

KORG

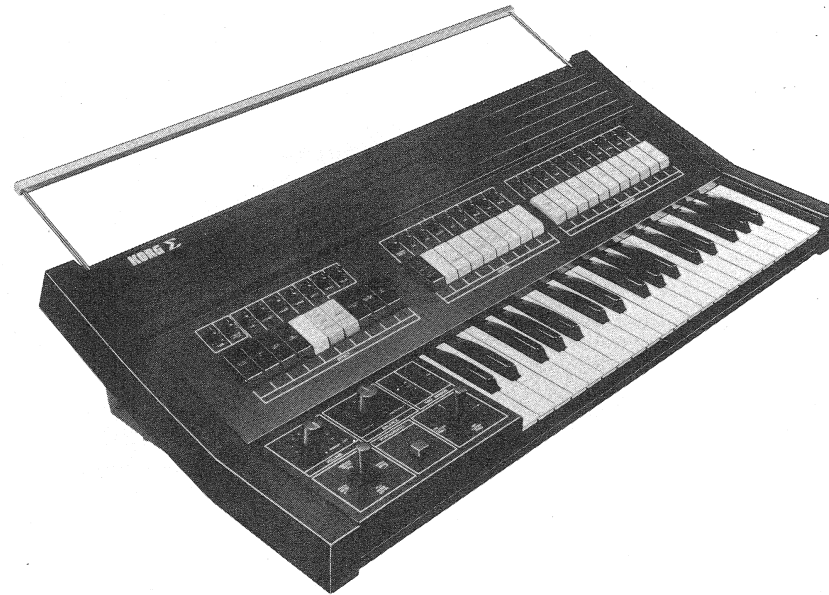

















PERFORMING SYNTHESIZER SERVICE MANUAL **KP-30**

CONTENTS

1. SPECIFICATIONS	2
2. STRUCTURAL DIAGRAM	3
3. CIRCUIT DIAGRAM	
KLM-166C	4
KLM-168C	5
KLM-167C	6
4. PC BOARD	
KLM-166C	7
KLM-168C	8
KLM-167C	9
5. BLOCK DIAGRAM	10
6. CHECK AND ADJUSTMENT	11
7. PARTS LIST (Mechanical parts not listed).....	13

KEIO ELECTRONIC LABORATORY CORPORATION
TOKYO/JAPAN

1. SPECIFICATIONS

1. KEYBOARD	● C – C 37 keys	
2. TABLET	SYNTHE	CONTROL
	● Ring Mod.	Synthe x INSTRUMENT
	● 	Synthe Pitch (±700 cents)
	● 	Attack/Release
	● 	32'
	● 	Attach/Release
	● 	16'
	● 	Clock Speed
	● 	16'
	● 	Attack/Release
	● 	8'
	● 	Attack/Release
	● 	8'
	● 	Decay
	● 	8'
	● 	Attack/Release
	● 	4'
	● 	Decay
	INSTRUMENT	CONTROL
	● Electric Bass	32'
	● Tuba	Cutoff Freq.
	● Tuba	32'
	● Clavi	Cutoff Freq.
	● Fuzz Guitar	16'
	● Fuzz Guitar	Pluse Width
	● Horn	16'
	● Horn	Tone
	● Trumpet	16'
	● Trumpet	Cutoff Freq.
	● Clarinet	8'
	● Clarinet	Cutoff Freq.
	● Double Reed	8'
	● Double Reed	Tone
	● String	8'
	● String	Tone
	● Flute	8'
	● Flute	Attack
	● Hammered Percussion	4'
	● Hammered Percussion	Tone
	● Hammered Percussion	4'
	● Hammered Percussion	Decay
	EFFECT	CONTROL
	● Octave Down	
	● Octave Up	
	● Portamento	Time
	● Keyboard Sensor	Intensity
	● Joy Stick SYNTHE	Range
	● Joy Stick INSTRUMENT	Range
	● Delay Vibrato INSTRUMENT	Delay, Depth, Speed
	● Quarter Tone	
	● Multiple Trigger	
	● Key Hold	
3. CONTROL	● Joy Stick	Pitch Bend, Vibrato Depth, Pink Noise Depth
	● Joy Stick	LPF. Cutoff Freq. (SYNTHE) HPF. Cutoff Freq. (SYNTHE)
	● Keyboard Sensor Control Switch x 2 Pitch Bend Up/Vibrato Depth/Pitch Bend Down, INSTRUMENT/INSTRUMENT + SYNTHE/SYNTHE
	● SYNTHE/INSTRUMENT Balance	
	● Total Tune ± 250 cents	
	● Synthe Pitch ± 700 cents	
	● Portamento Memortary Switch	
	● Power Switch and Volume	
4. OUT PUT	● Signal Out	Max/Synthe Out 5Vp-p Max. Mix/Instrument Out 5Vp-p Max.
	● KBD CV Out	Hz/V (0V ~ 8V)
	● KBD TRIG Out	GND
	● Headphones Out	
5. CONTROL IN	● VCO CV In	Hz/V (0V ~ 8V)
	● EG TRIG In	GND
	● VCO FM In	OCT/V (-3V ~ +3V)
	● Synthe VCF FcM In	2 OCT/V (-5V ~ +5V)
6. POWER CONSUMPTION	17 Watts, Local Voltage, 50/60 Hz	
7. DIMENSIONS	774 x 400 x 173 (mm)	
8. WEIGHT	11 kg	

2. STRUCTURAL DIAGRAM

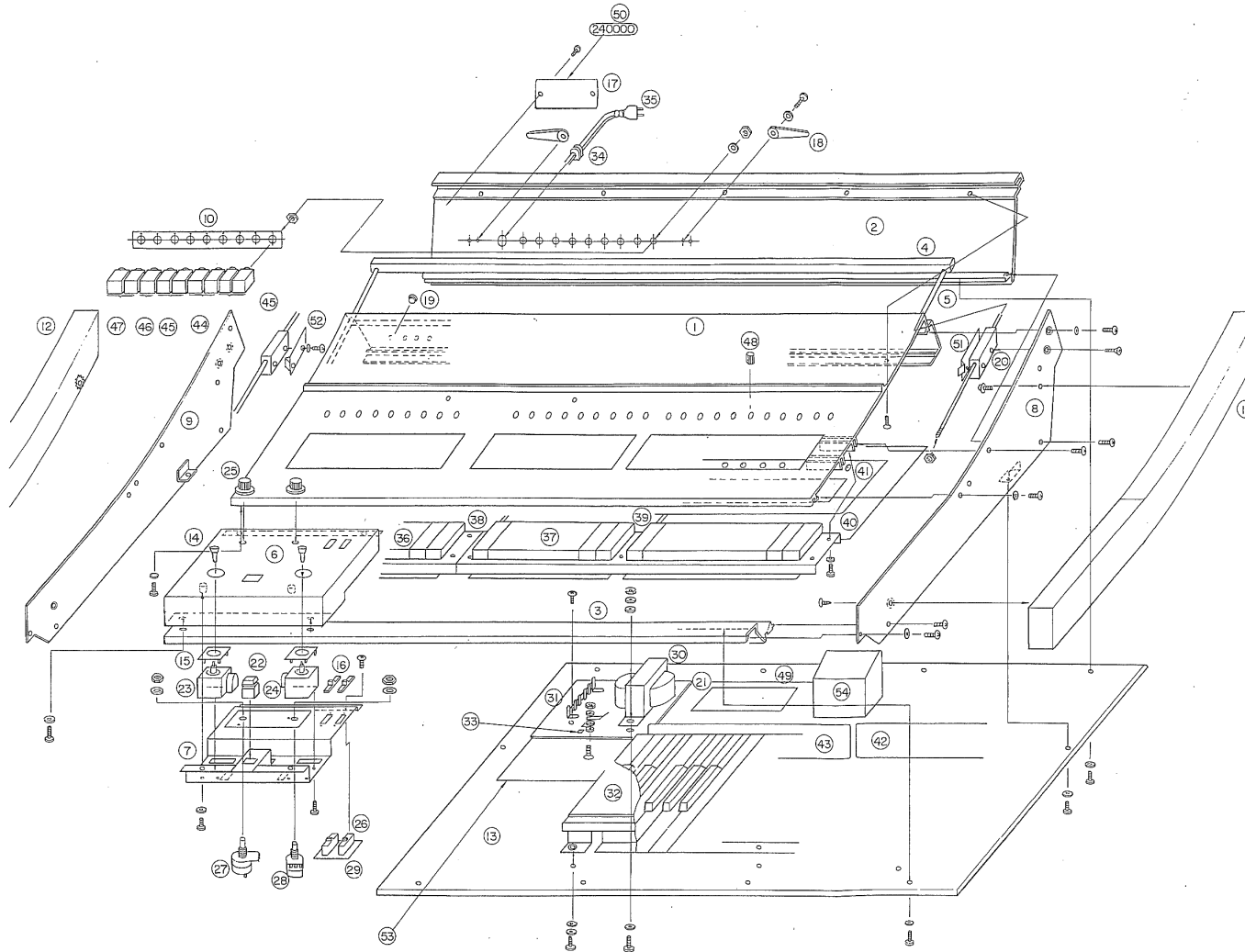

Item	Part Name	Remarks
1	Front panel	
2	Rear panel	
3	Front chassis	
4	Music stand cross bar (square)	
5	Music stand side bar (round)	
6	Control panel	
7	Control subchassis	
8	Right side chassis	
9	Left side chassis	
10	Phone jack mounting board	
11	Right side	
12	Left side	
13	Bottom	
14	Joy stick lever knob	
15	Joy stick Vr cover	
16	Slide contact	
17	Model number plate	
18	Cord stopper	EM-5038
19	Trimmer stopper	
20	Music stand side bar guide block	
21	Aluminum earth (ground) plate	
22	Push switch	SCK-4150 AKC-2N
23	Joy stick unit	JX62T-10KB
24	Joy stick unit	JX60A-20KB
25	Rotary knob	Large
26	Slide switch	SSB-123
27	Rotary control	EWF-PQ5P20A15
△28	Rotary control	EWK-DOAK20B14
29	Printed circuit board for slide switch	KLM-181A
30	Power transformer	KA-331,KB-331
31	Lug board	No.9 2L4P
32	Keyboard	ESK-431T 37 KEY
33	Earth (ground) seal	X-1942
34	Strain release bushing	4K-4, 5P-4
35	Power cord	
36	Tablet switch	EST-195
37	Tablet switch	EST-1913
38	Printed circuit board	KLM-166B
39	Printed circuit board	KLM-167B
40	Printed circuit board	KLM-168B
41	VR Tablet switch mask	
42	Printed circuit board	KLM-137A
43	Printed circuit board	KLM-137B
44	Phone jack	S-G7501
45	Phone jack	S-G7617
46	Phone jack	S-G7701
47	Phone jack	S-G7850
48	Rotary knob	Small
49	Fuse caution seal	
50	Serial number plate	
△51	Right spring plate	
△52	Left spring plate	
△53	Aluminum film	
△54	Support	

3. CIRCUIT DIAGRAM KLM-166C

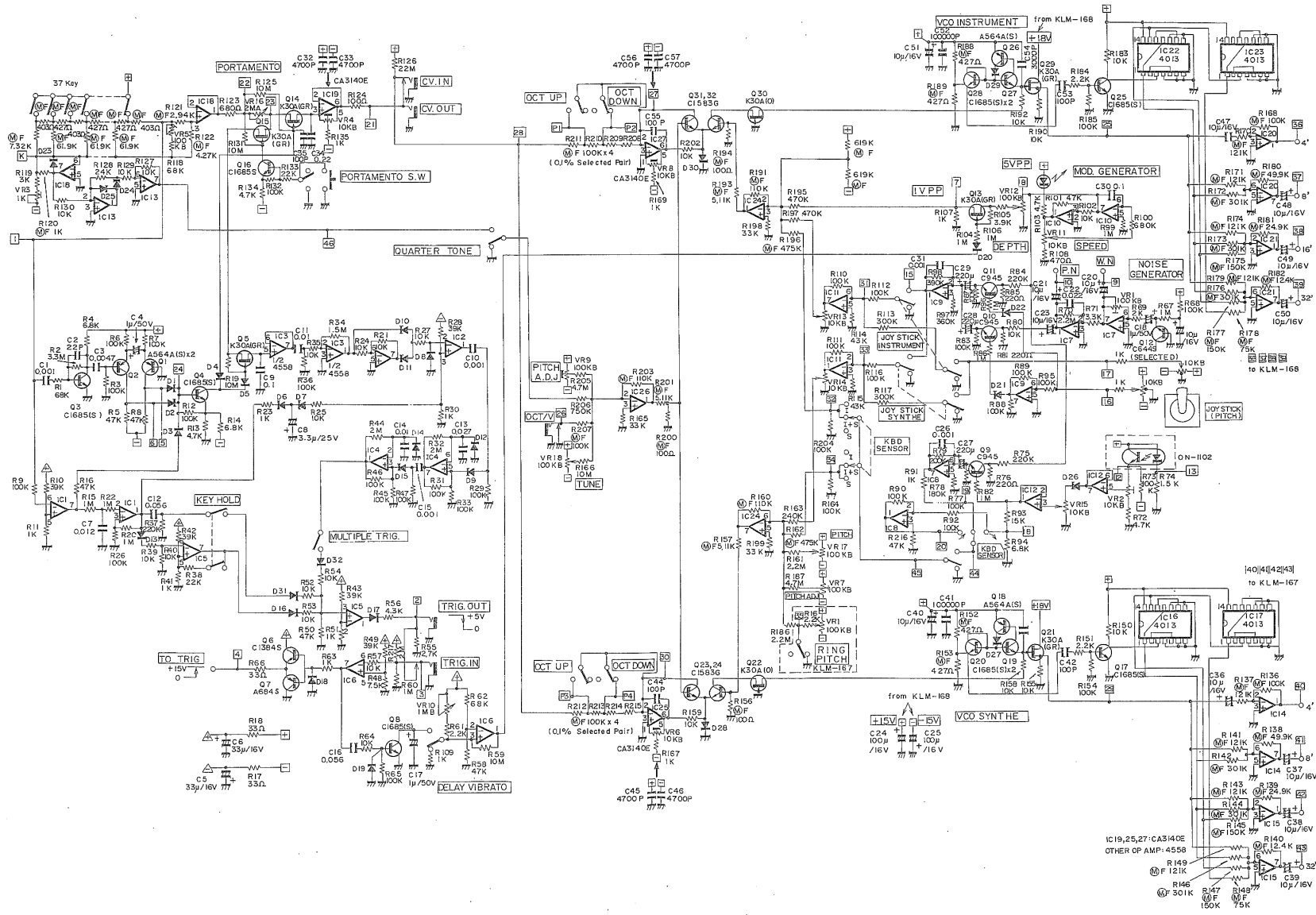

KLM-168C

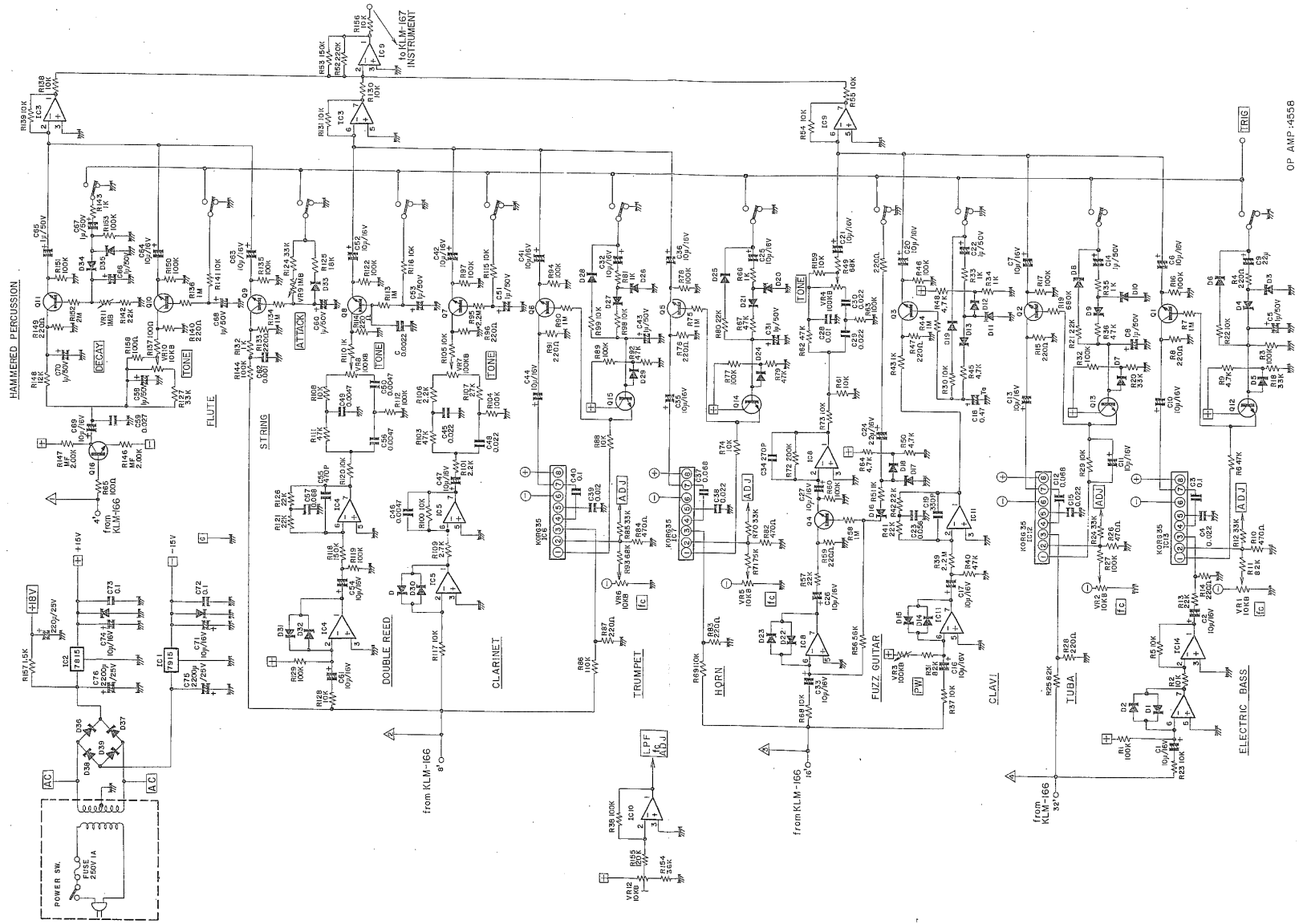

OP AMP-4556

KLM-167C

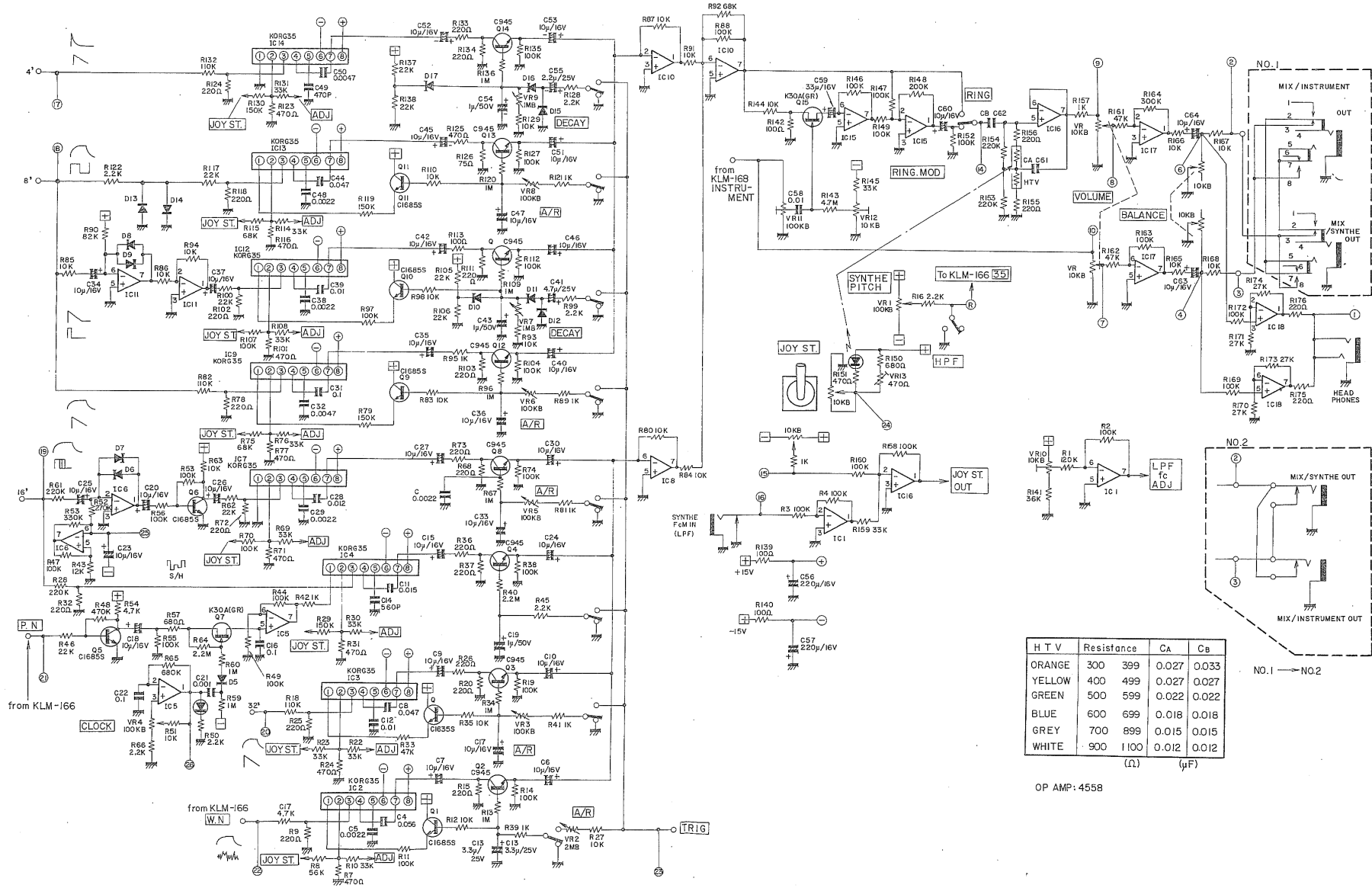

HTV	Resistance	Ca	Cb
ORANGE	300	399	0.027
YELLOW	400	499	0.027
GREEN	500	599	0.022
BLUE	600	699	0.018
GREY	700	899	0.015
WHITE	900	1100	0.012
	(Ω)		(μF)

OP AMP: 4558

4. PC BOARD KLM-166C

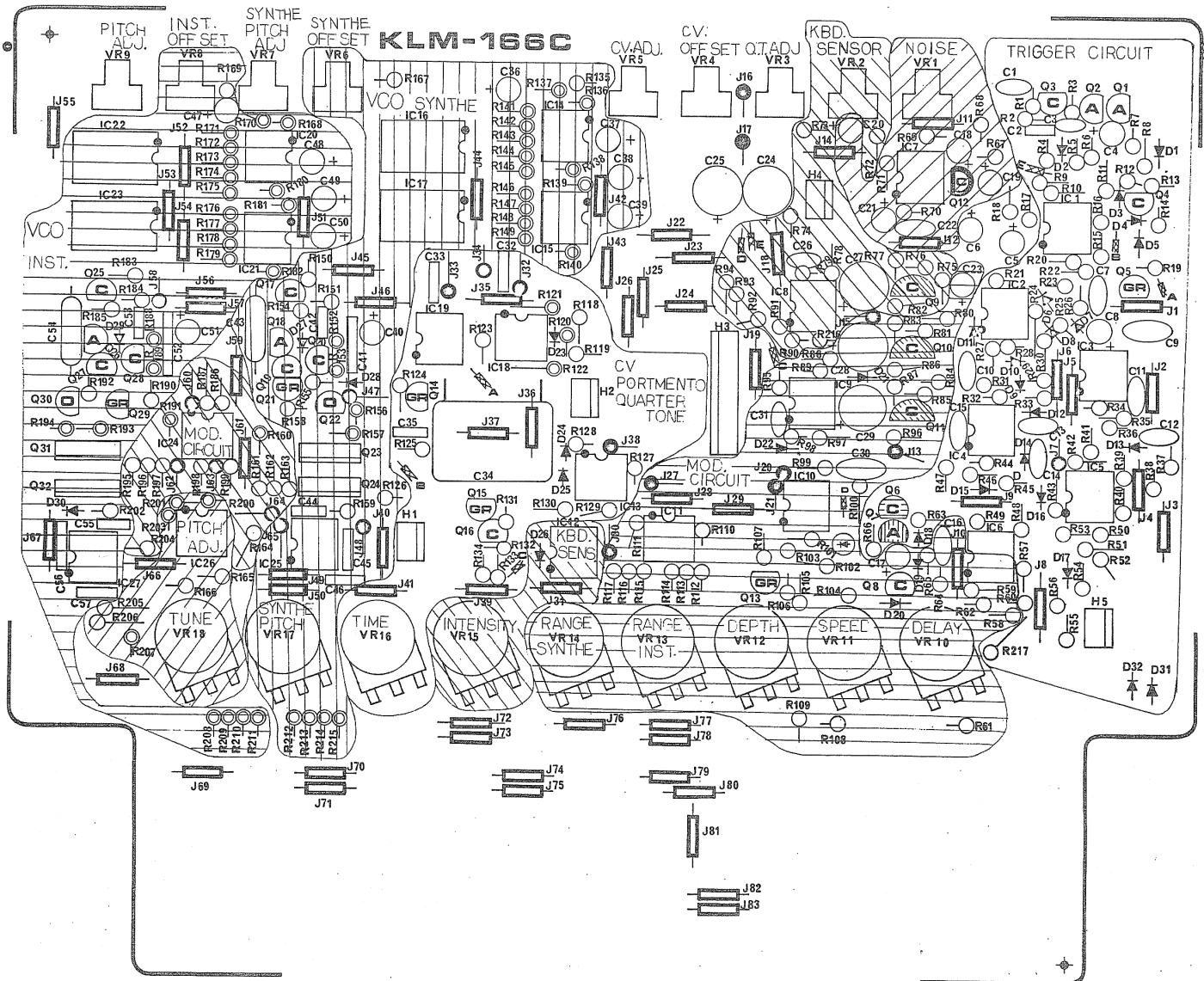

KLM-168C

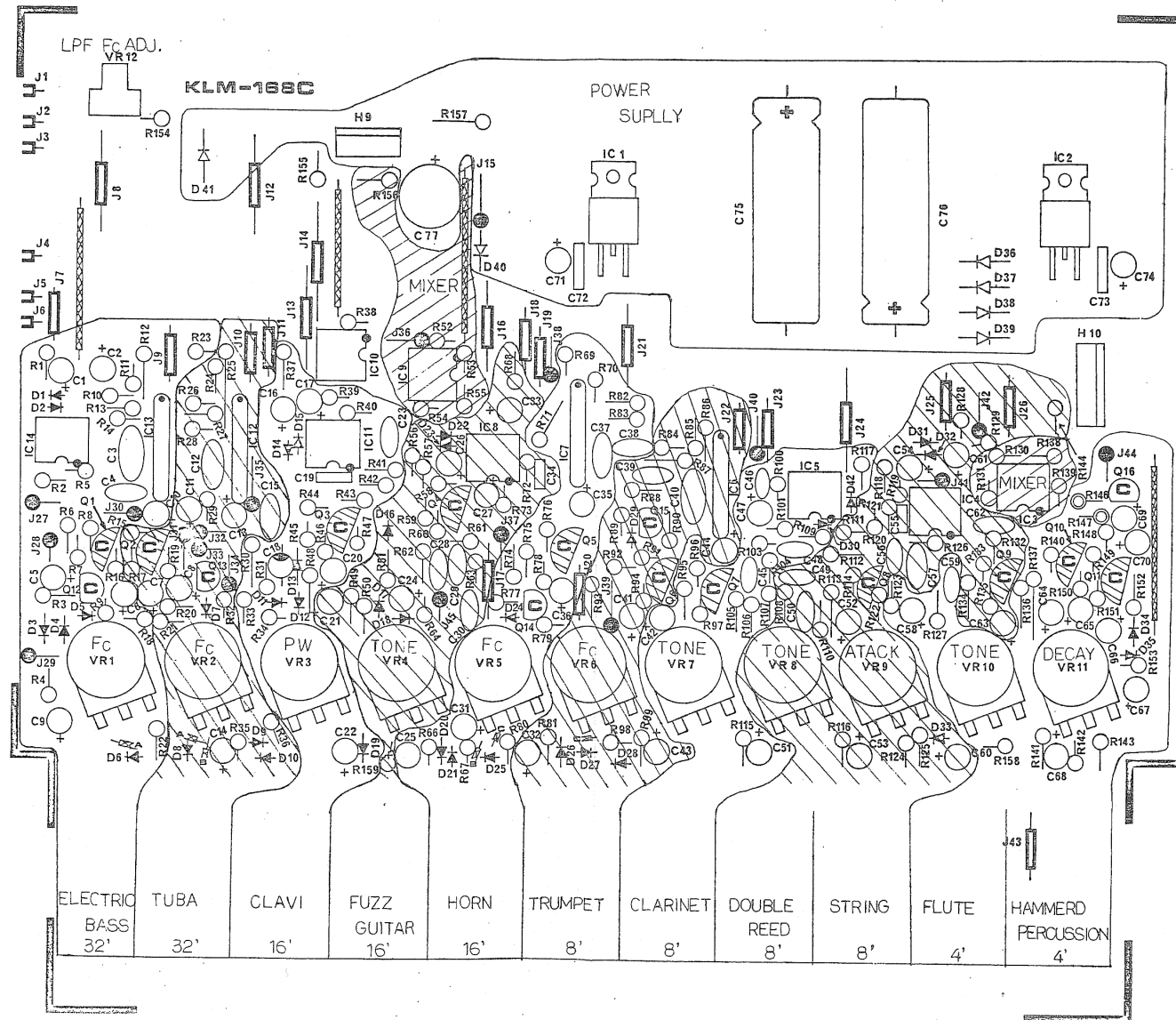

KLM-167C

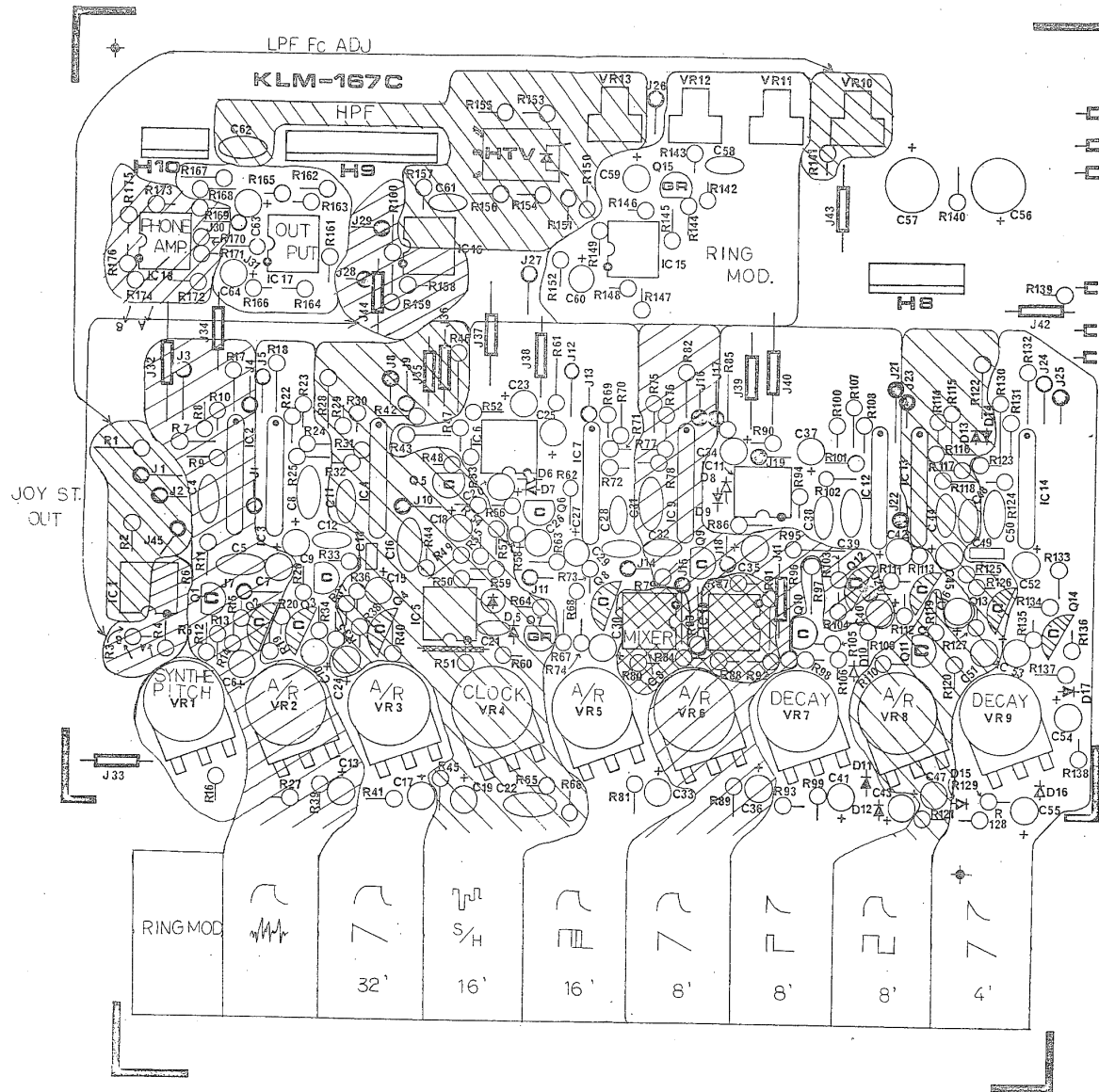

5. BLOCK DIAGRAM

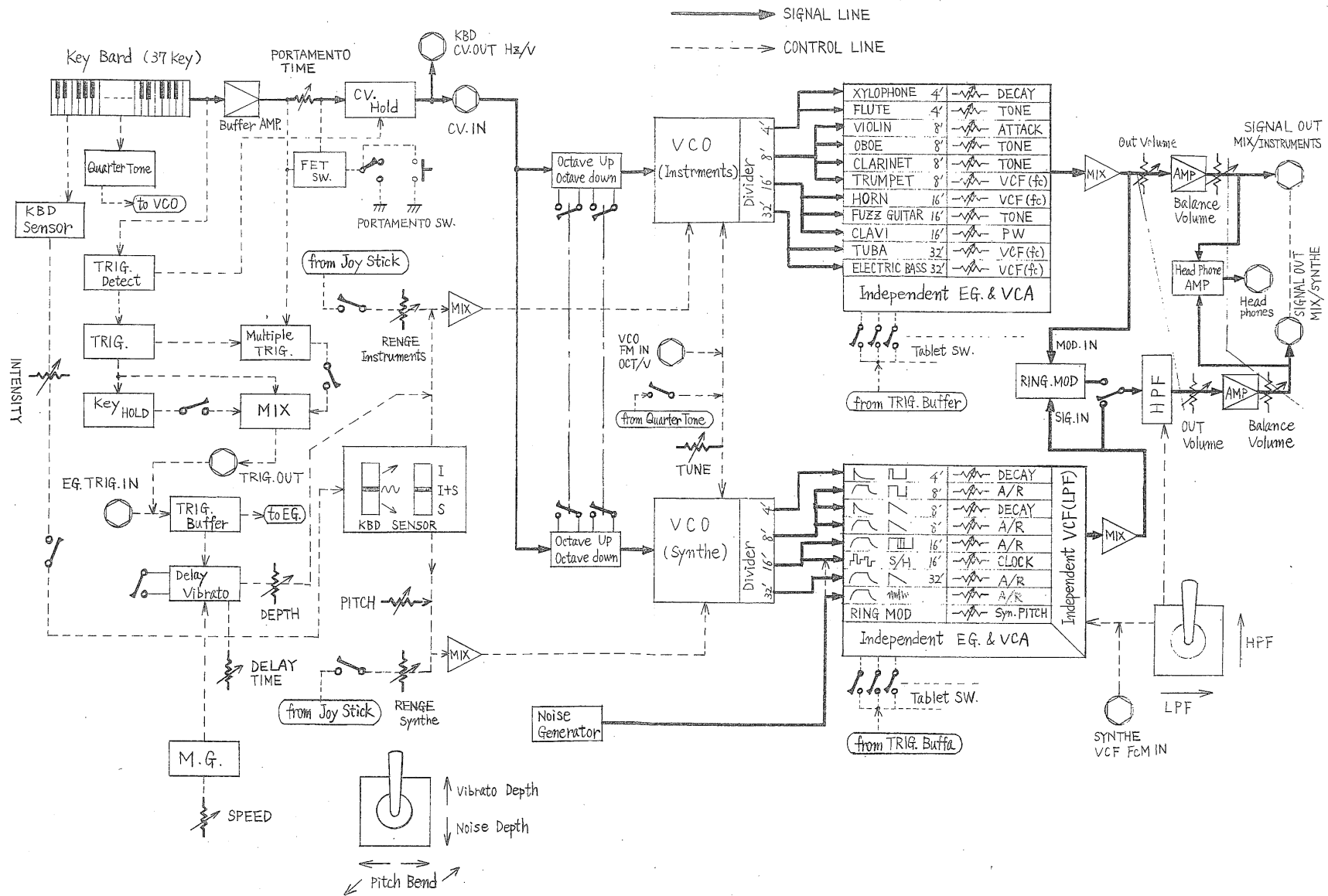

6. CHECK AND ADJUSTMENT

*Functions not included in steps 1 ~ 10 below, are to be checked aurally.

6-1 KBD CV adjustment

Use a 4-1/2 place digital voltmeter to measure the KBD CV OUT signal.

- Measure output voltage first when you play key C-4, then when you play key C-3. The output voltage for C-3 should be exactly half that for C-4. Adjust the KBD CV Hi Vr as necessary so that C-3 produces half the voltage of C-4.
- Measure C-2 and then C-1 in the same way. Adjust the KBD CV Lo Vr as necessary so that C-1 produces exactly half the voltage of C-2.
- Repeat steps a and b as many times as necessary until the output voltage of each of C-1, C-2, C-3, and C-4 is exactly half that of the next.

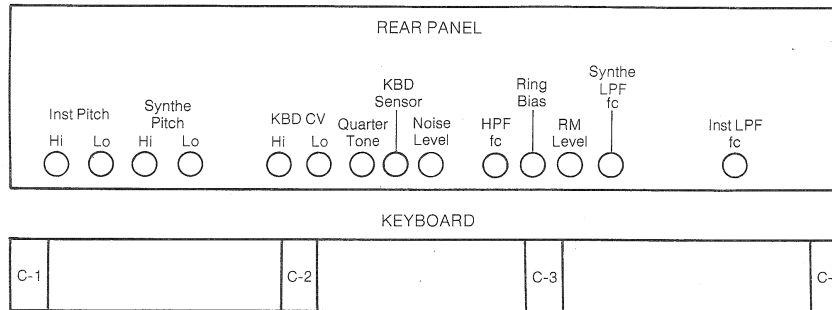

6-2 Instrument pitch adjustment

Settings	
Mix out	WT-10A
Mode	Clarinet
Balance	Instrument
Tune	Center

- Play C-4 and adjust Inst Pitch Hi (on rear panel) so WT-10A meter indicates 0 cent.
- Play C-1 and adjust Inst Pitch Lo to 0 cent.
- Repeat steps a and b several times as necessary so that C-1 through C-4 are within ± 3 cents.
- Check that pitch remains within ± 5 cents at Octave Up and Octave Down positions.

6-3 Synthe pitch adjustment

Settings	
Mix out	WT-10A
Mode	8' (A/R Min.)
Balance	Synthe
Synthe Pitch	Center

Follow same procedure as for Inst Pitch, but use Synthe Pitch Hi and Lo Vr's for adjustment.

6-4 Instrument LPF fc ADJ.

Settings	
Mix out	Oscilloscope
Mode	Trumpet (fc max.)
Volume	Max.
Balance	Instrument

Play C-2 and after the waveform has stopped moving, adjust the Inst LPF fc so that the second peak in the waveform is at 400msec. Refer to fig-1.

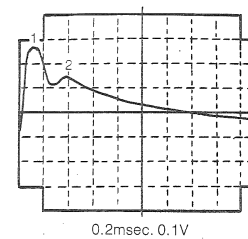





Fig. 1

6-5 Synthe HPF fc ADJ.

Settings	
Mix out	Oscilloscope
Mode	32'  (A/R min.)
Volume	Max.
Balance	Synthe
Filter joy stick	

Play C-1 and adjust HPF fc to the setting that produces the lowest sound.

6-6 Synthe LPF fc ADJ.

Settings	
Mix out	Oscilloscope
Mode	8'  (A/R min.)
Volume	Max.
Balance	Synthe
Filter joy stick	

Play C-1 and adjust so that the 6th peak in the waveform is at 1sec. Refer to fig-2.

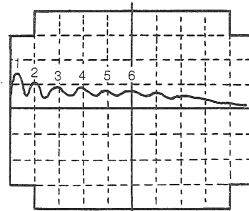



Fig. 2

6-7 Ring Mod Adjustment

Settings	
Mix out	Oscilloscope
Mode	8'  (A/R min.) and RING MOD.
Balance	Synthe
Filter joy stick	

- Adjust Ring bias to the setting that gives minimum output when you play a key (any key will do).
- At that setting, turn on Horn 16' and adjust Ring Level so that the volume is the same as when Ring Mod is turned off.

6-8 Quarter Tone and Key Hold

Settings	
Mix out	Amp
Mode	Clarinet
Quarter Tone	On
Key Hold	On



- Play B-3 (for example) and adjust the Quarter Tone Vr so that when you release the key the pitch does not change.
- Turn Key Hold off, play G-3 and B-3 at the same time and compare the pitch to that of A-3. Repeat adjustment a (above) as many times as necessary so that the pitch matches A-3.

6-9 KBD Sensor

Settings	
Mix out	Amp, WT-10A
Mode	8' 
Mode	Clarinet
KBD Sensor	On (Intensity - max.)

With KBD SENSOR switches at  and 1+s, adjust the KBD Sensor Vr so that both sounds rise in pitch by 6 degrees. (Up to 5 cents difference between the pitch of the two sounds is OK.)

6-10 Noise Level

Settings	
Mix out	Oscilloscope
Mode	Noise (A/R min.)
Mode	16'  (A/R min.)
Balance	Synthe
Filter joy stick	

Play C-2 and adjust so that the noise level is the same as the PW waveform signal level. (This is easy to tell by listening to the sound.)

7. PARTS LIST

(Refer to structural diagram for parts list)

● CARBON RESISTORS

not listed

● METAL FILM RESISTORS

1/4W 1% 100Ω x 3
403Ω x 19
427Ω x 22
1.00KΩ x 1
2.00KΩ x 2
2.94KΩ x 1
4.27KΩ x 1
5.11KΩ x 3
7.32KΩ x 1
12.4KΩ x 2
24.9KΩ x 2
61.9KΩ x 18
75.0KΩ x 2
100KΩ x 11
110KΩ x 3
121KΩ x 8
150KΩ x 4
301KΩ x 6
619KΩ x 2
49.9KΩ x 2

● SOLID RESISTORS

1/4W 10% 10MΩ x 5
22MΩ x 1

● MYLAR CAPACITORS

50V - 0.001μF x 7
0.0022μF x 4
0.0047μF x 7
0.01μF x 6
0.012μF x 3
0.015μF x 1
0.022μF x 8
0.027μF x 2
0.047μF x 2
0.056μF x 4
0.068μF x 3
0.1μF x 7

● CERAMIC CAPACITORS

50V - 22pF x 1
100pF x 5
270pF x 1
330pF x 1
470pF x 3
0.0047μF x 6
25V - 0.1μF x 4

● ELECTROLYTIC CAPACITORS

50V - 1μF x 21
25V - 22μF x 1
3.3μF x 2
4.7μF x 1
16V - 10μF x 74
22μF x 2
33μF x 3
100μF x 2
220μF x 5
25V - 220μF x 1
2200μF x 2

● TANTALUM CAPACITORS

16V - 0.47μF x 1

● POLYPROPYLENE CAPACITORS

200V - 0.22μF x 1

● POLYSTYRENE CAPACITORS

50V - 3000pF x 2

● TRANSISTORS

2SA-564A(S) x 4
684S x 1
2SC-945(L)K x 22
(special selected)
2SC-1384S x 1
1583G x 4
1685S x 22
644R x 1

● FET

2SK-30A(GR) x 8
(O) x 2

● DIODES

1S-1555 x 81
1885 x 6

● LED

GL-3AR-2 x 2

● PHOTOCOUPLER

HTVP-873-G35-911 x 1
(special selected)

● IC

4558DV x 38
CA-3140E x 3
MC-14013 x 4
μPC-14315 x 1
μA7915 x 1
EHM KOR35 x 12
(special selected)

● SEMI-FIXED RESISTORS

SR29D 470Ω x 1
1KΩ x 1
10KΩ x 7
100KΩ x 5

● ROTARY VARIABLE RESISTORS

VM60Z 10KB x 9
100KB x 13
1MB x 5
2MB x 1
2MA x 1

● CONNECTORS

MLR-03 TRC-1 x 1
MLP-03TRC-60 x 1
3P x 4
4P x 2
6P x 1
7P x 1
10P x 1
L11P x 1