

microKONTROL

CONTENTS

Page:

1. KLM-2436 Power and Rear I/O
2. KLM-2436 CPU, I/O Port
3. KLM-2437 Joystick Unit
4. KLM-2437 LED Matrix
5. KLM-2437 MENU SW, 8 Encoder, 8 Slider
6. KLM-2437 LCD
7. KLM-2437 PADS
8. KLM-2437 LDC Back Light
9. KLM-2437 Block Diagram
10. Test Mode
- 11-13. Parts List

1st Edition

Issued date: January 23, 2004

Issued by: KORG INC.

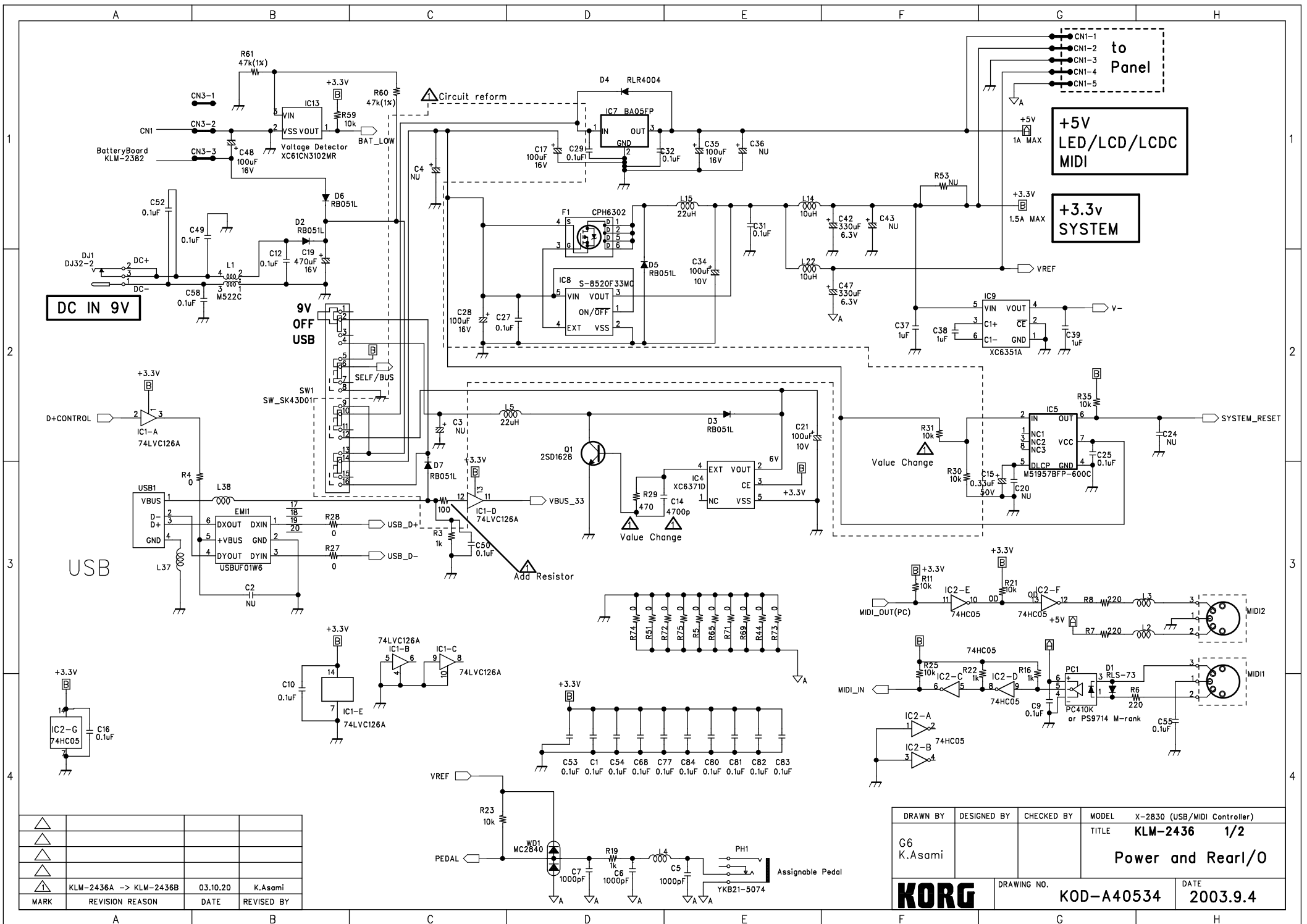

△			
△			
△			
△	KLM-2436A → KLM-2436B	03.10.20	K.Asami
MARK	REVISION REASON	DATE	REVISED BY

DRAWN BY	DESIGNED BY	CHECKED BY	MODEL	X-2830 (USB/MIDI Controller)
G6	K.Asami		TITLE	KLM-2436 1/2
			Power and Rear I/O	
DRAWING NO.		DATE		
KORG		KOD-A40534		2003.9.4

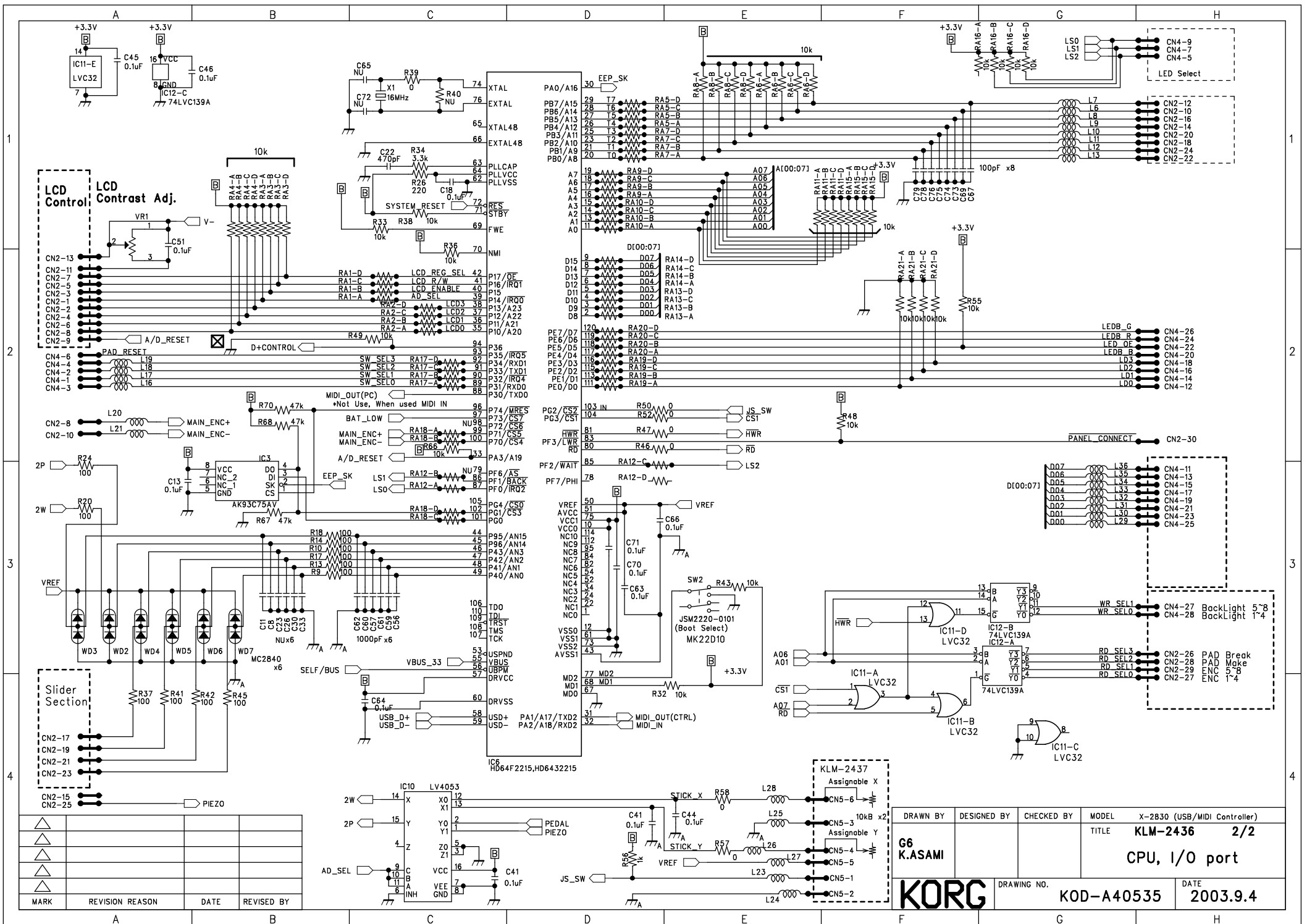

MARK	REVISION	REASON	DATE	REVISED BY

DRAWN BY	DESIGNED BY	CHECKED BY	MODEL	X-2B30 (USB/MIDI Controller)
G6	K.ASAMI		TITLE	KLM-2436 2/2
				CPU, I/O port
KORG		DRAWING NO.	KOD-A40535	DATE
				2003.9.4

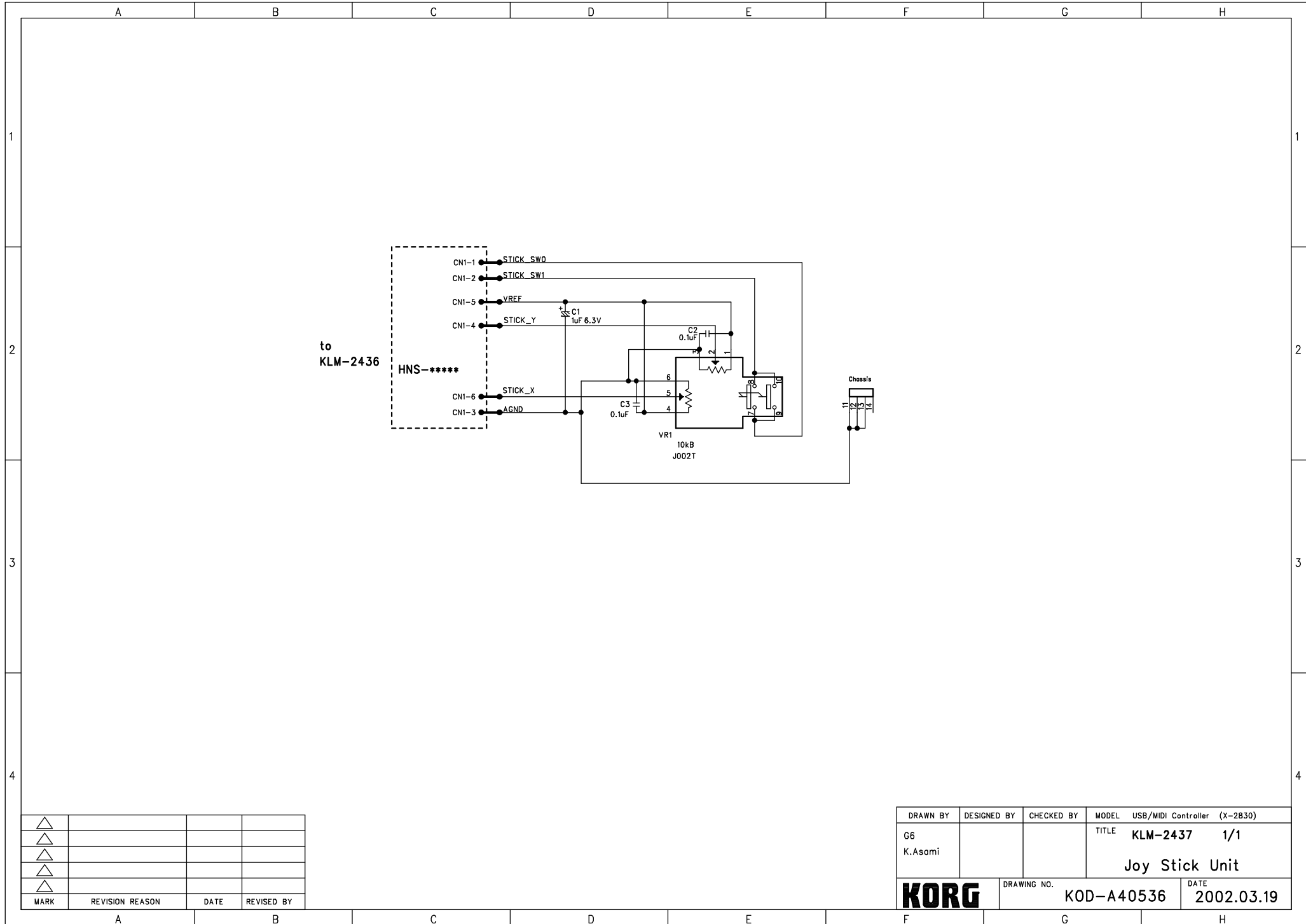

△			
△			
△			
△			
△			
MARK	REVISION REASON	DATE	REVISED BY

DRAWN BY	DESIGNED BY	CHECKED BY	MODEL	USB/MIDI Controller (X-2830)
G6			TITLE	KLM-2437 1/1
K.Asami			Joy Stick Unit	
KORG		DRAWING NO.	KOD-A40536	DATE
				2002.03.19

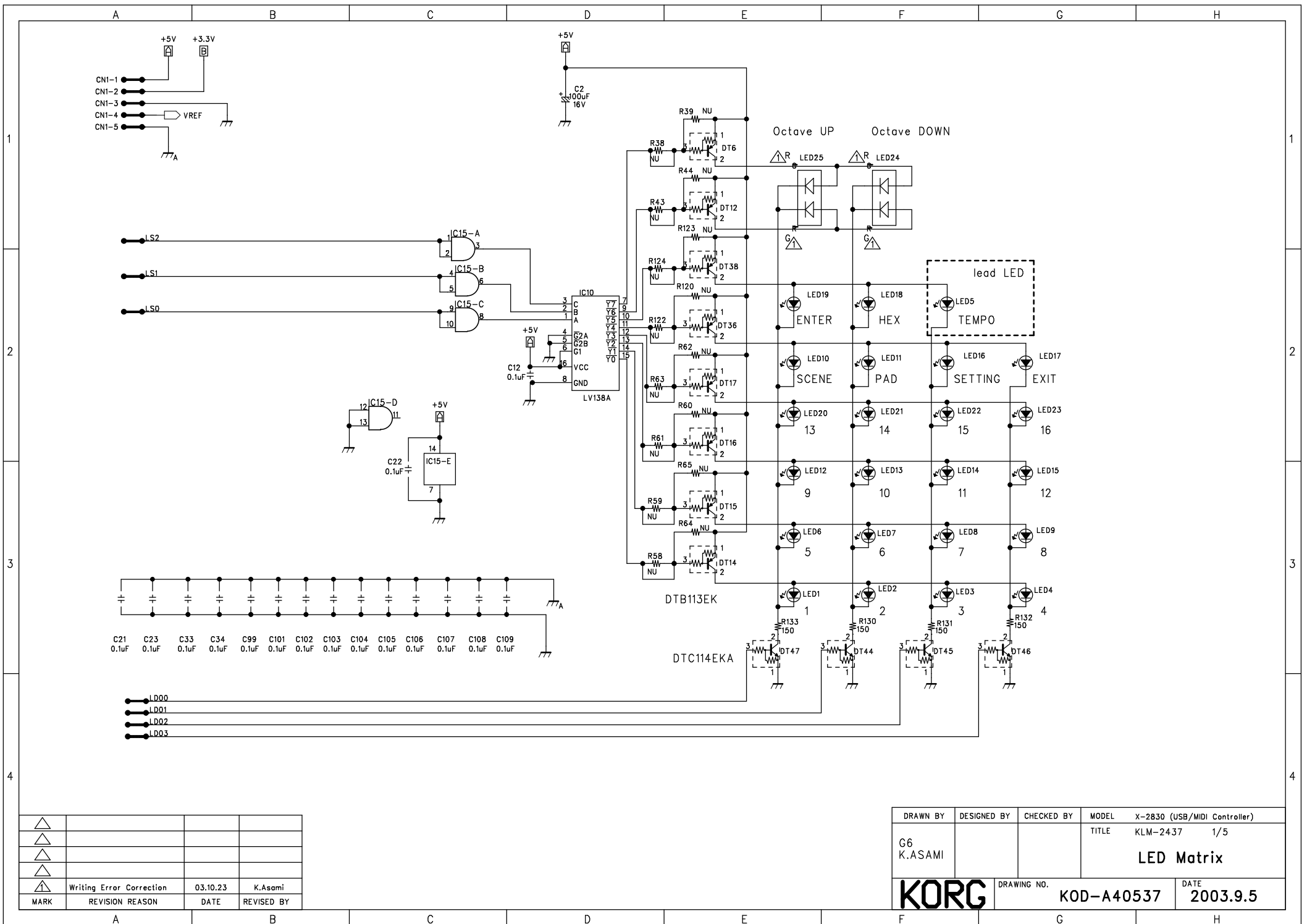

△			
△			
△			
△	Writing Error Correction	03.10.23	K.Asami
MARK	REVISION REASON	DATE	REVISED BY

DRAWN BY	DESIGNED BY	CHECKED BY	MODEL	X-2830 (USB/MIDI Controller)
G6	K.ASAMI		TITLE	KLM-2437 1/5
			LED Matrix	
KORG		DRAWING NO.	KOD-A40537	DATE
				2003.9.5

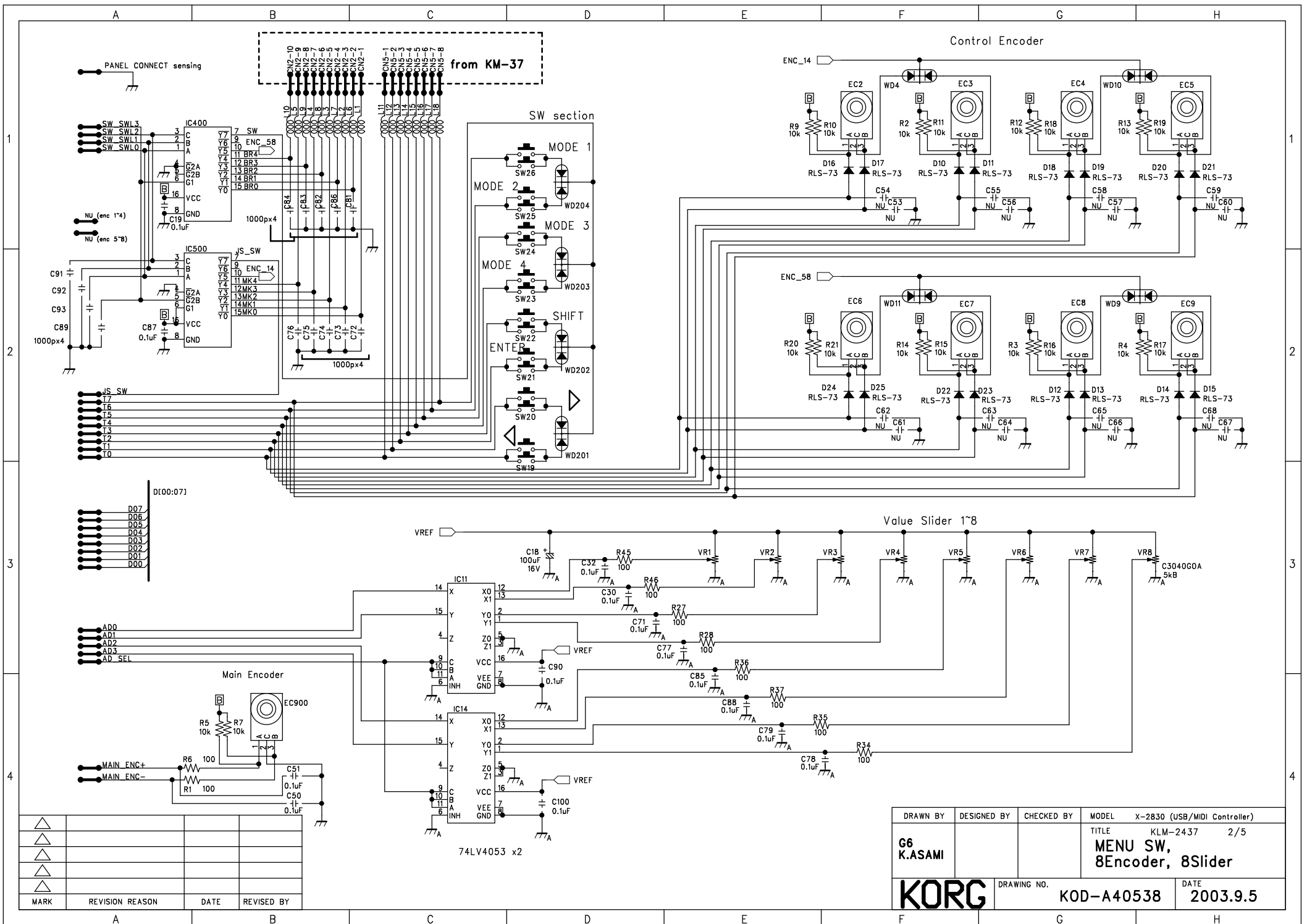

DRAWN BY	DESIGNED BY	CHECKED BY	MODEL	X-2830 (USB/MIDI Controller)
G6 K.ASAMI			TITLE	KLM-2437 2/5
			MENU SW, 8Encoder, 8Slider	
KORG		DRAWING NO.	KOD-A40538	DATE
				2003.9.5

MARK	REVISION REASON	DATE	REVISED BY
△			
△			
△			
△			

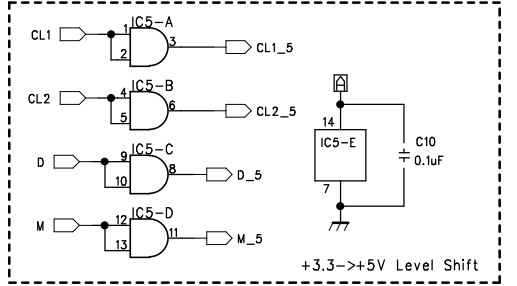
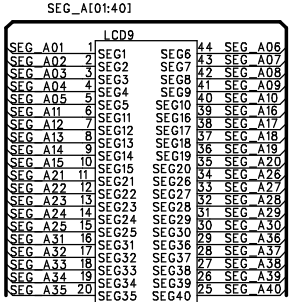
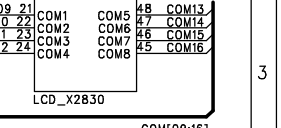
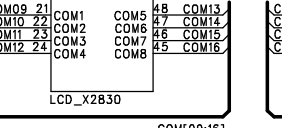
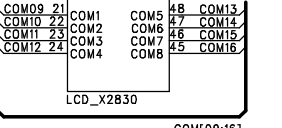
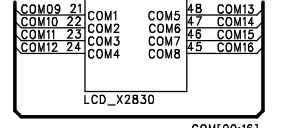
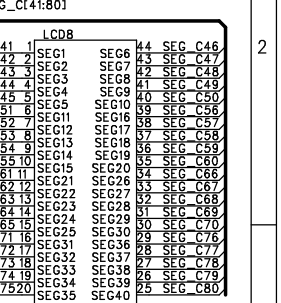
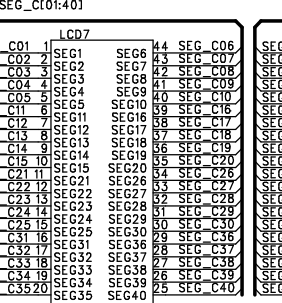
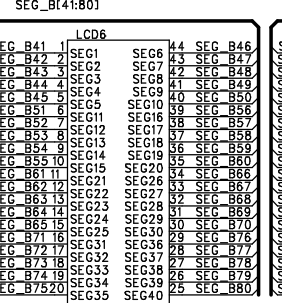
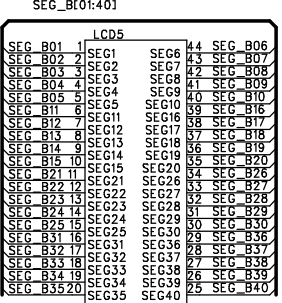
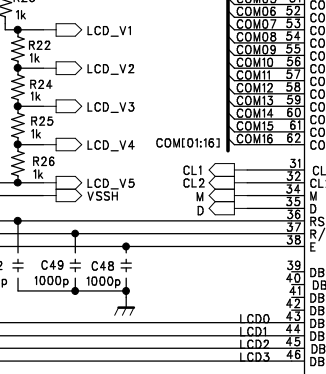
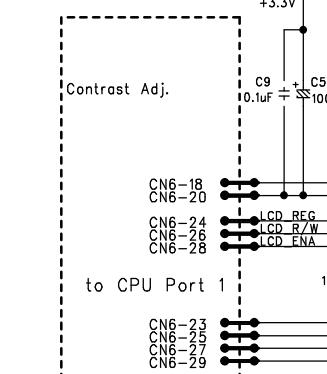
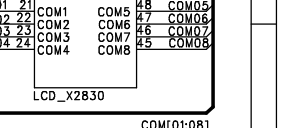
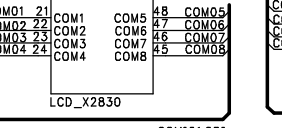
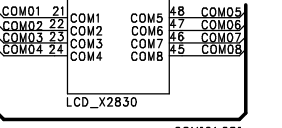
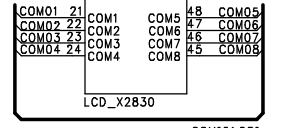
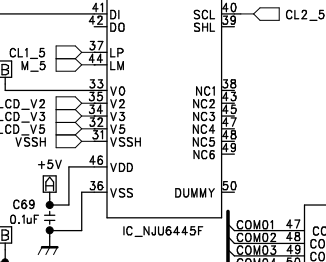
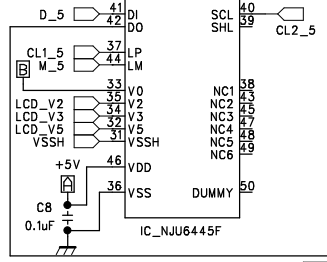
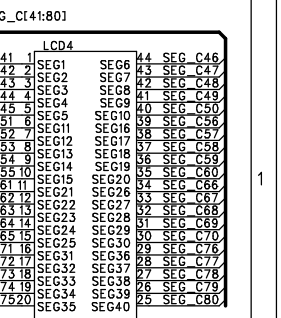
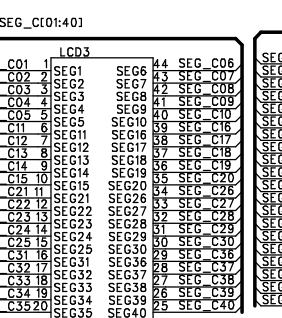
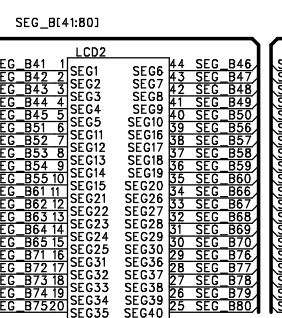
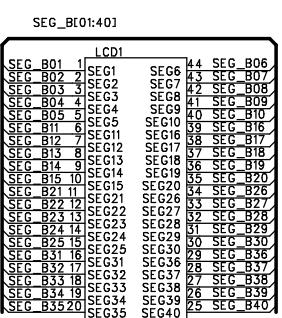
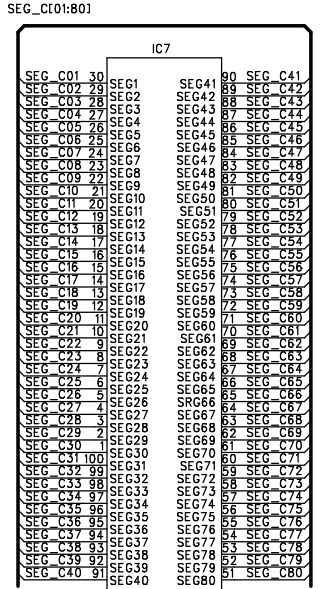
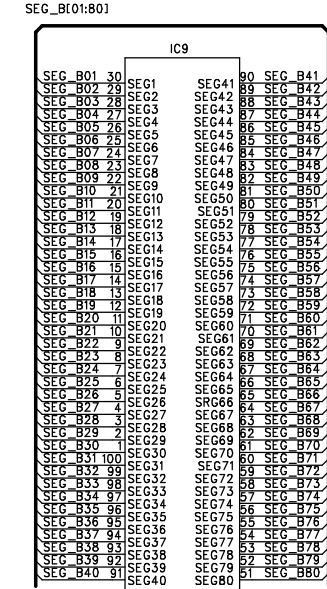
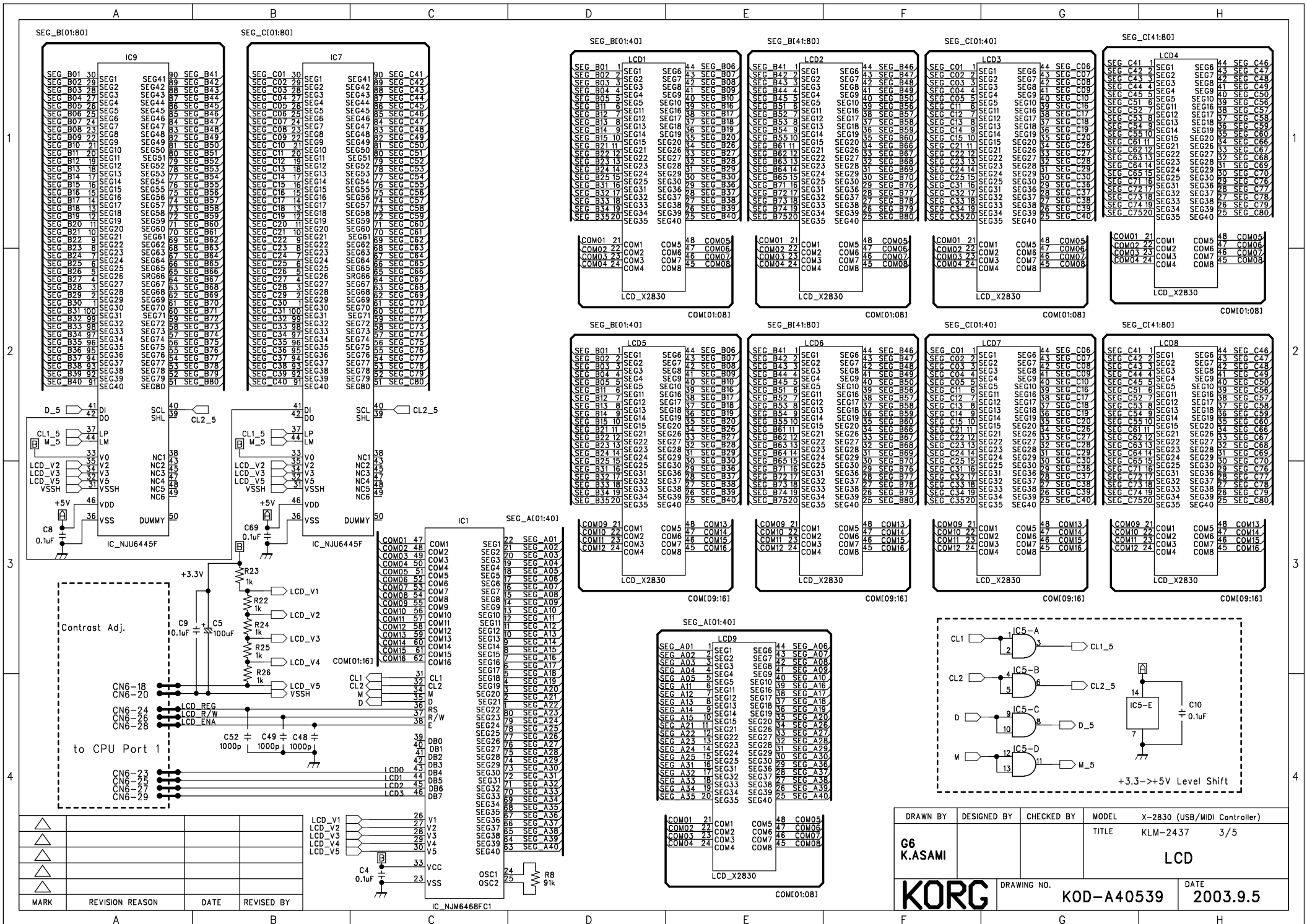

MARK	REVISION	REASON	DATE	REVISED BY

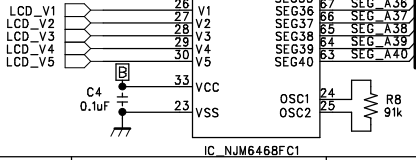

DRAWN BY	DESIGNED BY	CHECKED BY	MODEL	X-2830 (USB/MIDI Controller)
G6 K.ASAMI			TITLE	LCD
DRAWING NO.			KOD-A40539	DATE
				2003.9.5

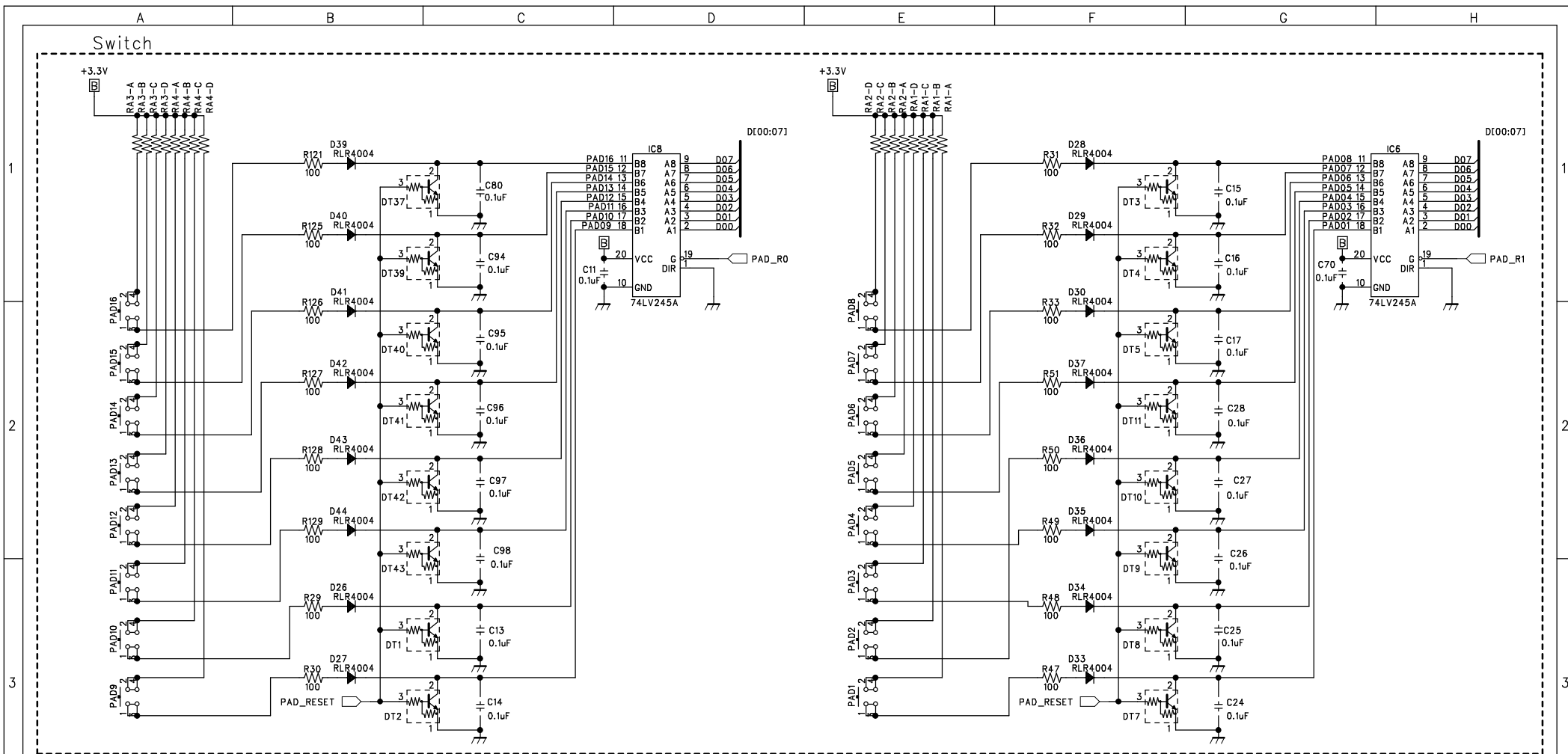

CN4-5 PAD_RESET

CN6-4 PAD_R0

CN6-2 PAD_R1

CN6-22 A/D_RESET

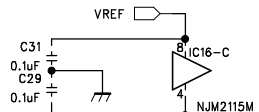
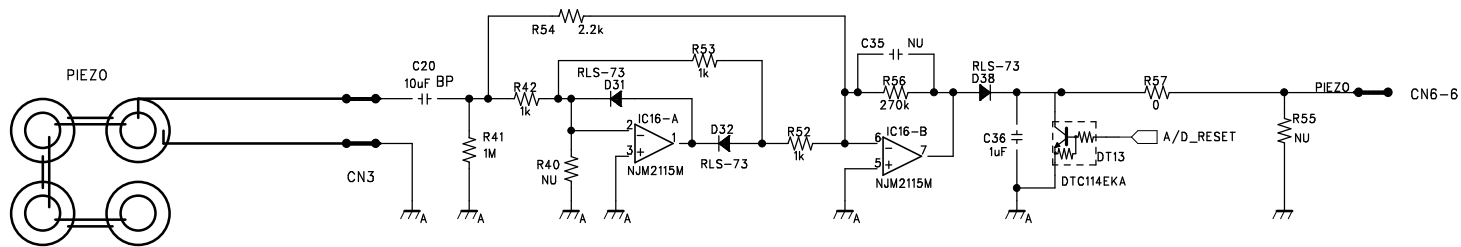

MARK	REVISION REASON	DATE	REVISED BY
△			
△			
△			
△			

DRAWN BY	DESIGNED BY	CHECKED BY	MODEL	X-2830 (USB/MIDI Controller)
			TITLE	KLM-2437 4/5
G6 K.ASAMI			PADs	
DRAWING NO.		KOD-A40540		DATE
				2003.9.5



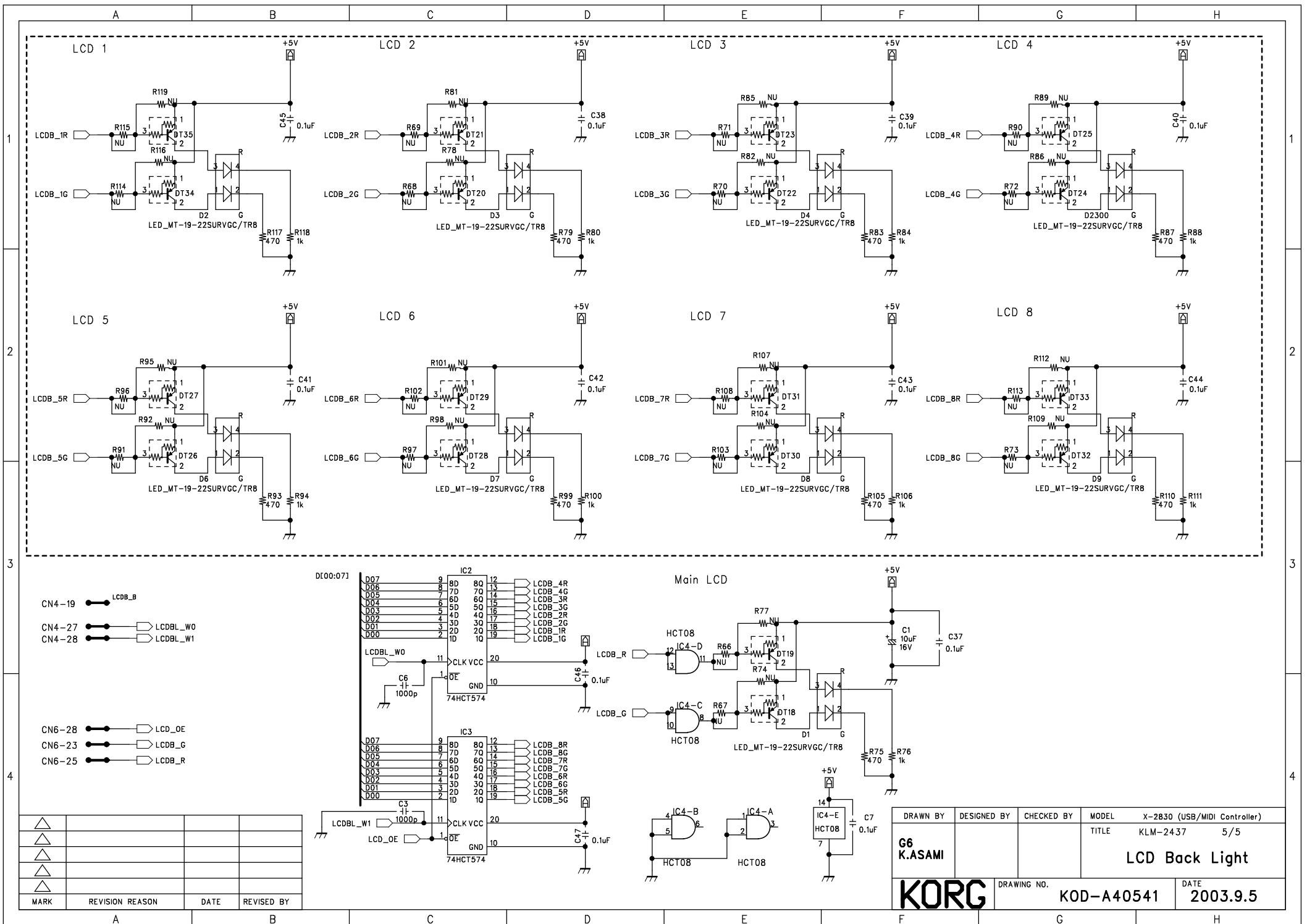

DRAWN BY	DESIGNED BY	CHECKED BY	MODEL	X-2830 (USB/MIDI Controller)
G6 K.ASAMI			TITLE	KLM-2437 5/5
KORG			DRAWING NO.	KOD-A40541
			DATE	2003.9.5

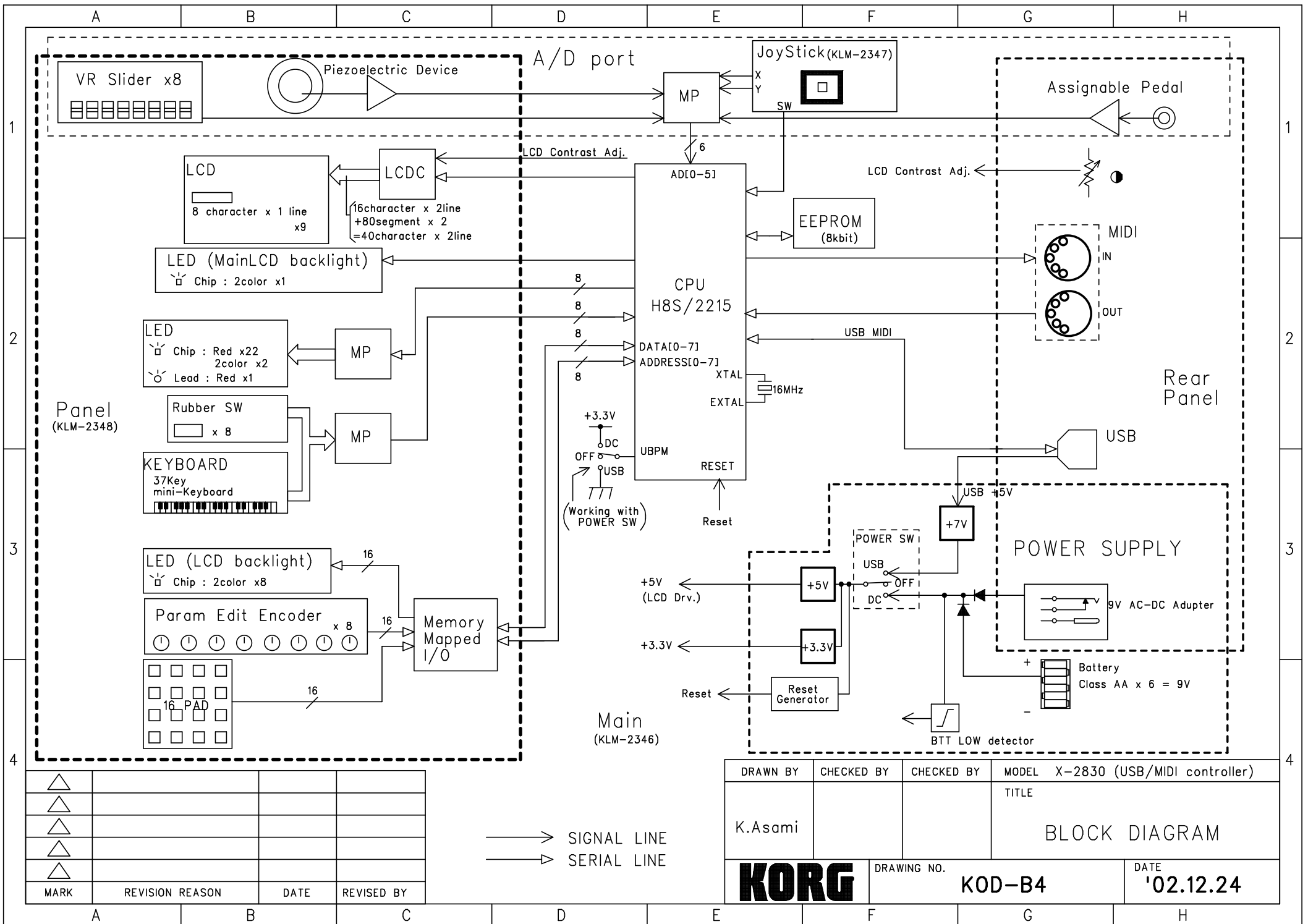

△			
△			
△			
△			
△			
MARK	REVISION REASON	DATE	REVISED BY

DRAWN BY	CHECKED BY	CHECKED BY	MODEL X-2830 (USB/MIDI controller)
K.Asami			TITLE
			BLOCK DIAGRAM
KORG		DRAWING NO. KOD-B4	DATE '02.12.24

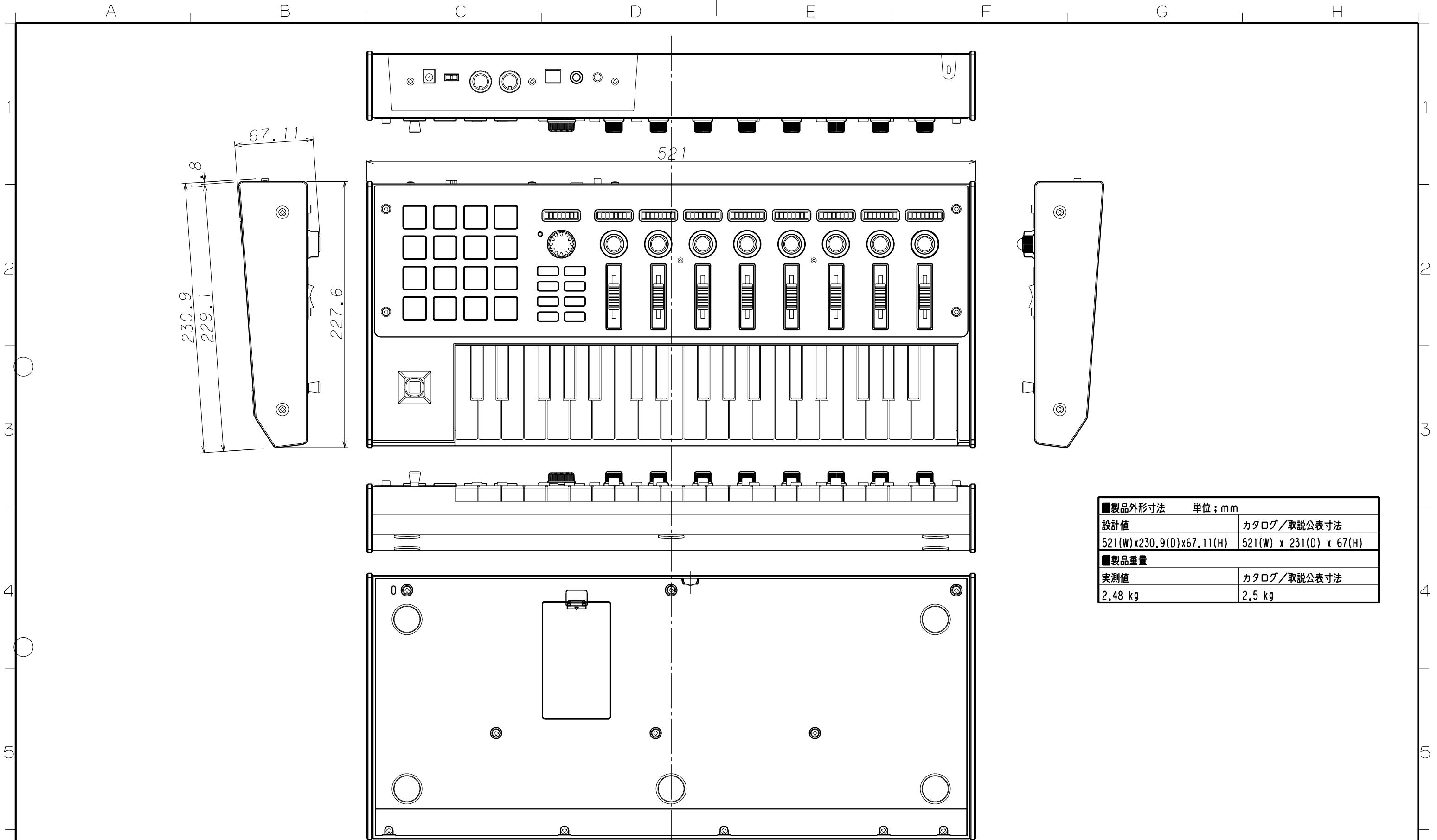

■製品外形寸法		単位 ; mm	
設計値	カタログ/取説公表寸法	521(W)x230.9(D)x67.11(H)	521(W) x 231(D) x 67(H)
■製品重量			
実測値	カタログ/取説公表寸法	2.48 kg	2.5 kg

REVISAL MARK	REVISAL REASON	REVISAL DATE	REVISED BY	APPROVED
△				
△				
△				
△				
△				

COMMERCIAL TOLERANCE ± mm

1	X-2830							
MODEL		SPECIFICATION			PARTS NAME		PARTS No.	
WEIGHT:		DRAWN	CHECKED	APPROVED	TITLE		試作図	
		服部	島川	安達	外形図		金型手配図	
		03/07/02	03/07/02	03/07/02			金型発注図	
		SCALE			DRAWING No.		量産図面	
		1/3			KOC-A30176		総合製作書用図面	

KORG

KORG INC.

SCALE

1/3

DRAWING No.

KOC-A30176

試作図
金型手配図
金型発注図
量産図面
総合製作書用図面

MicroKontrol Test Mode

How to start and operate the test mode

SETTING + & DC: Self-power full test

MESSEAGE + &DC: Self-power test excluding its internal test

MESSEGE : Proceed the test

SETTING : ITEM UP

SCENE : ITEM DOWN

> : STEP UP

< :STEP DOWN

PART CODE	PART NAME	NOTE	Q'TY
001238200	PCB ASSY KLM-2382 MICRO-KORG	M.PART	1
001243600	PCB ASSY KLM-2436 MC1	M.PART	1
001243700	PCB ASSY KLM-2437 MC1	M.PART	1
001243800	PCB ASSY KLM-2438 MC1	M.PART	1
304000130	TR 2SD1628-G (TS)	KLM-2436	1
304050140	DIGITAL TR DTC114EKA T146 (TS)	KLM-2438	21
304050280	DIGITAL TR DTB113EK T146 (TS)	KLM-2438	26
304060250	FET CPH6302-TL(TS)	KLM-2436	1
314001400	DIODE RLS-73 TE-11 (TS)	KLM-2438	35
314001400	DIODE RLS-73 TE-11 (TS)	KLM-2436	1
314029700	DIODE RLR4004 TE-21 (TS)	KLM-2436	1
314030700	DIODE RB051L-40TE25 (TS)	KLM-2436	5
315000500	DOUBLE DIODE MC-2840-T12-1(TS)	KLM-2436	7
315000600	DOUBLE DIODE MC2838-T12-1 (TS)	KLM-2438	8
320009103	IC NJU6468FG1-00	KLM-2438	1
324007005	IC BA05FP-E2 (TS)	KLM-2436	1
324009019	IC NJM2115M-TE2 (TS)	KLM-2438	1
324018005	IC AK93C75AV-L(TS)	KLM-2436	1
324021020	IC SN74AHCT08PWR(TS)	KLM-2438	3
324021021	IC SN74HC05APWR(TS)	KLM-2436	1
324021103	IC SN74LV32APWR (TS)	KLM-2436	1
324021105	IC SN74LV245APWR (TS)	KLM-2438	2
324021108	IC SN74LV138APWR (TS)	KLM-2438	3
324023009	IC S-8520F30MC-BNS-T2 (TS)	KLM-2436	1
334001700	PHOTO COUPLER PS9714 M-RANK	KLM-2436	1
405012000	AC ADAPTER KA-181(100V/9V)	M.PART 100JP	1
405012100	AC ADAPTER KA-183(120V/9V)	M.PART 117US	1
405012100	AC ADAPTER KA-183(120V/9V)	M.PART 117EX	1
405012100	AC ADAPTER KA-183(120V/9V)	M.PART 117CN	1
405012200	AC ADAPTER KA-189(230V/9V)	M.PART 230FR	1
405012200	AC ADAPTER KA-189(230V/9V)	M.PART 230WG	1
405012200	AC ADAPTER KA-189(230V/9V)	M.PART 230GE	1
405012300	AC ADAPTER KA-186(UK/9V)	M.PART 230UK	1
420006800	37KEY MINI KEYBOARD KM-37	M.PART	1
454012700	DC POWER JACK DJ32-2	KLM-2436	1
454012709	DIN SOCKET DS-05-02(W/OUT SW)	KLM-2436	2
471060500	CONNECTOR TOP B5B-EH-A	KLM-2438	1
471060500	CONNECTOR TOP B5B-EH-A	KLM-2438	1
*315X150003	LED MSB31DA-1	KLM-2438	1
*315X283000	CHIP LED MT-19-22SURVGC/TR8	KLM-2438	11
*315X283001	CHIP LED SML-212VT86	KLM-2438	22
*324X040002	IC XC6351A120MR	KLM-2436	1
*324X283000	IC SN74LV126ADBR	KLM-2436	1
*324X283001	IC SN74LVC139ADBR	KLM-2436	1
*324X283002	IC CD74HC4053PWR	KLM-2436	1
*324X283002	IC CD74HC4053PWR	KLM-2438	2
*324X283003	IC SN74HCT574APWR	KLM-2438	2
*324X283004	IC M51957BFP-600C	KLM-2436	1
*324X283005	IC XC61CN3102MR	KLM-2436	1
*335X283000	CRYSTAL OSC HC-49US 16MHZ	KLM-2436	1
*360X283000	VR R0911NOX-H1B103TG00 10KB	KLM-2436	1

PART CODE	PART NAME	NOTE	Q'TY
*360X283001	VR J002T-B103-60S60-00 W/SW	KLM-2437	1
*365X283000	SVR C3030NOA-V1B502BC50-00	KLM-2438	8
*370X283000	REC E1211A3A-V1FG05-00X3	KLM-2438	9
*373X040001	SLIDE SW JSM2220-0101	KLM-2436	1
*373X283000	SLIDE SW SK-43D01-TK-G8	KLM-2436	1
*402X283000	TROID CORE K1T 16.0X10.0X10.0	M.PART	1
*404X040001	CHIP INDUCTOR C6-K3.0L 10UH	KLM-2436	2
*404X283000	CHIP INDUCTOR C13-K4.5L 22UH	KLM-2436	2
*404X283001	INDUCTOR SMB-201209-N4-102A	KLM-2438	18
*404X283001	INDUCTOR SMB-201209-N4-102A	KLM-2438	31
*404X283002	INDUCTOR BLM21PG221SN1	KLM-2436	2
*415X283000	PIEZO 27MM WO/FB	M.PART	4
*430X283000	MICRO KONTROL CD_ROM	M.PART	1
*450X283000	PHONE JACK PJ-603	KLM-2436	1
*474X150000	SJ CONNECTOR S2M-3WR	KLM-2436	1
*474X238001	CONNECTOR S2M-3W	KLM-2438	1
*474X283000	CONNECTOR S2M-6W	KLM-2436	1
*474X283000	USB CONNECTOR TYPE-B GE813A02	KLM-2436	1
*474X283002	CONNECTOR BA-30SG	KLM-2436	2
*474X283002	CONNECTOR BA-30SG	KLM-2438	2
*475X283000	HARNESS HNS-3278 3PIN 500MM	KLM-2382	1
*475X283001	HARNESS HNS-3281 10PIN 200MM	KLM-2438	1
*475X283002	HARNESS HNS-3280 8PIN 120MM	KLM-2438	1
*475X283003	INTER CONNECTOR YP 33X13.5X2	M.PART	18
*475X283003	HARNESS HNS-3279 6PIN 200MM	KLM-2437	1
*475X283004	HARNESS HNS-3284 5PIN 300MM	M.PART	1
*475X283005	HARNESS HNS-3372 50MM RED	M.PART	1
*475X283006	HARNESS HNS-3373 50MM BLACK	M.PART	1
*475X283007	HARNESS HNS-3288 30PIN 200MM	M.PART	1
*475X283008	HARNESS HNS-3289 30PIN 100MM	M.PART	1
*475X283009	HARNESS HNS-3293 3PIN 350MM	M.PART	1
*500X851003	X-8510 RUBBER LEG KOC-F40709	M.PART	5
*540X283001	X-2830 SHIELD SHEET KOC-F30103	M.PART	1
*550X283000	X-2830 JS FELT KOC-F41056	M.PART	1
*580X283001	X2830 PARAMETER SEAL1 F41068-1	M.PART	1
*580X283002	X2830 PARAMETER SEAL2 F41068-2	M.PART	1
*580X283003	X2830 OVERLAY SHEET KOC-F41067	M.PART	1
*600X283000	USB CABLE TYPE A-B 1.5M	M.PART	1
*620X120007	X-1200 ENCODER KNOB KOC-E30301	M.PART	1
*620X283000	X-2830 RUBBER KEY(8) E30323	M.PART	1
*620X283001	X-2830 RUBBER KEY(16) E30324	M.PART	1
*620X283002	X-2830 JS KNOB KOC-E40577	M.PART	1
*620X283003	X-2830 SLIDER KNOB KOC-E40578	M.PART	8
*620X283004	X-2830 ENCODER KNOB KOC-E40579	M.PART	8
*630X283000	X-2830 LCD WINDOW KOC-F41054	M.PART	1
*630X283001	LCD SHEET DLC-60003NLGF	M.PART	9
*641X283000	X-2830 PANEL KOC-C20405	M.PART	1
*641X283001	X-2830 SIDE BOARD R C30617-1	M.PART	1
*641X283002	X-2830 SIDE BOARD L C30617-2	M.PART	1
*641X283003	X-2830 JACK PLATE KOC-C30616	M.PART	1
*641X283004	X-2830 SIDE ANGLE KOC-C41312	M.PART	2

PART CODE	PART NAME	NOTE	Q'TY
*641X283005	X-2830 PCB SPACER KOC-C41313	M.PART	1
*641X283006	X-2830 PANEL SPACER KOC-C41314	M.PART	2
*644X111000	X-1110 BATTERY SPRING (W)	M.PART	5
*644X111001	X-1110 BATTERY SPRING (+)	M.PART	1
*644X111002	X-1110 BATTERY SPRING (-)	M.PART	1
*646X283000	X-2830 UPPER CASE KOC-E10213	M.PART	1
*646X283001	X-2830 LOWER CASE KOC-E10205-2	M.PART	1
*646X283002	X-2830 BATTERY COVER E30288-2	M.PART	1
*646X283003	X-2830 LCD FRAME KOC-E30325	M.PART	9
*646X283004	X-2830 LCD REFLECTOR E30326	M.PART	9