

DWG NO:					
COMPANY: LOUD Technologies					
TITLE: MR5mk3					
DRAWN: robert	DATED: Jun.07.2013	CHECKED:	DATED:	APPROVED:	DATED:
SIZE:A2		REV:3.0		SHEET: 1 OF 1	

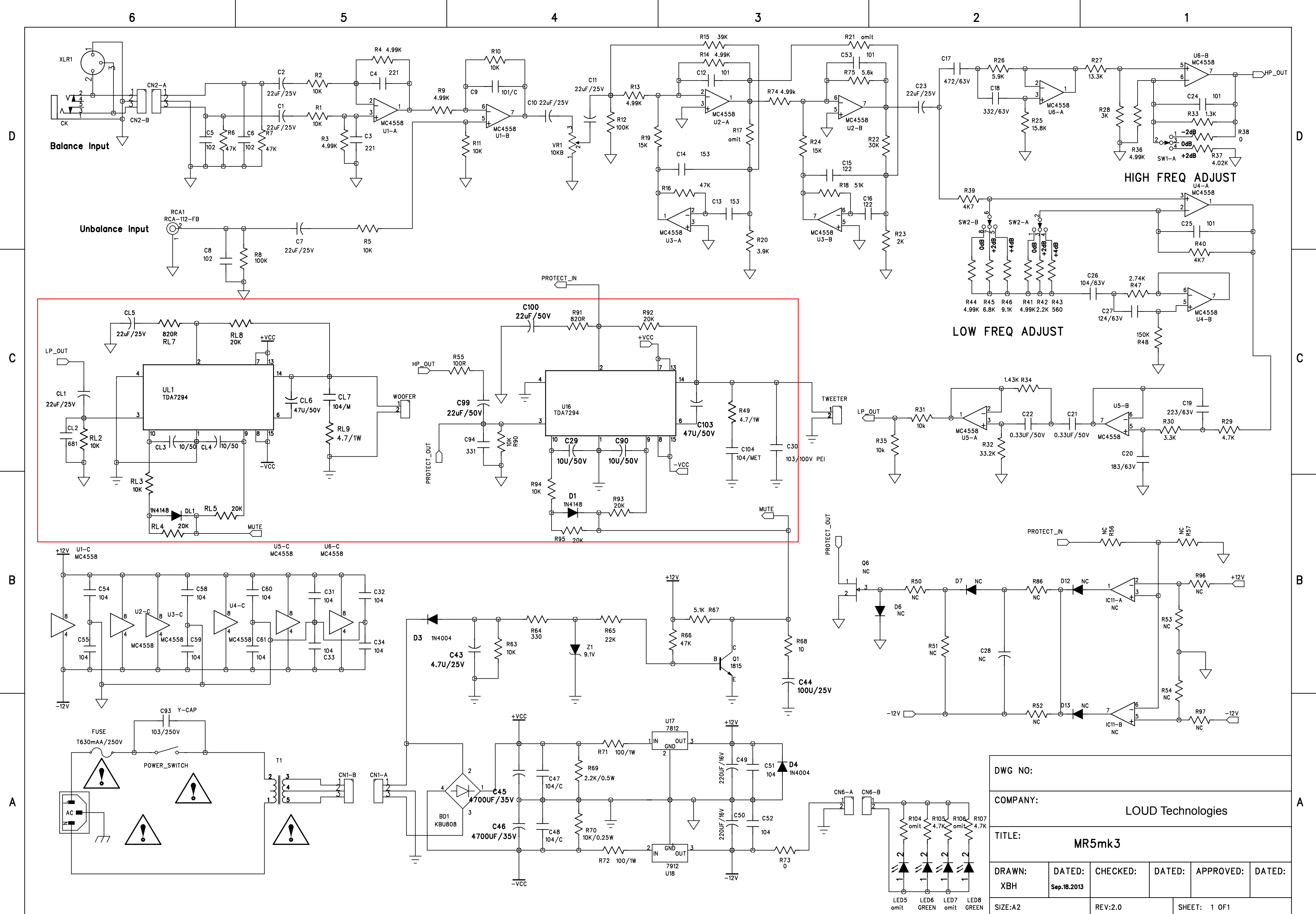

DWG NO:					
COMPANY: LOUD Technologies					
TITLE: MR5mk3					
DRAWN: XBH	DATED: Sep.18.2013	CHECKED:	DATED:	APPROVED:	DATED:
SIZE:A2		REV:2.0		SHEET: 1 OF 1	