

MACKIE®

SR1530

Active Speaker

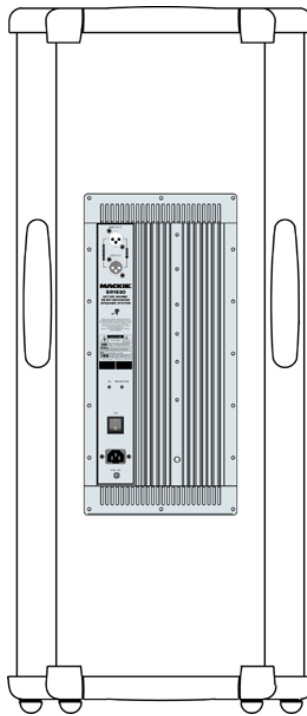
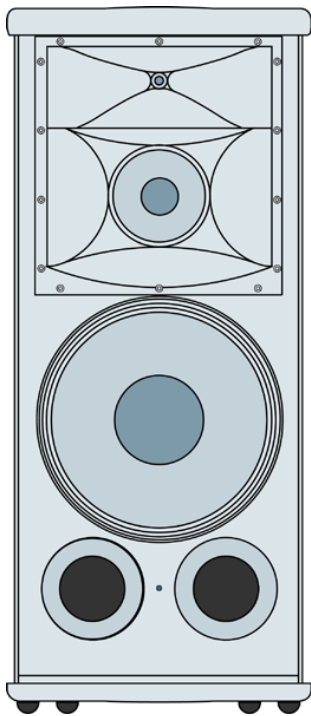

SERVICE MANUAL



SERVICE ON THIS EQUIPMENT IS TO BE PERFORMED BY
EXPERIENCED REPAIR TECHNICIANS ONLY
CONFIER L'ENTRETIEN AU PERSONNEL QUALIFIE



CAUTION AVIS

RISK OF ELECTRIC SHOCK
DO NOT OPEN
*RISQUE DE CHOC ELECTRIQUE
NE PAS OUVRIR*

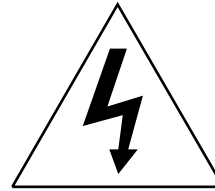

CAUTION: TO REDUCE THE RISK OF
ELECTRIC SHOCK DO NOT REMOVE
THE COVER (OR BACK)
NO USER SERVICEABLE PARTS INSIDE
REFER SERVICING TO QUALIFIED
PERSONNEL

WARNING: TO REDUCE THE RISK OF
FIRE OR ELECTRIC SHOCK, DO NOT
EXPOSE THIS PRODUCT TO RAIN OR
MOISTURE

TO PREVENT ELECTRIC SHOCK, DO
NOT USE THIS POLARIZED PLUG WITH
AN EXTENSION CORD, RECEPTACLE OR
OTHER OUTLET UNLESS THE BLADES
CAN BE FULLY INSERTED TO PREVENT
BLADE EXPOSURE.

ATTENTION: POUR EVITER LES
RISQUES DE CHOC ELECTRIQUE, NE
PAS ENLEVER LE COUVERCLE. AUCUN
ENTRETIEN DE PIECES INTERIEURES
PAR L'USAGER. CONFIER L'ENTRETIEN
AU PERSONNEL QUALIFIE.

AVIS: POUR EVITER LES RISQUES
D'INCENDIE OU D'ELECTROCUTION,
N'EXPOSEZ PAS CET ARTICLE A LA
PLUIE OU A L'HUMIDITE.

POUR PREVENIR LES CHOCS
ELECTRIQUES NE PAS UTILISER CETTE
FICHE POLARISEE AVEC UN
PROLONGATEUR, UN PRISE DE
COURANT OU UNE AUTRE SORTIE DE
COURANT, SAUF SI LES LAMES
PEUVENT ETRE INSEREES A FOND
SANS LAISSER AUCUNE PARTIE A
DECOUVERT.

This apparatus does not exceed the Class A/Class B (whichever is applicable) limits for radio noise emissions from digital apparatus as set out in the radio interference regulations of the Canadian Department of Communications.

ATTENTION :Le présent appareil numérique n'émet pas de bruits radioélectriques dépassant les limites applicables aux appareils numériques de class A/de class B (selon le cas) prescrites dans le règlement sur le brouillage radioélectrique édicté par les ministere des communications du Canada.

This equipment has been tested and found to comply with the limits for a Class A digital device, pursuant to part 15 of the FCC rules. These limits are designed to provide reasonable protection against harmful interference when the equipment is operated in a commercial environment. This equipment generates, uses, and can radiate radio energy and, if not installed properly and used in accordance with the instruction manual, may cause harmful interference to radio communications. Operation of this equipment in a residential area is likely to cause harmful interference in which case the user will be required to correct the interference at his own expense.

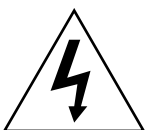

The lightning flash with arrowhead symbol within an equilateral triangle is intended to alert the user to the presence of uninsulated "dangerous voltage" within the product's enclosure, that may be of sufficient magnitude to constitute a risk of electric shock to persons.

Le symbole éclair avec point de flèche à l'intérieur d'un triangle équilatéral est utilisé pour alerter l'utilisateur de la présence à l'intérieur du coffret de "voltage dangereux" non isolé d'ampleur suffisante pour constituer un risque d'électrocution.



The exclamation point within an equilateral triangle is intended to alert the user of the presence of important operating and maintenance (servicing) instructions in the literature accompanying the appliance.

Le point d'exclamation à l'intérieur d'un triangle équilatéral est employé pour alerter les utilisateurs de la présence d'instructions importantes pour le fonctionnement et l'entretien (service) dans le livret d'instruction accompagnant l'appareil.

CONTENTS

Introduction	3
Overview	4
Specifications	5
Test procedure	6
Safety test	8
Parts	9
Service bulletins	19



Fold-out Sections	
Schematics and PCB layouts	
Amplifier board	Amp-1
Filter board	Filter-1
Wiring diagrams	Wiring-1

INTRODUCTION

	<p>SERVICE ON THIS EQUIPMENT IS TO BE PERFORMED BY EXPERIENCED REPAIR TECHNICIANS ONLY</p> <p><i>CONFIER L'ENTRETIEN AU PERSONNEL QUALIFIE</i></p>	
--	---	--

This manual contains basic service information. It is essential that you have a copy of the user's manual as this contains the complete operating instructions.

SERVICE TECHNICAL ASSISTANCE

Mackie Designs, Service Technical Assistance, is available 8AM - 5PM PST, Monday through Friday for Authorized Mackie Service Centers, at 1-800-258-6883. Feel free to call with any questions and speak with a carefully-calibrated technician. If one is not available, leave a detailed message and a qualified Mackoid will return your call asap.

DISCLAIMER

The information contained in this manual is proprietary to Mackie Designs, Inc. The entire manual is protected under copyright and may not be reproduced by any means without express written permission from Mackie Designs, Inc.

OVERVIEW

The SR1530 is a high output, horn loaded, 3-way, wide dispersion, active sound reinforcement system. It features a one-piece 90° x 40° horn, which includes both the mid and high frequency sections in a proprietary "Optimal Wavefront" design. Unlike typical mid/high horn designs, the high frequency section is positioned to fire down into the six-inch mid-range's dispersion pattern. This creates a focused, single wave front with excellent phase and power response characteristics.

The mid-range transducer operates between 700Hz and 3000Hz, eliminating the placement of a crossover point in the middle of critical voice frequencies. Frequencies above 3000Hz are reproduced by a 1-inch exit compression driver. The low frequencies are produced through a high output 15-inch woofer.

The SR1530 accepts a line-level signal via a female XLR input jack. A male XLR Thru jack is provided for daisy-chaining the signal to additional SR1530 cabinets.

Two built-in power amplifiers provide 100 watts each for the mid-frequency and high-frequency drivers. The low-frequency driver is powered by a high-efficiency, high-current Class G topology amplifier providing 300 watts of power. The amplifier modules sit on a large heatsink that eliminates the need for fans, dramatically extending life expectancy, and eliminating maintenance cycles.

The cabinet is constructed using both 18mm multi-layered plywood and pressure injected structural resin. Two carrying handles are integrated into each side for easy loading and transport.

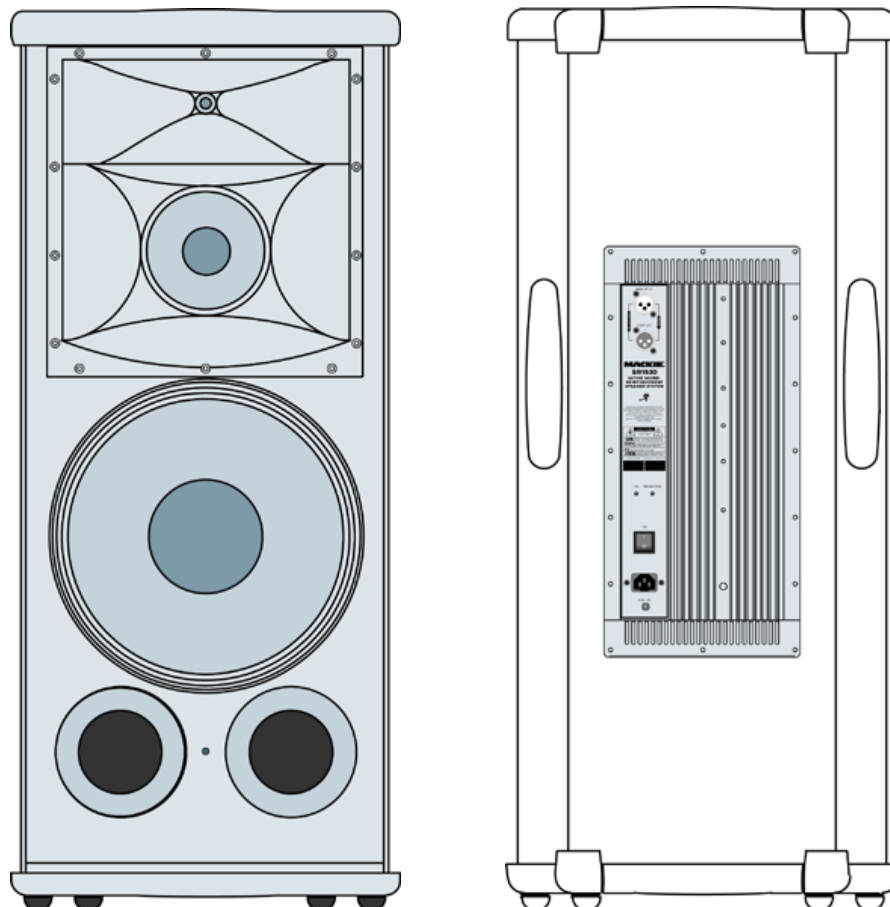

SPECIFICATIONS

System Specifications

Frequency Range	40Hz–20kHz
Frequency Response (-3 dB)	45Hz–18kHz
Horizontal Coverage Angle (-6 dB)	90° averaged 2kHz to 10kHz
Vertical Coverage Angle (-6 dB)	40° averaged 2kHz to 10kHz
Directivity Factor; DI (Q)	10.77 (11.95) averaged 2kHz to 10kHz
Maximum SPL @ 1m	123 dB
Peak Output @ 1m	126 dB
Crossover Points	700Hz, 3000Hz
Dynamic Range	> 100 dB
Phase Response	±40° from 500Hz to 10kHz
Input Type	Balanced differential
Input Impedance	50K ohms
Input Protection	Monitoring and limiting of continuous rms output of the amplifiers
Thermal Protection	Input stage muting, auto-reset

Transducer Specifications

Low-Frequency Transducer	
Diameter	15" (381mm)
Voice Coil Diameter	2.5" (63mm)
Power Handling	250 watts rms
Mid-Frequency Transducer	
Diameter	6" (152mm)
Voice Coil Diameter	2" (50mm)
Power Handling	60 watts rms
High-Frequency Transducer	
Diaphragm Diameter	1" (25mm)
Voice Coil Diameter	1" (25mm)
Power Handling	25 watts rms
Diaphragm Material	Mylar

Power Amplifiers

Low-Frequency Power Amplifier	
Burst Capability	300 watts
Rated THD	< 0.05%
Design	Class G, High Efficiency/High Current
Mid and High-Frequency Power Amplifiers	
Burst Capability	100 watts
Rated THD	< 0.1%
Design: Integrated Module	
Line Input Power	
US	120V, 60Hz
Recommended Amperage Service	8 amps
Europe	230V, 50Hz
Recommended Amperage Service	5 amps

Physical Properties

Height	43.9" (1116mm)
Front Width	19.1" (484mm)
Rear Width	13.9" (352mm)
Depth	18.1" (460mm)
Weight 100 lbs.	(45.5kg)
Enclosure	18mm thick multi-layered plywood, top and bottom high pressure resin injected "caps"
Enclosure Geometry	Trapezoidal, 10° angle sides
Mounting Methods	Floor mount

Disclaimer

Since we are always striving to make our products better by incorporating new and improved materials, components, and manufacturing methods, we reserve the right to change these specifications at any time without notice.

"Mackie" and the "Running Man" figure are trademarks or registered trademarks of Mackie Designs Inc.

All other brand names mentioned are trademarks or registered trademarks of their respective holders, and are hereby acknowledged.

©2000 Mackie Designs Inc.

All Rights Reserved.

Printed in Italy.

Amplifier Test Procedure

TEST EQUIPMENT

Audio generator/analyser
Oscilloscope
Voltmeter
2 load resistors 16 ohm, 200W
1 load resistor 8 ohm, 100W
Variac with voltage and current-draw meters

1 INSPECTION

- 1.1 Inspect all components, solder, wires, connectors, screws, heatsink screws. Make sure all transistors and IC amps are secured correctly to the heatsink.

2 CONNECTIONS

- 2.1 Connect the two 16 ohm loads to the Low and High outputs (Low+ Low- and Hi+ Hi -).
- 2.2 Connect the 8 ohm load to the Mid outputs (Mid+ and Mid -).
- 2.3 Connect the audio generator's output to the XLR input of the SR1530.
- 2.5 Initially connect the analyser and scope to the 16 ohm load on the Low Freq section.
- 2.6 Connect the variac to the AC connector of the SR1530.
- 2.7 Set the frequency to 200 Hz, at minimum output.
- 2.8 Turn on the SR1530 Power Switch

3 POWER UP

- 3.1 Slowly bring the Variac up to 115 Vac (230 Vac for European models).
- 3.2 Verify that the green led is illuminated.
- 3.3 Verify an ac current draw of: 340 mA \pm 10 % (115 Vac)
170 mA \pm 10 % (230 Vac).
- 3.4 Verify with a DC voltmeter the values of the two DC rails (\pm 25 Vdc; \pm 50 Vdc) with a tolerance of approx 1.5 Vdc for the 25V rail and approx 2 Vdc for the 50V rail.

4 VERIFICATION OF THE LOW FREQUENCY SECTION.

- 4.1 Initially set the input signal to 30 mV at 100Hz.
- 4.2 Increase the input signal slowly until the limiter starts to stabilize the output to 35V (approximately 76.7W) with an input of approx 250 mV.
- 4.3 Lower the input signal until the limiter is not operating. The input signal should be approx 220\230mV) and the output signal should be 32V (approx 63.5 W into the 16 ohm load).
- 4.4 Bypass the limiter temporarily by shorting the led section of the optocoupler, and increase the input signal until the output signal is clipping. Verify this occurs at approx 53 volts (180 W into the 16 ohm load). The input signal should be approx 380mV.
- 4.5 Remove the short circuit and verify that the limiter kicks in after 7 or 8 seconds.

5 VERIFICATION OF THE HIGH FREQUENCY SECTION.

- 5.1 Connect the analyser and scope to the 16 ohm load on the High Freq section.
- 5.2 Initially set the input signal to 100 mV at 10 kHz.
- 5.3 Increase the input signal slowly until the limiter starts to stabilize the output to 10.1V (approx 6.4W into 16 ohms) with an input of approx 240 mV.
- 5.4 Lower the input signal until the limiter is not operating. The input signal should be approx 190\200mV) and the output signal should be 7.9V (approx 3.9 W into 16 ohms).
- 5.5 Bypass the limiter temporarily by shorting the led section of the optocoupler, and increase the input signal until the output signal is clipping. Verify this occurs at approx 19.2 volts (23 W into 16 ohms). The input signal should be approx 441 mV.
- 5.6 Remove the short circuit and verify that the limiter kicks in after 6 to 7 seconds.

6 VERIFICATION OF THE MID FREQUENCY SECTION.

- 6.1 Connect the analyser and scope to the 8 ohm load on the Mid Freq section.
- 6.2 Initially set the input signal to 120 mV at 1 kHz.
- 6.3 Increase the input signal slowly until the limiter starts to stabilizes the output to 14.6V (approx 26.7W into 8 ohms) with an input of approx. 560 mV.
- 6.4 Lower the input signal until the limiter is not operating. The input signal should be approx 490\500mV) and the output signal should be 12.9V (approx 20.9 W into 8 ohms).
- 6.5 Bypass the limiter temporarily by shorting the led section of the optocoupler, and increase the input signal until the output signal is clipping. Verify this occurs at approx 24 volts (72 W into 16 ohms). The input signal should be approx 940 mV.
- 6.6 Remove the short circuit and verify that the limiter kicks in after 5 to 6 seconds.

Safety test



You must perform the following leakage test before returning the unit to your customer. Take every safety precaution to protect yourself while doing this test.



1. Make a small loading RC circuit as shown in the diagram below, and connect the AC volt meter between the AC power source ground and any exposed metal on the unit under test.
2. Connect the unit under test to an AC power source using a ground-lift adaptor, leaving the unit's safety ground floating. Turn the unit on.
3. The meter reading should be less than 750mVAC (note: this is equivalent to 0.5mA of leakage current).
4. Flip the plug over in the receptical so the hot and neutral are swapped. Verify that the reading is still less then 750mVAC.
5. If either reading is greater than 750mVAC, then you must investigate and repair the unit before returning it to your customer.

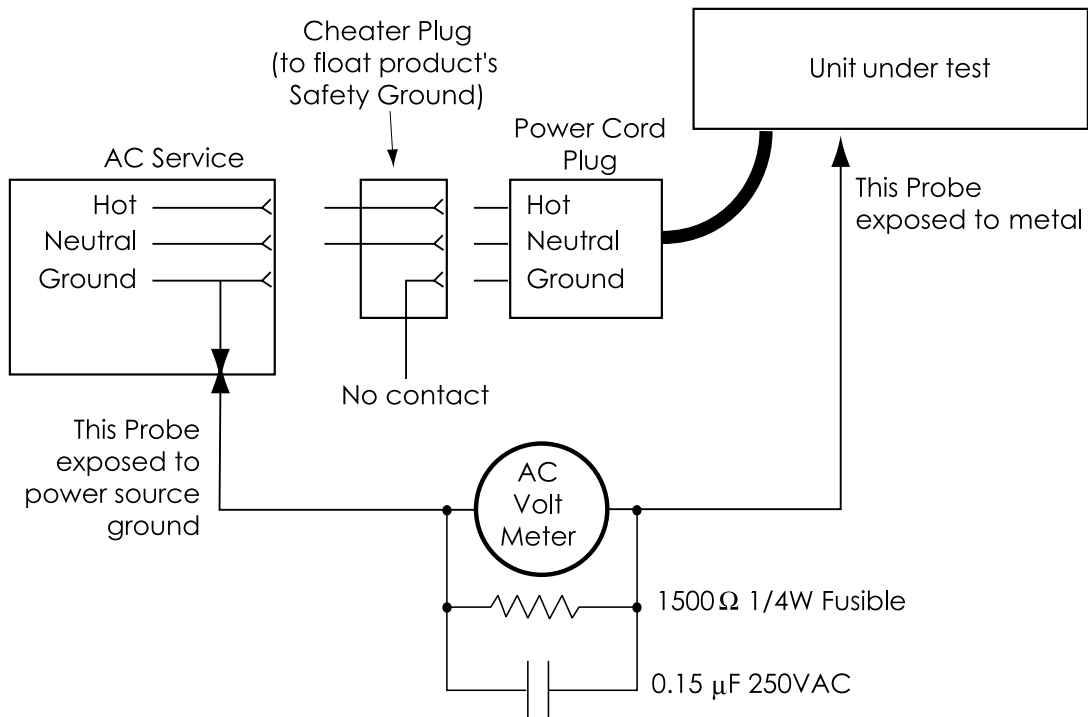

SR1530 PARTS LIST

<u>PART#</u>	<u>DESCRIPTION</u>	<u>PAGE</u>
13110050	SR1530 ASSEMBLY	10
23103130	AMPLIFIER SUBASSEMBLY	11
23103130	AMPLIFIER SUBASSEMBLY (dual volt)	11
23103130	AMPLIFIER SUBASSEMBLY (115V)	11
23103810	AMPLIFIER SUBASSEMBLY (100V)	12
23103710	AMPLIFIER SUBASSEMBLY (230V)	13
23103820	AMPLIFIER SUBASSEMBLY (240V)	13
3020490	AMPLIFIER PCB ASSEMBLY	14
23030110	FILTER PCB ASSEMBLY	15
	EARLY AMPLIFIER ASSEMBLY	16
	LATEST AMPLIFIER COMMON PARTS	18
	RECONE KIT	18



WARNING: IN THE PAGES WHICH FOLLOW, PARTS WHICH ARE MARKED WITH THE WARNING TRIANGLE SHOULD ONLY BE REPLACED WITH EXACT REPLACEMENT PARTS. THIS IS REQUIRED TO MAINTAIN PRODUCT SAFETY.







MACKIE SR1530 SERVICE MANUAL

13110050 SR 1530 ASSEMBLY 115V

PART#	DESCRIPTION	QTY	COMMENTS
SC034351	WIRING DIAGRAM REVD	1	
21110110	LOUDSPEAKER L15-64-MAS 1530 REVA	1	WOOFER
21110120	MR 160-MAS 1530 REVA	1	MIDRANGE
23020480	LED BOARD ASSEMBLY	1	
23030110	FILTER ASSEMBLY	1	SEE PAGE 13
23103130	AMPLIFIER SUBASSEMBLY	1	SEE PAGE 11
23103150	LOUDSPEAKER CABLE ASSEMBLY	1	
23103490	LED CABLE ASSEMBLY	1	
25110160	TWEETER N 270-MAS 1530 REVA	1	TWEETER
33090410	CABINET 34231	1	
33090460	HANDLE HOUSING 34278	2	
33161060	WOOFER GASKET 23630	1	
33180120	TOP VENTILATION PLATE 34332	1	FITS ON TOP OF AMPLIFIER
33180360	LOWER VENTILATION PLATE 35271	1	FITS ON BOTTOM OF AMPLIFIER
33221510	FRONT GRILL 35723	1	
33890150	VIBRATION-DAMPING MATERIAL 23418	1	MOUNTS INSIDE, NEAR THE HOLE FOR THE STAND
33890190	CABINET FEET 34344	4	
33900120	SIDE HANDLE BAR 33939	2	HANDLE BAR
33900360	CIRCULAR PLUGS 34360	2	TOP/BOTTOM PLUGS WITH LOGO
33900470	REFLEX PORT 35255	2	CIRCULAR BASS REFLEX PORTS
33910660	ABSORBENT FOAM 35724	1	
33910670	ABSORBENT FOAM 35739	2	
33920590	PLASTIC SIDE HANDLE GRIP 34280	2	HANDLE GRIP
33920650	TOP HANDLE 34335REV B	2	TOP HANDLE
33951530	MACKIE LABEL 34342	1	
33951540	MACKIE ACTIVE LOGO 34343	1	
33951980	RUNNING MAN LOGO 34844	1	
33990990	PACKAGING BOX 34357	1	
33991000	INTERNAL PACKAGING 34358	1	
33991010	INTERNAL PACKAGING 34367	4	
33994410	INTERNAL PACKAGING 35551	1	
33995370	ANGLE 1800 33302		
33995500	PACKAGE COVER 35706	1	
33995510	PALLET 35705	1	WOODEN PALLET PACKAGING
43900580	RUBBER "U" PROFILE 200S	1	
43900600	GROMMET 34582	2	
43900820	GASKET 32181	1	
51150351	SCREW V.TC+M4 X30ZNN U7687	8	
51170415	SCREW V.TSC+M5 X10ZNN U7689	8	
51190230	SCREW V.TCEI M5 X20 ZNN U5931 10559 1/2	2	
51240211	SCREW V.TC+AB 2,9X9,5ZNN U6954 12600 1/2	1	
51310402	SCREW V.TC+SL 3,5X10 ZNN	1	
51310523	SCREW V.TC+SL 4X20 ZNN 6175 1/2	16	
51310545	SCREW V.TC+SL 4X40 ZNN	22	
51510221	SCREW V.TC+AUTOP.DK3,5X19ZNC UNI 8118	4	
51991009	SCREW V.TC+AUTOM. SW M4X10 ZNN U8112	4	
51992013	SCREW V.T1/2T+SL 4X16 ZNN 34462	12	
52100110	WASHER 4,3X 9ZNN U6592 6329 1/2	39	
52100116	WASHER 5,3X10ZNC U6592 11618 1/2	2	
52201004	WASHER 5 DIN6798 0239	2	
54302001	LOCK WASHER 35059	2	
 83483019	POWER CORD-USA C3C83-012E003	1	
 83483013	POWER CORD EU	1	
 83483021	POWER CORD U.K.	1	







23103130 AMPLIFIER SUBASSEMBLY (115V Dual-voltage Xformer)

PART#	DESCRIPTION	QTY	COMMENTS
SE034341	SCHEMATIC	1	
23020490	AMPLIFIER CIRCUIT BOARD ASSEMBLY	1	SEE PAGE 12
23102690	WIRE ASSEMBLY UR	2	
23103140	WIRE ASSEMBLY UR	1	
33120320	HEATSINK 34322	1	HEATSINK
33951510	STICKER AMPLIFIER 34334	1	
51150316	SCREW V.TC+M4 X10ZNN U7687 6233	6	
51180571	SCREW V.TE M8 X90ZNN U5739	1	TRANSFORMER BOLT
51240110	SCREW V.TC+AB 2,2X9,5ZNC U6954 50452	8	
51240211	SCREW V.TC+AB 2,9X9,5ZNN U6954 12600 1/2	4	
51250211	SCREW V.TSP+AB2,9X9,5ZNN U6955 12596	2	
52100110	WASHER 4,3X 9ZNN U6592 6329 1/2	6	
52100138	WASHER 8,4X17ZNN U6592	2	
52201003	WASHER 4 DIN6798 11647 1/2	6	
52201005	WASHER 8 DIN6798 176	2	
53301025	NYLOCK NUT M8	1	TRANSFORMER NUT
 81751005	C1T51-008A -POWER TRANSFORMER	1	DUAL VOLTAGE TRANSFORMER
 83111141	C3P11-003T402-FUSE 4 AT	2	FUSES
 83242013	C3S42-015 -SWITCH	1	
 83482004	C3C82-004M003-RECESSED AC SOCKET	1	AC SOCKET



NOTE: The earlier models used a dual voltage transformer as shown above. Later models use a different transformer for each of the four voltage models: 100, 115, 230 and 240VAC, as shown below and on the next two pages.

23103130 AMPLIFIER SUBASSEMBLY (115V Transformer)

PART#	DESCRIPTION	QTY	COMMENTS
23020490	AMPLIFIER CIRCUIT BOARD ASSEMBLY	1	
23102690	WIRE ASSEMBLY UR	2	
23102740	WIRE ASSEMBLY UR	2	
23103680	WIRE ASSEMBLY GREEN/YELLOW	1	
33120320	HEATSINK 34322	1	
33890200	SPACER 35717	2	
33951510	STICKER AMPLIFIER 34334	1	
51150331	SCREW V.TC+M4 X16ZNN U7687	6	
51160335	SCREW V.TSP+M4 X16ZNN U7688	1	
51190475	SCREW V.TCEI M8X90 ZNN U5931	1	
51240211	SCREW V.TC+AB 2.9X9.5ZNN U6954 12600 1/2	4	
51240303	SCREW V.TC+ B 3.5X6.5ZNC U6954 11620	10	
51250211	SCREW V.TSP+AB2.9X9.5ZNN U6955 12596	2	
52100110	WASHER 4.3X 9ZNN U6592 6329 1/2	7	
52100138	WASHER 8.4X17ZNN U6592	2	
52100142	WASHER 3.2X6 ZNN U6592	4	
52201003	WASHER 4 DIN6798 11647 1/2	8	
52201005	WASHER 8 DIN6798 176	2	
53102010	NUT M 4 U5588-A-6S 01880 1/2	2	
53301025	NUT M8 NYLOCK	1	
 81751111	C1T51-092A -POWER TRANSFORMER	1	
 83111144	C3P11-003T802-FUSE 8 AT	2	
 83242013	C3S42-015 -POWER SWITCH	1	
 83482004	C3C82-004M003-AC SOCKET	1	
83822008	C3A22-008 -ANCORAGGIO SN	1	



Components noted with this symbol shall be replaced only by the component specified. This is required to maintain product safety.

23103810 AMPLIFIER SUBASSEMBLY (100V Transformer)

PART#	DESCRIPTION	QTY	COMMENTS
23020490	AMPLIFIER CIRCUIT BOARD ASSEMBLY	1	
23102690	WIRE ASSEMBLY UR	2	
23102740	WIRE ASSEMBLY UR	2	
23103680	WIRE ASSEMBLY GREEN/YELLOW	1	
33120320	HEATSINK 34322	1	
33890200	SPACER 35717	2	
33951510	STICKER AMPLIFIER 34334	1	
33953510	STICKER 100V 35698	1	
51150331	SCREW V.TC+M4 X16ZNN U7687	6	
51160335	SCREW V.TSP+M4 X16ZNN U7688	1	
51190475	SCREW V.TCEI M8X90 ZNN U5931	1	
51240211	SCREW V.TC+AB 2.9X9.5ZNN U6954 12600 1/2	4	
51240303	SCREW V.TC+ B 3.5X6.5ZNC U6954 11620	10	
51250211	SCREW V.TSP+AB2.9X9.5ZNN U6955 12596	2	
52100110	WASHER 4.3X 9ZNN U6592 6329 1/2	7	
52100138	WASHER 8.4X17ZNN U6592	2	
52100142	WASHER 3.2X6 ZNN U6592	4	
52201003	WASHER 4 DIN6798 11647 1/2	8	
52201005	WASHER 8 DIN6798 176	2	
53102010	NUT M 4 U5588-A-6S 01880 1/2	2	
53301025	NUT M8 NYLOCK	1	
⚠ 81751110	C1T51-091A -POWER TRANSFORMER	1	
⚠ 83111144	C3P11-003T802-FUSE 8 AT	2	
⚠ 83242013	C3S42-015 -POWER SWITCH	1	
⚠ 83482004	C3C82-004M003-AC SOCKET	1	
83822008	C3A22-008 -ANCORAGGIO SN	1	





23103710 AMPLIFIER SUBASSEMBLY (230V Transformer)

PART#	DESCRIPTION	QTY	COMMENTS
23020490	AMPLIFIER CIRCUIT BOARD ASSEMBLY	1	
23102690	WIRE ASSEMBLY UR	2	
23102740	WIRE ASSEMBLY UR	2	
23103680	WIRE ASSEMBLY GREEN/YELLOW	1	
33120320	HEATSINK 34322	1	
33890200	SPACER 35717	2	
33951510	STICKER AMPLIFIER 34334	1	
33953000	STICKER 230V 35543	1	
51150331	SCREW V.TC+M4 X16ZNN U7687	6	
51160335	SCREW V.TSP+M4 X16ZNN U7688	1	
51190475	SCREW V.TCEI M8X90 ZNN U5931	1	
51240211	SCREW V.TC+AB 2.9X9.5ZNN U6954 12600 1/2	4	
51240303	SCREW V.TC+ B 3.5X6.5ZNC U6954 11620	10	
51250211	SCREW V.TSP+AB2.9X9.5ZNN U6955 12596	2	
52100110	WASHER 4.3X 9ZNN U6592 6329 1/2	7	
52100126	WASHER 9X24 ZNC U6593	1	
52201003	WASHER 4 DIN6798 11647 1/2	8	
52201005	WASHER 8 DIN6798 176	2	
53102010	NUT M 4 U5588-A-6S 01880 1/2	2	
53301025	NUT M8 NYLOCK	1	
⚠ 81751112	C1T51-093A -POWER TRANSFORMER	1	
⚠ 83111141	C3P11-003T402-FUSE 4 AT	2	
⚠ 83242013	C3S42-015 -POWER SWITCH	1	
⚠ 83482004	C3C82-004M003-AC SOCKET	1	



23103820 AMPLIFIER SUBASSEMBLY (240V Transformer)



PART#	DESCRIPTION	QTY	COMMENTS
-------	-------------	-----	----------

23020490	AMPLIFIER CIRCUIT BOARD ASSEMBLY	1	
23102690	WIRE ASSEMBLY UR	2	
23102740	WIRE ASSEMBLY UR	2	
23103680	WIRE ASSEMBLY GREEN/YELLOW	1	
33120320	HEATSINK 34322	1	
33890200	SPACER 35717	2	
33951510	STICKER AMPLIFIER 34334	1	
33953520	STICKER 240V 35697	1	
51150331	SCREW V.TC+M4 X16ZNN U7687	6	
51160335	SCREW V.TSP+M4 X16ZNN U7688	1	
51190475	SCREW V.TCEI M8X90 ZNN U5931	1	
51240211	SCREW V.TC+AB 2.9X9.5ZNN U6954 12600 1/2	4	
51240303	SCREW V.TC+ B 3.5X6.5ZNC U6954 11620	10	
51250211	SCREW V.TSP+AB2.9X9.5ZNN U6955 12596	2	
52100110	WASHER 4.3X 9ZNN U6592 6329 1/2	7	
52100138	WASHER 8.4X17ZNN U6592	2	
52100142	WASHER 3.2X6 ZNN U6592	4	
52201003	WASHER 4 DIN6798 11647 1/2	8	
52201005	WASHER 8 DIN6798 176	2	
53102010	NUT M 4 U5588-A-6S 01880 1/2	2	
53301025	NUT M8 NYLOCK	1	
 81751113	C1T51-094A -POWER TRANSFORMER	1	
 83111141	C3P11-003T402-FUSE 4 AT	2	
 83242013	C3S42-015 -POWER SWITCH	1	
 83482004	C3C82-004M003-AC SOCKET	1	
83822008	C3A22-008 -ANCORAGGIO SN	1	



Components noted with this symbol shall be replaced only by the component specified. This is required to maintain product safety.

3020490 AMPLIFIER PCB ASSEMBLY

PART#	DESCRIPTION	QTY	COMMENTS
33030370	PCB 34341	1	PCB
33120310	HEATSINK X TRANSISTOR 34329	1	
33180100	BRACKET X TRANSISTOR 34327	4	TRANSISTOR BRACKETS
33912310	INSULATING STRIP 33238	6	INSULATING STRIPS
51150216	SCREW V.TC+M3 X8 ZNN U7687 6686	11	
51150316	SCREW V.TC+M4 X10ZNN U7687 6233	6	
52100103	WASHER 3,2X 6ZNC U6592 12272	3	
52100110	WASHER 4,3X 9ZNN U6592 6329 1/2	6	
52201002	WASHER 3 DIN6798 11628 1/2	8	
81121000	C1R21-251J0R0-RES.STR. 1/4W5% 0	1	RESISTORS
81121001	C1R21-251J010-RES.STR. 1/4W5% 1	1	
81121013	C1R21-251J100-RES.STR. 1/4W5% 10	1	
81121021	C1R21-251J470-RES.STR. 1/4W5% 47	4	
81121025	C1R21-251J101-RES.STR. 1/4W5% 100	6	
81121031	C1R21-251J331-RES.STR. 1/4W5% 330	4	
81121036	C1R21-251J821-RES.STR. 1/4W5% 820	15	
81121037	C1R21-251J102-RES.STR. 1/4W5% 1K	3	
81121041	C1R21-251J222-RES.STR. 1/4W5% 2,2K	2	
81121043	C1R21-251J332-RES.STR. 1/4W5% 3,3K	1	
81121045	C1R21-251J472-RES.STR. 1/4W5% 4,7K	1	
81121046	C1R21-251J562-RES.STR. 1/4W5% 5,6K	1	
81121049	C1R21-251J103-RES.STR. 1/4W5% 10K	21	
81121053	C1R21-251J223-RES.STR. 1/4W5% 22K	6	
81121057	C1R21-251J473-RES.STR. 1/4W5% 47K	1	
81121061	C1R21-251J104-RES.STR. 1/4W5% 100K	1	
81121073	C1R21-251J105-RES.STR. 1/4W5% 1M	8	
 81127322	C1R27-202K100-RES.FUSE 2W10% 10	2	FUSIBLE RESISTOR
81136001	C1R36-162J010-RES.MET. 1,6W5% 1	2	
81136075	C1R36-162J122-RES.MET. 1,6W5% 1,2K	2	
81136081	C1R36-162J222-RES.MET. 1,6W5% 2,2K	4	
81241019	C1F41-302J3R3-RES.FILO 3W5% 3,3	8	RESISTOR-WIRE WOUND
81413007	C1C13-101K103-COND.FILM100V10% 10N	4	CAPACITORS-FILM
81413009	C1C13-101K223-COND.FILM100V10% 22N	4	
81413013	C1C13-101K104-COND.FILM100V10% 100N	16	
81413026	C1C13-500K224-COND.FILM50V10% 220N	4	
81421007	C1C21-500K100-COND.CER.50V10% 10 P	1	CAPACITORS-CERAMIC
81421019	C1C21-500K101-COND.CER.50V10% 100 P	1	
81421023	C1C21-500K221-COND.CER.50V10% 220P	7	
81426045	C1C26-500K105-COND.CER.50V10% 1U	4	
81426055	C1C26-500J681-COND.CER.50V5% 680P	2	
81521047	C1E21-250*100-COND.EL. 25V 10U	5	CAPACITORS-ELECTROLYTIC
81521048	C1E21-250*220-COND.EL. 25V 22U	6	
81521050	C1E21-250*101-COND.EL. 25V 100U	2	
81533036	C1E33-250*103-COND.EL. 25V 10000U	4	
81533047	C1E33-101*222-COND.EL. 100V 2200U	1	
82112001	C2D12-750*151-DIODE 1N4148	23	DIODES
82122014	C2D22-201*352-DIODE BYV28	4	
82122015	C2D22-101*402-DIODE MUR410	2	
 82131015	C2D31-132J150-ZENER 1,3W 15V	1	ZENER DIODES
 82131050	C2D31-501J120-ZENER 0,5W 12V	6	
 82131051	C2D31-501J130-ZENER 0,5W 13V	2	
 82175011	C2D75-211*802-BRIDGE 8A	2	BRIDGE RECTIFIER



PART#	DESCRIPTION	QTY	COMMENTS
82212002	C2T12-101B450-TRANSISTOR BC560/C	2	TRANSISTORS
82212019	C2T12-101C450-TRANSISTOR BC550	6	
82232020	C2T32-102B101-TRANSISTOR TIP30	1	
82232021	C2T32-102A101-TRANSISTOR TIP29	1	
82262017	C2T62-143A101-MOSFET IRF530	2	FETS
82262018	C2T62-193B101-MOSFET IRF9540	2	
82312005	C2A12-25532 -IC NE5532	1	INTEGRATED CIRCUIT
82322010	C2A22-1*3886 -IC LM3886	6	INTEGRATED CIRCUIT
⚠ 82511006	C2F11-006 -DIODE LED RED	1	LED
⚠ 82512008	C2F12-008 -DIODE LED GREEN	1	
⚠ 82561001	C2F61-001*5C8-OPTOCOUPLER VTL	1	OPTOCOUPLER
⚠ 83121006	C3P21-006*102-THERMAL SWITCH	1	THERMAL SWITCH
83142005	C3P42-251K224-COND.FILM.250V10%0.22	1	CAPACITOR-FILM
83414023	C3C14-019M003-CONNECTOR XLR MALE	1	
83414024	C3C14-019F003-CONNECTOR XLR FEMALE	1	
83432089	C3C32-022F005-CONNECTOR 5P	2	
83432090	C3C32-022F010-CONNECTOR 10P	1	
83434001	C3C34-001M001-FASTON 90	24	
⚠ 83811002	C3A11-002 -INSULATOR	6	INSULATOR
⚠ 83812001	C3A12-001 -INSULATING WASHER	12	INSULATOR

23030110 FILTER ASSEMBLY

PART#	DESCRIPTION	TYPE	QTY	REF. DESIGNATORS
	C1R21-251F1501RES.STR.	1K5	2	R6 R19
	C1R21-251F3323RES.STR.	330k	1	R8
	C1R21-251F5600RES.STR.	560R	3	R4 R7 R30
81121592	C1R21-251F3320RES.STR.	330 5%	1	R27
81121638	C1R21-251F1001RES.STR.	1K 5%	6	R1-2 R15-16 R25-26
81121671	C1R21-251F2211RES.STR.	2K2	3	R37
81121688	C1R21-251F3321RES.STR.	3K3 5%	7	R5 R9-11 R13 R20 R29
	C1R21-251F3901RES.STR.	3K9 5%	1	R22
	C1R21-251F6801RES.STR.	6K8 5%	2	R12 R21
	C1R21-251F8201RES.STR.	8K2 5%	2	R14 R35
81121734	C1R21-251F1002RES.STR.	10K 5%	3	R17-18 R23
81121767	C1R21-251F2212RES.STR.	22K 5%	1	R36
	C1R21-251F4702RES.STR.	47K 5%	1	R28
	C1R21-251F4703RES.STR.	470K 5%	1	R3
81413022	C1C13-630K474-COND.FIL	.047 10%	5	C1 C6 C8-9 C27
81413013	C1C13-101K104-COND.FIL	.01 2.0%	4	C10 C12-13 C15
81413003	C1C13-101K222-COND.FIL	.0022 2.0%	1	C14
81413004	C1C13-101K332-COND.FIL	.0033 2.0%	1	C18
81413005	C1C13-101K472-COND.FIL	.0047 2.0%	1	C11
81413013	C1C13-101K104-COND.FIL	.1 10%	7	C2 C4
81413026	C1C13-500K224-COND.FIL	.22 10%	3	C3 C29
	C1C13-101K122-COND.FIL	.0012 2.0%	1	C16
81421124	C1C21-500J101-COND.CER	100PF 10%	1	C28
81521074	C1E21-630*4R7-COND.LYTIC	4.7UF 10%	1	C17
	LED GREEN		2	D1-2
82312005	C2A12-25532 -CIRC.INT	NE5532AN	6	U1-6
	C3C32-022F10		2	J1 J3
	C3C32-022F20		1	J2
			2	J6-7



Components noted with this symbol shall be replaced only by the component specified. This is required to maintain product safety.

MACKIE SR1530 SERVICE MANUAL

This is an older amplifier board. It may be useful as it shows Mackie-US part numbers and some reference designators.

PART#	DESCRIPTION	VALUE	REFERENCE DESIGNATORS
110-001-00	RES CF .25W 5% 10 OHM	10 5%	R81
110-017-00	RES CF .25W 5% 47 OHM	47 5%	R84-87
110-025-00	RES CF .25W 5% 100 OHM	100 5%	R56-57 R66-67 R76 R92
110-037-00	RES CF .25W 5% 330 OHM	330 5%	R51-52 R61-62
110-047-00	RES CF .25W 5% 820 OHM	820 5%	R21-23 R26-27 R34-36 R39-40 R47 R58 R69-71
110-049-00	RES CF .25W 5% 1K OHM	1K 5%	R1 R3
110-057-00	RES CF .25W 5% 2K2 OHM	2K2 5%	R10 R13 R17 R90-91 R106
110-061-00	RES CF .25W 5% 3K3 OHM	3K3 5%	R99
110-065-00	RES CF .25W 5% 4K7 OHM	4K7 5%	R82
110-067-00	RES CF .25W 5% 5K6 OHM	5K6 5%	R83
110-073-00	RES CF .25W 5% 10K OHM	10K 5%	R2 R4-7 R12 R15-16 R19-20 R32-3 3 R4 R74-75 R78-79 R88-89 R93 R98
110-081-00	RES CF .25W 5% 22K OHM	22K 5%	R28 R31 R41 R44 R48 R68
110-089-00	RES CF .25W 5% 47K OHM	47K 5%	R9
110-097-00	RES CF .25W 5% 100K OHM	100K 5%	R77
110-121-00	RES CF .25W 5% 1M OHM	1M 5%	R8 R11 R14 R18 R80 R95-97
121-081-00	RES MO 1W 5% 2K2 OHM	2K2 5%	R102-105
122-025-00	RES MO 2W 5% 1 OHM	1 5%	R53 R63
122-037-00	RES MO 2W 5% 3.3 OHM	3.3 5%	R24 R30 R37 R43 R49-50 R59-60
122-075-00	RES MO 2W 5% 1K2 OHM	1K2 5%	R55 R65 R100-101
153-025-00	RES FUS 2W 5% 10 OHM	10 5%	R72-73
200-027-02	PLY .1UF 5% 100V TR	0.1 5%	C11-12 C16-19 C21-22 C26-29 C56-57 C64-66
200-028-02	PLY .01UF 5% 100V TR	0.01 5%	C36-37 C44-45
200-031-02	PLY .022UF 2% 50V TR	0.022 5%	C58-61
200-042-02	PLY/BX .22UF 10%250V TR	0.22	C30 C33 C39 C41
210-002-02	CER 100PF 10% 50V RAD TR	100PF 10%	C6
210-023-02	CER DIP 10PF NPO 100V	10pF	C5
210-024-02	CER DIP 220PF NPO 100V	220pF	C10 C14 C20 C24 C31 C40 C55
210-025-02	CER DIP 680PF NPO 100V	680pF	C2-3
210-026-02	CER DIP 1UF X7R 50V	1UF	C1 C4 C38 C46
220-001-02	LYT 22UF 20% 25V RAD TR	22UF 10%	C34-35 C42-43 C47 C53
220-011-02	LYT 100UF 20% 25V RAD	100UF 10%	C15 C25 C32 C54
220-027-02	LYT 10UF 20% 50V RAD TR	10UF 10%	C7-9 C13 C23
220-056-00	LYT 10000UF 20% 25V 30X25	10,000uF	20% C48-51
220-057-00	LYT 2200UF 20% 100V 35X25	2,200UF	20% C52
300-001-00	DIO SIG 1N4148 100V 500MW	1N4148	D1-4 D7-19 D26-27 D36 D38-39 D6 66
301-001-00	DIO STKY BYV27-200	BYV27	D23 D25 D31 D33
301-032-00	DIO PWR BRDG 8A 600V SIP	8A	D34-35
302-026-00	DIO ZEN 1N4744A 15V 1W	1N4744	D37
302-027-00	DIO ZEN 1N4742A 12V 1W	1N4742	D20 D22 D24 D28 D30 D32
302-028-00	DIO ZEN 1N4743A 13V 1W	1N4743	D21 D29
304-001-00	LED RED T-1	RED	D44
304-004-00	LED GREEN T-1	GRN	D45
310-002-02	XSTR PNP 2N4403 T&R	2N4403	Q1 Q12
310-007-02	XSTR NPN 2N4401 T&R	2N4401	Q2-5 Q11 Q14
310-019-00	XSTR NPN TIP31A	TIP31A	Q13
310-020-00	XSTR PNP TIP32A	TIP32A	Q10
310-059-00	XSTR MOSFET N-CH IRF530	IRF530	Q6 Q8
310-060-00	XSTR MOSFET P-CH IRF9540	IRF9540	Q7 Q9
320-017-00	OPAMP NE5532AN	NE5532AN	U1
325-093-00	LM3886 11P ZIP	LM3886	U3-8
329-070-00	VTL5C8 OPTOCOUPLER	VTL5C8	U2



PART#	DESCRIPTION	VALUE	REFERENCE DESIGNATORS
400-141-00	XLR 3P F VERT A-SERIES		XLR1
400-142-00	XLR 3P M VERT A-SERIES		XLR2
400-243-00	HDR 2P .098X1 SHRD		JP1
400-255-00	SKT HDR 10P .100X2 STR		K2-3
400-256-00	SKT HDR 20P .100X2 STR		K4
400-269-00	TERM QDISC RTA .250 PCMT		J1-24
450-266-00	PCB, MAS1530 MAIN		Z2 (older prototype board)
500-026-00	THERMOSTAT 67F070 PCMNT	67F070	SW1
660-002-00	JUMPER WIRE 24GA T&R		P1-2



Components noted with this symbol shall be replaced only by the component specified. This is required to maintain product safety.

MACKIE SR1530 SERVICE MANUAL

NOTE: This common parts list is for later models. The dual-voltage power transformer was replaced with four different transformers, one for each of the main primary voltages: 100V, 115V, 230V, 240V.

PART#	DESCRIPTION	QUANTITY
21110110	WOOFER L15-64 SR 1530	1
11464001	RE-CONE KIT L15-64 SR 1530	1
21110120	MR 160 SR 1530	1
23020480	PCB ASSY LED	1
23030110	PCB ASSY XOVER	1
23103710	PCB SR 1530 AMPLIFIER 230V	1
23103820	PCB SR 1530 AMPLIFIER 240V	1
23103130	PCB SR 1530 AMPLIFIER 115V	1
23103810	PCB SR 1530 AMPLIFIER 100V	1
82312005	C2A12-25532 -CIRC.INT. NE5532	6
82212024	C2T12-601A400-TRANSISTOR 2N4401	6
82212025	C2T12-601B400-TRANSISTOR 2N4403	2
82232020	C2T32-102B101-TRANSISTOR TIP30	1
82232021	C2T32-102A101-TRANSISTOR TIP29	1
82262017	C2T62-143A101-MOSFET IRF530	2
82262018	C2T62-193B101-MOSFET IRF9540	2
82322010	C2A22-1*3886 -CIRC.INT. LM3886	6
83121006	THERMAL RELAY	1
81751113	SA XFMR 240 V	1
81751111	SA XFMR 115 V	1
81751112	SA XFMR 230 V	1
81751110	SA XFMR 100 V	1
83242013	SWITCH	1
25110160	TWEETER N270 SR 1530	1
15410091	DIAPHRAGM N270 SR 1530	1
33090410	SPKR CABINET	1
33090460	HANDLE CASE	2
33161060	WOOFER GASKET	1
33221510	PROTECTION GRILLE	1
33890190	CABINET FEET	4
33900470	REFLEX	2
23103910	HANDLE ASSY	2
33951530	LBL LOGO SPKR FRONT	1
33951540	LBL ACTIVE BLUE	1
33951980	LBL LOGO SPKR RUNNING MAN	1
83483013	POWER CORD EU	1
83483021	POWER CORD U.K.	1
83483019	POWER CORD USA	1

WOOFER RECONE KIT

PART#	DESCRIPTION	QUANTITY
11464001	RE-CONE KIT L15-64 SR 1530	1

MACKIE®

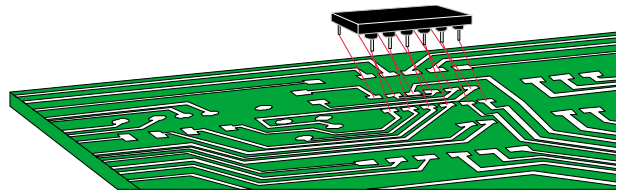

THE MACKIE FIXER • MACKIE DESIGNS SERVICE NEWS

SR1530 active speaker modification

Models affected:

All SR1530 active speakers before serial number: **EA 14008**
Add this as part of your normal repair procedures.

Symptom:

Lack of midrange frequencies, or intermittent midrange

Possible Cause:

Poor connection of the midrange wires to the midrange transducer.

Solution:

Improve the connections to the midrange transducer.

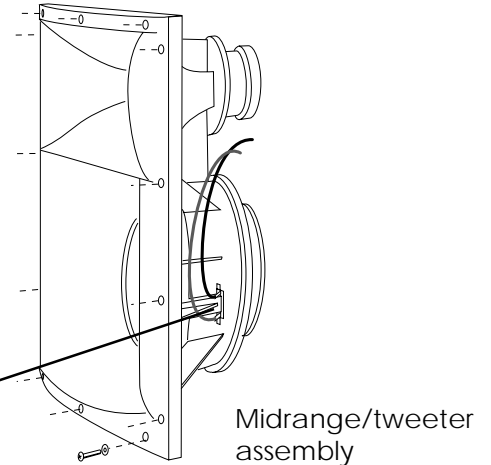

Safety Warning:



Caution! These instructions are for use by qualified personnel only. To avoid electric shock, do not perform any servicing unless you are qualified to do so. Refer all service to qualified personnel.

Tools Required:

Phillips screwdriver, electrical cutters, safety glasses.

Procedure:

1. Remove all cords (including the power cable and input cable) from the speaker.
2. Lay the speaker on its back on a soft carpet or surface.
3. Take off the front grill, taking care to undo the LED wire connector. Undo the 14 screws and washers holding the midrange/tweeter assembly to the front of the cabinet.
4. Lift up the midrange/tweeter assembly and remove the wires from the transducers. Make sure the gasket does not get torn. Place the assembly face down on a soft surface.
5. Bend the tabs on the midrange terminal strip, so they are pointing approximately 45 degrees the terminal board. See diagram 5 below.
6. Remove the plastic housing around the end of each of the midrange wires, see diagram 6.
7. Refit the black and the green wires onto the midrange terminals and make sure they are tight and **fully inserted**. The negative terminal is smaller than the positive. Fit the tweeter wires securely.
8. Check that the gasket is in the correct position, then reassemble the speaker. Check the front grill gaskets (top and bottom) are in the correct position and the LED wires are reconnected.
9. Perform a complete specification and safety test.

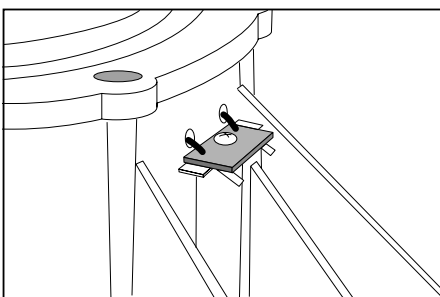

Terminal board of the midrange transducer

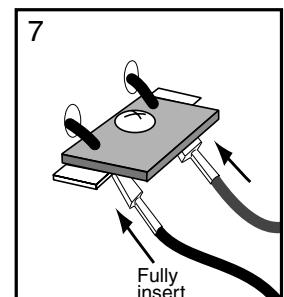
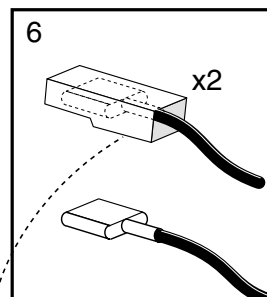
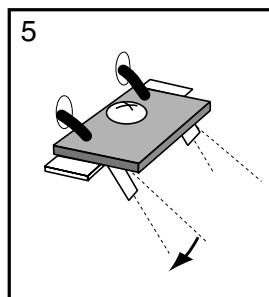

Green (+)
Black (-)

