



OPERATORS MANUAL

Midas
Klark Teknik Building,
Walter Nash Road,
Kidderminster.
Worcestershire.
DY11 7HJ.
England.

Tel:+44 1562 741515
Fax:+44 1562 745371

Email: midas.info@u.telex.com
Website: midasconsoles.com

MIDAS Heritage 4000 Console
Operators Manual DOC02-H4000
Issue 1.1 - February 2004

Due to a policy of continual product improvement, specification
and features may be subject to change without notice.



IMPORTANT SAFETY INSTRUCTIONS



These symbols are internationally accepted symbols that warn of potential hazards with electrical products.



The lightning flash with arrowhead symbol, within an equilateral triangle is intended to alert the user to the presence of uninsulated "dangerous voltage" within the product's enclosure that may be of sufficient magnitude to constitute a risk of electric shock to persons.



The exclamation point within an equilateral triangle is intended to alert the user to the presence of important operating and maintenance (servicing) instructions in the literature accompanying the appliance.

1. Read these instructions.
2. Keep these instructions.
3. Heed all warnings.
4. Follow all instructions.
5. Do not use this apparatus near water.
6. Clean only with a dry cloth.
7. Do not block any of the ventilation openings. Install in accordance with the manufacturers instructions.
8. Do not install near any heat sources such as radiators, heat registers, stoves, or other apparatus (including amplifiers) that produce heat.
9. Do not defeat the safety purpose of the polarized or grounding-type plug. A polarized plug has two blades with one wider than the other. A grounding type plug has two blades and a third grounding prong. The wide blade or the third prong are provided for your safety. If the provided plug does not fit into your outlet, consult an electrician for replacement of the obsolete outlet.
10. Protect the power cord from being walked on or pinched particularly at plugs, convenience receptacles, and the point where they exit from the apparatus.
11. Only use attachments / accessories specified by the manufacturer.
12.  Use only with the cart, stand, tripod, bracket, or table specified by the manufacturer, or sold with the apparatus. When a cart is used, use caution when moving the cart/apparatus combination to avoid injury from tip-over.
13. Unplug this apparatus during lightning storms or when unused for long periods of time.
14. Refer all servicing to qualified personnel. Servicing is required when the apparatus is damaged in any way, such as power-supply cord or plug is damaged, liquid has been spilled or objects have fallen into the apparatus, the apparatus has been exposed to rain or moisture, does not operate normally, or has been dropped.



Klark Teknik Group (UK) Plc, Klark Teknik Building, Walter Nash Road,
Kidderminster. Worcs. DY11 7HJ. England
Tel:+44 1562 741515 Fax:+44 1562 745371
www.midasconsoles.com www.klarktechnik.com

DECLARATION OF CONFORMITY

We, **Klark Teknik Group (UK) Plc**

of, Klark Teknik Building, Walter Nash Road, Kidderminster, Worcestershire, DY11 7HJ.

Declare that a sample of the following product:-

Product Type Number	Product Description	Nominal Voltage (s)	Current	Freq
Heritage 4000	Professional Audio Mixing Desk	115V AC 230V AC	8.0A 4.0A	50/60Hz

to which this declaration refers, is in conformity with the following directives and/or standards:-

Directive(s)	Test Standard(s)
<i>Generic Standard using EN55103 Limits and Methods</i>	<i>EN50081/2</i>
<i>Class B Conduct Emissions</i>	<i>EN55103</i>
<i>Class B Radiated Emissions</i>	<i>EN55103</i>
<i>Fast Transient Bursts</i>	<i>EN61000-4-4</i>
<i>Static Discharge</i>	<i>EN61000-4-2</i>
<i>Basic Electrical Safety</i>	<i>EN60204</i>
<i>LVD</i>	<i>EN60065</i>
<i>Harmonics</i>	<i>EN61000-3-2</i>
<i>Flicker</i>	<i>EN61000-3-3</i>

Signed: 
Name: Simon Harrison

Date: 1st September 2003

Authority: Research and Development Director, Klark Teknik Group (UK) Plc

Attention!

Where applicable, the attention of the specifier, purchaser, installer or user is drawn to special limitations of use which must be observed when these products are taken into service to maintain compliance with the above directives. Details of these special measures and limitations to use are available on request and are available in product manuals.

Thank you for purchasing a Midas Heritage 4000 mixing console. The Heritage 4000 has been developed by listening to the needs of live sound engineers and builds upon the flexibility of the Heritage 3000.

Offering a total of forty (40) aux sends plus stereo masters, the Heritage 4000 is a comprehensive monitor console. With it's flexible assignable buss routing, the Heritage 4000 can be quickly configured making the Heritage 4000 just as comfortable at the Front of House.

As you would expect from Midas, the story does not end there. The Heritage 4000 features Midas XL4 microphone pre-amps and channel equalisation, VCA and mute automation and independent level control over each and all outputs. All backed up, of course, with the standard Midas Three Year Warranty.

Please take the time to fill out the registration card and, to obtain the best results with a minimum of effort, read this operators manual.

Finally, Enjoy your new Midas Heritage 4000 Console!

Contents

Installation & Operation Considerations	Page 3
Wiring Diagrams	Page 3
Mono Input Module	Page 4
Stereo Input Module	Page 10
Auxtender Pod	Page 16
VCA Master Faders	Page 20
Group Output Module	Page 24
Matrix Output Module	Page 28
Master Output Module	Page 30
Monitor Output Module	Page 34
Console Automation	Page 38
Automation and Console Linking Walkthrough	Page 46
MIDI	Page 50
CANBUS	Page 53
Weights and Dimensions	Page 54
Rear Panel	Page 56
Block Diagrams	Page 58
Channel Cribsheet	Page 66
Features and Specifications	Page 68
Overview	Page 69
Technical Specification	Page 70

ATTENTION

The following special limitations must be observed in order to maintain safety and electromagnetic compatibility performance.

Power Connection

The console should only be operated with the power supply connected to ground via the ground in the mains connector.

Control Connections

The console should only be operated with high quality screened control cables. All connector shells should be of metal bodied construction such that the shell provides a screen when connected to the console.

All 'DEE' connector shells should be connected to the cable screen.

All XLR and DIN connectors should have pin one (1) connected to the cable screen.

INSTALLATION

There are a number of points to consider when installing a mixing console, many of these points will have already been addressed even before the console is unpacked, however it is worth repeating them.

Position

The console should be located in a convenient location commensurate with the use to which the console is being put. Ideally a cool area is preferential not too close in proximity to electrical distribution equipment or other sources of interference. Provision should be made for some flat surface surrounding the console to prevent it's use as a table top.

Power

The console's power supply should be located as far away from the console as the connecting cable will allow. It should be set for the voltage supply available in your area and plugged into the mains outlet using the cable provided.



THE POWER SUPPLY SHOULD NEVER BE OPERATED WITH THE MAINS EARTH DISCONNECTED

Please note that the power supply contains LETHAL VOLTAGES greatly in excess of the mains voltage and that it's rails can produce extremely large currents which could burn out equipment and wiring if shorted. All testing and servicing should ONLY be carried out by a qualified engineer.

Connections

To ensure the correct and reliable operation of your Midas Heritage 4000 console, only high quality balanced screened twisted pair audio cable and metal bodied connectors should be used.

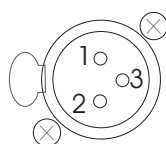

Female XLR

Pin 1 - Screen/Ground
Pin 2 - Hot Signal
Pin 3 - Cold Signal

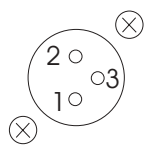

Male XLR

Pin 1 - Screen/Ground
Pin 2 - Hot Signal
Pin 3 - Cold Signal

Note: Sockets are viewed from the front face.

Quarter Inch Jack

Sleeve - Screen/Ground
Ring - Cold Signal
Tip - Hot Signal

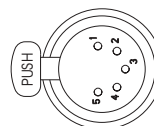

5-Pin Midas Can Bus

Pin 1 - +18V (100mA max.)
Pin 2 - Can Low
Pin 3 - 0V Can
Pin 4 - Can High
Pin 5 - -18V (100mA max.)

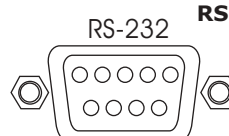

RS-232

Pin 2 - Receive data
Pin 3 - Transmit data
Pin 5 - GND

To ensure compatibility between the console and interconnects, always ensure connectors and cable are of reputable quality.



Mono Input Module

Auxtender Pod

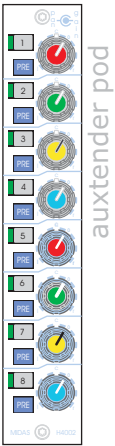

auxtender pod

The auxtender pod provides each input channel strip with an additional 16 mixes (eight stereo auxes) making the total number of 'auxiliary' (aux) outputs for the console forty (40).

Each stereo aux send is enabled by pressing the numbered switch adjacent to the dual-concentric pan/gain potentiometer (pot). When enabled the accompanying LED will light according to the pre/post switch position.

- Green = Stereo Aux send is POST-Fader
- Red = Stereo Aud send if PRE-Fader

The inner ring of the dual-concentric pot provides gain control for the aux send while the outer ring provides the PAN (left-to-right balance) control, allowing the user to position the channel within a stereo image.

Mono Input Module

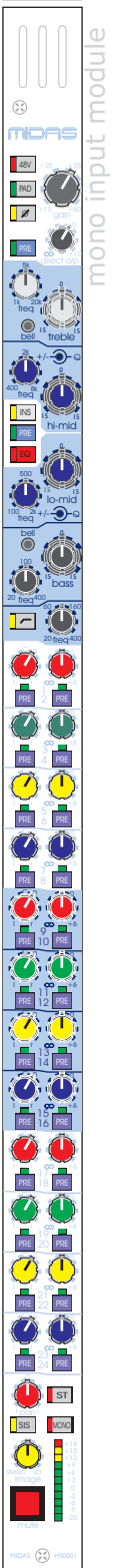

mono input module

Mono Input Channels

INPUTS

- Send
- Return

- Microphone Input
- Direct Output

In the process of describing the mono input channel, controls will be described in order of signal flow .

The Heritage 4000's mono input channels each have a single balanced microphone input, an insert point via two (2) quarter-inch (0.25") TRS jack plugs and a balanced direct output all conventionally wired.

48V - Phantom power is provided to allow the connection of condenser microphones, direct inject boxes and other devices that require +48V phantom power to operate. When depressed the 48V LED will light, indicating that +48V is being applied.

PAD - When enabled, the PAD switch provides 25dB attenuation to the input signal which allows the connection of high output microphones or line-level signals. If the input amplifier is transformer coupled (option), the pad greatly reduces the risk of saturation at very low frequencies. When depressed the pad LED will light, indicating that the pad is enabled.

PHASE (Ø) - The phase switch causes a 180 degree phase change (with respect to the input) in the input amplifier. Hence the input channel signal has inverse phase (with respect to the input). When depressed the phase LED will light, indicating that the phase change is being applied.

PRE - The PRE switch, in this instance, controls the operation of the direct output. When enabled the pre LED is lit to indicate that the direct output signal is derived PRE-Insert and PRE-EQ.

It is worthy of note that in either state, the direct output is PRE-MUTE and hence is unaffected by changes in channel mute.

GAIN - The input gain of the Heritage 4000's input is continuously variable from +15dB to +60dB.

DIRECT O/P - The direct output pot allows the continuous alteration of the direct output level from - inf (minus infinity) to +10dB.

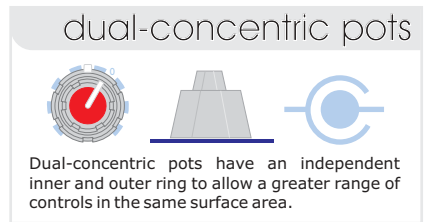

Dual-concentric pots have an independent inner and outer ring to allow a greater range of controls in the same surface area.

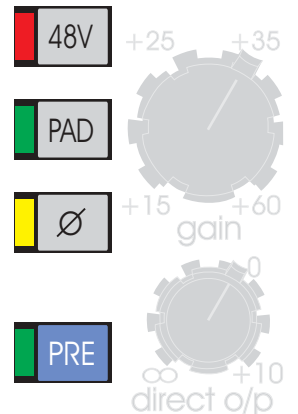
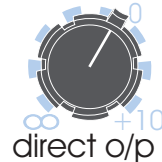
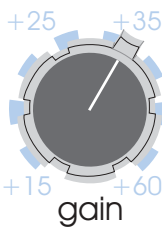

Channel Equalisation

The treble equalisation is selectable fully parametric or high shelving via the bell switch.

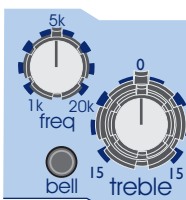

Treble Frequency - Selectable frequency centre. Continuously variable from 1kHz to 20kHz.

Treble Gain - The inner dial on the dual-concentric pot controls the gain of the treble EQ stage and is continuously variable from -15dB to +15dB with a centre detent at 0dB.

Treble Width - The outer dial on the dual concentric pot controls the band width of the treble filter when in fully parametric mode (i.e. when the **bell** switch is depressed) from 0.1 to 2 octaves with a centre detent at 0.5 octaves.

Treble Bell - When depressed, the treble equaliser full parametric mode is enabled. When released, the equaliser Midas shelving mode is enabled.

Mono Input Module



Both the hi-mid and low-mid are fully parametric equalisers.

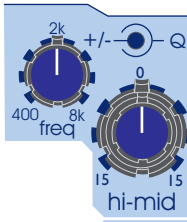

Hi-Mid Freq - Selects the frequency centre of the EQ. Continuously variable from 400Hz to 8kHz (hi-mid) and 100Hz to 2kHz (lo-mid).

Hi/Lo Mid Gain - The inner dial on the dual-concentric pot controls the gain of the EQ stage and is continuously variable from -15dB to +15dB with a centre detent at 0dB.

Hi/Lo Mid Width - The outer dial on the dual concentric pot controls the band width of the eq filter and is continuously variable from 0.1 to 2 octaves with a centre detent at 0.5 octaves.

The bass equalisation is selectable fully parametric or Midas low shelving via the bell switch.

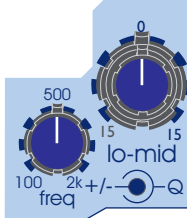

Bass Freq - Selectable frequency centre. Continuously variable from 100Hz to 400Hz.

Bass Gain - The inner dial on the dual-concentric pot controls the gain of the bass EQ stage and is continuously variable from -15dB to +15dB with a centre detent at 0dB.

Bass Width - The outer dial on the dual concentric pot controls the band width of the bass filter when in fully parametric mode from 0.1 to 2 octaves (i.e. when the **bell** switch is depressed) with a centre detent at 0.5 octaves.

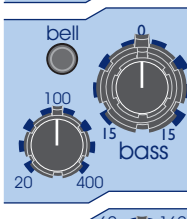

Bell - When depressed, the bass equaliser full parametric mode is enabled. When released, the equaliser Midas shelving mode is enabled.



The input strip equalisation also features a continuously variable high pass filter (HPF) from 20Hz to 400Hz. The HPF switch enables or disables the HPF from the channel strip. The HPF LED indicates whether or not the HPF is operational.

Channel Operation



INS - When enabled, the INS switch enables the insert point of the channel by connecting the channel input return to the channel signal path.



PRE - When enabled, the channel signal passes through the insert point before proceeding to the EQ stage (the insert is pre-EQ). When disabled, the channel signal passes through the insert point after the EQ stage (the insert is post-EQ).

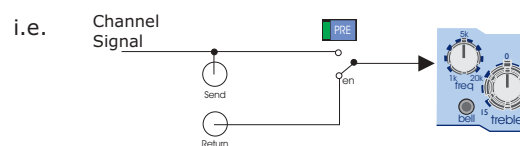

EQ - When depressed, the channels equalisation stages are enabled. When released, the channels equalisation stages.

Signal Routing & busses

The Heritage 4000 has 24 assignable buss outputs which are discussed in more detail later in this manual). Each pair of busses may be assigned:

- Mono Auxillary
- Stereo Auxillary
- Stereo Group

This enables the Heritage 4000 to be used as an FOH, Monitor or FOH & Monitor console depending upon the requirements of the user. Essentially the uses are endless, and offer the maximum flexibility to the engineer.

Mono Input Module



aux tender pod

In MONO AUX mode:

The buss send pot is a dual purpose switching pot:

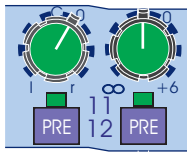

Pressing the pot will enable/disable the buss send for that channel. When depressed, the buss active LED will light to indicate that the buss send is active and also whether the send is pre or post-fader.

When the PRE button is depressed, the buss send is PRE-Fader, otherwise the buss send is POST-Fader. The buss active LED is bi-colour to represent this:

Green = POST-Fade
Red = PRE-Fade

Rotating the buss send pot controls the level sent to the mono aux buss.

In this mode the operation is the same for both odd and even numbered buss sends.

In STEREO AUX mode:

The buss send pot is a dual purpose switching pot:

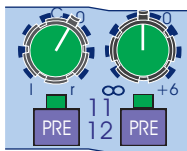

Pressing the even numbered pot will enable/disable the buss send for that channel. When depressed, the buss active LED will light to indicate that the buss send is active and also whether the send is pre or post-fader.

When the PRE button is depressed, the buss send is PRE-Fader, otherwise the buss send is POST-Fader. The buss active LED is bi-colour to represent this:

Green = POST-Fade
Red = PRE-Fade

Rotating the even numbered buss send pot controls the level sent to the stereo aux buss.

In this mode the odd numbered buss send pot acts as the pan control placing the input signal into a stereo (left-to-right) field.

In STEREO GROUP mode:

The buss send pot is a dual purpose switching pot:

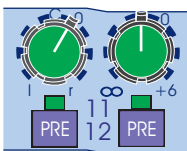

Pressing the even numbered pot will enable/disable the buss send for that channel. When depressed, the buss active LED will light to indicate that the buss send is active.

In this mode, the even and odd buss pots have no other use as group sends are always POST-Fader and POST-Pan. Hence the signal is sent at UNITY GAIN (i.e. 0dB).

Pan and Routing

PAN - The pan control defines the stereo position of the channel in a stereo group or stereo master.

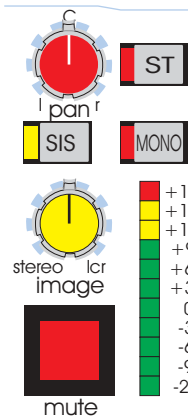

The pan obeys constant law whereby the centre detent positions the channel in the centre of the stereo field with each side at -3dB.

ST - When depressed, the ST switch sends the channel output to the Stereo Master Bus via the Pan Control. The ST LED will light to indicate that the signal has been routed to the stereo master bus.

MONO - When depressed, the MONO switch sends the channel output to the Mono Master Bus. The MONO LED will light to indicate that the signal has been routed to the mono master bus.

SIS - The SIS switch enables the spacial imaging system which operates in conjunction with the pan and image controls. It also acts as a left, centre, right master bus enable overriding any stereo and mono master bus assignments.

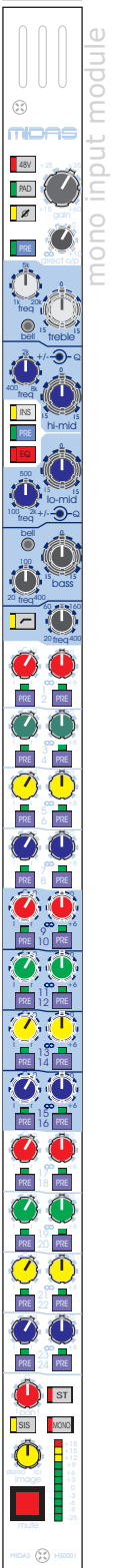

mono input module

Mono Input Module

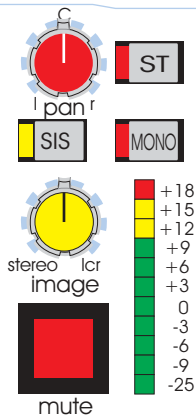
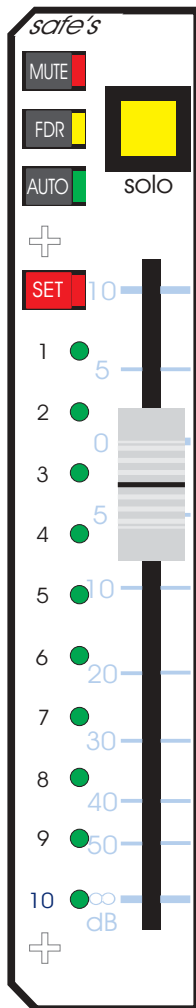

IMAGE - When the spacial imaging system is active the IMAGE control can modify the action of the pan control so as to place the channel within a three speaker system. When the image control is fully clockwise the pan control will operate in full left, centre, right such that a centre panned signal will route to the centre speaker only and will not appear in either of the left or right outputs. When the image control is fully anti-clockwise the pan control reverts to stereo such that a centre panned signal will route at equal power to the left and right speakers. All other Image control positions generate a composite blend of the stereo and LCR panning systems so that the optimum degree of center image focus and speaker power can be obtained. When the image control and pan control are both set central the channel will be routed with equal power to all three speakers. Constant power is maintained at all times so that the image can be adjusted during the show without any perceived level change.

MUTE - The MUTE switch mutes the input channel at all points after the insert send (i.e. all aux, buss sends etc..). The switch can also be controlled from snapshot automation.

LED Signal Meter - The input channel signal can be monitored with the in-line channel meter which is pre-fader and post insert and EQ.

Input Fader



The input fader panel can be used as a conventional channel fader or as part of the automation system.

Safe switches disable any remote control over the channel as selected:

MUTE Safe - The channel mute will not be affected by automute or snapshot automation

FDR Safe - The channel fader will not be affected by virtual fader automation or the VCA master fader (including VCA mutes).

AUTO Safe - The channel will not be affected by snapshot automation. Automutes, VCA masters and assignment systems will remain active.

SET - The set switch is a momentary switch that toggles the VCA and mute assignments for the channel.

In the central console, either mute or VCA operation can be selected. Then using the assign keys, the appropriate VCA or automute can be selected. Pressing the channel set switch for more than half a second will erase the existing VCA or automute assignments and then accept the new ones. A quick press will simply toggle the new settings.

i.e. If the channel is assigned to VCA 1,3 and 4 and the assign keys are then set to 1 and 2 and the channel set button is pressed quickly. The resulting VCA assignment for the channel would be VCA's 2,3 and 4.

When setting mute or VCA assignments, the current assignment will be shown in the ten (10) LED's adjacent to the fader.

SOLO - The SOLO switch sends the input channel signal to the PFL mono and AFL stereo busses. If the switch is pressed for a short time it will latch on or off, but if it is held on for more than 1 second the latching is disabled and when the switch is released the channel solo will turn off. As a default the solo system is auto cancelling so each new solo cancels the last. This function is time dependant which allows several solos to be active as long as they are switched on at approximately the same time. The SOLO ADD MODE switch on the MONITOR module defeats the auto cancelling and allows multiple channel monitoring. In this mode input solos have priority over outputs and will temporarily override any active output solos. The input solos also override any active VCA solos.

The **FADER** function varies according to the virtual fader setting. Normally, the fader gives continuous adjustment of the input channel level from off (-inf) to +10dB.

In Virtual fader mode, the 'real' fader is used to trim the 'virtual' fader shown on the fader LEDs. When taken to 0dB the fader trims the virtual fader level (i.e. at 0dB the channel level is that of the virtual fader snapshot memory but can be trimmed to +10dB or down to -inf).

In addition to showing VCA and mute assignments, the ten (10) LED's adjacent to the channel fader perform a number of different operations depending upon the settings on the central console.

Input Fader

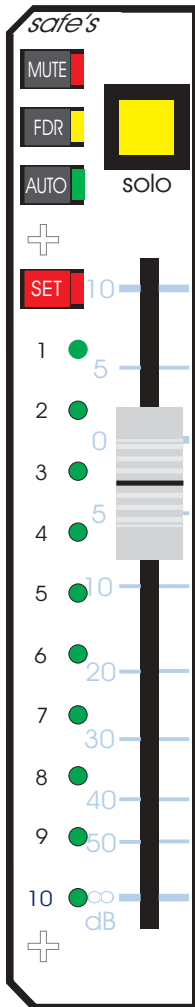

FADER MANUAL RECALL AND NULL

In this mode, the STATUS LEDs are used to prompt the operator where to move the fader. If the fader is not at the position stored in the current recalled snap shot, one/two LEDs will flash to indicate where the fader should be. A single flashing LED indicates that the fader should be positioned next to that LED, if two LEDs are flashing the fader should be between the two LEDs. As the fader is moved closer to the required position the LED(s) will stop flashing and will be replaced by a single continuously lit LED. Once the fader is at the correct position all LEDs will extinguish.

FADER POSITION CHECK

When a scene's contents are being "checked" (see automation operation) the STATUS LEDs will indicate the fader position stored in the scene by continuously illuminating one or two LEDs as appropriate.

VIRTUAL FADER RECALL

When in VIRTUAL FADER mode (see automation operation) the automation system will generate a "virtual" fader, set to the level of the input fader at the time the snap shot was stored. The level of the virtual fader is added to the level of the physical input fader. In this mode the STATUS LEDs indicate the "position" of the virtual fader by illuminating a bar of LEDs starting at off (-inf).



Stereo Input Module

Auxtender Pod

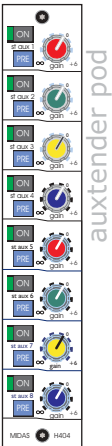

auxtender pod

The auxtender pod provides each input channel strip with an additional 16 mixes (eight stereo auxes) making the total number of 'auxiliary' (aux) outputs for the console forty (40).

Each stereo aux send is enabled by pressing the numbered switch adjacent to the gain potentiometer (pot). When enabled the accompanying LED will light according to the pre/post switch position.

- Green = Stereo Aux send is POST-Fader
- Red = Stereo Aud send if PRE-Fader

The gain pot is continuously variable from off (-inf) to + 6dB.

Stereo Input Module

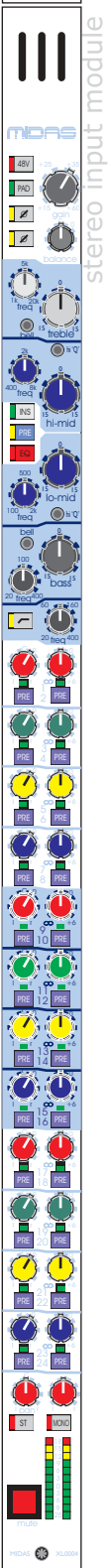

stereo input module

INPUTS

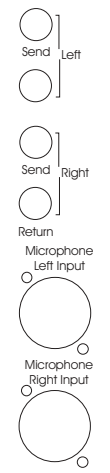

Stereo Input Channels

In the process of describing the stereo input channel, controls will be described in order of signal flow.

The Heritage 4000's stereo input channels each have two (2) balanced microphone inputs and one insert point per input (i.e. two inserts per channel) on conventionally wired TRS quarter-inch (0.25") jack plugs.

The insert points are balanced and hence two TRS quarter inch jacks provide the send and return for each insert.

Note that stereo channels do not carry a direct output.

For clarity, both the inputs and inserts are labelled *left* and *right*.

48V - Phantom power is provided to allow the connection of condenser microphones, direct inject boxes or other devices requiring +48V Phantom power to operate. When depressed, the 48V LED will light, indicating that phantom power is being applied. NOTE: On stereo modules, +48V phantom is applied to both left and right inputs.

PAD - Pad provides 25dB of attenuation to both input signals to allow the connection of high output microphones or line-level signals. If the input signal is transformer coupled (option), the use of the pad greatly reduces the risk of saturation at very low frequencies. The pad LED will light when 25dB of attenuation is being applied.

PHASE Ø - The phase switches cause a 180 degree phase change (with respect to the input) to occur in the input amplifier. The upper switch acts upon the left input whereas the lower switch acts upon the right input allowing separate phase alteration between inputs.

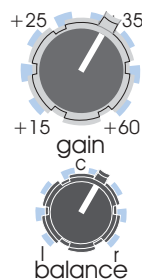
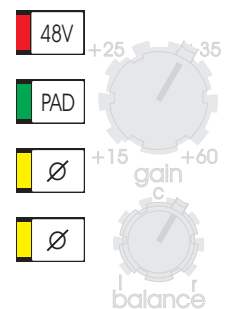

GAIN - The input gain for both input amplifiers is continuously variable from +15dB to +60dB.

Balance - The balance pot is available on stereo input modules only and allows for the reciprocal adjustment of the stereo left and right signals by +10dB to -10dB. This allows the fine adjustment of the left and right signal levels.

Channel Equalisation

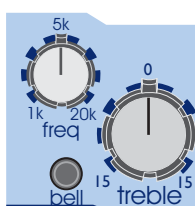

The treble equalisation is selectable 1.5 octave peaking (bell) or Midas shelving via the bell switch.

Freq - The frequency centre of the EQ is continuously variable from 1kHz to 20kHz.

Treble - Controls the gain of this EQ stage and is continuously variable from -15dB to +15dB with a centre detent at 0dB.

Bell - The bell switch selects between classic Midas Shelving EQ (bell switch OUT) and 1.5 octave bandwidth Bell EQ (bell switch IN).

Stereo Input Module



auxtender pod

stereo input module

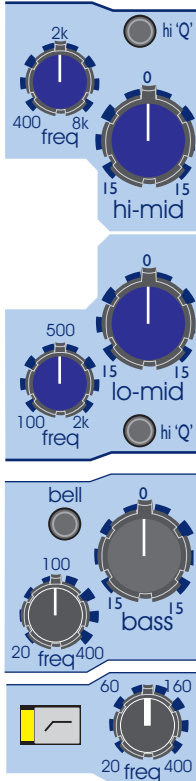

Both the lo-mid and hi-mid sections are selectable 1.5 or 0.5 octave equalisers.

Freq - The frequency centre of the EQ is continuously variable from 400Hz to 8kHz (hi-mid) and 100Hz to 2kHz (lo-mid).

lo/hi-mid - Controls the gain of this EQ stage and is continuously variable from -15dB to +15dB with a centre detent at 0dB.

hi 'Q' - When depressed the bandwidth of the EQ section is set to 0.5 octaves or Hi 'Q'. Otherwise the bandwidth of the EQ is set to 1.5 octaves

The bass equalisation is selectable 1.5 octave or Midas shelving via the bell switch.

Freq - The frequency centre of the EQ is continuously variable from 20Hz to 400Hz.

Bass - Controls the gain of this EQ stage and is continuously variable from -15dB to +15dB with a centre detent at 0dB.

Bell - The bell switch selects between classic Midas Shelving EQ (bell switch OUT) and 1.5 octave bandwidth Bell EQ (bell switch IN).

Freq - The High Pass filter frequency is continuously variable from 20Hz to 400Hz and is enabled by pressing the HPF switch in. The HPF LED indicates the status of the HPF.

Channel Operation



INS - When depressed, the insert point of the channel is engaged and the input return is connected to the channel signal path.



PRE - When the pre switch is depressed the insert is selected PRE-EQ, otherwise the insert is selected POST-EQ (i.e. the signal passes through the EQ before the insert point).



EQ - The EQ switch enables the channel equalisation (including HPF) when depressed or bypasses the channel equalisation when released.

Signal Routing and Busses

The Heritage 4000 has, in addition to the 8 stereo auxes, 24 assignable buss outputs which are discussed in more detail later in this manual. Each pair of busses may be assigned:

- Mono Auxiliary
- Stereo Auxiliary
- Stereo Group

This enables the Heritage 4000 to be used as an FOH, Monitor or FOH & Monitor console depending upon the requirements of the user. The control over the assignable buss sends will change according to the status of the buss output modules.

In MONO AUX mode:

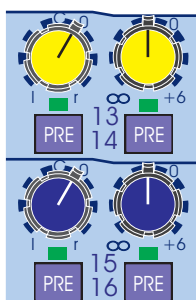

The buss send pot is a dual function switching pot. Pressing the odd or even numbered pot will enable the buss send. When enabled, the buss send LED will light according to the setting of the PRE switch. With the PRE switch depressed, the signal will be sent PRE-Fader to the buss, otherwise the signal will be sent POST-Fader to the buss and the bi-colour LED will represent this:-

- GREEN - Buss send enabled and POST-Fader
- RED - Buss send enabled and PRE-Fader
- NONE - Buss send disabled

The odd and even numbered buss sends control the level of signal sent to the buss. The buss send is continuously variable from off (-inf) to +6dB.

NOTE: When in mono aux mode, a mono sum of the left and right inputs are sent to the buss.

Stereo Input Module

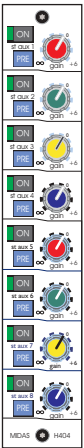

aux tender pod

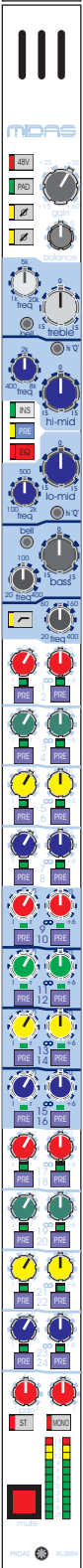

stereo input module

In STEREO AUX mode:

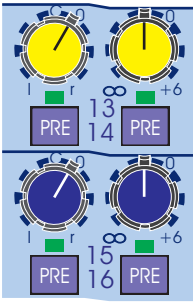

The buss send pot is a dual function switching pot. Pressing the odd or even numbered pot will enable the buss send

When enabled, the buss send LED will light according to the setting of the PRE switch. With the PRE switch depressed, the signal will be sent PRE-Fader to the buss, otherwise the signal will be sent POST-Fader to the buss and the bi-colour LED will represent this:-

- GREEN - Buss send enabled and POST-Fader
- RED - Buss send enabled and PRE-Fader
- NONE - Buss send disabled

The odd and even numbered buss sends control the level of signal sent to the buss. The buss send is continuously variable from off (-inf) to +6dB.

NOTE: When in stereo aux mode the odd numbered buss send pot sends the left input and the even numbered buss send pot send the right input.

In STEREO GROUP mode:

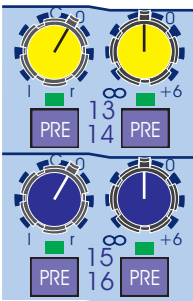

The buss send pot is a dual function switching pot. Pressing the odd or even numbered pot will enable the buss send.

In stereo group mode the left input is sent to the odd numbered buss and the right input sent to the even numbered buss. The signal is always send POST-Fader and POST-Pan at unity gain. Hence the buss send pots have no other function.

Pan and Routing

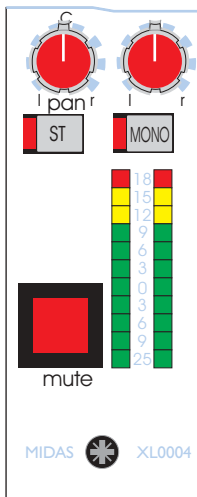

PAN - The stereo input channel has two pan controls, one for each input. Hence each input can be placed anywhere in the stereo image. As well as placement, the pan controls can be used to adjust the image width from full stereo to mono through to reverse stereo (left and right crossed over).

Both pan controls have a constant power law (i.e. -3dB at the centre detent).

ST - Connects the post fader channel signal to the master stereo buss via the pan controls.

MONO - Connects a mono sum of the post fader channel signal to the master mono buss

MUTE - The mute switch mutes the input channel at all points after the insert send. The mute switch can also be controlled by the snapshot automation system.

METERS - The meters show the peak pre-fader, post-EQ and insert input signal level of the input channel.

Stereo Input Module

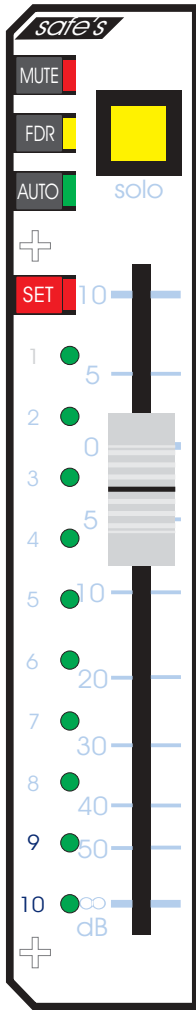

The input fader panel can be used as a conventional channel fader or as part of the automation system.

Safe switches disable any remote control over the channel as selected:

MUTE Safe - The channel mute will not be affected by automute or snapshot automation

FDR Safe - The channel fader will not be affected by virtual fader automation or the VCA master fader (including VCA mutes).

AUTO Safe - The channel will not be affected by snapshot automation. Automutes, VCA masters and assignment systems will remain active.

SET - The set switch is a momentary switch that toggles the VCA and mute assignments for the channel.

In the central console, either mute or VCA operation can be selected. Then using the assign keys, the appropriate VCA or automute can be selected. Pressing the channel set switch for more than half a second will erase the existing VCA or automute assignments and then accept the new ones. A quick press will simply toggle the new settings.

i.e. If the channel is assigned to VCA 1,3 and 4 and the assign keys are then set to 1 and 2 and the channel set button is pressed quickly. The resulting VCA assignment for the channel would be VCA's 2,3 and 4.

When setting mute or VCA assignments, the current assignment will be shown in the ten (10) LED's adjacent to the fader.

SOLO - The SOLO switch sends the input channel signal to the PFL mono and AFL stereo busses. If the switch is pressed for a short time it will latch on or off, but if it is held on for more than 1 second the latching is disabled and when the switch is released the channel solo will turn off. As a default the solo system is auto cancelling so each new solo cancels the last. This function is time dependant which allows several solos to be active as long as they are switched on at approximately the same time. The SOLO ADD MODE switch on the MONITOR module defeats the auto cancelling and allows multiple channel monitoring. In this mode input solos have priority over outputs and will temporarily override any active output solos. The input solos also override any active VCA solos.

The **FADER** function varies according to the virtual fader setting. Normally, the fader gives continuous adjustment of the input channel level from off (-inf) to +10dB.

In Virtual fader mode, the 'real' fader is used to trim the 'virtual' fader shown on the fader LEDs. When taken to 0dB the fader trims the virtual fader level (i.e. at 0dB the channel level is that of the virtual fader snapshot memory but can be trimmed to +10dB or down to -inf).

In addition to showing VCA and mute assignments, the ten (10) LED's adjacent to the channel fader perform a number of different operations depending upon the settings on the central console.

FADER MANUAL RECALL AND NULL

In this mode, the STATUS LEDs are used to prompt the operator where to move the fader. If the fader is not at the position stored in the current recalled snap shot, one/two LEDs will flash to indicate where the fader should be. A single flashing LED indicates that the fader should be positioned next to that LED, if two LEDs are flashing the fader should be between the two LEDs. As the fader is moved closer to the required position the LED(s) will stop flashing and will be replaced by a single continuously lit LED. Once the fader is at the correct position all LEDs will extinguish.

FADER POSITION CHECK

When a scene's contents are being "checked" (see automation operation) the STATUS LEDs will indicate the fader position stored in the scene by continuously illuminating one or two LEDs as appropriate.

VIRTUAL FADER RECALL

When in VIRTUAL FADER mode (see automation operation) the automation system will generate a "virtual" fader, set to the level of the input fader at the time the snap shot was stored. The level of the virtual fader is added to the level of the physical input fader. In this mode the STATUS LEDs indicate the "position" of the virtual fader by illuminating a bar of LEDs starting at off (-inf).



Auxtender Pod

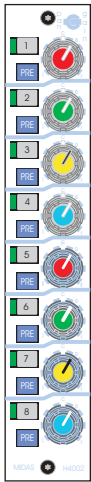

mono pod module

Mono Pod Module

The mono input pod is connected to the mono channel strips on the main Heritage 4000 console internally, hence there are no connections directly to it on the rear of the pod.

The mono pod module allows the routing of signal to the 8 stereo auxes (outputs on the rear of the auxtender pod).

Each stereo aux send is enabled by depressing the switch adjacent to the dual-concentric pan/gain potentiometer. When enabled, the accompanying LED will illuminate according to the pre/post switch.

The pre/post switch determines whether the signal is sent PRE or POST Fader. This is displayed on the LED as:-

- GREEN - Aux send is enabled and POST-Fader
- RED - Aux send if enabled and PRE-Fader

The inner ring of the dual-concentric pot provides gain control for the aux send while the outer ring provides the PAN (left-to-right balance) control allowing the user to position the channel within the stereo aux image.

NOTE: Unlike the Heritage 4000's 24 assignable buss outputs, the stereo auxiliaries are always auxes.

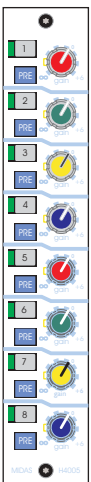

stereo pod module

Stereo Pod Module

The stereo input pod is connected to the stereo channel strips on the main Heritage 4000 console internally, hence there are no connections directly to it on the rear of the pod.

The stereo pod module allows the routing of signal to the 8 stereo auxes (outputs on the rear of the auxtender pod).

Each stereo aux send is enabled by depressing the switch adjacent to the dual-concentric pan/gain potentiometer. When enabled, the accompanying LED will illuminate according to the pre/post switch.

The pre/post switch determines whether the signal is sent PRE or POST Fader. This is displayed on the LED as:-

- GREEN - Aux send is enabled and POST-Fader
- RED - Aux send if enabled and PRE-Fader

The pot provides gain control for the aux send which is continuously variable from off (-inf) to +6dB.

NOTE: Unlike the Heritage 4000's 24 assignable buss outputs, the stereo auxiliaries are always auxes.



optics module

Optics Module

On the Heritage 4000 the control for the optics system has been moved to the auxtender pod.

The optics system is controlled from the front panel on the auxtender pod.

Brightness - Brightness of the desk lamps (XLR Sockets on the rear of the console aux-extender pod).

ON - Turns the XLR lamps on (depressed) or off (released).

LED Brightness - The brightness of the LEDs in the console surface (with the exception of the major function LEDs) can be controlled.

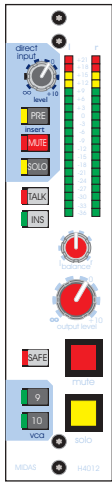

pod output module

Output Module

- Meters** - The 20 LED meters provide peak level metering of the stereo aux output of the desk.
- Direct Input** - The level of the direct inputs (Left and Right) sent to the output is continuously variable from off (-inf) to +10dB.
- Pre (insert)** - When depressed the direct input signals are connected to the output channel PRE-Insert, otherwise the direct input signals are connected to the output channel POST-Insert.
- Mute (insert)** - The direct input signals are muted when the mute switch is depressed.
- Solo (insert)** - The direct input signals are sent to the main Stereo AFL buss and to the main Mono PFL buss.
- TALK** - The console talk buss is sent to the stereo aux output.
- INS** - When depressed, the stereo aux insert points (on the rear of the aux-extender pod) are engaged into the aux output signal path. Otherwise the insert points are disabled.
- Balance** - Sets the stereo balance for the output.
- Output Level** - The stereo aux output level is continuously variable from off (-inf) to +10dB
- Safe** - When enabled, the stereo aux mute is removed from the automation system.
- Mute** - Mutes the output of the stereo aux. This can also be controlled by the mute snapshot system.
- Solo** - Routes the stereo aux signal to the Stereo AFL and mono PFL busses.
- VCA 9/10** - Enables the stereo aux to be controlled by VCA groups 9 and/or 10 including VCA mutes.

Auxtender Pod Rear

<p>left right</p>	<p>send</p> <p>insert</p> <p>return</p>	<p>Connections to the auxtender pod can be found on the rear in the centre. Channel connections (i.e. stereo aux sends for each channel) are connected internally so there is no need to make further connections.</p>
	<p>direct in left</p> <p>direct in right</p>	<p>The auxtender pod adds two (2) insert points (left and right), two (2) direct inputs (left and right) and two (2) outputs (left and right) per stereo auxiliary.</p> <p>Insert</p> <p>The balanced insert points are connected by two (2) quarter inch (0.25") TRS jack plugs conventionally wired. One send and one return for both left and right per stereo aux.</p>
	<p>direct in left</p> <p>direct in right</p>	<p>Direct In</p> <p>Two (2) balanced line-level direct inputs are provided (one left, one right) for each stereo aux.</p>
	<p>output left</p> <p>output right</p>	<p>Output</p> <p>Output from the consoles stereo auxes are provided on the rear of the auxtender pod by two balanced XLR plugs conventionally wired (one left one right).</p>

Connections

To ensure the correct and reliable operation of your Midas Heritage 4000 console, only high quality balanced screened twisted pair audio cable and metal bodied connectors should be used.

The following diagrams are included as a guide for audio connections only, wiring for specialist cables or connections may vary.

XLR

- Pin 1 - Screen/Ground
- Pin 2 - Hot Signal
- Pin 3 - Cold Signal

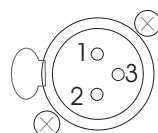

Quarter Inch Jack

- Sleeve - Screen/Ground
- Ring - Cold Signal
- Tip - Hot Signal



To ensure compatibility between the console and interconnects, always ensure connectors and cable are of reputable quality.

Note: Sockets are viewed from the front face.



VCA Master Fader

VCA Master Fader

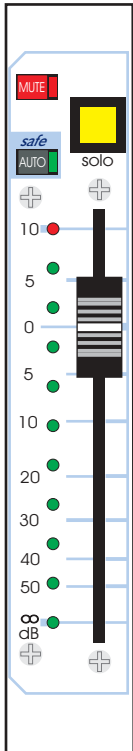
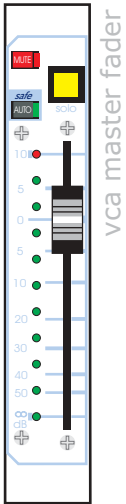

The VCA Master Fader panel contains ten (10) long-throw assignable VCA Faders. The Heritage 4000's input channels may be assigned to any of the ten VCA's. The Auxtender and Assignable Buss Outs may be assigned to VCA's 9 and 10 only.

MUTE - The VCA mute switch acts on any post fader input channel or sub-group that is assigned to be controlled from the corresponding VCA master.

The mute can also be controlled by the snapshot automation system.

AUTO (Safe) - When depressed, the VCA is removed from snapshot automation control over the VCA fader and VCA mutes.

VCA Solo - The VCA solo switches are used to monitor the VCA faders by creating a mix of all the inputs and sub-groups assigned to that VCA fader and routing the signal to the solo busses.

If the VCA solo is pressed in briefly, the solo will latch on or off. If the solo is pressed in for more than one second then the latch is cancelled and the solo will be cancelled as soon as the switch is released.

When the console is in solo ADD mode, input channels take priority over VCA fader solos.

Fader - The fader adjusts the effective output level provided by the VCA continuously from off (-inf) to +10dB.

Status LEDs

The eleven (11) LEDs adjacent to the fader have a number of purposes depending upon the mode of the automation system:

When in VCA or Mute Assignment Mode - All the status LEDs are off.

Fader Manual Recall and NULL

In this mode, the status LEDs are used to prompt the operator where to move the fader. When the fader is not at the position stored in the current snapshot one or two LEDs will flash to indicate it's preset position. A single flashing LED indicates that the fader should be brought to this position. Two flashing LEDs indicate that the fader should be positioned between the two. As the fader is moved towards the desired position the LED will light continuously. Once the fader is in the correct position all LEDs will be extinguished.

Fader Position Check

When a scene's contents are being checked (see the automation section) the status LEDs will indicate the fader position by illuminating one or two LEDs as described above.

Virtual Fader Recall

When in virtual fader mode (see the automation section), the automation system generated a 'virtual' fader, set to the level of the fader at the time the snapshot was stored. The status LEDs will display the level of the fader by illuminating all the LEDs from -inf to the position of the 'virtual' faderA

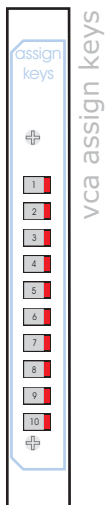

VCA Assign Keys

The VCA and automute assignments are made using the assign keys.





The automation system must be unlocked and the correct assign mode selected (VCA or Mute). See the automation section in this manual for more information.

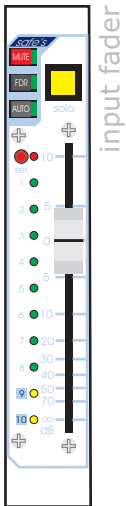

To add a mute or VCA assignment, the desired assign keys should be selected. Normally pressing an assign key will deselect the previous one. Should more than one key be desired, a long press of the desired key will select the additional key without cancelling the previous selection.

To complete the assignment, select the channel to be assigned to the VCA or automute (see below).



 To assign a channel to a VCA fader or the automute system, the automation system must be unlocked and the correct assign mode selected (VCA or Mute).

set Select the desired automute or VCA using the assign keys (see above) and press the channel SET key.

The channel SET key can be used in two ways:

Long Press - A long press will erase the previous VCA or automute settings for the channel and take the new setting given by the assign keys.

Short Press - A short press will not erase the previous VCA or automute settings for the channel. Instead, the selected assign keys will toggle the assigns for the channel.

EG: Steps:

VCA 1,2,3 and 4 are already assigned to a channel
VCA 2 and 5 are selected on the assign keys
The channel select key is [short] pressed

Result:

The channel will now be additionally assigned to VCA 5
The channel's assignment to VCA 2 will be toggled

i.e. The channel will now have VCA assignments to 1,3,4 and 5.



Group Output Module

Group Outputs

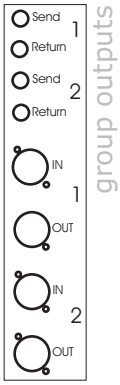

group outputs

The Heritage 4000's assignable buss (group) outputs are located together on the rear of the console main body. Pairs of group outputs and their corresponding insert points and direct input are located together

The group insert point is provided by two balanced TRS quarter-inch jack sockets, one send and one return per output. The top insert point on the console will insert into the odd numbered output while the lower insert point will insert into the even numbered output.

The output from the group is provided by a balanced male XLR socket. Again the top socket is used for the odd numbered output while the lower socket is used for the even number output.

The direct input is connected to the group by a single balanced female XLR socket. Again the top socket is used for the odd numbered group output while the lower socket is used for the even numbered group output.

In total the Heritage 4000 has 24 group outputs, direct inputs and group inserts.

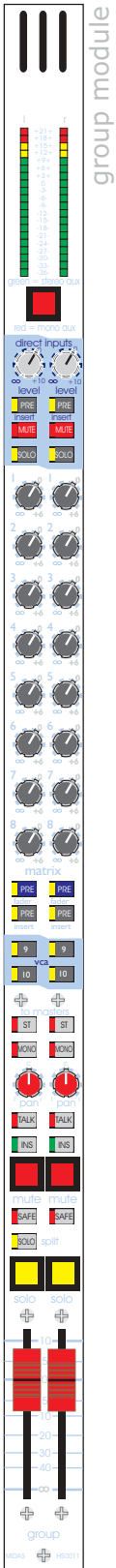

group module

Group Module

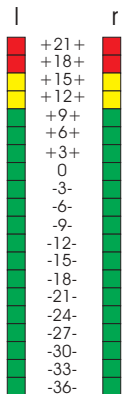

The group module controls the signals sent to the assignable buss from the input channels.

LED Bargraph Meter - The LED bargraph meter shows the peak POST-Fader group output.

Buss Mode Select - An important feature of the Heritage 4000 is the flexible buss routing. This is achieved by using the buss mode select switch at the top of the group module strip.

The configuration of the buss is set by pressing the switch which will cycle the buss mode through three possible options:

- green = stereo aux **Green** - Stereo Aux
- red = mono aux **Red** - Mono Aux
- Off** - Sub-group Output



red = mono aux

The console will cycle through these three options indefinitely each time the switch is pressed. This allows the console to be reconfigured quickly and with ease.

Group Direct Inputs

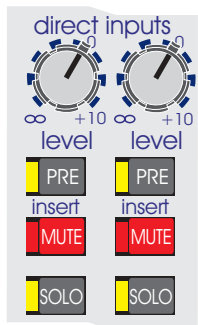

Level - The direct input level is continuously variable from off (-inf) to +10dB. The direct input signal is summed with the group signal allowing for effects returns or the combination of a number of consoles. A direct input is provided for both the odd and even numbered group.

Pre (insert) - When depressed, the direct input is applied to the group signal pre-insert. Otherwise, the direct signal is applied post-insert.

Mute - When depressed, the direct input signal is muted from the group at all points.

Solo - When depressed, the direct input signal is sent to the mono PFL and stereo AFL master busses. The behaviour of the solo switch follows the solo behaviour of the rest of the console. If in solo ADD mode, all input channels will take priority over this solo.

MATRIX Sends

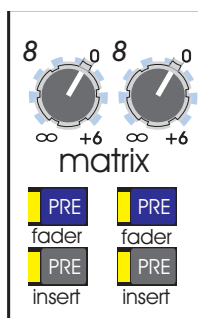

The H4000 has 8 mono matrix outputs. 8 matrix output sends are provided on each group module for both the odd and even numbered outputs. The matrix send level is continuously variable from off (-inf) to +6dB.

Pre (fader) - When enabled, the matrix sends are sourced from the group signal PRE-fader. Otherwise, the signal is sent from the group module POST the group output fader.

Pre (insert) - When enabled, the matrix sends are sourced from the group signal before it is applied to the insert point (pre-insert). Otherwise, the signal is sourced after the insert return (post-insert).

Group Module

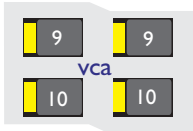
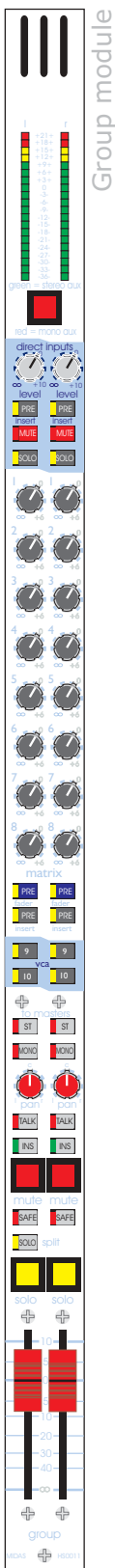
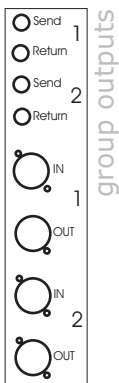

VCA Assign - Each of the groups may be assigned to either VCA 9 or VCA 10 control.

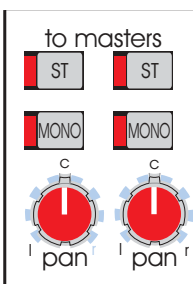

To Masters

ST - When depressed, the ST switch causes the group output to be routed to the master stereo buss.

Mono - When depressed, the MONO switch causes the group output to be routed to the master mono buss.

PAN - When sent to the master stereo buss, the PAN control places the group signal within the stereo image. The PAN pot has a constant power law (i.e. -3dB at the centre detent).

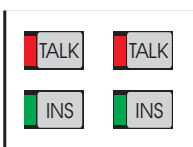

Talk - When depressed, signal from the monitor module (i.e. oscillator or microphone) are routed into the group signal.

INS - When depressed, the insert point of the channel is enabled and the group insert return is connected to the group signal path.

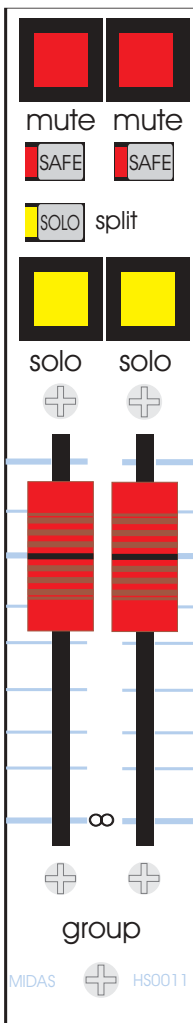

MUTE - When depressed, the mute for the group output is toggled. When lit, the group signal is muted at every point after the group insert send. This mute is also controllable from the snapshot automation system.

Safe - When depressed, the group mute is removed from the snapshot automation system control.

Solo (Split) - When placed in solo split mode, the AFL solos are changed from mono to stereo.

SOLO - The solo switch sends the group to the stereo AFL and the mono PFL buss and obeys the console's standard solo behaviour. Buss outputs take lower priority than input channels when the console is in solo ADD mode.

Fader - The group output level is continuously variable from off (-inf) to +10dB for each output.



Matrix Module

Matrix Connections

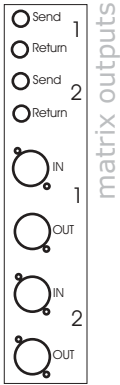

matrix outputs

The Heritage 4000's matrix outputs are located together on the rear of the console main body. Pairs of matrix outputs and their corresponding insert points and direct input are located together

The matrix insert point is provided by two balanced TRS quarter-inch jack sockets, one send and one return per output. The top insert point on the console will insert into the odd numbered output while the lower insert point will insert into the even numbered output.

The output from the matrix is provided by a balanced male XLR socket. Again the top socket is used for the odd numbered output while the lower socket is used for the even number output.

The direct input is connected to the matrix by a single balanced female XLR socket. The matrix direct inputs do not have level control and are connected to the matrix buss at unity. The intention being that matrix direct inputs should be used for console linking or similar operation.

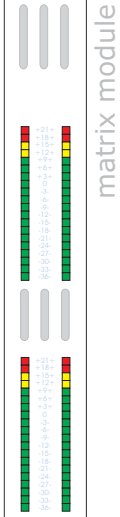

matrix module

The HS0041 matrix module provides control for four (4) matrix outputs per module. Two modules are required per console.

For this reason, the upper and lower parts of the matrix module are duplicated to allow control over all four matrix outputs per module. Ergo, we will consider only one pair of meters and controls per module.

Matrix Module

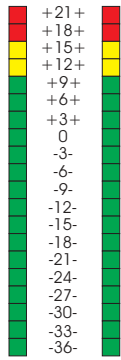

Meters - The LED bargraph meter monitors the peak (post-fader) output level from the matrix.

VCA - When depressed, the matrix output is assigned to VCA control from the master fader so that the matrix output tracks changes in the master output.

Talk - When depressed, the matrix output is connected to the monitor module talk buss so that the talk mic, generator or external talk input may be routed to the matrix.

INS - When depressed, the matrix insert is enabled and the insert return is routed to the matrix signal path.

Mute - The matrix mute switch toggles the matrix mute. When lit, the matrix is muted at all points after the insert send. This mute switch can be controlled by the snapshot automation system.

Safe - The safe switch removes the matrix mute from automation system control.

Solo (split) - The solo split switch changes the matrix AFL solos from mono to stereo.

Solo - The matrix solo switch sends the matrix signal to the AFL stereo and PFL mono busses and obeys the normal console solo behaviour. In solo add mode, input channels will take priority over matrix solos.

Fader - The matrix fader allows the continuous adjustment of the matrix output levels from off (-inf) to +10dB.

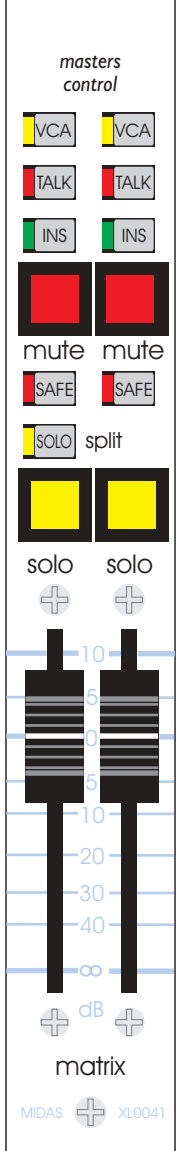



Master Output Module

Master Outputs



The Heritage 4000 main outputs are located on the rear of the console. Six (6) male XLR sockets conventionally wired are provided - two (2) each for Left, Right and Mono (centre).

Six (6) balanced TRS quarter-inch jack sockets provide the send and return sockets for the master output inserts (two (2) for each Left, Right and Mono).

Master Module

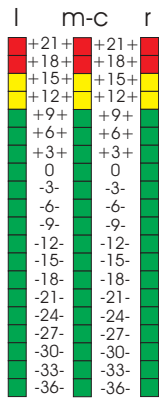
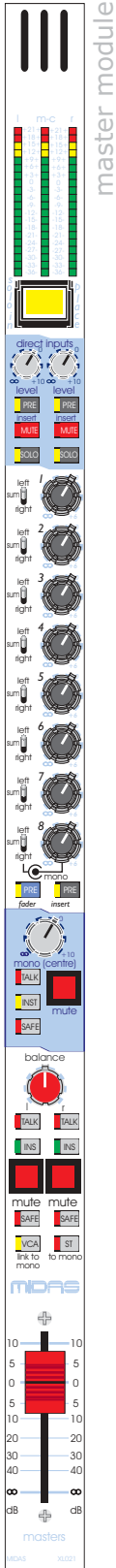

Meter - The output LED bargraph meters monitor the peak master stereo output level (post-fader)



Solo In Place - The solo in place switch sets the console to be in Solo In Place mode. In this mode, when a solo is made on the console all other channels are muted. Individual channels can be protected from this by enabling their channel mute safes.

Direct Inputs

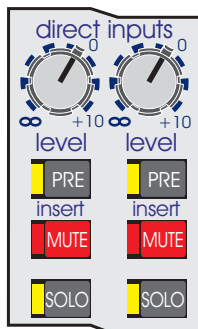

Direct Input - The direct input level is continuously variable from off (-inf) to +10dB. The left and right direct inputs are summed into the left and right master signals (respectively) and can be used for effects returns, console linking, etc... The master mono also has a direct input which is intended for console linking only.

Pre (insert) - When depressed, the direct input is combined with the main signal before the insert points. Otherwise, the direct input is combined with the main signal after the insert point return.

Mute - When depressed, the direct input is muted from the master channel at all points.

Solo - When pressed, the direct input is sent to the stereo AFL and the mono PFL busses and obeys the console's standard solo behaviour. When the console is in solo ADD mode, input channels take priority over this solo.

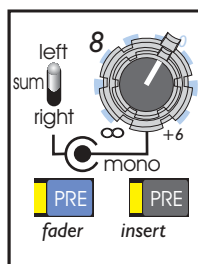

Matrix Send - Each of the H4000's eight mono matrix busses can be sent from the master stereo and mono channels. The inner ring of the dual-concentric pot sends from the master mono and is continuously variable from off (-inf) to +6dB.

The outer ring of the dual-concentric pot outputs either from the left channel, right channel or as a mono sum of the left and right channels (switch selectable). The amount sent to the matrix is then continuously variable from off (-inf) to +6dB.

Pre (fader) - When depressed, signal is routed to the matrix before the main fader. Otherwise the signal is routed POST-fader.

Pre (insert) - When depressed, signal is routed to the matrix before the main insert points. Otherwise, the signal is routed to the POST-insert.

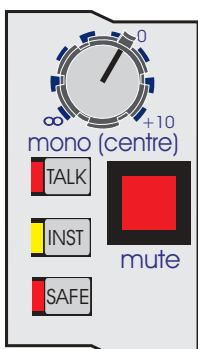

Mono Level - The level sent to the mono (centre) output is continuously variable from off (-inf) to +10dB.

Talk - The mono talk switch connects the mono output to the monitor module so that the internal talk or oscillator may be routed to the mono output (see the monitor module section later in this manual).

INST - When depressed, the INST switch connects the mono insert point into the mono master signal path.

Safe - When depressed, the mono channel is removed from the mute snapshot automation.

Mute - The mono mute switch toggles the mono mute. When lit, the mono signal is muted at all points after the mono insert send. This switch can be controlled by the snapshot automation system.

Master Module

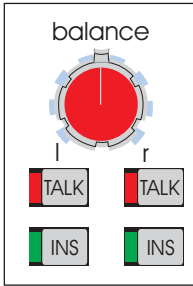
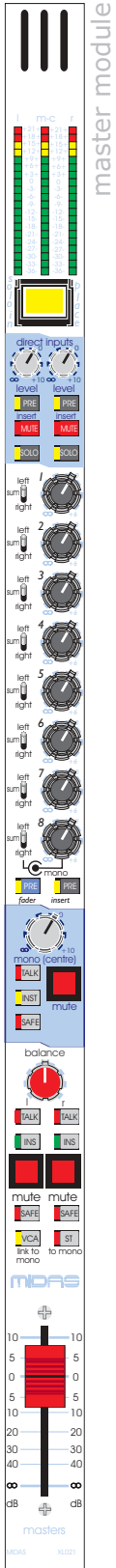

Balance - The balance (Pan) control gives continuous and reciprocal adjustment of the stereo left and right signals by +3dB to off. This allows fine adjustment of the left, right power levels and imaging.

Talk - The left/right talk switch connects the left/right output to the monitor module so that the internal talk or oscillator may be routed to the output (see the monitor module section later in this manual).

INS - The INS switch connects the left/right insert return to the left/right signal path.

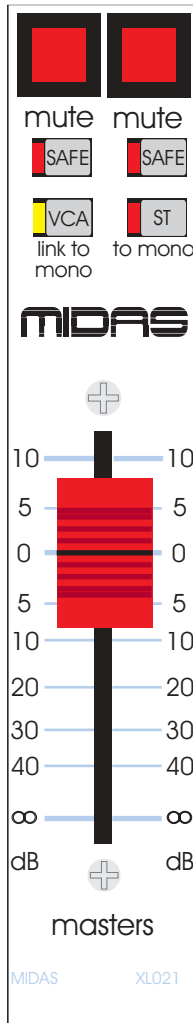

Mute - The left/right mute switches toggle the left/right mute. When lit, the left/right signal is muted at all points after the insert send. These mute switches can be controlled by the snapshot automation system.

VCA (link to mono) - When enabled, the mono signal is VCA controlled by the stereo master fader so that the mono output tracks changes in stereo output fader.

ST (to mono) - When depressed, a mono sum of the stereo signal (pre-insert) is sent to the main mono buss.

Fader - The master fader adjusts the level of the master output and is continuously variable from off (-inf) to +10dB



Monitor Module

Monitor Connections

The Heritage 4000 local outputs are located on the rear of the console. Six male XLR sockets conventionally wired are provided - two (2) each for Left, Right and Mono (centre). The local outputs are labelled 'Local Outputs' and 'B Speaker'.

Six (6) balanced TRS quarter-inch jack sockets provide the send and return sockets for the local output inserts (two (2) for each Left, Right and Mono).

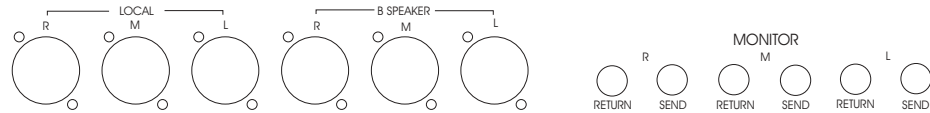

Monitor Module

Meters - The bargraph LED meters show the peak levels of the left and right monitor paths.

Signal Generator

1kHz - The 1kHz switch overrides the variable frequency control, replacing it with a constant 1kHz sine tone.

Freq - The freq control gives continuous adjustment of the oscillator signal frequency from 50Hz to 5kHz.

Pink - The pink switch overrides the oscillator and replaces it with a pink noise generator.

Level - The generator level control gives continuous adjustment of the signal generator peak output from off (-inf) to +10dB.

Generator to Internal - This switch connects the signal generator to the console's internal talk all and talk select busses.

Generator to External - This switch connects the signal generator to the external output talk XLR.

Talk

Talk to All - When enabled, this switch overrides all other talk buss switches and routes the talk mic or generator to all outputs.

Talk Mic - The talk mic socket is a conventionally wired balanced microphone socket accepting 150 ohm microphone signals.

Mic Gain - The gain of the talk mic is continuously variable from +20dB to +60dB. Note: The talk mic is operated in conjunction with a peak limiter which is factory set at +10dBu.

Level - The level of the talk mic is continuously variable from off (-inf) to +10dB.

Talk to Internal - This switch connects the talk mic signal to the console's internal talk all and talk select busses. Note: Local outputs are attenuated by 20dB when this switch is activated to help prevent feedback.

Talk to External - This switch connects the talk mic signal to the external output talk XLR.

Pre (Meter Change Over) - In normal operation, input meters are pre-fade (but post eq and post insert) and output and buss meters are post-fade. When the Meter Change Over switch is enabled, the metering is changed to monitor the input amplifier level and the buss driver level. i.e. the input meters become pre-fade, pre-eq and pre-insert. The buss and output meters become pre-fade.

Note: the monitor meter is the only meter on the console not changed.

Monitor Module

Mono source

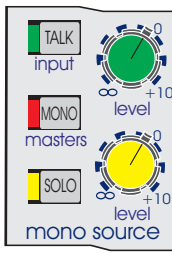

Talk (input) - The talk input switch connects the external talk input to the local mono monitor output.

Level - The level of the external talk inputs is continuously variable from off (-inf) to +10dB.

Mono (masters) - The Mono (masters) switch routes the post fader mono master mix to the local mono monitor output.

Solo - The Solo switch routes solo signals to the local output whenever a solo is active on the console. This overrides any signals sent from the mono buss but does not override talk inputs.

Mono output

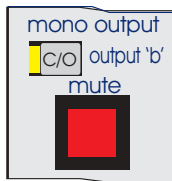

C/O (output 'b') - The mono output 'b' C/O switch disconnects the mono local monitor output from the main 'a' output and reconnects it to the secondary 'b' output.

Mute - The mono output mute switch toggles the mono output mute. When lit, the local mono monitor output is muted.

Phones

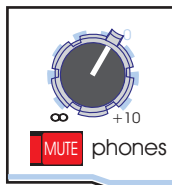

Phones - The headphone output level control gives continuous adjustment of the headphone level from off (-inf) to +10dB.

Mute - When depressed, the headphone output is muted.

Stereo source

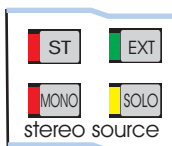

ST - When depressed, the post fader master stereo outputs are routed to the local stereo monitor outputs.

EXT - When depressed, the external stereo input (2 track, etc...) is routed to the stereo local monitor outputs.

MONO - The mono master switch routes the post fader master mono buss to the stereo local monitor outputs.

SOLO - The solo switch routes the solo buss signal to the stereo local monitor outputs when ever a solo is in place on the console overriding signals sent from the stereo master, mono master or any external input.

Stereo output

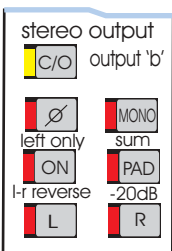

C/O (output 'b') - The stereo output C/O switch disconnects the local stereo 'a' outputs and connects the secondary 'b' local stereo monitor outputs.

Ø (left only) - The stereo output left only phase switch causes the phase of the left output of the local stereo monitors to be inverted.

Mono (sum) - The mono sum switch adds the left and right monitor signals with a 4.5dB summing loss.

ON (I-r reverse) - When depressed, the left hand monitor signal is routed to the right hand outputs and the right hand monitor signal is routed to the left hand output.

PAD (-20dB) - When depressed, the three local monitor outputs are attenuated by 20dB. 20dB attenuation is also provided when talk inputs are enabled to help prevent feedback.

L - The LEFT switch routes the left hand signal to both left and right local monitor outputs.

R - The RIGHT switch routes the right hand signal to both left and right local monitor outputs.

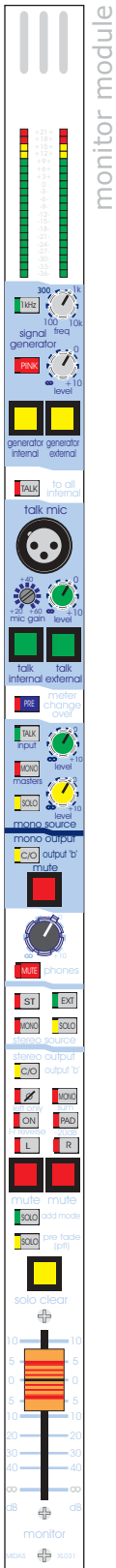

Monitor Module

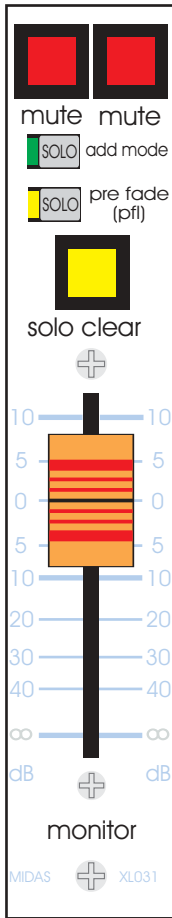
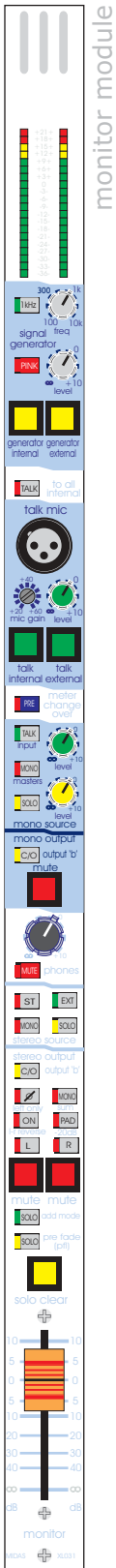

Mute (left) - toggles the mute on the left hand side of the local monitor outputs.

Mute (right) - toggles the mute on the right hand side of the local monitor outputs.

Solo (add mode) - The solo add mode switch changes the behaviour of the consoles solo operation. See the panel below for detailed information)

Solo (pre fade PFL) - The solo PFL switch sends the mono PFL bus signals to the headphones and local monitor outputs in place of the stereo AFL solo buss signals.

Solo Clear - The solo clear button has two functions:-

- 1 - The solo clear button will light to indicate that a solo is in place on the console.
- 2 - Pressing the solo clear button while lit will clear any active solos on the desk.

Fader - The monitor fader allows continuous adjustment of all three local monitor output signals from off (-inf) to +10dB.

Solo Behaviour

Normal Solo Function

When a channel solo is activated, the signal is sent to the PFL mono and the AFL stereo busses.

If the switch is pressed for a short time, it will latch the solo on or off. The solo system is, by default, auto cancelling. This means that when a solo is pressed, any previous solos will be released. However, if a number of solos are pressed within a short period (i.e. almost at the same time) of each other, a number of solos can be operated simultaneously.

If a solo switch is pressed for more than one second, the solo latch is disabled and the solo is cancelled as soon as the solo switch is released.

Solo Add Mode

When in solo add mode (solo add mode switch on the monitor module) the auto cancelling solo function is disabled allowing multiple solos to be activated. There is a priority order for the solo system in this mode which is:-

(High)	Input Solos
	VCA Solos
	Direct In Solos
	Group Solos
	Output Solos
(Low)	

In the case of a high priority solo being placed after lower priority solo, the higher priority solo will be sent to the PFL and AFL busses and the lower priority solo will not. Once the higher priority solo is removed, the lower priority solo will then be sent to the AFL and PFL busses.

Solo Clear

The Solo Clear switch on the monitor module will illuminate to show that a solo is in place on the console.

Pressing the Solo Clear switch on the monitor module will release all active solos on the console.



Console Automation

VCA and Mute assignment

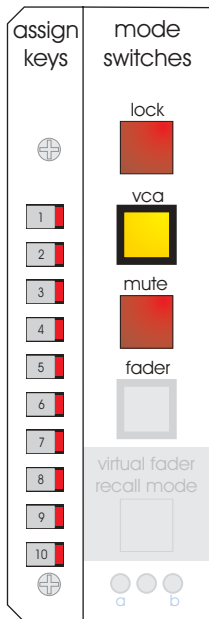

LOCK

To make assignments to any of the Heritage 4000's VCA or automutes, the system must first be unlocked by pressing the lock key (mode switches).

Pressing the lock key will toggle the console lock between off and on. When the switch is illuminated, changes are not permitted.

After 90 seconds of inactivity, the system will automatically return to a locked state.

VCA

To make assignments to the VCA, VCA mode must be selected by pressing the VCA key. This may only be done when the console is unlocked. VCA mode is enabled when the VCA key is illuminated.

MUTE

To make assignments to the Automute system, Mute mode must be selected by pressing the mute key. Again, the system must be unlocked to do this. Mute mode is enabled when the Mute key is illuminated.

ASSIGN KEYS

To make a channel assignment to a VCA or automute, the console must be unlocked and the mode must be selected. Then the desired VCA (or automute) can be selected using the assign keys.

A short press of the assign key will select the key and clear all previous selections. A long press, however, will allow multiple selections to be made. Pressing an assign key that is illuminated (selected) will cause it to be de-selected and the internal LED will be extinguished.

To assign the VCA or Mute to an input channel, press the channel SET key.

A long press on the channel SET key will clear any previous assignments and make new assignments according to the assign keys.

A short press will toggle the channels existing assigns with the selected assign keys.

i.e.
 If a channel has a mute assignment to 1,2 & 3
 In Mute mode, Assign keys 2 & 4 are selected
 The channels SET key is pressed

Result





Mute 1, 3 & 4 are assigned.

Clear Mode

Mute and VCA assignments may be cleared at the same time. Pressing the VCA and Mute mode switches for more than half a second will select both VCA and Mute modes. Ensuring all the assign keys are off, long-press the channel SET key for the channel to be erased. This will clear all Mute and VCA assignments for the channel.

Similarly, to clear only the Mute or VCA assigns, repeat the steps above except select only VCA or Mute mode.

MUTE recall

a		1
u		2
t		3
o		4
		5
m		6
u		7
t		8
e		9
s		10

To recall an automute, press the automute recall switch. Any channel that is assigned to that automute will be muted/unmuted.

If a channel is assigned to more than one automute, it's mute will not be released until all automute switches to which that channel are assigned are released.

Dot Notation

The dot in the upper left hand corner of the numeric display indicates that the scene number indicated is the scene in current usage.



The dot in the lower right hand corner of the numeric display indicates that the scene number indicated hold scene data (i.e. is not empty).

Backup

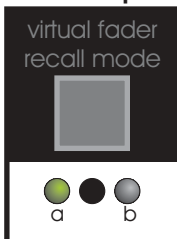

The Heritage 4000 automation and assignment system uses an on-board micro card to control the function of the console.

In fact, the H4000 has a redundant micro card should a fault occur on the other. For reliability, changes to the console are stored to both micro cards so that the information held on each is identical.

Beneath the 'virtual fader recall mode' switch on the mode switches console are two indicator LEDs and a switch.

The two LEDs indicate which of the two micro cards are currently in operation or that there is a fault:-

- Green LED - Card Active
- No LED - Card inactive
- Red LED - Card is damaged or not responding - Call an engineer as soon as possible

The switch can be used to switch between the two micro cards should one fail.

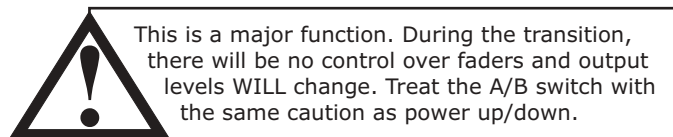

Snapshot automation

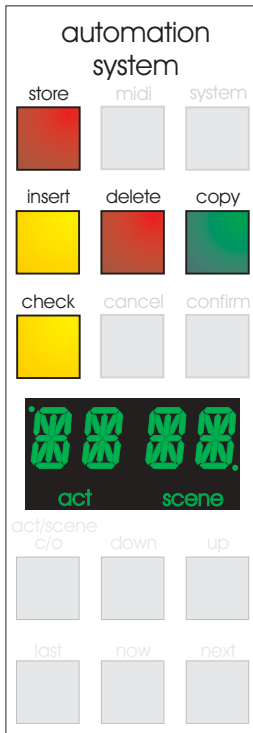

Snapshots of the consoles automation controls can be stored as SCENES or as ACTS. Essentially, there is no difference between an act and a scene memory except the way in which they are numbered.

As in a play or script, scenes are subsets within an act.

STORE

Pressing the store key will store the current console assignments and settings to the snapshot memory (as indicated on the numeric display).

NOTE: To prevent overwriting snapshot memories, the console can be locked. See later in this section.

INSERT

The insert key allows the operator to insert a snapshot memory (at the number indicated on the numeric display). All snapshot memories in the same scene after this point will be re-numbered (incremented by one).

COPY

The copy function allows the snapshot (indicated on the numeric display) to be copied to a temporary memory location. This can then be stored or inserted in the normal manner OR a fast scene number can be assigned to the scene by pressing the desired fast scene key.

DELETE

The delete key will delete the contents of the scene indicated on the numeric display.

CHECK

The check key can be used to preview the contents of a scene memory without actually recalling the memory.

Mute settings will be shown in the SAFE switches so that the actual channel mutes are not obscured. Whilst in this mode, the act/scene changeover and the up/down switches can be used to step through the memories on the console.

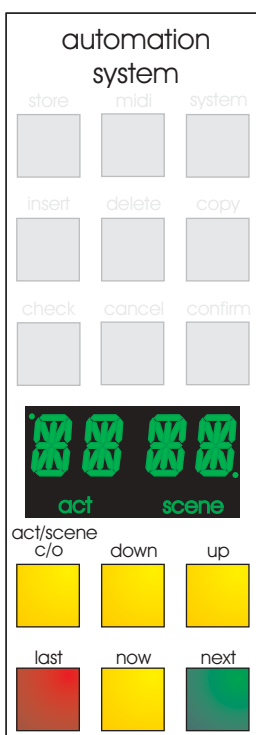

The lower 6 keys are used to navigate or load the scene and act memories.

Act/Scene C/O

The act/scene changeover key switches between act or scene mode. The current mode is indicated under the numeric display.

Up/Down

The up and down keys allow the user to scroll through the scene or act memories on the console and navigate through menus. The numeric display shows the number of the memory but note that using the up/down keys does not load the memory.

Please note the function of 'dots' on the numeric display (as shown on page38).

Last/Now/Next

The last, now and next allow quick the recall of memories.

Now - Recalls the snapshot memory indicated on the numerical display.

Last - Recalls the snapshot memory that numerically precedes the snapshot memory that is currently active or stored.

Next - Recalls the snapshot memory that numerically proceeds the snapshot memory that is currently active or stored.

Fader automation system

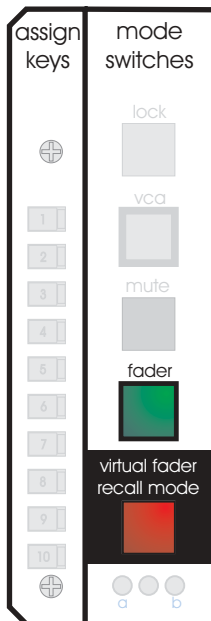

Fader

The fader switch enables the fader assignment/display mode for the fader tray LED's.

Virtual Fader Recall Mode

The virtual fader recall mode switch enables the operation of the virtual fader system.

Real Fader Mode

In real fader mode, all of the internal VCA systems are controlled by the real (physical) faders. The automation system can assist in the control of each real fader by prompting the user using the 11 LEDs next to each fader.

The fader positions stored in a snapshot memory can be viewed by recalling the scene and pressing the virtual fader recall mode switch. The LEDs will flash to indicate the stored position of the fader. As the fader is moved towards the position shown, the LED will stay alight continuously until the fader is in the correct position. If the fader is just under the stored position, a LED will light above the fader position. If the fader is just over the stored position, a LED will light below the fader position until the fader is positioned to the correct level.

Virtual Fader Mode

In virtual fader mode, the console automation takes control of all the internal VCA systems and displays a representation of the virtual fader position using the 11 LEDs next to the real fader. Additional adjustment trims can be added if necessary.

If the console is unlocked to RECALL mode or higher, scenes may be recalled but not stored or overstored. If fader adjustments are required, the fader must be 'picked up' by taking it to the 0dB level. Fader adjustments then remain active for all subsequent scenes recalled (unless the adjustment is cleared).

If the console is unlocked to STORE mode or higher, scenes may be recalled, stored and overstored. When storing a snapshot, the virtual fader level is always stored, regardless of the real fader. If fader adjustments are required, the fader must be 'picked up' by taking it to the current virtual fader position. When a new scene is recalled, the fader adjustment is removed forcing the user to 'pick up' the fader again before making further adjustments.

Access levels

system

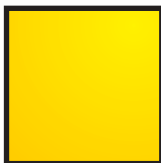

The Heritage 4000's automation system can be locked so that it's memories cannot be changed, erased or overwritten by mistake.

This is done in the SYSTEM menu (more explanation of this later in this section) under the LOCK section.

Four (4) options are available which will limit the amount of access granted to users of the console.

TOTAL

All automation and assignment functions disabled

ReCALI

Only recall and assignment functions are available

STORe

Scene storage/editing, recall and assignment are available

SYSTEM

All functions are available

This protection is designed as a protection against accidental rather than security protection as it is not password protected.

Virtual fader recall vs store

The differences between virtual fader recall and virtual fader store modes are discussed in more detail:-

Recall Mode	Store Mode
<p>Recall a new scene and leds will indicate the current virtual fader positions. Note that that these leds <u>always</u> indicate the actual fader setting that is controlling the audio.</p>	<p>Recall a new scene and leds will indicate the current virtual fader positions. Note that that these leds <u>always</u> indicate the actual fader setting that is controlling the audio.</p>
<p>To adjust a virtual fader move the real fader to 0dB. When the fader is at 0dB the red set led will illuminate indicating that the virtual fader is ready for adjustment. Moving the fader will add an offset to the original stored scene. The amount of offset is clearly indicated by the physical position of the fader above or below the 0dB line. The virtual fader position can also be viewed via the leds (plus any adjustment offsets).</p>	<p>To adjust a virtual fader move the real fader to the same position as the virtual fader. When the fader has reached this point the red set led will illuminate indicating that the virtual fader is now "tracking" the real fader. Moving the real fader will there for adjust the position of the virtual fader and this is indicated by changes in the virtual fader leds.</p>
<p>If a new scene is recalled the fader adjustments made will be added to the new scene also. The adjustment can be removed by returning the fader to the 0dB position or by "clearing" the fader to -infin as detailed below.</p>	<p>If a new scene is recalled the fader adjustments will all be cleared and the set leds will extinguish to indicate that faders are not "tracking" even if their position suggests that they are (because they are not set to -infin).</p>
<p>In order to make the virtual fader leds as clear to view as possible it might be desirable to "clear" all non adjusted faders to -infin. To do this press the virtual fader switch and then move any fader that is to be "cleared" to the -infin position. Press the virtual fader switch again and the faders will be ready to be active again. Only faders which do not need adjustment should be cleared as any virtual fader level changes made prior to clearing will be removed at the next scene recall.</p>	<p>In order to make the virtual fader leds as clear to view as possible it might be desirable to "clear" all non adjusted faders to -infin. To do this press the virtual fader switch and then move any fader that is to be "cleared" to the -infin position. Press the virtual fader switch again and the faders will be ready to be active again. Any virtual fader level changes made prior to clearing will still be active but they will be cleared at the next scene recall.</p>

<p>It is possible to "pick up" all the faders and then set them to 0dB if adjustment is not required. There is no <u>need</u> to "clear" them. This is a user preference.</p>	<p>If faders are not cleared prior to recalling a new scene it may be advisable to clear them immediately afterwards to avoid confusion.</p>
<p>Any virtual fader can be isolated from further scene recall by pressing the AUTOMation SAFE switch. After the switch is pressed it will also be possible to "pick up" the virtual fader at the recalled position and adjust it using the real fader (exactly the same as for store mode). Any subsequent scene recall will have no effect on the virtual fader position.</p>	<p>Any virtual fader can be isolated from further scene recall by pressing the AUTOMation SAFE switch. After the switch is pressed it will also be possible to "pick up" the virtual fader at the recalled position and adjust it using the real fader. Any subsequent scene recall will have no effect on the virtual fader position.</p>
<p>To regain virtual fader control switch the AUTOMation SAFE switch off and then recall the current (or next required) scene. Virtual fader control will resume as the scene is recalled. The fader will not be "picked up" and can be moved to -infin if desired as long as it does not pass through 0dB. If it does pass through 0dB it will "pick up" in the normal way.</p>	<p>To regain virtual fader control switch the AUTOMation SAFE switch off and then recall the current (or next required) scene. Virtual fader control will resume as the scene is recalled. The fader will not be "picked up" and can be moved to -infin if desired as long as it does not pass through the virtual fader position. If it does it will "pick up" in the normal way.</p>
<p>Any input channel virtual fader can be <u>totally</u> isolated by pressing the FADER SAFE switch. At this point the virtual fader will "snap" to match the real fader position and any master VCA and automation control will be removed. To regain virtual fader control switch the fader safe off and recall a new scene. The real fader can then be cleared to -infin in the normal way.</p>	<p>Any input channel virtual fader can be <u>totally</u> isolated by pressing the FADER SAFE switch. At this point the virtual fader will "snap" to match the real fader position and any master VCA and automation control will be removed. To regain virtual fader control switch the fader safe off and recall a new scene. The real fader can then be cleared to -infin in the normal way.</p>
<p>It is not possible to store a scene in this mode. The main reason this is not allowed is because multiple overstores of faders which have adjustments made would result in incremental virtual fader position changes which in most cases would not be desired.</p>	<p>When storing a scene the information loaded into the scene memory will always be as displayed by the leds. This still applies if a fader is isolated by the fader safe or automation safe switches.</p>

Using fader modes

The Heritage 4000 has a flexible fader mode system which, used properly, will allow the user to benefit from the full functionality of the console. There is no right or wrong way to use the fader modes as this will be largely dictated by the environment in which the console is being used and the application.

It is worth spending some time to familiarise yourself with the fader modes and automation systems so that they may be tailored to your specific needs, but as a guide:-

REAL FADER STORE and RECALL modes

Used for the initial setup of a show and during early rehearsals. Also used for situations where no prior setup has been possible. Fader positions stored to the automation memory are as per the real faders so great care must be taken to set them correctly prior to overstoreing any adjustments.

VIRTUAL FADER STORE mode

Used for later rehearsals and for shows where there is a large degree of change from night to night due to venue conditions or ad lib's etc. Each scene recalled is as it was stored but may need adjustment to suit the prevailing conditions. Adjustments are clear and fast to implement with the real fader taking over from the virtual fader as required. Overstoreing is easily possible so as to fine tune the data in the automation memory.

VIRTUAL FADER RECALL mode

Used for events and shows that are well rehearsed and predictable. Each scene recalled is as it was stored plus an offset adjustment from the real fader if required. Any changes that are made are active for all subsequent scenes until such a time as they are removed by the operator. Overstoreing is not possible.

Setup menus

To make changes to the console's configuration or to invoke memory dumps etc...
A menu map is provided below.

 This symbol is used to denote that the confirm key must be pressed to continue.

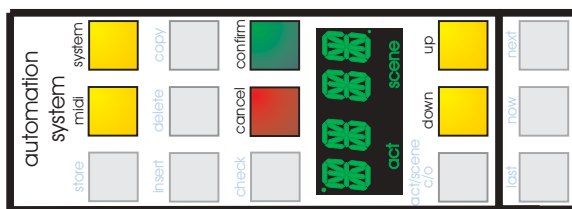

To enter the menu system, press either the MIDI or SYSTEM key to access the relevant menu.

The up/down keys are used to navigate the menu system and cancel/confirm to make or lose changes.

The numeric display will show the menu options and the values which have been assigned.

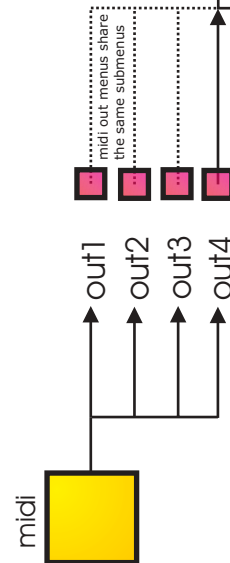
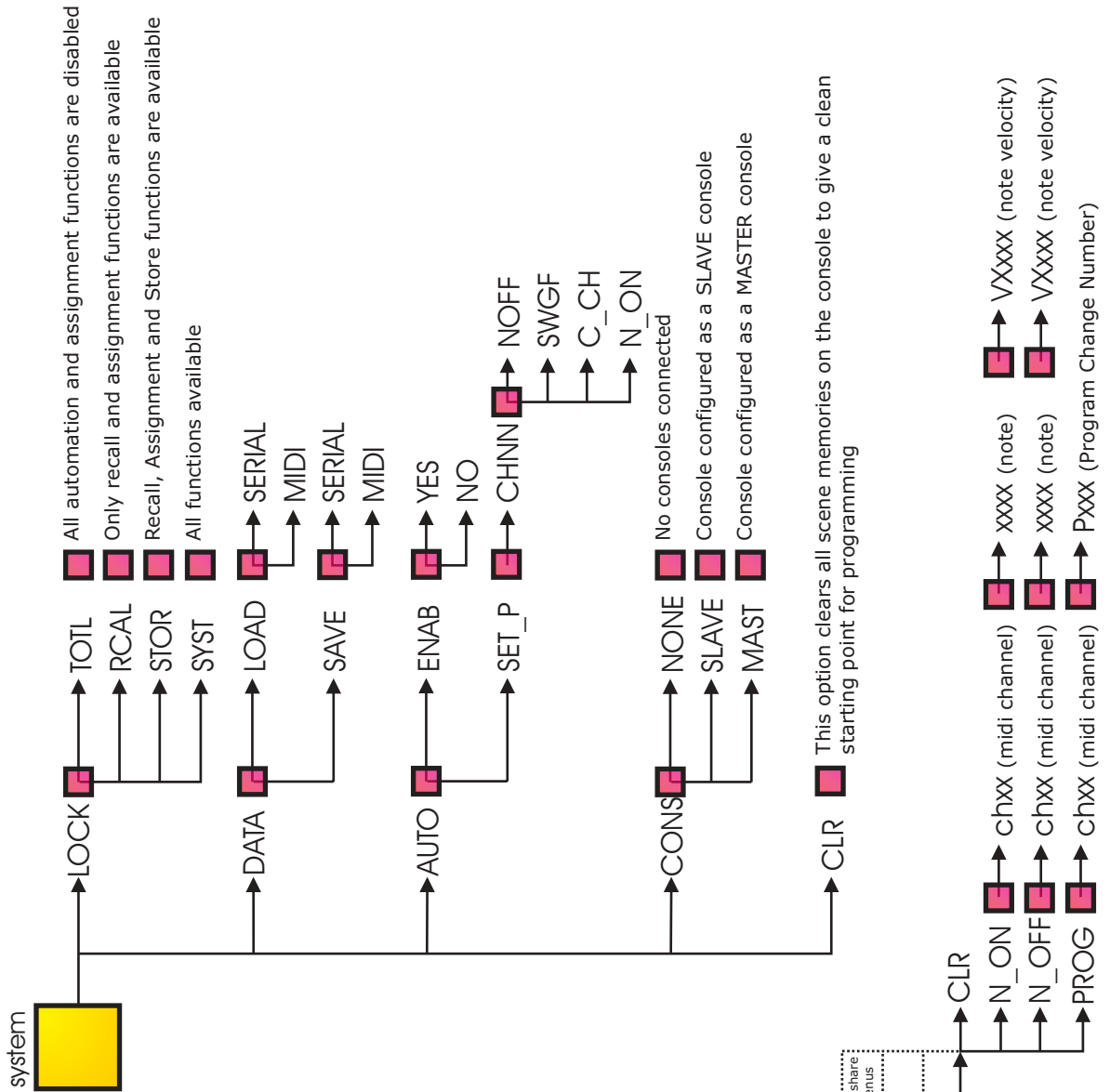



Automation & Linking Walkthrough

Unlocking the Console:

To unlock the mixing console press the SYSTEM menu button. Using the up/down keys scroll through the menu until LOCK is displayed, press CONFIRM. Using the up/down keys scroll through the menu until the desired level of unlock is displayed on the screen, then press the confirm button.

Locking the Console:

To lock the mixing console press the SYSTEM menu button. Using the up/down keys scroll through the menu until LOCK is displayed, press CONFIRM. Using the up/down keys scroll through the menu until TOTL is displayed on the screen, then press the CONFIRM button.

The LOCK button located on the MODE SWITCHES disables the Assign keys, Mode switches and Set switches on the Centre section and input faders.

Storing a Scene:

Setting up a scene, Assigning VCA, Mutes, Faders etc.

Assigning VCAs:

Ensure that the lock button is not illuminated on the mode switches (if it is, press the button to extinguish the LED).

- Press the VCA mode button so that it is illuminated. This has now selected the VCA mode on the input modules.
- Using the ASSIGN KEY select which master VCA you wish to assign to a particular input module (1-10). Quickly pressing a key will clear all other buttons enabled so only the one selected is illuminated, push and holding the key down for 0.25 seconds will not disable other buttons previously enabled.
- On the input channels you wish to assign to the master VCA(s) selected press the SET Button, the relevant LED(s) on the input channel will illuminate. If the SET button is pressed quickly the VCA's selected on the assign keys will toggle those already selected on the channel. If the SET button is pressed and held for a short time then any VCA's already selected on that channel will be cleared and replaced with those selected by the assign key.

Assigning Mutes:

- Ensure that the lock button is not illuminated on the mode switches. If it is, press the button to extinguish the LED.
- Press the MUTE mode button so that it is illuminated. This has now selected the mute mode on the input modules.
- Using the ASSIGN KEY select which Automutes you wish to assign to a particular input module (1-10). Quickly pressing a key will clear all other keys enabled so only the one selected is illuminated, push and holding the key down for 0.25 seconds will not disable other buttons previously enabled.
- On the input channels you wish to assign to the Automutes selected, press the channel SET Button. The relevant LED(s) on the input channel will illuminate. If the SET button is pressed quickly the Automutes selected on the assign keys will toggle those already selected on the channel. If the SET button is pressed and held for a short time then any Automutes already selected on that channel will be cleared and replaced with those selected by the assign key.

Fader Position:

- Ensure the Virtual Fader recall mode button is not illuminated and the faders are in normal mode, if this is enabled the new fader position will not be stored.
- Move the faders to the desired position. The only other automated buttons on the console to be set are the Input Mutes, Master VCA Mutes, Group Mutes, Matrix Mutes and Master Mutes.

Selecting a memory number and storing the memory:

- The numbers in the display can be altered as follows. Select either Act or Scene using the ACT/SCENE C/O switch. You will see either act or scene illuminate below the display.
- The digits can then be altered between 00-99 using the UP and DOWN keys. This function is looping so if you are on 00 you can go directly to 99 by scrolling down.
- To store a scene press STORE. If the scene is new then it will be stored and the screen will display done.

Automation and Linking

- If the scene already exists then the display will read over_str and you will need to press the confirm button. The screen will then read done.

Editing Midi (Program Change):

- Pressing the MIDI button places you in the MIDI menu.
- Using the UP and DOWN buttons scroll through OUT01 to 04 until the required message is reached. (On the Heritage there are a maximum of 4 MIDI out messages that can be sent per recalled scene). Press CONFIRM.
- Using the UP and DOWN buttons scroll through the menu until the screen reads PROG. Press the CONFIRM button
- The display will read CH00, using the UP and DOWN keys a channel between 01 to 16 can be selected. Press CONFIRM.
- The display will read P000. Using the UP and DOWN keys, a program change between 00 and 127 can be selected. Press confirm and you will be dropped back to the first level of the menu. When the desired messages have been edited press the MIDI button again to drop out of the menu.
- To then store the MIDI information with the scene the STORE button must be pressed followed by CONFIRM

Assignment of Program changes to a Scene:

- Once a scene has been stored press the STORE button so that the display reads OVER/STOR.
- Press the UP key until the display reads PRCH then press CONFIRM.
- Using the UP or DOWN key chose the required MIDI program change you wish the scene to be recalled by. You have the choices NONE, Program Changes 000-127.

Inserting Scenes:

- Once you have created the scene you wish to insert edit the act/scene number display using the ACT/SCENE, UP and DOWN buttons until the desired position is displayed.
- Press the INSERT key. The display will then read *done*. The original scene and any scene preceding it will then be incremented by one position.

NB The INSERT button will only be illuminated if a scene exists where you wish to place the scene, otherwise STORE may be used as normal.

Copying Scenes:

- Recall the scene you wish to copy by selecting the scene number and pressing the NOW button.
- Press the COPY button.
- The MIDI Button will be illuminated as default which indicates that the midi out messages will also be copied with the scene. If you do not wish the midi out information to be copied to the new scene press the MIDI button so that the light is extinguished.
- The act/scene numbers can now be scrolled through using the ACT/SCENE, UP and DOWN buttons until the desired position is reached, then press the STORE button.

Editing the Cross fade Value of a Scene:

- Recall the scene you wish to copy by selecting the scene number and pressing the NOW button.
- Press the STORE button, and using the UP and DOWN buttons scroll through the display until XFADE is shown, press CONFIRM.
- The current cross fade speed stored with the screen will be displayed. Using the UP and DOWN buttons select the required cross fade speed.
- Press CONFIRM to store this new speed with the scene.
- NB When a scene with a cross fade speed is being recalled the display will flash for the specified cross fade time

Automation and Linking

Halting a Cross fade:

- To Pause a crossfade during recall press the CANCEL button. The crossfade can be resumed again by pressing the CONFIRM button.

Bypassing a Cross fade:

- A crossfade can be bypassed by pressing the confirm button as the crossfade is being applied, this will immediately take you to the finished scene.

Previewing a Scene:

To preview a scene without affecting your mix, select the scene number on the display using the ACT/SCENE, UP and DOWN buttons. Once the desired number is displayed, press the CHECK button. The automated switch configuration and fader positions stored for that scene can be viewed without changing the actual settings.

The Automute Safe buttons on the inputs will display the input mute state.

The master VCA mutes will display the Master VCA mute setting with out altering the Audio.

The Group and Matrix Mute Safe buttons will display the checked scene mute status.

The display will also scroll through the other stored scene information, telling you if midi in is enabled and the channel assigned. The MIDI out information stored with the scene, cross fade value and program change number the scene will respond to.

Pressing the CHECK button will drop you back into normal mode.

Recalling Scenes:

There are 3 methods by which scenes can be recalled:

- Stepping through existing scenes using the LAST and NEXT buttons. This steps through the scenes in numerical order.
- Select the act/scene number using the ACT/SCENE, UP and DOWN buttons, when the correct scene number is displayed in the screen press the NOW button and the scene will be recalled.
- A scene can be assigned to a fast scene key (1-10). In this instance the scene is recalled by just pushing the fast scene key.

Assigning A Scene To A Fast Scene Key:

- Recall the scene you wish to assign to a FAST SCENE KEY.
- Press the COPY button, followed by the FAST SCENE KEY button you wish to assign that ACT/SCENE to. The screen will then display done.

Deleting a Scene From A Fast Key:

- Press and hold down the FAST KEY you want to delete.
- When the YES and NO button start to flash you can now select either YES or NO to delete or cancel deletion of the FAST KEY.

Deleting A Scene:

- Recall the scene you wish to delete, Or display the scene number on the screen using the ACT/SCENE, UP and DOWN buttons. When this is done press the DELETE button.
- You will be asked to confirm this. Press the CONFIRM button the screen will then say done when the scene is deleted.

Automation and Linking

Midi In Assignment:

Setting The Console to Respond to MIDI Changes:

The console settings can be accessed via the "AUTO" submenu after pressing the "System" button. This submenu option is only available when in "SYS" Lock-Mode.

After selecting "AUTO", there are two further sub-menus:

1. ENAB -(ENABLE), this is the master switch for this function and can be set to "YES" or "NO". Toggling this switch will not delete the other setup parameters for this function.
2. SETP - (SETuP), this is where we set the actual midi parameters that are used for this function. These parameters define the midi command that the console will respond to, and decode the required act/scene number. The two parameters that can be set are as follows:
 - a. The midi command, this can be either of the following midi commands:
 - N ON - (Note ON)
 - NOFF - (Note OFF)
 - SNGP - (Song Pointer)
 - PRCH - (Program Change)
 - b. The MIDI channel, this covers the full 16 channels possible, the display shows CH 01 - CH 16.

Notes:

1. To respond to an external midi request to change the act/scene number, the following conditions must be true:
 - a. The "AUTO - ENAB" menu setting must be set to "YES".
 - b. The console must not be in "TOTL" (TOTaL) Lock-Mode.
 - c. The console use must not be performing any menu operations.

Setting Up a Midi Device:

To cause the console to automatically change its act/scene, a MIDI command can be sent using the pre-programmed command & channel (as set on the console). The actual act/scene number is encoded into the MIDI command data that is sent.

The required MIDI command data can be constructed by setting the midi command parameters as follows:

Note ON/OFF : These MIDI commands have two parameters, as follows:

1. NOTE, this parameter is equivalent to the required "ACT" number.
Each note has a numerical equivalent (see table below)
2. Velocity, this parameter is equivalent to the required "SCENE" number.

Example: To program a change to ACT 20, SCENE 44, - Set the note to G#-1, set velocity to 44.

Song Pointer - The command is a numerical value and is equivalent to the combined "ACT" & "SCENE" number.

Example: To programme a change to ACT 45, SCENE 02, - set the value to 4502

MIDI Sysex Dumps:

NOTE	OCTAVE										
	-1	0	1	2	3	4	5	6	7	8	9
c	0	12	24	36	48	60	72	84	96	108	120
c#	1	13	25	37	49	61	73	85	97	109	121
d	2	14	26	38	50	62	74	86	98	110	122
d#	3	15	27	39	51	63	75	87	99	111	123
e	4	16	28	40	52	64	76	88	00	112	124
f	5	17	29	41	53	65	77	89	01	113	125
f#	6	18	30	42	54	66	78	90	02	114	126
g	7	19	31	43	55	67	79	91	03	115	127
g#	8	20	32	44	56	68	80	92	04	116	-
a	9	21	33	45	57	69	81	93	05	117	-
a#	10	22	34	46	58	70	82	94	06	118	-
b	11	23	35	47	59	71	83	95	07	119	-

Automation and Linking

MIDI Sysex Dumps:

To store the recall a memory between the console and a midi device (such as an Yamaha MDF3 midi Filer) or the windows software available from Midas, select the SYSTEM menu, using the UP and DOWN keys select DATA and press CONFIRM. Using the UP and DOWN keys select either SAVE or LOAD and press CONFIRM. There are 2 communication options, either MIDI (through the midi port rear of the console or via RS232. Select either MIDI or SERIAL using the UP and DOWN buttons and press CONFIRM. The screen will then indicate the function being carried out and notify the user when finished.

Saving The Memory From The H4000 To A File

Connect the null modem cable.

Select the Show menu and click on 'Download From Console'. A window will open and set up the Comm port. The message

Waiting for Show data will then be displayed.

Select the 'SYSTEM' menu on the H4000 and scroll to 'DATA'. Press 'CONFIRM', then scroll to 'SAVE' and press 'CONFIRM'. Now scroll to 'RS-232' and press 'CONFIRM'. The show memory from the H3000 will then be down loaded into the computer. When the data transfer is complete, the H4000 will ask you to confirm the STORE OK, press 'CONFIRM'.

Select the Show menu in Hsutil and click on Save To File.

A prompt will appear asking for a show a name. Give the file type as *.shw.

Click on OK and the file will be saved.

Down Loading A Show Into The H4000

Connect the null modem cable.

Select Show menu and click on 'Load From File'. Using the browse function select the show you wish to download into the console and click on OK. A window will open telling you the loading is complete, click on OK.

Select the Show menu in Hsutil and click on Upload to console. A window will open asking you to hit upload when console is ready.

Select the SYSTEM menu on the H4000, and scroll to 'DATA' then press 'CONFIRM'. Scroll to 'LOAD' and press 'CONFIRM'. Now scroll to RS232 and press 'CONFIRM'.

Click on the 'Upload' button.

When the file is downloaded successfully, the H4000 will prompt you to press 'CONFIRM'. The show memory from the computer will now be loaded into the H4000.

Linking Heritage Consoles together Via CAN:

A maximum of 6 consoles can be linked via the CAN bus connector located at the rear of the Heritage consoles. Any mixture of any Heritage consoles may be linked H4000, H3000, H2000 or H1000. They are linked using a cable the description of which is given on the next page. If you have more than 2 consoles in a system the end consoles (either end of the cable) must have the RED termination button in the out position (default), all other consoles must have this Red button pressed in.

When linked only one console can be the master at any one time, all other linked consoles are slaves. The following functions are linked:

- Master VCA Control
- Master AutoMute Control
- VCA Master Solo
- Solo in Place Mode
- Scene Storage and Recall (See attached Note 1)
- Mode Switches
- Automation Assignment Keys
- Solo On
- Solo Clear (See Note 2)

Automation and Linking

Note 1

All scene memory information remains local to the console so when saving or loading memories to or from the console by either computer file or midi sysex dump, each console must be done individually. When setting up a multiple console system it is recommended that programming is done from the start with all consoles linked. This is to avoid recalling a scene that does not exist on a slave console. If this is done you will see a warning message on the Master indicating that the scene does not exist and prompting for confirmation at which point the master will recall the required scene but the slave will remain on the last existing scene recalled.

MIDI may only be stored locally on a console, if you wish to program midi outs on slave console you must first make this the master or stand alone (this will be described later) and then program your midi out messages as normal.

Note 2

As the Solo add and Clear function of the Heritage 1000 are controlled differently to that of the 4000, 3000 and 2000. The solo CLR and ADD functions are not linked and must be triggered locally on any 1000 linked into a system.

Switching a Console to Master or Slave:

Press the SYSTEM menu and using the UP and DOWN keys scroll to CONS then press CONFIRM.

Using the UP and DOWN keys select either Master or Slave then Press CONFIRM.

You will then be prompted to choose the ID number of the console using the UP and DOWN keys you have a choice of ID 1 to 8. No two consoles in the same system may have the same ID.

Pressing CONFIRM will then synchronize the console with the system.

Note When a console is in slave mode CONS is the only item of the SYSTEM menu that can be accessed. If a slave console is reconfigured to be a master it will automatically make the original master console a slave when the CONFIRM button is pressed.

Cable Specification		CAN CABLE HS-CAN-8-01	Page 1 of 1.
		H1000 / H2000 / H3000 / H4000	ACBLX-1606-1

Item	Description	Qty	Manufacturers' Reference	KT Part No.
Connectors				
1.	5 Pin XLR NC5MXB X-Series	2	Neutrik: NC5MXB	CON31-5MXB
2.	5 Pin XLR NC5FXB X-Series	1	Neutrik: NC5FXB	CON31-5FXB
Cable				
3.	Cardinal 48400 'Starquad' 4 Core Cable	8m	Farnell: 152-133	

Connector Pins	Signal	Cable Core	Cable Colour
Pin 1	NA	No Connection	NA
PIN2	CAN_L	CABLE CORE 1	BLUE
PIN3	0V CAN	CABLE CORE 3	GREEN
PIN4	CAN_H	CABLE CORE 2	RED
Pin5	NA	No Connection	NA
CASE	CHASSIS	Braid Screen	TIN
No Connection	NA	Cable Core 4	White

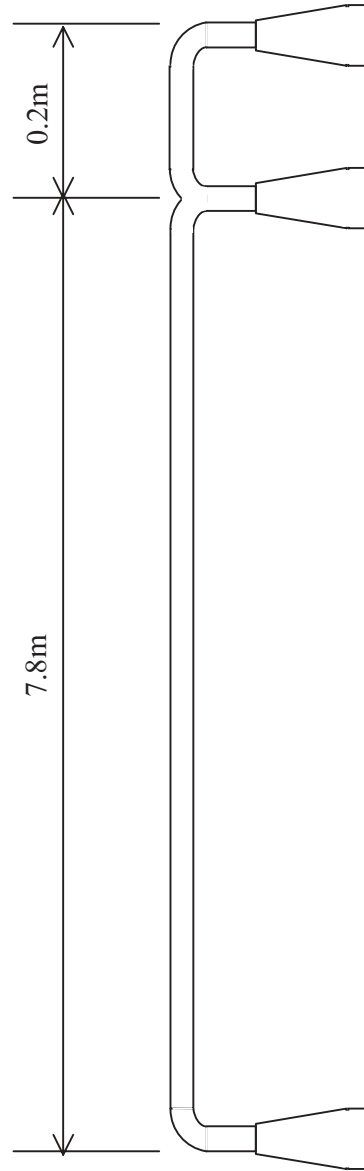

Issue	Date	Notes/ECN	Drawn:	Alison Ashmore	Drawing Number
1	01-12-99	Released to Production	Checked:		ASI606-1
2			Approved:		
3			From: N/A	To: N/A	
4			Connector (n/a)	Connector (n/a)	



Weights and Dimensions

Weights and Dimensions

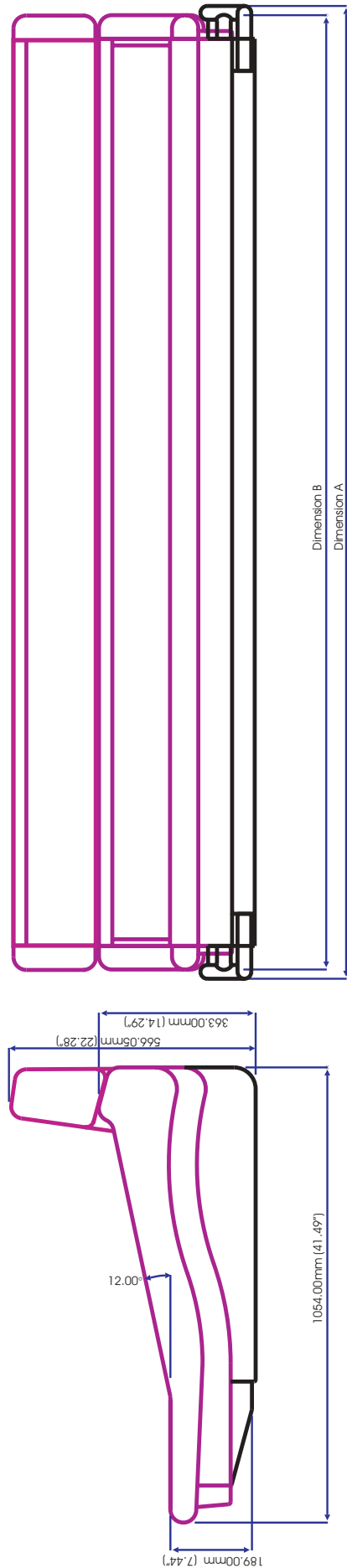

48 channel frame

Dimension A=2268.00mm (89.290") Dim B=2225.00mm (87.590") Weight* 255kg (560.0lbs)

56 Channel Frame

Dimension A=2559.00mm (100.740") Dim B=2516.00mm (99.050") Weight* 293kg (645.7lbs)

64 Channel Frame

Dimension A=2780.00mm (109.449") Dim B=2737.00mm (107.756") Weight* 300kg (661.2lbs)

*out of flightcase

Rear Panel Description

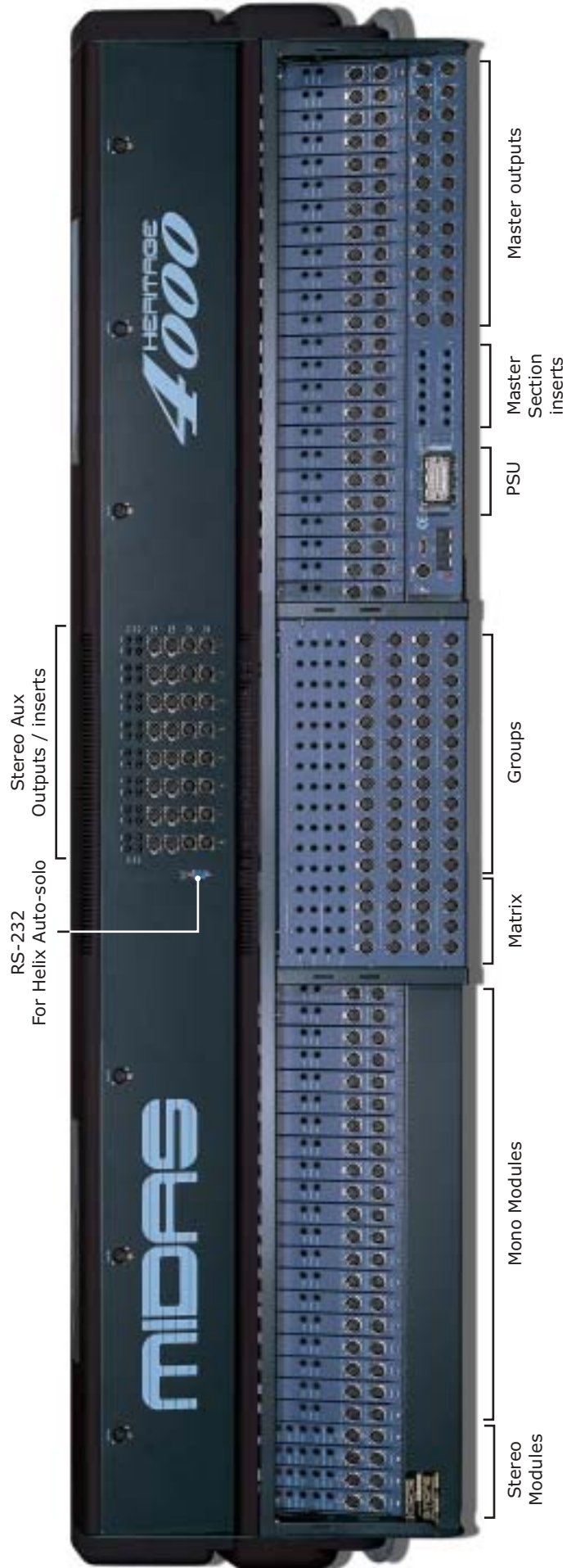



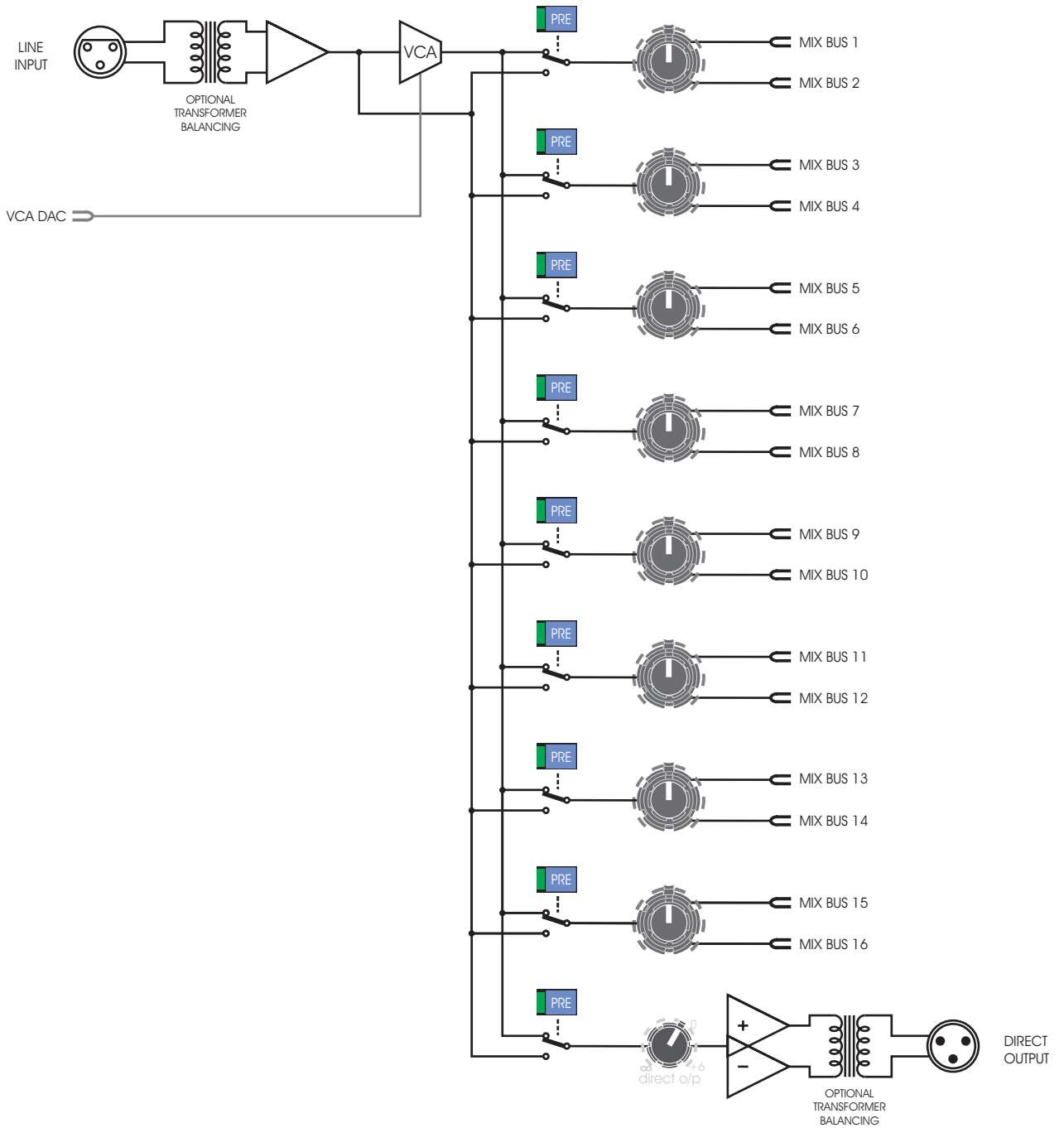

Block Diagrams



MIDAS

HERITAGE 4000 AUXTENDER
INPUT MODULE BLOCK DIAGRAM

SIGNAL PATH KEY	
	ANALOGUE SIGNALS
	D.C. SIGNALS

MIDRAS

HERITAGE 4000 GROUP MODULE BLOCK DIAGRAM

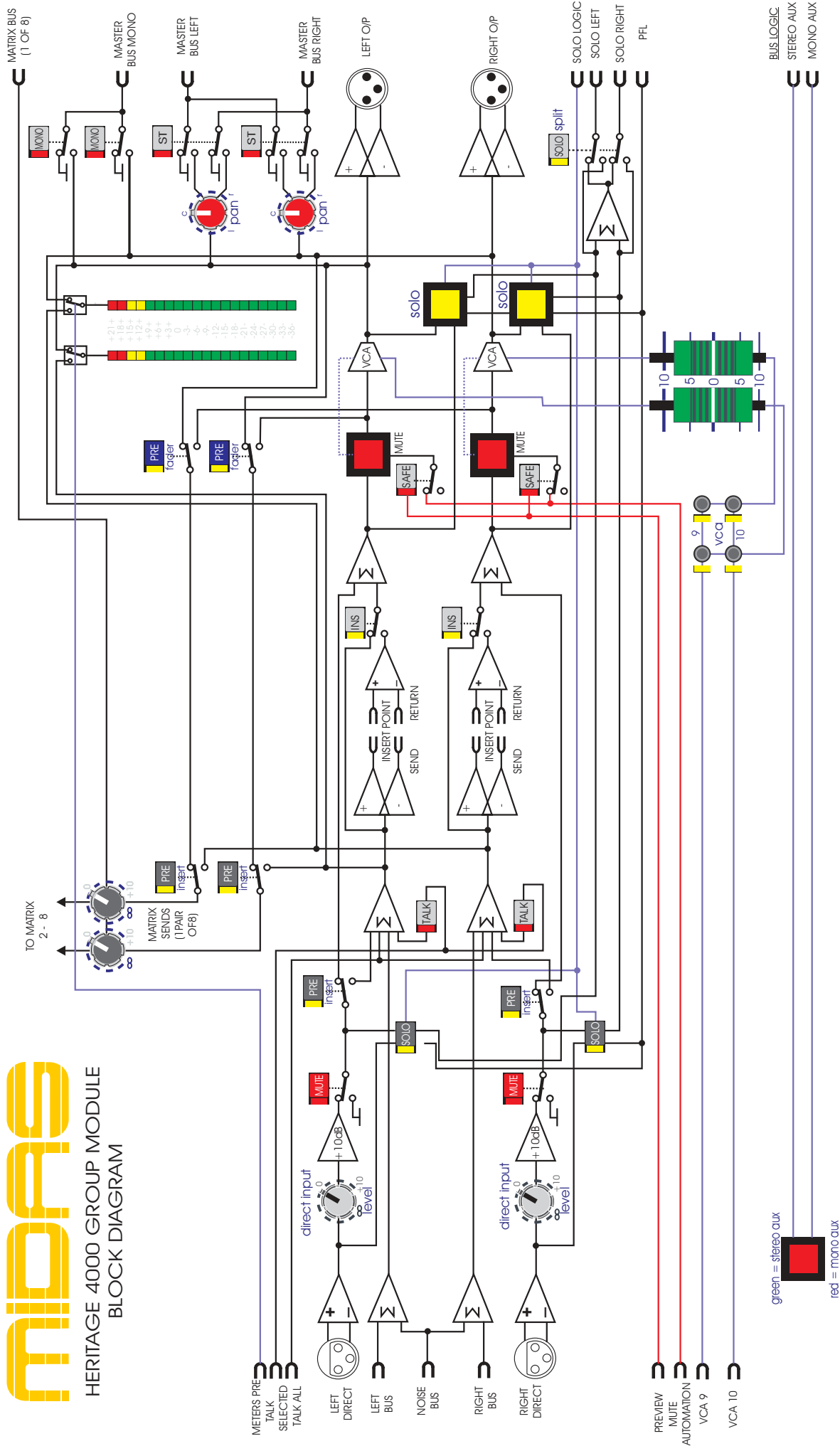

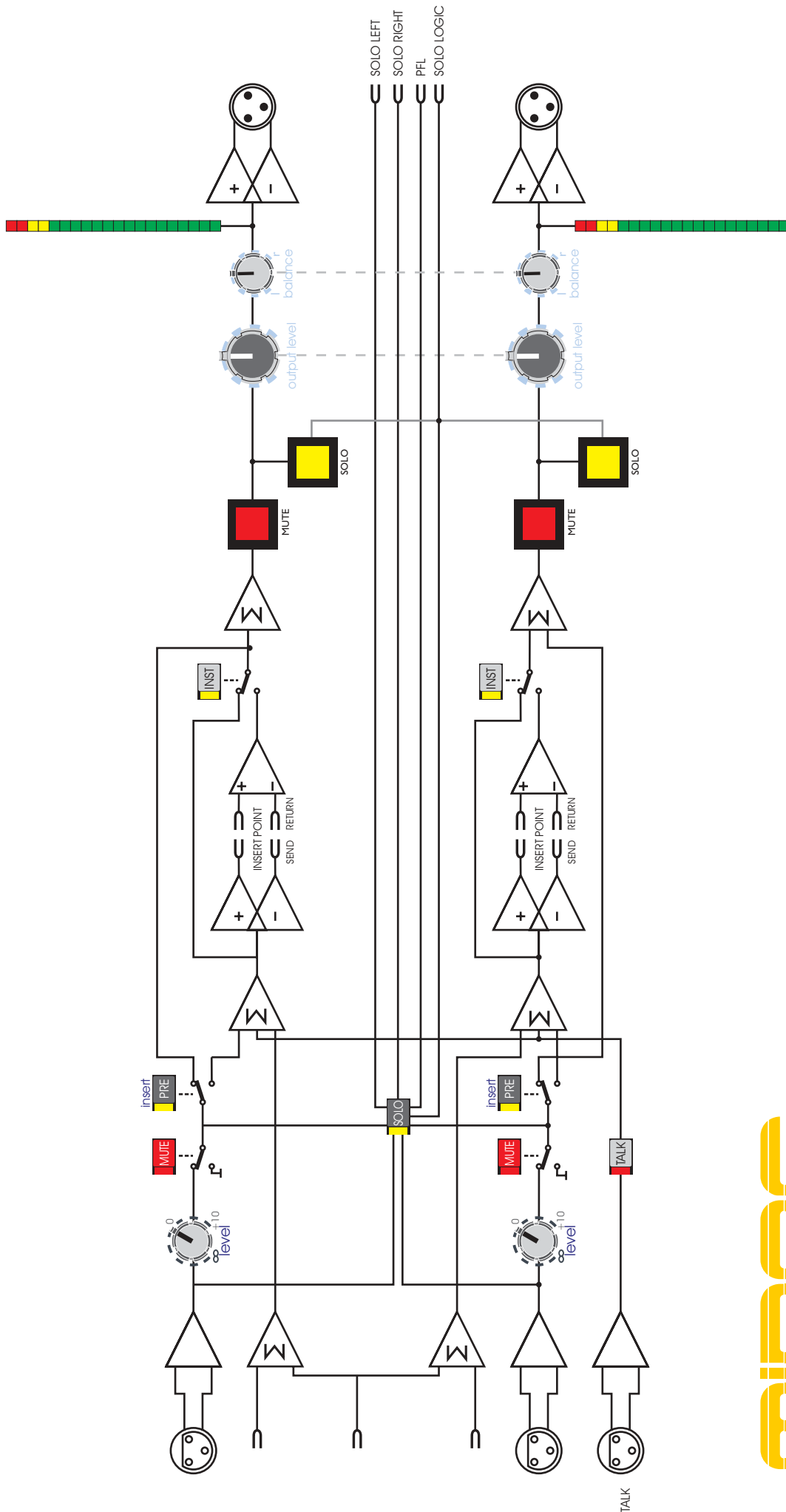

MIOPS

HERITAGE 4000 STEREO AUX
MODULE BLOCK DIAGRAM

MIDAS

HERITAGE 4000 MATRIX MODULE BLOCK DIAGRAM

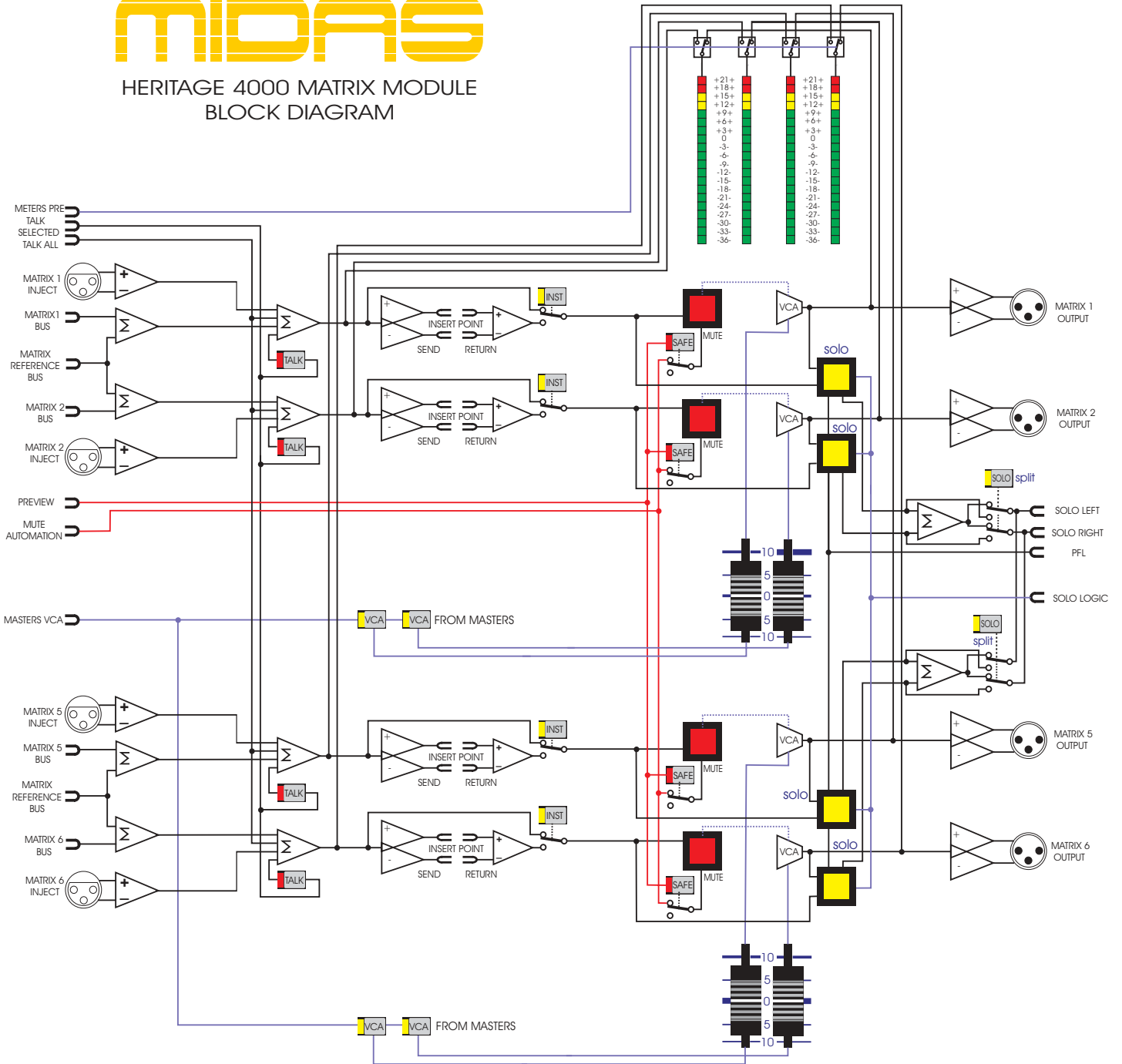



HERITAGE 4000 MASTER MODULE BLOCK DIAGRAM

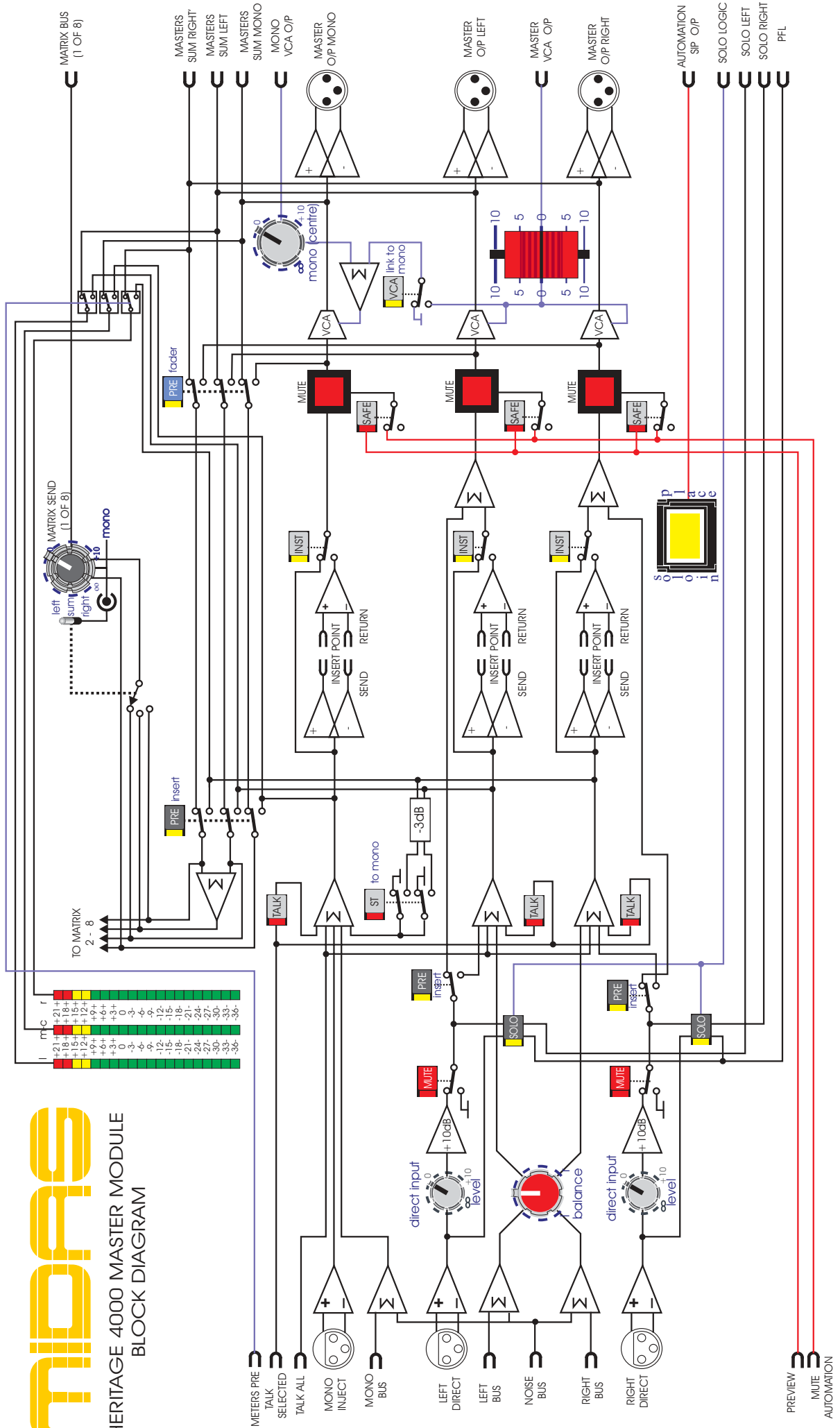

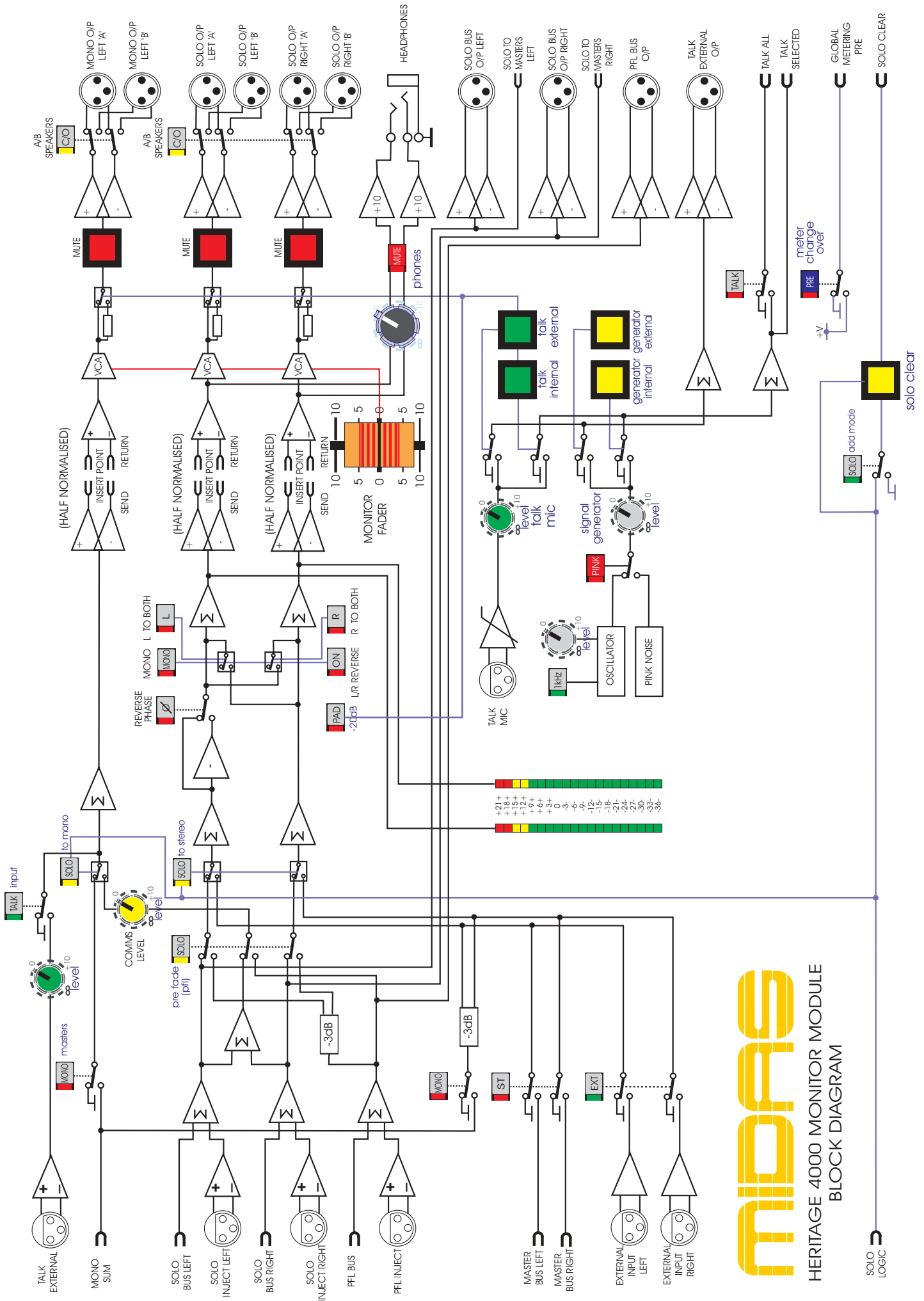

MIOFES

HERITAGE 4000 MONITOR MODULE
BLOCK DIAGRAM



Crib Sheet



Crib sheet
Mono input plus pod
Inputs
_____ to _____

Notes:

channel	channel	channel	channel	channel	channel	channel	channel





Features and Specifications

Technical Specification

Input impedance	Mic Line	2k ohms Balanced 20k ohms Balanced
Input Gain	Mic Mic + Pad Line Level Inputs	Continuously variable +15 to +60 dB Continuously variable -10 to +35 dB 0dB
Maximum Input Level	Mic Mic + Pad Line Level Inputs	+6dBu +31dBu +21dBu
CMR @ 100Hz	Mic (gain +40dB) Mic + Pad (gain 0dB)	Typ. 115dB Typ. 80dB
CMR @ 1kHz	Mic (gain +40dB) Mic + Pad (gain 0dB) Line	> 100dB > 60dB > 50dB
Frequency Response (20Hz - 20kHz)	Mic to Mix (gain +60dB)	+0dB to -1dB
Noise (20Hz - 20kHz)	Mic EIN ref. 150 ohm (gain +60dB)	-128dBu
System Noise (20Hz - 20kHz)	Summing Noise (48 Channels routed with faders down) Line to Mix Noise (48 channels routed at 0dB, pan centre)	-80dB -75dB
Distortion @ 1kHz	Mic to Mix (gain +60dB, 0dBu output)	< 0.03%
Crosstalk @ 1kHz	Channel to Channel Mix to Mix Channel to Mix Maximum Fader Attenuation	< -90dB < -90dB < -90dB > 80dB
Output Impedance	All Line Outputs Headphones	50 ohms Balanced source to drive > 600 ohms To Drive > 8 ohm load
Maximum Output Level	All Line Outputs Headphones	+21dBu +21dBu
Nominal Signal Level	Mic Line Headphones	-60dBu to +10dBu 0dBu +10dBu

Technical Specification

Equaliser

Hi-Pass Slope	12dB / Oct.
High Pass Frequency	Continuously variable -3dB Point from 20Hz to 400Hz
Treble Gain	Continuously variable-15 to +15dB Centre detent @ 0dB
Treble Shelving Freq.	Continuously variable -3dB point from 1kHz to 20kHz
Treble Bell Freq.	Continuously variable Centre from 1kHz to 20kHz
Treble Bell Bandwidth	Continuously variable from 0.1 - 2.0 Octaves Centre Detent @ 0.5 oct
Hi-Mid Gain	Continuously variable-15 to +15dB Centre detent @ 0dB
Hi-Mid Freq.	Continuously variable Centre from 400Hz to 8kHz
Hi-Mid Bandwidth	Continuously variable from 0.2 - 2.0 Octaves Centre Detent @ 0.5 oct.
Lo-Mid Gain	Continuously variable-15 to +15dB Centre detent @ 0dB
Lo-Mid Freq.	Continuously variable Centre from 100Hz to 2kHz
Lo-Mid Bandwidth	Continuously variable from 0.3 - 2.0 Octaves Centre Detent @ 0.5 oct.
Bass Gain	Continuously variable-15 to +15dB Centre detent @ 0dB
Bass Shelving Freq.	Continuously variable -3dB point from 20Hz to 400Hz
Bass Bell Freq.	Continuously variable Centre from 20Hz to 400Hz
Bass Bell Bandwidth	Continuously variable from 0.4 - 2.0 Octaves Centre Detent @ 0.5 oct.

