

**Operators & Service
Manual
XL250**

EVI PRO AUDIO GROUP
Klark Teknik Building
Walter Nash Road, Kidderminster
Worcestershire DY11 7HJ,
England

Tel: (01562) 741515 Fax: (01562) 745371

Contents

MIDAS WARRANTY.....	4
DECLARATION OF CONFORMITY.....	5
XL2552 TECHNICAL SPECIFICATION.....	6
XL2552 STATISTICS.....	8
AN OVERVIEW OF THE CONSOLE.....	10
THE MONITOR CONSOLE.....	12
INSTALLATION.....	14
POSITION.....	14
POWER.....	14
WIRING.....	14
ATTENTION.....	15
MIDAS XL250 APPLICATION NOTES.....	16
IN EAR MONITORING.....	18
CONSOLE LINKING.....	20
USING THE DIRECT OUTPUTS.....	21
USING THE GROUP INSERT POINTS.....	23
USING THE DIRECT INPUTS.....	24
XL250 MODULE DESCRIPTIONS.....	25
XL2501 MONO INPUT MODULE.....	25
CONNECTORS AND PIN DEFINITIONS.....	33
XL2504 STEREO INPUT MODULE.....	34
CONNECTORS AND PIN DEFINITIONS.....	40
XL2511, 2, 3, 4 & 5 MIX GROUP MODULES.....	41
CONNECTORS AND PIN DEFINITIONS.....	45
XL2512 COMMS MODULE.....	46
CONNECTORS AND PIN DEFINITIONS.....	50
POWER SUPPLY CABLE.....	52
XL250 CIRCUIT DESCRIPTION.....	53
EARTHING SYSTEM.....	53
POWER SUPPLY.....	54
MONO INPUT MODULE.....	56
STEREO INPUT MODULE.....	59
QUAD GROUP MODULES.....	61
COMMS MODULE.....	73
SCHMATIC DIAGRAMS	

The information in this manual has been carefully verified and is believed to be correct, however, EVI Professional Audio reserves the right to modify the product described in this manual at any time. This document may not be copied or reproduced by any method whatsoever, whether in part or in whole, without the written permission of EVI Professional Audio.

© Copyright 1997 EVI Professional Audio Group. All rights reserved.

Manual Version ISSUE 1

MIDAS WARRANTY

Midas products are manufactured by Klark Teknik/Midas and are warranted to be free from defects in components and factory workmanship under normal use and service for a period of three years from date of purchase.

During the warranty period Klark Teknik/Midas will undertake to repair or at its option, replace the product at no charge to its owner when failing to perform as specified, provided the unit is returned shipping prepaid to the factory or authorised service facility.

No other warranty is expressed or implied.

This warranty shall not be applicable and be void when the product is subjected to:-

- a) Repair work or alteration by persons other than those authorised by Klark Teknik/Midas in such a manner as to injure, in the sole judgment of Klark Teknik/Midas, the performance, stability, reliability or safety of the product.
- b) Misuse, negligence, accident, act of God, war or civil insurrection.
- c) Connection, installation, adjustment or use otherwise than in accordance with the instructions provided by Klark Teknik/Midas.

Klark Teknik/Midas reserves the right to alter specifications without notice. This warranty does not affect the statutory rights of the UK customer.

Declaration of Conformity

The Manufacturer of the Products covered by this Declaration is



Klark Teknik Building, Walter Nash Road, Kidderminster, Worcestershire, DY11 7HJ.

The Directives Covered by this Declaration.

89/336/EEC Electromagnetic Compatibility Directive, amended by 92/31/EEC & 93/68/EEC
73/23/EEC Low Voltage Equipment Directive, amended by 93/68/EEC.

The Products Covered by this Declaration.

Equipment type	Product Name	Variants
Audio Mixing Console	Q2	Q2 VCA
Audio Mixing Console	Q2 Monitor	Meterbridge
Audio Mixing Console	QMR	Meterbridge
Audio Mixing Console	FMR	
Audio Mixing Console	Forum	PA, Matrix, Mute
Audio Mixing Console	Forum Monitor	Meterbridge
Audio Mixing Console	XL200	
Audio Mixing Console	XL250	

The Basis on which Conformity is being Declared

The products identified above comply with the protection requirements of the EMC Directive and with the principal elements of the safety objectives of the Low Voltage Directive, and the manufacturer has applied the following standards:
EN 55013: 1990

Limits and methods of measurement of radio disturbance characteristics of Broadcast Receivers and Associated Equipment.

EN 50082-1: 1992

Electromagnetic Compatibility - Generic immunity standard

Part 1. Residential, commercial and light industry.

EN 60065: 1994

Safety requirements for mains operated electronic related apparatus for household and similar general use.

The technical documentation required to demonstrate that the products meet the requirements of the Low Voltage Directive has been compiled by the signatory below and is available for inspection by the relevant enforcement authorities.
The CE mark was first applied in 1996

Signed:

A handwritten signature in black ink, appearing to read "G.M. Squires", written over a horizontal line.

G.M.Squires

Authority: Product Support Manager.

Date: 1st, January 1997.

Attention

The attention of the specifier, purchaser, installer, or user is drawn to special measures and limitations to use which must be observed when these products are taken into service to maintain compliance with the above directives. Details of these special measures and limitations to use are available on request, and are also contained in product manuals.

XL2552 TECHNICAL SPECIFICATION.

Input Impedance

Mic	2K Balanced
Line	20K Balanced

Input Gain (all faders at 0dB)

Mic	Continuously variable + 15dB to + 60dB
Mic + Pad	Continuously variable - 10dB to + 35dB
Line Level Inputs	0dB

Maximum Input Level	Mic	+ 6dBu
	Mic + Pad	+ 31dBu
	Line Level Inputs	+ 21dBu

CMR at 1KHz	Mic (gain + 60dB)	> 80dB
	Mic + Pad (gain + 10dB)	> 55dB
	Line	> 50dB

Frequency Response (20 to 20KHz)	Mic to Mix (gain + 60dB)	+ 0dB to - 1dB
-------------------------------------	-----------------------------	----------------

Noise (20 to 20KHz)	Mic EIN ref.	
	150 Ohms (gain + 60dB)	- 129dBu
	Mic + Pad EIN (gain + 10dB)	- 98dBu

System Noise (20 to 20KHz)

Summing Noise (12 channels routed with faders down)	- 83dBu
Line to Mix Noise (12 channels routed at 0dB, pan centre)	- 80dBu
Summing Noise (52 channels routed with faders down)	- 82dBu
Line to Mix Noise (52 channels routed at 0dB, pan centre)	- 75dBu

Distortion at 1KHz

Mic to Mix (+ 60dB gain, 0dBu output)	< 0.03%
---------------------------------------	---------

Crosstalk at 1 KHz

Channel to Channel	< - 90dB
Channel Mute	< - 80dB

Output Impedance

All Line Outputs	
50 Ohms Balanced Source to drive	> 600 Ohms
Headphones to drive	> 8 Ohms

Maximum Output Level

All Line Outputs	+ 21dBu
Headphones	+ 21dBu (8W into 8 Ohms)

Nominal Signal Level	
Mic	- 60dBu to + 10dBu
Talk Mic	- 50dBu to - 20dBu (auto gain)
Line Inputs and Outputs	0dBu
Headphones	+ 10dBu
Headroom at all stages	Headphones >10dB
All other signals	>20dB
Input Metering	
Type	10 led peak reading plus signal present
Range	- 25dBu to + 15dBu
Colour Green	Up to + 6dBu Normal signal
Colour Yellow	+ 9dBu to + 12dBu High signal
Colour Red	Over + 15dBu Signal Very High
Quantity	48
Output Metering	
Type	20 led peak reading
Range	- 36dBu to + 21dBu
Colour Green	Up to + 9dBu Normal signal
Colour Yellow	+ 12dBu to + 15dBu High signal
Colour Red	Over + 18dBu Signal Too High
Quantity	22
Equaliser	
Hi pass slope	12dB / Oct.
Hi pass frequency	Continuously variable 20Hz to 400Hz
Treble Gain	Continuously variable + 15 dB to - 15 dB Centre detent = 0dB
Treble Shelving Freq.	Continuously variable - 3dB point from 1K to 20K
Hi Mid Gain	Continuously variable + 15 dB to - 15 dB Centre detent = 0dB
Hi Mid Freq. Hi Mid Bandwidth	Continuously variable centre 400Hz to 8K Continuously variable from 0.1 Oct. to 2 Oct.
Lo Mid Gain	Continuously variable + 15 dB to - 15 dB Centre detent = 0dB
Lo Mid Freq. Lo Mid Bandwidth	Continuously variable centre 100Hz to 2K Continuously variable from 0.1 Oct. to 2 Oct.
Bass Gain	Continuously variable + 15 dB to - 15 dB Centre detent = 0dB
Bass Shelving Freq.	Continuously variable - 3dB point from 20Hz to 200Hz

XL2552 STATISTICS.

1. The XL250 is a 23 bus console as follows:-

2 mono aux	=	2
16 stereo or mono configurable groups	=	16
1 stereo master	=	2
1 stereo AFL	=	2
1 mono PFL	=	1
TOTAL	=	23

2. The XL250 has 8 automute group buses.

3. The XL2552 has 52 input channels plus an additional 20 direct inputs on the group modules.

4. The XL2552 has a total XLR input count of 77 as follows:-

52	channel mic inputs
20	group direct inputs
3	solo bus inject inputs
1	talk mic input
1	talk bus inject input

5. The XL2552 has a total XLR output count of 70 as follows:-

44	input channel direct outputs
2	aux outputs
16	configurable group outputs
2	stereo master outputs
3	solo outputs
2	local outputs
1	talk output

6. The XL2552 has a total of 144 balanced 1/4 inch jacks for inserts follows:-

52	input channel insert sends
52	input channel insert returns
2	mono aux insert sends
2	mono aux insert returns
16	configurable group insert sends
16	configurable group insert returns
2	stereo master insert sends
2	stereo master insert returns

7. The XL2552 has a total of 70 peak program meters with:-

20	LED segments on outputs
11	LED segments on inputs

8. XL2548 Dimensions:-
1736mm width
930mm depth
260mm height

9. XL2548 Weight:- 125Kg/276lb net weight
250Kg/551lb shipping weight

AN OVERVIEW OF THE CONSOLE

The XL250 is an extremely flexible and truly “multi-functional” console which can be re-configured in seconds for applications such as in ear monitoring, wedge monitoring, front of house use and many more.

The XL250 features a new microphone amplifier giving excellent CMR, noise and distortion performance using a constant HF bandwidth topology assuring excellent amplifier stability and RF rejection at all gains. All inputs are fully balanced and are both differential and common mode impedance matched.

The responsive control, character and sonic performance of the legendary XL3 equaliser are maintained in full including parametric mid’s and traditional Midas swept shelving treble and bass. Each channel has a half normalised fully balanced insert send and return point which can be switched in or out and positioned either pre or post equaliser from the front panel.

Peak reading input meters monitor the pre fader signals and cover a 40dB range from +15dBu downwards in ten 3dB steps with a signal present indicator at -25dBu.

Every input module is fitted with a direct output as standard with its own level control and front panel switch to select either the pre fader signal or the pre insert and pre equaliser signal. This provides a valuable output feed for effects, broadcast or recording.

The XL250 has 4 fixed buses, 2 of these are intended for use as mono auxiliary buses while the other pair are the stereo master bus. The auxiliary buses have independent on/off switching and pre/post fader switching. The remaining 16 buses are configured on a bus by bus basis as mono or stereo mixes. The channel mix controls that feed these buses automatically change from level + level to level + pan under the control of a switch on the group modules. As an extreme this gives 18 independent mono buses with a stereo master bus or 2 mono aux buses with 9 independent stereo buses. Dual concentric type controls have not been used on any of the bus sends in order to simplify adjustments and the viewing of relative levels within the mix. All the configurable mix sends feature independent on/off switching and pre/post fader switching.

The 20 mix groups feature 100mm faders and can be used directly as speaker outputs or as audio sub groups with groups 1 to 18 feeding the stereo master (groups 19 and 20) via individual pan controls and on/off switches. Each mix group also has a direct input with a level control which can be routed into the mix group either pre or post the insert point. This can be used to link consoles, return effects and to bring in sub mixes or taped material.

All outputs including the insert sends can drive large capacitive loads and feature semi-floating fully balanced circuits which are both differential and common mode impedance matched. All the mix group outputs are monitored post fader by 20 led peak reading meters which cover a 60dB range in 3dB steps.

The XL250 has 8 automute masters. They can be assigned to any input or group and act on the pre fader and post fader signals. The mute groups can overlap and allow easy muting of unwanted instruments during a performance. Each module has a safe switch which can be used to over ride the automute system without de-assigning the module or group.

There is an advanced solo system which operates in two main modes — auto cancel and input priority add mode. The auto cancel mode allows fast access to channels and groups by removing the need to cancel previous solos. The add mode allows the building of solo scenes when many solos can be placed on to the solo buses at the same time — inputs are given priority over groups, i.e. any active input channel solo will temporarily override an active group solo. In auto cancel mode, stereo and other multiple channels or groups can be soloed together providing they are switched on at the same time. This saves switching back

and forth between the two modes. In either mode the solo switches are only latching in operation if they are pressed for under a second, if they are held for longer than this they unlatch and the solo will cancel when the switch is finally released. The solo system can operate as PFL mono, AFL stereo or solo in place which operates on the stereo master output.

The talk system is very simple, fast and flexible — one button press selects the source from a choice of talk mic, pink noise generator, swept oscillator or external input; a second button press routes the signals to any of the mix outputs. An external output is also provided to connect to other systems. Internal console signals can be monitored via a powerful 8 watt headphone amplifier or via speakers under control of the 100mm local output fader.

THE MONITOR CONSOLE

The role of the monitor console is fundamentally different from that of the front of house console in that it must produce a large number of distinct mixes of equal relative importance. In contrast the front of house console produces one main mix with several, arguably less important, mixes for sending to effect units. The XL250 console has the capacity to produce a maximum of 20 mixes which are in effect the group outputs of the console.

Why the need for a monitor console in the first place ?

Before the advent of large public address (P.A.) systems bands would have the instrument amplification behind them and everyone on stage would have the ability hear at least a rough mix of the sound. As more and more instruments began to be put through the increasingly large P.A. systems then the soundfield on stage became less representative of what was really happening "out front". Loudspeakers were then required on stage to recreate the sound lost from the instrument amplifiers. A further refinement of this idea meant that musicians could be provided with individual monitor feeds by having their own wedge which would be supplied with a mix adjusted to the specific requirements of the player.

It is important for the monitor engineer to have a local monitor, usually a wedge, allowing access to the stereo mix and any solos. The solo function is critical in allowing the monitor engineer to adjust individual monitor mixes. To aid the engineer the solo system has input priority meaning that if an input solo is selected while an output solo is active the output solo will be suspended. When the input solo is cancelled the output solo is returned to the local monitor output. This allows quick and intuitive operation with a useful reduction in the number of button pushes required.

Stereo or mono ?

Until the advent of in ear monitoring mono monitor feeds were adequate. With the introduction of in ear wireless systems stereo mixes were required and this facility had to be available on the monitor console. The XL250 allows 16 of the monitor sends to be switched between mono and stereo operation.

Routing

The routing on the monitor console is more akin to the auxiliary send facility of other consoles as it is usually done with rotary potentiometers and switches. The potentiometers are used to create the mix to a monitor send or group output. Thus a monitor console is likely to have a large number of knobs.

Pre or Post fade ?

The monitor feeds are usually taken pre fade as they can then be independently adjusted. If required they can be selected post fade although they will then be dependent on the channel fader. The DIRECT OUTPUT has several links associated with a PRE switch giving a choice of signals that can be selected.

Insert Points

The monitor outputs are equipped with insert points allowing the insertion of equalisers and other equipment into the monitor output signal path. This has a great advantage over the more conventional approach of placing this equipment in between the monitor output and the power amplifier as it allows the effect to be soloed by the monitor engineer. It can thus be accurately set up without the need for semaphore signals from the stage area !

Meters

All monitor outputs are metered to show the level from that output. Peak meters give a truer indication of the actual signal level and this means that the signal can be run "hotter" than with VU meters. This improves

the signal to noise ratio of the console.

Auxiliary Functions

The monitor console may also have to perform other functions including splitting the microphone feeds from the stage to send to the front of house console. If this was not the case two microphones would be required - one feeding the front of house console and the other feeding the monitor console. The channel direct outputs can be used for this purpose

INSTALLATION

There are a number of points to consider when installing a mixing console. Many of these points will have been addressed before the console is even unpacked but it is worth repeating them again.

POSITION

The console should be located in a convenient space commensurate with the use to which the console is being put. Ideally a cool area is preferred not in close proximity to power distribution equipment or other potential sources of interference. Provision should be made for some flat surface surrounding the console to prevent people using it as a table top. One of the worst fates that can befall a console is for a cup of coffee to be tipped into it by someone resting it on the control surface!

POWER

The power supply should be located as far from the console as the connecting cable will allow. It should be set for the appropriate line voltage and plugged into the mains outlet using the supplied cable.

WIRING

The console uses three different connector styles:-

TRS jack sockets, XLR male connectors and XLR female connectors.



1/4 INCH TRS 'A' GAUGE JACK PLUG

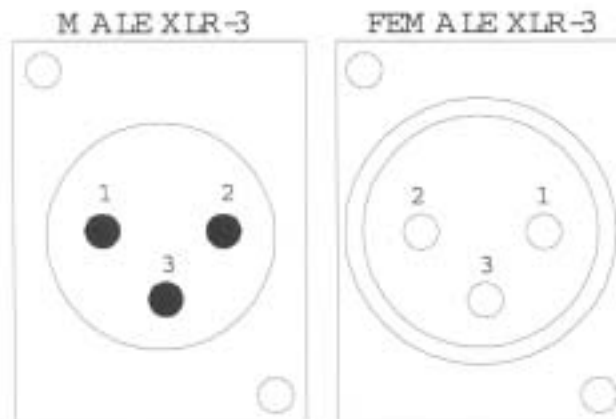

The cables used should be of as high a quality as possible. Many installation problems can be traced back to poor or faulty cables and connectors.

There are two different conventions for the wiring of XLR connectors. The international convention uses pin 2 as the hot pin while the older American convention uses pin 3 as the hot pin. When going from balanced input to balanced output this is of little consequence but when unbalanced signals are used then phase reversal can result. The XL250 is wired PIN 2 HOT for XLRs and TIP HOT for TRS jacks.

ATTENTION

The following special limitations apply to the console and must be observed in order to maintain safety and electromagnetic compatibility performance.

POWER CONNECTION

The console should only be operated with the power supply connected to ground via its mains supply connector.

CONTROL CONNECTIONS

The connections should only be operated with high quality screened control cables. All connector shells should be of metal construction so that they provide a screen when they are plugged into the console. All D type connector shells shall be connected to the cable screen. All XLR and DIN connectors should have pin 1 connected to the cable screen.

AUDIO CONNECTIONS

The console should only be operated with high quality screened twisted pair audio cables. All connector shells should be of metal construction so that they provide a screen when they are plugged into the console. All D type connector shells shall be connected to the cable screen. All XLR and DIN connectors should have pin 1 connected to the cable screen.

ELECTRIC FIELDS

If the console is operated in an electromagnetic field that is amplitude modulated by an audio frequency signal, the signal to noise ratio may be degraded. Degradation of up to 60dB may be experienced under extreme conditions (3V/m, 90% modulation)

MIDAS XL250 APPLICATION NOTES.

Audio Levels and General Gain Structure.

Audio manufacturers often quote professional signal levels as "+4dBu" and semi-pro or domestic equipment as "-10dBV". To complicate matters some console manufacturers quote signal levels for main outputs as "+4dBu" and chose to reduce this to "-2dBu" for all insert points. Other manufacturers quote "sensitivity" for mic amplifiers referring the input to 0dBu whilst referring the output to +4dBu. This means for a typical microphone the mic amp could be set to -36dB sensitivity while the actual mic amp gain measured at the output would be +40dB. This is all very confusing and the reasons behind it are many and varied, the +4dBu reference probably originates from the use of VU meters which give a reading of 0VU if a 1KHz sine wave signal is connected at +4dBu.

Typically consoles are not used to mix 1KHz sine waves and this is why Midas has not adopted the +4dBu VU standard. This does not mean that Midas consoles can not operate at +4dBu — what it means is that we give the operator the control to set up and monitor signal levels that best match the system requirements. To do this all Midas XL Consoles adopt a simple and understandable UNITY GAIN STRUCTURE with all controls marked in dB to indicate RELATIVE GAIN not absolute signal level. This means that when all controls are set to 0dB any signal that enters the console will exit the console at the same level — if an input is +4dBu the output will be +4dBu, if an input is +10dBu the output will be +10dBu.

Headroom and Peak Metering.

Accurate metering is essential in order to control gain and headroom within the console and the audio system. VU meters are not suitable for this application as they are very slow to respond and do little more than indicate signal present or to be precise signal present half a second ago. Many transient signals that can clip internal circuits will go unnoticed on a VU meter while constant low crest factor signals may show the VU in the red when there is still ample headroom to spare. Experienced operators can compensate for this to a large extent as they instinctively know the transient nature of most signal types. However this still leaves much of the system gain and headroom to speculation.

The only way to view signal levels and available headroom accurately is to use peak responding meters. All Midas XL Consoles feature 20 LED peak responding meters on the outputs which cover a 60dB range right up to the console maximum signal level of +21dBu. Output operating levels can be safely taken up to +15dBu whilst still retaining 6dB of headroom. If the system crossovers, amplifiers and speakers are calibrated to reach overload or limiting at the same maximum signal level as the console. The meters are then giving accurate headroom information for the entire system and not just the console.

The XL250 input channels are equipped with peak responding 11 LED meters covering a 40dB range (including the signal present indicator) up to +15dBu. The maximum channel signal level is again +21dBu, however it may be prudent to run the channel at a lower level than the outputs to allow additional headroom for equalisation and input high pass filtering. An indicated peak level of +12dB would still leave 9dB of headroom. The channel input amplifiers have additional headroom and can accept signals up to +31dBu when padded which should allow connection to the hottest of signals without problems.

Audio Signals and Technical Specifications.

With constant sine wave signals VU readings of 0dB will correspond with peak meter readings of +4dBu (just over the 3dB LED), however with typical music source material VU readings of 0dB will correspond with peak meter readings of approx. +15dBu. VU meters are however still extensively used to indicate the loudness of a signal where their slow response is preferable.

All Midas performance specification measurements are quoted relative to 0dBu — not because this is the

intended console operating level but because 0dBu is an international standard for equipment measurement (0dBu represents 0.775 Volts which is the voltage developed across a 600 ohm resistor when dissipating 1mWatt of power). Headroom is quoted as the level available above this reference and noise measurements are quoted as a level below this point. The subtraction of noise from headroom will give available dynamic range (noise is quoted in negative dB so the two numbers should actually be added). Headroom and noise performance during real use will be dependant on the operating signal levels that are chosen, however peak readings of 0dBu should be considered as the very lowest of signal levels that are acceptable for professional performance.

Mono Mix Gain Structure.

Buses are used to route input signals to outputs and normally involve addition of several or many inputs to one output. Once again there is a difference in the way genuine audio signals combine when compared to test tones. When two coherent test signals are added together the resultant signal is 6dB higher than the inputs, when four signals are added together the resultant signal is 12dB higher. This pattern continues thus:- 8 inputs give +18dB, 16 inputs give +24dB, 32 inputs give +30dB and 64 inputs giving +36dB.

Fortunately real audio signals are not at all coherent and are either transient, occurring at different points in time, or partially cancel in the summing process due to phase and frequency differences. Music instrument material typically mixes to give a 6 to 9dB increase in level when 48 inputs are summed together. To compensate for this some console manufacturers reduce the gain of their summing amplifiers by 6dB which is why they often quote their inserts as -2dBu as opposed to the main inputs and outputs at +4dBu. This can however be confusing especially when small numbers of inputs are routed through a sub group and appear to have lost 6dB in signal level.

The Midas UNITY GAIN STRUCTURE gives control back to the operator. If only one or two signals are to be summed together the operator can set the nominal send gain from each input channel to approx. 0dB, i.e. 2 o'clock position. If many inputs are being summed, as in audio sub group applications, the nominal send gain can be reduced a little and when all 48 inputs are routed, as in monitor applications, the send levels can be set down to approx. -6dB, i.e. 12 o'clock position. When compared with the maximum possible bus send gain of +6dB this set-up gives 12dB of in hand gain which may be useful for artists requiring extreme mix balances. All the suggested nominal send positions will need to be fine tuned to produce the final mix/mixes but their use as a starting point will give optimum gain structure within the console and provide more consistent levels for outboard equipment.

Stereo Mix Gain Structure

When operating in stereo the nominal send pot positions can be similar to those used for mono busses however the actual levels sent are also effected by the pan pot which has a 3dB loss in it's centre position. If only one or two signals are to be sub grouped together they will probably be panned hard apart and the nominal send gain can be set to 0dB, i.e. 2 o'clock position (as per mono mix above). If many inputs are to be sub grouped together some of them will typically be panned towards the centre. This will provide some level drop and keep the gain structure close to ideal. When all 48 inputs are routed, as in monitor applications, the inputs that are centre panned typically generate a 2dB loss in level across the bus. In order to maintain an ideal gain structure a further 4dB gain reduction is required which can be achieved again by setting the nominal send pot positions to 12 o'clock (the law of the stereo gain pots has been chosen to give -4dB at this point as opposed to -6dB for the mono sends).

When generating a monitor mix on the stereo master buses the same nominal gain reduction can be used — setting the faders to just above the -5dB line will typically give the best internal gain structure. This complicates matters a little when other mixes are sent post fader because the nominal send pot gain reduction is now no longer required; i.e. the send pot position should be at 0dB which is the 2 o'clock position.

IN EAR MONITORING

If an artist does not receive the correct foldback or monitor mix then the performance of that artist may suffer, consequently the foldback or monitor mix is much more important than might at first be imagined. The balance of the performer to the rest of the ensemble in the monitor mix must be correct otherwise pitching difficulties may be encountered while a lack of ambience or reverberation can also affect the amount of life that a performer is able to inject into a performance. It is also easier to follow a beat when the rhythm instruments are in mono. Traditional monitoring relies on stage mounted loudspeakers usually fed from mono signal sources and although supplying the artists with the required foldback there are many drawbacks. Not least is the high level of sound on stage which can interfere with the front of house sound and introduce feedback.

In ear monitoring was developed in the late 1980's to overcome some of the problems inherent with traditional stage monitoring practices. Usually a number of Wedge Monitor Speakers are used, one positioned in front of each artist, and fed with a mix adjusted to the requirements of that artist. Thus on a busy stage there could be as many as 16 wedges all carrying different mixes. In addition there may even be sidefills to give coverage of the stage area with no wedges facilitating movement of the artists without losing their monitor feed. It can be deduced that the stage, under these circumstances, can be a very noisy area with a great deal of interaction occurring between the different monitor mixes. The monitor engineer may have to constantly adjust several monitor mixes in order to track an artist moving around the stage.

There are several problems here.

- Health and safety - whereby the artists are being subjected to high sound pressure levels
- Imprecision of the monitor mix actually received by the artist
- The sound on stage increases the risk of feedback and will also spill to affect the front of house sound.
- Distortion from the monitor loudspeakers entering the microphones which feed the front of house system which reduces the clarity of the sound.

While the monitor engineer has the ability to solo a monitor mix on his console this does not necessarily coincide with the mix heard by an artist on stage who is probably receiving spills from other monitor mixes in addition the intended one. In ear monitoring addresses these concerns by providing a barrier to external sounds thus enabling the artist to hear a much more precise monitor mix.

As the mix is now heard in comparative isolation the monitor engineer then has a much clearer idea of what the artist is receiving and consequently can adjust the mix much more precisely. In fact the monitor engineer may have his own in ear system allowing auditioning of precisely the same signal as is sent to an artist.

In ear monitoring uses the good fit of the earpieces to provide a high degree of attenuation to external sounds. In top flight systems the earpieces can be custom moulded to the exact shape of an artist's ear. Bone conduction will obviously not allow sounds to be completely attenuated but it will be sufficient to enable a monitor mix to be accurately heard while attenuating other sounds. It can be expected that the monitor sound will now be at a lower level than that coming from a wedge. Some artists, notably bass players and drummers like to "feel" the sound, sometimes referred to as "trouser flapping", and this is one area where in ear monitoring cannot compete. In these instances a sub woofer can be supplied feeding the low frequencies to the performer. For a drummer the sub woofer could be placed under the drum riser while a bass player could stand close to, or even upon, his instrument's loudspeaker cabinet. It is even

possible to buy a drum stool with built in loudspeaker.

One of the great advantages of radio links is the mobility they bestow and a combination of in ear monitoring with a radio microphone allows a performer to go virtually anywhere within a performance area. This not only improves the lot of the monitor engineer by reducing the workload but also dramatically improves the quality of the monitor sound received by the artist improving in turn the quality of their performance.

As with everything in life there are a number of basic rules to be followed for optimum results and these can summarised as follows.

Never try and set up the system on a new user. This is akin to equalising a monitor wedge with an artist standing in front of it. They do not like it !

Always start with the simplest mix you think you can get away with and run the system as quietly as possible. This way the artist can cue from the mix and blend into the ambient sound of the band. Add more into the mix as you acquire confidence.

Add some reverberation - a dry sound is very unnatural. As a starting point try using the large room or small hall settings at 1.6 seconds reverberation with the sibilance taken out. Reverberation can be of great benefit when assisting those with pitching difficulties.

Try to maximise the signal into the system without overloading it.

Retain line of site paths between transmitters and receivers for best reception.

The last two points will help maintain the signal to noise ratio of the wireless link.

There is a psycho-acoustic phenomenon whereby the person making a sound perceives that sound as quieter than another person hearing it (the Stapedius muscle reflex). This often accounts for the volume battles between musicians on stage. In setting up your mix, the ratio of a voice to the backing mix for example, will be much higher than you would normally expect. Keep the backing mix low and the vocals well out in front.

Many singers more to used to working with wedges can be overcome by the power of in ear monitoring. Consequently they sing more quietly, which although beneficial for their voice, can sometimes lead to front of house gain problems. The solution here is to turn the monitor level down either at the belt pack or at the input to the system.

Be aware that any adjustments made to the monitor mix will be clearly heard - do not change the mix unless you absolutely have to.

Many thanks to Garwood Communications Ltd., makers of the RADIO STATION In Ear Monitoring System, for the above information.

CONSOLE LINKING

There are circumstances where one console is insufficient to meet the requirements of a contract and the XL250 allows consoles to be used in a master/slave configuration in order to increase the effective console size. Each console is equipped with two connectors, one labelled MASTER and the other SLAVE. These connectors link the the control signals for the automute buses and the solo systems between the two consoles. Audio from the slave console can be brought in to the master console through the group direct inputs and mixed with other signals assigned to the same group on the master console. Input signals on the slave console can be soloed and will be heard on the master console as though they had originated there.

To connect two consoles for linked operation do the following.

- 1 Connect the group outputs of the slave console into the direct group inputs of the master console.
- 2 Connect the solo outputs of the slave console to the same solo inputs on the master console.
- 3 Connect the MASTER DC connector on the master console to the SLAVE DC connector on the slave console.
- 4 Adjust the group output levels on the slave console to a reasonable level and use the direct input level control to trim the level onto the mix buses of the master console. The direct input should be set to PRE unless you specifically want the slave signal to bypass the group insert point.

If the number of monitor buses is insufficient then it is possible to link the consoles by using the direct outputs from the master console to feed into the channel inputs of the slave console. Rather than increasing the number of available inputs as the first method does this method increases the number of monitor sends as there are now a similar number of sends on the slave console. The second console need not be an XL250 of course and a smaller console such as the DDA CS12M could easily be used in this situation.

USING THE DIRECT OUTPUTS

Every input channel has a direct output which has a level control and a PRE switch. The signal from the direct output depends on the position of the PRE switch, SW20 and a number of internal links as follows :-

Position of SW 20	Standard Links A. & C	Option Links A. & D	Option Links E. & D
PRE	Pre. EQ. and INS	Pre. EQ. and INS	Pre. fader (post. EQ. and INS)
POST	Post. EQ. and INS	Post. fader	Post. fader

The direct output can be put to many uses and a brief description of some is given in the following.

There are instances where a performance has to be recorded. Using any of the mix outputs would give a signal to tape but generally a monitor mix bears no relationship to that of a recording mix. The direct channel outputs enable the signals from each input to be assigned to the different tracks of a multi track tape recorder giving independent adjustment of each signal level.

When the XL250 is used in conjunction with a front of house (FOH) console the direct outputs may be used as microphone splitters. Thus the signal from the direct outputs can be fed to the inputs of the FOH console. The FOH engineer will probably want a PRE signal although any adjustment of the channel input gain on the monitor console will be seen on the FOH console. In practise this should not present a problem as the gain control is usually preset for a certain input signal.

The direct output can be used in conjunction with the group insert point or direct input to create a special effect or equalisation for one particular monitor feed. Normally the signal being sent to all sends from one input module will have the same equalisation applied to it. Should an artist want a different equalisation then signal can be taken from the direct output, fed through an equaliser (or effect) and returned to the group direct input where it is mixed with the remainder of the signals for that monitor feed.

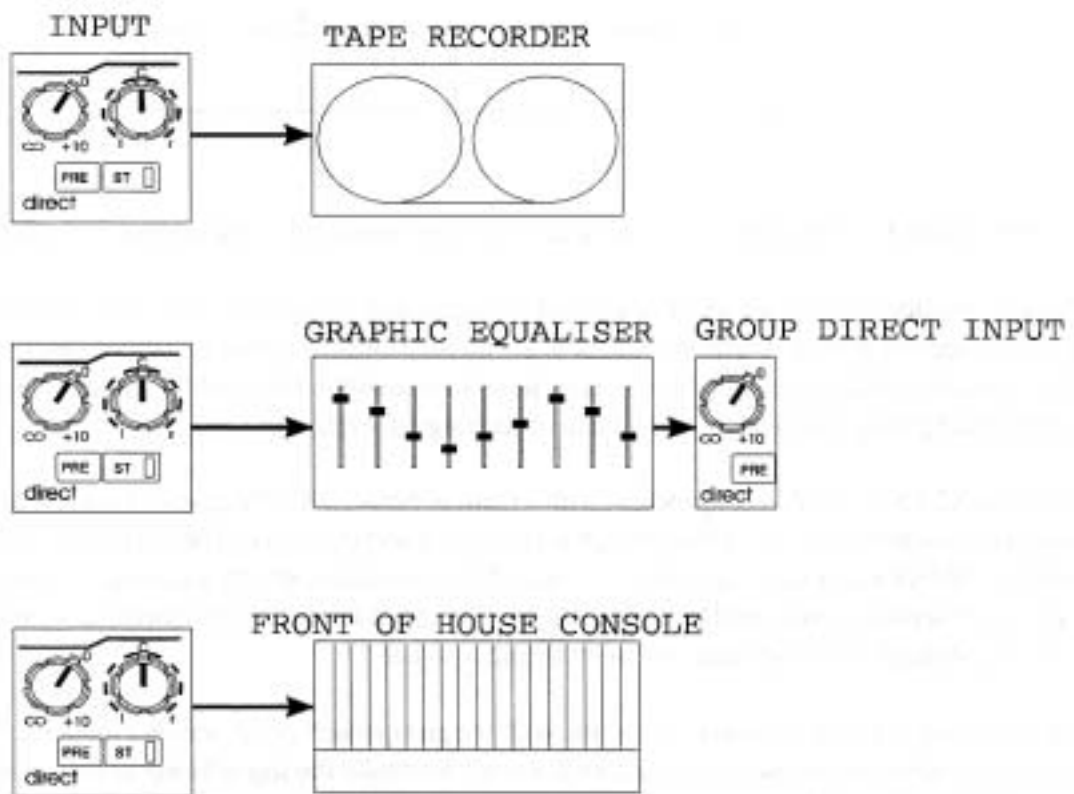

USING THE GROUP INSERT POINTS

The group insert points are positioned in the group signal path immediately after the group summing amplifier. The insert send is always active and can be used as a feed of the mixed group signal. The insert return must be selected by the INS switch. If nothing is plugged into the insert return then the group signal will still pass through as the jacks are half normalised. If an equaliser is plugged in then the group signal will be equalised before passing to the fader and hence to the group output.

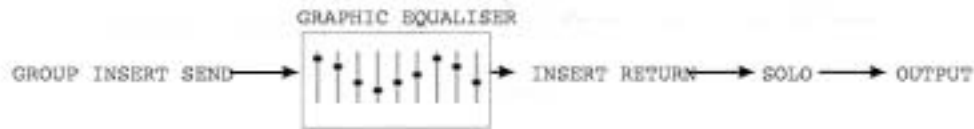

The major benefit of this is of course that the group signal can be soloed and any changes to the equalisation checked. The group meters will also show the level of the equalised signal. The alternative might be having the equaliser located between the group output and the power amplifier. It would not then be possible to check the equalisation by using the solo system and there may be noise problems as the equaliser signal level will be dependent on the group output fader.

USING THE DIRECT INPUTS

The direct inputs can be used to bring in signals from a slave console or return the output of an effect unit into the console. Any signal will only be returned to the group whose return is being used — if it is required to return it to many groups then it must be assigned through an input module, usually a stereo input module, to those groups.

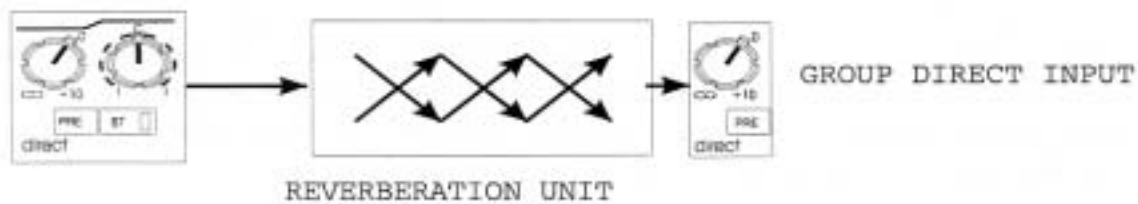
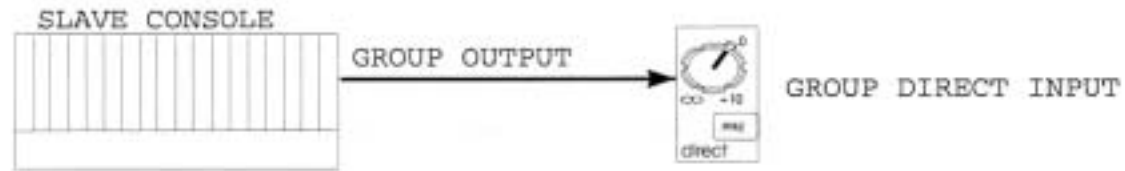

One advantage of returning the signal from a reverberation device through the direct input is that the direct input level control can be used to adjust the amount of reverberation mixed in with the original signal. This adjustment could of course be made on the reverberation device but the operation is made much simpler and faster if it can be located on the console in front of the engineer.

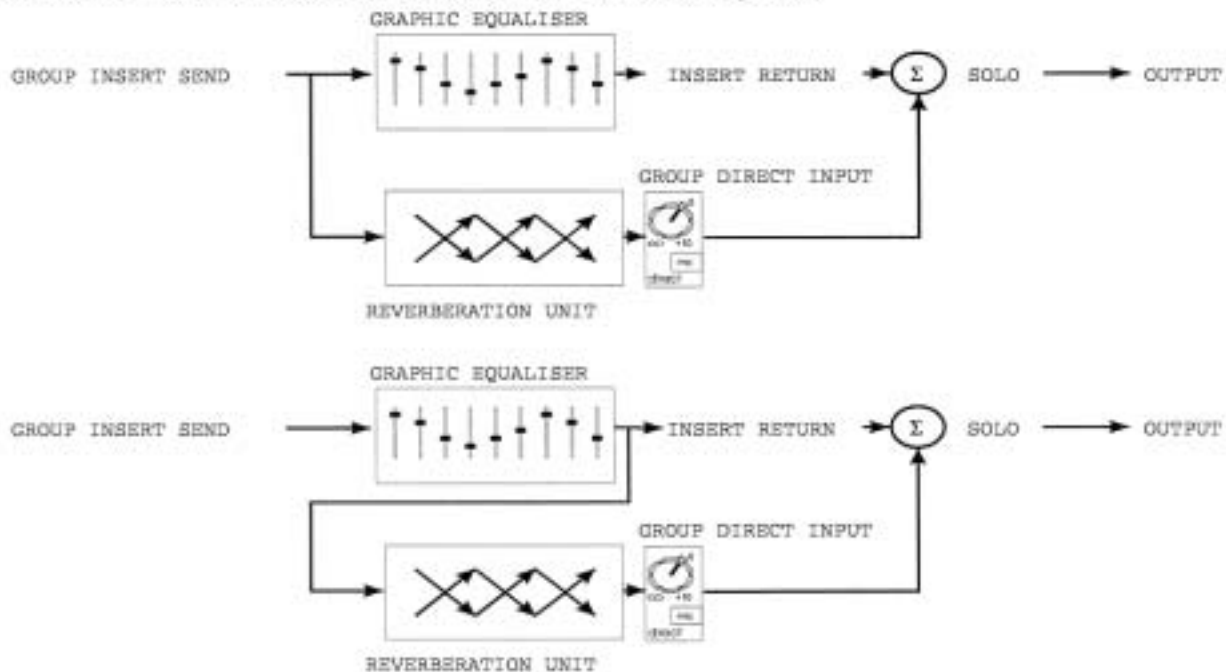

If the total group signal is having reverberation added and the insert point is also required the send cable can be split so that it can drive both the equaliser and the reverberation unit as in the examples above.

XL250 MODULE DESCRIPTIONS

XL2501 MONO INPUT MODULE.

The input module accepts either microphone (low level) or line (high level) signals. After being unbalanced and shifted to a suitable level for the console electronics the signal is passed through a four band equaliser section and from there through the channel fader to be sent to the monitor send buses.

There are 20 possible buses that the signal can be routed to with buses 1 and 2 fixed as mono only and 19 and 20 are reserved as the main stereo bus of the console. The remaining sends can be used as mono sends or linked to be used in pairs as stereo sends.

There is a channel direct output which can be selected either pre or post equaliser and insert point with a level control. This can be used to feed a tape recorder in situations where a multi track recording of an event is required or could be used to feed the input of either the front of house console or another monitor console when the number of monitor sends required exceeds the capacity of the first console.

There are eight automute buses to which the channel can be assigned. An eleven segment meter indicates the channel signal level and there is a MUTE and a SOLO switch.



THE INPUT SECTION

PHASE

The PHASE switch reverses the phase or more accurately the polarity of the input signal. This can be used in situations where the polarity of a signal is reversed with respect to all others due to cable wiring or some other cause.

GAIN

The GAIN control gives continuous adjustment of the input amplifier gain from +15dB to +60dB.

PAD

The PAD switch gives 25dB of attenuation to the input signal which will allow the connection of high output microphones or line level signals. If the input amplifier is transformer coupled (option) the pad greatly reduces the risk of saturation at very low frequencies.

48V

The 48V switch connects 48 volt phantom power to the input connector which is suitable for a condenser microphone or DI box.

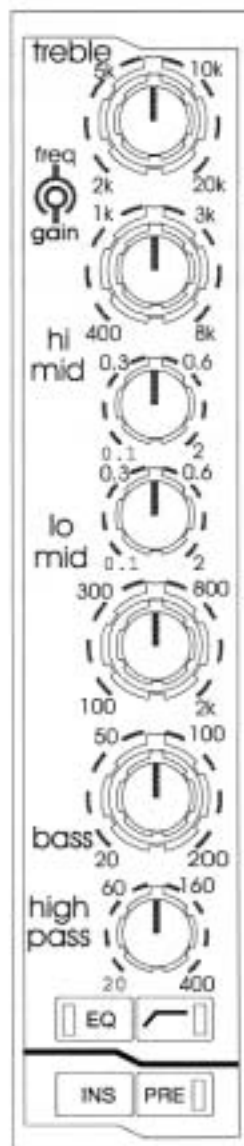

THE EQUALISER

TREBLE (dual concentric top)

This provides up to 15dB of boost or cut at a frequency between 2kHz and 20kHz with a shelving response.

FREQ (dual concentric bottom)

The treble FREQ control gives continuous adjustment of the frequency range that the treble equaliser acts on from 2kHz to 20kHz.

HI MID (dual concentric top)

This provides up to 15dB of boost or cut at frequencies between 400Hz and 8kHz.

FREQ (dual concentric bottom)

The hi-mid FREQ control gives continuous adjustment of the frequency range that the hi-mid equaliser acts on from 400Hz to 8kHz.

WIDTH

The hi-mid WIDTH control gives continuous adjustment of bandwidth from 0.1 to 2 octaves with a 0.4 octave centre point.

WIDTH

The lo-mid WIDTH control gives continuous adjustment of bandwidth from 0.1 to 2 octaves with a 0.4 octave centre point.

LO MID (dual concentric top)

This provides up to 15dB of boost or cut at frequencies between 100Hz and 2kHz.

FREQ (dual concentric bottom)

The lo-mid FREQ control gives continuous adjustment of the frequency range that the lo-mid equaliser acts on from 100Hz to 2kHz.

BASS (dual concentric top)

This provides up to 15dB of boost or cut at a frequency between 20Hz and 400Hz with a shelving response.

FREQ (dual concentric bottom)

The bass FREQ control gives continuous adjustment of the frequency range that the bass equaliser acts on from 20Hz to 400Hz.

HI PASS (CONTROL)

The hi pass filter control is continuously adjustable from 20Hz to 400Hz. When used in conjunction with the High Pass Switch it can be used to tune out unwanted sounds.

HI PASS (SWITCH)

This places the high pass filter in the input channel signal path before the insert point and equaliser. It can be used for removing low frequency sounds such as those transmitted through a stage and up the microphone stand.

EQ

The EQ switch places the equaliser in the input channel signal path. This switch may be used to remove the equaliser from circuit when it is not in use or to carry out comparisons between the equalised and unequalised signals.

INS

The INS switch connects the input insert return signal to the input channel signal path. The insert send point can be used as a signal source without this switch being depressed.

PRE

When depressed this places the insert point before the equaliser - normally it is located after the equaliser.

THE AUXILIARY SENDS

There are a total of 20 mix buses. Of these the first two are dedicated for mono use and are for use as effects sends, the following 16 may be used in either stereo or mono mode for creating monitor mixes while the remaining pair, numbers 19 and 20, are dedicated to stereo use. They form the main stereo bus of the console and any groups assigned to the stereo bus will be routed to buses 19 and 20.

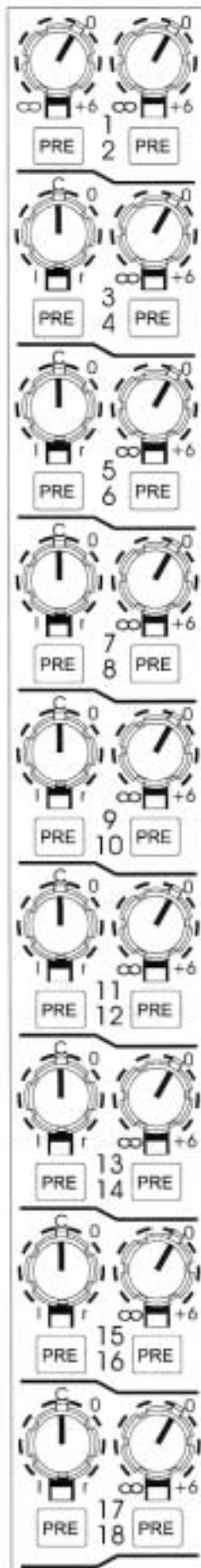

1, 2

The mono auxiliary MIX controls (1 and 2) give continuous adjustment of the level sent from the input channel to auxiliary buses 1 and 2. The level adjustment is from +6dB to off. These controls incorporate an ON/OFF switch which is activated by pushing the knob. A GREEN led indicates the ON status. Note that auxiliaries 1 and 2 cannot be used for stereo operation.

PRE

The auxiliary PRE switches change the signal sent to the auxiliary buses from post fader to pre fader.

3-18

The configurable group MIX controls (3 to 18) adjust the levels sent from the input channel to the group buses. They can be configured for mono or stereo use on a bus by bus basis and are controlled from the STEREO switches on the GROUP modules.

When configured as stereo the left hand controls perform a pan function while the right hand controls give continuous level adjustment from +6dB to off. When configured as mono the left and right controls give independent level adjustments from +6dB to off. These controls incorporate an ON/OFF switch which is activated by pushing the knob. A GREEN led indicates the ON status. During STEREO operation only the right hand led will illuminate.

PRE

The group PRE switches change the signals sent to the group buses from post fader to pre fader. During STEREO operation only the right hand switch will operate.

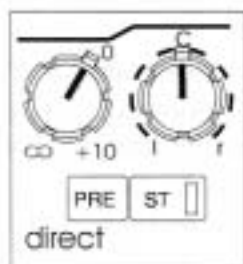

DIRECT

The DIRECT control gives continuous adjustment of the direct output level from +10dB to off. The output is normally derived from the post-equaliser pre-fader signal and will be muted if a local mute or an automute is active on the channel.

There are a number of possible uses for the Direct Output.

- i as an effect send for one module without using up a bus.
- ii to feed the signal into another module where different equalisation could be applied to the signal compared with that on the original module.
- iii to feed another monitor console in order to increase the number of available monitor sends.
- iv to feed a front of house console.
- v to feed a multi track tape recorder for recording performances

PRE

This changes the direct output to the pre-insert/pre-equaliser signal. Internal links allow further signal selections to be made as shown in the following table:-

Position of SW 20	Standard Links A. & C	Option Links A. & D	Option Links B. & D
PRE	Pre. EQ. and INS	Pre. EQ. and INS	Pre. fader (post. EQ. and INS)
POST	Post. EQ. and INS	Post. fader	Post. fader

PAN

The PAN controls the placement of the channel within the master stereo mix and has a constant power law i.e. -3dB at the centre position.

ST

The ST switch connects the post fader channel signal to the master stereo bus via the pan control.

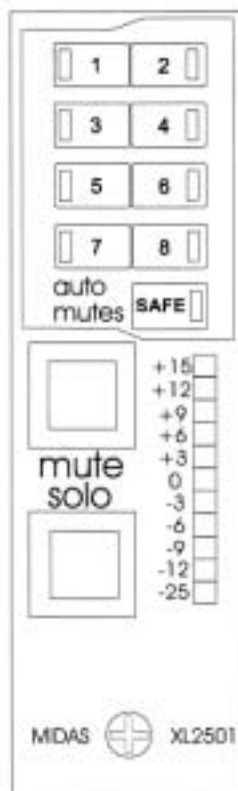

THE AUTOMUTES

AUTO MUTES

The AUTO MUTE switches assign the channel to any or all of the 8 auto mute groups. Any channel assigned to automute 1, for example, will mute when master automute 1 is activated from the communications module.

SAFE

The SAFE switches disconnects the channel from the auto mute buses. This allows any assignments to remain in place while the channel is temporarily prevented from responding to automutes.

MUTE

This mutes the input channel. The insert send will remain active while the DIRECT OUTPUT will only remain active if set to PRE.

SOLO

The SOLO switch sends the input channel signal to the PFL mono and AFL stereo buses. If the switch is pressed for a short time it will latch on or off, but, if it is held on for more than 1 second the latching is disabled and when the switch is released the channel solo will turn off.

As a default the solo system is auto cancelling so each new solo cancels the last. This function is time dependant which allows several solos to be active as long as they are switched on at approximately the same time. The SOLO ADD MODE switch on the COMMS module defeats the auto cancelling and allows multiple channel monitoring. In this mode input solos have priority over outputs and will temporarily override any active output solos.

METER

This is an 11 segment peak reading meter. It displays the pre fader signal which is post equaliser and post insert.

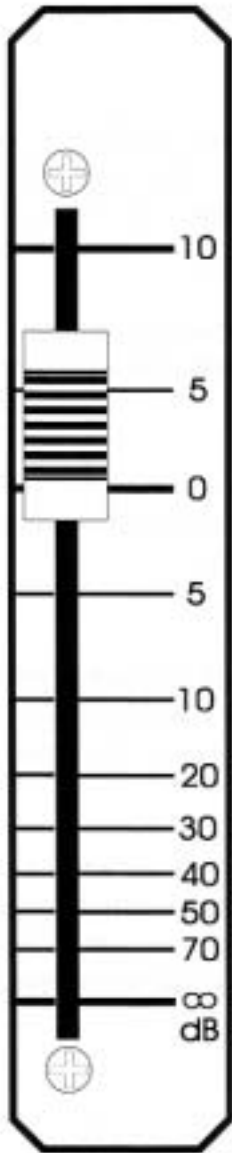

FADER

The channel fader gives continuous adjustment of the input channel level from + 10dB to - infinity. It is the main signal level control for the channel, and is a long-throw type giving smooth control.

CONNECTORS AND PIN DEFINITIONS

INSERT SEND

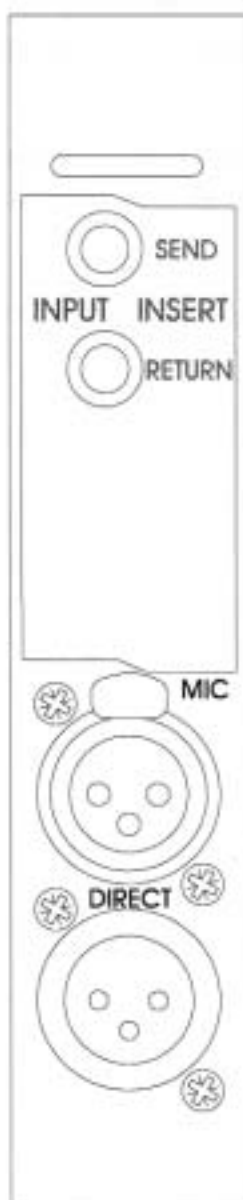

1/4" TRS style jack socket, A Gauge balanced
Nominal Output Level 0dB
Tip: Signal +ve
Ring: Signal -ve
Sleeve: Ground
Output Impedance: = 50R

INSERT RETURN

1/4" TRS style jack socket, A Gauge balanced
Nominal Input Level 0dB
Tip: Signal +ve
Ring: Signal -ve
Sleeve: Ground
Input Impedance: =20kOhm

MIC

3 pin female XLR style connector, balanced
Nominal Input Level 0dB
Pin 2: Signal +ve (hot)
Pin 3: Signal -ve (cold)
Pin 1: Ground
Input Impedance: =2kOhm

DIRECT OUTPUT

3 pin male XLR style connector, balanced
Nominal Output Level 0dB
Pin 2: Signal +ve (hot)
Pin 3: Signal -ve (cold)
Pin 1: Ground
Output Impedance: =50R

XL2504 STEREO INPUT MODULE.

The stereo input module accepts either microphone (low level) or line (high level) signals. After being unbalanced and shifted to a suitable level for the console electronics the signal is passed through a three band equaliser section and from there through the channel fader to be sent to the monitor send buses.

There are 20 possible buses that the signal can be routed to with buses 1 and 2 fixed as mono only and 19 and 20 reserved as the main stereo bus of the console. The remaining sends can be used as mono sends or linked to be used in pairs as stereo sends.

There are eight automute buses to which the channel can be assigned. An eleven segment meter indicates the channel signal level and there is a MUTE and a SOLO switch.

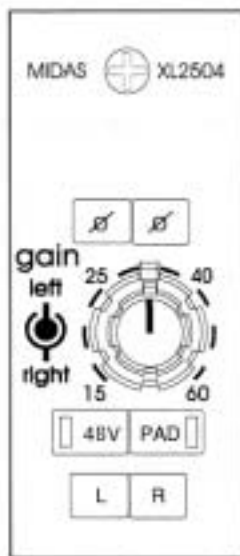

PHASE

There are independent phase reverse switches for the left and right signal paths. More correctly these switches reverse the polarity of the input signals. If a stereo microphone is out of phase with the remaining microphones connected to the console then both switches may be pressed. If only one half of a stereo pair is found to be out of phase with everything else then the appropriate switch can be pressed to correct the situation.

GAIN

The dual concentric GAIN controls give continuous adjustment of the input amplifier gains from + 15dB to + 60dB. The left channel is the upper knob while the right channel is the lower knob.

PAD

The PAD switch gives 25dB of attenuation to both input signals allowing the connection of high output microphones or line level signals. If the input amplifiers are transformer coupled (option) the pad greatly reduces the risk of saturation at very low frequencies.

48V

The 48V switch connects 48 volt phantom power to both input connectors.

LEFT

This switch places the left channel signal onto both left and right channels.

RIGHT

This switch places the right channel signal onto both left and right channels.

If the left and right switches are both pressed a mono sum signal is fed to both channels of the input channel.

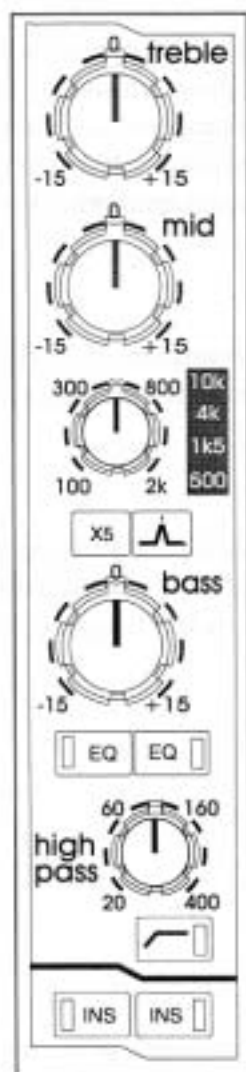

THE EQUALISER

TREBLE

This provides up to 15dB of boost or cut at a frequency of 10kHz with a shelving response.

MID

This provides up to 15dB of boost and cut at frequencies between 100Hz and 10kHz.

FREQ

The mid FREQ control defaults to give continuous adjustment of the frequency range that the mid equaliser acts on from 100Hz to 2K.

WIDTH

The WIDTH control selects the bandwidth of the mid equaliser to be 1.5 octave or 0.3 octave.

X5

The frequency X5 control increases the mid equaliser frequency to operate between 500Hz and 10K.

BASS

This provides up to 15dB of boost or cut at a frequency of 100Hz with a shelving response.

EQ

The EQ switch connects the equaliser in the input channel signal path. This switch may be used to remove the equaliser from circuit when it is not in use

or to carry out comparisons between the equalised and unequalised signals.

HI PASS (Control)

The HI PASS filter control is continuously adjustable from 20Hz to 400Hz.

HI PASS (Switch)

The HI PASS switch places the filter into the input channel signal path before the insert point.

INS

The INS switches connect the input insert return signals to the input channel signal paths. The insert points are pre equaliser and the left and right signal paths may be independently controlled.

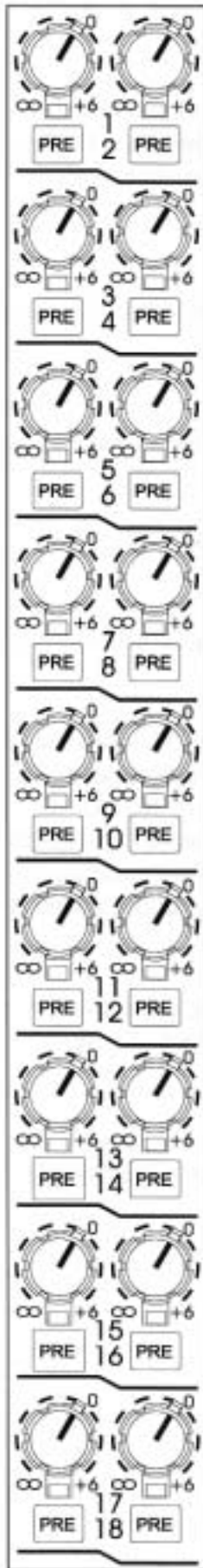

THE SENDS

The auxiliary sends are almost identical to that of the mono module.

1 AND 2

The mono auxiliary MIX controls (1 and 2) give continuous adjustment of the level sent from the input channel to the auxiliary buses. The signal is a mono sum of left and right and the level adjustment is from +6dB to off. The level controls incorporate an ON/OFF switch which is a non latching push switch. ON status is indicated by a LED.

The aux PRE switches change the signal sent to the aux buses from post fader to pre fader.

3-18

The configurable group MIX controls (3 to 18) give continuous adjustment of the levels sent from the input channel to the group buses. The adjustment is from +6dB to off. They can be individually configured as mono or stereo mixes and are controlled from the global STEREO switches on the GROUP modules. When configured as stereo the left controls send left channel signals and the right controls send right channel signals. When configured as mono the left and right controls give independent level adjustments and derive their signal from a mono sum of the left and right signals. These controls incorporate an ON/OFF switch which is a non latching push switch. ON status is indicated by a LED.

The group PRE switches change the signals sent to the group buses from post fader to pre fader.

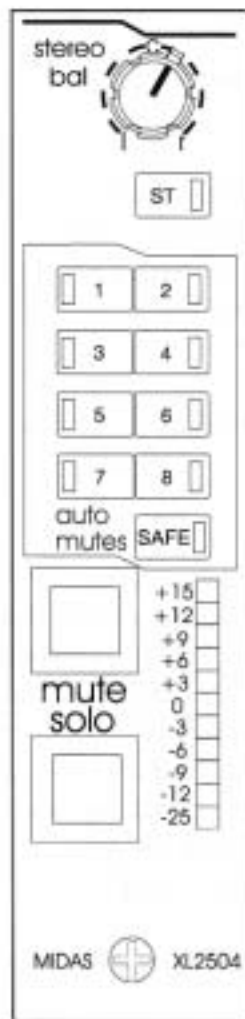

THE AUTOMUTES

BALANCE

The **BALANCE** (pan) control is used to balance the relative levels of the left and right channel signals that are sent to the master stereo mix (19 and 20). The control has a constant power law giving 0dB at the centre position and + 3dB or off at either extreme setting.

ST

The **ST** switch connects the post fader channel signals to the master stereo mix (19 and 20) via the balance control.

AUTOMUTE

The **AUTO MUTE** switches assign the channel to the 8 auto mute groups.

SAFE

The **SAFE** switches disconnect the channel mutes from the auto mute buses.

MUTE

The **MUTE** switch mutes the input channel at all points except the insert send.

SOLO

The **SOLO** switch sends the input channel signals to the PFL mono and AFL stereo buses. If the switch is pressed for a short time it will latch on or off, but, if it is held on for more than 1 second the latching is disabled and when the switch is released the channel solo will turn off. As a default the solo system is auto cancelling so each new solo cancels the last. This function is time dependant which allows several solos to be active as long as they are switched

on at approximately the same time.

The **SOLO ADD MODE** switch on the **COMMS** module defeats the auto cancelling and allows multiple channel monitoring. In this mode input solos have priority over outputs and will temporarily override any active output solos.

METER

The **METER** monitors the peak signal level of the channel pre fader left and right inputs (which ever is the highest).

FADER

The channel fader gives continuous adjustment of the input channel level from + 10dB to - infinity. It is the main signal level control for the channel, and is a long-throw type giving smooth control.

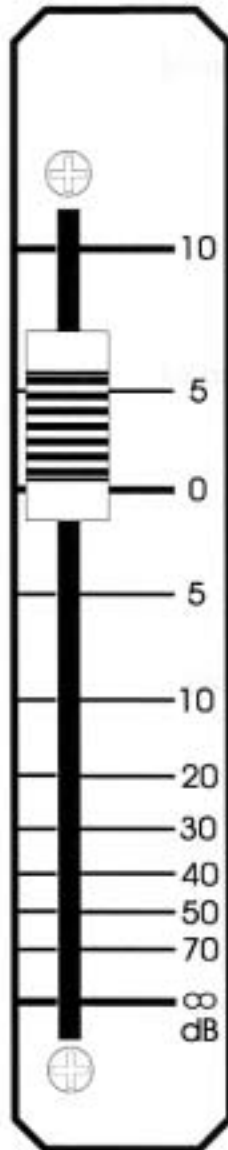

CONNECTORS AND PIN DEFINITIONS

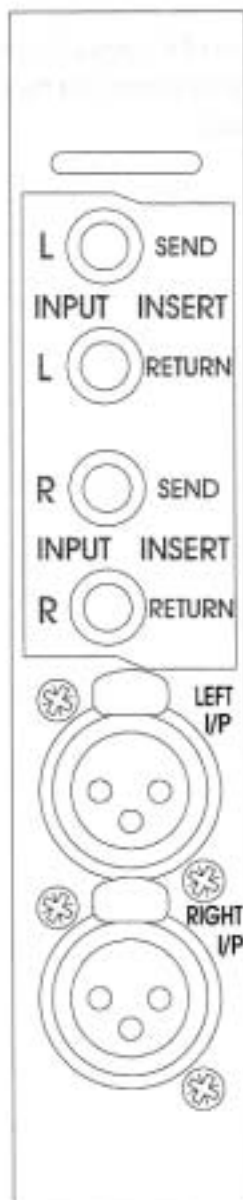

INSERT SENDS

1/4" TRS style jack socket, A Gauge balanced
Nominal Output Level 0dB

Tip: Signal +ve

Ring: Signal -ve

Sleeve: Ground

Output Impedance: = 50R

INSERT RETURNS

1/4" TRS style jack socket, A Gauge balanced
Nominal Input Level 0dB

Tip: Signal +ve

Ring: Signal -ve

Sleeve: Ground

Input Impedance: =20kOhm

INPUTS

3 pin female XLR style connectors, balanced

Nominal Input Level 0dB

Pin 2: Signal +ve (hot)

Pin 3: Signal -ve (cold)

Pin 1: Ground

Input Impedance: =20kOhm



XL2511, 2, 3, 4 & 5 MIX GROUP MODULES

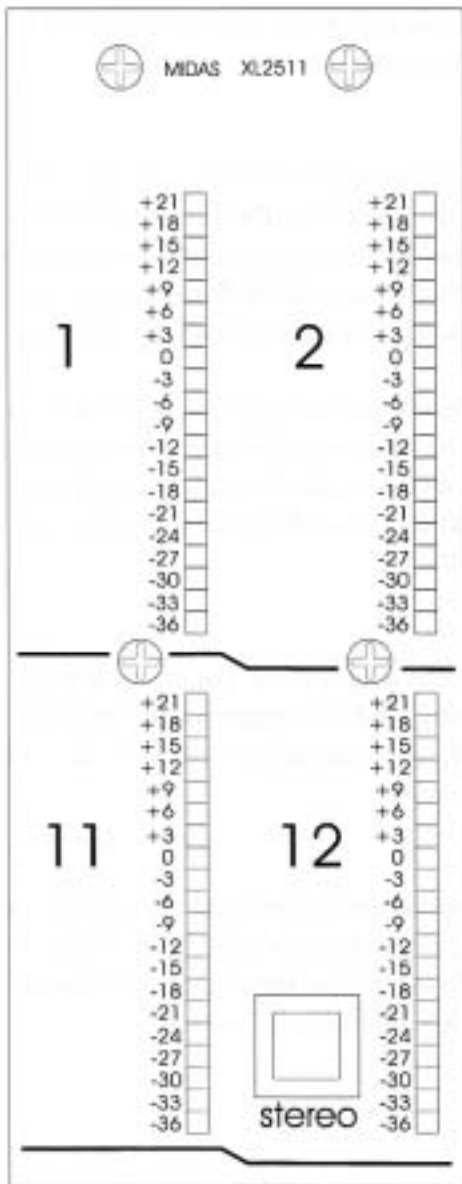

Each of the 5 group modules carries 4 group outputs thus giving a total of 20 group outputs. Outputs 1 and 2 are mono only and therefore do not have a stereo switch. Outputs 3-18 are identical in function and may be independently switched to stereo operation. Outputs 19 and 20 may be regarded as the main stereo bus of the console and therefore do not have a stereo switch as they are always stereo.

METERS

The METERS monitor the peak signal levels of the mix group outputs (post fader). The meters are 20 segment peak reading led bargraph types.

STEREO

The STEREO switch configures all input modules for a particular pair of sends to act as either mono level and level or as stereo level and pan. Sends can therefore be quickly and easily switched between mono and stereo operation depending upon the application.

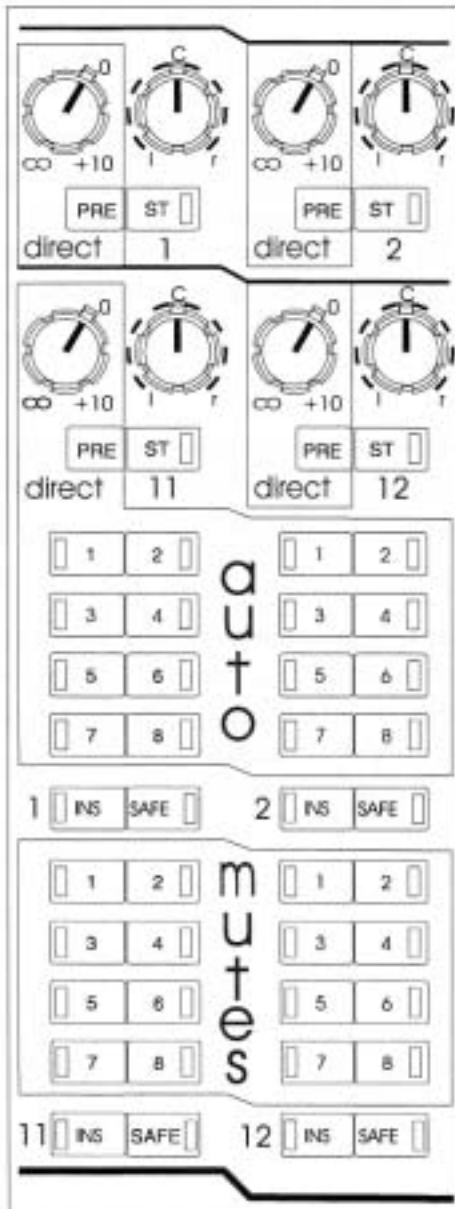

DIRECT

The DIRECT input control gives continuous adjustment of the direct input signal from +10dB to off. The direct input can be accessed by the solo function if the SOLO C/O switch is pressed.

PRE

The direct PRE switch moves the point at which the direct signal is summed into the mix group. The default position is post insert. This allows the insert point to be used as an effects send with the direct input performing the effects return function with level and solo control

If the PRE switch is active the direct signal is summed onto the mix bus (pre insert). With this configuration the direct input can be used to return effects, add ambience microphones (with a suitable preamplifier) or facilitate console bus linking.

PAN

The PAN control allows stereo placement of any mixes which are being used as sub groups feeding the master stereo mix. It has a constant power law i.e. -3dB at the centre position.

ST

The ST switch connects the post fader mix group signals to the master stereo buses via the pan control. Sends 19 and 20 are the master stereo bus and therefore do not have a PAN control or ST switch.

AUTOMUTE

The AUTO MUTE switches assign the group output to the 8 auto mute groups.

SAFE

The SAFE switch disconnects the mutes from the auto mute buses.

INS

The INS switch connects the insert return signals into the group signal path.

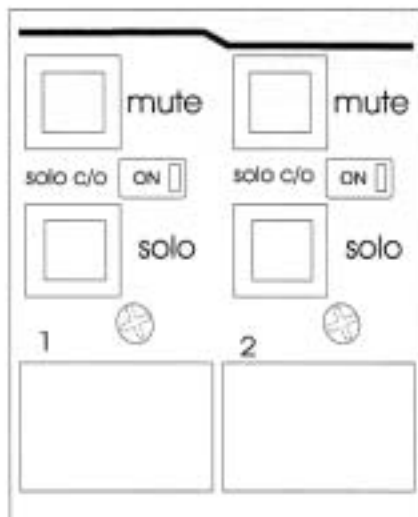

MUTE

The MUTE switch mutes the mix group at all points except the insert send.

SOLO

The SOLO switches send mix group signals to the PFL mono and AFL stereo buses (AFL is selected as stereo or mono depending on the global STEREO switch setting). If a SOLO switch is pressed for a short time it will latch on or off, but, if it is held on for more than 1 second the latching is disabled and when the switch is released the channel solo will turn off. As a default the solo system is auto cancelling so each new solo cancels the last. This function is time dependant which allows several solos to be active as long as they are switched on at approximately the same time, i.e. to solo both sides of a stereo

mix press both solo switches at the same time. Alternatively the SOLO ADD MODE switch on the COMMS module can be used to defeat the auto cancelling and allow multiple channel monitoring. In this mode input channel solos have priority over the mix group solos and will temporarily override them. When the input solos are cancelled the mix group solos will be active again.

Note that the master module performs differently. Priority is always present regardless of mode and Master Left and Right solos can not be cleared using the SOLO CLEAR switch. Thus master solos could be left permanently on as they will be suspended while an input or a group solo is active.

SOLO C/O

The SOLO C/O switch moves the solo switch function over to the group direct input. This then allows the direct input to be soloed whether it is being used as an effect return or as an input for a linked console.

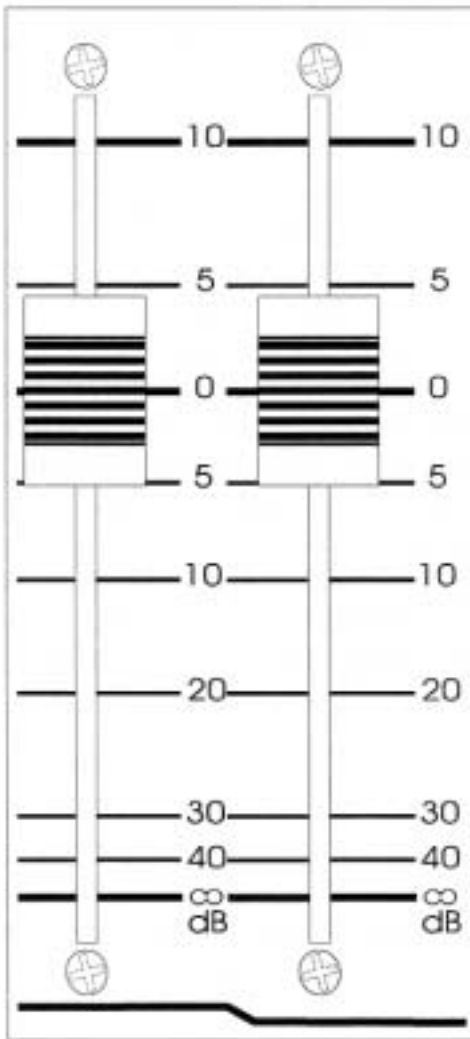

FADER

The **GROUP FADERS** give continuous adjustment of the mix output levels from + 10dB to off.

It is the main signal level control for the group, and is a long-throw type giving smooth control.

CONNECTORS AND PIN DEFINITIONS

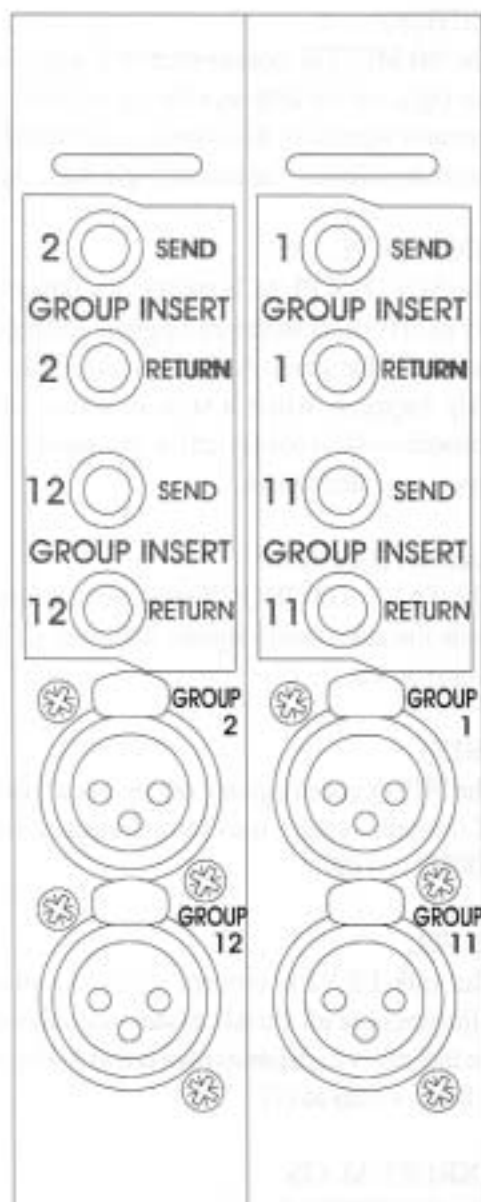

DIRECT INPUTS

3 pin female XLR style connector, balanced
 Nominal Input Level 0dB
 Pin 2: Signal +ve (hot)
 Pin 3: Signal -ve (cold)
 Pin 1: Ground
 Input Impedance: = 20kOhm

INSERT POINTS

1/4" TRS style jack sockets, A Gauge balanced
 Nominal Input Output Level 0dB
 Tip: Insert Send
 Ring: Insert Return
 Sleeve: Ground
 Output Impedance: =50R
 Input Impedance: =20kOhm

GROUP OUTPUTS

3 pin male XLR style connector, balanced
 Nominal Output Level 0dB
 Pin 2: Signal +ve (hot)
 Pin 3: Signal -ve (cold)
 Pin 1: Ground
 Output Impedance: =50R

Note that the group outputs are located on the XLR panels as illustrated below, and not on the modules.

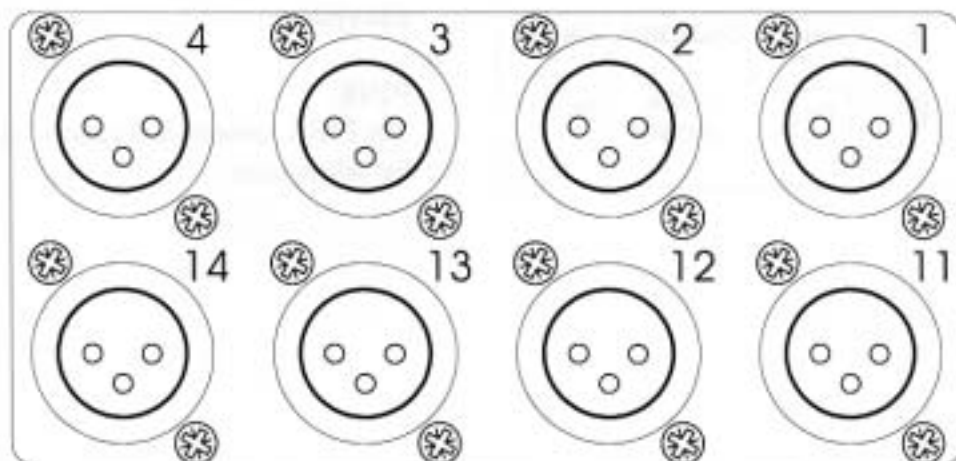

XL2512 COMMS MODULE.

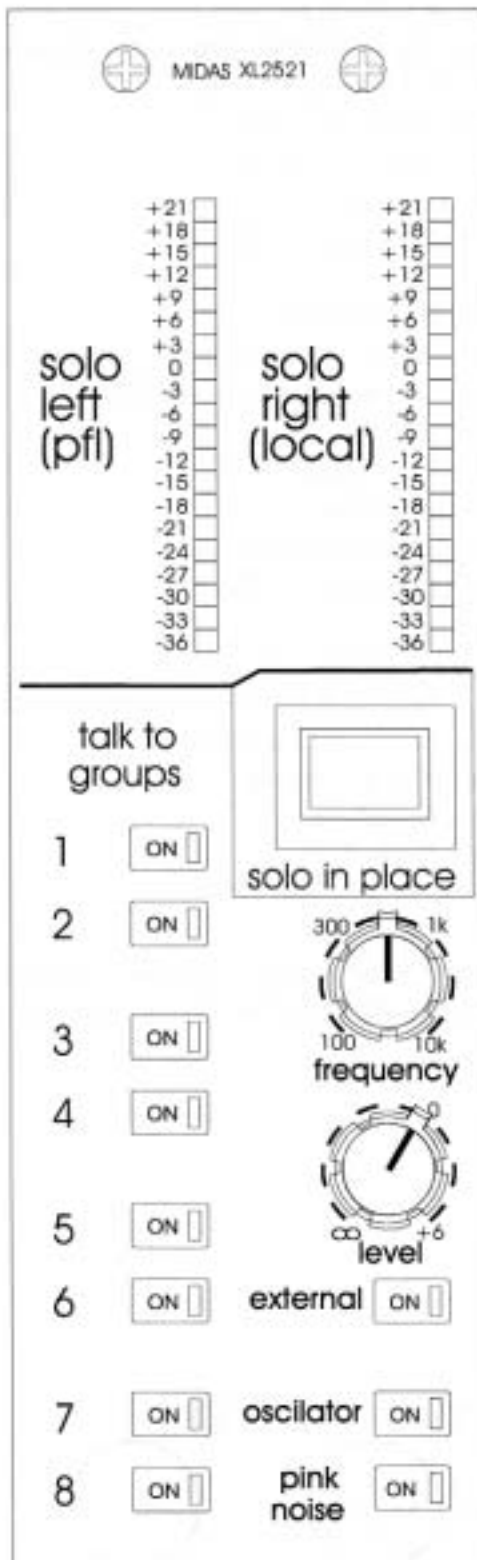

METERS

The left METER monitors the PFL signal while the right meter displays the right hand local monitor signal. If AFL mode is selected then the meters display the left and right AFL signals.

SOLO IN PLACE

The SOLO IN PLACE switch disconnects the pre insert master stereo mix signals and replaces them with the stereo AFL solo bus signals. This only happens when a solo is active on the console — if no solo is active the master stereo bus is not interrupted.

TALK TO GROUP

The TALK TO GROUP switches are used to route the talk system signals to any or all of the group buses.

FREQ

The FREQ. control gives continuous adjustment of the talk system oscillator frequency from 100Hz to 10K.

LEVEL

The talk LEVEL control gives continuous adjustment of all the talk system signals except the talk mic which has its own control. The range is from +6dB to off.

EXRERNAL ON

The EXTERNAL ON switch connects the external talk input and output to the talk system.

OSC

The OSC switch connects the oscillator to the talk system.

PINK

The PINK noise switch connects pink noise to the talk system.

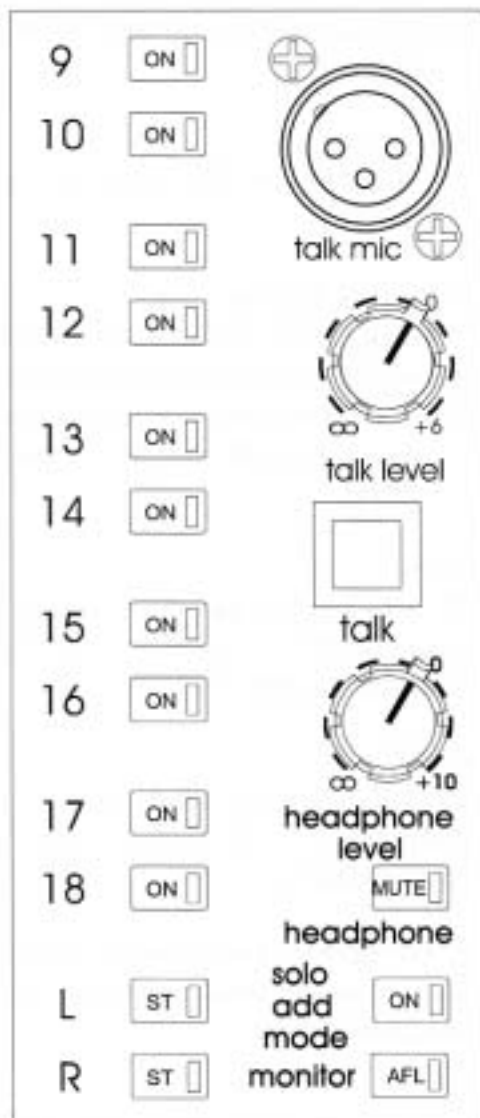

TALK XLR

The TALK XLR socket accepts balanced 150 Ohm microphone signals from - 50dBu to - 20dBu and uses an auto ranging gain system to bring the level to nominal 0dBu line level.

TALK

The TALK control gives continuous adjustment of the talk microphone amplifier signal from + 6dB to off.

TALK

The TALK switch connects the talk microphone input to the talk system and at the same time dims the local outputs by 20dB to prevent howl round.

HEADPHONE LEVEL

The HEADPHONE LEVEL control gives continuous adjustment of the headphone level from + 10dB to off.

HEADPHONE MUTE

The HEADPHONE MUTE switch mutes the headphone outputs.

SOLO ADD MODE

The SOLO ADD MODE switch allows multiple channel access to the solo buses. When the solo add mode is off the action of pressing a solo switch will cancel any previously active solo. Multiple solos such as stereo left and right signals can be monitored in this mode of operation as long as the solo switches are

pressed at approximately the same time. When the solo add mode is on the auto cancelling is defeated which allows multiple channel or output soloing. In this mode input channel solos have priority over the output solos, i.e. any active input solo will temporarily override all active output solos — when the input solo is cancelled the output solos will return.

MONITOR AFL

The MONITOR AFL switch sends the stereo AFL solo bus signals to the headphones and local outputs in place of the mono PFL solo bus signal.

auto mute masters

1



2



3



4



5



6

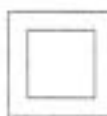

7

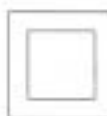

8

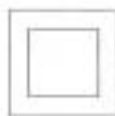

local
mute

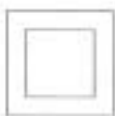

left
solo

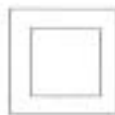

solo
clear



right
solo



MIDAS XL2521



AUTOMUTE MASTERS

The AUTO MUTE GROUP MASTER switches (1 to 8) activate the mute circuits on any appropriately mute group assigned input channels or mix groups.

LOCAL MUTE

The LOCAL MUTE switch mutes the local outputs.

SOLO ON/CLEAR

The SOLO ON / CLEAR switch and indicator has two functions. It illuminates when any solo is active and when pressed it clears any active solos on the console and on a slave console if one is connected.

LEFT

The LEFT switch cuts the AFL right signal and places the AFL left signal on to both left and right local and headphone outputs.

RIGHT

The RIGHT switch cuts the AFL left signal and places the AFL right signal on to both local and headphone outputs.

If both are pressed the solo signal is mixed to mono and fed to the local monitor output and the headphone output.

FADER

The LOCAL FADER gives continuous adjustment of the local output level from +10dB to off.

It is the level control for the local output, and is a long-throw type giving smooth control.

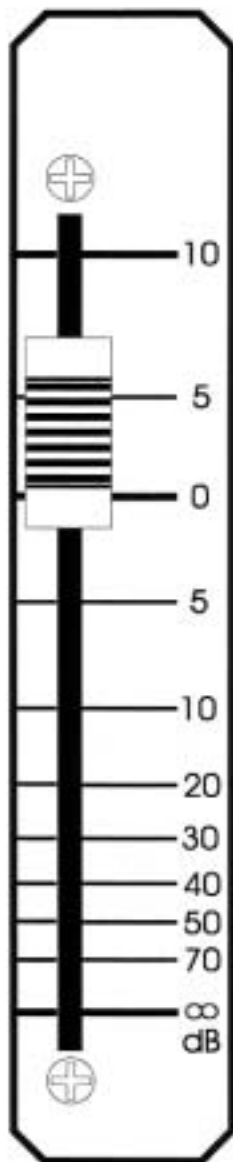

CONNECTORS AND PIN DEFINITIONS

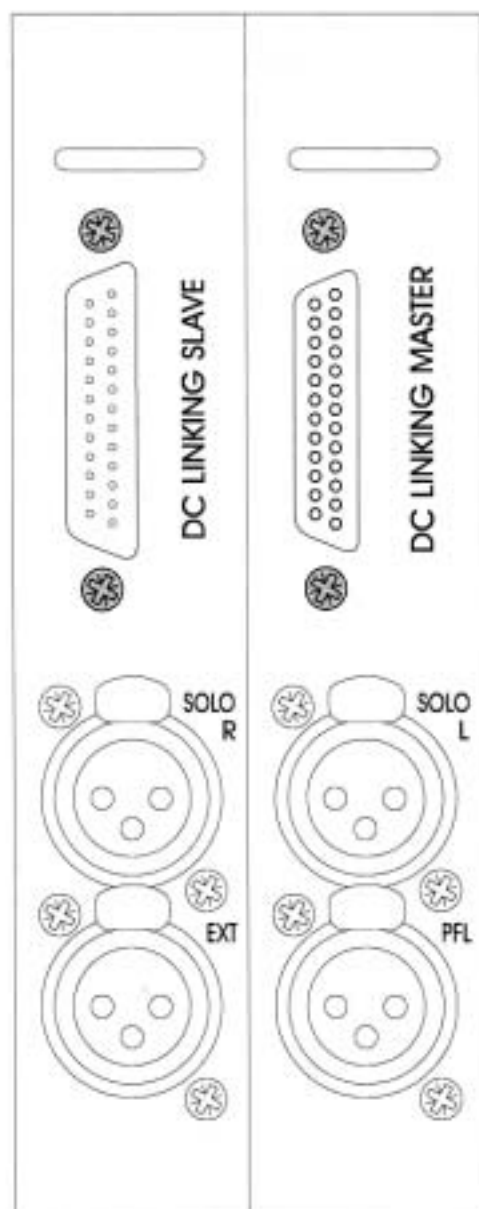

EXTERNAL INPUT

3 pin female XLR style connector, balanced

Nominal Input Level 0dB

Pin 2: Signal +ve (hot)

Pin 3: Signal -ve (cold)

Pin 1: Ground

Input Impedence: =20kOhms

EXTERNAL OUTPUT

3 pin male XLR style connector, balanced

Nominal Input Level 0dB

Pin 2: Signal +ve (hot)

Pin 3: Signal -ve (cold)

Pin 1: Ground

Output Impedence: =50R

SOLO INPUTs

3 pin female XLR style connectors, balanced

Nominal Input Level 0dB

Pin 2: Signal +ve (hot)

Pin 3: Signal -ve (cold)

Pin 1: Ground

Input Impedence: =20kOhms

SOLO OUTPUTS

3 pin male XLR style connectors, balanced

Nominal Output Level 0dB

Pin 2: Signal +ve (hot)

Pin 3: Signal -ve (cold)

Pin 1: Ground

Output Impedence: =50R

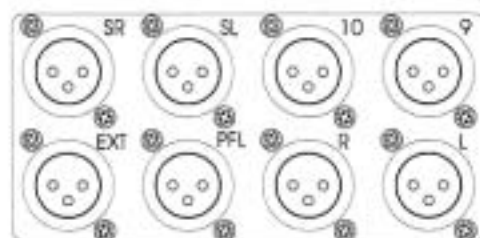

LOCAL OUTPUTS

3 pin male XLR style connector, balanced

Nominal Output Level 0dB

Pin 2: Signal +ve (hot)

Pin 3: Signal -ve (cold)

Pin 1: Ground

Output Impedence: = 50R



DC LINK PIN NOS.	DC LINK OUTPUT (MASTER)	DC LINK INPUT (SLAVE)
1	AUTO MUTE 1 OUTPUT	AUTO MUTE 1 INPUT
2	AUTO MUTE 2 OUTPUT	AUTO MUTE 2 INPUT
3	AUTO MUTE 3 OUTPUT	AUTO MUTE 3 INPUT
4	AUTO MUTE 4 OUTPUT	AUTO MUTE 4 INPUT
5	AUTO MUTE 5 OUTPUT	AUTO MUTE 5 INPUT
6	AUTO MUTE 6 OUTPUT	AUTO MUTE 6 INPUT
7	AUTO MUTE 7 OUTPUT	AUTO MUTE 7 INPUT
8	AUTO MUTE 8 OUTPUT	AUTO MUTE 8 INPUT
9		
10		
11		
12		
13		
14		
15		
16		
17		
18		
19		
20		
21		
22	SOLO CLEAR	SOLO CLEAR
23	OVA	OVA
24	OVA	OVA
25	SOLO ON INPUT	SOLO ON OUTPUT

POWER SUPPLY CABLE

SIGNAL NAME	PSU CONNECTOR	CABLE	CONSOLE CONNECTOR
+18V	2	2	2
+18V	3	3	3
-18V	4	4	4
-18V	5	5	6
+48V	10	1	5
CHASSIS	CASE	G/Y	CASE
0V	7	6	1