

Operating Manual

OPTIMOD-FM[®]

MODEL 8100A1

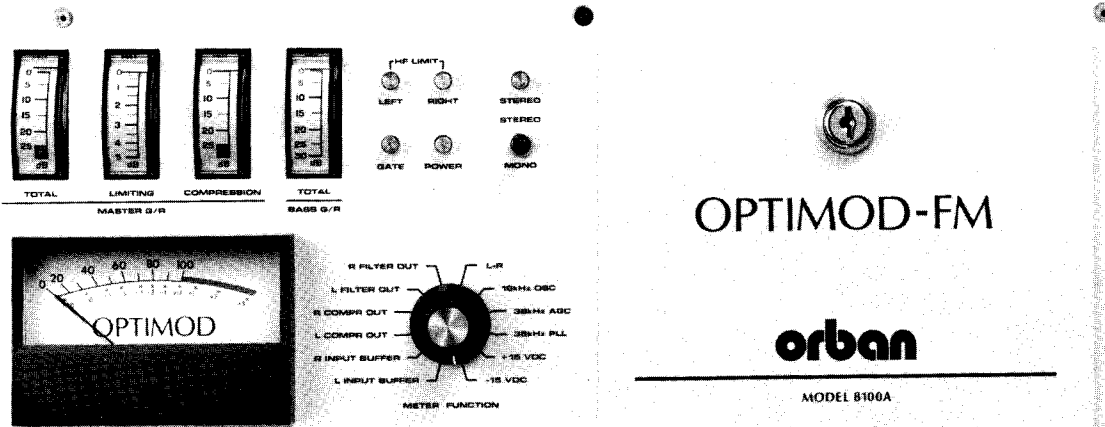

orban[®]
a division of AKG Acoustics, Inc.

Important Note:

The name of your OPTIMOD-FM unit and references to it in the manual may not match. Refer to the list below.

If you purchased:	Manual References Include:
8100A1/U75	8100A/1
8100A1/U75F	8100A/1 & ACC 22
8100A1/J50	8100A/1, MVM 21, OPT 11
8100A1/J50F	8100A/1, MVM 21, OPT 11, ACC 22
8100A1/E50	8100A/1 230V, OPT 21, OPT 11
8100A1/E50F	8100A/1 230V, OPT 21, OPT 11, ACC 22

The 8100A1 OPTIMOD-FM is protected by U.S.A. patents #4,460,871; #4,249,042 and U.K. patent #2,001,495.

Other patents pending.

Orban is a registered trademark of AKG Acoustics, Inc.

OPTIMOD-FM is a registered trademark of AKG Acoustics, Inc.

This manual is part number 95039-000-06.

©1990 by AKG Acoustics, Inc.

600-IP-8/90

Safety Instructions

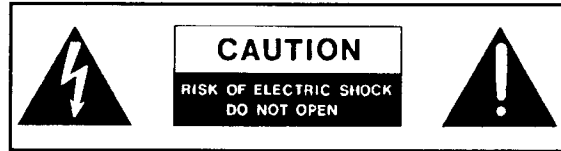

CAUTION: TO REDUCE THE RISK OF ELECTRICAL SHOCK, DO NOT REMOVE COVER (OR BACK). NO USER SERVICEABLE PARTS INSIDE. REFER SERVICING TO QUALIFIED SERVICE PERSONNEL.

WARNING: TO REDUCE THE RISK OF FIRE OR ELECTRICAL SHOCK, DO NOT EXPOSE THIS APPLIANCE TO RAIN OR MOISTURE.



This symbol, wherever it appears, alerts you to the presence of uninsulated dangerous voltage inside the enclosure — voltage that may be sufficient to constitute a risk of shock.



This symbol, wherever it appears, alerts you to important operating and maintenance instructions in the accompanying literature. Read the manual.

Notice For U.K. Customers

WARNING: THIS APPLIANCE MUST BE EARTHED.

The cores in the mains lead are coloured in accordance with the following code:

GREEN and YELLOW - Earth

BLUE - Neutral

BROWN - Live

As colours of the cores in the mains lead of this appliance may not correspond with the coloured markings identifying the terminals in your plug, proceed as follows:

The core which is coloured green and yellow must be connected to the terminal in the plug marked with the letter E, or with the earth symbol, (\perp), or coloured green, or green and yellow.

The core which is coloured blue must be connected to the terminal marked N or coloured black.

The core which is coloured brown must be connected to the terminal marked L or coloured red.

Detailed Safety Instructions

All the safety and operating instructions should be read before the appliance is operated.

Retain Instructions: The safety and operation instructions should be retained for future reference.

Heed Warnings: All warnings on the appliance and in the operating instructions should be adhered to.

Follow Instructions: All operation and user instructions should be followed.

Water and Moisture: The appliance should not be used near water (e.g., near a bathtub, washbowl, kitchen sink, laundry tub, in a wet basement, or near a swimming pool, etc.).

Ventilation: The appliance should be situated so that its location or position does not interfere with its proper ventilation. For example, the appliance should not be situated on a bed, sofa, rug, or similar surface that may block the ventilation openings; or, placed in a built-in installation, such as a bookcase or cabinet that may impede the flow of air through the ventilation openings.

Heat: The appliance should be situated away from heat sources such as radiators, heat registers, stoves, or other appliances (including amplifiers) that produce heat.

Power Sources: The appliance should be connected to a power supply only of the type described in the operating instructions or as marked on the appliance.

Grounding or Polarization: Precautions should be taken so that the grounding or polarization means of an appliance is not defeated.

Power-Cord Protection: Power-supply cords should be routed so that they are not likely to be walked on or pinched by items placed upon or against them, paying particular attention to cords at plugs, convenience receptacles, and the point where they exit from the appliance.

Cleaning: The appliance should be cleaned only as recommended by the manufacturer.

Non-use Periods: The power cord of the appliance should be unplugged from the outlet when left unused for a long period of time.

Object and Liquid Entry: Care should be taken so that objects do not fall and liquids are not spilled into the enclosure through openings.

Damage Requiring Service: The appliance should be serviced by qualified service personnel when:

The power supply cord or the plug has been damaged; or

Objects have fallen, or liquid has been spilled into the appliance; or

The appliance has been exposed to rain; or

The appliance does not appear to operate normally or exhibits a marked change in performance; or

The appliance has been dropped, or the enclosure damaged.

Servicing: The user should not attempt to service the appliance beyond that described in the operating instructions. All other servicing should be referred to qualified service personnel.

Gerät nur an der am Leistungsschild vermerkten Spannung und Stromart betreiben.

Sicherungen nur durch solche, gleicher Stromstärke und gleichen Abschaltverhaltens ersetzen. Sicherungen nie überbrücken.

Jedwede Beschädigung des Netzkabels vermeiden. Netzkabel nicht knicken oder quetschen. Beim Abziehen des Netzkabels den Stecker und nicht das Kabel erfassen. Beschädigte Netzkabel sofort auswechseln.

Gerät und Netzkabel keinen übertriebenen mechanischen Beanspruchungen aussetzen.

Um Berührung gefährlicher elektrischer Spannungen zu vermeiden, darf das Gerät nicht geöffnet werden. Im Fall von Betriebsstörungen darf das Gerät nur von befugten Servicestellen instandgesetzt werden. Im Gerät befinden sich keine, durch den Benutzer reparierbare Teile.

Zur Vermeidung von elektrischen Schlägen und Feuer ist das Gerät vor Nässe zu schützen. Eindringen von Feuchtigkeit und Flüssigkeiten in das Gerät vermeiden.

Bei Betriebsstörungen bzw. nach Eindringen von Flüssigkeiten oder anderen Gegenständen, das Gerät sofort vom Netz trennen und eine qualifizierte Servicestelle kontaktieren.

On s'assurera toujours que la tension et la nature du courant utilisé correspondent bien à ceux indiqués sur la plaque de l'appareil.

N'utiliser que des fusibles de même intensité et du même principe de mise hors circuit que les fusibles d'origine. Ne jamais shunter les fusibles.

Éviter tout ce qui risque d'endommager le câble secour. On ne devra ni le plier, ni l'aplatir. Lorsqu'on débranche l'appareil, tirer la fiche et non le câble. Si un câble est endommagé, le remplacer immédiatement.

Ne jamais exposer l'appareil ou le câble à une contrainte mécanique excessive.

Pour éviter tout contact avec une tension électrique dangereuse, on n'ouvrira jamais l'appareil. En cas de dysfonctionnement, l'appareil ne peut être réparé que dans un atelier autorisé. Aucun élément de cet appareil ne peut être réparé par l'utilisateur.

Pour éviter les risques de décharge électrique et d'incendie, protéger l'appareil de l'humidité. Éviter toute pénétration d'humidité ou fr liquide dans l'appareil.

En cas de dysfonctionnement ou si un liquide ou tout autre objet a pénétré dans l'appareil couper aussitôt l'appareil de son alimentation et s'adresser à un point de service après-vente autorisé.

Hacer funcionar el aparato sólo con la tensión y clase de corriente señaladas en la placa indicadora de características.

Reemplazar los fusibles sólo por otros de la misma intensidad de corriente y sistema de desconexión. No poner nunca los fusibles en puente.

Proteger el cable de alimentación contra toda clase de daños. No doblar o apretar el cable. Al desenchufar, asir el enchufe y no el cable. Sustituir inmediatamente cables dañados.

No someter el aparato y el cable de alimentación a esfuerzo mecánico excesivo.

Para evitar el contacto con tensiones eléctricas peligrosas, el aparato no debe abrirse. En caso de producirse fallos de funcionamiento, debe ser reparado sólo por talleres de servicio autorizados. En el aparato no se encuentra ninguna pieza que pudiera ser reparada por el usuario.

Para evitar descargas eléctricas e incendios, el aparato debe protegerse contra la humedad, impidiendo que penetren ésta o líquidos en el mismo.

En caso de producirse fallos de funcionamiento como consecuencia de la penetración de líquidos u otros objetos en el aparato, hay que desconectarlo inmediatamente de la red y ponerse en contacto con un taller de servicio autorizado.

Far funzionare l'apparecchio solo con la tensione e il tipo di corrente indicati sulla targa riportante i dati sulle prestazioni.

Sostituire i dispositivi di protezione (valvole, fusibili ecc.) solo con dispositivi aventi lo stesso amperaggio e lo stesso comportamento di interruzione. Non cavallottare mai i dispositivi di protezione.

Evitare qualsiasi danno al cavo di collegamento alla rete. Non piegare o schiacciare il cavo. Per staccare il cavo, tirare la presa e mai il cavo. Sostituire subito i cavi danneggiati.

Non esporre l'apparecchio e il cavo ad esagerate sollecitazioni meccaniche.

Per evitare il contatto con le tensioni elettriche pericolose, l'apparecchio non deve venir aperto. In caso di anomalie di funzionamento l'apparecchio deve venir riparato solo da centri di servizio autorizzati. Nell'apparecchio non si trovano parti che possano essere riparate dall'utente.

Per evitare scosse elettriche o incendi, l'apparecchio va protetto dall'umidità. Evitare che umidità o liquidi entrino nell'apparecchio.

In caso di anomalie di funzionamento rispettivamente dopo la penetrazione di liquidi o oggetti nell'apparecchio, staccare immediatamente l'apparecchio dalla rete e contattare un centro di servizio qualificato.

Operating Manual

OPTIMOD-FM[®]

MODEL 8100A1

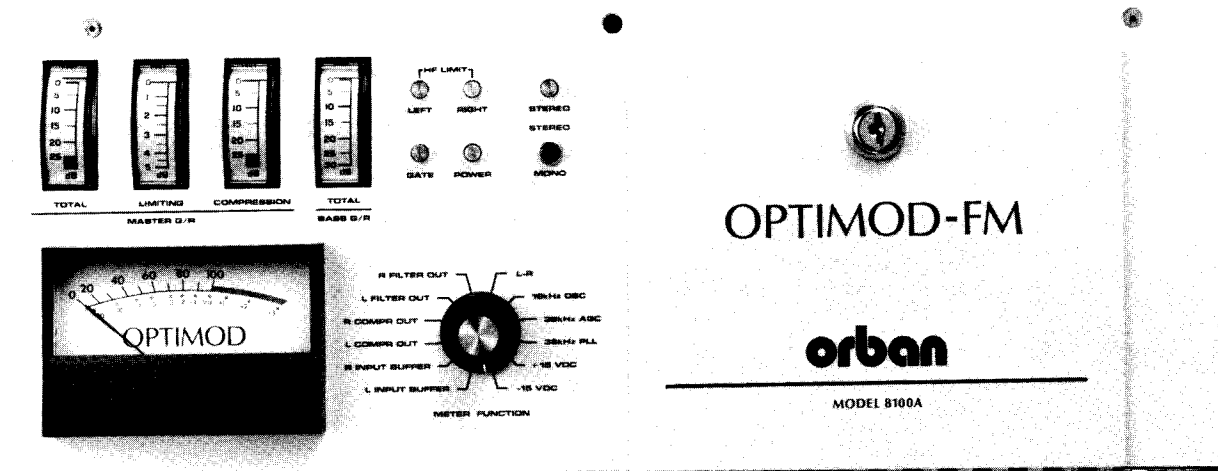

orban[®]

a division of AKG Acoustics, Inc.

1525 Alvarado Street, San Leandro, California 94577 USA
Tel 415/351-3500 Fax 415/351-0500

This manual is for use with all OPTIMOD-FM® Models 8100A/1 to date. It is not directly applicable to the 8100A/1's immediate ancestor, the Model 8100A.

The Model 8100A/1 processor differs from the Model 8100A in that it has been modified for use with other Orban products such as:

8100A/XT Six-Band Limiter Accessory Chassis

which is used to obtain improved source-to-source consistency and/or presence on smaller radios and in cars.

Cards #5, #6, and #8/9 have been reconfigured in the Model 8100A/1 to allow use of the optional Model 8100A/XT Six-Band Limiter Accessory Chassis. The motherboard has been changed, and a prewired Accessory Port has been included to interface the Accessory Chassis.

In the current revision of this manual, references to the Dolby^R 334 Noise Reduction Processor (including the interface information formerly contained in **Appendix G**) have been deleted. Please contact Customer Service for Dolby 334 interface information. References to FM quadrasonic broadcasting have also been deleted.

A new **Appendix G** gives information on changing the unit's preemphasis for those countries with a preemphasis standard different from the one used in the USA.

New information on the FM filter Card (#0) has been added. **Appendix K** (Audio Quality Considerations in FM Plants) has been deleted from the manual and now exists as a separate document shipped with your unit. References to FCC regulations have been updated.

Part 5 (Operating Instructions) has been extensively updated and revised.

CAUTION

The installation and servicing instructions in this manual are for use by qualified personnel only. To avoid electric shock do not perform any servicing other than that contained in the Operating Instructions unless you are qualified to do so. Refer all servicing to qualified service personnel.

(per UL 813)

OPTIMOD-FM is a registered trademark of AKG Acoustics, Inc.

Smart Clipper is a trademark of AKG Acoustics, Inc.

Dolby is a registered trademark of Dolby Laboratories, Inc.

Energine is a registered trademark of Sterling Drugs, Inc.

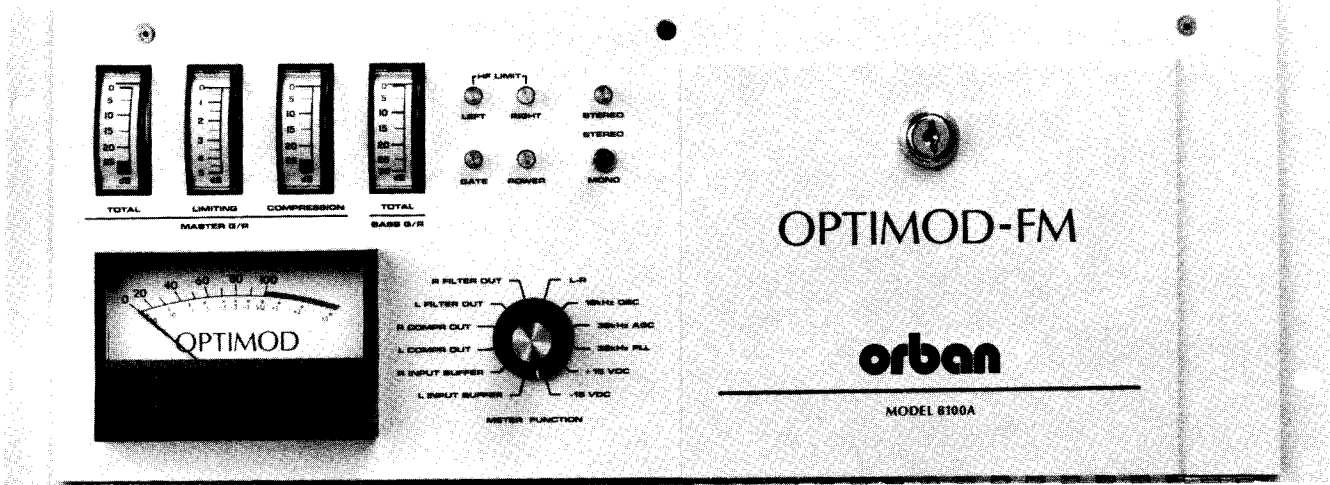

Front Panel

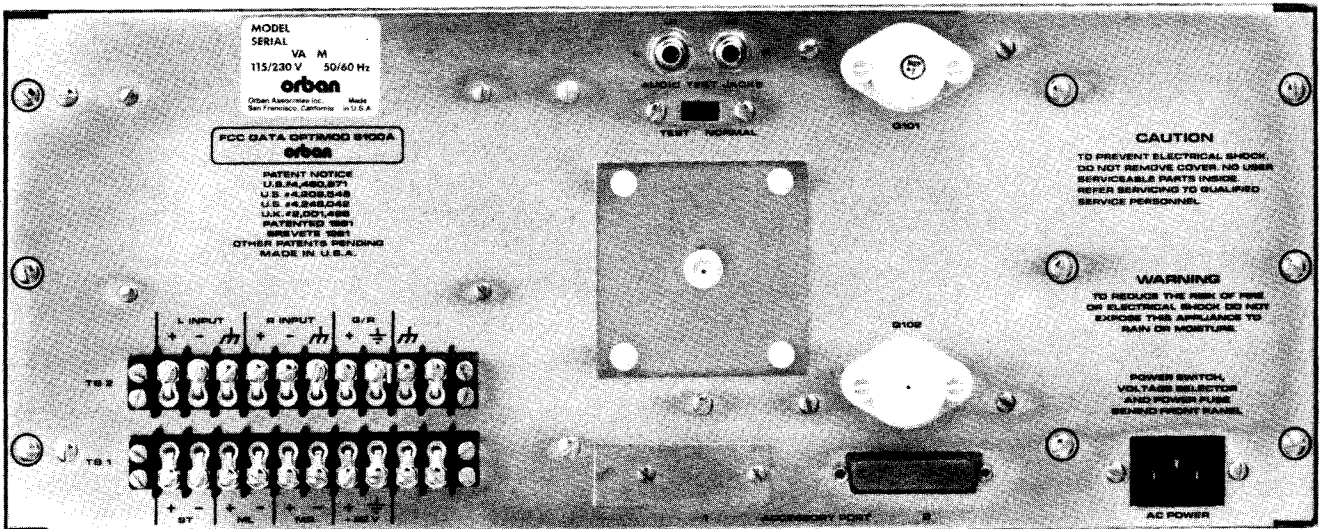

Rear Panel

Table of Contents

INTRODUCTION AND SYSTEM DESCRIPTION	1
APPLICATION	2
INSTALLATION	3
INITIAL SETUP PROCEDURE	4
OPERATING INSTRUCTIONS	5
SYSTEM PERFORMANCE VERIFICATION	6
ROUTINE MAINTENANCE	7
<hr/>	
SYSTEM DESCRIPTION	A
CIRCUIT DESCRIPTION	B
USER ACCESS	C
FIELD AUDIT-OF-PERFORMANCE PROCEDURE	D
FIELD ALIGNMENT PROCEDURE AND SPECIFICATION	E
TRUBLE DIAGNOSIS AND CORRECTION	F
CHANGING PREEMPHASIS	G
DETAILED EXCITER INTERFACE INSTRUCTIONS	H
SCHEMATICS, PARTS LOCATORS, AND PARTS LISTS	J
OMITTED	K
SPECIFICATIONS	L
FUNCTIONS OF JUMPERS ON PC CARDS	M

APPENDICES

Table of Contents

PREFACE

- Registration Card
- Packing Material
- User Feedback Form
- FCC Filing (USA)
- Security (Keys and Locks)

1: INTRODUCTION AND SYSTEM DESCRIPTION

- 1-1 Function Of OPTIMOD-FM
- 1-2 Fig. 1-1: Signal Flow Diagram
- 1-3 Simplified System Description
- 1-3 Input Conditioning Filter
- 1-3 Dual-Band Compressor
- 1-4 Preemphasis and High Frequency Limiter
- 1-4 FM Smart Clipper
- 1-4 Frequency-Contoured Sidechain Overshoot Corrector
- 1-5 Stereo Generator
- 1-6 VU Meter
- 1-7 Studio Accessory Chassis
- 1-7 Six-Band Limiter Accessory Chassis
- 1-8 FM Filter Card

2: APPLICATION

- 2-1 Studio-Transmitter Links
- 2-2 Exciters
- 2-3 RCA BTE-15 Exciter
- 2-3 Gates TE1, TE3 Exciters
- 2-3 Collins 310Z/Continental 510R-1 Exciters
- 2-3 RF Amplifiers and Antennas
- 2-3 SCA
- 2-4 Remote Control Functions
- 2-4 Difficult Environments

3: INSTALLATION

- 3-1 Registration Card
- 3-1 Unpacking and Initial Inspection
- 3-1 Physical Examination
- 3-2 Power Considerations
- 3-2 Fig. 3-1: Power Cord Compatibility
- 3-3 Initialization Options

- 3-3 Powerup Mode
- 3-3 Fig. 3-2: Powerup & Mono Mode Jumpers
- 3-3 Mono Mode
- 3-4 Input Attenuator Pads
- 3-3 Fig. 3-3: Input Attenuation Jumpers
- 3-4 Defeating The 30Hz Highpass Filters
- 3-4 Reassembly
- 3-5 Initial Electrical Checkout
- 3-5 Equipment Location
- 3-6 Mounting And Grounding
- 3-6 Input Signal Connections
- 3-6 Studio Chassis Output Connections
- 3-6 Composite Output Connection
- 3-6 Balanced Exciter Input
- 3-7 Unbalanced Exciter Input
- 3-7 Remote Control
- 3-8 Remote Gain Reduction Meter

4: INITIAL SETUP PROCEDURE

- 4-1 Dual-Chassis Alignment
- 4-2 Stereo Generator
- 4-3 Separation
- 4-3 Fig. 4-2: Separation Scope Pattern
- 4-4 Pilot Phase
- 4-4 Fig. 4-3: Pilot Phase Scope Pattern
- 4-4 Fig. 4-4: Pilot Phase Scope Pattern, x10
- 4-5 Program Tests
- 4-5 Fig. 4-5: Setup Controls

5: OPERATING INSTRUCTIONS

- 5-1 Table of Contents
- 5-2 8100A Controls and Meters
- 5-4 Recommended Control Settings
- 5-4 Fig. 1: Recommended Control Settings
- 5-6 Getting the Sound You Want
- 5-7 More About Audio Processing
- 5-7 Some audio processing concepts
- 5-8 Loudness and density
- 5-9 Gain reduction metering
- 5-9 Gating
- 5-9 Spectral balance
- 5-10 High-frequency limiting to reduce distortion
- 5-10 Peak control
- 5-11 Equalization and "missing controls"
- 5-12 Quality of source material
- 5-13 Some Hints to Help You Achieve Your Processing Goals

- 5-8 GETTING THE SOUND YOU WANT
- 5-8 To Obtain More Loudness
- 5-8 To Obtain More Brightness
- 5-8 To Obtain More Bass
- 5-8 To Obtain Less Bass
- 5-8 To Make "Air" Sound Most Like "Program"
- 5-9 To Obtain "Open" Sound
- 5-9 To Obtain A "Heavily-Processed" Sound
- 5-9 To Avoid "Noise Pump-Up"
- 5-9 To Achieve More Subtle Gain Riding
On Wide-Dynamic Range Material
- 5-9 To Avoid Excessive Sibilance

6: SYSTEM PERFORMANCE VERIFICATION

- 6-1 Mono Performance Verification
- 6-1 Stereo Performance Verification
- 6-1 Main Channel
- 6-2 Subchannel
- 6-2 Separation
- 6-3 Crosstalk
- 6-3 38kHz Subcarrier Suppression
- 6-3 Pilot Frequency
- 6-3 Fig. 6-1: Pilot Frequency Test Point
- 6-4 Pilot Injection
- 6-4 Rear-Panel TEST Jacks

7: ROUTINE MAINTENANCE

- 7-1 General
- 7-1 Routine Performance Verification
- 7-1 Stereo Generator Tests
- 7-1 Dynamic Separation
- 7-2 38kHz Suppression
- 7-2 Pilot Injection
- 7-2 Audio Processing

APPENDICES

APPENDIX A: SYSTEM DESCRIPTION

- A-1 General
- A-1 Input Amplifier
- A-1 30Hz Highpass Filter
- A-2 Allpass Phase Scrambler And Preemphasis/Deemphasis
- A-2 Dual-Band "Master/Bass" Compressor
- A-3 Crossover And Bass Clipper
- A-3 Voltage-Controlled Amplifier Operation
- A-4 Compressor Control Circuitry

- A-5 Phase-Corrected Lowpass Filter/Preemphasis
- A-5 High Frequency Limiter
- A-6 FM Smart Clipper
- A-7 Clipper With Dynamic Threshold
- A-7 15kHz Phase-Corrected Lowpass Filter
- A-7 Distortion-Cancelling Sidechain
- A-8 Frequency-Contoured Sidechain Overshoot Compensator
- A-9 Stereo Generator:
- A-10 19kHz Oscillator
- A-10 19kHz Doubler
- A-10 38kHz Filter And Phase Shifter
- A-10 38kHz AGC Loop
- A-10 38kHz Phase-Locked Loop
- A-11 Stereo Modulator
- A-12 Mode Switching Logic
- A-12 Power Supplies

APPENDIX B: CIRCUIT DESCRIPTION

- B-1 General
- B-1 Input Amplifier
- B-1 30Hz Highpass Filter
- B-2 Allpass Phase Scrambler And Preemphasis/Deemphasis
- B-2 Dual-Band "Master/Bass" Compressor
- B-2 Crossover And Bass Clipper
- B-2 Voltage-Controlled Amplifier Operation
- B-3 Compressor Control Circuitry
- B-5 Gain Reduction Metering
- B-6 Gating Circuitry
- B-6 Phase-Corrected Lowpass Filter/Preemphasis
- B-7 Differential Preemphasis And High Frequency Limiter
- B-7 High Frequency Limiter Control Circuitry
- B-8 FM Smart Clipper
- B-8 Clipper With Dynamic Threshold
- B-9 15kHz Phase-Corrected Lowpass Filter
- B-10 2.2kHz Distortion-Cancelling Sidechain
- B-10 Frequency-Contoured Sidechain Overshoot Compensator
- B-11 Stereo Generator:
- B-11 19kHz Oscillator
- B-12 19kHz Doubler
- B-12 38kHz Filter And Phase Shifter
- B-13 38kHz AGC Loop
- B-13 38kHz Phase-Locked Loop
- B-14 L-R Amplifier
- B-15 38kHz Doubly-Balanced Modulator
- B-16 L+R/Mono Path
- B-17 Output Summing Amplifier
- B-17 Mode Switching Logic
- B-17 Unregulated Power Supply
- B-18 +15 Volt Regulator
- B-19 -15 Volt Regulator
- B-19 Miscellaneous Voltage Supplies

APPENDIX C: USER ACCESS

- C-1 Routine Access
- C-1 User Adjustments
- C-1 Line Fuse, Power Switch, and Line Voltage Selector
- C-1 Circuit Cards
- C-1 Service Access
- C-1 General Cautions
- C-2 Cover Removal
- C-2 Access To Area Behind Rear Panel
- C-3 Access To RF Filter Card
- C-3 Access To Unregulated Power Supply Chamber
- C-3 Removal Of Card #1 (The DC Regulator) From Rear Panel And Power Transistor Replacement

APPENDIX D: FIELD AUDIT-OF-PERFORMANCE

- D-1 General
- D-1 Required Equipment
- D-2 Audio Processing
 - D-2 Standard Control Setup
 - D-2 Skeleton Proof
 - D-2 Fig. D-1: 75us Deemphasis Network Schematic
- D-3 Fig. D-2: Standard 75us Preemphasis Graph
- D-4 Operate-Mode Measurements
- D-5 Stereo Generator
 - D-5 Stereo Performance Measurements
- D-6 Crosstalk
- D-6 38kHz Suppression
- D-6 Separation
- D-7 Pilot Phase
- D-7 Remote Control And Logic Verification
- D-8 Optional Measurements Using Spectrum Analyzer

APPENDIX E: FIELD ALIGNMENT PROCEDURE AND SPECIFICATION

- E-1 General
- E-1 Required Test Equipment And Materials
- E-2 Card #1 (Power Supply)
- E-2 Cards #3/#4 (Input Buffer/Input Conditioning Filter/Compressor Audio Path)
- E-4 Card #5 (Compressor Control/Gating Detector)
- E-4 Card #6 (Preemphasis/HF Limiter)
- E-5 Fig. E-1: Deemphasized System Frequency Response
- E-6 Cards #8/#9 (FM Smart Clipper/FCS Overshoot Corrector)
- E-7 Fig. E-2: Distortion Cancellation Swept Response
- E-8 Fig. E-3: Overshoot Compensator Overdriven by 5kHz
- E-8 Card #7 (Stereo Generator)
- E-11 Fig. E-4: Separation Scope Pattern
- E-11 Fig. E-5: Pilot Phase Scope Pattern
- E-11 Fig. E-6: Pilot Phase Scope Pattern, x10

APPENDIX F: TROUBLE DIAGNOSIS AND CORRECTION

- F-1 General
- F-2 Problem Localization Routine
 - F-2 General Principles
 - F-2 Power Supply Tests
 - F-2 VU Meter Techniques
- F-3 Card Swap Technique
 - F-4 Fig. F-1: Card #6 Channel Reversal Jumpers
 - F-4 Cards Common To Both Channels
 - F-4 Failures Not Diagnosed By Card-Swapping
- F-5 CATALOG OF SYMPTOMS AND POSSIBLE CAUSES
- F-9 Factory Assistance
- F-10 Troubleshooting At The Component Level
 - F-10 Troubleshooting IC Opamps
 - F-10 Ordering Replacement Parts
- F-11 Replacing Printed Circuit Board Components
- F-13 Shipping Instructions
- F-13 Circuit Cards
- F-13 Shipping The Complete Chassis

APPENDIX G: CHANGING PREEMPHASIS

APPENDIX H: DETAILED EXCITER INTERFACE INSTRUCTIONS

- H-1 Collins 310Z-1(B)
- H-1 Continental 510R-1 (Collins 310Z-2)
- H-2 Gates (Harris) TE-1 And TE-3
- H-2 RCA BTE-15

APPENDIX J: SCHEMATICS, PARTS LOCATORS, AND PARTS LISTS

- J-1 General
- J-1 Table Of Contents For Appendix J Schematics With Parts Locators
- J-3 Card #PS
- J-5 Card #3/#4
- J-7 Card #5
- J-9 Card #6
- J-11 Card #7
- J-13 Card#8/#9
- J-15 Input Filter
- J-17 Meter Resistor
- J-18 Accessory Port Wiring
- J-21 BLOCK DIAGRAM
- J-23 Parts List
- J-23 Obtaining Spare Parts
- J-34 Vendor Codes

APPENDIX K: OMITTED

APPENDIX L: SPECIFICATIONS

**APPENDIX M: FUNCTIONS OF JUMPERS
ON PC CARDS**

APPENDIX K: OMITTED

APPENDIX L: SPECIFICATIONS

**APPENDIX M: FUNCTIONS OF JUMPERS
ON PC CARDS**

Preface

This Manual is organized into two major sections. The first contains information on how to plan your installation, how OPTIMOD-FM^R interfaces with other station equipment, how to set up and adjust OPTIMOD-FM, how to do an in-system performance verification, and brief comments on routine maintenance. You should read Parts 1, 2, and 3 before attempting to install OPTIMOD-FM.

The second section contains Appendices which provide useful information that you may need at some time during the life of OPTIMOD-FM. This is primarily reference material, and you do not need to digest it to install, set up, or operate your unit.

There is no Index, so the TABLE OF CONTENTS should be used to help you find the information you want. The TABLE OF CONTENTS provides an overview of the organization of the manual, and lists in some detail the topics discussed.

Registration Card: The original purchaser should have received a postpaid Registration Card packed with this manual.

Registration is of benefit to you because it enables us to tell you of new applications, possible performance improvements, service aids, etc., which may be developed over the life of the product. It also provides us with the date of sale so that we may more promptly respond to possible claims under Warranty in the future (without having to request a copy of your Bill of Sale or other proof of purchase).

Please fill in the Registration Card and return it to us.

If the Registration Card has become lost or you have purchased the unit used, please photocopy the image of the card reproduced on the following page and send it to us in an envelope. Use the address shown on the title page.

Do not allow your Dealer to submit the card for you. If he forgets, you can miss important future mailings and may be delayed in obtaining Warranty service.

Packing Material: The carton in which your OPTIMOD-FM was shipped was carefully designed to prevent damage from the stresses ordinarily encountered in commercial shipments. SAVE THE CARTON AND ALL PACKING MATERIAL in case you ever have to ship the OPTIMOD-FM chassis back to the factory for service.

User Feedback Form: We are very interested in your comments about this product. Your suggestions for improvements to either the product or this manual will be carefully reviewed. A User Feedback Form is provided for your convenience. If it is missing, please write us at the address on the title page. Thank you.

FCC Filing (U.S.A): A verification has been filed with the Commission that the stereo generator section of OPTIMOD-FM Model 8100A/1 meets all requirements of FCC 73.322 when used with a direct-FM exciter originally designed with sufficient bandwidth to accept a stereo generator. As of this writing, there is no requirement that the FCC be notified that you have changed stereo generators.

Security (Keys and Locks): To control access to the setup controls, the access door is fitted with a lock. Two keys are supplied. These can be duplicated as desired.

The dealer from whom your 8100A/1 was purchased can supply additional keys, as can the factory. In either case, your Registration Card must be on file at the factory, and you must supply your serial number to obtain replacement keys.

If all keys are lost, you can obtain access by removing the three hex-socket screws from the top of the main front panel with a 5/64" hex wrench (one was supplied with the unit).

If you wish to make the unit's adjustments more secure, obtain similar splined-socket or aircraft tri-point screws (and tools), and use these in place of the hex-socket screws supplied. (Tools for these are not commonly found in hardware stores or other places D.J.'s might frequent.) The screws are 6-32 x 3/8" 82° flathead, nickel-plated steel.

Registration Card			
Model # _____	Serial # _____	Purchase Date _____	
Your name _____		Title _____	
Company _____		Telephone _____	
Street _____			
City, State, Mail Code (Zip), Country _____			
Nature of your product application _____			
How did you hear about this product? _____		Purchased from _____	
Comments _____			
Which magazines do you find the most useful to your job?			
<input type="checkbox"/> Audio	<input type="checkbox"/> Broadcast Engineering	<input type="checkbox"/> Broadcast	<input type="checkbox"/> dB Magazine
<input type="checkbox"/> Electronic Musician	<input type="checkbox"/> EQ	<input type="checkbox"/> Millimeter	<input type="checkbox"/> Mix
<input type="checkbox"/> Post	<input type="checkbox"/> Pro Sound News	<input type="checkbox"/> Radio & Records	<input type="checkbox"/> Radio World
<input type="checkbox"/> RE/P	<input type="checkbox"/> Sound & Communications	<input type="checkbox"/> S & VC	<input type="checkbox"/> TV Broadcast
<input type="checkbox"/> TV Tech	_____	_____	_____
<input type="checkbox"/> _____	_____	_____	_____
95101-000-07 5/90			

Duplicate Registration Card

PART 1:
Introduction

Function of OPTIMOD-FM: OPTIMOD-FM is an integrated signal-processing system which replaces conventional compressors, limiters, clippers, and stereo generators. Each part of the OPTIMOD-FM system has been precisely engineered to be compatible with all other parts to achieve optimum performance.

OPTIMOD-FM should be fed unprocessed audio. NO OTHER AUDIO PROCESSING IS NECESSARY, OR DESIRABLE.

Briefly, the OPTIMOD-FM system performs the following functions:

1. It rides gain over a range of as much as 25dB, compressing dynamic range and compensating for gain riding errors on the part of operators. The amount of dynamic range reduction ordinarily produced is adjustable. When OPTIMOD-FM is operated with an optimum release time setting, gain riding and compression are virtually undetectable because of advanced program-controlled time constants and multiband compression.
2. It prevents aliasing distortion in the stereo generator by means of bandwidth-limiting 15kHz lowpass filters. Full overshoot compensation is provided for these filters. OPTIMOD-FM thus provides extremely tight control over peak modulation, preventing overmodulation and controlling the baseband spectrum simultaneously.
3. When OPTIMOD-FM's dual-band compressor is operated in "independent" mode, OPTIMOD-FM can make audio quality more consistent by correcting frequency balances between bass and midrange material. When operated in "wideband" mode, OPTIMOD-FM will preserve frequency balances and will produce an output which sounds almost precisely like its input.
4. OPTIMOD-FM prevents peak overload and overmodulation due to the effects of the FM preemphasis curve.
5. OPTIMOD-FM generates a stereo baseband signal with outstanding separation, low crosstalk, and vanishingly low distortion and spurious components.

Optional accessories for the OPTIMOD-FM provide for separate studio and main chassis (8100A/ST), six-band limiting (8100A/XT), and special filtering (Accessory Kit 22). These accessories are discussed in greater detail at the end of this part of the Operating Manual.

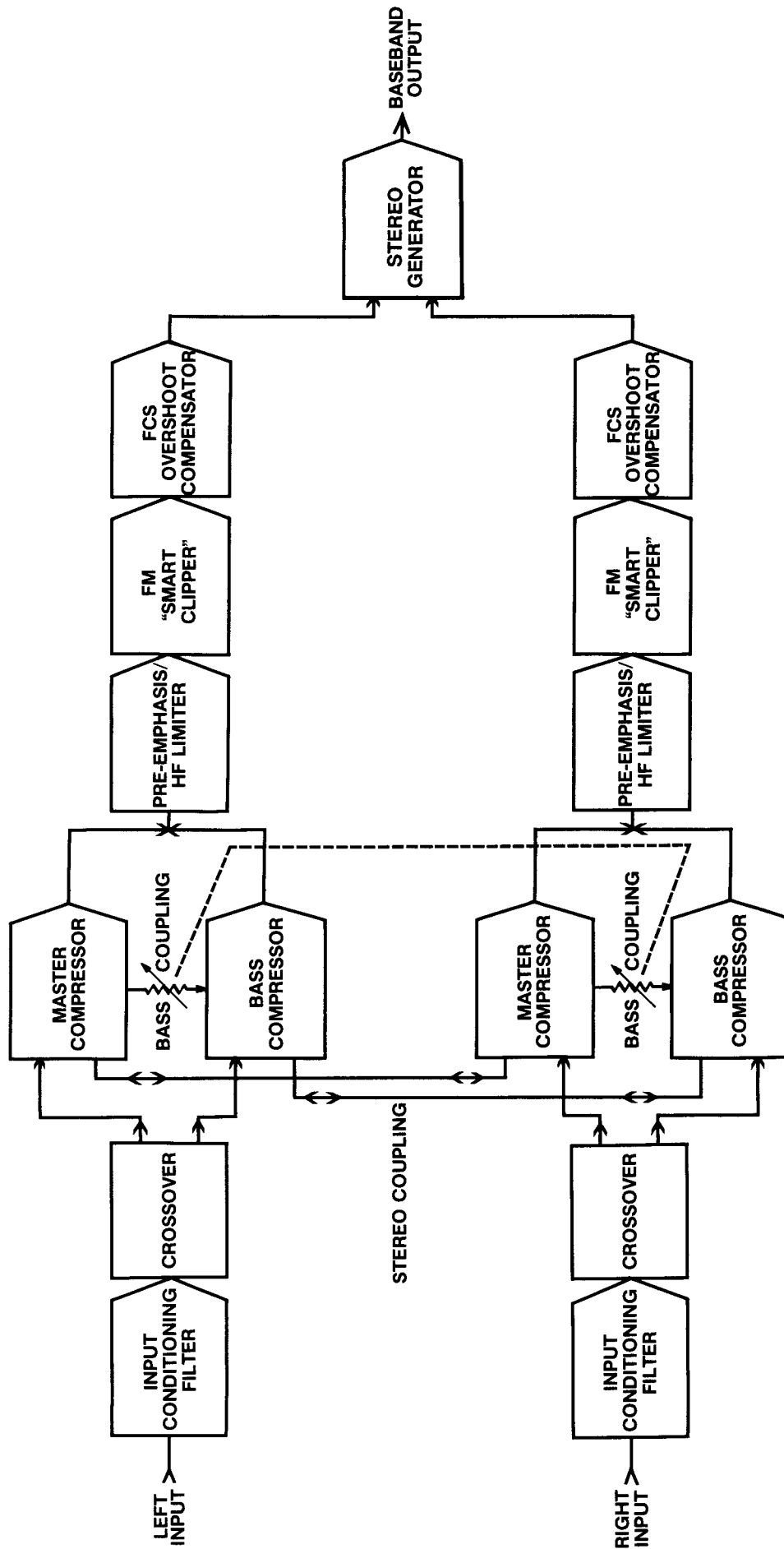

Fig. 1-1: OPTIMOD-FM Model 8100A/1 Signal Flow Diagram

SIMPLIFIED SYSTEM DESCRIPTION

OPTIMOD-FM Model 8100A/1 consists of six basic blocks. See cover and figure 4-5 for illustration of controls.

1. Input Conditioning Filter: This consists of an allpass phase scrambler to make peaks more symmetrical (thus reducing clipping distortion and permitting higher loudness), and a 30Hz 18dB/octave highpass filter to prevent subsonic information from disturbing the operation of the audio processing or exciter's AFC's. Even if an AFC doesn't unlock, it can attempt to "track" subsonic information, thus producing IM distortion. The 30Hz highpass filter can be defeated (although we have purposely made it slightly inconvenient to do so); the phase scrambler is an essential part of the system and is non-defeatable.

2. Dual-Band Compressor: This consists of two compressors in parallel: "Bass" which processes audio below 200Hz (12dB/octave crossover), and "Master" which processes above 200Hz. A BASS COUPLING control adjustable by the user determines if the two bands will operate discriminately ("independent" mode), or if the "Bass" band will be forced to track the "Master" band ("wideband" mode), thus preserving frequency balances. Intermediate partial-crosscoupling settings are also available.

Even in "wideband" mode, the bass control loop is still active. Therefore, heavy bass will cause a momentary reduction in the gain of the "Bass" band rather than forcing gain reduction of the entire signal (as in a true wideband system), thus avoiding pumping.

Time constants and other parameters of the Dual-Band Compressor have been adjusted so that the summed and preemphasized output of the two bands can be connected directly to the FM Smart ClipperTM. No further gain reduction is required for distortion control, and maximum naturalness is preserved.

The threshold of limiting is adjustable over a 6dB range by the CLIPPING control. This determines the output level of the compressor, and thus the amount of HF limiting and clipping which occur later in the system.

The release time of the "Master" band only is adjusted with the RELEASE TIME control, thus permitting loudness/fatigue tradeoffs according to format requirements.

Both "Master" and "Bass" compressors are gated such that the release time is slowed by a factor of approximately 50:1 when the input level drops below a threshold adjustable by the GATE THRESHOLD control. This prevents noise rush-up during program pauses, and makes the 25dB gain reduction range usable. Simultaneously, the gain does not get "stuck" forever, so low-level musical passages are eventually increased in level. Since gain recovery takes over one minute to occur in GATED mode, the gradual increase in level cannot be perceived.

Gain reduction in both "Master" and "Bass" compressors is metered by edgewise-reading meters calibrated with a dB-linear scale. To provide best value, no attempt has been made to make these meters extremely accurate, and their readings may disagree with the actual gain reduction by as much as $\pm 20\%$. This accuracy is fully adequate for the purpose, since the amount of gain reduction varies widely with variations in program material and operator gain riding.

3. Preemphasis And High Frequency Limiter: The summed outputs of the two compressors are applied to a phase corrector, 24dB/octave 15kHz lowpass filter, preemphasis network, and high frequency limiter. The purpose of the lowpass filter is to prevent out-of-band components from affecting the operation of the high frequency limiter and to avoid intermodulation between out-of-band frequency components and in-band frequency components in the clipper. Phase correction reduces the peak level increase caused by filter ringing and preemphasis to the theoretical minimum, thus reducing the amount of clipping.

The high frequency limiter is controlled by high frequencies only (rather than by the peak level of the preemphasized signal, as in the old Model 8000A), thus eliminating any possibility of modulation of high frequency content by low frequency material.

The threshold of limiting of the high frequency limiter is user-adjustable over a 3dB range, permitting brightness and high frequency distortion to be traded off according to format requirements. Because the FM Smart Clipper incorporates IM distortion cancellation, substantially more clipping can be accomplished without objectionable distortion than in the old Model 8000A, and significantly improved high frequency power handling capability is achieved through the system.

4. FM Smart Clipper: The Smart Clipper provides the peak limiting function, and contains filters to assure that the clipping does not introduce out-of-band frequency components above 19kHz which could cause aliasing distortion.

The output of the HF limiter is applied to a clipper with automatically-varying threshold. This clipper performs the basic peak limiting function. The output of the clipper is subtracted from its input, thus deriving the distortion added by the clipper. This distortion component is lowpass filtered at 2.2kHz (the knee of the 75us preemphasis curve), and then added to the clipped signal. This "smoothing signal" cancels all clipper-induced distortion below 2.2kHz by 30dB or more, and is particularly effective in eliminating the effects of high-frequency IM, such as sibilance splatter.

The 2.2kHz distortion-cancelling lowpass filter has a time delay. To assure proper distortion cancellation, the main clipped signal must be delayed by an equal amount before the main signal and distortion-cancelling signal are added. The main signal is delayed by a phase-corrected 15kHz lowpass filter, which also removes all out-of-band harmonics caused by the clipping process.

5. Frequency-Contoured Sidechain (FCS) Overshoot Corrector: The output of the Smart Clipper contains overshoots due to the addition of the distortion-cancelling signal, and due to unavoidable overshoots in the 15kHz filter. These overshoots must be eliminated without adding out-of-band frequency components. This is done in the FCS Overshoot Corrector.

The FCS circuit first derives that part of the signal exceeding the 100% modulation point by means of a "center clipper". If these overshoots were then subtracted from the input signal, the overshoots would be cancelled -- in fact, doing so would be equivalent to simple clipping. Unfortunately, this can't be done because the overshoots contain out-of-band frequency components which would cause aliasing distortion if applied directly to the stereo generator.

We therefore lowpass-filter the overshoots to eliminate out-of-band components. If the overshoot filter had a flat response to its cutoff frequency, this filtering action would reduce the amplitude of high-frequency overshoots (by removing out-of-band harmonics which make the overshoots "spikey"). This would result in incomplete cancellation of the overshoots after subtraction. The overshoot filter is therefore designed to have a rising response at 15kHz, effectively increasing the gain of the fundamentals of the higher-frequency overshoots and compensating for the fact that their harmonics have been removed. The overshoot extractor and this filter are the "Frequency-Contoured Sidechain".

The overshoot filter has phase shift. Phase shift networks are therefore included in the main path to make sure that the overshoot subtraction process works correctly, and that the overall FCS system has constant time delay.

The rising response of the overshoot filter means that essentially no extra subtraction gain (compared to the system operated without the filter as a simple differential clipper) is required. Any low frequency IM introduced by the FCS circuit is therefore no worse than the low-frequency IM caused by a simple clipper.

Because the FCS circuit is an instantaneous system and uses no gain reduction or dynamic filtering, it causes neither pumping nor dulling of program material.

6. Stereo Generator: The stereo generator accepts the processed outputs from the left and right FCS circuits, and produces the stereo baseband signal. It is characterized by high stability, very low distortion, and minimal spurious outputs. 19kHz oscillator level, pilot phase, and separation are all controlled and stabilized by means of servo loops.

The stereo baseband is generated by the "matrix" technique, as opposed to the more common "switching" design. The "matrix" design modulates only the L-R component, and passes the L+R component through to the output without degradation due to switching. Since the L+R component almost always dominates, this results in maximum audio quality. In addition, no baseband lowpass filter is required. Such a filter would add to system cost, and could compromise separation.

To facilitate adjustment of pilot phase and measurement of main-channel-to-subchannel and subchannel-to-main-channel crosstalk, two special TEST modes are provided. These apply the right channel audio directly to the main or sub inputs of the stereo generator. For testing, these stereo generator audio inputs can be accessed by means of a pair of TEST jacks on the rear chassis apron. This provides an alternate means of measuring crosstalk and other stereo generator performance parameters.

The stereo generator can be operated in STEREO, MONO LEFT, or MONO RIGHT modes. All three modes can be selected by remote control by means of optically-isolated remote control terminals. STEREO and one of the two MONO modes can be selected locally by means of a front-panel switch. An internal strap determines which of the two MONO modes is selected. Another internal strap determines which of the three modes will be entered on powerup.

VU Meter: The front-panel VU meter can monitor the level of the left and right audio at three different points in the circuitry. (See **Block Diagram** [p. J-21] for metering points.) The meter also monitors the difference between left and right channels (L-R) to aid channel balance adjustments.

Three stereo generator parameters are monitored: 19kHz pilot oscillator level, 38kHz AGC control voltage, and 38kHz Phase-Locked Loop control voltage. The latter two readings will vary, and are used to check whether these servo loops are within their ordinary operating range, or whether they are saturated.

Finally, the +15 and -15V power supply voltages are monitored.

Accessories Currently Available:

8100A/ST
STUDIO ACCESSORY
CHASSIS

(A separate manual is supplied with this unit.)

In some installations, it may be desirable to perform the compression function ahead of the STL to optimize system signal-to-noise ratio by relaxing STL headroom requirements. (STL's are discussed further in **Part 2**). The Model 8100A/ST Accessory Chassis (which performs this function) consists of a chassis shell assembly with a power supply/metering card and three empty card locations. Cards #3, #4, and #5 (the Dual-Band compressor cards) are removed from the Main Chassis and installed in these locations. Dummy cards provided with the Accessory are then installed in the Main Chassis to preserve the signal path.

The Accessory Chassis provides convenient access at the studio to all operating controls except for H-F Limiting and stereo/mono mode switching. It provides the same gain reduction metering as the Main Chassis, and several diagnostic metering functions as well.

More complete information about the 8100A/ST is provided in a separate manual shipped with the unit.

8100A/XT
SIX-BAND LIMITER
ACCESSORY
CHASSIS

(A separate manual is supplied with this unit.)

The optional 8100A/XT Accessory Chassis has been created to provide aggressive multiband processing for stations that desire bright, loud, "highly-processed" audio. Derived from OPTIMOD-AM Model 9100A, 8100A/XT consists of a stereo bass equalizer which drives a stereo six-band limiter cascaded with the exclusive Orban distortion-cancelling multiband clipping system. When added to the basic 8100A/1 system, the 8100A/XT creates a dense, consistent sound without pumping or other obvious processing artifacts.

Functionally, the unit replaces the high frequency limiter within the 8100A/1 and permits the following objectives to be met:

- For most types of program material, increased loudness for a given level of audible processing side-effects (by comparison to an unmodified 8100A/1 or 8100A);
- Improved consistency from source to source due to the "automatic equalization" effect of the six-band limiter; and,
- Increased presence and intelligibility on smaller radios and in autos.

The 8100A/XT is most appropriate for contemporary popular music formats, although its ability to improve consistency and intelligibility can make it useful for talk and news formats as well. It is generally unsuited for "beautiful" or classical formats.

The Model 8100A/1 is prewired to readily accept the 8100A/XT. (Older 8100A's must be converted by means of retrofit kit "RET-27" before they can accept the 8100A/XT.)

The 8100A/XT uses a great deal of the existing 8100A/1 circuitry in the interest of achieving efficiency and economy. The 8100A/XT (which requires two rack units) is mounted directly below the 8100A/1 and is then plugged into a multipin connector on its rear panel. Jumpers on Cards #5, #6, #8, and #9 within the 8100A/1 must then be moved according to instructions in a manual supplied with the 8100A/XT.

The normal positions of 8100A/1 card jumpers when the 8100A/XT is not in use are tabulated in **Appendix M** of this Manual.

The 8100A/XT is fully compatible with the Studio Accessory Chassis Model 8100A/ST, allowing use of the 8100A/XT in either single- or split-chassis installations. In all cases, the 8100A/XT is mounted immediately below the main (8100A/1) chassis.

Full instructions for installing and operating the 8100A/XT are included in the **Operating Manual** for that unit. That Manual also includes a complete discussion of the 8100A/XT's principles of operation, how it relates to the 8100A/1, and other information important to those who plan to use the unit.

ACCESSORY KIT 22: (Separate installation and alignment instructions are included in this kit.)
FM FILTER CARD (#0)

The OPTIMOD-FM Model 8100A/1 has been designed to meet all FCC Rules regarding crosstalk between the main channel and subchannel and vice-versa. However, higher performance than this is sometimes desirable to fully protect SCA subcarriers from interference caused by the operation of the 8100A/1's safety clippers (on cards #8 and #9) on extremely densely-processed program material.

Card #0 replaces each safety clipper with two cascaded overshoot-compensated lowpass filters. This reduces "splatter" in the SCA region of the baseband by 25-30dB compared to the "stock" 8100A, and simultaneously reduces any residual overshoot by about 5%. This processing can achieve loudness within 0.3dB of that produced by composite clipping (an inaudible difference), while protecting the SCA region about 40-50dB better than a composite clipper.

Card #0 is installed in the signal path between the output of the existing cards #8/9 and the input of card #7 (stereo generator). The frequency response of the card is typically +0, -0.1dB, 30-15,000Hz. An 8100A/1 containing this card will therefore perform well within its ± 0.75 dB specification.

Card #0 has been specifically designed to be used in conjunction with the 8100A/1's existing FCS Overshoot Corrector. Card #0 is therefore unusable with our older Optimod-FM Model 8000A, or with other manufacturers' equipment.

This concludes the **Introduction and Simplified System Description**. The next part of this manual (**Application**) should now be read carefully to assure that your installation produces optimum results.

PART 2:

Application

2

This Part of the Manual provides essential information on how OPTIMOD-FM fits in with the rest of the equipment at your station. **Appendix K** contains further information on achieving high audio quality.

Studio/Transmitter Links: There are five types of studio/transmitter links in common use internationally in FM stereo service. These are:

- 1) Analog land-lines (telephone lines)
- 2) Dual-microwave STL's
- 3) Composite baseband microwave STL's
- 4) PCM (Pulse-Code Modulation) links
- 5) Video STL's with PCM adapters

All except (3) carry both audio channels either directly, or in some encoded form other than the standard 19kHz "pilot tone" stereo baseband. These links are ordinarily fed both left and right audio channels in non-encoded form, and their receiver output is the regenerated left and right channels.

The composite STL (3) carries the standard "pilot tone" stereo baseband, and is therefore fed from the output of a stereo generator like the one in the 8100A/1. The receiver output of the composite STL is the stereo baseband signal, which is applied directly to wideband input of the FM broadcast transmitter's exciter.

In general, highest quality is obtained by use of a composite microwave STL provided that a line-of-sight transmission path of less than 10 miles or so exists between studio and transmitter. If not, RF signal-to-noise ratio, multipath distortion, and diffraction effects can cause serious quality problems.

The dual-microwave system provides more noise immunity. However, problems include gain- and phase-matching of the left and right channels, preemphasis-induced overloads, and requirements that the audio applied to the microwave transmitters be processed to prevent overmodulation.

Land-line quality is extremely variable, ranging from excellent to atrocious. The decision on whether to employ land-lines depends a great deal on the quality locally available. However, even the best land-lines tend to slightly veil audio quality due to line equalizer characteristics, phase shifts, and repeaters of indifferent quality.

PCM links are generally unavailable in the USA as of this writing, although they are widely used in Europe. They achieve good noise performance and consistency at the expense of a very sharp high-frequency cutoff, rapid changes in group delay around cutoff (unless elaborate phase equalization is used), and quantization distortion. At the moment, there is considerable disagreement over how elaborate the coding must be to render quantization distortion inaudible to critical listeners, and no PCM system should be accepted without critical listening tests.

Some stations are sending PCM-encoded audio through a video STL at frequencies above 20GHz. Typically, consumer PCM adapters (from Sony or dbx, for example) are being used. The quality of signal received at the transmitter through this type of STL is high.

OPTIMOD-FM Model 8100A/1 is available in either single- or dual-chassis configurations. The dual-chassis splits the system at a point between the output of the Dual-Band Compressor and the input of the HF Limiter.

The dual-chassis configuration is ordinarily used with STL's of types (1), (2), and (4) of modest performance characteristics. By performing initial compression before the STL input, the dual-chassis version can prevent STL overload and can aid in achieving superior STL signal-to-noise ratio.

The single-chassis arrangement is suited for composite STL's, or for installations where studio and transmitter are at the same site or are connected by short, high-quality lines. Because it is less expensive than the dual-chassis version, the single-chassis version is also suited for use with any STL having extremely wide dynamic range (80dB or better) such that unprocessed audio can be passed to the compressor without danger of noise build-up when the compressor's gain increases towards its maximum.

It is important to note that the compressor section alone does not control peak levels accurately, and does not compensate for overloads caused by preemphasis. (Peak limiting and high frequency limiting are performed later in the system.) It is therefore necessary to allow headroom in the STL to accommodate compressor overshoots. If the STL is preemphasized at 50 or 75us (as is the case with many dual-microwave systems), further headroom must be allowed to accommodate the peak level increases caused by the preemphasis. Precise STL setup recommendations are provided in **Part 4** of this Manual.

If STL preemphasis can be readily modified, use of 25us preemphasis will match headroom to the typical spectral distribution of contemporary recorded material, thus achieving optimum STL signal-to-noise ratio.

Exciters: OPTIMOD-FM will interface with most direct-FM exciters although some older exciters designed before FM stereo standards were adopted may have to be modified to extend their bandwidths. If an input transformer is an essential part of such an older exciter (driving a push-pull input or providing a bias path for the input stage, for example), it may be possible to replace such a transformer with a Western Electric 111C coil. When loaded with 470 ohms, these coils can pass a stereo composite signal such that all requirements in part 73.322 of the FCC Rules are met.

WARNING!
(U.S.A. customers)

Exciter modifications must conform to the requirements of 73.257 of the FCC Rules.

OPTIMOD-FM cannot be used with exciters using phase modulators. Such exciters include PhasotronTM and SerrasoidTM designs.

In general, modern solid-state exciters provide both vastly improved reliability and audible improvements in sound quality when compared to pre-1961 designs, and such older exciters should be retired if at all possible. In fact, the latest generation of exciters provides audibly improved performance over the earlier generation of solid-state units as well.

To our knowledge, the baseband output of OPTIMOD-FM can be directly connected without additional interfaces to the wideband input of all direct-FM exciters designed after 1963, with the exception of the following:

RCA BTE-15: Obtain a jumper plug directly from Orban.

Gates (Harris) TE-1, TE-3: Obtain the Orban Associates ATE-3F wideband interface panel, which fits in the chassis in place of the TE-3 stereo generator.

Collins 310Z-1: Obtain a factory update from Continental to convert to a 510R-1, and obtain the 785E-1 wideband interface card directly from Continental.

Continental 510R-1 (Collins 310Z-2): Obtain a wideband interface card directly from Continental.

Most wideband inputs are BNC connectors, and require a BNC-to-BNC shielded cable to connect to OPTIMOD-FM. Ordinarily, RG-58A/U cable should be used. (The Collins A830-2 exciter has an RCA phono jack input, and requires a BNC-to-RCA cable.)

Detailed information for interfacing OPTIMOD-FM with the BTE-15, TE-1, TE-3, 310Z-1, and 310Z-2 exciters is found in **Appendix H**.

RF Amplifiers And Antennas: It is important that the RF amplifier and antenna be sufficiently wideband to pass all sidebands of the FM signal without attenuation or phase shift. Ideally, the bandwidth should exceed 500kHz. Narrowband amplifiers and/or antennas may make the highs sound "gritty". This may become particularly noticeable due to the 8100A/1's outstanding high frequency power handling capability.

Any audible degradation can be assessed by using a high-quality FM tuner in "wideband" mode to compare the sound normally produced on the air with the sound produced by picking up the output of the exciter alone. The exciter must be correctly terminated by a resistive 50-ohm load. (If you leave it connected to the transmitter, VSWR resulting from impedance mismatches between exciter and RF amplifier can also cause distortion.) A tuner is specified because many modulation monitors use older design techniques and are unsuited for accurately assessing audio of exceptional quality.

SCA: OPTIMOD-FM operates well with SCA's because OPTIMOD-FM provides excellent baseband spectrum control, thus protecting that part of the baseband occupied by the SCA. No special SCA precautions need be taken; SCA should be implemented according to the instructions of the exciter manufacturer.

Although the 8100A/1 has been designed to meet all FCC Rules regarding crosstalk between the main channel and subchannel, extremely densely-processed program material may make it desirable to more fully protect SCA subcarriers from interference caused by the operation of the 8100A/1's safety clippers. The optional FM Filter Card (available as Accessory Kit 22) replaces each safety clipper with two overshoot-compensated lowpass filters. This processing can achieve loudness within 0.3dB of that produced by composite clipping (an inaudible difference), while protecting the SCA region about 40-50dB better than would a composite clipper.

Older exciters may not have separate SCA inputs. In most cases, one can be added simply by passively summing into the modulated oscillator through a resistor and small capacitor. Note, however, that such older exciters often suffer from narrow RF bandwidths which may cause SCA "birdies" due to intermodulation. Such problems may also occur if SCA injection is not limited to 10% modulation and deviation to $\pm 4\text{kHz}$.

If you are using a composite STL, be sure to limit SCA modulation to the amount recommended by the STL manufacturer or IM between the SCA and the main program may occur in the STL.

Remote Control Functions: OPTIMOD-FM's three operating modes (STEREO, MONO LEFT, and MONO RIGHT) can be selected by remote control. The MONO LEFT and MONO RIGHT functions are useful in the case of failure of one channel of the STL or one channel of 8100A/1 audio processing. The good channel can be fed in mono, and programming can be continued by selecting the good channel and MONO mode.

The remote control ports are easily interfaced with virtually all commercial remote controls.

A remote TOTAL MASTER GAIN REDUCTION meter can also be fitted to enable the operator to observe the amount of gain reduction his levels are producing.

Details on how to interface the remote functions is provided in **Part 3** of this manual.

DIFFICULT ENVIRONMENTS

1. Where humidity is typically high, the environment should be controlled to prevent moisture from condensing on circuit cards of all plant equipment, including OPTIMOD-FM, as this can degrade performance. Using some of the exhaust from the transmitter to heat the building slightly above ambient temperature is often sufficient to prevent problems.
2. If electrical storms are frequent, it may be advisable to add suitable varistors between each incoming wire (AC, remote control, and audio) and a solid earth ground as indicated by local experience.
3. After a power failure, bear in mind that the stereo generator mode-control logic will come up according to the power-up mode for which it was strapped (see **Initialization Options** in **Part 3**), unless the power interruption was less than one second or so. In this case, the powerup circuitry may not have sufficient time to reset, and an undesired mode may be entered.

PART 3:
Installation

3

Registration Card: If you have not already done so, please fill out the Registration Card fully and mail it to the factory. (See **Preface**.)

Unpacking And Initial Inspection: You are now ready to proceed with unpacking and installation of your OPTIMOD-FM.

Sometime during the life of your OPTIMOD-FM, you may wish to re-ship or return it. Since it is expensive and heavy, it is advisable to ship it only in the original packing materials which have been carefully designed to protect it. For this reason, it is wise to mentally note the method of packing and to save all packing materials.

If you might be returning it:

--Don't cut the grounding pin from the power cord (use the adapter provided if you must defeat the safety grounding provision);

--Set the unit only on soft, clean surfaces to prevent damage to painted or plated surfaces (a folded newspaper will do);

--Use the nylon-washer rack screws supplied to protect the panel from paint chipping.

Sage advice for repacking and reshipping your unit is contained at the end of **Appendix F**.

Various items are packed with OPTIMOD-FM:

- (1) Line Cord
- (4) 10-32x3/4" Rack Screws
- (1) 3-wire AC Adapter (USA)
- (1) Operating Manual
- (1) 5/64" Allen Wrench (for front panel screws)
- (2) Keys For Adjustment Door
- (1) 24" BNC-to-BNC Cable (for composite output)
- (2) 620-ohm $\pm 5\%$ 1/4-watt carbon film resistors
(for input termination, where required)
- (1) Final Factory Qualification Test Results

Physical Examination: Perform a general inspection of the perimeter of the unit to check for obvious damage.

DAMAGE CLAIMS MUST BE MADE BY YOU AGAINST THE CARRIER IMMEDIATELY UPON DISCOVERY. Save packing and other evidence of damage for the carrier's inspector.

PART 3:
Installation

3

Registration Card: If you have not already done so, please fill out the Registration Card fully and mail it to the factory. (See **Preface**.)

Unpacking And Initial Inspection: You are now ready to proceed with unpacking and installation of your OPTIMOD-FM.

Sometime during the life of your OPTIMOD-FM, you may wish to re-ship or return it. Since it is expensive and heavy, it is advisable to ship it only in the original packing materials which have been carefully designed to protect it. For this reason, it is wise to mentally note the method of packing and to save all packing materials.

If you might be returning it:

--Don't cut the grounding pin from the power cord (use the adapter provided if you must defeat the safety grounding provision);

--Set the unit only on soft, clean surfaces to prevent damage to painted or plated surfaces (a folded newspaper will do);

--Use the nylon-washer rack screws supplied to protect the panel from paint chipping.

Sage advice for repacking and reshipping your unit is contained at the end of **Appendix F**.

Various items are packed with OPTIMOD-FM:

- (1) Line Cord
- (4) 10-32x3/4" Rack Screws
- (1) 3-wire AC Adapter (USA)
- (1) Operating Manual
- (1) 5/64" Allen Wrench (for front panel screws)
- (2) Keys For Adjustment Door
- (1) 24" BNC-to-BNC Cable (for composite output)
- (2) 620-ohm $\pm 5\%$ 1/4-watt carbon film resistors
(for input termination, where required)
- (1) Final Factory Qualification Test Results

Physical Examination: Perform a general inspection of the perimeter of the unit to check for obvious damage.

DAMAGE CLAIMS MUST BE MADE BY YOU AGAINST THE CARRIER IMMEDIATELY UPON DISCOVERY. Save packing and other evidence of damage for the carrier's inspector.

Set the unit on a flat, soft surface. Remove the three hex-socket screws at the top of the front panel using the wrench provided. The front panel, which is hinged at the bottom, will then tilt downward and reveal the interior. Look for IC's or other loose parts which may have fallen out during shipment.

Remove the subpanel through which the controls protrude by twisting the four DZUS fasteners 1/4 turn counterclockwise. Tilt the panel to remove it. This reveals the "card cage".

Various components are mounted in sockets for servicing convenience. It is possible (but improbable) that a component could be dislodged by heavy shocks in shipment.

Starting at the left, using the card ejector tabs, carefully remove each card in turn, examine it, and replace it. Make sure that all components are properly seated in their sockets. Check with particular care to make sure that none of the can-type IC's are held in their sockets by one row of leads only.

Power Considerations: OPTIMOD-FM will operate on 115/230V $\pm 15\%$ 50-60Hz AC power. Without applying power to the line cord, turn the power switch ON and check the position of the LINE VOLTAGE SELECTOR switch. Units are shipped with this switch in the "115 Volt" position, unless labeled otherwise on the line cord. Adjust the selector switch so that the appropriate voltage is indicated. (If OPTIMOD-FM is installed within a transmitter, 230V may be the only power available.) Check the fuse, and replace with the following values if necessary:

- 115 VOLT: 1/2 Amp, 1/4 x 1 1/4 SLO-BLO (or 5 x 20 mm, type T)
- 230 VOLT: 1/4 Amp, 1/4 x 1 1/4 SLO-BLO (or 5 x 20 mm, type T)

AC connection to the chassis is made through an RF filter with IEC-standard mains connector. This filter is designed to meet the standards of all international electrical safety authorities, and leaks less than 0.5mA to the chassis when operated from 230V mains.

A U.S.A.-standard "U-ground" power cord is supplied to connect to the IEC socket, unless a different cord and connector is ordered. Users in other countries will ordinarily be able to easily obtain a power cord compatible with their country's standard. If you choose to cut the "U-Ground" plug from the cord and replace it with a plug appropriate to your standards, refer to Fig. 3-1 below.

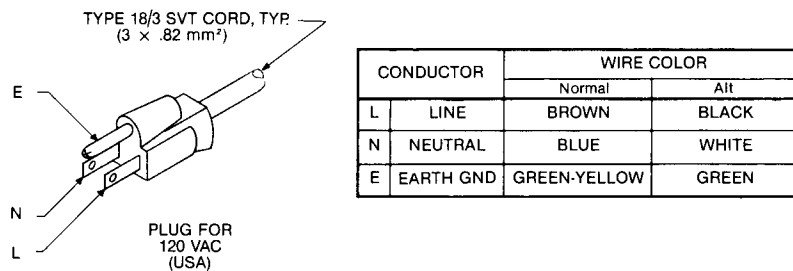

Fig. 3-1: AC Mains Cord Detail

In areas where power lines are frequently struck by lightning, it may be advisable to connect voltage-dependent resistors (varistors) between each side of the line and earth, sized according to local experience.

Initialization Options: This section describes how to change certain operating characteristics of OPTIMOD-FM to suit your needs. If your needs correspond to the "factory-standard" characteristics, then no modifications need to be made, and you may skip to **Reassembly** below. **Appendix M** provides a quick summary of all 8100A/1 jumper options.

All modifications are made on the plug-in circuit cards. If the steps regarding physical inspection above have been followed, the cards are now readily accessible.

- 1) **Powerup Mode:** OPTIMOD-FM is shipped to power up in STEREO mode. To restrap so that it powers up in either MONO LEFT or MONO RIGHT mode, you must move a jumper plug on Card #7 according to Fig. 3-2.

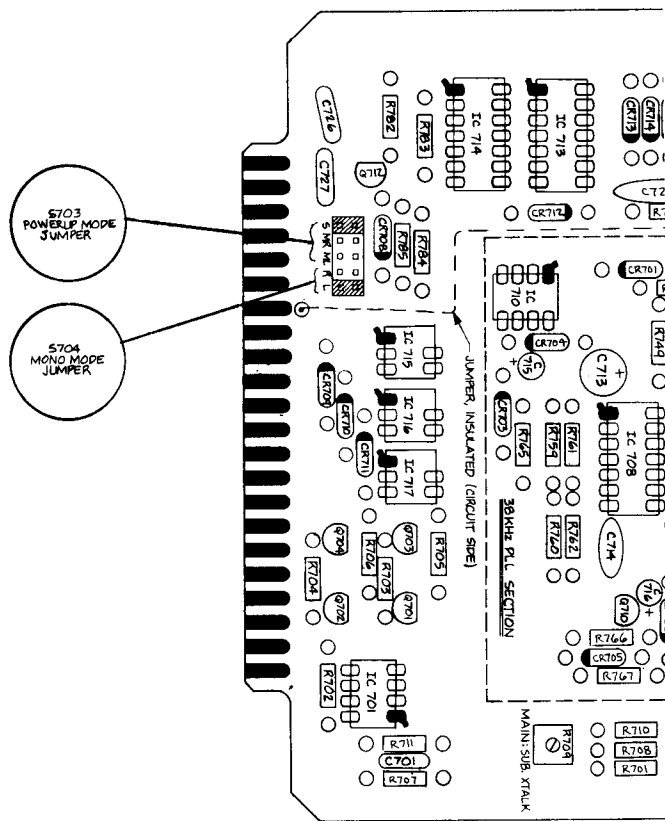

Fig. 3-2: Card #7 Powerup and Mono Mode Jumpers

- 2) **Mono Mode:** The front-panel STEREO/MONO switch ordinarily forces MONO LEFT mode when MONO is selected by this switch. If MONO RIGHT is desired, move a jumper plug on Card #7 according to Fig. 3-2.

3) **Input Attenuator Pads:** OPTIMOD-FM is shipped with 20dB pads ahead of the input buffer amplifiers. These are located on Card #3 (left channel) and Card #4 (right channel), and are suited for nominal input levels from -10 to +10dBm. If lower input levels from -30 to -10dBm are present, the pads must be defeated. To do this, remove Card #3. Reposition the jumper straps according to Fig. 3-3. Repeat for Card #4, and replace both cards.

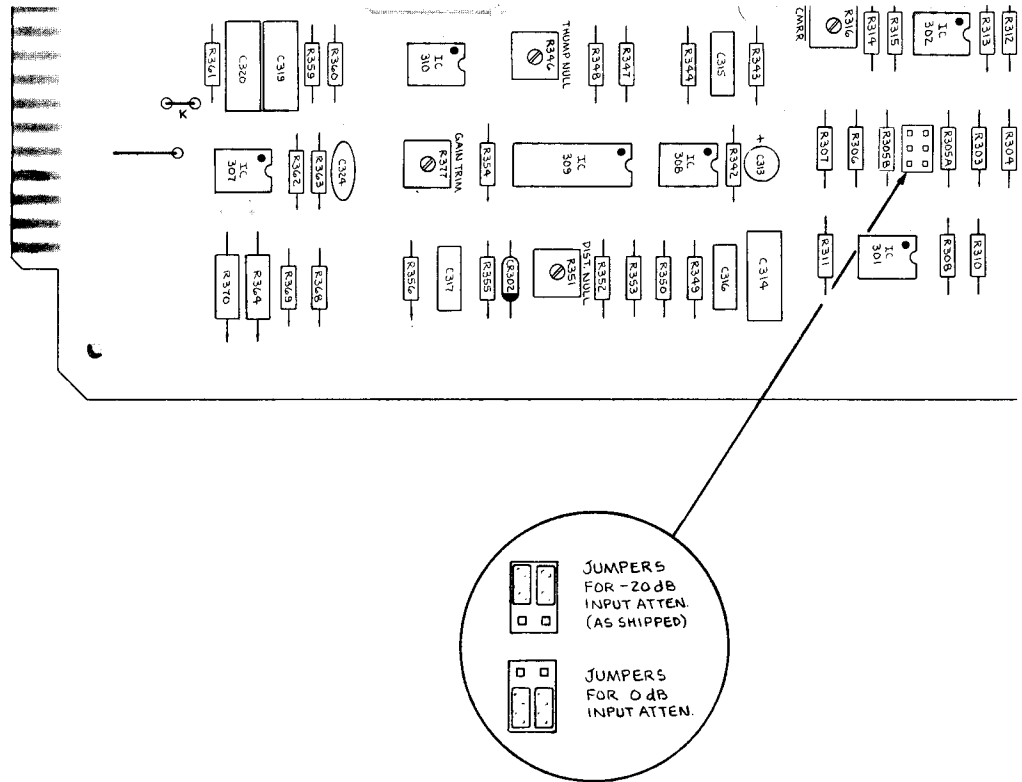

Fig. 3-3: Cards #3/#4 Input Attenuation Jumpers

4) **Defeating The 30Hz Highpass Filters:** There is no formal jumper for defeating these filters because we feel that the overall broadcast system will work better with the filters in for reasons discussed in detail in paragraphs 1.b of **Appendix A**. We recognize that there are those who will disagree. Those who wish to defeat the filters can do so by connecting a jumper between pins 3 and 7 of IC302 (Card #3) and IC402 (Card #4).

Reassembly: When the physical examination, line voltage adjustment, and optional initialization procedures are completed, replace the subpanel. The subpanel, besides carrying knob identification and calibrations and holding the cards in place, also provides RF shielding for the cards. So, all four DZUS fasteners should be engaged by turning 1/4-turn clockwise.

The front panel may now be closed and fastened using the three hex-socket screws. Normally, all access required from now on can be achieved through the smaller access door (equipped with a key lock).

Initial Electrical Checkout: Plug the power cord into an outlet whose voltage corresponds to the setting of the internal LINE VOLTAGE SELECTOR switch. The unit should spring to life. Check to make sure that the following conditions occur:

- A) The green POWER LED is illuminated;
- B) The red GATE LED is illuminated;
- C) The green STEREO LED is illuminated (unless you have restrapped Card #7 for MONO powerup);
- D) Both yellow HF LIMIT LED's are off;
- E) The VU meter readings are approximately identical to those provided in the "Final Factory Qualification Test Results" supplied separately from this Manual.

If anything is abnormal, repeat the **Physical Inspection** described above to make sure that you didn't miss anything. A preliminary diagnosis should be made, and, if necessary, the factory should be consulted.

If you wish to perform a more rigorous and complete checkout before installation, **Appendix D (Field Audit-Of-Performance Procedure)** provides complete instructions.

Equipment Location: OPTIMOD-FM is supplied in either single-chassis or dual-chassis versions. The dual-chassis version splits the system at the output of the Compressor. The studio chassis may be located in any convenient rack space in the studio. It is important to bear in mind that its RFI suppression is modest because it was assumed that the unit would be operated at a considerable distance from high-powered transmitters.

The main chassis, which is highly RFI-suppressed, is ideally located within 6 feet (1.8m) of the transmitter's exciter or composite STL transmitter. (The BNC/BNC cable supplied is 24" [61cm] long; longer cables must be supplied by the customer.) It requires 4 units (7", 17.8cm) in a standard 19" rack. If it is impossible to locate the OPTIMOD-FM chassis within 15 feet of the transmitter-mounted exciter, we recommend that you remove the exciter from the transmitter and mount it close to the OPTIMOD-FM chassis, rather than attempting to run a long baseband cable in a high RF field. Another advantage of moving the exciter away from the vibration of the transmitter blower is that microphonic effects will be reduced, thus improving signal-to-noise ratio.

If this is totally impractical, the OPTIMOD-FM stereo generator may be modified to drive higher capacitance. To do this, replace IC704 with an Analog Systems (P.O. Box 35879, Tucson, AZ 85740) type MA-332 operational amplifier and replace R739 with a 10-ohm $\pm 5\%$ 1/4-watt carbon film resistor. This will permit OPTIMOD-FM to drive up to 30 feet of RG-58A/U without problems due to capacitive loading. However, RF pickup in a cable of this length may prove problematical. (The MA-332 is pin-for-pin compatible with the stock AD-518 opamp and simply plugs into its socket.)

If the exciter is moved, be sure to use coaxial cable between exciter and IPA which properly matches the exciter output impedance. The IPA grid circuit should be carefully tuned for minimum VSWR between exciter and IPA.

Equipment life will be lengthened if the equipment is operated at moderate room temperatures and humidity, and if the air is reasonably dust-free and non-corrosive.

Although good audio monitor systems seem rare at transmitter sites, such a system which can be clearly heard at the OPTIMOD-FM will facilitate subjective adjustments. An alternative is the relocation of the controls to the studio location by use of the 8100A/ST Studio Accessory Chassis (see **Part 1.**)

Mounting And Grounding: It is important that the OPTIMOD-FM chassis (like all transmission equipment) be properly connected to a good earth ground. Wire is totally ineffective at VHF; the best way to ground the OPTIMOD-FM chassis is to mount it solidly in a well-grounded rack (or the transmitter cabinet). The rack or cabinet must be connected to earth through a wide, thin copper ground strap.

To assure good electrical contact between the OPTIMOD-FM chassis and the rack, it may be necessary to scrape the paint from the rack and/or the OPTIMOD-FM mounting flanges. Measure the resistance between the OPTIMOD-FM chassis and rack, and verify that it is less than 0.5 ohm.

Input Signal Connections: These instructions apply to the audio inputs of single-chassis OPTIMOD-FM's, and to the audio inputs of both studio and transmitter chassis in dual-chassis OPTIMOD-FM's.

In a high RF field, the audio input to OPTIMOD-FM must be fully-balanced, and should be run in 100% foil-shielded cable like Belden 8451. The shield should be connected to earth (chassis) ground at both ends. In addition, you should make sure that the telephone line termination box or STL receiver is properly grounded to earth.

In low-RF environments, the shield should be grounded at one end only, and audio may be run unbalanced over distances of less than 20 feet (6m).

OPTIMOD-FM should be operated with its integral 20dB input pad for levels between -10 and +10dBm, and without the pad for levels between -30 and -10dBm. Instructions for restrapping the pads are found above in **Initialization Options.**

The OPTIMOD-FM input is bridging, and its impedance is 200K with the 20dB pad defeated and 11.2K with the 20dB pad operative. If the source requires a 600-ohm termination (such as a telephone line), connect a 620-ohm $\pm 5\%$ 1/4-watt carbon film resistor across each audio input. Two such resistors are provided for your convenience.

It is important that both left and right audio inputs be in phase. This is ordinarily assured simply by connecting the red and black wires within all shielded cables symmetrically and consistently when wiring the two stereo channels. If a phasing error occurs, it will be indicated in on-air testing by failure of the OPTIMOD-FM L-R meter to null when OPTIMOD-FM is fed mono material, and by the stereo monitor's indicating more L-R than L+R level.

Studio Chassis Output Connections: In the dual-chassis version of OPTIMOD-FM, the output of the studio chassis presents a 600-ohm pure-resistive source impedance, balanced to ground, with a nominal output level of +10dBm when loaded by 600 ohms. It is thus suited for driving a land-line directly, or for driving the balanced input of a microwave STL transmitter.

If you wish to drive an unbalanced input, connect such an input between the studio chassis "+" output and circuit ground. **Do not ground the "-" output;** while no damage will occur, it will short the output of the "-" line amplifier to ground through a 300-ohm resistor.

Composite Output Connection: The composite output is capable of driving greater than 4V p-p into 10K. Its output impedance is 470 ohms, independent of the setting of the OPTIMOD-FM OUTPUT ATTEN control. We recommend that less than 6 feet (1.8m) of RG-58A/U cable be used to connect the exciter to OPTIMOD-FM, lest capacitive loading compromise the stereo performance due to frequency response rolloff and phase shift, or excessive RF pickup occur in the cable.

If a longer cable must be used, a low-capacitance coaxial cable such as RG-62A/U may be used for runs up to 15 feet (4.6m). Alternately, the stereo generator output can be modified as described in **Equipment Location** above. However, we suggest that the exciter be moved instead.

The composite output appears on a BNC connector. It is mounted on a metal plate which is insulated from the chassis by means of a thin polyester film. This assembly forms an RF-bypass capacitor of approximately 1000pF. The shell of the BNC connector is connected to OPTIMOD-FM circuit ground through an RFI filter.

The purpose of this arrangement is to enable unbalanced wideband exciter inputs to be driven without introducing hum-inducing ground loops. Different techniques must be used for interconnection, depending on whether the exciter input is balanced or unbalanced.

1) Balanced Exciter Input: (The most common of these include the Continental 510R-1 (Collins 310Z-2) with Continental 785E-1 Wideband Interface Card, the Gates TE-1 and TE-3 with Gates-supplied transformer-type Wideband Interface, and the Broadcast Electronics FX-30.) Connect the OPTIMOD-FM circuit ground and chassis ground terminals at the rear-panel barrier strip. This will create the required connection between exciter and OPTIMOD-FM circuit grounds.

2) Unbalanced Exciter Input: (This includes the Gates TE-1 and TE-3 with Orban ATE3-F Wideband Interface, and most other exciters. Check your exciter manual to be sure.) OPTIMOD-FM circuit ground will be automatically connected to exciter circuit ground through the shield of the baseband connector coax. Ordinarily OPTIMOD-FM circuit and chassis grounds will not be jumpered, as this will tend to create a ground loop. However, high RF fields often force reconsideration of conventional grounding rules, and if hum is a problem, you should try jumpering OPTIMOD-FM circuit and chassis grounds to see if hum is reduced.

Remote Control: Three sets of remote control terminals for selecting STEREO, MONO LEFT, and MONO RIGHT modes are located on the barrier strip on the OPTIMOD-FM rear panel. These are optically-isolated, RF suppressed, and may be floated +50V above ground. Mode switching can be effected by applying a pulse as short as a few milliseconds to the appropriate terminals. Either AC or DC from 6 to 24 volts may be used. To use 48 volts, connect a 1K +10% 2W carbon composition resistor to each terminal for current limiting.

IMPORTANT

The life of the opto-isolators will be somewhat shortened if switching is effected by supplying continuous voltage (instead of a single pulse) to the terminals. If this is the only practical way to operate your particular remote control, we advise adding a series resistor to the remote control terminals to limit current to 10mA. If this is done, a life of many years can be expected.

If the remote control can provide voltage pulses from its internal power supply, this is the simplest means of activating the functions. The current requirement is approximately 1.9mA/volt. If the pulses are DC, be sure to observe the polarity indicated on the OPTIMOD-FM barrier strip.

If the remote control can provide only contact closures, then you can supply the +22V unregulated DC from OPTIMOD-FM through the contacts in the remote control to activate the functions. A suitably current-limited source of +22V is available on the OPTIMOD-FM barrier strip. If you choose this mode of operation, then connect all three "-" OPTIMOD-FM remote control terminals to chassis ground.

WARNING!

Do not apply voltage to more than one set of remote control terminals at a time. Extreme overmodulation can result.

Remote Gain Reduction Meter: A negative voltage approximately proportional to the Total Master Gain Reduction is available between the OPTIMOD-FM rear-panel G/R terminal and ground. The voltage scale is approximately -0.33V per dB of gain reduction, and the source impedance is 8.87K. A standard 0-25dB Orban gain reduction meter can be connected directly between this terminal (-) and ground (+).

The Orban meter has a sensitivity of 1mA f.s. and a DC resistance of 880 ohms. Full-scale corresponds to 30dB G/R. Because only 25dB G/R can be achieved, the last 5dB of the scale is printed in red. The purpose of this is to match the scale to that of the BASS G/R meter, which is capable of, and fully calibrated to, 30dB G/R.

If an external meter with different characteristics is used, it is easy to calculate the required additional multiplier resistor for a 0-30dB scale by the formula: $M=(9.75/F)-(8870+R)$, where:

- M is the required multiplier resistor in ohms,
- F is the full scale meter sensitivity in amps, and
- R is the internal DC resistance of the meter in ohms.

If M is negative, the meter you wish to use is not sensitive enough, or has too high an internal resistance.

If you wish to interface the G/R output to a remote control for telemetry, bear in mind that the input impedance of the remote control will load down the G/R output and reduce the voltage according to the gain factor: $G=X/(X+8870)$, where X is the input resistance of the remote control in ohms. The scaling of the remote control should therefore be $-0.33xG$ volts per dB gain reduction.