

Operating Manual

OPTIMOD-TV[®]

Stereo Generator

MODEL 8185A

orban[®]

IMPORTANT NOTE: Refer to the unit's rear panel for your Model Number.

Model Number:	Manual References	Description:
8182A/U75	8182A	OPTIMOD-TV Audio Processor, 115V 75µs
8182A/J50	8182A + MVM-021 + OPT-018	OPTIMOD-TV Audio Processor, 100V 50µs
8182A/E75	8182A + OPT-021	OPTIMOD-TV Audio Processor, 230V 75µs
8182A/E50	8182A + OPT-021 + OPT-018	OPTIMOD-TV Audio Processor, 230V 50µs
8182AT/U	8182A	*OPTIMOD-TV Audio Processor, 115V 75µs
8182AT/J	8182A + MVM-021 + OPT-018	*OPTIMOD-TV Audio Processor, 100V 50µs
8182AT/E	8182A + OPT-021	*OPTIMOD-TV Audio Processor, 230V 75µs
8182AT/E	8182A + OPT-021 + OPT-018	*OPTIMOD-TV Audio Processor, 230V 50µs
8182AST/U	8182A/ST + MVM-021	OPTIMOD-TV Studio Chassis, 115V
8182AST/E	8182A/ST + MVM-021	OPTIMOD-TV Studio Chassis, 230V
8182AST/J	8182A/ST + MVM-021	OPTIMOD-TV Studio Chassis, 100V
8185A/U	8185A	BTSC TV Stereo Generator, 115V
8185A/E	8185A + OPT-021	BTSC TV Stereo Generator, 230V
8182ASAP/U	8182A/SAP	BTSC SAP Generator w/ Monitor Card, 115V
8182ASAP/E	8182A/SAP + OPT-021	BTSC SAP Generator w/ Monitor Card, 230V
8182APRO	8182A/PRO	BTSC PRO Generator for 8182A/SG
8185APRO	8185A/PRO	BTSC PRO Generator for 8185A

*Supplied with 3 and 4 TX cards and less the 2, 3, 4 and 5 cards.

OPTIONS AVAILABLE

Model Number:	Manual References	Description:
8182ASTSPK		Spare Parts and Semiconductor Kit
ACC021	ACC-021	dbx Monitor Card for earlier 8182/SAP
RET025	RET-025	8180A to 8182A Factory Upgrade
SC4	ACC-014	Clear Security Cover for OPTIMOD TV units
SC2	ACC-012	Clear Security Cover for ST units

MANUAL:

Part Number:	Description
95076-000-03	8185A Manual

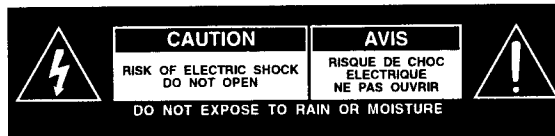

CAUTION: TO REDUCE THE RISK OF ELECTRICAL SHOCK, DO NOT REMOVE COVER (OR BACK). NO USER SERVICEABLE PARTS INSIDE. REFER SERVICING TO QUALIFIED SERVICE PERSONNEL.

WARNING: TO REDUCE THE RISK OF FIRE OR ELECTRICAL SHOCK, DO NOT EXPOSE THIS APPLIANCE TO RAIN OR MOISTURE.



This symbol, wherever it appears, alerts you to the presence of uninsulated dangerous voltage inside the enclosure — voltage that may be sufficient to constitute a risk of shock.



This symbol, wherever it appears, alerts you to important operating and maintenance instructions in the accompanying literature. Read the manual.

IMPORTANT SAFETY INSTRUCTIONS

All the safety and operating instructions should be read before the appliance is operated.

Retain Instructions: The safety and operation instructions should be retained for future reference.

Heed Warnings: All warnings on the appliance and in the operating instructions should be adhered to.

Follow Instructions: All operation and user instructions should be followed.

Water and Moisture: The appliance should not be used near water (e.g., near a bathtub, washbowl, kitchen sink, laundry tub, in a wet basement, or near a swimming pool, etc.).

Ventilation: The appliance should be situated so that its location or position does not interfere with its proper ventilation. For example, the appliance should not be situated on a bed, sofa, rug, or similar surface that may block the ventilation openings; or, placed in a built-in installation, such as a bookcase or cabinet that may impede the flow of air through the ventilation openings.

Heat: The appliance should be situated away from heat sources such as radiators, heat registers, stoves, or other appliances (including amplifiers) that produce heat.

Power Sources: The appliance should be connected to a power supply only of the type described in the operating instructions or as marked on the appliance.

Grounding or Polarization: Precautions should be taken so that the grounding or polarization means of an appliance is not defeated.

Power-Cord Protection: Power-supply cords should be routed so that they are not likely to be walked on or pinched by items placed upon or against them, paying particular attention to cords at plugs, convenience receptacles, and the point where they exit from the appliance.

Cleaning: The appliance should be cleaned only as recommended by the manufacturer.

Non-Use Periods: The power cord of the appliance should be unplugged from the outlet when left unused for a long period of time.

Object and Liquid Entry: Care should be taken so that objects do not fall and liquids are not spilled into the enclosure through openings.

Damage Requiring Service: The appliance should be serviced by qualified service personnel when:

- The power supply cord or the plug has been damaged; or
- Objects have fallen, or liquid has been spilled into the appliance; or
- The appliance has been exposed to rain; or
- The appliance does not appear to operate normally or exhibits a marked change in performance; or
- The appliance has been dropped, or the enclosure damaged.

Servicing: The user should not attempt to service the appliance beyond that described in the operating instructions. All other servicing should be referred to qualified service personnel.

The Appliance should be used only with a cart or stand that is recommended by the manufacturer.

Safety Instructions (European)

Notice For U.K. Customers If Your Unit Is Equipped With A Power Cord.

WARNING: THIS APPLIANCE MUST BE EARTHED.

The cores in the mains lead are coloured in accordance with the following code:

GREEN and YELLOW - Earth BLUE - Neutral BROWN - Live

As colours of the cores in the mains lead of this appliance may not correspond with the coloured markings identifying the terminals in your plug, proceed as follows:

The core which is coloured green and yellow must be connected to the terminal in the plug marked with the letter E, or with the earth symbol, (⏏), or coloured green, or green and yellow.

The core which is coloured blue must be connected to the terminal marked N or coloured black.

The core which is coloured brown must be connected to the terminal marked L or coloured red.



The power cord is terminated in a CEE7/7 plug (Continental Europe). The green/yellow wire is connected directly to the unit's chassis. If you need to change the plug and if you are qualified to do so, refer to the table below.

WARNING: If the ground is defeated, certain fault conditions in the unit or in the system to which it is connected can result in full line voltage between chassis and earth ground. Severe injury or death can then result if the chassis and earth ground are touched simultaneously.

CONDUCTOR		WIRE COLOR	
		Normal	Alt
L	LIVE	BROWN	BLACK
N	NEUTRAL	BLUE	WHITE
E	EARTH GND	GREEN-YELLOW	GREEN

AC Power Cord Color Coding

Safety Instructions (German)

Gerät nur an der am Leistungsschild vermerkten Spannung und Stromart betreiben.

Sicherungen nur durch solche, gleicher Stromstärke und gleichen Abschaltverhaltens ersetzen. Sicherungen nie überbrücken.

Jedwede Beschädigung des Netzkabels vermeiden. Netzkabel nicht knicken oder quetschen. Beim Abziehen des Netzkabels den Stecker und nicht das Kabel erfassen. Beschädigte Netzkabel sofort auswechseln.

Gerät und Netzkabel keinen übertriebenen mechanischen Beanspruchungen aussetzen.

Um Berührung gefährlicher elektrischer Spannungen zu vermeiden, darf das Gerät nicht geöffnet werden. Im Fall von Betriebsstörungen darf das Gerät nur von befugten Servicestellen instandgesetzt werden. Im Gerät befinden sich keine, durch den Benutzer reparierbare Teile.

Zur Vermeidung von elektrischen Schlägen und Feuer ist das Gerät vor Nässe zu schützen. Eindringen von Feuchtigkeit und Flüssigkeiten in das Gerät vermeiden.

Bei Betriebsstörungen bzw. nach Eindringen von Flüssigkeiten oder anderen Gegenständen, das Gerät sofort vom Netz trennen und eine qualifizierte Servicestelle kontaktieren.

Safety Instructions (French)

On s'assurera toujours que la tension et la nature du courant utilisé correspondent bien à ceux indiqués sur la plaque de l'appareil.

N'utiliser que des fusibles de même intensité et du même principe de mise hors circuit que les fusibles d'origine. Ne jamais shunter les fusibles.

Eviter tout ce qui risque d'endommager le câble secour. On ne devra ni le plier, ni l'aplatir. Lorsqu'on débranche l'appareil, tirer la fiche et non le câble. Si un câble est endommagé, le remplacer immédiatement.

Ne jamais exposer l'appareil ou le câble à une contrainte mécanique excessive.

Pour éviter tout contact avec une tension électrique dangereuse, on n'ouvrira jamais l'appareil. En cas de dysfonctionnement, l'appareil ne peut être réparé que dans un atelier autorisé. Aucun élément de cet appareil ne peut être réparé par l'utilisateur.

Pour éviter les risques de décharge électrique et d'incendie, protéger l'appareil de l'humidité. Eviter toute pénétration d'humidité ou fr liquide dans l'appareil.

En cas de dysfonctionnement ou si un liquide ou tout autre objet a pénétré dans l'appareil couper aussitôt l'appareil de son alimentation et s'adresser à un point de service après-vente autorisé.

Safety Instructions (Spanish)

Hacer funcionar el aparato sólo con la tensión y clase de corriente señaladas en la placa indicadora de características.

Reemplazar los fusibles sólo por otros de la misma intensidad de corriente y sistema de desconexión. No poner nunca los fusibles en puente.

Proteger el cable de alimentación contra toda clase de daños. No doblar o apretar el cable. Al desenchufar, asir el enchufe y no el cable. Sustituir inmediatamente cables dañados.

No someter el aparato y el cable de alimentación a esfuerzo mecánico excesivo.

Para evitar el contacto con tensiones eléctricas peligrosas, el aparato no debe abrirse. En caso de producirse fallos de funcionamiento, debe ser reparado sólo por talleres de servicio autorizados. En el aparato no se encuentra ninguna pieza que pudiera ser reparada por el usuario.

Para evitar descargas eléctricas e incendios, el aparato debe protegerse contra la humedad, impidiendo que penetren ésta o líquidos en el mismo.

En caso de producirse fallas de funcionamiento como consecuencia de la penetración de líquidos u otros objetos en el aparato, hay que desconectarlo inmediatamente de la red y ponerse en contacto con un taller de servicio autorizado.

Safety Instructions (Italian)

Far funzionare l'apparecchio solo con la tensione e il tipo di corrente indicati sulla targa riportante i dati sulle prestazioni.

Sostituire i dispositivi di protezione (valvole, fusibili ecc.) solo con dispositivi aventi lo stesso amperaggio e lo stesso comportamento di interruzione. Non cavallottare mai i dispositivi di protezione.

Evitare qualsiasi danno al cavo di collegamento alla rete. Non piegare o schiacciare il cavo. Per staccare il cavo, tirare la presa e mai il cavo. Sostituire subito i cavi danneggiati.

Non esporre l'apparecchio e il cavo ad esagerate sollecitazioni meccaniche.

Per evitare il contatto con le tensioni elettriche pericolose, l'apparecchio non deve venir aperto. In caso di anomalie di funzionamento l'apparecchio deve venir riparato solo da centri di servizio autorizzati. Nell'apparecchio non si trovano parti che possano essere riparate dall'utente.

Per evitare scosse elettriche o incendi, l'apparecchio va protetto dall'umidità. Evitare che umidità o liquidi entrino nell'apparecchio.

In caso di anomalie di funzionamento rispettivamente dopo la penetrazione di liquidi o oggetti nell'apparecchio, staccare immediatamente l'apparecchio dalla rete e contattare un centro di servizio qualificato.

Operating Manual

OPTIMOD-TV[®]

Stereo Generator

MODEL 8185A

orban[®]

The 8185A OPTIMOD-TV is protected by U.S. patents 4,249,042; 4,208,548; 4,460,871; and U.K. patent 2,001,495.
Other patents pending.

OPTIMOD-TV and Orban are registered trademarks.

This manual is part number 95076-000-03.
200 - FB - 5/2/96

© 1996 Orban, Inc.

orban

H A Harman International Company

1525 Alvarado Street, San Leandro, CA 94577 USA

Phone: (1) 510/351-3500 • Fax: (1) 510/351-0500 • E-mail: custserv@orban.com

Operating Manual

OPTIMOD-TV

Stereo Generator

Model 8185A

page	contents
1-1	Section 1: Introduction Orban's OPTIMOD-TV Stereo Generator BTSC Multichannel Television Sound System Requirements Registration, Warranty, Feedback
2-1	Section 2: Installation Installation — Quick Set-up Installation — Comprehensive Instructions Rewire of 8182A Accessory Port
3-1	Section 3: Operation Controls and Indicators Recommended Control Settings Discussion of Audio Processing Functions
4-1	Section 4: Maintenance Routine Maintenance Getting Inside the Chassis In-Line Performance Verification Individual Card Tests Field Alignment and Comprehensive Card Tests Appendix: Evaluating BTSC Stereo Generators and Audio Processors: Some Suggestions
5-1	Section 5: Troubleshooting Troubleshooting Technique Problems and Possible Causes Technical Support
6-1	Section 6: Technical Data Specifications Circuit Description Parts List Schematics, Assembly Drawings

INDEX on next page

Index

- 8182A audio processor
 - accessory port 2-28
 - controls and indicators 3-4
 - dual-chassis configuration (with 8182A/ST) 2-3, 2-5,6, 2-9, 2-12, 2-20,22, 2-24,26
 - recommended control settings 3-6
 - set-up 2-2,7, 2-9, 2-11,14, 2-20,27
- 8185 OPTIMOD-TV 1-3, 2-3,4
- abbreviations 6-80
- access to circuitry 2-28
- alignment, field 4-16
- antennas 1-10
- appendix 4-44
- assembly drawings 6-55
- audio input 2-23
- audio processing 3-6, 3-9
- audio processor
 - evaluation 4-44
 - non-Orban 1-10, 2-2,3, 2-7, 2-12, 2-14, 6-2
 - Orban 8182A 1-10, 2-2,3, 2-7, 2-12, 2-14, 2-20,27, 6-2
 - reconfiguring 2-11
- bass
 - boost 3-13
 - coupling control 3-4
- bessel null calibrator 3-2, 6-15
- block diagram 6-5
- BTSC 1-3, 1-7,8
- BTSC stereo generators
 - evaluation 4-44
- buzz 5-3, 5-9
- cable, interconnect 2-2, 2-12
- chassis, getting inside 4-4
- circuit cards, access to 4-4
- circuit description 6-5, 6-6
- circuitry specifications 6-3
- cleaning 4-3
- clipping 3-4
- commercials, excessively loud 3-12
- components, replacing 5-11
- composite output 6-3
- compression, 8182A 3-5, 3-8,9
- compressor switch, 8182A 3-4
- controls 3-2, 3-4,5, 3-9,
 - 8182A 3-4,6
 - 8182A recommended settings 3-6
 - set-up 4-4
- corrosion 4-2
- cover, top & bottom 4-6
- crossstalk
 - main-to-subchannel 5-8
 - sub-to-main channel 5-8
- customer service 5-13
- dbx 1-3, 1-6, 6-12, 6-22
 - noise reduction cards 6-26
- de-emphasis 6-12
- decoder, accuracy 4-46
- density 3-9, 3-13
- deviation
 - aural carrier 1-8
 - baseband 1-5
 - SAP subcarrier 1-9
- diagnostic meter 5-4, 5-5
- diplexers 1-11
- distortion 3-4, 3-6, 3-13, 5-9, 6-2
- dynamic range 3-10
- EIA 1-8
- eleven-pole filters 6-10
- ENG 3-10
- environmental specifications 6-3
- exciters 1-10,11, 2-18
- exciter sensitivity 2-16
- factory service 5-13
- FCC 1-8
- filters
 - eleven-pole 6-10
 - left and right low-pass 6-3
 - low-pass 6-3,4
 - six-pole 6-7
 - sum and difference low-pass 6-4
- frequency response 6-2
- front panel 1-2, 4-5
- FSK 1-8
- fuse 2-5, 6-24
- gain reduction 3-10,11
- gate indicator 3-4
- gate threshold control 3-4
- gating 3-9,10
- G/R meters
 - bass 3-5
 - total 3-5
- ground 2-2, 2-12
- grounding 4-3
 - problems 5-3
- group delay correctors 6-6
- high-frequency
 - limiter 6-2
 - limit indicator 3-4
 - limiting 3-13
- hum 5-3, 5-9
- humidity 6-3
- indicators 3-2
 - 8182A 3-4
- input
 - amplifiers 6-6
 - attenuation 2-20
 - attenuator controls 3-4
 - audio 2-23
 - filter 2-2
 - filter board 4-7
 - sync termination impedance 2-13
- INPUT ATTEN 2-20
- installation
 - comprehensive 2-3
 - specifications 6-2
 - quick 2-2
- instrumentation
 - dynamic separation 4-46
- interference 5-10
- jumpers 2-2 2-7, 2-8, 2-9, 2-11
- level
 - adjustment 2-18
 - inconsistent 3-10
- limiter switch 3-4
- limiting 3-13
- line voltage 2-5
- linearity testing 4-44
- loudness
 - commercials 3-7, 3-12
 - consistency 3-6
 - control 2-20
 - controller 3-4, 3-8
 - subjective 3-4
- low-pass filter, 15kHz 2-7
- maintenance, routine 4-2
- master G/R meters 3-5
- matrix 6-7
- measurements, stereo generator 4-47
- meters 2-6, 4-2, 5-4,5
 - G/R meters 3-5
 - peak detector 6-22
 - red zone 3-11
 - VU 2-12, 3-2, 4-2, 5-4,5, 6-22
- mode switching logic 6-20
- modulation 2-25
 - 100% 1-8
 - overshoot 1-8, 2-25
 - problems 5-8
- modulation monitor
 - accuracy 2-16, 2-18, 2-25
 - overshoots in 2-25
- monitor built into 8185A
 - circuit 6-22
 - decoder 6-2
 - N/R decoder 3-2
 - output 6-3
- monitoring 1-3
- MTS baseband 1-9
- multichannel tv sound 1-8
- N/R encoder 3-2
- noise 5-5
 - breathing 3-4, 3-10
 - noise reduction 1-3
 - cards 6-26
 - decoder 6-12, 6-22
 - encoder 6-11,12
- OET-60A 1-8
- opamps 5-11
- optical soundtracks 3-10
- OPTIMOD-TV 1-3, 2-3,4
- ordering parts 6-41
- output 2-2
 - attenuator controls 3-4
 - composite 6-3
 - impedance 2-7
 - monitor 6-3
- overshoot 6-11, 6-23
 - compensation 3-4
- packing for shipment 5-13
- parts
 - list 6-41
 - ordering 6-41
- peak control 3-12
- performance
 - field audit 4-16
 - proof of 4-48
 - specifications 6-2
 - verification (in-line) 4-11
- phase,
 - balance circuit 6-9
 - correction 6-6
 - locked loop 6-13,14
- pilot tone 1-8
 - AGC 6-16
 - generator 6-16
 - switch 3-2

- power 2-2
 - cord plug 2-4
 - indicator 3-2, 3-4
 - problems 5-4
 - specifications 6-3
 - supplies 5-4 6-23, 6-25
 - switch 4-4
 - transistors 4-9
 - unregulated supply 6-25
- pre-emphasis 1-8, 6-12
 - networks 6-6
- PRO channel 1-8
- problems 5-7
 - localization 5-2
- product features 1-3
- quick set-up 2-2
- rear panel 1-2, 4-6
- red zone, meters 3-11
- release shape 3-7, 3-10
 - switch 3-4
- release time 3-10, 6-23
 - control 3-4
- remote control 6-3
- return authorization 5-13
- RF filter box 4-7
- RS-508 1-11
- SAP channel 1-9
- SAP subcarrier input 6-2
- schematics 6-55
- screws 4-4
- second audio program 1-3, 1-9
- separation 4-2, 5-8, 5-10
 - L+R gain 3-2
- service 5-13
- set-up 2-2
- shielding 2-12
- shipping instructions 5-13
- side panel 4-8
- signal distortion 5-9
- signal tracing 5-5
- sinewave generator 6-15
- sinewave measurements 4-45
- six-pole filter 6-7
- sound 3-6
- source material 5-5
- specifications 6-2
 - circuitry 6-3
 - installation 6-2
 - performance 6-2
 - warranty 6-4
- spectral balance 3-13
- split chassis 1-10
- stereo baseband
 - encoder 6-4
 - generator 6-17
- stereo modulator 6-18
- stereo/mono
 - filter bypass 6-11
 - switch 3-2
 - switching 6-9
- STL 1-10, 2-20, 2-22
 - composite 1-10
- Studio Chassis 1-10, 2-2,3, 2-5,6 2-9,10
 - 2-12, 2-20,27
 - cards 2-9
- subcarrier 1-8, 5-9
 - input 6-2
 - suppression 5-9
- subjective tests, audio processor 4-48
- subpanel 2-5, 4-5
- sum and difference low-pass filters 6-4
- sum compensator 6-11
- sum phase-balance trimmer 3-2
- suppression, subcarrier 5-9
- switching waveform generator 6-19
- sync 2-2
 - card 6-12
 - input 2-13
 - lock 2-6 3-2, 5-10
 - lock indicator 6-3
 - loop-through 1-11, 2-13
 - reference input 6-2
 - separator 6-13
 - termination 2-13
- system, configuration 1-4
- system, requirements 1-10
- technical support 5-13
- telephone lines 1-10
- temperature range 6-3
- test switch 3-2
- testing, linearity 4-44
- THD 6-2
- total baseband output level control 3-2
- troubleshooting 5-2 5-7
 - card swap 5-6
 - components 5-11
- user comments 1-13
- user registration 1-13, 2-2, 2-25
- voltage regulators 6-23
- VU meter 2-12, 3-2, 4-2 5-4,5, 6-22
 - selector switch 3-4
- warranty 1-13, 6-4
- weight 6-3

Section 1

Introduction

page	contents
1-3	The Orban OPTIMOD-TV Stereo Generator
1-2	Front and Rear Panels
1-4	Fig. 1-1: Common System Configurations
1-5	Fig. 1-2: Baseband Spectrum
1-5	Fig. 1-3: Level vs. Frequency
1-5	Fig. 1-4: Group Delay vs. Frequency
1-6	About Measurements of Separation Performance
1-7	Fig. 1-5: BTSC Swept Sine-Wave Separation Performance
1-7	Fig. 1-6: BTSC Separation Performance With Pink Noise
1-8	BTSC Multichannel Television Sound
1-9	Fig. 1-7: The BTSC MTS Baseband
1-10	System requirements: STLs, Exciters, Antennas, Sync
1-11	Fig. 1-8: RS-508 Exciter Performance Specifications
1-12	Additional Sources of Information
1-13	Registration, Warranty, Feedback

The 8185A Stereo Generator

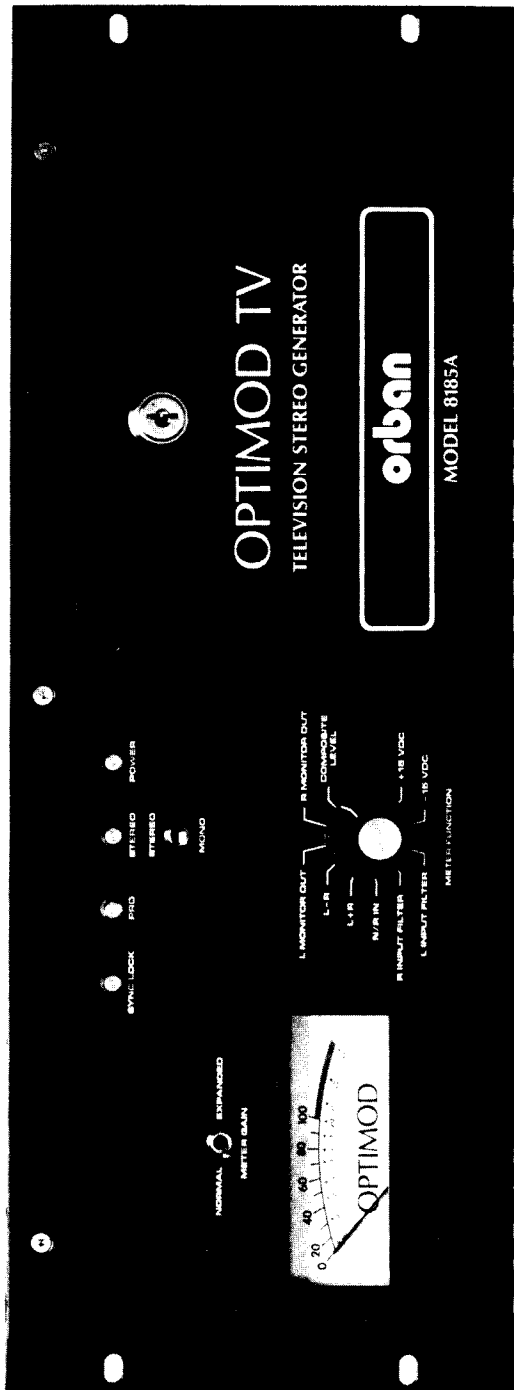

Front

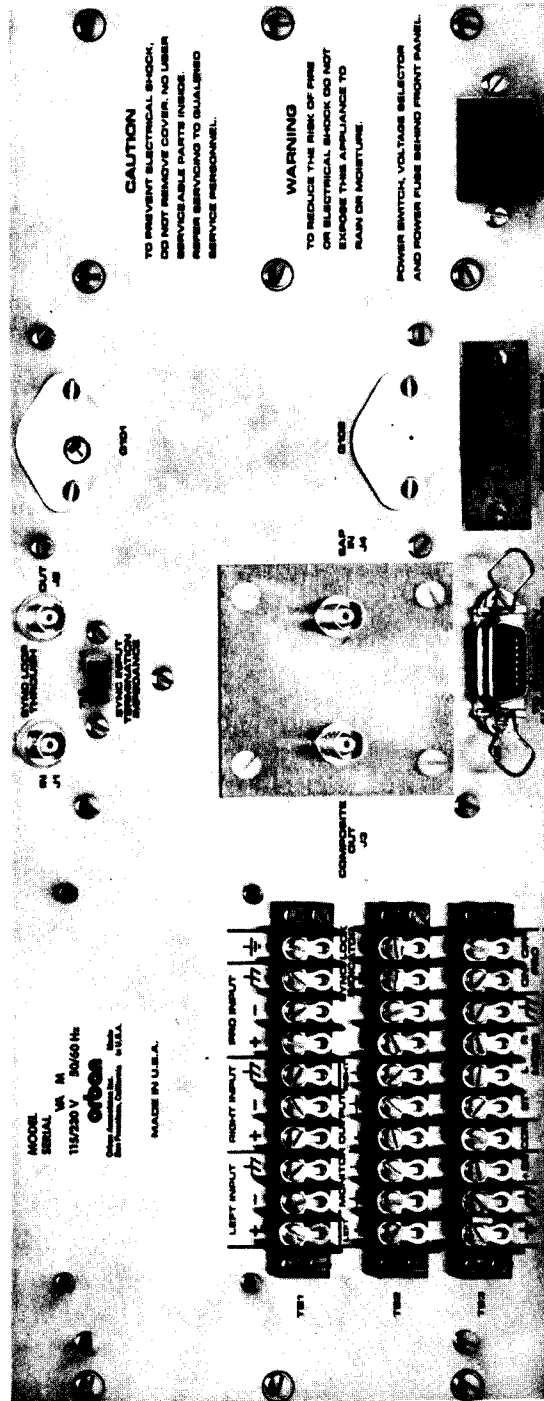

Rear

The Orban OPTIMOD-TV Stereo Generator

The 8185A Stereo Generator is a high-performance BTSC-standard stereo generator having superb audio quality and exceptional stability. Although the 8185A will work with *any* audio processor, it is designed to be especially effective when used in conjunction with the Orban OPTIMOD-TV audio processor.

The 8185A far exceeds BTSC requirements, delivers unimpeachable subjective audio quality, and uses extremely high-performance low-pass filters to achieve excellent high-frequency response and the industry's best aliasing rejection. The 8185A Stereo Generator has a digital baseband encoder, group delay equalization, and upgraded noise reduction circuitry for better overall performance and tighter specifications.

- Digital baseband encoder generates BTSC-standard stereo subchannel and composite baseband. Fig. 1-2 shows the very clean baseband spectrum produced by the Hadamard Transform Baseband Encoder.™
- Separation performance exceeds all BTSC specifications.
- Works with any audio processor. (Has +10dBm active-balanced left and right inputs, and can accept flat or pre-emphasized input.)
- When used with the Orban 8182A OPTIMOD-TV Audio Processor, a special interface allows interleaving of circuitry to get the brightest sound with the lowest distortion.
- Easy to install and operate.
- Built-in Bessel null calibration tone.
- Built-in peak-indicating meter for input, circuit, and output levels.
- Sharp filtering protects pilot and prevents crosstalk between the main channel and subchannel (see Fig. 1-3).
- Excellent protection from aliasing.
- Group delay equalization of low-pass filters to minimize overshoots (see Fig. 1-4).
- dbx® noise reduction encoder.
- Built-in dbx noise reduction decoder, de-emphasis, and de-matrixing for monitoring audio up to the baseband encoder.
- Optional 8185A/PRO Professional Channel Generator circuitry.
- Input port for separate Second Audio Program channel generator.
- Optically-isolated remote control inputs for switching between stereo and mono operation, for monitoring sync lock status, and for controlling the optional 8185A/PRO Professional Channel Generator.

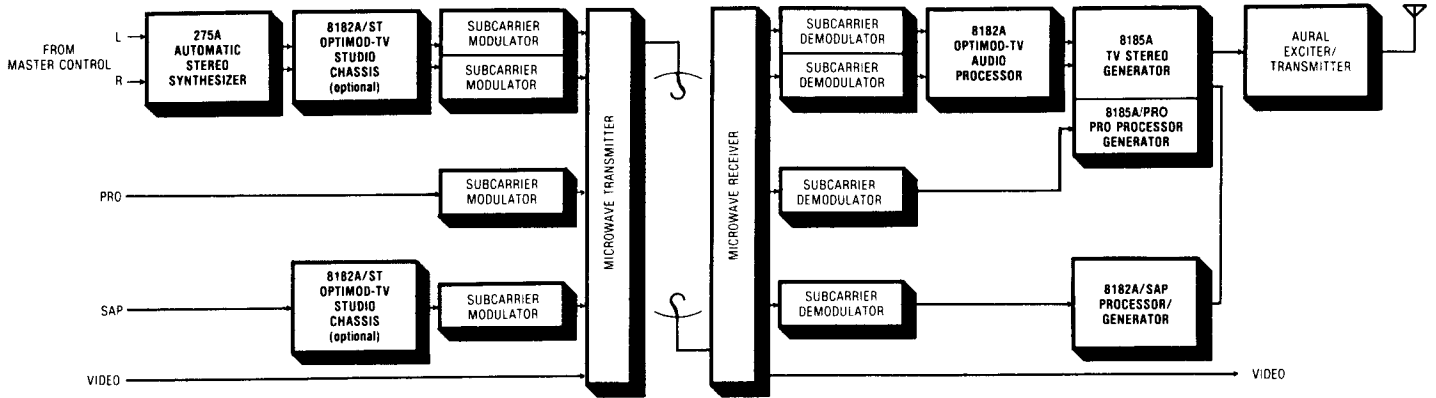

Stereo TV System with discrete subcarrier microwave STL

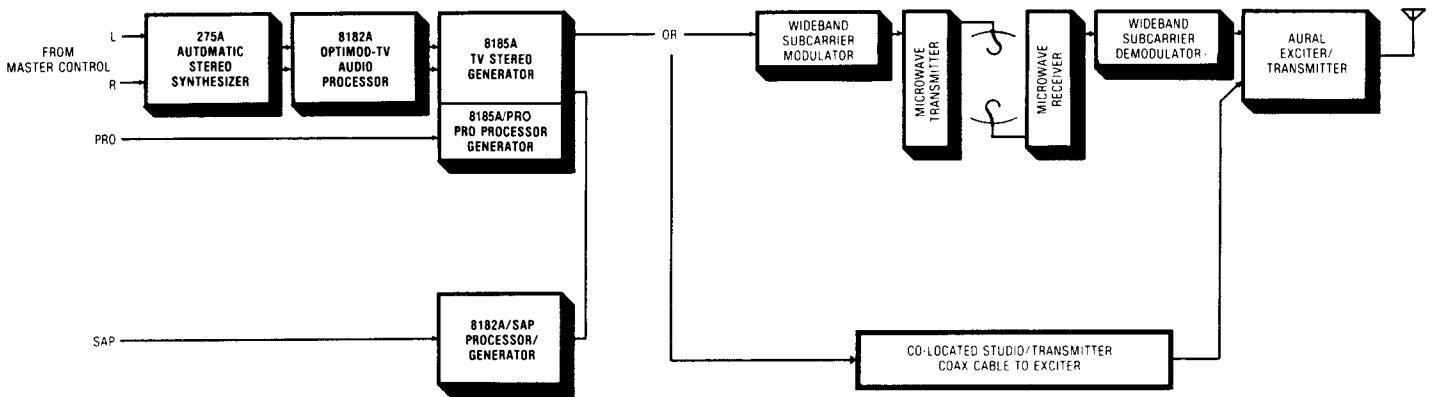

**Stereo TV System with composite subcarrier microwave STL
or
co-located studio/transmitter**

Fig. 1-1: Common System Configurations

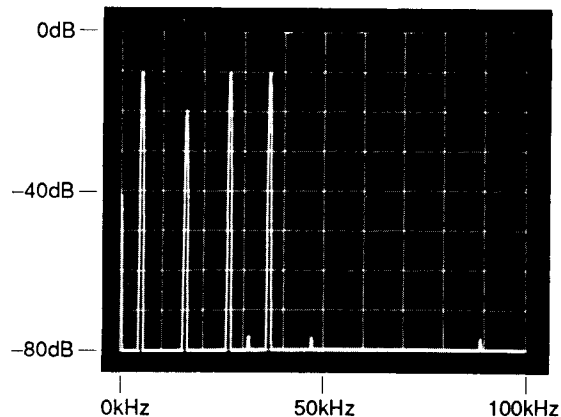

Fig. 1-2: Baseband Spectrum
(5kHz L-only modulation, equivalent mode, ± 55 kHz devi.

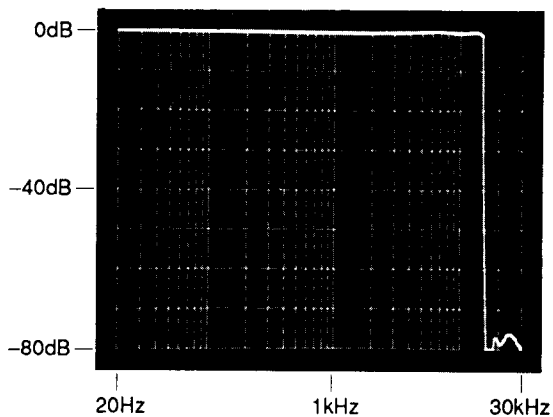

Fig. 1-3: Level vs. Frequency
(Demonstrating stopband filtering effectiveness)

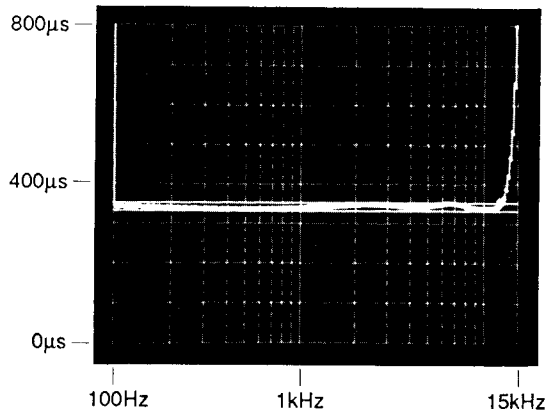

Fig. 1-4: Group Delay vs. Frequency

About Measurements of Separation Performance

A major factor affecting swept sine-wave separation measurements is the matching between the noise reduction encoder in the stereo generator and the decoder in the receiver. When measuring system separation beyond 35dB, minuscule variations between encoders and decoders can skew results by 5dB or more. Orban has been working closely with dbx to optimize system separation. The improved dbx encoder and monitor decoder used in the 8185A reflect this effort.

Nevertheless, swept sine-wave separation measurements cannot predict dynamic separation in BTSC stereo, because they do not correlate well to separation performance with real-world program material. Swept sine-wave measurements are simultaneously *completely insensitive* to dynamic separation artifacts that are produced by non-complementary noise reduction encoder and decoder nonlinearities, and *overly sensitive* to small linear errors which “average out” in the broadband energy of program material. Thus, swept sine-wave measurements could lead one to expect to hear linear interchannel crosstalk that, in fact, cannot be heard, while not revealing non-linear crosstalk distortion that *is* heard.

For these reasons, Orban assesses separation with a dual-channel FFT analyzer, using both program material and pink noise for excitation. The role of swept sine-wave measurements is limited to verifying that BTSC specifications are met. Relying on swept sine-wave measurements alone as a indicator of the overall quality is unwise because such measurements fail to predict dynamic separation and do not excite the aliasing distortion that can result from inadequate audio filtering of program material.

It is well-established that there is no audible improvement in stereo imaging when *real-world dynamic separation* is improved beyond 17dB. Since all Orban stereo generators greatly exceed 30dB dynamic separation at all frequencies contributing to the stereo effect, almost all of the error budget is left for the receiver.

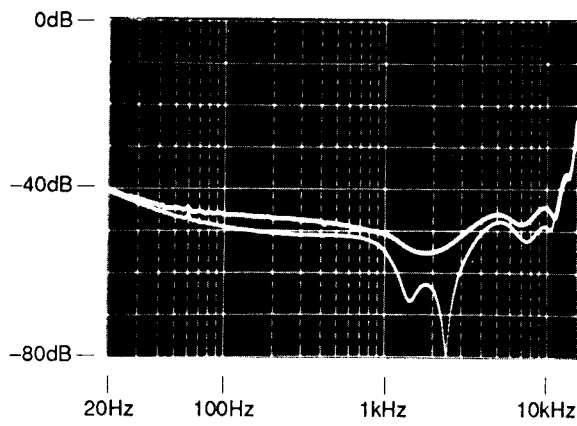

Fig. 1-5: BTSC Swept Sine-Wave Separation Performance (10% and 30% 75 μ s equivalent input level)

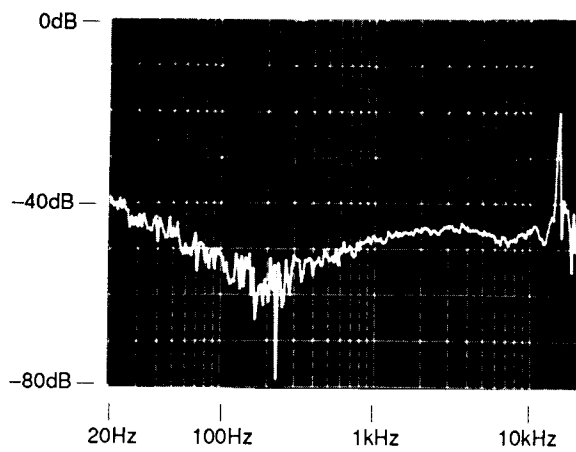

Fig. 1-6: BTSC Separation Performance With Pink Noise Excitation

BTSC Multichannel Television Sound

The Broadcast Television Systems Committee (BTSC) Multichannel Television Sound (MTS) system was chosen by a vote of industry leaders in late 1983. Extensive testing of rival transmission and noise reduction systems was performed under the auspices of the Electronics Industries Association (EIA), and the results of the tests were published for examination by the industry. As the result, the BTSC standard incorporates the Zenith transmission system and the dbx® noise reduction system.

The FCC, to avoid possible legal challenges from the losers, voted early in 1984 to authorize a “modified marketplace” choice of TV stereo. That is, a television broadcaster could use any television stereo system which met the technical requirements of the FCC rules. However, if a pilot tone was broadcast at 1H (15,734Hz), then the stereo system in use was required to meet BTSC specifications. These specifications were set forth in the Office of Engineering and Technology publication OET-60A. OET-60A is not complete, in that many details and recommended practices are omitted. These details were left to an industry committee, again working under the auspices of the EIA, which specified them in the EIA publication *BTSC System Television: Multichannel Sound Recommended Practice*.

In the Zenith transmission system specified by the BTSC, a main channel occupying 50–15kHz is modulated with the stereophonic sum (L+R) signal. To be consistent with existing monophonic standards, 100% modulation was defined to be $\pm 25\text{kHz}$ deviation of the aural carrier, and $75\mu\text{s}$ pre-emphasis was specified.

In the BTSC MTS system, the stereo subchannel carries the stereo difference (L-R) information. Double-sideband-suppressed carrier amplitude modulation was specified. The subcarrier frequency is 2H (31,468Hz). A pilot tone broadcast at 15,734Hz with $\pm 5\text{kHz}$ deviation indicates that stereo is being broadcast and serves as a phase reference to regenerate the subcarrier at the receiver's stereo decoder. 100% modulation of the stereo subchannel is defined to be $\pm 50\text{kHz}$ deviation. 100% modulation of the baseband (the sum of the stereo sum and difference channels) is also defined to be $\pm 50\text{kHz}$ deviation. The recommended practice allows brief, low-energy overshoots induced by low-pass filters to exceed $\pm 50\text{kHz}$ deviation.

The system is similar to that used in FM radio. However, the difference channel does not use fixed pre-emphasis. Instead, the difference signal is processed by the dbx noise reduction encoder to produce a highly compressed signal which can then be recovered at the receiver by a precisely complementary expansion. This restored difference signal is then matrixed with the sum signal in the receiver to produce the left and right stereo channels. Use of noise reduction in the difference channel eliminates the large signal-to-noise degradation which would otherwise occur upon switching from mono to stereo reception. Correct operation of the dbx system depends on a precisely controlled gain between the output of the encoder at the transmitter and the input of the decoder at the receiver. Stereo separation is very sensitive to gain errors in the transmission system.

The BTSC MTS standard provides for a frequency-modulated Professional (PRO) channel subcarrier at 6.5H (102kHz). This is a non-broadcast, communications-quality channel intended for signaling between transmitter, studio, and remote vehicles, and for other similar intra-station communications. The PRO subcarrier deviates the main carrier $\pm 3\text{kHz}$. Maximum deviation of the PRO subcarrier is also $\pm 3\text{kHz}$. Audio bandwidth is limited to 3kHz. The PRO channel may be used for digital data with the frequency-shift keying (FSK) method.

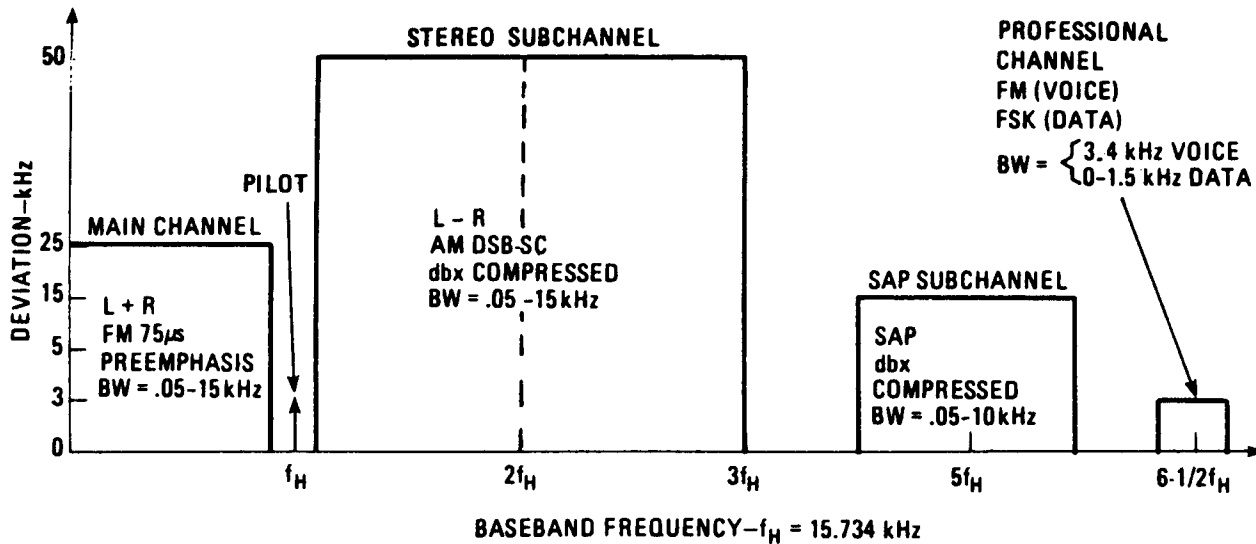

Fig. 1-7: The BTSC MTS Baseband

The BTSC MTS also provides for a Second Audio Program (SAP) on a frequency-modulated subcarrier. The SAP channel is intended for broadcast of a second audio signal with a television program. The Second Audio Program may be dialog in a second language, alternate coverage of sports events, or other program-related material. Audio unrelated to the video or main channel audio may also be broadcast over the SAP channel.

The SAP subcarrier has a carrier frequency of $5H$ (78,671Hz) in absence of modulation, and modulates the main aural carrier to ± 15 kHz deviation. 100% modulation of this subcarrier is defined to be ± 10 kHz deviation of the subcarrier frequency; the audio bandwidth of SAP modulation is limited to 10kHz. Fixed pre-emphasis is not used, but a dbx noise reduction encoder is inserted before the subcarrier generator. A complementary dbx noise reduction decoder in the receiver restores the original signal.

The FCC does not require that the BTSC standard for the SAP channel be adhered to even if the 15,734Hz BTSC stereo pilot is being transmitted. The standard recommended by the EIA therefore suggests that if a non-BTSC subcarrier is transmitted at $5H$, it should be broadcast with an injection that results in less than ± 7.5 kHz main carrier deviation to avoid false triggering of SAP decoders in BTSC receivers.

System Requirements: STLs, Exciters, Antennas, Sync

It is considerably easier to implement MTS stereo than to implement the other MTS subcarriers (the SAP and PRO channels), since limitations in the exciter, diplexer, and antenna generally do not degrade the quality of the stereo signal below “entertainment quality”. (If, however, Incidental Carrier Phase Modulation in the visual transmitter exceeds 5° , it can cause subjectively annoying buzz which will be clearly audible to the consumer.)

Because of the greater carrier deviations involved and the fact that the sidebands produced by the SAP and PRO subcarriers are further from the nominal carrier frequency than is the stereo subchannel, there is substantially higher probability that some difficulty (mainly crosstalk from stereo into SAP) will be experienced with the SAP and PRO carriers in many unmodified transmitter plants. A more rigorous engineering analysis will probably be required.

It is not necessary to qualify the plant for *all* MTS subcarriers just to implement stereo. Some stations have found it convenient to begin stereo operation without waiting until the plant was upgraded to be able to provide the other MTS subcarriers as well. These stations have found that a very satisfying entertainment-quality signal can be achieved with as little as 20dB midband separation and 12kHz audio bandwidth.

At this writing, the ideal method of transmitting the MTS signal from studio to transmitter is far from being well defined. Many stations use several subcarriers on their video STL to accommodate the various audio signals, including the left and right audio channels, the SAP audio, and the PRO audio. If this method is used, the audio processor and stereo and subcarrier generators should be located at the transmitter.

If the STL has poor signal-to-noise ratio, we recommended that Orban's 8182A Audio Processor (if used) be split, with the dual-band compressor located at the studio end of the STL to protect it from overload and to permit higher average STL modulation. The split chassis configuration employs the optional Model 8182A/ST Studio Chassis. Stations which use telephone lines to carry audio to the transmitter site can also benefit from the split-chassis configuration, because the available signal-to-noise ratio is increased.

If a composite STL system (in which the *entire* stereo baseband, including the stereo, SAP, and PRO subcarriers, is encoded into a single subcarrier of the video STL) is used, the 8185A should be located at the studio, just prior to the STL. Current “wideband” subcarriers not specifically designed for MTS do not have sufficiently flat group delay to pass the MTS baseband, and should not be used.

It is probably unwise to try to use video distribution amplifiers to pass the stereo baseband. While high-frequency bandwidth and phase linearity would be adequate, non-linear distortion might be excessive, low-frequency group delay might not be sufficiently flat, noise performance is suspect, and any video processing circuitry involved in the distribution amplifier would certainly degrade the baseband signal.

Broadcast of the full MTS baseband spectrum (which extends to 105kHz and requires a total aural carrier deviation of $\pm 73\text{kHz}$) places new demands on exciter

performance in the areas of bandwidth, linearity, frequency deviation capability, and group delay. While many existing exciters can be relatively easily adapted to broadcast of the MTS *stereo* signals, many of these exciters are not suited for SAP operation. EIA Standard RS-508 contains specifications for MTS aural exciters (see Fig. 1-8).

The bandwidths of older **RF amplifiers, diplexers, and antennas** may not be sufficiently wide to achieve satisfactory SAP performance. RS-508 provides some guidance here. Rule-of-thumb performance guidelines are $\pm 200\text{kHz}$ (-3dB) bandwidth for the diplexer (with group delay symmetrical around the center frequency), and greater than 1MHz bandwidth for RF amplifiers. As this area is highly specialized, we recommend consultation with the manufacturer of the transmitter and/or diplexer to determine if any modifications are required to make these parts of the system adequate for SAP operation.

The 8185A requires **sync or EIA-standard composite video** at 1-volt peak-to-peak, and is designed with "video loop-through" for maximum flexibility. If both the 8185A Stereo Generator and the optional 8182A/SAP Second Audio Program Generator are fed from a single reference, it may be looped through one and terminated in the other. (Composite video can be looped through without degradation.) Sync input impedance may be switched to 75 ohms to terminate video lines if a separate sync or composite video drive is available to feed the 8185A.

	Composite Input	Subcarrier Input
Frequency Range	30Hz–120kHz	16kHz–120kHz
Input Impedance	75 ohms	75 ohms
100% Modulation	1.5V = 75kHz	1.5V = 75kHz
Deviation Capability	>100kHz, 30Hz–50kHz >50kHz, 16kHz–120kHz	>50kHz
Frequency Response	$\pm 0.1\text{dB}$, 50Hz–50kHz $\pm 1\text{dB}$, 30Hz–120kHz	$\pm 1\text{dB}$
Deviation from Linear Phase	$\pm 0.5^\circ$, 100Hz–50kHz	
Signal/Noise Ratio (below 25kHz deviation)	55dB, 30Hz–15kHz 60dB at 15.734kHz 50dB, 16kHz–47kHz 44dB, 63kHz–94kHz 40dB, 30Hz–120kHz	44dB, 63kHz–94kHz 40dB, 16kHz–120kHz
THD (30Hz–15kHz)	<0.5% up to 25kHz deviation <1.0% up to 50kHz deviation	(not applicable)
SMPTE IM Distortion	<1.0%	(not applicable)

Fig. 1-8: RS-508 Exciter Performance Specifications

Additional Sources of information

BTSC System Multichannel Television Sound Recommended Practices

This lengthy document produced by the Electronic Industries Association suggests methods and standards for implementation both in receivers and transmitters. It is somewhat mathematical and idealized, and does not consistently recognize field practicalities. Primarily oriented towards design engineers in the transmitter and receiver industries, it nevertheless contains some highly useful information for the well-grounded station engineer.

From: Electronic Industries Association
Consumer Electronics Group
2001 Eye Street, N.W.
Washington, D.C. 20006
(202) 457-4919 TWX 710-822-0148

Multichannel Television Transmission and Audio Processing Requirements for the BTSC System. FCC Office of Engineering and Technology Bulletin No. 60, April 1984. (Known popularly as OET-60A.)

The definitive FCC document which defines the standards for the Multichannel Television Service when a 15,734Hz pilot tone is present. (If the tone is not present, almost any combination of subcarriers can be used for broadcast or non-broadcast applications.)

From: U.S. Government Printing Office
Washington, D.C.
Order desk: (202) 783-3238

National Association of Broadcasters: Proceedings of the 39th Annual Broadcast Engineering Conference, Las Vegas, Nevada, 1985.

Sixty-six pages of meaty, practical articles for station engineers. RCA's Mattison discusses RF considerations and especially conversion techniques for various RCA transmitters. ITS's Zborowski treats transmitter plant requirements and testing. Jim Swick of WTTW, Chicago, talks about system design and configuration. Randy Hoffner of NBC explains how to prepare the transmitter. Aitken and Fiore of Comark illuminate diplexer mysteries as does a succeeding article from Micro Communications. Finally, Geoff Mendenhall of Broadcast Electronics addresses the testing of the existing plant for MTS service. There are other interesting articles on audio for MTS.

The ***38th Annual Proceedings*** (1984 Conference) contains good articles on how the system works.

The ***NAB Engineering Handbook*** (7th Edition; 1985) contains MTS information on pages 3.5-149 to 3.5-154, and on pages 3.6-185 to 3.6-196.

From: NAB Services
1771 N Street, N.W.
Washington, D.C. 20036
Order by phone: (800) 368-5644

Registration, Warranty, Feedback

Registration Card

There are two good reasons for returning the Registration Card shipped with this product:

- 1) It enables us to inform you of new applications, performance improvements, and service aids which may be developed, and
- 2) It helps us respond promptly to claims under warranty without having to request a copy of your bill of sale or other proof of purchase.

Please fill in the Registration Card and send it to us today. If it is lost (or you have purchased this unit used), please photocopy the duplicate below, fill it in, and send it to Orban at the address on the inside of the front cover.

Registration Card			
Model # _____	Serial # _____	Purchase Date _____	
Your name _____		Title _____	
Company _____		Telephone _____	
Street _____			
City, State, Mail Code (Zip), Country _____			
Nature of your product application _____			
How did you hear about this product? _____		Purchased from _____	
Comments _____			
Which magazines do you find the most useful to your job?			
<input type="checkbox"/> Audio	<input type="checkbox"/> Broadcast Engineering	<input type="checkbox"/> Broadcast	<input type="checkbox"/> dB Magazine
<input type="checkbox"/> Electronic Musician	<input type="checkbox"/> EQ	<input type="checkbox"/> Millimeter	<input type="checkbox"/> Mix
<input type="checkbox"/> Post	<input type="checkbox"/> Pro Sound News	<input type="checkbox"/> Radio & Records	<input type="checkbox"/> Radio World
<input type="checkbox"/> RE/P	<input type="checkbox"/> Sound & Communications	<input type="checkbox"/> S & VC	<input type="checkbox"/> TV Broadcast
<input type="checkbox"/> TV Tech	_____	_____	_____
_____	_____	_____	_____

95101-000-07 1/91

Warranty

The warranty, which can be enjoyed only by the first end-user of record, is stated on the separate Warranty Certificate packed with this manual. Save it for future reference. Details on obtaining factory service are provided on page 5-13.

User Feedback Form

We are very interested in your comments about this product. Your suggestions for improvements to either the product or the manual will be carefully reviewed. A postpaid User Feedback Form is provided in the back of this manual for your convenience. If it is missing, please write us at the address on the inside of the front cover. Thank you.

Notes:

Section 2

Installation

page contents

2-2 Installation — Quick Set-up

2-3 Installation — Comprehensive Instructions

- 2-6 Fig. 2-1: AC Power Plug Wiring
- 2-8 Fig. 2-2: Jumper positions, 8185A Stereo Generator Card #2
- 2-8 Fig. 2-3: Jumper positions, 8185A Stereo Generator Card #7
- 2-9 Fig. 2-4: Jumper positions, 8185A Stereo Generator Meter Resistor Board
- 2-10 Fig. 2-5: Card Positions, 8182A/ST Studio Chassis
- 2-11 Fig. 2-6: Jumper Positions, 8182A Audio Processor Card #7
- 2-13 Fig. 2-7: Control Settings for Step 12
- 2-16 Fig. 2-8: Oscilloscope Display for Steps 13 and 15
- 2-19 Fig. 2-9: Control Settings for Step 16
- 2-19 Fig. 2-10: Bessel Null
- 2-21 Fig. 2-11: Control Settings for Step 17
- 2-23 Fig. 2-12: Control Settings for Step 20
- 2-26 Fig. 2-13: Control Settings for Step 21

2-28 Rewiring the 8182A Accessory Port

- 2-31 Fig. 2-14: Motherboard Solder Forks, 8182A Audio Processor
- 2-32 Fig. 2-15: Accessory Port Wiring Diagram, 8182A Audio Processor

CAUTION

The installation and servicing instructions in this manual are for use by qualified personnel only. To avoid electric shock do not perform any servicing other than that contained in the Operating Instructions unless you are qualified to do so. Refer all servicing to qualified service personnel.



Installation (Quick Set-up)

The detailed comprehensive installation instructions which follow cover many special situations and include tests of the plant's readiness for BTSC stereo operation. If your plant is qualified for stereo operation and your situation is not unusual, everything you need to know to get up and running is on this page. If you are using the optional 8182A/ST Studio Chassis, you should probably use the comprehensive instructions. Refer to the comprehensive installation procedure on page 2-3 for more information.

1) Reset jumpers (if necessary).

If you are using the 8182A OPTIMOD-TV Audio Processor, move these jumpers on its Card #7: jumpers A and B to the "PRE-EMPHASIZED" position, jumper C to the "L OUT" position, and jumper D to "R OUT" (see Fig. 2-6 on page 2-11).

If you are using another audio processor, move these jumpers on the 8185A Stereo Generator's Card #2: jumpers A, C, D, and F to the "EXT. PROCESSOR" position (see Fig. 2-2 on page 2-8). Configure your audio processor for pre-emphasized output, if possible (if only flat output is available, move jumpers B and E on Card #2 to the "FLAT INPUT" position).

2) Mount and connect 8185A Stereo Generator.

Connect power and ground (also connect the chassis ground jumper on the 8185A's rear panel to the audio processor's chassis), input audio (use the supplied interconnect cable for the 8182A Audio Processor), and sync or composite video to the 8185A. Connect the 8185A's composite output to the exciter. Set controls as shown in Fig. 2-11 on page 2-21 (if you are using the 8182A Audio Processor, set its rear-panel STEREO GENERATOR switch to IN).

3) Match audio processor and 8185A Stereo Generator levels.

Feed typical program material at normal levels to the audio processor. Adjust the processor's input level for normal operation. If you are using the 8182A Audio Processor, temporarily set its CLIPPING control to "+2".

Set the 8185A Stereo Generator to L INPUT FILTER, then adjust the audio processor's left output level until the 8185A's VU meter reads *exactly* "0VU" (100%) on peaks. Reset the VU meter selector to R INPUT FILTER, then adjust the audio processor's right output level until the 8185A's VU meter reads *exactly* "0VU" (100%) on peaks. If using the 8182A, reset its CLIPPING control to "-1".

4) Match 8185A Stereo Generator to exciter (Bessel null).

Connect an RF spectrum analyzer to a sample of the aural exciter's output. Set the 8185A Stereo Generator's BESSEL NULL CAL control to TONE. Turn the 8185A's TOTAL BASEBAND OUTPUT LEVEL control fully counterclockwise (up to 18 turns), then slowly turn the control clockwise until the carrier nulls for the first time. Return the BESSEL NULL CAL switch to OPERATE.

5) Complete and return the Registration Card.

Installation (Comprehensive Instructions)

Allow about 2 hours for installation. Follow instructions in the order given, as some steps depend on the results of previous steps.

The 8185A OPTIMOD-TV Stereo Generator can be used with the OPTIMOD-TV Audio Processing System or with other audio processing. The following instructions cover both situations. For those using OPTIMOD-TV processing, detailed instructions for installation of the 8182A OPTIMOD-TV Audio Processor and the optional 8182A/ST Studio Chassis are included.

Installation begins with a check-out of the unit(s) and setting of option jumpers on circuit cards. The unit(s) are mounted in a rack, connected to power and sync, and the 8185A Stereo Generator and audio processor are level-matched. After verification of baseband separation out of the 8185A Stereo Generator, the unit is connected to the exciter. Verifying transmitter sensitivity, verifying separation out of the transmitter, matching levels (Bessel null) between the 8185A Stereo Generator and exciter, connecting the audio inputs and outputs, adjusting input levels with program material, and checking modulation level and air sound complete the process.

Completely install and check the 8185A OPTIMOD-TV Stereo Generator (and the 8182A Audio Processor and 8182A/ST Studio Chassis, if used) before installing the optional OPTIMOD-TV Second Audio Program Generator (8185A/SAP), Professional Channel Generator (8185A/PRO), or Automatic Stereo Synthesizer (275A). See each unit's Operating Manual for installation instructions.

Equipment required:

Low-distortion audio oscillator

Triggered-sweep oscilloscope

With at least 5MHz vertical bandwidth.

RF spectrum analyzer

To look at the aural carrier.

Optional, but strongly recommended:

Precision aural wideband demodulator

Tektronix 1450-1 with wideband composite output, Telemet 3713, Belar TVM-100, TFT 850, or equivalent.

BTSC stereo decoder/monitor

Helpful for monitoring audio off air, but not required. Should *not* be used for adjusting composite level or separation.

CAUTION

Be sure power is off before removing or inserting any of the printed circuit cards.

1) Unpack and inspect.

If obvious physical damage is noted, contact the carrier immediately to make a damage claim.

If you should ever have to ship a unit (e.g., for servicing), it is best to ship it in the original packing materials since these have been carefully designed to protect the unit. Therefore, make a mental note of how the unit is packed and *save all packing materials*.

Packed with the 8185A OPTIMOD-TV Stereo Generator are:

- 1 Power cord
- 1 3-wire power cord plug adapter
- 4 10-32 × 3/4-inch rack screws
- 1 5/64-inch hex wrench for front-panel screws
- 2 Keys for front-panel door
- 1 Adjustment tool (mounted inside front-panel door)
- 1 Extender card (shipped in the card rack)
- 1 Wrench for removing knobs
- 1 Final Factory Qualification Test Results (3 pages)
- 1 Memo, "Please Read This"
- 1 Warranty Certificate
- 1 Registration Card
- 1 Operating Manual

And these items for those using the 8182A OPTIMOD-TV Audio Processor:

- 1 Cable for interconnection with the 8182A Audio Processor
- 2 Resistors, 620-ohm ±5%, 1/4-watt, carbon film
- 1 Retrofit Kit RET-035 for older 8182A units

Packed with the 8182A OPTIMOD-TV Audio Processor are:

- 1 Power cord
- 1 3-wire power cord plug adapter
- 4 10-32 × 3/4-inch rack screws
- 1 5/64-inch hex wrench for front-panel screws
- 2 Keys for front-panel door
- 1 Adjustment tool (mounted inside front-panel door)
- 1 Extender card (shipped in the card rack)
- 1 Wrench for removing knobs
- 1 Final Factory Qualification Test Results
- 1 Memo, "Please Read This"
- 1 Warranty Certificate
- 1 Registration Card
- 1 Operating Manual

Packed with the optional 8182A/ST OPTIMOD-TV Studio Chassis are:

- 1 Card #3TX
- 1 Card #4TX
- 12 6-32 × 3/16-inch screws for mounting cards
- 4 6-32 × 1 1/4-inch stand-offs for mounting Card #2
- 1 3-wire power cord plug adapter
- 4 10-32 × 3/4-inch rack screws
- 2 Keys for front-panel door
- 1 Adjustment tool (mounted inside front-panel door)
- 1 Wrench for removing knobs
- 2 Resistors, 620-ohm ±5%, 1/4-watt, carbon film
- 1 Memo, "Please Read This"
- 1 Warranty Certificate
- 1 Registration Card
- 1 Operating Manual

- A Remove the three hex-socket screws at the top of the 8185A Stereo Generator's front panel with the 5/64-inch hex wrench provided with the unit, then tilt the hinged front panel down to reveal the interior.
- B Loosen the four DZUS fasteners on the subpanel by turning each fastener 1/4-turn counterclockwise with a long 3/16-inch or 1/4-inch flat-blade screwdriver.
- C Taking care not to stress the flat cables beneath it, tilt the top of the subpanel outward and to the left to clear the upper chassis lip and the door support rail at the right.
- D Carefully remove each circuit card, check that all IC components are properly seated in their sockets, then return each card to its slot.
- E If you are using the 8182A Audio Processor, repeat steps a) through d) for that unit.

2) Connect power.

- A DO NOT connect power to the unit yet!
- B Check that AC POWER switches behind the front panels are set to ON.
- C Check the line voltage.

The 8185A, 8182A, and 8182A/ST are shipped ready for 115 or 230V, 50/60Hz operation. Refer to the unit's rear panel for your Model # and the inside front cover of the manual for your Model #'s line voltage setting. To change the operating voltage, set the VOLTAGE SELECTOR to 115V or 230V as appropriate (voltages 15% of the nominal voltage are acceptable).
- D Check the value of the fuse and change the fuse if the value is incorrect.

For safety the fuse must be 1/2-amp 250V Slow Blow fuse — 3AG or 250mA "T" type as appropriate (for 115-volt or 230-volt operation). The 8182A/ST is hard wired for the voltage ordered (instructions for changing the 8182A/ST's voltage are in the 8182A/ST Operating Manual).



- E Connect the 8185A, 8182A, and 8182A/ST's power cord to an appropriate AC power source.

The power cord is ordinarily terminated in a "U-ground" plug (USA standard), or CEE7/7 plug (Continental Europe), as appropriate to your unit's Model #. The green (or green/yellow) wire from the safety-ground prong is connected directly to the chassis.

If it becomes necessary to lift this ground to suppress ground loops, do so with a three-prong to two-prong adapter plug, rather than by damaging the power plug. But you should *not* defeat the ground unless absolutely necessary, because it eliminates the intrinsic safety feature of the three-wire system.

WARNING



If the ground is defeated, certain fault conditions in the unit or in the system to which it is connected can result in full line voltage between chassis and earth ground. Severe injury or death can then result if the chassis and earth ground are touched simultaneously.

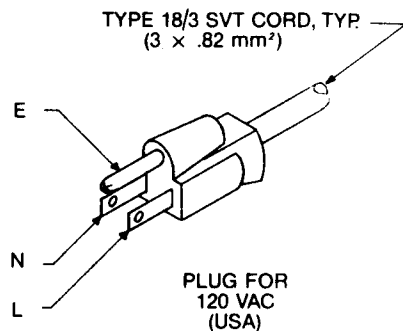

CONDUCTOR		WIRE COLOR	
		Normal	Alt
L	LINE	BROWN	BLACK
N	NEUTRAL	BLUE	WHITE
E	EARTH GND	GREEN-YELLOW	GREEN

Fig. 2-1: AC Power Cord Color Coding

3) Check indicators and meters.

[If you would like to perform a complete field audit of the 8185A Stereo Generator's performance before installing it, see Section 4 of this manual. Appendix D of the 8182A Operating Manual gives field audit instructions for the 8182A Audio Processor.]

- A Connect AC power to each unit.
- B Verify that the POWER indicators and the 8182A's GATE indicator light, and that the 8185A's SYNC LOCK, PRO and STEREO indicators, the 8182A's HF LIMIT indicators, and the 8182A/ST's GATE indicator remain unlit.

If indicators do not respond as they should, repeat step 1. If that does not correct the problem, see the troubleshooting routines in Section 5.

- c Verify that the VU meters of each unit* reads "0VU" ±1VU when its selector is set to -15 VDC or +15 VDC.

* Except the 8182A/ST's meter should read "-3VU" ±1VU.

If a meter reading is abnormal, repeat step 1; if that does not correct the problem, see Section 5.

- d Disconnect the power.

4) Reposition 8185A Stereo Generator jumpers.

See Fig. 2-2 for jumper positions.

- A** *If you are using the 8182A Audio Processor*, verify that jumpers A, C, D and F on the 8185A Stereo Generator's Card #2 are in the "8182A" position, and that jumpers B and E on Card #2 are in the "PRE-EMPHASIZED INPUT" position.

The 8185A is shipped with Card #2 jumpers in these positions.

- B** *If you are using another audio processor*, place jumpers A, C, D and F on the 8185A Stereo Generator's Card #2 in the "EXT. PROCESSOR" position. Place jumpers B and E on Card #2 in the "PRE-EMPHASIZED INPUT" position if you are feeding the 8185 Stereo Generator pre-emphasized audio; place them in the "FLAT INPUT" position if you are feeding "flat" audio.

Feed pre-emphasized audio to the 8185A Stereo Generator, if possible.

- C** If your exciter requires that the 8185A Stereo Generator have a 75-ohm output impedance, move jumper A on the 8185A Stereo Generator's Card #7 to the "75Ω" position.

See Fig. 2-3. Since normal and suggested practice is to run 0Ω lines which are terminated with 75Ω, this jumper is shipped in the "0Ω" position (see step 13 on page 2-16 for more information).

- D** If you would like the 8185A Stereo Generator to power up in right channel mono or left channel mono instead of in stereo, move jumper B on the 8185A Stereo Generator's Card #7 accordingly.

See Fig. 2-3 for jumper positions.

- E** If you would like the 8185A Stereo Generator to use the right channel for mono input instead of the left, move jumper C on the 8185A Stereo Generator's Card #7 accordingly.

See Fig. 2-3 for jumper positions.

- F** If you would like make the 8185A Stereo Generator's VU meter a true peak-reading meter, move jumper A on the 8185A Stereo Generator's Meter Resistor Board to the "0ms" position.

With jumper A in the "0ms" position, the meter will read every transient overshoot from the noise reduction encoder and from the 15kHz low-pass filters. Because such overshoots are so quick that they cause no interference to the video or to other channels, readings of these peaks are not meaningful. With jumper A in the "1.5ms" position (as shipped), the meter reads significant peaks and ignores extremely brief transient overshoots. Even with jumper A in the "1.5ms" position, the meter still responds about 7 times faster than an EBU-standard peak program meter (PPM).

The Meter Resistor Board is mounted on the inside of the front panel. Jumper A is located on the solder side of the board for easy access. See Fig. 2-4 for jumper positions.

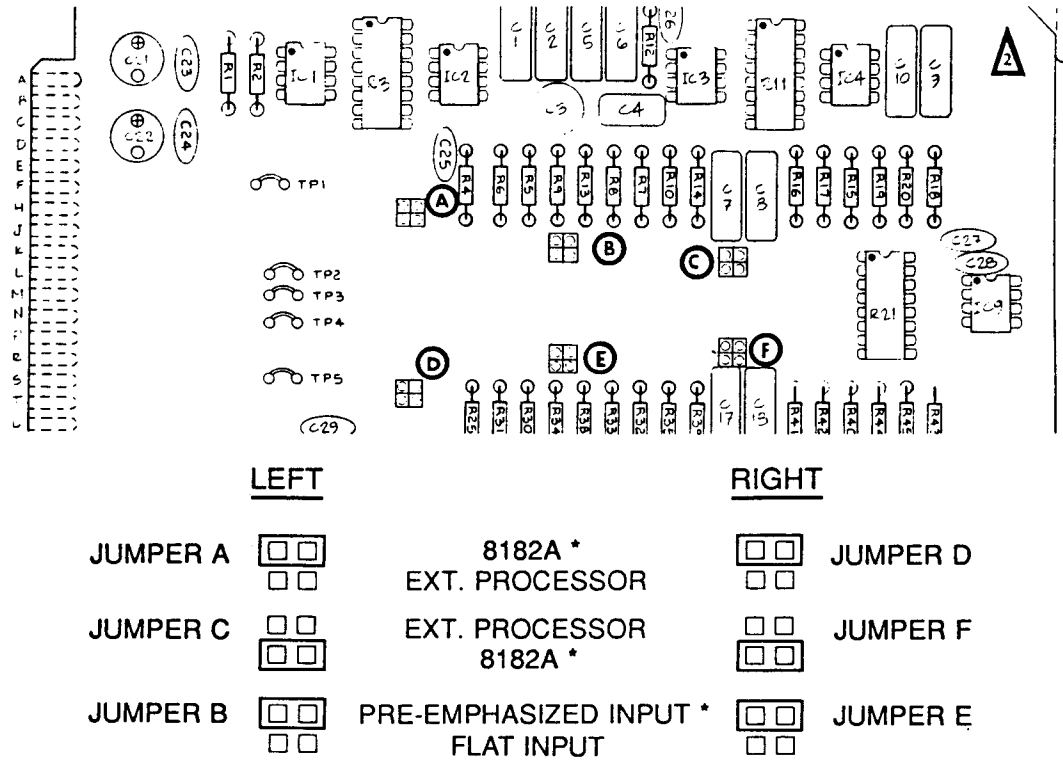

* As shipped

Fig. 2-2: Jumper positions, 8185A Stereo Generator Card #2

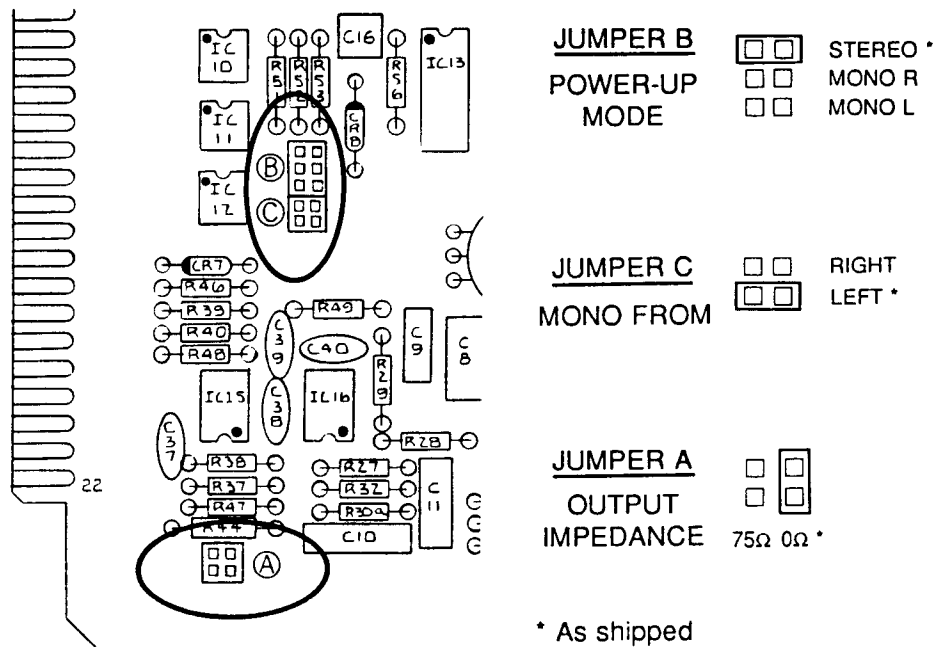

* As shipped

Fig. 2-3: Jumper positions, 8185A Stereo Generator Card #7

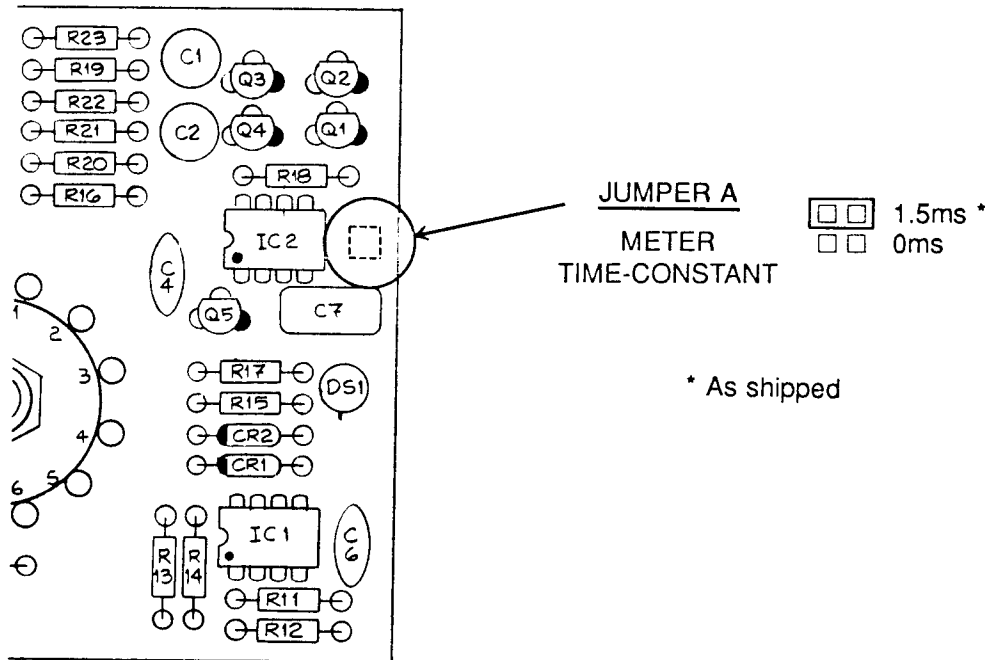

Fig. 2-4: Jumper positions, 8185A Stereo Generator Meter Resistor Board
(Jumper is on solder side — opposite components.)

5) Install 8182A/ST Studio Chassis circuit cards. (optional)

[Skip this step if you will not also be installing the optional 8182A/ST Studio Chassis with the 8182A Audio Processor.]

- A Remove Cards #2, #3, #4, and #5 from the 8182A Audio Processor.
- B Install Card #3TX in the 8182A Audio Processor's slot #3, and install Card #4TX in slot #4.
- C Remove the top and bottom covers of the 8182A/ST Studio Chassis, and install circuit cards as shown in Fig. 2-5.

Position Card #5, attach the edge connector to the card, then secure the card to the standoffs with the supplied 6-32 screws. Center the control knobs in their holes just before tightening down the screws.

Install Card #3 in the same way, using the supplied 6-32 hex standoffs instead of screws.

Mount Card #2 *component side down* on these standoffs and fasten with 6-32 screws.

Turn the unit upside-down, install Card #4 *component side up*, and secure the card with 6-32 screws.

See the 8182A/ST Operating Manual for additional information.

- D Replace the top and bottom covers of the 8182A/ST Studio Chassis.

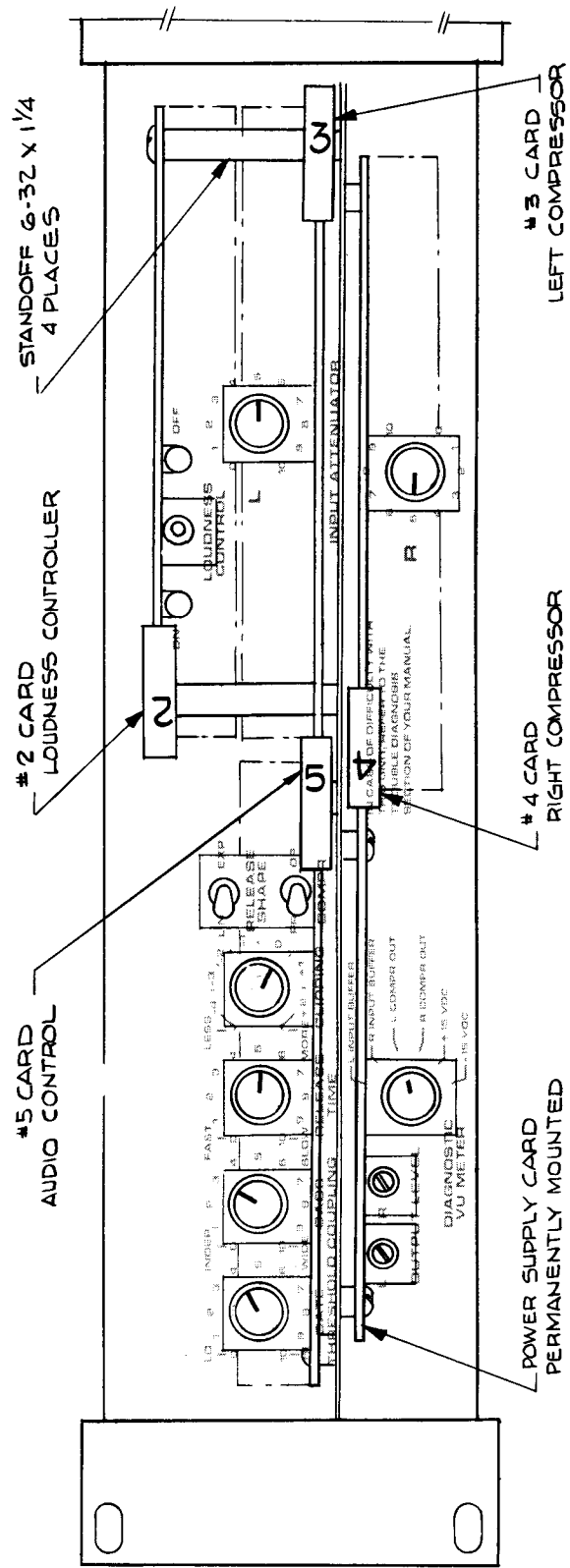
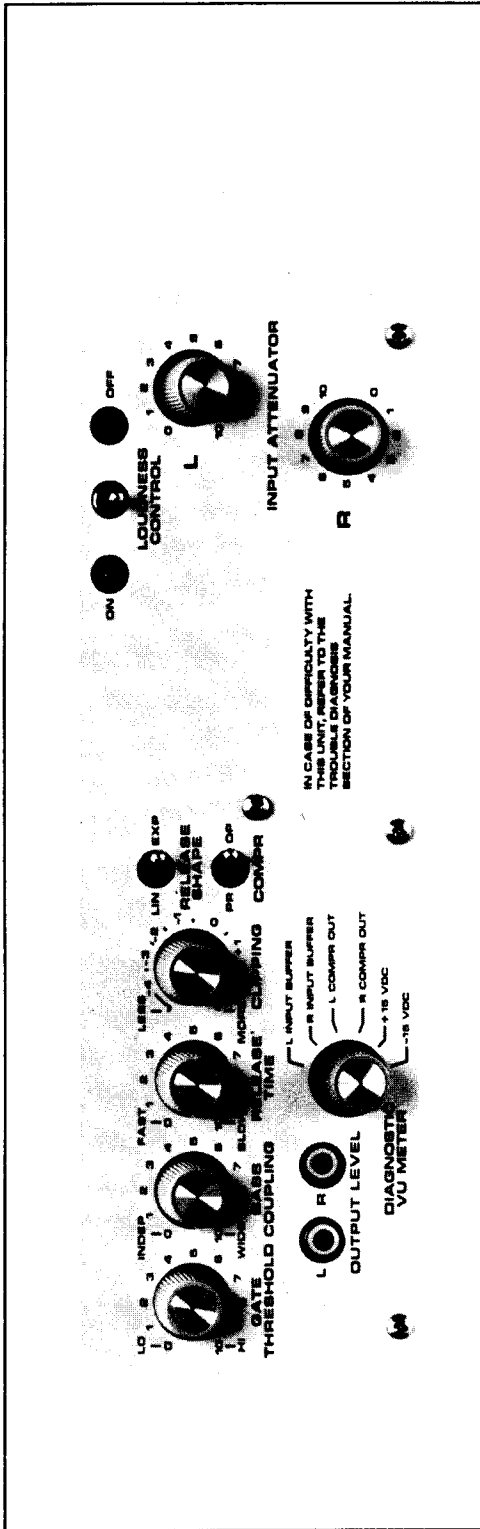

Fig. 2-5: Card Positions, 8182A/ST Studio Chassis

6) Reconfigure 8182A Audio Processor.

[Skip this step if you are not using Orban's 8182A Audio Processor.]

- A On the 8182A Audio Processor's Card #7, reposition jumpers A, B, C, and D as shown in Fig. 2-6.

Note that the correct jumper positions for use with the 8185A Stereo Generator are not the same positions that are used with Orban's earlier 8182A/SG Stereo Generator.

- B Set the 8182A's rear-panel STEREO GENERATOR switch to IN.
This switch is labeled "NOISE REDUCTION" on some earlier units.

- C Only if the serial number of your 8182A Audio Processor is below 780000 will you need to rewire its ACCESSORY PORT (see page 2-28).

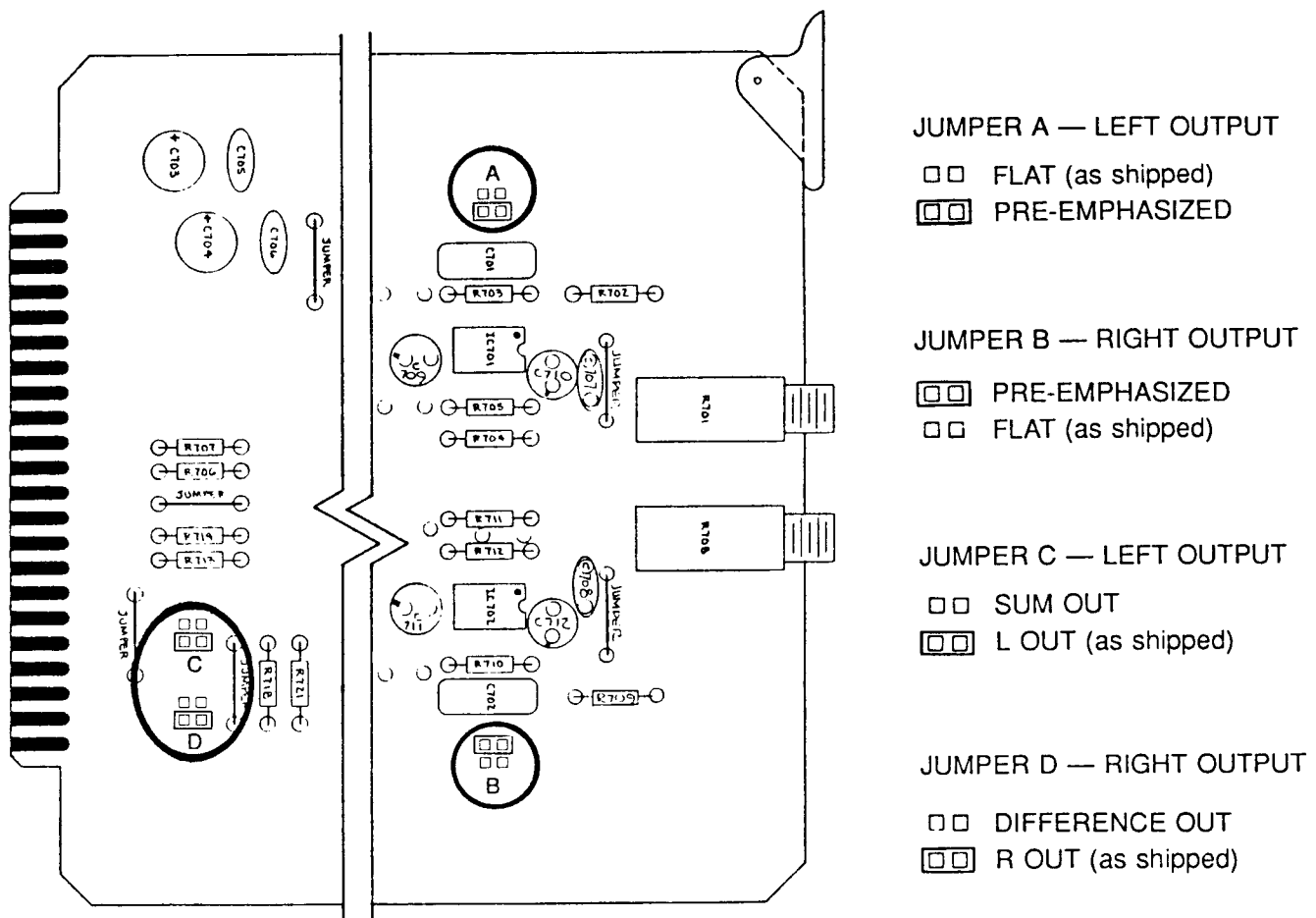

Fig. 2-6: Jumper Positions, 8182A Audio Processor Card #7

7) Zero VU meters.

- A Set the 8185A Stereo Generator's (and, if used, the 8182A Audio Processor's) VU meter selector to one of the unlabeled positions.
- B Mechanically zero the VU meter(s).

8) Reassemble units.

- A Replace the subpanel and close the front panel of the 8185A Stereo Generator (and of the 8182A Audio Processor, if used).



Be sure that all four fasteners on the subpanel are engaged, since the subpanel is an integral part of the unit's RF shielding.

The DZUS fasteners turn only 1/4-turn. Don't force them, lest they be damaged in a way that is very time consuming to repair.

9) Mount and ground units.

- A Mount the 8185A Stereo Generator (and 8182A Audio Processor and 8182A/ST Studio Chassis, if used) in appropriate racks.

The 8185A Stereo Generator is ordinarily located close to the transmitter's aural exciter or wideband composite microwave subcarrier generator. If used with the 8182A Audio Processor, the 8185A Stereo Generator must be mounted immediately above (or below) the 8182A. The 8182A/ST Studio Chassis, when used, is located in the studio.

- B Connect the 8185A Stereo Generator's circuit ground to the station's RF system ground.
- C Connect the chassis ground jumper that is attached to the back of the 8185A Stereo Generator to the audio processor's chassis.

If you are using the 8182A Audio Processor, connect the ground jumper to one of the screws circled in black on the 8182A Audio Processor's rear panel.

- D To drive a *balanced* exciter input, connect the 8185A Stereo Generator's circuit and chassis grounds to each other at the rear-panel terminals (as shipped).

If you are using the Orban 8182A Audio Processor, DO NOT connect the 8182A Audio Processor's circuit and chassis ground terminals together.

- E To drive an *unbalanced* exciter input, DO NOT connect the 8185A Stereo Generator's chassis and circuit grounds together.

10) Connect the output of the audio processor to the 8185A Stereo Generator's inputs.

If you are using Orban's 8182A Audio Processor, connect the 8182A Audio Processor and 8185A Stereo Generator with the supplied 14-pin interconnect cable.

If you are using other audio processing, feed L and R, *not* L-R and L+R audio. Feed either pre-emphasized or "flat" audio (your audio processor and the 8185A Stereo Generator must both be set for your choice — see step 4).

11) Connect sync input.

- A Connect sync or composite video to the 8185A Stereo Generator's rear-panel SYNC IN (J1) connector.
- B Set the SYNC INPUT TERMINATION IMPEDANCE switch to 75 OHMS, unless you wish to loop the sync signal through the 8185A Stereo Generator. For loop-through, set the switch to HI-Z and take the output from SYNC OUT connector J2.

Do not connect audio inputs or composite output at this time.

8185A OPTIMOD-TV Stereo Generator:

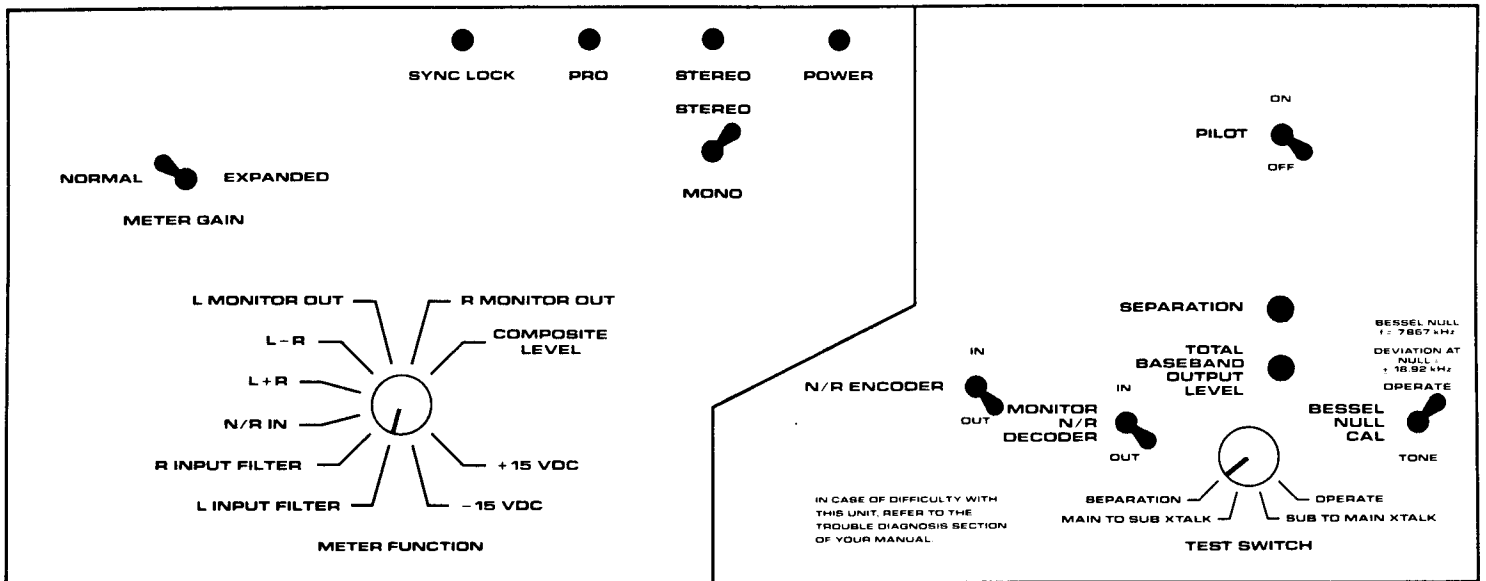

8182A OPTIMOD-TV Audio Processor:

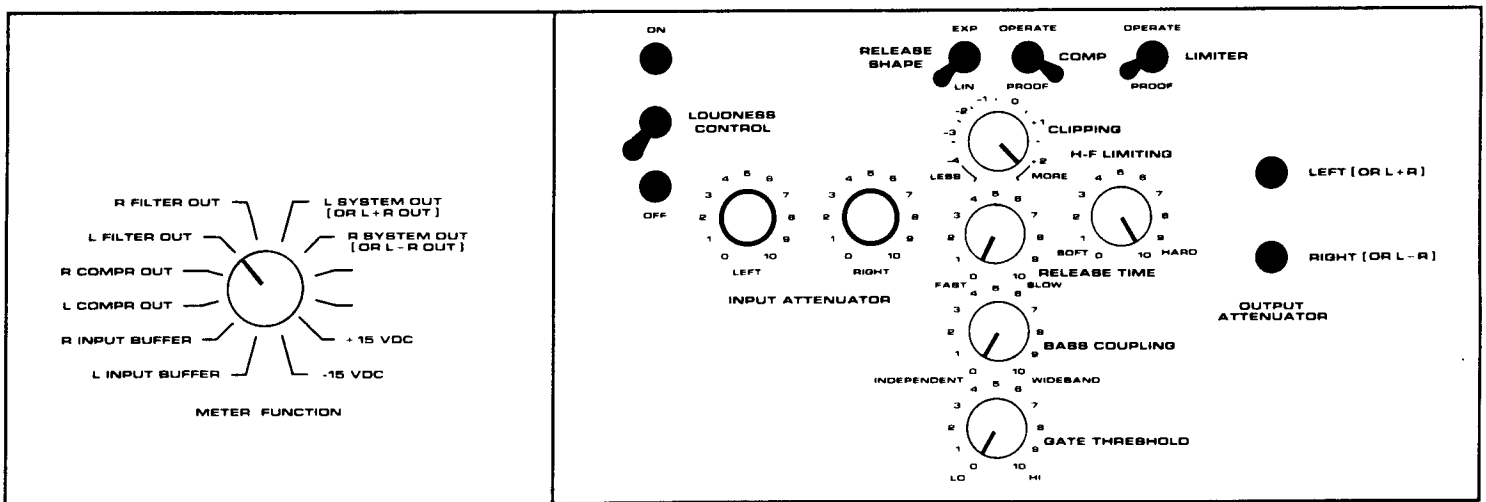

Fig. 2-7: Control Settings for Step 12

12) Match levels of audio processor and 8185A Stereo Generator (with tone).

(Later, when program lines are connected, level-matching can be performed just as effectively with program material as with tone.)

- A Set controls as shown in Fig. 2-7. If you are using the 8182A Audio Processor, set its controls as shown in Fig. 2-7.

IMPORTANT: If your audio processor is already installed, record the settings of all controls before proceeding.

- B Patch an audio oscillator into the left input of the audio processor. Set the oscillator's frequency to 100Hz.

- C Adjust the audio processor to produce a calibrated output equivalent to 100% modulation:

8182A Audio Processor — Adjust the audio oscillator's output level until the 8182A Audio Processor's VU meter reads *exactly* "+3VU".

Other processors — Follow manufacturer's instructions.

- D Adjust the output level of the audio processor's left channel until the 8185A Stereo Generator's VU meter reads *exactly* "0VU" (100%).

On the 8182A Audio Processor use the LEFT OUTPUT ATTENUATOR control.

- E Disconnect the audio oscillator from the audio processor's left input and connect it to the right input.

Leave the oscillator's frequency set to 100Hz.

- F Set the 8185A Stereo Generator's VU meter selector to R INPUT FILTER. If you are using the 8182A Audio Processor, set its VU meter selector to R FILTER OUT.

- G Adjust the audio processor to produce a calibrated output equivalent to 100% modulation:

8182A Audio Processor — Adjust the audio oscillator's output level until the 8182A Audio Processor's VU meter reads *exactly* "+3VU".

Other processors — Follow manufacturer's instructions.

- H Adjust the output level of the audio processor's right channel until the 8185A Stereo Generator's VU meter reads *exactly* "0VU" (100%).

On the 8182A Audio Processor use the RIGHT OUTPUT ATTENUATOR control.

- I Disconnect the audio oscillator from the audio processor.

13) Verify baseband generator separation.

- A Connect an oscilloscope to the 8185A Stereo Generator's COMPOSITE OUTPUT connector J3.

Use a triggered-sweep oscilloscope with a DC coupling on the input. DO NOT use an attenuator probe. Trigger the oscilloscope externally from the audio oscillator.

- B Set the 8185A Stereo Generator's BESSEL NULL CAL switch to TONE.

- C Adjust the 8185A Stereo Generator's TOTAL BASEBAND OUTPUT LEVEL control until the oscilloscope indicates a level 0.76V peak-to-peak (0.38V peak).

This calibrates the output level of the 8185A Stereo Generator to the RS-508 standard of 1.00V peak-to-peak at 100% main channel modulation (± 25 kHz).

- D Set the 8185A Stereo Generator's BESSEL NULL CAL switch to OPERATE.

- E Set the 8185A Stereo Generator's VU meter selector to L INPUT FILTER. If you are using the 8182A Audio Processor, set its VU meter selector to L FILTER OUT.

- F Patch the audio oscillator into the audio processor's left input. Set the oscillator's frequency to 1kHz, and adjust its output level until the 8185A Stereo Generator's VU meter reads between "-3VU" and "0VU".

- G Adjust the audio oscilloscope's timebase, vertical sensitivity, and trigger controls to obtain a display like the one in Fig. 2-8.

- H Verify that the baseline is flat.

A flat baseline indicates that the stereo baseband encoder section of the 8185A Stereo Generator is adjusted for best separation. If your 8185A Stereo Generator is "factory fresh" and the baseline appears to be curved, check it on another oscilloscope before assuming that the 8185A Stereo Generator is not correctly adjusted. (Some scopes have vertical amplifier problems that will distort the baseline.) If the baseline appears curved on more than one scope, flatten it by adjusting the 8185A Stereo Generator's SEPARATION control. Increase the scope's vertical gain to see the baseline more clearly.

- I Set the audio oscillator to 50Hz, and re-adjust its output level until the 8185A Stereo Generator's VU meter reads between "-3VU" and "0VU".

- J Verify that the baseline is flat.

- K Set the audio oscillator to 15kHz, and re-adjust its output level until the 8185A Stereo Generator's VU meter reads between "-3VU" and "0VU".

- L Verify that the baseline is flat.

If the baseline is not flat at 15kHz or 50Hz, but was flat at 1kHz, it is highly probable that the scope you are using is not sufficiently accurate to be used in the following verification of separation through the transmitter (see step 15). Get a scope that shows a flat baseline at 50Hz and 15kHz before continuing. (Remember that the scope must be DC-coupled; do *not* use an attenuator probe!)

- M Disconnect the oscilloscope.

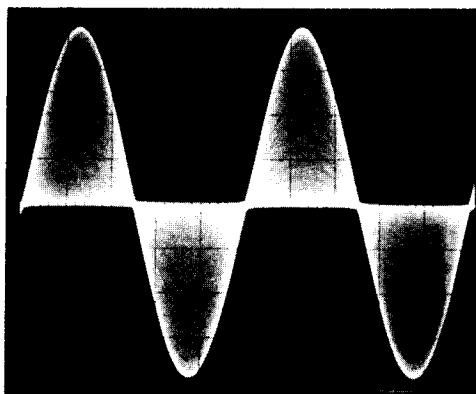

Fig. 2-8: Oscilloscope Display for Steps 13 and 15

Connect 8185A Stereo Generator to exciter.

To feed one exciter, connect the 8185A Stereo Generator's COMPOSITE OUTPUT to the wideband composite input of the aural exciter. Use a 50- or 75-ohm coaxial cable.

Often, best performance is achieved when the exciter's 50- or 75-ohm termination resistor is replaced by a 1000-ohm resistor and jumper A on the 8185A Stereo Generator's Card #7 is in the "0 Ω " position. (Because of the low frequencies involved, do not be concerned that this will cause mismatches between the cable, source, and load.)

To feed more than one exciter, install one or more BNC "T" (J-P-J) adapters on the 8185A Stereo Generator's COMPOSITE OUTPUT. Use a separate 50- or 75-ohm coaxial cable to connect the COMPOSITE OUTPUT to the wideband composite input of each aural exciter. Jumper A on the 8185A Stereo Generator's Card #7 *must* be in the "0 Ω " position.

The 8185A Stereo Generator is capable of driving a total load impedance of 37.5 ohms or greater. However, best performance is often achieved when the exciter's 50- or 75-ohm termination resistor is replaced by a 1000-ohm resistor. This results in best isolation between exciter inputs.

14) Verify transmitter sensitivity.

- A Set the 8185A Stereo Generator's BESSEL NULL CAL switch to TONE.
- B Turn on the aural exciter (and transmitter, if necessary).
- C With a mono or stereo modulation monitor, verify that your main-channel modulation (re ± 25 kHz) is between 50% and 100%.

If it is not, adjust the aural exciter's composite input level control until the modulation monitor indicates 75% main-channel modulation.

- D Set the 8185A Stereo Generator's BESSEL NULL CAL switch to OPERATE.

15) Verify separation through transmitter.

[Skip this step if you do not have access to a demodulator with a wideband composite output.]

- A Verify that the controls are set as shown in Fig. 2-7.
- B Set the audio oscillator's frequency to 1kHz, and adjust its output level until the 8185A Stereo Generator's VU meter reads between "-3VU" and "0VU".
- C Demodulate the off-air signal with a precision RF demodulator or a stereo (*not* mono) baseband monitor with a composite output.
- D Connect the composite baseband output of the demodulator (or baseband monitor) to a triggered-sweep oscilloscope.

Use DC coupling on the oscilloscope input. DO NOT use an attenuator probe. Trigger the oscilloscope externally from the audio oscillator. Is your scope accurate enough? — see step 13-L.

- E Adjust the oscilloscope's timebase, vertical sensitivity, and trigger controls to obtain a display like the one in Fig. 2-8.

A flat baseline indicates proper separation at the output of the transmitter. If the baseline is curved, the exciter/transmitter system does not have perfectly flat frequency response and/or phase response in the BTSC passband. You can compensate for this to some degree by adjusting the 8185A Stereo Generator's SEPARATION control. Increase the oscilloscope's vertical sensitivity to see the baseline more clearly.

Separation can be estimated from the oscilloscope display using the formula:

$$S = 20[\log(P/D)]$$

S = Separation in dB

D = peak-to-peak deviation from perfect flatness in volts

P = peak-to-peak level of the total baseband in volts

If separation is less than 40dB after adjusting the SEPARATION control, the most likely cause is bandwidth limitations in the transmission path. Diplexers are particularly suspect. If this is the case, separation at 15kHz (measured in step G, below) will be much worse than it is at 1kHz.

- F Set the audio oscillator's frequency to 50Hz, adjust the audio oscillator's output level until the 8185A Stereo Generator's VU meter reads between "-3VU" and "0VU", then adjust the oscilloscope's timebase, vertical sensitivity, and trigger controls to obtain a display like the one in Fig. 2-8.

If the baseline was flat at 1kHz, but is now curved at 50Hz, there is a problem either with the time-constant of the exciter's AFC or with inadequate low-frequency response. Test the AFC time-constant by turning off the exciter's AFC circuit and observing the baseline. If it flattens, the time-constant needs to be increased.

Test low-frequency response by connecting the audio oscillator directly to the exciter's composite input, then sweeping the audio oscillator from 400Hz down to 5Hz while observing the amplitude of the demodulated audio on the oscilloscope. It should remain flat.

DO NOT readjust the 8185A Stereo Generator's SEPARATION control to try to correct loss of separation at 50Hz.

- Set the audio oscillator's frequency to 15kHz, adjust the audio oscillator's output level until the 8185A Stereo Generator's VU meter reads between "-3VU" and "0VU", then adjust the oscilloscope's timebase, vertical sensitivity, and trigger controls to obtain a display like the one in Fig. 2-8.

If the baseline was flat at 1kHz and 50Hz, but is now curved at 15kHz, the problem probably is insufficient bandwidth in the exciter, RF amplifier, or diplexer.

DO NOT readjust the 8185A Stereo Generator's SEPARATION control.

- Disconnect the oscilloscope.

16) Match 8185A Stereo Generator to exciter (Bessel null).

- Set the 8185A's controls as shown in Fig. 2-9.
- Connect an RF spectrum analyzer to a sample of the output of the aural exciter or aural transmitter.

If feeding more than one exciter, sample the "main" exciter first.

If a spectrum analyzer is not available, adjust the 8185A Stereo Generator's TOTAL BASEBAND OUTPUT LEVEL control to obtain 75.7% modulation (referenced to ± 25 kHz deviation) as indicated on your mono modulation monitor, or 75.7% main channel modulation as indicated on your stereo modulation monitor. (This is a crude method, since most modulation monitors are not accurate enough for this adjustment; errors can result in loss of stereo separation and possibly in non-compliance with FCC/DOC deviation specifications.)

- Turn the 8185A Stereo Generator's TOTAL BASEBAND OUTPUT LEVEL control fully counterclockwise (up to 18 full turns).
- Slowly turn the 8185A Stereo Generator's TOTAL BASEBAND OUTPUT LEVEL control clockwise until the carrier nulls for the *first* time (see Fig. 2-10).

The 8185A Stereo Generator produces a 7.867kHz ($1/2$ H) Bessel tone, which results in a first Bessel null at ± 18.918 kHz deviation. This is 75.673% modulation re ± 25 kHz carrier deviation. The internal level of the tone has been set so that very accurate ($\pm 0.1\%$) calibration of the noise reduction encoder to exciter deviation gain is possible. **Note**, however, that 100% L+R modulation (± 25 kHz deviation) is *not* produced, and that this tone *cannot* be used to align certain manufacturers' "stereo reference decoders" that require a reference tone at 100% modulation.

- If you are feeding more than one exciter*, connect the RF spectrum analyzer to a sample of the second exciter's output, turn the second exciter on, and then adjust the second exciter's composite input level control to achieve the first Bessel null. Adjust additional exciters in the same way.

Do not change the setting of the 8185A Stereo Generator's TOTAL BASEBAND OUTPUT LEVEL control.

NOTE: The level relationship between the 8185A Stereo Generator and the exciter(s) is now precisely set. **DO NOT ALLOW THIS RELATIONSHIP TO CHANGE.** *Do not readjust* the 8185A Stereo Generator's TOTAL BASEBAND OUTPUT LEVEL control. Such changes will cause errors in tracking between the dbx® noise reduction in the 8185A Stereo Generator and that in the receiver, leading to rapid deterioration of separation.



8185A OPTIMOD-TV Stereo Generator:

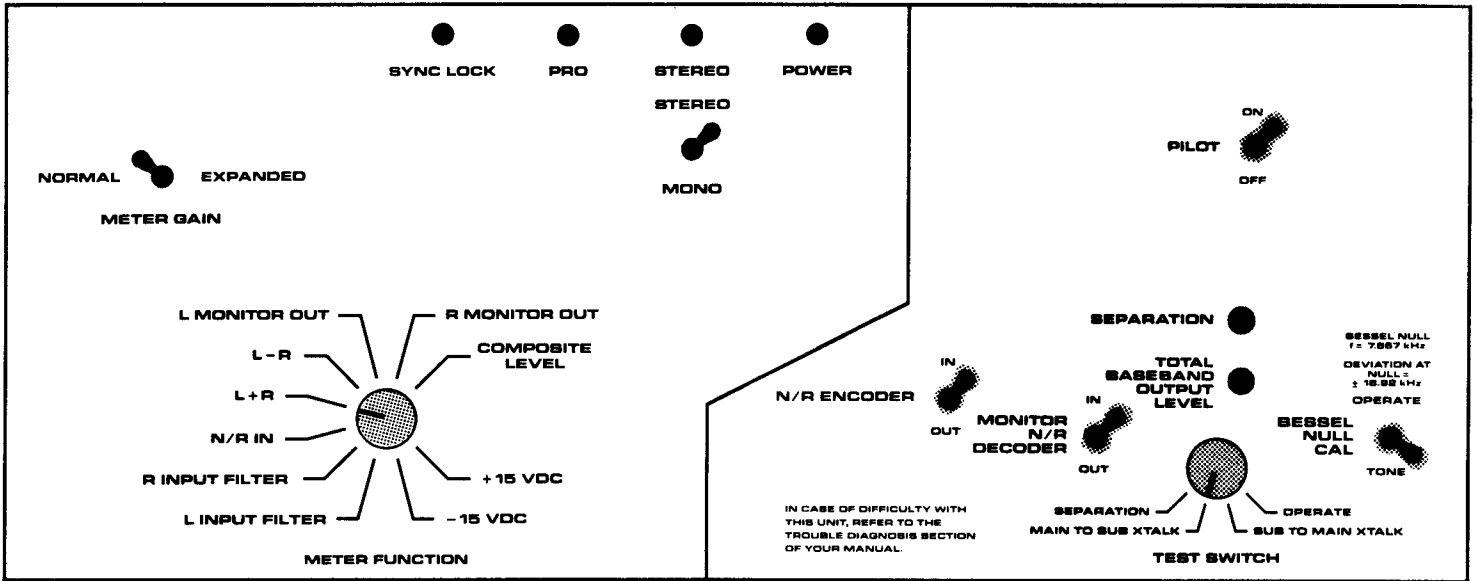

Only shaded controls are set differently than in the last control settings figure.

Fig. 2-9: Control Settings for Step 16

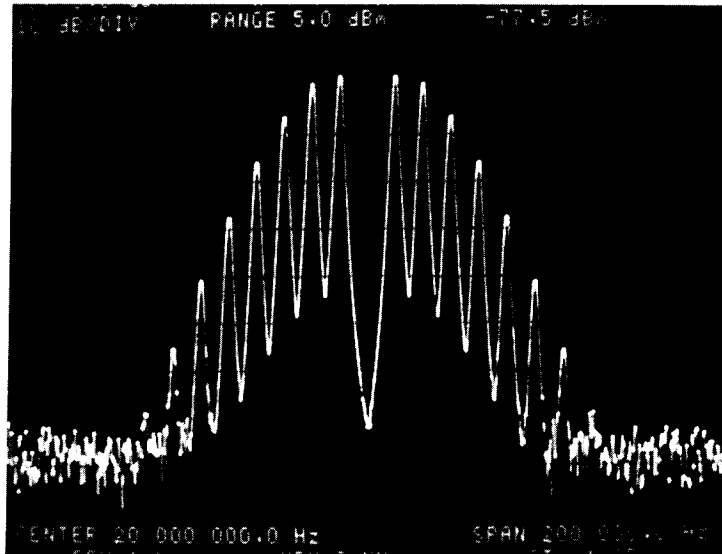

Fig. 2-10: Bessel Null (see step 16)

17) Match levels of the 8182A Audio Processor and the 8182A/ST Studio Chassis.

[Skip this step if you are not installing the 8182A Audio Processor and the 8182A/ST Studio Chassis.]

- A Set controls as shown in Fig. 2-11.

Since the LOUDNESS CONTROL switch is momentary, it will reset to its jumper-selected power-up setting after any interruption of AC power. Set it to OFF again, just to be sure.

- B Patch an audio oscillator into the L INPUT of the 8182A/ST Studio Chassis. Set the oscillator's frequency to 1kHz, and adjust its output level until the TOTAL MASTER G/R meter on the 8182A/ST Studio Chassis reads "0dB".

Be sure that no signal is fed to the R INPUT.

- C Adjust the 8182A/ST Studio Chassis' OUTPUT LEVEL controls. If you are driving land lines, a M/A-COM PAC-10 modulator, or an STL with a modulation meter, follow the instructions in the following paragraphs. Otherwise, follow the instructions in the box on page 2-22.

Land lines — USA-standard land lines are not pre-emphasized and require a nominal drive level of +8dBm. Turn the 8182A/ST Studio Chassis' OUTPUT LEVEL controls fully clockwise.

M/A-COM PAC-10/12 — Follow the instructions in the PAC-10 and PAC-12 manuals to change the pre-emphasis and de-emphasis from 75 μ s to flat. Turn the 8182A/ST Studio Chassis' OUTPUT LEVEL controls fully clockwise.

STL WITH METER — Adjust the 8182A/ST Studio Chassis' L OUTPUT LEVEL control until the modulation meter on the microwave STL transmitter reads 8dB below its nominal 100% modulation level (for STL subcarriers that are not pre-emphasized) or until it reads 12dB below its nominal 100% modulation level (for STL subcarrier with 50 μ s or 75 μ s pre-emphasis).

- D Adjust the 8182A Audio Processor's LEFT INPUT ATTENUATOR control until its VU meter reads "100" (0VU).

If the LEFT INPUT ATTENUATOR control will not adjust the meter to this level, you may need to restrap the input attenuation pads on Cards #3TX and #4TX. See the 8182A/ST Operating Manual for further information.

- E Disconnect the audio oscillator from the L INPUT of the 8182A/ST Studio Chassis and connect it to the R INPUT.

- F Adjust the oscillator's output level until the 8182A/ST Studio Chassis' TOTAL MASTER G/R meter reads "0dB".

- G Set the 8182A Audio Processor's VU meter selector to R COMPR OUT.

- H Adjust the 8182A/ST Studio Chassis' R OUTPUT LEVEL control and the 8182A Audio Processor's RIGHT INPUT ATTENUATION control as in steps 17-C and D, above.

- I Disconnect the oscillator.

8185A OPTIMOD-TV Stereo Generator:

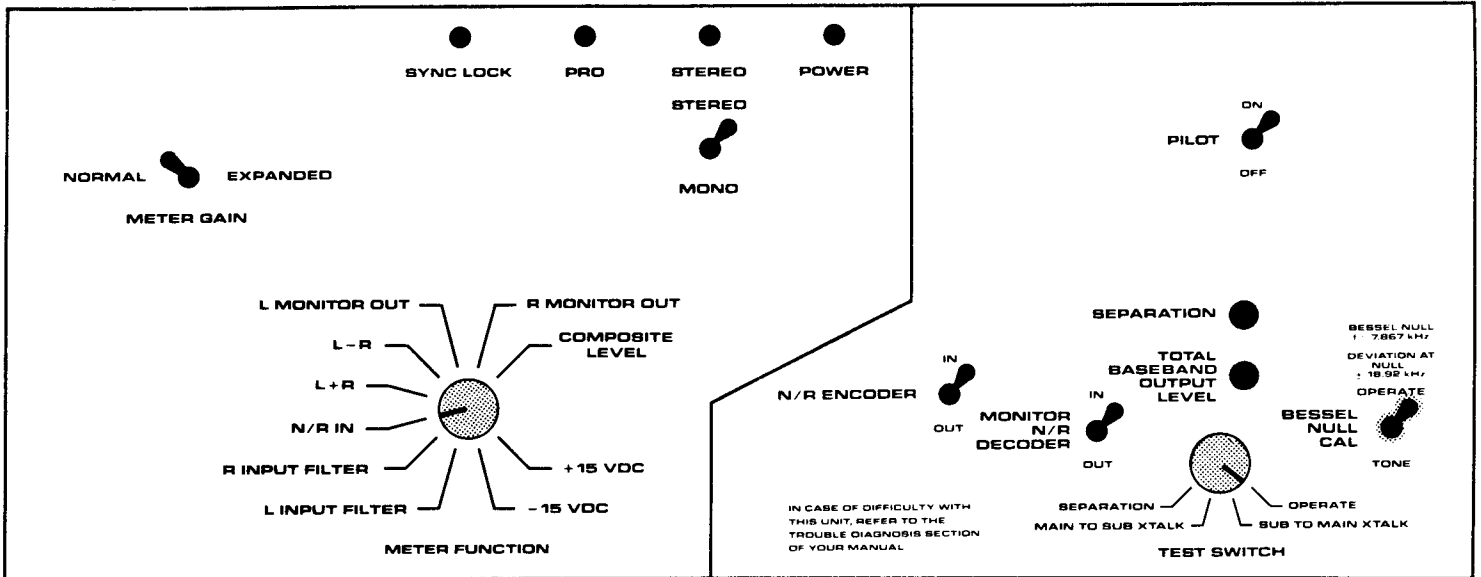

8182A OPTIMOD-TV Audio Processor:

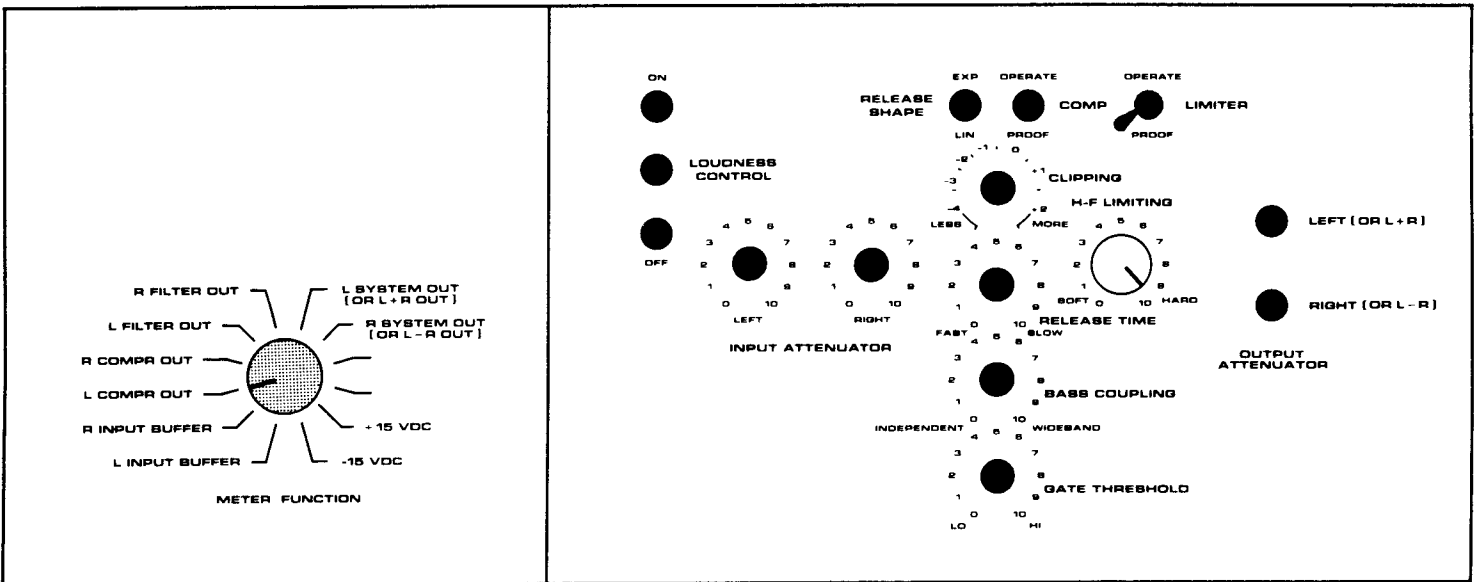

8182A/ST OPTIMOD-TV Studio Chassis:

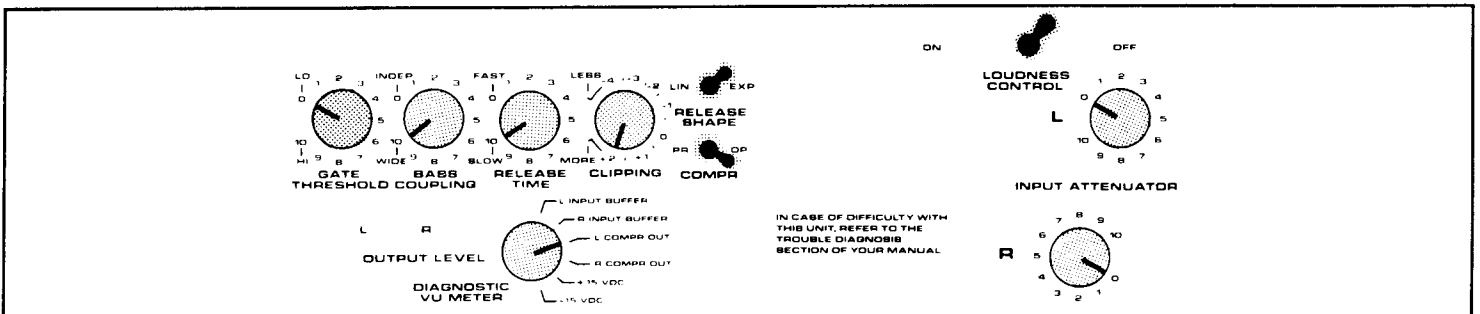

Only shaded controls are set differently than in the last control settings figure.

Fig. 2-11: Control Settings for Step 17

Adjusting Input Level for STLs Without Meters

If your STL is not a land line or M/A-COM PAC-10/12, and does not have a modulation meter, use the following procedure to adjust the 8182A/ST Studio Chassis' OUTPUT LEVEL controls, instead of those in step 17-C.

- 1) Feed wideband program audio into the L Input of the 8182A/ST Studio Chassis.
- 2) Adjust the 8182A/ST Studio Chassis' L INPUT ATTENUATOR control until the 8182A/ST Studio Chassis' TOTAL MASTER G/R meter reads "0dB".
- 3) Turn the 8182A Studio Chassis' OUTPUT LEVEL controls fully clockwise.
- 4) Connect an oscilloscope to the output of the STL subcarrier demodulator (at the transmitter).
- 5) Measure the clipping level (the level which the audio waveform peaks cannot exceed) in volts peak-to-peak.
- 6) Turn the 8182A/ST Studio Chassis' L OUTPUT LEVEL control until none of the audio waveform peaks observed on the oscilloscope exceed $\frac{1}{2}$ of the clipping level measured in step 5 on this page.

The 8182A/ST Studio Chassis' L OUTPUT LEVEL control is now set.

DO NOT CHANGE THIS SETTING.

- 7) Disconnect the program feed and connect an audio oscillator to the 8182A Studio Chassis' L Input. Set the oscillator's frequency to 1kHz.
- 8) Adjust the 8182A/ST Studio Chassis' L INPUT ATTENUATOR control until the 8182A/ST Studio Chassis' TOTAL MASTER G/R meter reads "0dB".
- 9) Measure the 8182A/ST Studio Chassis' left output level.
- 10) Connect an audio oscillator to the 8182A/ST Studio Chassis' R Input. Set the oscillator's frequency to 1kHz.
- 11) Adjust the 8182A/ST Studio Chassis' R INPUT ATTENUATOR control until the 8182A/ST Studio Chassis' TOTAL MASTER G/R meter reads "0dB".
- 12) Adjust the 8182A/ST Studio Chassis' R OUTPUT LEVEL control until the 8182A/ST Studio Chassis' right output level is the same as that measured for the left output in step 9 on this page.

19) Connect audio inputs and outputs.

A Connect the audio program lines to the audio processor's audio inputs.

In a *high RF radiation field*, run fully-balanced audio to the audio processor in 100% foil-shielded twisted-pair cable (e.g., Belden 8451). Connect the shield to chassis ground at the source; connect the shield through a 470pF disc capacitor with leads less than 1/4-inch long to the audio input chassis ground on the audio processor. In a *low RF radiation field*, run balanced audio in shielded cable with the shield connected to chassis ground at the *source end only*.

Right and left audio inputs *must be in phase*. Connect red and black wires within all shielded cables symmetrically and consistently.

8185A OPTIMOD-TV Stereo Generator:

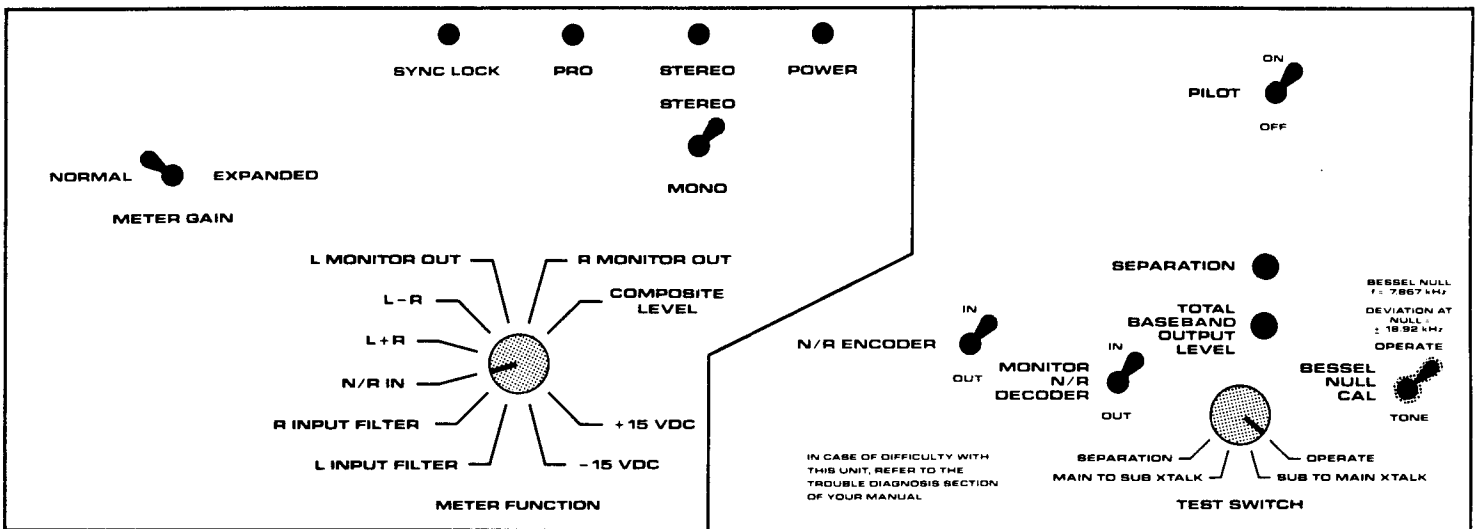

8182A OPTIMOD-TV Audio Processor:

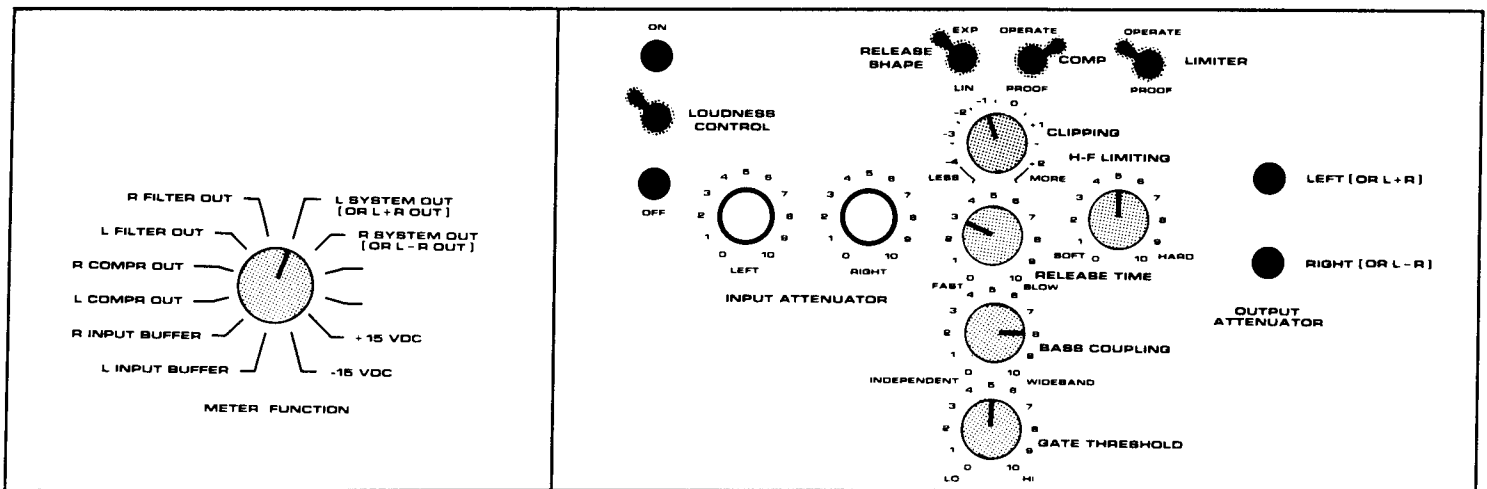

Only shaded controls are set differently than in the last control settings figure.

Fig. 2-12: Control Settings for Step 20 (normal operation)

20) Adjust input level with program material.

[Skip this step if you are using the optional 8182A/ST Studio Chassis.]

- A If you are using the 8182A Audio Processor, set its controls as shown in Fig. 2-12. If you are not using the 8182A Audio Processor, set your processor's controls for normal operation according to the manufacturer's instructions.
- B Set your switcher to mono, so both channels will put out identical signals and levels.
- C Drive the audio processor with typical audio at your usual operating level. Peak switcher output meters at 0VU.
- D Adjust the audio processor's left input level until its gain reduction meter indicates the normal operating level, according to the manufacturer's instructions. If you are using the 8182A Audio Processor, adjust its LEFT INPUT ATTENUATOR control until its TOTAL MASTER G/R meter reads approximately "0dB".

If the LEFT INPUT ATTENUATOR control will not adjust the meter to this level, you may need to restrap the input attenuation pads on Cards #3 and #4. See the 8182A Operating Manual for further information.
- E Adjust the audio processor's right input level until the 8185A Stereo Generator's VU meter nulls.
- F Set the 8185A Stereo Generator's METER GAIN switch to EXPANDED and fine-adjust the null.
- G Reset the METER GAIN switch to NORMAL.

21) Adjust input level with program material. (with Studio Chassis)

[Skip this step unless you are using the optional 8182A/ST Studio Chassis.]

- A Set the controls as shown in Fig. 2-13.
- B Set your switcher to mono, so both channels will put out identical signals and levels.
- C Drive the 8182A/ST Studio Chassis with typical audio at your usual operating level. Peak switcher output meters at 0VU.
- D Adjust the 8182A/ST Studio Chassis' LEFT INPUT ATTENUATOR control until its TOTAL MASTER G/R meter reads approximately "0dB".

If the LEFT INPUT ATTENUATOR control will not adjust the meter to this level, you may need to restrap the input attenuation pads on Cards #3 and #4. See the 8182A Operating Manual for further information.
- E Set the 8182A/ST Studio Chassis' DIAGNOSTIC VU METER switch to L COMPR OUT. Note the VU meter reading.
- F Set the 8182A/ST Studio Chassis' DIAGNOSTIC VU METER switch to R COMPR OUT, then adjust the 8182A/ST Studio Chassis' R INPUT ATTENUATOR control until the VU meter reads the same as noted in step e.

A more precise adjustment can be made if an operator is available to observe the 8185A Stereo Generator or if a BTSC stereo monitor is available at the studio:

- G Adjust the 8182A/ST Studio Chassis' RIGHT INPUT ATTENUATOR control until the 8185A Stereo Generator's VU meter nulls. Then set the 8185A Stereo Generator's METER GAIN switch to EXPANDED and fine-adjust the null. Set the METER GAIN switch back to NORMAL.

If a BTSC stereo monitor is available at the studio, its L-R metering can also be used to make the null.

22) Check modulation with stereo modulation monitor.

[Skip this step if you do not have access to a BTSC-compatible modulation monitor. Correct modulation cannot be verified with a mono modulation monitor.]

- A Drive the audio processor with typical audio at your usual operating level. Peak switcher output meters at 0VU.
- B With your switcher set to stereo, verify that modulation is correct ($\pm 5\%$) as shown on the total modulation meter on your stereo aural modulation monitor.

Note: The exacting filtering requirements specified by OET-60A for pilot protection inevitably result in overshoot and ringing. This means that your peak flasher may show considerable activity when the modulation level is properly adjusted. *This is to be expected and is no cause for alarm.* The EIA committee that produced the document *Multichannel Television Sound: BTSC System Recommended Practices* could not agree on the time-constant for the peak flasher on the modulation monitor. The FCC is aware of the problem. (As this is being written, the BTSC is working on standards for peak flasher dynamics that will permit the flashers to be used for accurate operational monitoring of modulation while ignoring overshoots inherent in the definition of the BTSC system. We expect that all BTSC monitors will eventually incorporate such standardized dynamic response, which will eliminate the problem described above.)

If you want to adjust modulation, use your audio processor's output level controls — DO NOT READJUST THE 8185A STEREO GENERATOR'S TOTAL BASEBAND OUTPUT LEVEL CONTROL! Because the 8185A Stereo Generator's VU meter indicates peaks with accuracy greater than $\pm 2.5\%$ when the VU meter selector is set to L or R INPUT FILTER, it can be used to accurately set modulation with either tone or program material. (See step 3 on page 2-2 for instruction for setting levels with program material.)

23) Verify audio quality of air sound.

Listen to the air sound on a good monitor system to verify that it sounds natural and free of noise and distortion.

24) Complete the Registration Card and return it to Orban (please).

The Registration Card enables us to inform you of new applications, performance improvements, and service aids which may be developed, and it helps us respond promptly to claims under warranty without having to request a copy of your bill of sale or other proof of purchase. Please fill in the Registration Card and send it to us today.

8185A OPTIMOD-TV Stereo Generator:

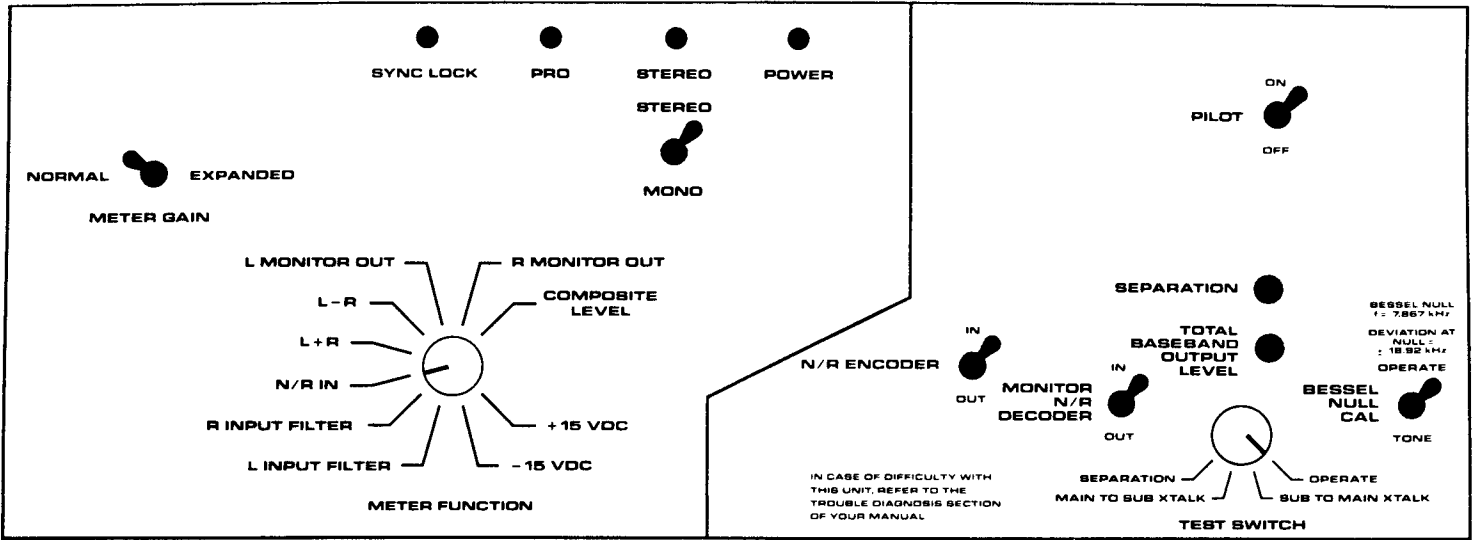

8182A OPTIMOD-TV Audio Processor:

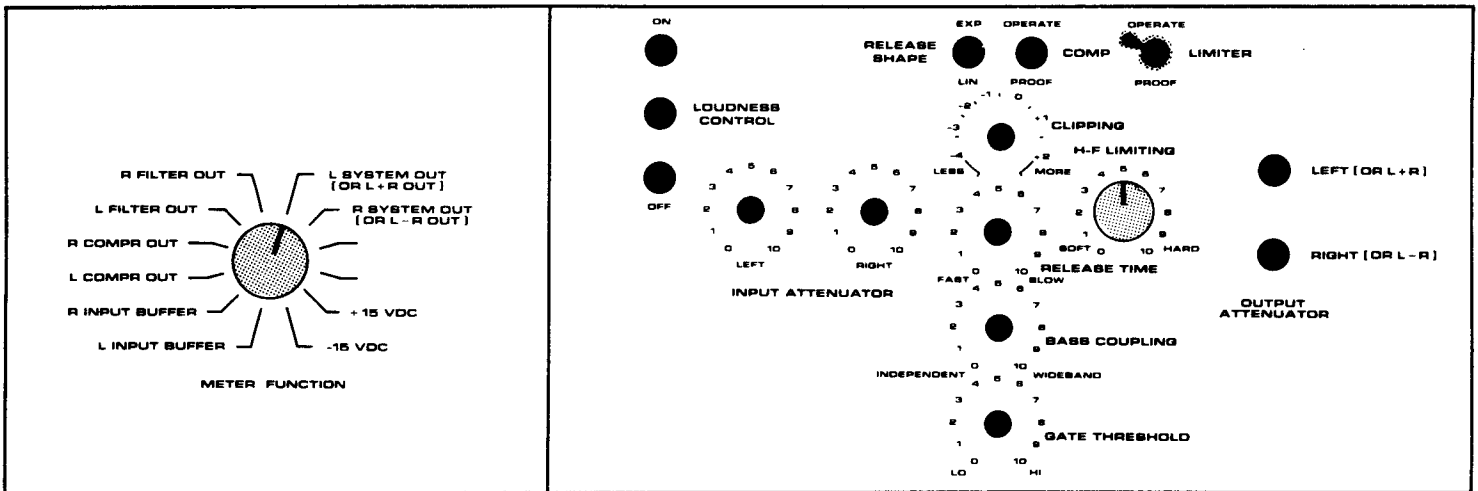

8182A/ST OPTIMOD-TV Studio Chassis:

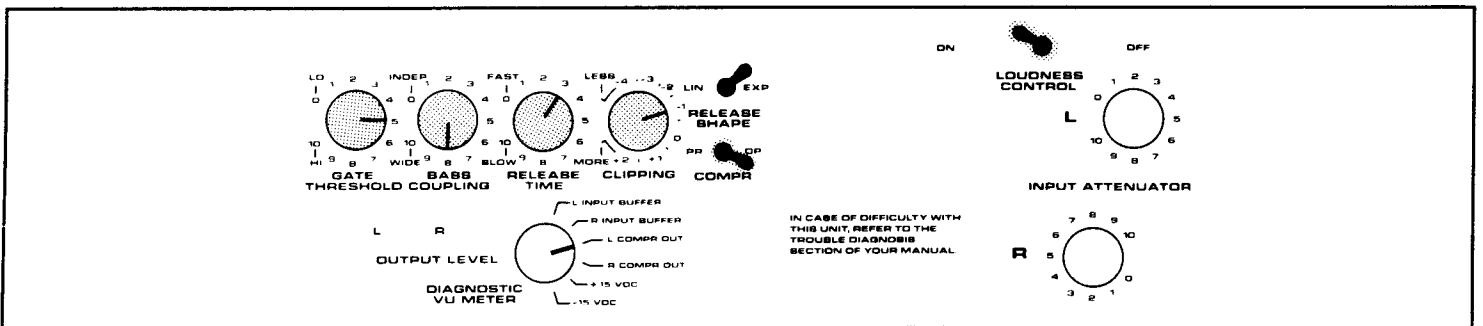

Only shaded controls are set differently than in the last control settings figure.

Fig. 2-13: Control Settings for Step 21 (normal operation)

That's it!

The 8185A OPTIMOD-TV Stereo Generator is matched to the exciter for best separation. It will not require frequent adjustment.

If you have also installed the 8182A OPTIMOD-TV Audio Processor, it is adjusted to our factory-recommended settings. We have found these settings result in excellent audio level control, without processing artifacts, for virtually all mono and stereo television programs.

Rewiring the 8128A Accessory Port

This procedure is *only* for 8182A OPTIMOD-TV Audio Processors with serial numbers below 780000.

Allow about 45 minutes for this procedure.

You will need a low-wattage soldering iron, rosin-core solder, a solder removal tool (spring-loaded suction type), and general tools. You will also need the following parts, which are supplied with each 8185A OPTIMOD-TV Stereo Generator, and as Retrofit Kit RET-035:

- 2 Jumpers, white
- 4 Wires, pre-cut and stripped
- 2 Lengths of tubing, $\frac{1}{16}$ -inch diameter

Fig. 2-15 supersedes the drawing in Appendix G of the 8182A Operating Manual (you may want to insert a copy of the new drawing in place of the old).

- 1) Disconnect the 8182A Audio Processor and remove it from the rack.
- 2) Remove the eight screws that attach the top cover to the rear panel of the 8182A Audio Processor. Also remove the eight screws that attach the bottom cover to the rear panel.
- 3) Set the unit on a padded surface with the rear panel facing you and the bottom cover down.

Leave about 6 inches (15cm) between the rear panel and the edge of the table. Be sure the AC power cord is unplugged.
- 4) Remove the three groups of three screws circled in black on the rear panel.
- 5) *Very carefully* pull the rear panel about $\frac{3}{4}$ -inch (2cm) toward you, and then tilt the top of the rear panel down until the rear panel is horizontal.

Careful! Watch for snags in the wiring or stress on the ceramic capacitors on the internal divider wall or RF box. These capacitors are very fragile and are difficult to replace.
- 6) Remove the jumper between solder forks E1 and E2 on the motherboard. Clear excess solder from the forks with the suction tool.

See Fig. 2-14 for solder fork locations. All E-series solder forks in this procedure are located on the 8182A Audio Processor's motherboard.
- 7) Remove the jumper between solder forks E3 and E4 on the motherboard. Clear excess solder from the forks with the suction tool.
- 8) Unsolder the white/blue wire and the violet wire connected to solder fork E21. Clear excess solder from the fork with the suction tool.

- 9) Solder the white/blue wire just disconnected from E21 to solder fork E2. (Leave room for another wire).
- 10) Solder the violet wire just disconnected from E21 to the motherboard solder point for pin W of the Card #7 connector.
Pin W is the fourth pin up from the bottom.
- 11) Unsolder the blue wire connected to solder fork E23. Clear excess solder from the fork with the suction tool.
- 12) Solder the blue wire just disconnected from E23 to solder fork E1.
- 13) Unsolder the gray wire connected to solder fork E25. Clear excess solder from the fork with the suction tool.
- 14) Solder the gray wire just disconnected from E25 to solder fork E3.
- 15) Unsolder the white/gray wire and the brown wire connected to solder fork E20. Clear excess solder from the fork with the suction tool.
- 16) Solder the white/gray wire just disconnected from E20 to solder fork E4.
- 17) Solder the brown wire just disconnected from E20 to solder fork E22.
- 18) Solder one end of the shorter of the two supplied jumpers to solder fork E21. Solder the other end to E23.
- 19) Solder one end of the longer supplied jumper to solder fork E20. Solder the other end to E25.
- 20) Unsolder and discard the wires connecting the rear-panel AUDIO TEST JACKS to the switch immediately below them.
Careful! Don't get any solder flux into the switch.
- 21) Solder one end of the supplied white/blue wire to solder fork E2.
- 22) Solder one end of the supplied white/gray wire to solder fork E4.
- 23) Twist the white/blue and white/gray wires together, then slip one of the supplied pieces of tubing over each of the wires.
- 24) Solder the other end of the supplied white/blue wire to pin 4 of ACCESSORY PORT # 1 connector J3 on the inside of the rear panel.
It may be convenient to "sweat" solder on the J3 connections: fill a solder cup with solder, let it cool, then re-heat it and place the supplied pre-tinned wire in the cup.
- 25) Solder the other end of the supplied white/gray wire to pin 6 of ACCESSORY PORT # 1 connector J3 on the inside of the rear panel.

- 26) Slip the tubing over the J3 connections.
- 27) Solder one end of the supplied yellow wire to solder fork E21.
- 28) Solder one end of the supplied red wire to solder fork E20.
- 29) Twist the yellow and red and wires together.
- 30) Solder the other end of the supplied yellow wire to L AUDIO JACK J1 on the inside of the rear panel.
- 31) Solder the other end of the supplied red wire to R AUDIO JACK J2 on the inside of the rear panel.
- 32) Check your work carefully against Fig. 2-15.

You can test your work by applying a 400Hz signal at about 1 volt to the left input. Set the COMP and LIMITER controls to PROOF, the NOISE REDUCTION switch on the rear panel to OUT, and the VU meter selector to L FILTER OUT. Turn the LEFT INPUT ATTENUATOR control and verify that the VU meter reading varies as you turn the control. Set the VU meter selector to L SYSTEM OUT and verify that there is a signal. Set the NOISE REDUCTION switch to IN, and the VU meter selector to L FILTER OUT. Verify no signal. Switch the signal from the left input to the right input, and repeat the tests on the right channel.

- 33) *Very carefully* tilt the rear panel up to the vertical position, and the push the rear panel forward into place.
Take care that no wires are pinched between the panel and the chassis.
- 34) Replace the 25 screws removed above.
Do not tighten any screws until all screws are loosely in place.
- 35) Re-label the rear-panel NOISE REDUCTION switch to indicate it is now the STEREO GENERATOR switch. Re-label the ACCESSORY PORT #1 as "TO STEREO GENERATOR".
- 36) Insert a copy of these rewire instructions in Appendix G of the 8182A Operating Manual.

The drawings on pages J-4, J-21, and J-25 of that manual will be partially incorrect as a result of this rewire. Make a note of those drawings to refer future readers to the copy of these instructions in Appendix G.

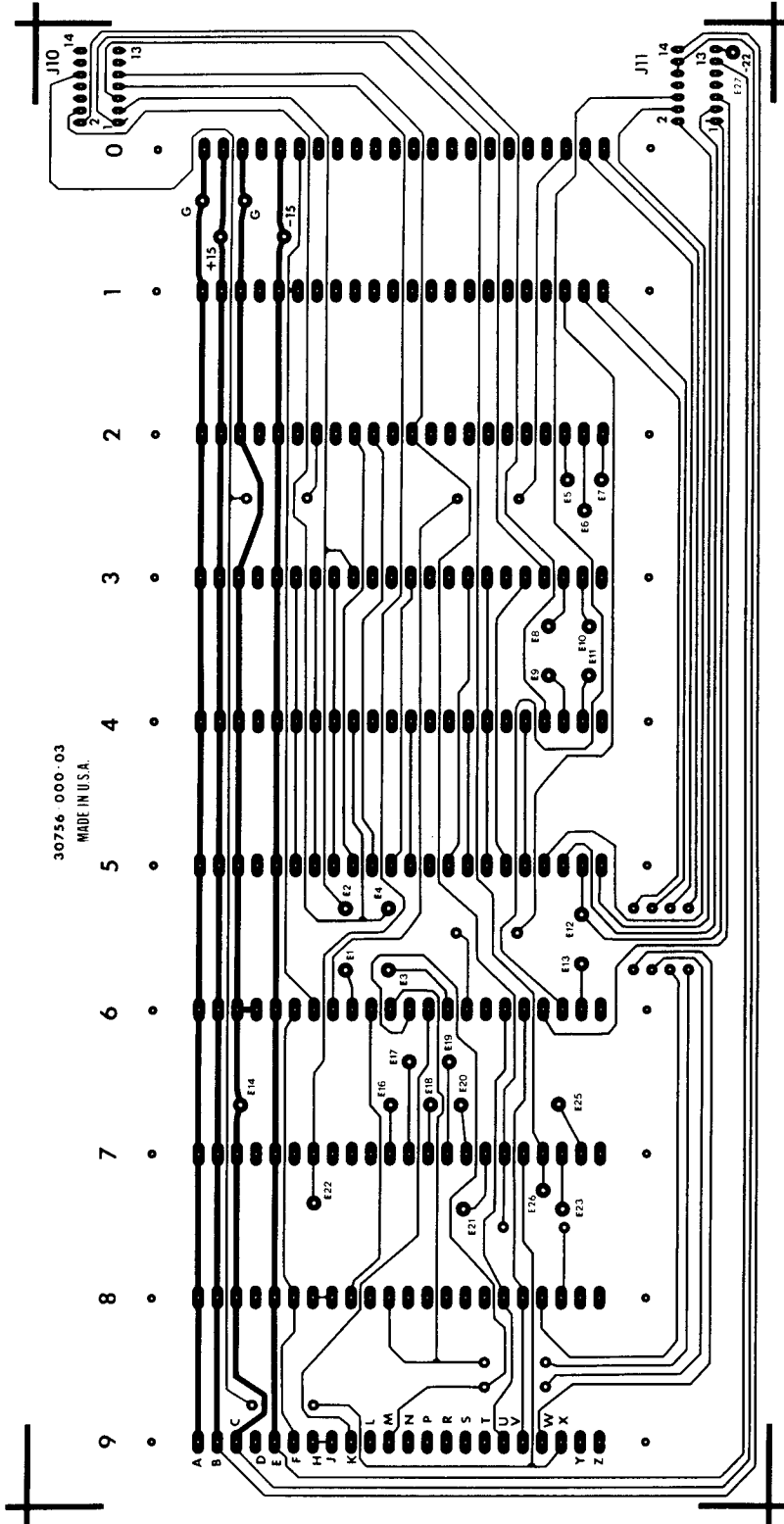
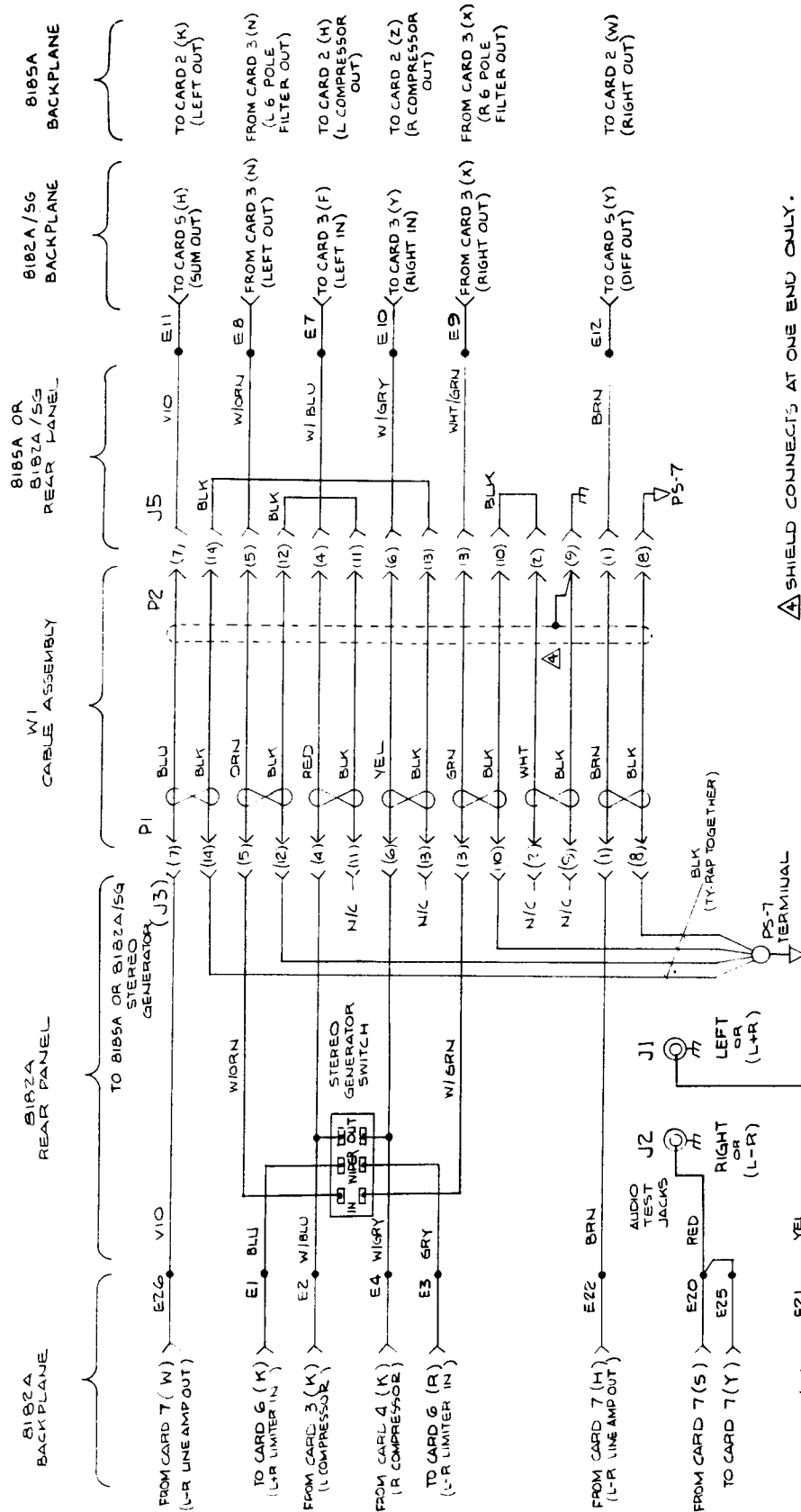

Fig. 2-14: Motherboard Solder Forks, 8182A Audio Processor



▲ SHIELD CONNECTS AT ONE END ONLY.
 3. CONNECTIONS ARE AMPHENOL 57-30140-40160.
 2. SUPERCEDES DWG 60126-000.
 1. WIRE TO BE B-24-14/36U.
 NOTES: (UNLESS OTHERWISE SPECIFIED)

Fig. 2-15: Accessory Port Wiring Diagram, 8182A Audio Processor