

# Section 2

# Installation

page	contents
2-3	<b>Installation of 8200</b>
2-2	Figure 2-1: 8200 Packaging
2-4	Figure 2-2: Opening the Unit
2-5	Figure 2-3: Stereo Encoder Jumpers (Card #2)
2-6	Figure 2-4: Input Termination Jumpers (Card #1)
2-7	Figure 2-5: Input Sensitivity Jumpers (Card #1)
2-8	Figure 2-6: 8200 Power Switch
2-9	Figure 2-7: Closing the Unit
2-13	Figure 2-8: AC Line Cord Wire Standard
2-14	Figure 2-9: Wiring the 25-pin Optically-isolated
2-15	Figure 2-10: Wiring the RS-232 and RS-422 Connectors
2-27	<b>Installation of Studio Level Controller</b>
2-29	Figure 2-11: 8200ST Jumpers
2-30	Figure 2-12: 464A Jumpers
2-35	Figure 2-13: 8100AST Jumpers
2-36	Figure 2-14: 4000 Jumpers
2-37	Figure 2-15: HF Limiter Jumpers
2-37	Figure 2-16: Pre-Emphasis EQ Jumpers
2-38	Figure 2-17: Pre-Emphasis Jumper
2-40	Figure 2-18: Stereo Coupling Jumpers
2-41	<b>System Setup Using QUICK SETUP</b>
2-55	<b>System Setup Using Individual Calibration Controls</b>
2-65	<b>Time and Date</b>
2-68	<b>Security and Pascode Programming</b>
2-74	<b>Remote Control Interface Programming</b>



### **CAUTION**

The installation and servicing instructions in this manual are for use by qualified personnel only. To avoid electric shock, do not perform any servicing other than that contained in the Operating Instructions unless you are qualified to do so. Refer all servicing to qualified service personnel.

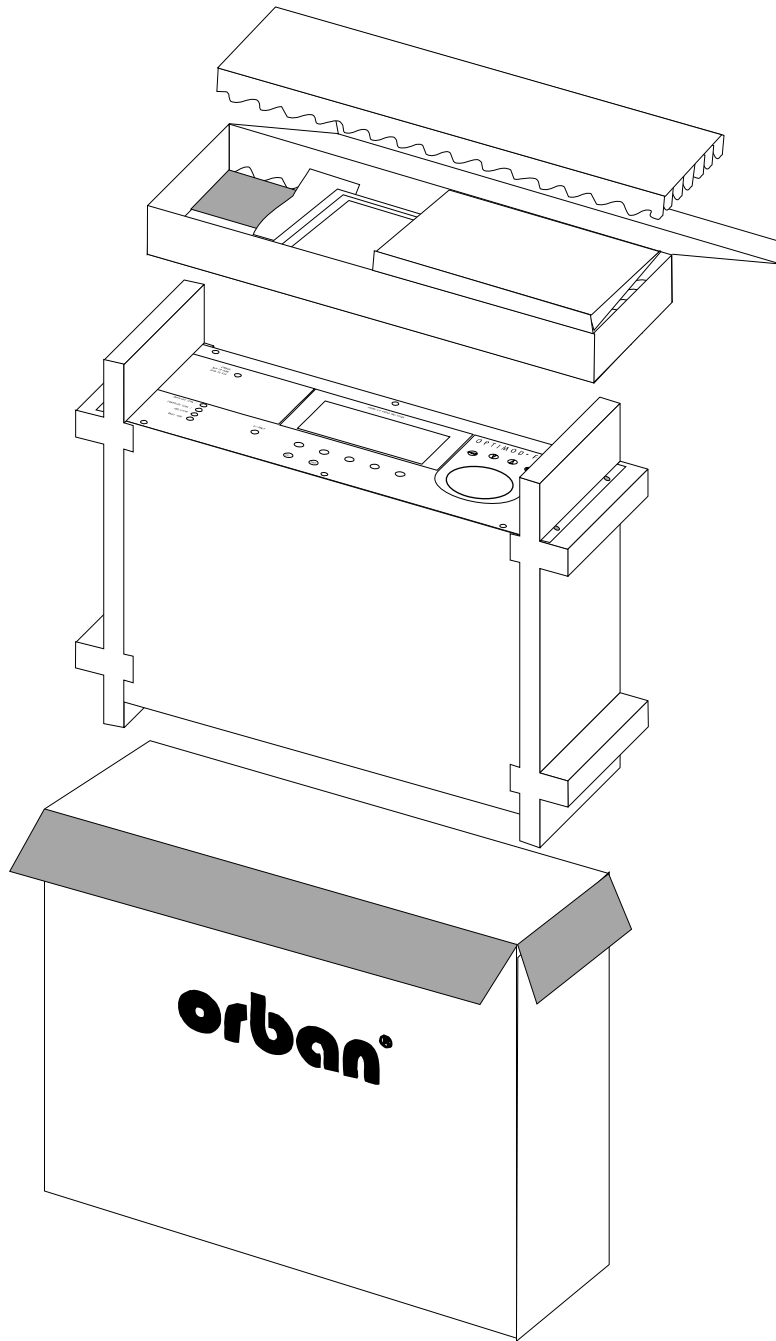

Figure 2-1: 8200 Packaging

## Installation of 8200

Allow about 2 hours for installation.

Installation consists of: (1) unpacking and inspecting the 8200, (2) optional resetting of jumpers for 8200 options (composite output impedance, input termination, input sensitivity), (3) checking the line voltage setting, fuses and power cord, (4) mounting the 8200 in a rack, (5) connecting inputs, outputs and power, (6) setting the GROUND LIFT switch, (7) optional connecting of remote control leads and (8) optional connecting of computer interface control leads.

When you have finished installing the 8200, proceed to "System Setup," on page 2-41.

### 1. Unpack and inspect. (includes resetting option jumpers)

If you note obvious physical damage, contact the carrier immediately to make a damage claim. Packed with the 8200 are:

1	Operating Manual
1	Line Cord
2	Fuses (F1 = 1/2A or 250mA F2 = 4A or 2A, depending upon specified mains voltage)
1	Extender Card
4	Rack-mounting screws, 10-32 x 1/2 — with washers, #10
1	Hex wrench — 1/8"
1	BNC Cable — 24" (60.96cm)
1	Orban green screwdriver (Xcelite R3323)
1	Booklet: <i>Audio Quality in the FM Plant</i>

**A** Save all packing materials! If you should ever have to ship the 8200 (e.g., for servicing), it is best to ship it in the original carton with its packing materials because both the carton and packing material have been carefully designed to protect the unit. Re-package the unit according to Fig 2-1.

**B** Complete the Registration Card and return it to Orban. (please)

The Registration Card enables us to inform you of new applications, performance improvements, and service aids that may be developed, and it helps us respond promptly to claims under warranty without our having to request a copy of your bill of sale or other proof of purchase. Please fill in the Registration Card and send it to us today. (The Registration Card is located after the cover page).

We do not sell our customer's names to anyone.

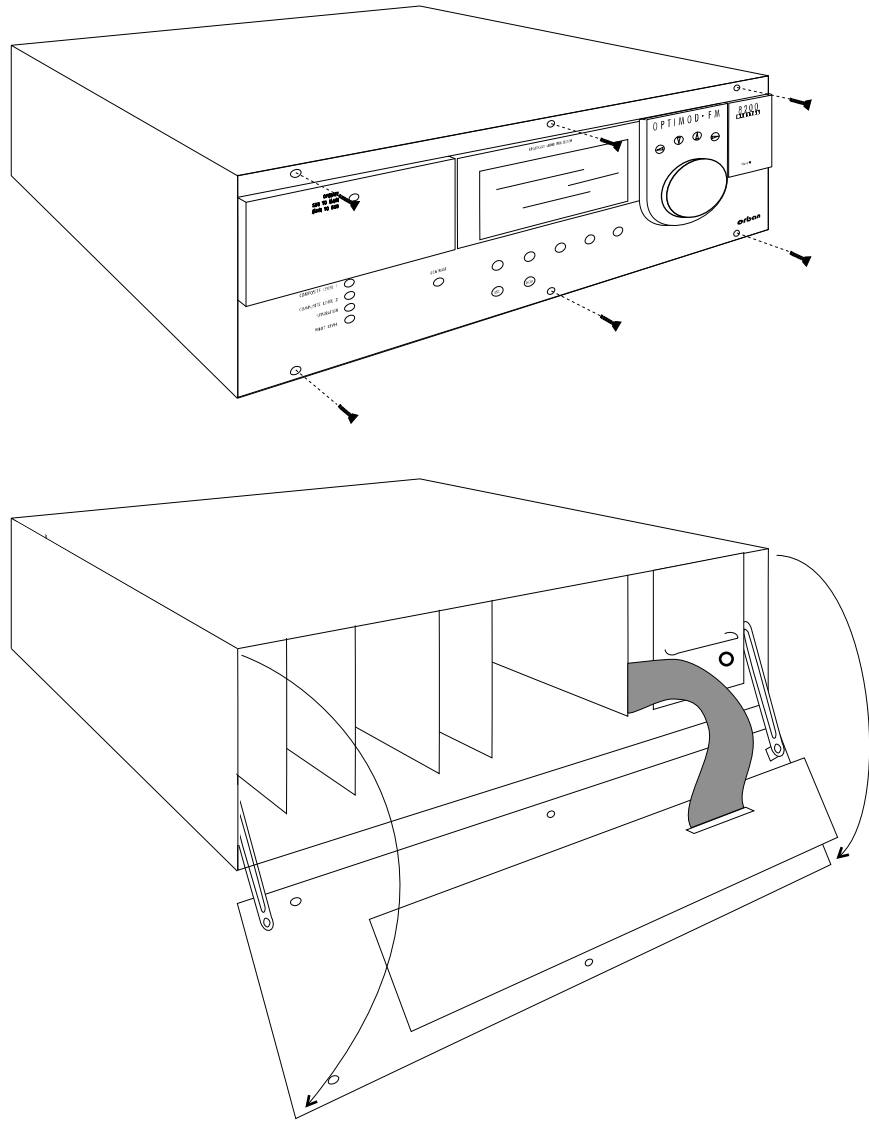

Figure 2-2: Opening the Unit

**2. Change standard factory configuration, if required.**

The 8200 is supplied from the factory with its jumpers set to the configuration correct for most installations.

*[Skip this step if your installation does not have any special requirements.]*

- A  Set stereo encoder composite output impedance.

*[Skip this step if your installation does not need 75Ω source impedance.]*

The stereo encoder is shipped from the factory with 0Ω source impedance. This is correct for virtually all installations. However, the 8200 stereo encoder can be changed to 75Ω source impedance if desired.

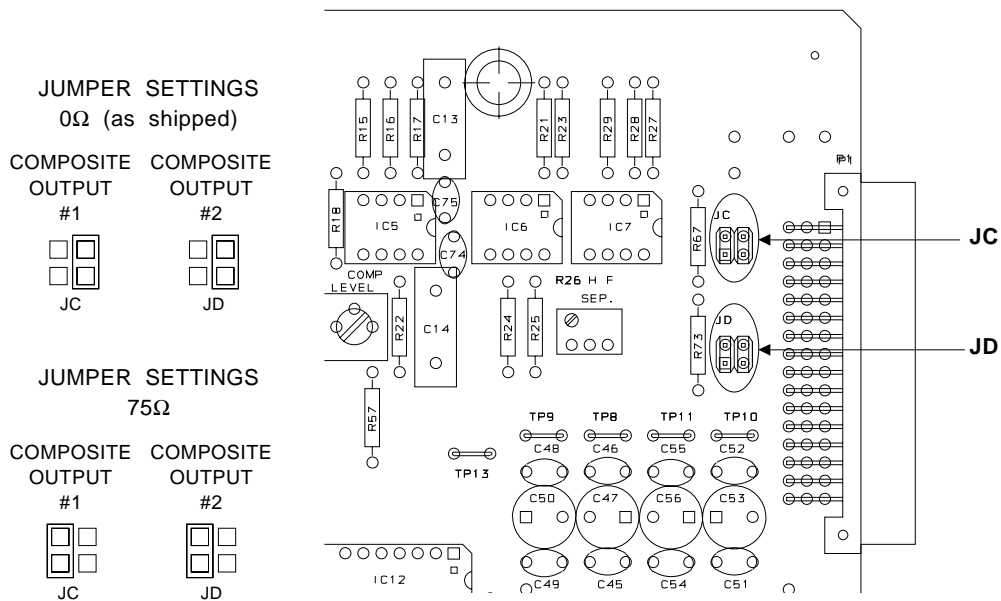

**Figure 2-3: Stereo Encoder Jumpers (Card #2)  
Jumpers JC and JD**

The frequencies in the stereo baseband are low by comparison to RF or video, and the characteristic impedance of coaxial cable is not 75Ω at lower frequencies, so the transmission system will have more accurate amplitude and phase response (and thus, better stereo separation) if the cable is driven by a very low source impedance (0Ω) and is terminated with greater than 1kΩ at the exciter.

However, a few broadcast organizations require that FM composite be transmitted in impedance-matched coaxial cable with 75Ω source and load impedances.

**To change the source impedance of one or both of the composite outputs:**

Make sure that power is off before removing or inserting circuit cards. Remove the stereo encoder board (the second card from the left) from the chassis.

To change the source impedance of composite output #1 (the upper BNC connector on the 8200's rear panel), move jumper JC to the "75Ω" position (Fig 2-3). To change the source impedance of composite output #2 (the lower BNC connector on the 8200's rear panel), move jumper JD to the "75Ω" position (Fig 2-3). Then replace the card and close the chassis.

- ▣ Set analog left/right input termination.

*[Skip this step if your installation does not require 600Ω termination on the analog left/right inputs.]*

The analog left/right inputs are shipped from the factory with balanced bridging (10kΩ) input impedance. However, the 8200 analog inputs can be changed to 600Ω input impedance.

**To change the input impedance of the analog left/right inputs:**

Make sure that power is off before removing or inserting circuit cards. Remove analog I/O board (the first card from the left) and move jumpers JA and JB according to Figure 2-4. Jumper JA sets the right channel and jumper JB sets the left channel.

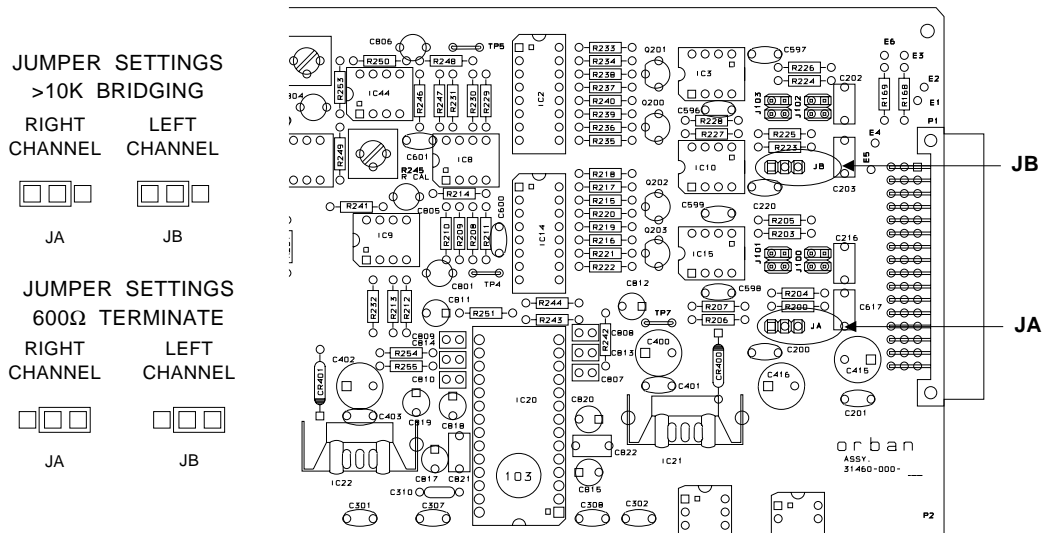
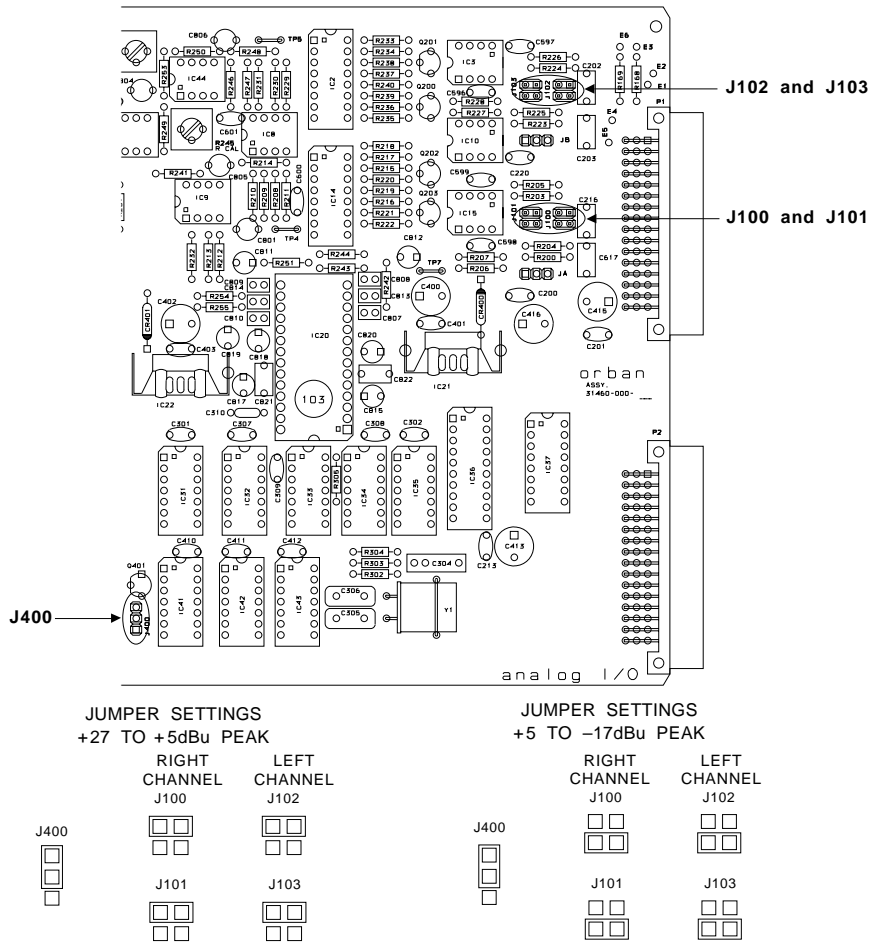
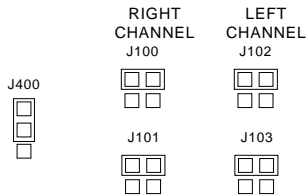

Figure 2-4: Input Termination Jumpers (Card #1)  
 Jumpers JA and JB



**JUMPER SETTINGS  
+27 TO +5dBu PEAK**



**JUMPER SETTINGS  
+5 TO -17dBu PEAK**

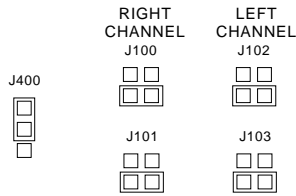

**Figure 2-5: Input Sensitivity Jumpers (Card #1)  
Jumpers J100, J101, J102, J103 and J400**

- c  Set analog left/right input sensitivity.

*[Skip this step if your installation will supply the 8200 with nominal input level of -10dBu or greater (+5dBu to +27dBu peak).]*

The analog left/right inputs are shipped from the factory with input sensitivity to accommodate inputs whose absolute maximum peak level is between +5dBu and +27dBu.

If VU meters are used, +5dBu to +27dBu absolute peak corresponds to a 0VU level of approximately -9dBu to +13dBu.

If PPMs are used, +5dBu to +27dBu absolute peak corresponds to a PPM level of approximately -2dBu to +20dBu.

However, in unusual circumstances where the input level is very low, the 8200 analog inputs can be changed for greater sensitivity. This usually occurs only when the studio-to-transmitter link is a long telephone or post

line with a passive equalizer at the receive end and no amplifier to make up the loss of the line and the equalizer.

**To increase the input sensitivity of the analog input to accommodate absolute peak levels of  $-17\text{dBu}$  to  $+5\text{dBu}$  (nominal levels down to  $-30\text{dBu}$ ):**

Make sure that power is off before removing or inserting circuit cards. Remove analog I/O board (the first card from the left) from its slot, and move jumpers J100, J101, J102, J103 and J400 according to Figure 2-5. Jumpers J100 and J101 set the right channel and jumpers J102 and J103 set the left channel. Jumper J400 sets the control board to recognize the new input sensitivity.

### 3. Close the front panel

- A  Verify that the power switch is set to ON (depressed).

The **AC POWER** switch is located on the power supply module to the right of the chassis. See Figure 2-6.

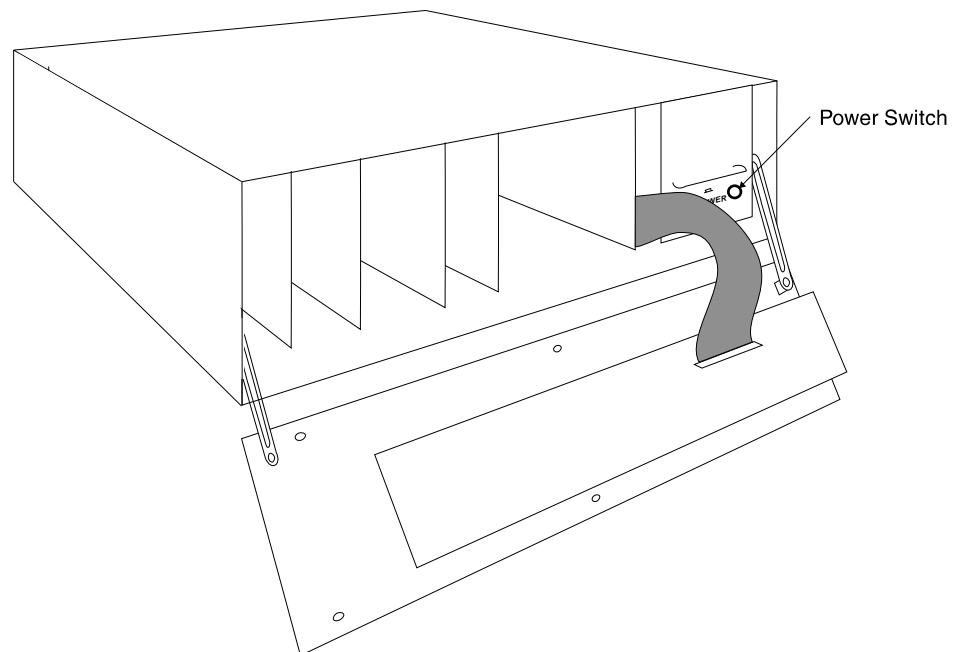

Figure 2-6: 8200 Power Switch

- B  To close the front panel, rotate the panel until it is vertical. Raise the panel while guiding it in on its supports.
- C  Fasten the six screws that secure the panel in place with a Phillips screwdriver.



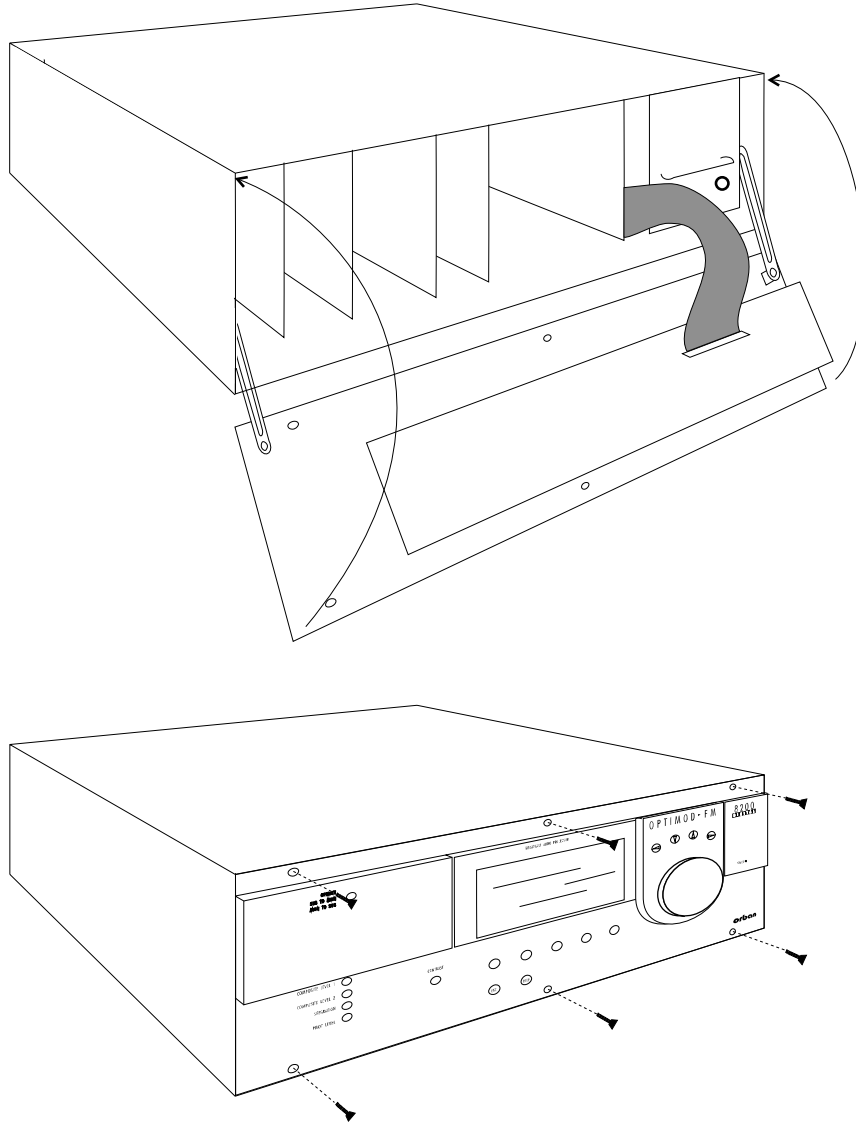
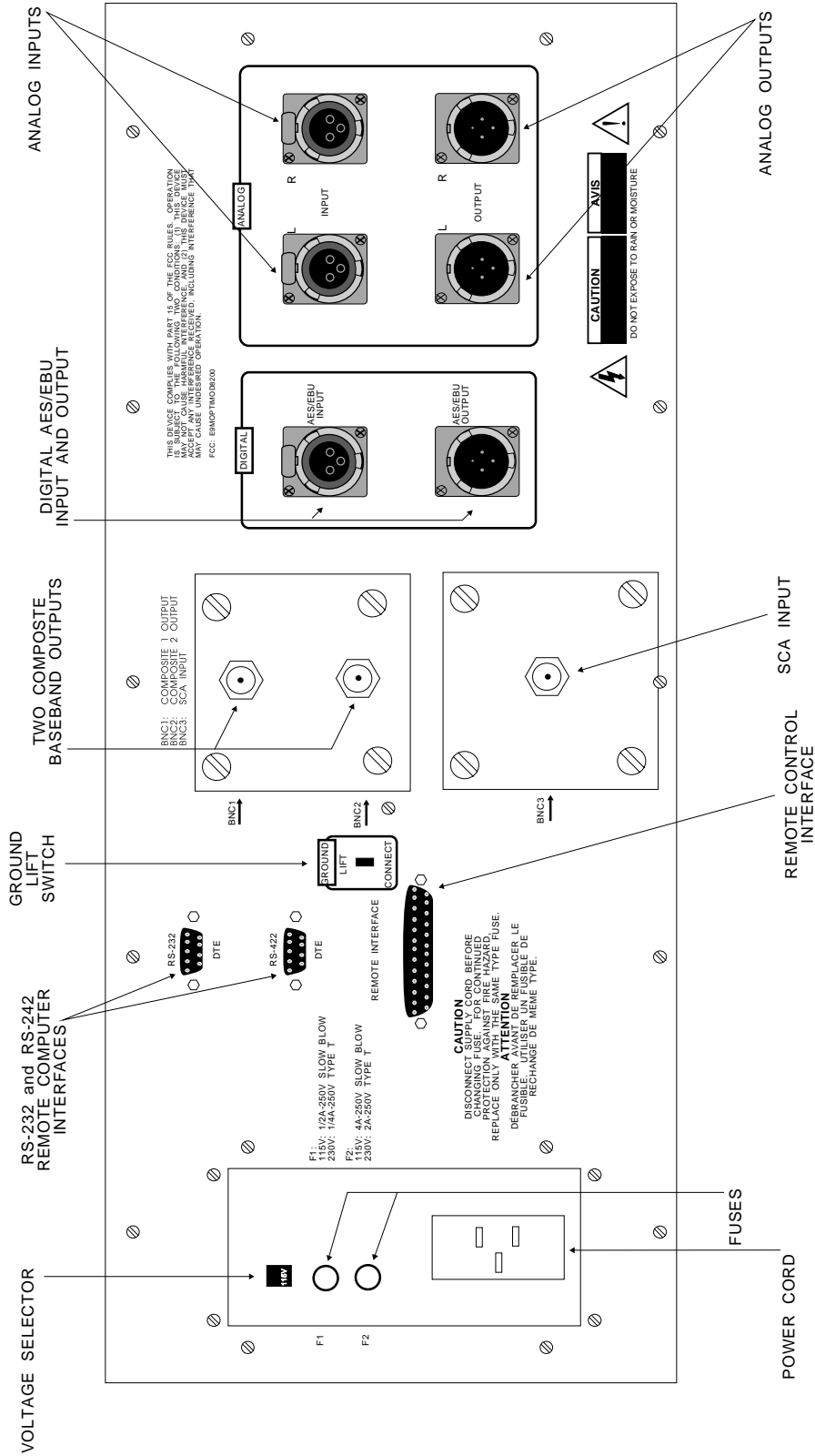

Figure 2-7: Closing the Unit



## 8200 Rear Panel

**Voltage Selector** can be set to 115V (for 90-130V operation) or 230V (for 180-260V operation).

**Fuse** values can be changed to support 115V or 230V operation. Fuse F1 must be 3AG Slow-Blow, 1/2-amp for 115V, or 1/4-amp (250mA) “T” type for 230V. Fuse F2 must be 3AG Slow-Blow, 4-amp for 115V, or 2-amp (250mA) “T” type for 230V.

**Power Cord** is detachable and is terminated in a “U-ground” plug (USA standard), or CEE7/7 plug (Continental Europe), as appropriate to your 8200’s Model Number.

**Ground Lift Switch** can be set to CONNECT (to connect the 8200’s circuit ground to its chassis), or to LIFT (if you are using the 8200’s stereo encoder, and are driving its composite output into an *unbalanced* exciter input).

**RS-232 and RS-422 Remote Computer Interfaces** are provided to connect the 8200 to IBM PC-compatible computers, directly or via modem, for remote control and metering. Both remote computer interfaces use DB-9 connectors.

**Remote Control Interface** is provided to connect the 8200 to your existing transmitter remote control. The 8200 remote control supports user-programmable selection of up to eight inputs for any one of the following parameters: user presets, factory presets, test presets, stereo, mono left, mono right, SC1 modulation compensation, SC2 modulation compensation, TX1 overshoot modulation compensation, TX2 overshoot modulation compensation, analog input, digital input, clock reset. The 8200 remote control accepts a DB-25 connector.

**Two Composite Baseband Outputs** are provided, each with independent OUTPUT level control. Each output uses a BNC connector.

**SCA Input** is provided for stations that use additional subcarriers (SCAs). The SCA input uses a BNC connector.

**Digital AES/EBU Input and Output** are provided to support two-channel AES/EBU-standard digital audio signals through XLR-type connectors.

**Analog Inputs and Outputs** are provided to support left and right audio signals through XLR-type connectors.



#### 4. Check the line voltage, fuse and power cord.

A  *DO NOT connect power to the unit yet!*

B  Check the VOLTAGE SELECTOR. This is on the rear panel.

The 8200 is shipped configured for either 90-130V or 200-250V, 50Hz or 60Hz operation, as indicated on the rear panel. Refer to the unit's rear panel for your Model Number and the inside of the front cover of this manual for your Model Number's line voltage setting. To change the operating voltage, set the VOLTAGE SELECTOR to 115V (for 90-130V) or 230V (for 200-250V) as appropriate.

c  Check the value of the fuse and change the fuse if the value is incorrect.

For safety, fuse F1 must be Slow-Blow, 1/2-amp for 115V, or 1/4-amp (250mA) "T" type for 230V. Fuse F2 must be Slow-Blow, 4-amp for 115V, or 2-amp "T" type for 230V.

d  Check power cord.

AC power passes through an IEC-standard mains connector and an RF filter designed to meet the standards of all international safety authorities.

The power cord is terminated in a "U-ground" plug (USA standard), or CEE7/7 plug (Continental Europe), as appropriate to your 8200's Model Number. The green/yellow wire is connected directly to the 8200 chassis.

If you need to change the plug to meet your country's standard and you are qualified to do so, see Figure 2-8. Otherwise, purchase a new mains cord with the correct line plug attached.

#### 5. Set GROUND LIFT switch.

The GROUND LIFT switch is located on the rear panel.

The GROUND LIFT switch is shipped from the factory set to CONNECT (to connect the 8200's circuit ground to its chassis ground). If you are using the 8200's stereo encoder, and are driving its composite output into an *unbalanced* exciter input, set the GROUND LIFT switch to LIFT.

This will break a ground loop that could otherwise occur.

Unbalanced exciter inputs can cause hum and noise because it is difficult to control the system grounding. If hum or noise appears that cannot be cured by resetting the GROUND LIFT switch, we suggest that you install the optional Orban CIT25 Composite Isolation Transformer at the exciter's input to balance it. If you use the CIT25, set the 8200's GROUND LIFT switch to CONNECT.

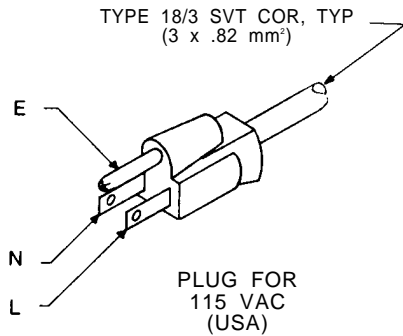

CONDUCTOR		WIRE COLOR	
		NORMAL	ALT
L	LINE	BROWN	BLACK
N	NEUTRAL	BLUE	WHITE
E	EARTH GND	GREEN-YELLOW	GREEN

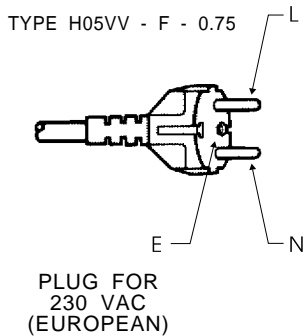

CONDUCTOR		WIRE COLOR
L	LINE	BROWN
N	NEUTRAL	BLUE
E	EARTH GND	GREEN-YELLOW

Figure 2-8: AC Line Cord Wire Standard

**6. Mount the 8200 in a rack.**

The 8200 requires four standard rack units (7 inches/17.6 cm).

Because the OPTIMOD-FM front panel opens down and out, do not mount your OPTIMOD-FM at the bottom of a rack or above equipment that projects out.

There should be a good ground connection between the rack and the 8200 chassis — check this with an ohmmeter to verify that the resistance is less than 0.5Ω.

Mounting the unit over large heat-producing devices (such as a vacuum-tube power amplifier) may shorten component life and is not recommended. Ambient temperature should not exceed 113°F/45°C when equipment is powered.

Equipment life will be extended if the unit is mounted away from sources of vibration, such as large blowers.

The shorter the baseband cable run from OPTIMOD-FM to exciter, the less likely that ground loops or other noise problems will occur in the installation. If you require a long

cable run, it is usually best to mount the RF exciter close to OPTIMOD-FM, and to make the long cable carry the RF output from the exciter to the transmitter's RF power amplifiers.

## 7. Connect remote control. (optional)

The 8200 has extensive remote control provisions, which are described on page 1-10.

Optically-isolated remote control connections are terminated in a type DB-25 female connector located on the rear panel. It is wired according to Fig. 2-9. To select the desired function, apply a 6-24V AC or DC pulse between the appropriate REMOTE terminals. The (-) terminals can be connected together and then connected to ground at pin 17 to create a REMOTE COMMON. If you use 48V, connect a 1K  $\pm$ 10%, 2-watt carbon composition resistor in series with the REMOTE COMMON or the (+) terminal to provide current limiting. A current-limited +12VDC source is available on pin 25.

In a high-RF environment, these wires should be short and should be run through foil-shielded cable, with the shield connected to CHASSIS GROUND at both ends.

PIN	ASSIGNMENT
1.	REMOTE 1+
2.	REMOTE 1-
3.	REMOTE 2+
4.	REMOTE 2-
5.	REMOTE 3+
6.	REMOTE 3-
7.	REMOTE 4+
8.	REMOTE 4-
9.	REMOTE 5+
10.	REMOTE 5-
11.	REMOTE 6+
12.	REMOTE 6-
13.	REMOTE 7+
14.	REMOTE 7-
15.	REMOTE 8+
16.	REMOTE 8-
17.	GROUND (↓)
18.	PILOT REFERENCE
19-23.	N/C
24.	CHASSIS GROUND (+)
25.	+12VDC

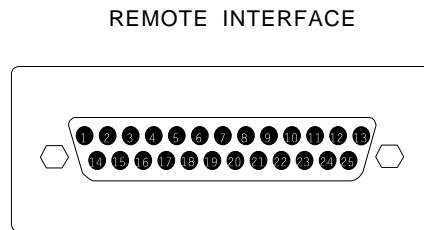

Figure 2-9: Wiring the 25-pin Optically-isolated Remote Control Connector

## 8. Connect computer interface. (optional)

The RS-232 and RS-422 serial connectors can be simultaneously active. They are wired according to Fig. 2-10.

In a high-RF environment, these wires should be short and should be run through foil-shielded cable, with the shield connected to CHASSIS GROUND at both ends.

(Most competently-designed serial cables are already well-shielded to prevent the cable from radiating EMI to the environment.)

### PIN ASSIGNMENT

1. N/C
2. RECEIVE DATA
3. TRANSMIT DATA
4. DATA TERMINAL READY
5. SIGNAL GROUND (↓)
6. DATA SET READY
7. REQUEST TO SEND
8. CLEAR TO SEND
9. N/C

### RS-232

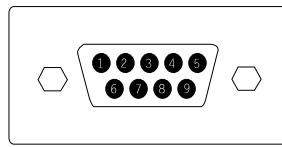

### PIN ASSIGNMENT

1. } DATA SET READY
2. }
3. CHASSIS GROUND (≠)
4. } RECEIVE DATA
5. }
6. } DATA TERMINAL READY
7. }
8. } TRANSMIT DATA
9. }

### RS-422

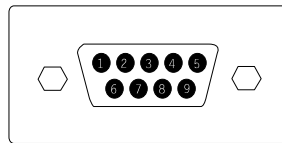

Figure 2-10: Wiring the RS-232 and RS-422 Connectors

## 9. Connect inputs and outputs.

See the hook-up and grounding information on the following pages.

Audio Input and Audio Output Connections	Page 2-16
SCA Input and Composite Output	Page 2-18
AES/EBU Digital Input and Output	Page 2-19
Grounding	Page 2-19

## Audio Input and Output Connections

### Cable

We recommend using **two-conductor foil-shielded cable** (such as Belden 8451 or equivalent), because signal current flows through the two conductors only. The shield does not carry signal, and is used only for shielding.

### Connectors

- **Input and output connectors** are XLR-type connectors.

In the XLR-type connectors, pin 1 is CHASSIS GROUND, while pin 2 and pin 3 are a balanced, floating pair. This wiring scheme is compatible with *any* studio wiring standard: If one pin is considered LOW, the other pin is automatically HIGH.

### Analog Audio Input

- **Nominal input level** between  $-30\text{dBu}$  and  $+8\text{dBu}$  will result in normal operation of the 8200. (See step 2-C on page 2-7 for a full discussion).  
( $0\text{dBu} = 0.775\text{Vrms}$ . For this application, the  $\text{dBm} @ 600\Omega$  scale on voltmeters can be read as if it were calibrated in  $\text{dBu}$ .)
- The **peak input level that causes overload** is dependent on the setting of the A-I CLIP LEVEL control. It is adjustable from  $-17\text{dBu}$  and  $+27\text{dBu}$  in two ranges.
- The **electronically-balanced input** uses an ultra low noise and distortion differential amplifier for best common mode rejection, and is compatible with most professional and semi-professional audio equipment, balanced or unbalanced, having a source impedance of  $600\Omega$  or less. The input is EMI suppressed.
- Input connections are the same whether the driving source is balanced or unbalanced.
- Connect the red (or white) wire to the pin on the XLR-type connector (#2 or #3) that is considered HIGH by the standards of your organization. Connect the black wire to the pin on the XLR-type connector (#3 or #2) that is considered LOW by the standards of your organization.



## Audio Input and Output Connections (continued)

- In **low RF fields** (like a studio site), do not connect the cable shield at the 8200 input — it should be connected at the source end only. In **high RF fields** (like a transmitter site), also connect the shield to pin 1 of the male XLR-type connector at the 8200 input.
- If the output of the driving unit is unbalanced and does not have separate CHASSIS GROUND and (–) (or LO) output terminals, connect both the shield and the black wire to the common (–) or ground terminal of the driving unit.

## Analog Audio Output

- **Electronically-balanced and floating outputs** simulate a true transformer output. The *source* impedance is  $30\Omega$ . The output is capable of driving loads of  $600\Omega$  or higher; maximum output level is  $>+23\text{dBu}$  into a balanced load and  $>+20\text{dBu}$  into an unbalanced load. The outputs are EMI suppressed.
- If an **unbalanced output** is required (to drive unbalanced inputs of other equipment), it should be taken between pin 2 and pin 3 of the XLR-type connector. Connect the LOW pin of the XLR-type connector (#3 or #2, depending on your organization's standards) to circuit ground, and take the HIGH output from the remaining pin. No special precautions are required even though one side of the output is grounded.
- Use two-conductor foil-shielded cable (Belden 8451, or equivalent).
- At the 8200's output (and at the output of other equipment in the system), connect the cable's shield to the CHASSIS GROUND terminal (pin 1) on the XLR-type connector. Connect the red (or white) wire to the pin on the XLR-type connector (#2 or #3) that is considered HIGH by the standards of your organization. Connect the black wire to the pin on the XLR-type connector (#3 or #2) that is considered LOW by the standards of your organization.

## Composite Output and Subcarrier Input

If the stereo encoder is fitted, the three BNC connectors on the rear panel are active.

- There are two independent composite baseband outputs (containing the encoded stereo signal, the stereo pilot tone, and any subcarrier that may have been applied to the subcarrier input).

Each output has an independent OUTPUT LEVEL control and can be strapped for  $0\Omega$  or  $75\Omega$  source impedance. Each output can drive up to 8V peak-to-peak into  $75\Omega$  in parallel with up to  $0.047\mu\text{F}$  in cable and input capacitance before any noticeable performance degradation occurs.

- Connect the 8200's composite output to the exciter input with up to 100 feet (30.5m) of RG-58/U or RG-59/U coaxial cable terminated with BNC connectors.

Longer runs of coax may increase problems with noise, hum, and RF pickup at the exciter. In general, the least troublesome installations place the 8200 close to the exciter and limit the length of the composite cable to less than 6 feet (1.8m).

We do not recommend that the exciter input be terminated by  $50\Omega$  or  $75\Omega$  unless this is unavoidable. Because the frequencies in the stereo baseband are low by comparison to RF or video, and because the characteristic impedance of coaxial cable is not constant at very low frequencies, the transmission system tends to have more accurate amplitude and phase response (and thus, better stereo separation) if the coax is driven by a very low impedance source and is terminated with greater than  $1\text{k}\Omega$  at the exciter end. This also eases thermal stresses on the output amplifier in the stereo encoder, and can thus increase equipment life.

If the Orban CIT25 Composite Isolation Transformer is used, the exciter *must* present a  $1\text{k}\Omega$  or greater load to the transformer for proper transformer operation.

Designed to be installed adjacent to each exciter, the CIT25 Composite Isolation Transformer provides ground loop isolation between the OPTIMOD-FM composite output and the exciter's input, and presents OPTIMOD-FM with a balanced floating load.

- The **subcarrier input** is provided for convenience in summing subcarriers into the baseband prior to its presentation to the FM RF exciter.

The subcarrier input will accept any subcarrier (or combination of subcarriers) above 23kHz. Below 20kHz, its sensitivity rolls off at 6dB/octave to suppress hum that might otherwise be introduced into the subcarrier input, which is unbalanced.

- Connect the subcarrier generator to the 8200's subcarrier input with coaxial cable terminated with BNC connectors. Any  $50\Omega$  or  $75\Omega$  coaxial cable will do as long as it can accommodate BNC connectors.

The subcarrier input is  $600\Omega$  impedance and unbalanced. The gain is scaled so that 1.5V peak at the subcarrier input produces 10% subcarrier injection with reference to 100% deviation of the FM carrier.

## AES/EBU Digital Input and Output

If the optional AES/EBU Digital I/O Card is fitted, the AES/EBU digital input and output are active. These follow the AES/EBU standard.

Per the AES/EBU standard, each digital input or output line carries both the left and right stereo channels.

The digital input clip level is fixed at 0dB relative to the maximum digital word. If the 8200 input meters are set to monitor clip levels, the maximum digital input will make the meters display 0dB. The reference level is adjustable using the D-I REF LEVEL control. If the 8200 input meters are set to monitor reference levels, a digital input at the reference level will make the meters display 0dB.

## Grounding

Very often, grounding is approached in a “hit or miss” manner. But with care it is possible to wire an audio studio so that it provides maximum protection from power faults and is free from ground loops (which induce hum and can cause oscillation).

In an ideal system:

- All units in the system should have *balanced inputs*. In a modern system with low output impedances and high input impedances, a balanced input will provide common-mode rejection and prevent ground loops — regardless of whether it is driven from a balanced or unbalanced source.

The 8200 has balanced inputs. Its optional subcarrier input is unbalanced, but its frequency response is rolled-off at low frequencies to reject hum.

- All equipment *circuit grounds* must be connected to each other; all equipment *chassis grounds* must be connected together.
- In a low RF field, *cable shields* should be connected at one end only — preferably the source (output) end.
- In a high RF field, *audio cable shields* should be connected to a solid earth ground at both ends to achieve best shielding against RFI.
- Whenever coaxial cable is used, shields are automatically grounded at both ends through the terminating BNC connectors.



## Grounding (continued)

### Power Ground

- Ground the 8200 chassis through the third wire in the power cord. Proper grounding techniques *never* leave equipment chassis unconnected to power/earth ground. *A proper power ground is essential to safe operation.* Lifting a chassis from power ground creates a potential safety hazard.

### Circuit Ground

To maintain the same potential in all equipment, the circuit (audio) grounds must be connected together:

- Circuit and chassis ground should always be connected by setting the 8200's GROUND LIFT switch to CONNECT, *except* when the 8200's optional stereo encoder composite output is driving an **unbalanced exciter input**. This is an unbalanced-to-unbalanced connection, so the ground loop that would otherwise occur must be broken by setting the 8200's GROUND LIFT switch to LIFT.

Alternately, you can balance and float the exciter input with the Orban CIT25 Composite Isolation Transformer — (see page 1-13).

- *In high RF fields*, the system is usually grounded through the equipment rack in which the 8200 is mounted. The rack should be connected to a solid earth ground by a wide copper strap — wire is completely ineffective at VHF because of the wire's self-inductance.

## Detailed Exciter Interface Instructions

**Most exciters have straightforward wideband inputs, and no special considerations are involved.** This section provides instructions on interfacing OPTIMOD-FM to certain exciters requiring special wideband interfaces.

### Collins 310Z-1(B)

Prior to installing the required Continental Electronics 785-1 Wideband Interface Card, this exciter must be modified using a kit of parts and instructions provided by Continental. Once this modification has been performed, proceed as in the case of the Continental 510R-1 (immediately below).

### Continental 510R-1 (Collins 310Z-2)

- Obtain a 785E-1 Interface Card directly from Continental Electronics.
- Remove the 53kHz phase-linear baseband filter (FL-1), Continental Part # 673-1162-020. The filter is located on the opposite side of the chassis under the protective grill in the rear of the exciter. To access this filter, first remove the entire rear grill of the exciter. Next, the circuit board that covers the screws that secure the filter in its socket must be removed. The filter is plugged into an octal socket and can be readily unplugged once its hold-down screws are removed.

Despite the inconvenience, it is **IMPERATIVE** that this filter be removed as it shunts the baseband input to the FM modulator and its continued presence would seriously degrade separation.

- Replace the hardware and grill.
- Install the 785E-1 Interface Card in its designated slot in the card cage.
- Be certain that the Interface Card is not being overloaded by OPTIMOD-FM. This can happen easily if the B/B LEVEL control on the modulator card of the Continental exciter is set excessively low and the OPTIMOD-FM output level is increased to make up the gain. The problem may not be immediately noticeable under test conditions, but will seriously degrade the normal operation of the system.

To avoid this condition, do not change the adjustment of the B/B LEVEL control from the setting appropriate for use with the Continental stereo generator. If there is any reason to suspect that this control has been misadjusted, it is worthwhile to check the input sensitivity. The B/B LEVEL control is correctly adjusted when a sinewave of 1.24V<sub>rms</sub> (3.5V<sub>p-p</sub>) applied to the Continental Wideband Input produces 100% modulation at any frequency.

## Detailed Exciter Interface Instructions (continued)

### RCA BTE-15

- If your exciter is not equipped with an RCA “Monaural Audio Module” (RCA P/N MI-561072), then order Orban Accessory RCA-1 (Orban P/N 05004-000) directly from Orban.
- Install OPTIMOD-FM directly above the exciter, allowing at least  $1\frac{3}{4}$ ” (1 rack unit) of air space between the units. You may want to switch the OPTIMOD-FM’s LINE VOLTAGE selector to “230V” so that it can be operated from the same 230 volt circuit that ordinarily powers the exciter. If you do this, be sure to change the fuses.
- Using the BNC/BNC cable provided with your OPTIMOD-FM, connect the OPTIMOD-FM baseband output to the WIDEBAND BNC connector (J108) on the right rear apron of the exciter mainframe. The WIDEBAND input is the second BNC connector from the top. Be careful not to connect to the TELEMETRY input.
- Remove the RCA BTS-1B stereo generator from the BTE-15 mainframe. If the RCA “Monaural Audio Module” is available, install it in place of the RCA stereo generator. S201, which is located on the Monaural Audio Module circuit board, must be in the EXTERNAL position.

If the “Monaural Audio Module” is not available, install the “RCA Jumper Plug” (RCA-1) in the jack vacated by the RCA stereo generator.

- If any of the following conditions are noted after installing OPTIMOD-FM, your BTE-15 probably has a defective varactor diode:

The peak modulation level, as indicated on your modulation monitor peak flasher, seems to vary several percent with transmitter room temperature.

Modulation is asymmetric.

OPTIMOD-FM cannot supply enough level to modulate the exciter to 100%.

Any of these conditions should make you suspect RCA modulated oscillator diodes CR2 and/or CR3. Replacement of these diodes and realignment of the modulator is critical, and should probably be left to personnel experienced in servicing this exciter.

## Detailed Exciter Interface Instructions (continued)

### Gates (Harris) TE-1 and TE-3

- If you do not have a Gates (Harris) Wideband Interface Kit (P/N 994 6672 001), order the Orban ATE-3F Interface Kit (P/N 04014-000-00) directly from Orban.
- Both the Gates (Harris) and Orban interface kits contain complete instructions for installation. Bear in mind that the Gates (Harris) interface provides a balanced input. This means that the OPTIMOD-FM circuit and chassis grounds will ordinarily be connected. The Orban interface provides an unbalanced input, and the OPTIMOD-FM circuit and chassis grounds will ordinarily be connected. See page 2-20.

### 10. Power up the 8200.

- Plug in the 8200's power cord.

The green power light on the lower right of the panel should light.

The IDLE screen appears in the front window display.

**IMPORTANT NOTE:** If you have a 2S version of the 8200, the screen below will be replaced with a 2-Band screen. The 2-Band screen replaces the 5 limiting band meters with Bass, Master and two HF Limiting meters.

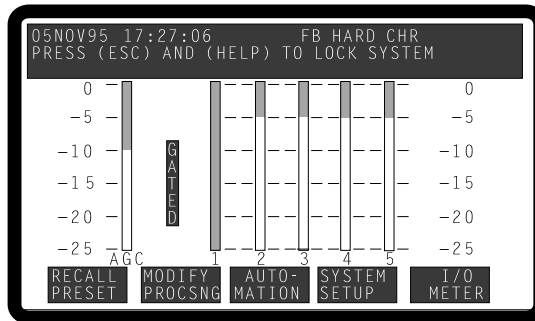

The IDLE screen is the “home” screen. It shows the gain reduction of the processing. The buttons located below the screen, as labeled on the bottom of the screen, provide access to all of the 8200's functions.

If the IDLE screen does not appear, repeatedly press ESC until it does appear.

### 11. Physical installation is complete.

- Continue with the explanation of the 8200 Controls and Meters, and then SYSTEM SETUP (initialization) on page 2-41.

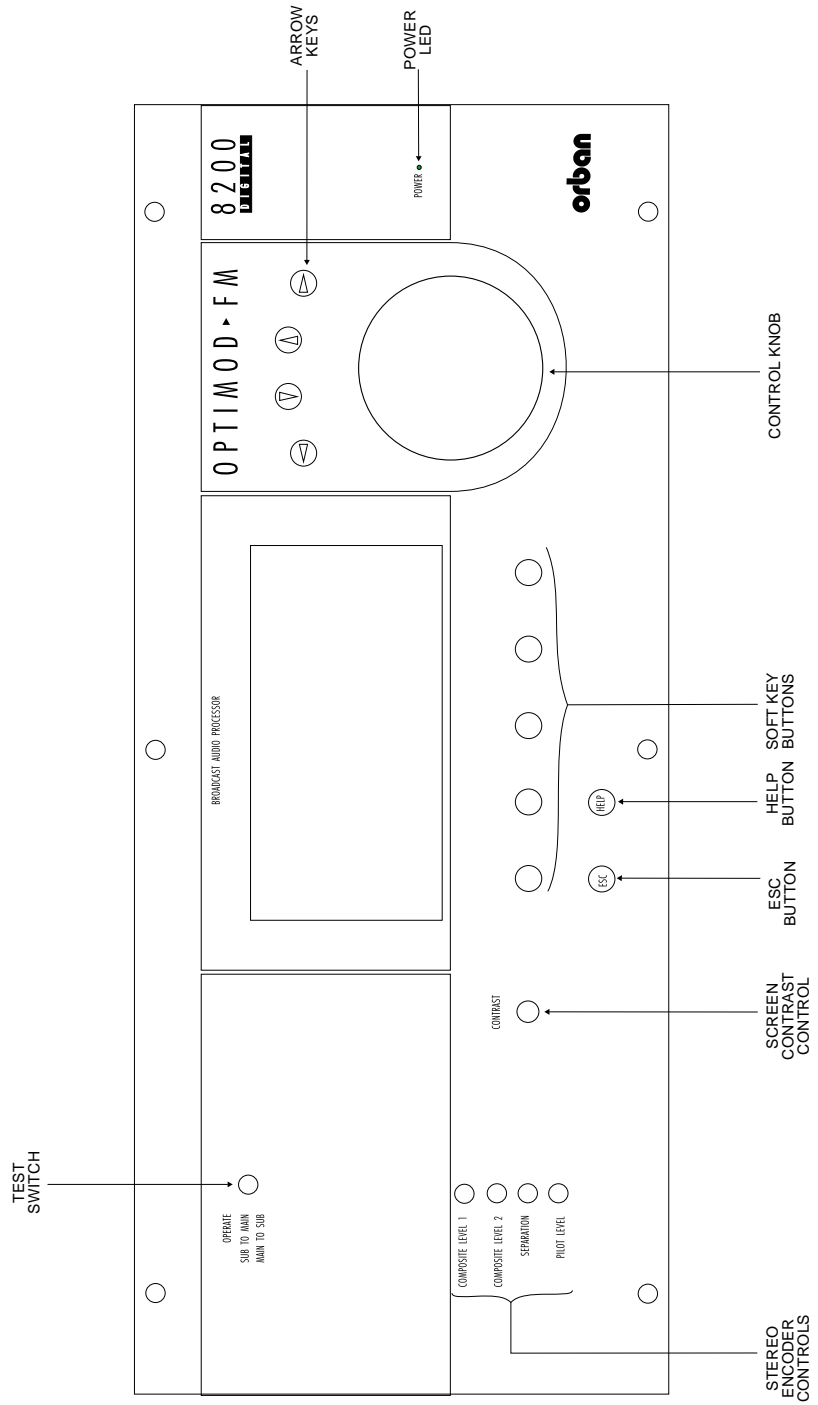



## 8200 Front Panel

**Arrow Keys** (↑, ↓, ←, →) are used for moving around the screen.

**Control Knob** is used for changing the setting that is selected by the arrow keys.

**Screen Display** provides all metering information, labels the five soft key buttons, and provides control setting information.

**Screen CONTRAST Control** adjusts the contrast of the screen display.

**Five Soft Key Buttons** provide access to all 8200 functions and controls. The functions of the buttons changes with each screen, according to the label at the bottom of each screen

**ESC Button** provides an escape from current screen, returns user to the next highest screen, and eventually to the IDLE screen.

**HELP Button** provides HELP information for the current screen and provides detailed help for all of the buttons on that screen. It also provides access to the HELP index of all HELP pages.

**POWER LED** lights when the unit is powered. (It monitors the +12VDC bus.)

### Stereo Encoder Screwdriver-Adjustable Controls

Orban supplies a special green-handled flat-blade screwdriver (Xcelite R3323) to adjust the stereo encoder controls. Note that the Orban tweaker tool supplied with the analog OPTIMODs cannot be used with the 8200.

**Test Switch (OPERATE — SUB TO MAIN — MAIN TO SUB)** sets the stereo encoder to operate normally, or to produce pure L-R or L+R signals for system testing.

**COMPOSITE LEVEL 1 Control** sets the output level of Composite Output 1.

**COMPOSITE LEVEL 2 Control** sets the output level of Composite Output 2.

**SEPARATION Control** adjusts the level of the L+R signal, enabling you to optimize the separation through the entire transmission system. (See step 4 on page 4-11.)

**PILOT LEVEL Control** adjusts the level of the 19kHz stereo pilot tone.

**This Page Intentionally Left Blank.**

## Installation of Studio Level Controller

Refer to “Level Control before the STL,” page 1-16.

### **If you are using Orban 8200ST-Studio Chassis:**

If the STL uses pre-emphasis, its input pre-emphasis network will probably introduce overshoots that will increase peak modulation without any increase in average modulation. We therefore strongly recommend that the STL transmitter’s pre-emphasis be defeated (freeing the STL from such potential overshoot), and that the 8200ST be used to provide the necessary pre-emphasis.

If the STL transmitter’s pre-emphasis cannot be defeated, then configure the 8200ST for flat output. In this case average modulation levels of the STL may have to be reduced to accommodate the overshoots.

### **1. Configure the 8200ST’s internal jumpers**

- A  Remove all screws holding the 8200ST’s cover in place, then lift it off.
- B  Refer to Fig 2-11 on page 2-29 .
  - Place jumper JA in the “CLIPPER ON” position.
  - If you have defeated the STL transmitter’s pre-emphasis, place jumpers JE and JF in the “PRE-EMPHASIZED” position.
  - If you cannot defeat the STL transmitter’s pre-emphasis, place jumpers JE and JF in the “FLAT” position.
- C  Replace the top cover. Replace all screws snugly (be careful not to strip the threads by fastening the screws too tightly).

### **2. Install the 8200ST in the rack. Connect the 8200ST’s audio input and output.**

Refer to the 8200ST Operating Manual if you require information about installation, audio input and output connections to the 8200ST.

**3. Set 8200ST Output Level with tone.**

- A  Press the TONE button on the 8200ST.

The TONE lamp should light and the modulation meters should indicate “0.” If they do not, restrap jumpers JB and JC to “peak.” (Refer to following page.) The 8200ST is now producing a 400Hz sine wave at each output. The peak level of this tone corresponds to 100% modulation.

- B  Adjust the L OUT and R OUT controls so that the STL transmitter is being driven to 100% modulation.

The L OUT and R OUT controls are now correctly calibrated to the transmitter. Provided that no significant overshoot occurs in the transmitter, the MODULATION meter will now give an accurate indication of peak modulation of the STL.

- C  Press the TONE button to turn off the tone.

If the STL transmitter suffers from bounce or overshoot, you may have to reduce the L OUT and R OUT control settings to avoid peak over-modulation caused by overshoots on certain audio signals.

**4. Set controls for normal operation with program material.**

The following assumes that a VU meter is used to determine 8200ST line drive levels with program material.

- A  Set controls as follows:

HF LIMITER	Set to match the pre-emphasis of the transmission system
L OUT, R OUT	Do not change
GATE	12:00
RELEASE	12:00
VOICE	OFF
AGC	ON
COUPLE	ON

- B  Feed the 8200ST either with tone at your system reference level (0VU), or with typical program material at normal levels.

- C  Adjust the GAIN REDUCTION control for the desired amount of gain reduction.

We recommend 8-15dB gain reduction for most formats.

TOP OF MAIN BOARD

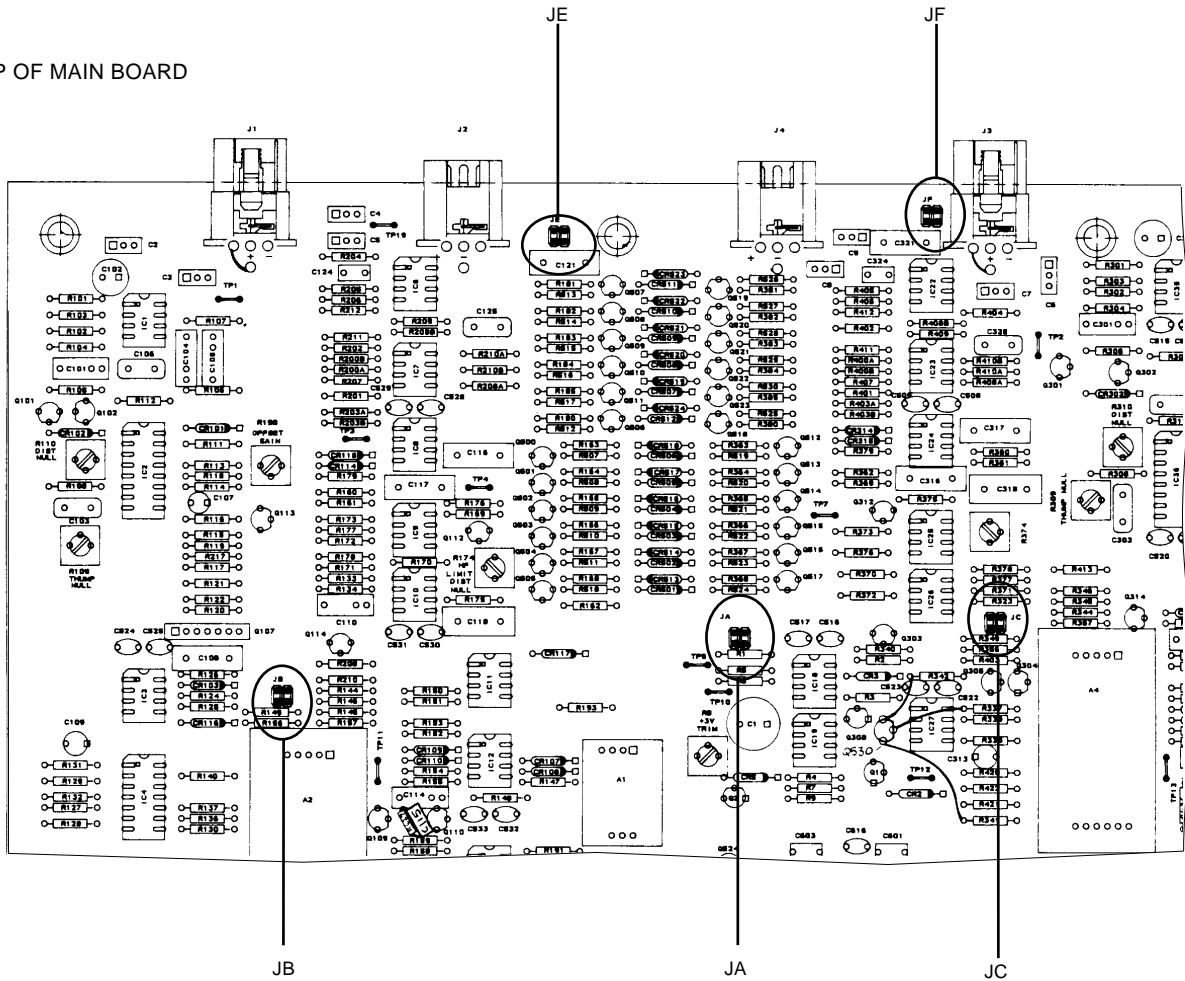

Clipper Jumpers

\*CLIPPER ON



JA

CLIPPER OFF



JA

Output Pre-Emphasis Jumpers

\*FLAT

LEFT OUTPUT



JE

RIGHT OUTPUT



JF

PRE-EMPHASIZED

LEFT OUTPUT



JE

RIGHT OUTPUT



JF

Line-up Level Jumpers

\*PEAK

LEFT OUTPUT



JB

RIGHT OUTPUT



JC

AVG

LEFT OUTPUT



JB

RIGHT OUTPUT



JC

Figure 2-11: 8200ST Jumpers

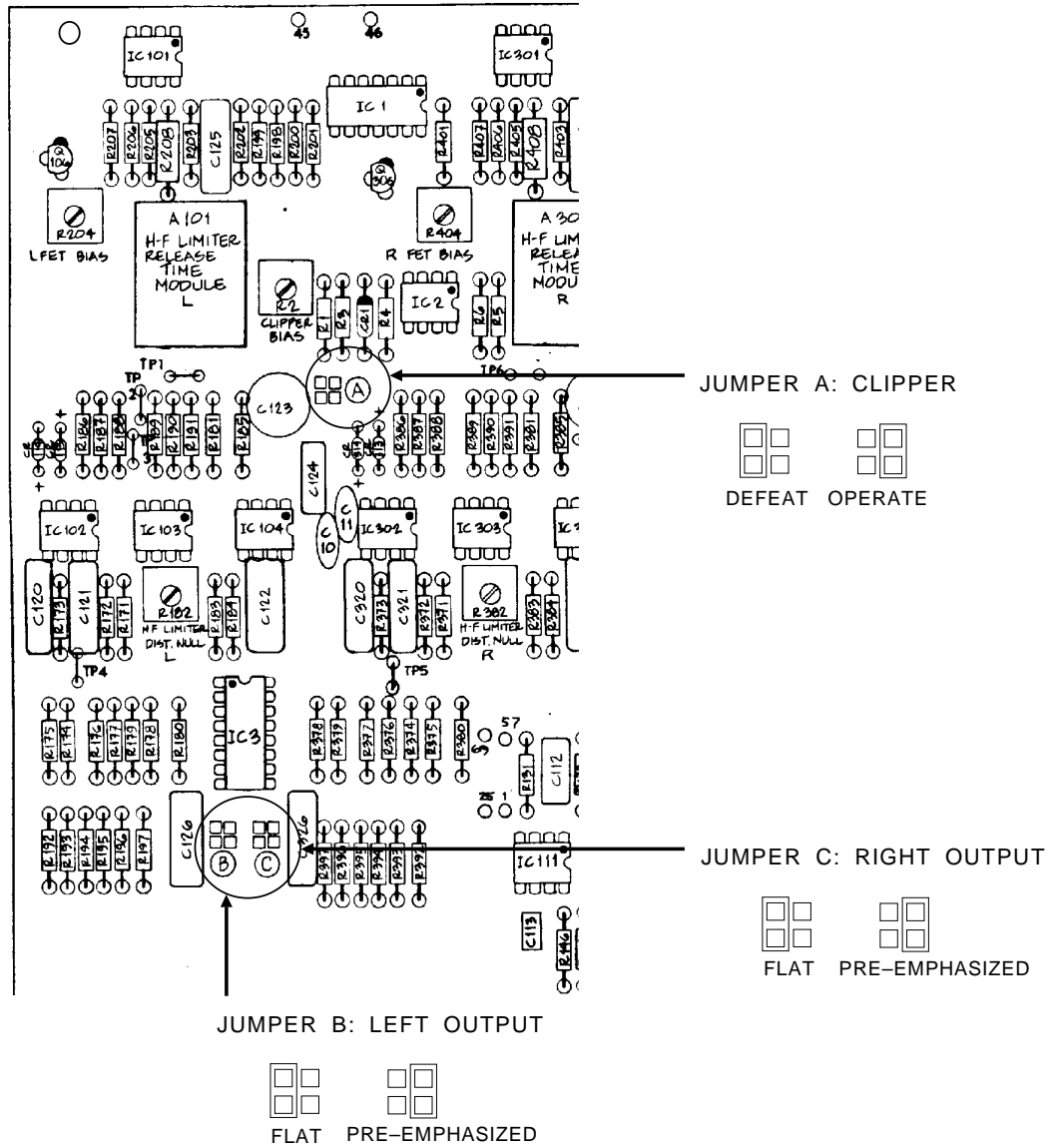

Figure 2-12: 464A Jumpers

**If you are using Orban 464A Co-Operator:**

If the STL uses pre-emphasis, its input pre-emphasis network will probably introduce overshoots that will increase peak modulation without any increase in average modulation. We therefore strongly recommend that the STL transmitter's pre-emphasis be defeated (freeing the STL from such potential overshoot), and that the 464A be used to provide the necessary pre-emphasis.

If the STL transmitter's pre-emphasis cannot be defeated, then configure the 464A for flat output. In this case average modulation levels of the STL may have to be reduced to accommodate the overshoots.

**1. Configure the 464A's internal jumpers**

A  Remove all screws holding the 464A's cover in place, then lift it off.

B  Refer to Fig 2-12 on page 2-30 .

Place jumper A in the "OPERATE" position.

If you have defeated the STL transmitter's pre-emphasis, place jumpers B and C in the "PRE-EMPHASIZED" position.

If you cannot defeat the STL transmitter's pre-emphasis, place jumpers B and C in the "FLAT" position.

C  Replace the top cover. Replace all screws snugly (be careful not to strip the threads by fastening the screws too tightly).

**2. Install the 464A in the rack. Connect the 464A's audio input and output.**

Refer to the 464A Operating Manual if you require information about installation, audio input and output connections to the 464A.

**3. Calibrate the 464A's output level and PEAK OUTPUT LEVEL meters.**

There is no quick way to calibrate the 464A's output level and PEAK OUTPUT LEVEL meters using a TONE. If your STL has input meters that give an accurate indication of program peaks, calibration may be achieved quickly and precisely using PROGRAM material following the procedures detailed in this step.

If you wish to use TONE to calibrate the 464A's output level and PEAK OUTPUT LEVEL meters, follow the procedure in the 464A Operating Manual, page 2-10, steps 10 and 11. Repeat for the right channel. Note that this procedure instructs you to calibrate the 464A's meters to indicate +3dB for 100% modulation of the STL. However, you may wish to calibrate them to indicate 0dB for 100% modulation of the STL. Just be consistent in steps 10 and 11.

**To calibrate the 464A's output level and PEAK OUTPUT LEVEL meters using PROGRAM material:**

- A  Set both channels of the 464A controls as follows:

METER CAL	0
HF LIMIT PRE-EMPHASIS	set to pre-emphasis of your STL; if no pre-emphasis, set to 25 $\mu$ s
OUTPUT ATTEN	0
INPUT ATTEN	10
GATE THRESH	0
RELEASE TIME	0
REL SHAPE	SOFT
LEVEL	OFF
COMPR	OFF
HF LIMIT	OPERATE
SYSTEM	OPERATE
POWER	ON
MODE	DUAL

- B  Play program material from your studio.
- C  Adjust the METER CAL controls on the 464A so that the 0dB segment on the 464A's PEAK OUTPUT LEVEL meter just illuminates on program peaks.
- D  Adjust the OUTPUT ATTEN controls to drive the STL to 100% modulation on program peaks, as shown on its modulation indicator.

**4. Set 464A's controls for normal operation with program material.**

- A  Set both channels of the 464A controls as follows:

METER CAL	Do not change
HF LIMIT PRE-EMPHASIS	Do not change
OUTPUT ATTEN	Do not change
GATE THRESH	5
RELEASE TIME	5
REL SHAPE	SOFT
LEVEL	ON
COMPR	OFF
HF LIMIT	OPERATE
SYSTEM	OPERATE
POWER	ON
MODE	DUAL

- B  Feed the 464A either with tone at your system reference/line-up level, or with typical program material at normal levels.
- C  Adjust the L and R INPUT ATTEN controls for the desired amount of gain reduction — we recommend 5-10dB.
- D  Switch the MODE switch to STEREO.



**If you are using Orban 8100AST Studio Chassis:****1. Configure the 8100AST's internal jumpers to calibrate the 8100AST's output to the STL.**

*[Skip this step if your 8100A OPTIMOD FM system is equipped with the 8100AXT2 Six-Band Limiter, and the 8100AST is already correctly level matched to your STL. Continue with step 7.]*

- A  Remove all screws from the top and bottom covers of the 8100AST.
- B  Check that card No. 5 has a part number of 30741-000-03 or above. All 8100A1 or 8100A/1 units, or any unit updated to work with the XT2 Six-Band Limiter should have the correct card.

If you have an older 8100A Card No. 5, it must be replaced to work correctly with the 8200. Order RET027 Retrofit Kit from your Orban dealer.

- C  Refer to Figure 2-13.

If your Studio Chassis had previously been correctly level matched to your STL, place jumpers A, B, and C in the ACCESSORY CHASSIS positions. Skip to step 5.

If your Studio Chassis had not previously been correctly level matched to your STL, place jumpers A, B, and C in the NORMAL positions. Then continue with the following steps.

**2. Connect the 8100AST's audio input and output.**

Refer to the 8100AST Operating Manual if you require information about audio input and output connections to the 8100AST.

Do not install the 8100AST in the rack at this time.

**3. Calibrate the 8100AST's output to the STL.**

- A  Be sure that jumpers A, B, and C are in the NORMAL position, as indicated in step 1-C.
- B  Set the 8100AST controls as follows:

Gate Threshold	0
Bass Coupling	10
Release Time	10
Clipping	+2
L and R OUTPUT LEVELS	fully counterclockwise (a maximum of 18 turns)
Proof/Operate Switch	OPERATE
L and R INPUT ATTENUATORS	10

- c  Connect an audio oscillator to the LEFT input of the 8100AST. Set its frequency to 1kHz, and its output level to produce 10dB gain reduction as indicated on the 8100AST's MASTER TOTAL G/R meter.
- d  Adjust the 8100AST's L OUTPUT LEVEL:
  - The tone produced is at the 8100AST's standard reference/line-up level.
  - If your STL is not pre-emphasized, adjust the 8100AST's L OUTPUT LEVEL for 9dB below 100% peak modulation of the STL.
  - If your STL is pre-emphasized to 50µs or 75µs, adjust the 8100AST's L OUTPUT LEVEL for 14dB below 100% peak modulation of the STL.
- e  Repeat steps C and D for the right channel.

**4. Configure the 8100AST's internal jumpers for proper operation with the 8200.**

- A  Refer to Figure 2-13.
  - Place jumpers A, B, and C in the ACCESSORY CHASSIS positions.

**5. Replace the top and bottom covers.**

**6. Install the 8100AST in the rack.**

- A  Refer to the 8100AST Operating Manual if you require information about installation.

**7. Set 8100AST's controls for normal operation with program material.**

- A  Set the 8100AST controls as follows:
 

Gate Threshold	4
Bass Coupling	7
Release Time	6.5
Clipping	0
L and R OUTPUT LEVELs	Do not change
Proof/Operate Switch	OPERATE
L and R INPUT ATTENUATORs	to produce 5-10dB gain reduction on typical program material, as shown on the 8100AST's TOTAL MASTER G/R meter

- B  Lock the door.

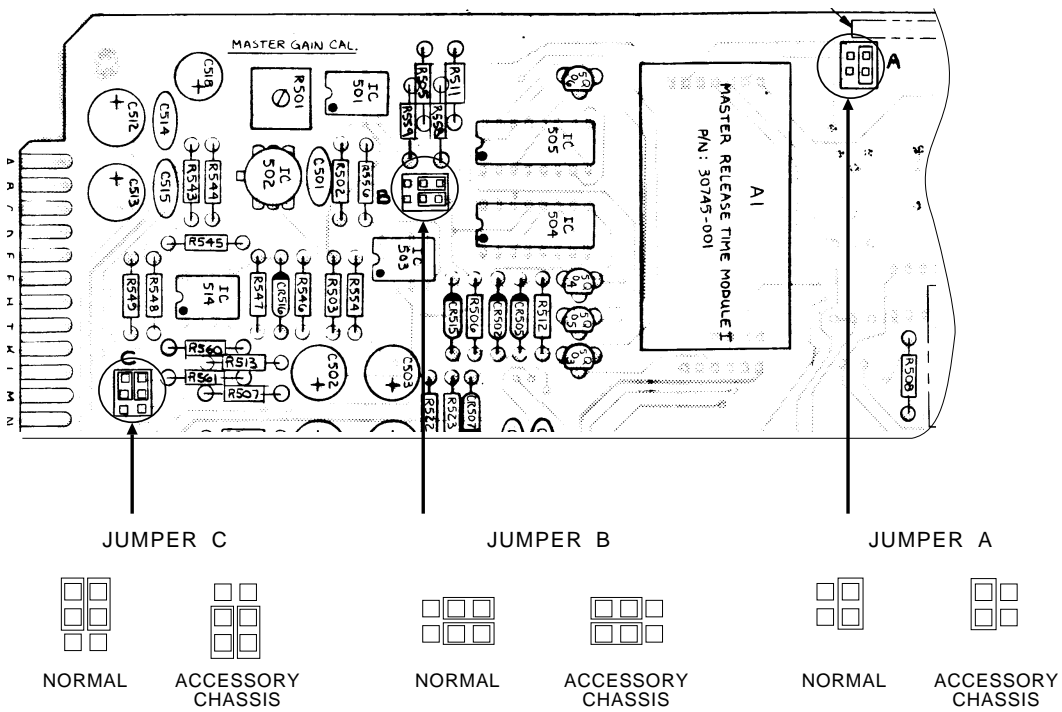

Figure 2-13: 8100AST Jumpers

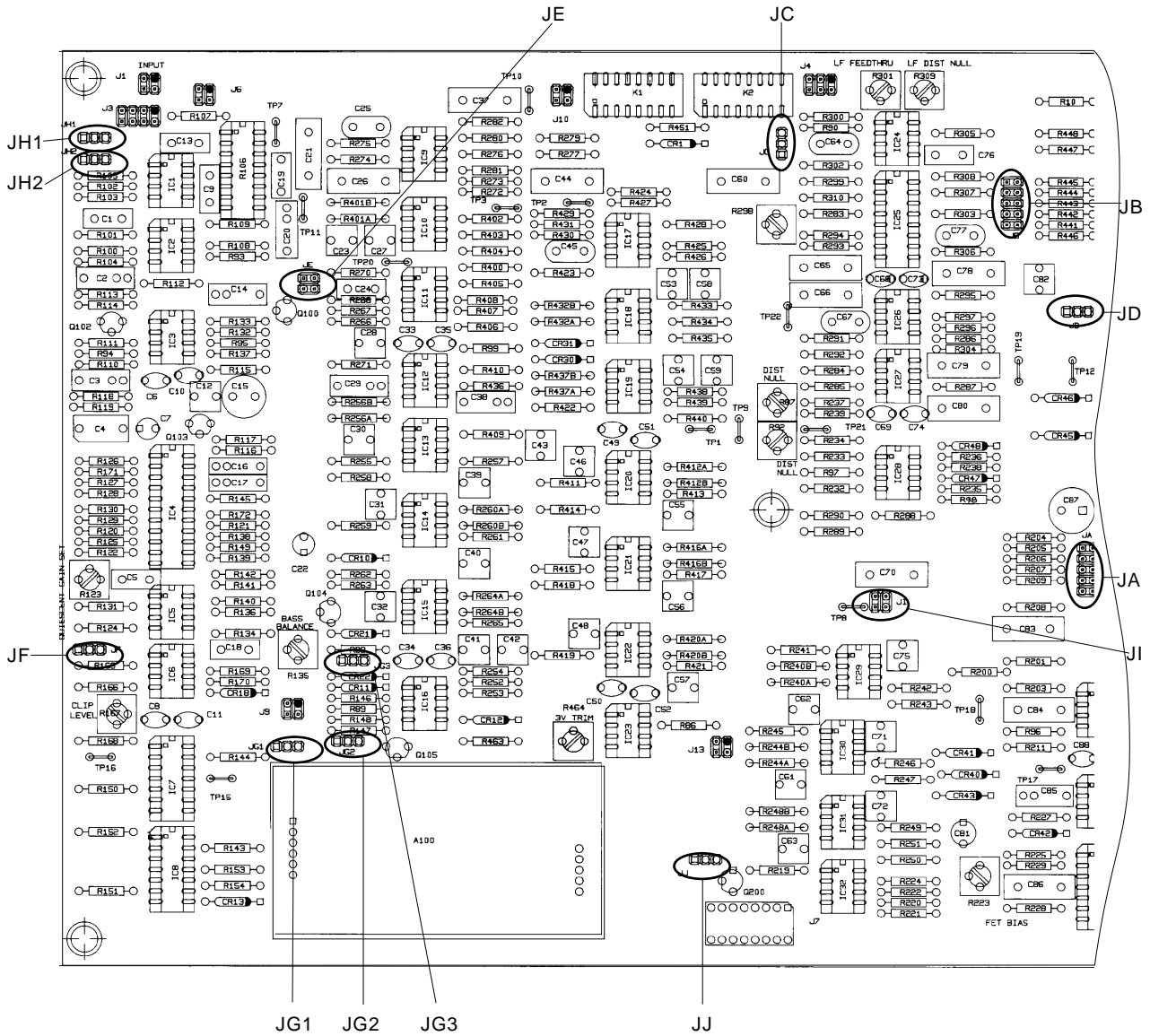

Figure 2-14: 4000 Jumpers

**If you are using Orban 4000 Transmission Limiter:**

If the STL uses pre-emphasis, its input pre-emphasis network will probably introduce overshoots that will increase peak modulation without any increase in average modulation. We therefore strongly recommend that the STL transmitter's pre-emphasis be defeated (freeing the STL from such potential overshoot), and that the 4000 be used to provide the necessary pre-emphasis.

If the STL transmitter's pre-emphasis cannot be defeated, then configure the 4000 for flat output. In this case average modulation levels of the STL may have to be reduced to accommodate the overshoots.

**1. Configure the 4000's internal jumpers**

- A  Remove the top and bottom covers to access the main circuit boards. **Note that the 4000 is a two-channel unit and has two boards with identical jumpers for resetting.**
- B  Refer to Figure 2-14 for jumper locations.
- C  Activate the high frequency limiter.

Place jumpers JI and JJ in the HF LIMITER ACTIVE position.

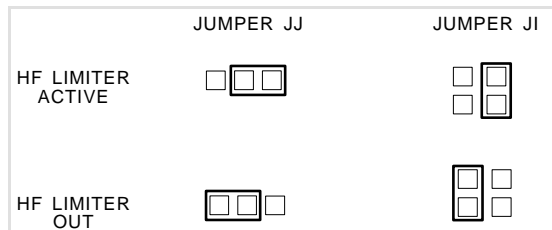

Figure 2-15: HF Limiter Jumpers

- Set pre-emphasis of the high frequency limiter.

Place jumpers JF, JE, JA and JB in the position for the pre-emphasis of your STL (25μs, 50μs, 75μs, 150μs, or J.17).

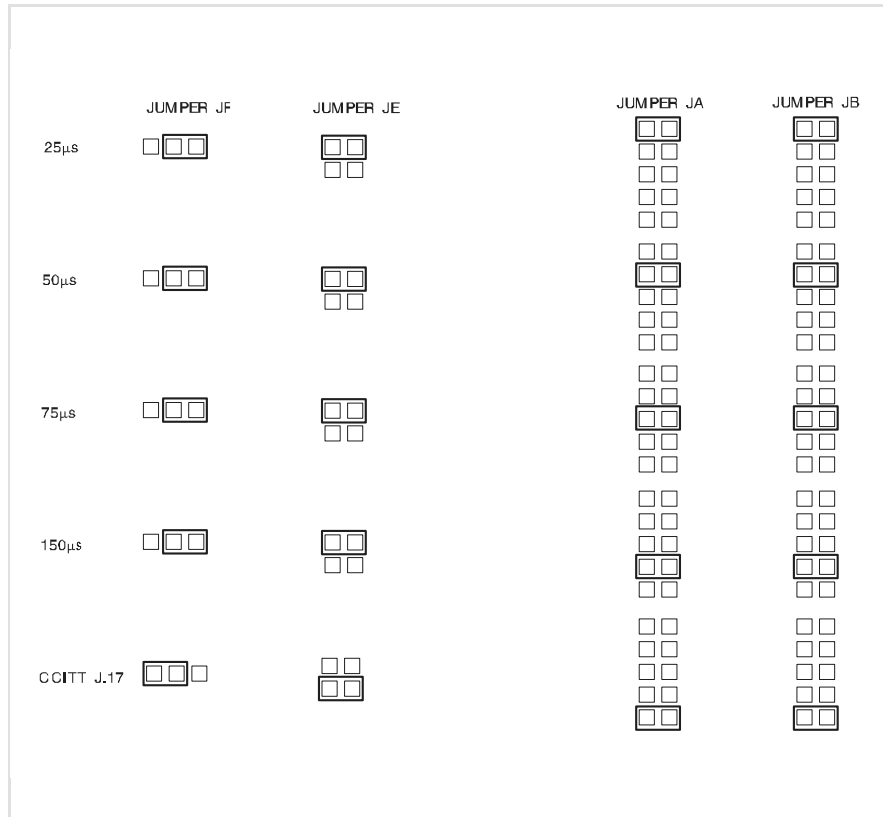

Figure 2-16: Pre-Emphasis EQ Jumpers

- Set the output for pre-emphasized or flat response, as appropriate.

If you have defeated the STL transmitter's pre-emphasis, place jumper JD in the PRE-EMPHASIZED position.

If you cannot defeat the STL transmitter's pre-emphasis, place jumper JD in the FLAT position.

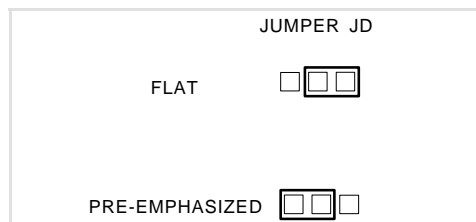

Figure 2-17: Pre-Emphasis Jumper

- F  Set the two channels for stereo coupling.

Place jumpers JG1, JG2, and JG3 in the COUPLED position.

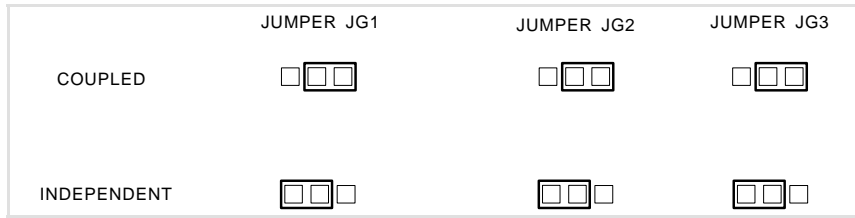

Figure 2-18: Stereo Coupling Jumpers

- G  Replace the top and bottom covers.

## 2. Install the 4000 in the rack. Connect the 4000's audio input and output.

Refer to the 4000 Operating Manual if you require information about installation, audio input and output connections to the 4000.

## 3. Calibrate the 4000's OUTput level to the STL.

- A  Press both TONE buttons on the 4000's front panel.  
 B  Adjust the 4000's L and R OUTPUT LEVELs for 100% peak modulation of the STL.

## 4. Calibrate the 4000's INput level for normal operation using tone.

*[Skip this step if you wish to calibrate the 4000's INput level using program material. (Refer to step 5)]*

Some facilities have specific standards for transmission line-up. For example, a transmission standard may state that +4dBu at 400Hz produces 50% modulation of a microwave link. Or PPM6 might allow 8dB of headroom so it would modulate the link to 40%.

Determine the input level to the studio-to-transmitter link that produces 100% modulation of the link.

In step 4-D, we calibrate the gain of the 4000 below the threshold of limiting.

For facilities using VU meters, we suggest:

$$100\% \text{ peak level (dBu)} - 0\text{VU level (dBu)} - 14\text{db} = \text{gain of the 4000}$$

For example, with an STL where 100% modulation = +18dBu, and with a studio where 0VU = +4dBu:

$$+18 - (+4) - 14 = \text{set gain of the 4000 to 0dB}$$

For facilities using PPM meters, we suggest:

$100\% \text{ peak level (dBu)} - \text{PPM reference level (dBu)} - 9\text{db} = \text{gain of the 4000}$

For example, with an STL where 100% modulation = +15dBu, and with a studio where PPM reference level = +6dBu:

$$+15 - (+6) - 9 = \text{set gain of the 4000 to 0dB}$$

- A  Turn the INput control fully counterclockwise.
- B  Press the OPERATE button, then the TEST button.
- C  Apply a line-up tone to the 4000 input, at your organization's standard reference line-up level.
- D  Calibrate the 4000 for the pre-determined gain or loss.
  - Measure the output level of the 4000 with an audio meter. Adjust the 4000's INput control to achieve the desired gain or loss.
- E  Press the OPERATE button. Observe the LIMITING meter.
  - If no gain reduction is indicated, the standard line-up level is below threshold.
  - If gain reduction is indicated, the standard line-up level is above threshold (less than 7dB below 100% modulation). System calibration will require that the TEST button be pressed, either on the front panel or by remote control, when system line-up calibration is performed. You may consider calibrating the 4000 for less than unity gain by reducing the INput control setting.

## 5. Calibrate the 4000's INput level for normal operation using program material.

*[Skip this step if you wish to calibrate the 4000's INput level using tone. (Refer to step 4)]*

- A  Turn the INPUT control fully counterclockwise.
- B  Press the OPERATE button, then the TEST button.
- C  Play program material from your studio at normal levels.
- D  Adjust the INput level controls so that the 4000 goes into gain reduction only on the highest program peaks.



## System Setup Using QUICK SETUP

Allow about 1 hour for system setup.

You can set up all of the 8200's required settings through QUICK SETUP. It is a guided screen-by-screen procedure for adjusting all of the setup adjustments needed to get you on the air, including time and date, and adjustment of input and output levels.

The same settings are also available on one screen (I/O CALIB), for those already familiar with the 8200's adjustments. That screen also contains a few special-feature input/output parameters that are not part of QUICK SETUP.

After quick setup, you may adjust these special-feature parameters, program the remote control, and restrict access to the controls using PASCODES.

**NOTE:** If you do not want to use QUICK SETUP to initialize your system, you can skip to "System Setup Using Individual Calibration Controls," on page 2-55, at this time.

**NOTE:** Quick Setup should not be used to make system changes after initial setup. Instead, use I/O Calib and other related controls, as necessary

### 1. Begin System Setup.

- If you have not done so already, plug in the 8200's power cord. The IDLE screen (shown below) appears in the window display.

If the IDLE screen does not appear, repeatedly press ESC until it does appear.

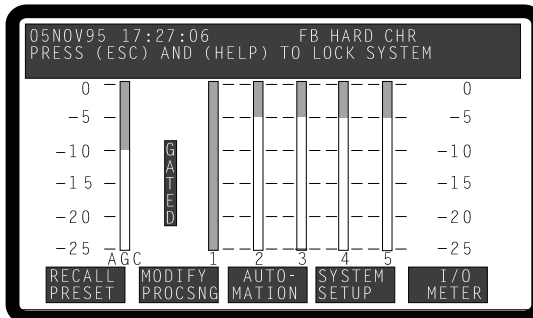

Use the CONTRAST knob to adjust the display for best clarity.

- B  Press **SYSTEM SETUP** button to access **SYSTEM SETUP** screen. (Press the soft key directly below the words “SYSTEM SETUP.”)

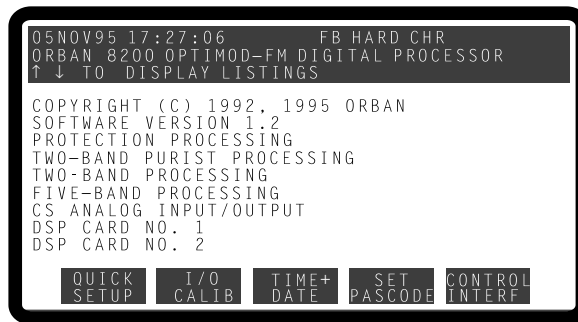

**2. Begin QUICK SETUP.**

- A  Press **QUICK SETUP** button to access the first **QUICK SETUP** screen.
- B  This screen provides a brief explanation and overview of **QUICK SETUP**.

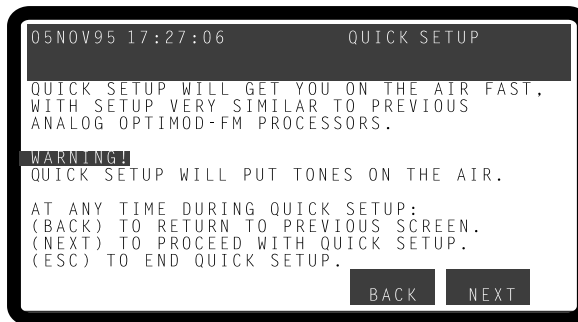

- c  Press **NEXT**, to continue.

Press **BACK** from any **QUICK SETUP** screen if you need to return to the previous screen.

Press **HELP** from **QUICK SETUP** screen for more information about the screen’s adjustments.

**3. Set QUICK SETUP to adjust ANALOG or DIGITAL inputs and outputs.**

*[This step will only appear in the first QUICK SETUP screen if one of the optional digital I/O cards is installed.]*

- A  Use the front panel control knob to set the 8200’s **QUICK SETUP** to adjust analog or digital parameters.
- B  If you want to calibrate the 8200 so it can be used with both analog and digital inputs, you must do two complete passes through the **QUICK SETUP** steps, once for digital, once for analog.

#### 4. Set the clock in OPTIMOD-FM.

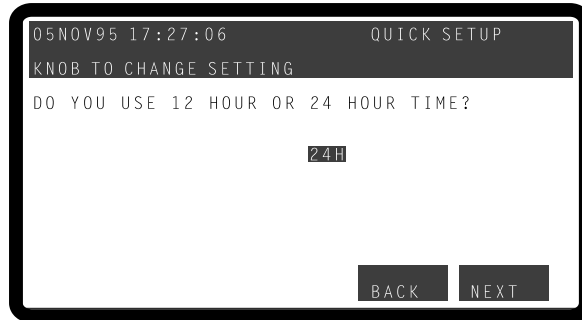

- A Set OPTIMOD-FM for 12-hour or 24-hour time.

The 8200's internal clock is displayed on the top line of the screen, and is used for programmed preset switching using the 8200's built-in AUTOMATION. It can be set to display 12 hour (AM and PM) or 24 hour time.

Use the knob to set the 8200 screen display for 12 hour or 24 hour time.

- B Press NEXT to continue.
- C Set the current time.

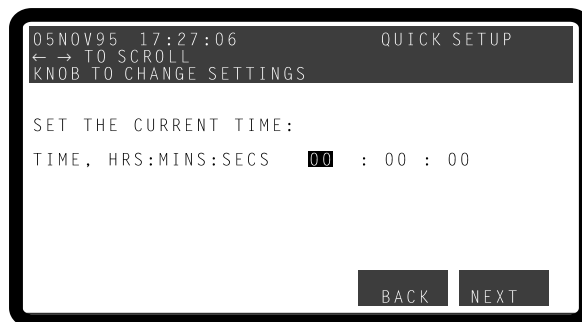

Use the ← and → arrow keys to scroll through hours, minutes, seconds. Change the settings with the control knob. When the NEXT button is pressed, the time that you entered is set.

- D Press NEXT to set the time entered, and to continue.

- E  Set the current date.

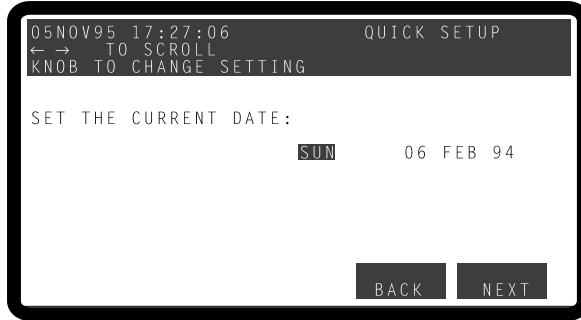

Use the ← and → arrow keys to scroll through the date parameters. Change the settings with the control knob.

- F  Press NEXT to continue.
- G  Set OPTIMOD-FM for daylight savings time.

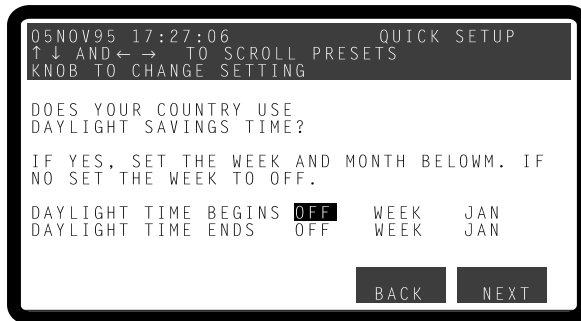

If your country uses Daylight Savings Time (Summer Time), the 8200's clock will advance the time one hour at 2:00A Sunday on the "BEGINS" week that you enter, and turn back the time one hour at 2:00A Sunday on the "ENDS" week that you enter.

Use the ↑, ↓, ← and → arrow keys to scroll through and select (highlight) the parameters. Use the control knob to change values. If your country uses Daylight Savings Time, set the date parameters, then press NEXT to continue.

If your country does not use Daylight Savings Time, set the week parameters to OFF.

Press NEXT, to continue.

At the time this manual was written (October 1992), we determined the rules for daylight savings times for selected countries. However, as with anything politically determined, these rules are subject to change without notice.

#### Europe

All countries except as noted below: begins LAST SUN MAR, ends LAST SUN SEP

Ireland, United Kingdom: begins LAST SUN MAR, ends LAST SUN OCT

#### Middle East

Israel: begins LAST SUN MAR, ends 1ST SUN SEP

#### North America

Bahamas, Bermuda, Canada, Cuba, Haiti, Mexico-Tijuana, United States (except Arizona, Hawaiian Islands, Indiana-East): begins 1ST SUN APR, ends LAST SUN OCT

#### Pacifica

Australia (Lord Howe Island, NSW, Victoria, ACT, SA, Broken Hill): begins LAST SUN OCT, ends 1ST SUN MAR

Australia (Tasmania): begins 1ST SUN OCT, ends LAST SUN MAR

New Zealand: begins 1ST SUN OCT, ends 3rd SUN MAR

#### South America

Brazil: begins 3RD SUN OCT, ends LAST SUN JAN

Argentina: begins 3RD SUN OCT, ends 1ST SUN MAR

Chile: begins 2ND SUN OCT, ends 2ND SUN MAR

Falkland Islands: begins 2ND SUN SEP, ends 3RD SUN APR

Uruguay: begins LAST SUN OCT, ends LAST SUN FEB

### 5. Set pre-emphasis to the standard used in your country.

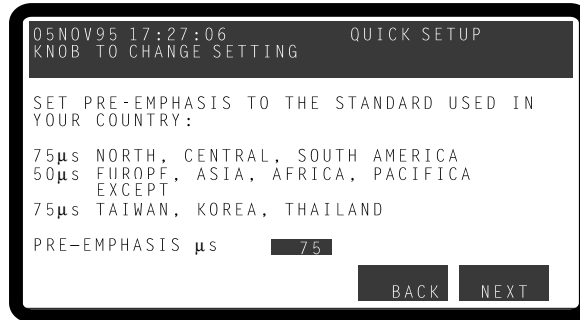

- A  Use the front panel control knob to set the 8200 pre-emphasis to the standard used in your country.
- B  Press NEXT, to continue.

### 6. Set studio chassis status.

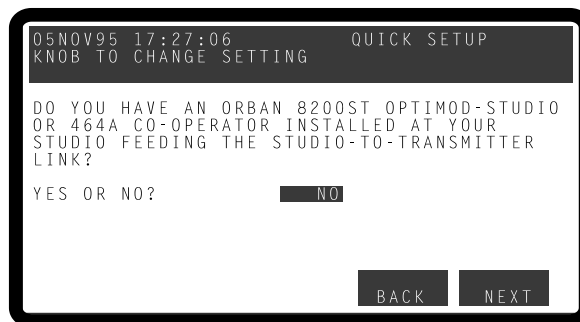

- A  Use the front panel control knob to tell the 8200 if you have an Orban 8200ST OPTIMOD-Studio or 464 Co-Operator, or similar AGC installed at your studio feeding the studio-to-transmitter link.

Most of the processing structures in the 8200 control level with a preliminary AGC (Automatic Gain Control). If you are using a suitable Automatic Gain Control at the studio (such as an Orban 8200ST OPTIMOD-Studio or 464 Co-Operator), the AGC in the 8200 should be defeated. This is so that the two AGCs do not “fight” each other, and so they do not simultaneously increase gain resulting in increased noise.

**If you are using an Orban 4000 Transmission Limiter**, answer **NO** to the question (so that the AGC function in the 8200 continues to work). The Orban 4000 is a transmission system overload protection device; it is normally operated below threshold. It is not designed to perform an AGC or gain-riding function, and it cannot substitute for the AGC function in the 8200.

- B  Press NEXT, to continue.

## 7. Adjust analog left/right input peak clipping level.

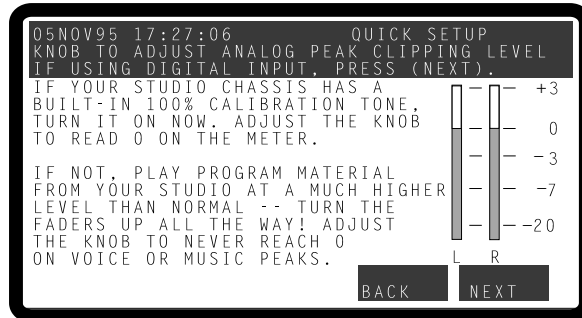

*[If you have set the 8200's active input to Digital in step 3, this step will not appear.]*

This step calibrates the level at which the 8200's A-D (Analog-to-Digital) converter clips to the absolute maximum peak level that your installation supplies to the 8200's analog input.

This setup maximizes the 8200's signal-to-noise ratio. If the clip level is set too low, the 8200's analog-to-digital converters will overload and distort on program peaks. If the clip level is set too high, the signal-to-noise ratio will suffer. Use care and attention in setting this adjustment.

If you are adjusting the 8200 during normal programming, and cannot interrupt or distort the program to play program material from your studio at a much higher level than normal, follow the directions for:

**calibration while on air with normal programming (page 2-48)**

If you are able to interrupt or distort normal programming, more precise calibration can be achieved. Follow the directions for:

**calibration with unprocessed audio (page 2-48)**

**calibration with a Studio Level Control System that has a built-in 100% CALIBRATION TONE, such as the Orban 8200ST-Studio Chassis or the Orban 4000 Transmission Limiter (page 2-48)**

**calibration with an Orban 464A Co-Operator (page 2-48)**

**calibration with an Orban 8100AST Studio Chassis (page 2-49)**

as appropriate.

Note that in this step, you are calibrating to the maximum absolute peak level; this is quite different from the maximum peak indication of the studio meters.

## calibration while on air with normal programming

- A  Adjust the 8200's control knob so that the program peaks just reach to about  $-10\text{dB}$  on the meter on the screen.

**Observe the meters on the 8200 screen for a long period of time; be sure to observe live announcer voice. If this setting is mis-adjusted, distortion will result.**

**0dB indicates input clipping on the 8200. These meters should never peak as high as 0dB with program material.**

- B  Press NEXT, to continue.

## calibration with unprocessed audio

- A  Play program material from your studio at a much higher level than normal — turn the faders up all the way! This will produce the highest peak level output that your system can produce.

- B  Adjust the 8200's control knob so that the program peaks just reach to about  $-2\text{dB}$  on the meter on the screen.

**0dB indicates input clipping on the 8200. These meters should never peak as high as 0dB with program material.**

- C  Press NEXT, to continue.

## calibration with a Studio Level Control System that has a built-in 100% CALIBRATION TONE, such as the Orban 8200ST-Studio Chassis or the Orban 4000 Transmission Limiter

- A  Turn on the Studio Level Control System's 100% CALIBRATION TONE.

On the Orban 4000 Transmission Limiter, press both of the 4000's front panel TONE buttons.

On the Orban 4000 Transmission Limiter, press both of the 4000's front panel TONE buttons.

- B  Adjust the output level of the Studio Level Control System for 100% modulation of the STL.

- C  Adjust the 8200's control knob to indicate  $-2\text{dB}$  on the meters on the screen.

- D  Press NEXT, to continue.

## calibration with an Orban 464A Co-Operator

The 464A does not have a built-in 100% tone. The easiest way to set the 8200 input peak clipping level is to temporarily re-adjust the 464A to produce clipped waveforms on program material to give a clear indication of peak clipping level.



- A  Set both channels of the 464A controls as follows:

METER CAL	0
HF LIMIT PRE-EMPHASIS	set to pre-emphasis of your STL; if no pre-emphasis, set to 25 $\mu$ s
OUTPUT ATTEN	0
INPUT ATTEN	10
GATE THRESH	0
RELEASE TIME	0
REL SHAPE	SOFT
LEVEL	OFF
COMPR	OFF
HF LIMIT	OPERATE
SYSTEM	OPERATE
POWER	ON
MODE	DUAL

- B  Play program material from your studio.
- C  Adjust the 464A's METER CAL controls so that the 0dB segment on the 464A's PEAK OUTPUT LEVEL meter just illuminates on program peaks.
- D  Adjust the 464A's OUTPUT ATTEN controls to drive the STL to 100% modulation.
- E  Adjust the 8200's knob so that the program peaks just reach to about -2dB on the meter on the screen.
- F  Return the 464A to the normal settings.
- G  Press NEXT, to continue.

### **calibration with an Orban 8100AST Studio Chassis**

The 8100AST does not have a built-in 100% tone. The easiest way to set the 8200 input peak clipping level is to temporarily re-adjust the 8100AST to produce maximum output level on program material to give a clear indication of peak clipping level.

- A  Set the 8100AST controls as follows:

Gate Threshold	0
Bass Coupling	0
Release Time	0
Clipping	MORE (+2)
L and R OUTPUT LEVELs	fully counterclockwise (a maximum of 18 turns)
Proof/Operate Switch	OPERATE
L and R INPUT ATTENUATORs	10

- B  Play program material from your studio.
- C  Set the output level controls to produce 100% modulation of the studio-to-transmitter link.
- D  Use the knob to adjust so that the program peaks just reach to about -2dB on the meter on the screen.

- E  Return the 8100AST to the normal settings.
- F  Press NEXT, to continue.

**8. Calibrate the 8200 to your standard studio level.**

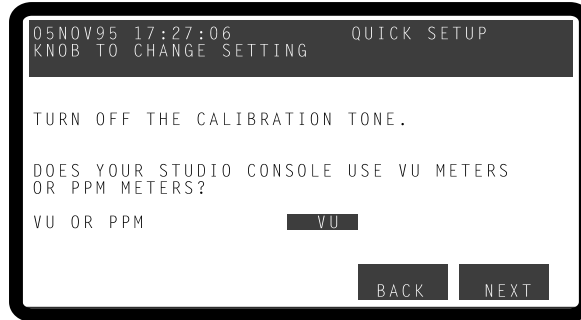

- A  Use the control knob to tell the 8200 if your studio console uses VU meters or PPMs.

*[Skip this step if you will not be using the 8200's analog input, but will only be using the AES/EBU digital input. Continue to step 8-B.]*

The relationship of average program level as seen on your console's meter to the average level sensing used in the 8200's gain reduction circuits differs between VU meters and PPMs. This setting compensates for this difference.

- B  Press NEXT, to continue.

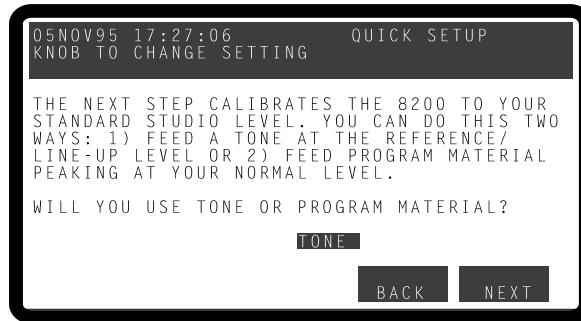

- C  Use the control knob to tell the 8200 if you are using tone or program material to calibrate the 8200 to your standard studio level.

*[Skip this step if you will not be using the 8200's analog input, but will only be using the AES/EBU digital input. Continue with step 8-D.]*

This step calibrates the 8200 to the level to which your studio operators peak program material on the studio meters. This assures that the 8200's processing presets will operate in their preferred range.

You may adjust this level with a standard reference/line-up level tone from your studio or with program material.

Note that in this step, we are calibrating to the normal indication of the studio meters; this is quite different from the actual peak level.

- Press NEXT, to continue.

*[Press NEXT if you will not be using the 8200's analog input, but will only be using the AES/EBU digital input. Continue with step 9.]*

- Calibrate using TONE — feed a tone at your reference level to the 8200.

*[Skip this step if you are using PROGRAM material to calibrate the 8200 to your standard studio level. Skip to step 8-H.]*

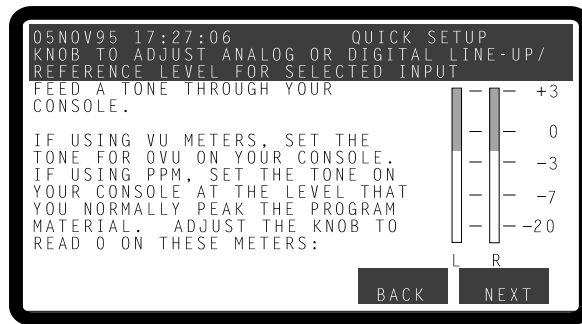

**If you are not using a studio level controller**, feed a tone through your console at the level to which you normally peak program material (typically 0VU if your console uses VU meters).

**If you are using an Orban 4000 Transmission Limiter**, press its two TEST buttons. Feed a tone through your console at the level to which you normally peak program material (typically 0VU if your console uses VU meters).

**If you are using a studio level controller that performs an AGC function, such as an Orban 8200ST OPTIMOD-Studio, 464A or 8100AST**, adjust it for normal operation.

- Use the 8200's front panel control knob to adjust for 0dB on the 8200's meters.
- Press NEXT, to continue. Skip to step 9.

- ⌘ Calibrate using PROGRAM — feed normal PROGRAM MATERIAL to the 8200.

*[Skip this step if you are using TONE to calibrate the 8200 to your standard studio level (see steps 8-A to 8-G).]*

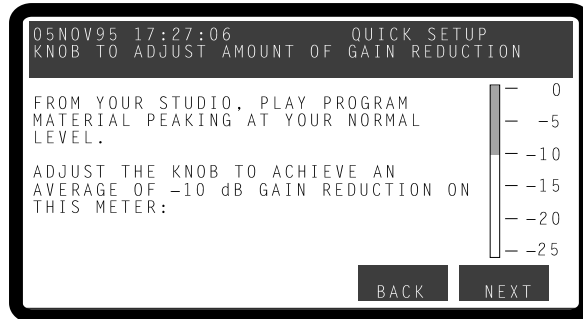

Play program material from your studio, peaking at the level to which you normally peak program material (typically 0VU if your console uses VU meters).

- ⌘ Use the 8200's front panel control knob for an average of -10dB on the 8200's meters.
- ⌘ Press NEXT, to continue.

**9. Adjust COMPOSITE OUT level control.**

*[Press NEXT if you are not using the 8200's built-in stereo encoder. Continue with step 9-C.]*

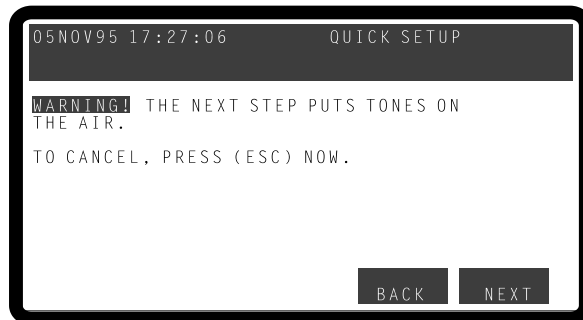

- A  Press NEXT, to continue.

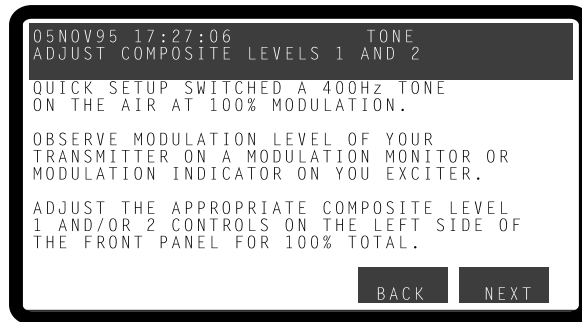

- B  Adjust the 8200's COMPOSITE OUT level control(s) — screwdriver slots on the left side of the front panel — for 100% TOTAL MODULATION of your FM exciter, as indicated on a modulation monitor, or modulation indicator on your exciter.

If using a composite STL, adjust the 8200's COMPOSITE OUT level control(s) for 100% TOTAL MODULATION of your composite STL transmitter, as indicated on the STL's modulation indicator. Then adjust your STL's receiver output level control and/or FM exciter composite input level control for 100% TOTAL MODULATION of your FM exciter, as indicated on a modulation monitor, or modulation indicator on your exciter.

If your station transmits with SCAs, and you are required to reduce program modulation to accommodate the SCA modulation, do not perform the reduction with this step — adjust this step for actual 100% modulation ( $\pm 75\text{kHz}$ ). This will assure that the pilot level on the air matches the 8200's built-in pilot level meter. See Remote Control Interface Programming, page 2-75, to adjust the 8200 to reduce program modulation in the presence of SCAs.

- C  Press NEXT, to continue.

## 10. Select the program format of your station.

This step selects the processing to complement the program format of your station.

After this step, you can always select a different processing preset, program the 8200 to automatically change presets on a time/date schedule, modify presets to customize your sound, and store these presets as user presets.

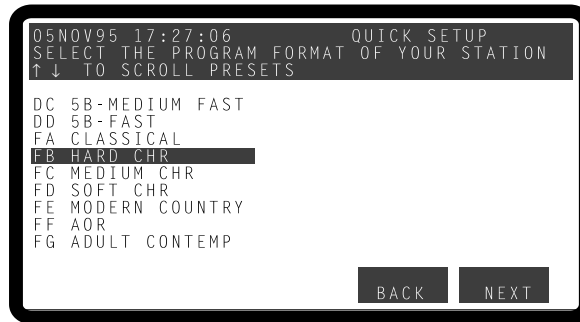

- A  Use the ↑ and ↓ arrow keys to scroll through and select (highlight) a format.
- B  Press NEXT, to continue.

**11. Complete QUICK SETUP.**

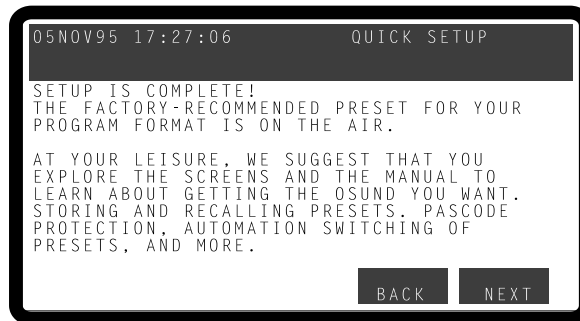

- A  Press NEXT, to exit QUICK SETUP and return to IDLE screen.

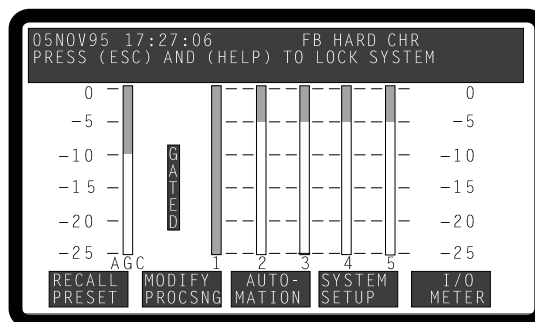

If you want to set up additional input/output parameters, program a pascode to limit access to front panel controls, or reset any setup adjustments, continue to “System Setup Using Individual Calibration Controls,” on page 2-55. If you are ready to use the 8200, proceed to Section 3 for important 8200 operation information.

## System Setup Using Individual Calibration Controls

[Skip this step if you set input/output levels in *QUICK SETUP* and you do not want to make further adjustments. A few special-feature input/output parameters are not part of *QUICK SETUP*. They are indicated on the list in step 2.]

### 1. Access I/O CALIB screen.

- A If the IDLE G/R screen (shown below) does not appear, press ESC repeatedly until you see it.

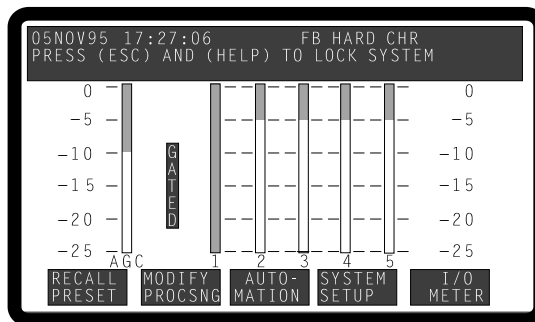

Use the CONTRAST knob to adjust the display for best clarity.

- B Press SYSTEM SETUP button to access SYSTEM SETUP screen. (Press the soft key directly below the words "SYSTEM SETUP.")

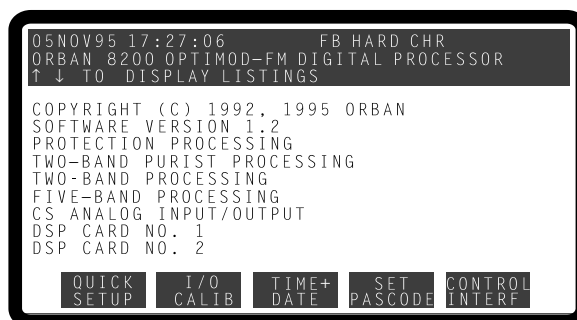

- c  Press I/O CALIB button to access I/O CALIB screen.

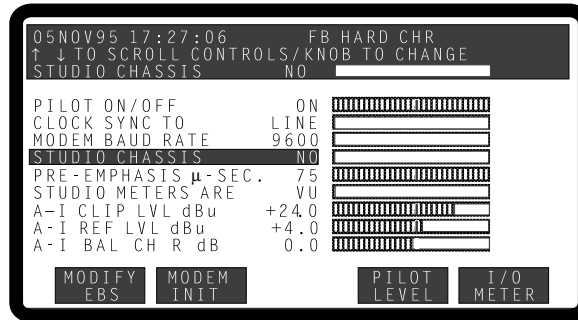

## 2. Adjust Input/Output Levels and System Calibrations.

For the following I/O CALIB parameters, use ↑ and ↓ arrow keys to scroll through and select (highlight) input/output parameters. Then use the front panel control knob to adjust the parameter settings, as desired.

The screen as shown above lists all of the controls available for adjustment. Observe that the control selected (highlighted) is also shown on line 3 of the screen. You can press the last soft key (I/O METER) to see the input and output meters instead of the control list. The selected control can be seen on line 3. You can still use the ↑ and ↓ arrows to scroll through the control list. To return to display the control list, press the last soft key (CONTROL LIST).

**Note:** If a Digital I/O Card is installed in your 8200, additional I/O CALIB parameters are listed. Refer to your Digital I/O Installation Instructions.

- A  STUDIO CHASSIS (included on QUICK SETUP)

[YES] or [NO]

This control tells the 8200 if you have a studio chassis (such as an Orban 8200ST OPTIMOD-Studio, Orban 464A Co-Operator, or similar AGC) installed at your studio feeding the studio-to-transmitter link.

Most of the processing structures in the 8200 control level with a preliminary AGC (Automatic Gain Control). If you are using a suitable Automatic Gain Control at the studio (such as an Orban 8200ST OPTIMOD-Studio or 464A Co-Operator), the AGC in the 8200 should be defeated. This is so that the two AGCs do not “fight” each other, and so they do not simultaneously increase gain resulting in increased noise.

**If you are using an Orban 4000 Transmission Limiter**, answer **NO** to the question (so that the AGC function in the 8200 continues to work). The Orban 4000 is a transmission system overload protection device; it is normally operated below threshold. It is not designed to perform an AGC or gain-riding function, and it cannot substitute for the AGC function in the 8200.

STUDIO CHASSIS YES defeats the 8200’s AGC.



**b**  **PRE-EMPHASIS  $\mu\text{s}$  (included on QUICK SETUP)**

[50 $\mu\text{s}$ ] or [75 $\mu\text{s}$ ]

This controls the pre-emphasis of the internal processing's high-frequency limiters, and the pre-emphasis of the stereo encoder's output. It does not control whether analog left/right outputs are flat or pre-emphasized; they are controlled by A-O FLAT/PRE-E (see step G).

Set this control to the pre-emphasis standard in your country:

75 $\mu\text{s}$	NORTH, CENTRAL, SOUTH AMERICA
50 $\mu\text{s}$	EUROPE, ASIA, AFRICA, PACIFICA EXCEPT
75 $\mu\text{s}$	TAIWAN, KOREA, THAILAND

**c**  **STUDIO METERS ARE (included on QUICK SETUP)**

[VU] or [PPM]

The relationship of program level as indicated on your console's meter to the average level sensing used in the 8200's gain reduction circuits differs between VU meters and PPM meters. This setting compensates for this difference.

**d**  **A-I CLIP LVL dBu (included on QUICK SETUP)**

Analog-Input CLIPPING LeVeL, in two ranges [+5dBu to +27dBu] or [-17dBu to +5dBu], (set by jumpers, see section 2, step 2-C on page 2-7), 0.5dB steps.

This setting calibrates the level at which the 8200's A-D (Analog-to-Digital) converter clips to the absolute maximum peak level that your installation supplies to the 8200's analog input.

This setting maximizes the 8200's signal-to-noise ratio. If the A-I CLIP LVL is set too low, the 8200's analog-to-digital converters will overload and distort on program peaks. If the A-I CLIP LVL is set too high, the signal-to-noise ratio will suffer. Use care and attention in setting this adjustment.

The complete procedure for calibrating A-I CLIP LVL is given in System Setup using QUICK SETUP, step 7, Adjust analog left/right input peak clipping level. See page 2-47.

If you know the maximum peak level that will be presented to the 8200, set the A-I CLIP LVL to about 2dB higher than this level (for safety).

**To verify the correct setting of A-I CLIP LVL with program material:**

From the I / O CALIB screen, press I/O METER to view I/O meters.

Scroll until the METERS INDICATE control appears on line 3 of the screen. Set it to CLIP.

Scroll until the A-I CLIP LVL control appears on line 3 of the screen.

Observe the L and R INPUT meters (the two meters on the left) on a wide range of program material, including live studio voice. The meters should never reach as high as 0dB, which is the level at which the input A-D converter clips. But on the highest peaks, the meters should indicate as high as -3dB.

Be sure to observe the meters on live voice, which tends to have higher level peaks than recorded music.

If necessary, re-adjust the A-I CLIP LVL.

This control has no effect on the AES/EBU digital input.

⊞ □ A-I REF LVL dBu (included on QUICK SETUP)

Analog-Input REFERENCE LeVeL, [-18dBu to +20.5dBu] or [-40dBu to -1.5dBu], jumper-selectable, in 0.5dB steps.

This step sets the center of the 8200's gain reduction range to the level to which your studio operators peak their program material on the studio meters. This assures that the 8200's processing presets will operate in their preferred range.

You may adjust this level with a standard reference/line-up level tone from your studio or with program material.

Note that in this step, we are calibrating to the normal indication of the studio meters; this is quite different from the actual peak level or actual average or RMS level.

A-I REF LVL also calibrates the indication of the L and R INPUT METERS when the METERS INDICATE control is set to CLIP.

If you know the reference VU or PPM level that will be presented to the 8200, set the A-I REF LVL to this level, but do verify it with the steps shown directly below.

The complete procedure for calibrating A-I REF LVL is given in System Setup using QUICK SETUP, step 8, Calibrate the 8200 to your standard studio level. See page 2-50. Use QUICK SETUP for this setting.

**To verify the correct setting of A-I REF LVL with program material:**

If STUDIO CHASSIS was previously set to YES (step 2-A), temporarily reset it to NO.

Press ESC repeatedly until you reach the IDLE G/R screen (the screen with the gain reduction meters).

Observe the AGC gain reduction meter (the left meter) on a wide range of program material, voice and music. It should average between 0 and -15dB.

Also observe the GATE indicator. It should go out when program is present.

If the AGC GAIN REDUCTION meter averages less gain reduction (higher on the meter), or if the GATE indicator stays on when program material is present, go back to the I/O CALIB screen, and re-adjust the A-I REF LVL to a lower level.

If the AGC GAIN REDUCTION meter averages more gain reduction (lower on the meter), go back to the I/O CALIB screen, and re-adjust the A-I REF LVL to a higher level.

When finished, reset STUDIO CHASSIS to YES if required, (e.g., if that was its setting prior to verifying D-I REF LVL).

This control has no effect on the AES/EBU digital input.

⊞ □ A-I BAL CH R dB (not included on QUICK SETUP)

Analog-Input BALANCE CHannel Right, [-3dB to +3dB] on right channel only, 0.1dB steps.

This is not a balance control like those found in consumer audio products. This control changes gain of the right channel only. Use this control if the right analog input to the 8200 is not at exactly the same level as the left

input. Be certain that the imbalance is not from a certain program source, but only through distribution between the console output and 8200 input.

If the meters aren't on the screen, press the I/O METER button to view the left and right input meters while making this adjustment.

**G**  A-O (not included on QUICK SETUP)

Analog-Output, [FLAT] or [PRE-E]

Controls whether the analog left/right outputs produce a FLAT signal, or a PRE-Emphasized signal, following the pre-emphasis set with PRE-EMPHASIS  $\mu$ s (in step B above).

**H**  A-O 100% LVL dBu (not included on QUICK SETUP)

Analog-Output 100% LeVeL, [-6dBu to +24dBu].

Adjusts the analog left/right output level. The level indication on the screen is the maximum peak output level that the processing will produce to modulate the transmitter to 100% peak modulation.

**I**  METERS INDICATE (not included on QUICK SETUP)

[REF] or [CLIP]

Controls whether the left/right input level meters indicate CLIP level or REFERENCE level.

When set to CLIP, 0VU on the 8200's left/right input meters is the clip level of the 8200's input. Use the A-I CLIP LVL control to adjust level so that the program peaks do not exceed 0VU on the meter. See step D, above.

**Setting this control to CLIP is generally preferred in most installations, since it provides a clear warning of overload.**

When set to REF, 0VU on the 8200's left/right input meters is the level set with the A-I REF LVL or D-I REF LVL control, depending on whether the 8200 is selected for analog or digital input (see step E, above). Setting this control to REF is convenient for broadcasting organizations that calibrate levels with line-up tone on a regular basis. **Note that the meters are peak-indicating; you cannot use them to adjust A-I REF LVL on program, only on tone. On program, they will usually read full-scale.**

**J**  OSHOOT TX1 COMP % (not included on QUICK SETUP)

OverSHOOT TranXmitter 1 COMPensation, [-20% to 0%], 0.5% steps.

Many composite STLs and FM exciters exhibit overshoot due to inadequate low frequency response in the transmitter's AFC circuit (See Section 1, page 1-11 and 1-13). Overshoot will be evident if, after adjusting the modulation using the 8200's 100% calibration tone, program material modulates the transmitter more than 100%.

OSHOOT TX1 COMP reduces *program* modulation on both the analog and (optional) digital output by the percentage programmed when the REMOTE INTERFACE is activated (see page 2-74). This control does not reduce the on-air modulation of the pilot tone or the 8200's 100% calibration tone. This way, you can still use the 8200's line-up tone to adjust the steady-state deviation to  $\pm 75$ kHz. Yet the reduced peak level of the audio emitted from the 8200 ensures that the carrier deviates no further than  $\pm 75$ kHz, including overshoot.

[Note that this feature was designed to compensate for main and standby transmitters, so *both* COMPOSITE OUTPUT 1 and COMPOSITE OUTPUT 2 are affected by *either* transmitter overshoot compensation. You cannot have simultaneous, different compensations on COMPOSITE OUTPUT 1 and COMPOSITE OUTPUT 2. Ordinarily, only one transmitter (main or standby) is on the air, so this causes no problem. If both OSHOOT1 and OSHOOT2 are selected in the REMOTE INTERFACE, the 8200 will reduce level to the higher of the two settings. Remember this when calibrating modulation of the *other* exciter.]

κ □ OSHOOT TX2 COMP % (not included on QUICK SETUP)

OverSHOOT TranXmitter 2 COMPensation, [-20% to 0%], 0.5% steps.

This control reduces *program* modulation on both COMPOSITE OUTPUT 1 and COMPOSITE OUTPUT 2 by the indicated percentage, without reducing the on-air modulation of the pilot tone and the 8200's 100% calibration tone. See step J, above.

λ □ SC1 MOD COMP % (not included on QUICK SETUP)

SubCarrier 1 MODulation COMPensation, [-20% to 0%], 0.5% steps

In many countries, when additional subcarriers (SCAs) are used, modulation of the main and stereo channel must be reduced to limit *total modulation* of the entire composite baseband to a required amount.

SC1 MOD COMP reduces *program* modulation on both the analog and (optional) digital output by the percentage programmed when the REMOTE INTERFACE is activated (see page 2-74). This control does not reduce the on-air modulation of the pilot tone, the subcarrier, or the 8200's 100% calibration tone. This way, you can still use the 8200's line-up tone to adjust the steady-state deviation to  $\pm 75\text{kHz}$ . Yet the reduced peak level of the audio emitted from the 8200 ensures that the carrier deviates no further than  $\pm 75\text{kHz}$ , including overshoot.

[Note that if both SC1 and SC2 are selected in the REMOTE INTERFACE, the 8200 will reduce level by the sum of the two settings.]

μ □ SC2 MOD COMP % (not included on QUICK SETUP)

SubCarrier 2 MODulation COMPensation, [-20% to 0%], 0.5% steps.

See step L, above.

ν □ MODULATION TYPE (not included on QUICK SETUP)

[MONOL], [MONOR], or [STEREO]

This controls sets the 8200 for mono or stereo operation.

MONOL (MONO FROM LEFT) switches the 8200's stereo encoder off, using the left input as the program source.

MONOR (MONO FROM RIGHT) switches the 8200's stereo encoder off, using the right input as the program source.

STEREO switches the 8200's stereo encoder on.

ο □ PILOT ON/OFF (not included on QUICK SETUP)

[ON] or [OFF]

This control turns the 8200's 19kHz stereo pilot tone On or Off.

Adjust pilot level on the stereo encoder with the screwdriver-adjustable control on the front panel.

**CLOCK SYNC TO** (not included on QUICK SETUP)

[LINE] or [XTAL]

LINE synchronizes the 8200's real-time clock to the AC line frequency.

XTAL synchronizes the 8200's real-time clock to the internal crystal oscillator.

**Note:** During power outages the battery maintains the clock update cycles in both modes of synchronization.

**MODEM BAUD RATE** (not included on QUICK SETUP)

[2400], [4800] or [9600]

The MODEM BAUD RATE sets the data transfer rate between the 8200 and either an IBM PC or modem.

Skip this step if you are not running 8200 PC Remote Control software.

The 8200 is fully remote-controllable from an RS-232/RS-422 serial port (for computer or modem interface). Orban's 8200 PC Remote Control software for IBM PC compatibles permits you to adjust any 8200 preset by remote control, or to do most anything else that you can do from the 8200's front panel. (Refer to the 8200 PC Operating Manual.)

You can connect to the RS-232 connector any modem designed to interface with an IBM or compatible PC. You can also establish connection between the 8200 and an IBM PC or compatible by connecting the PC's COM port to the 8200's RS-232 port through a null modem cable.

If OPTIMOD 8200 is connected to a computer, via modems, set MODEM BAUD RATE to the highest rate your modems are capable of supporting. (Refer to the manual that came with each modem.)

If OPTIMOD 8200 is connected directly to a computer, choose 9600.

Refer to the 8200 PC Manual, included with your 8200 Operation Manual, for additional information.

**INPUT-A or D** (not included on QUICK SETUP)

[ANALOG] or [DIGITL]

This sets the analog inputs or the AES/EBU digital input as the audio source. If the Digital I/O Card is not fitted, or if no digital source is present, the 8200 will automatically use the analog input as its source and this selection will not appear.

**Note:** If a Digital I/O Card is installed in your 8200, additional I/O CALIB parameters are listed. Refer to your Digital I/O Installation Instructions.

**D-I REF-PK LVL dB** (not included on QUICK SETUP)

Digital-Input REFerence LeVeL, [-20dBu to 0dBu], in 0.5dB steps.

This setting is similar to the A-I REF LVL, except for the digital input.

If you know the reference VU or PPM level that will be presented to the 8200 (in dB below the maximum digital word), set A-I REF LVL to this level.

**To verify the correct setting of D-I REF LVL with program material:**

Be sure that a digital input is present at the 8200's AES/EBU connector.

Be sure that the 8200 is switched to DIGITAL INPUT either via the I/O CALIB screen's INPUT-A or D setting, or via the REMOTE CONTROL INTERFACES ID INPUT DIGITAL switch.

If STUDIO CHASSIS was previously set to YES (step 2-A), temporarily reset it to NO.

Press ESC repeatedly until you reach the IDLE G/R screen (the screen with the gain reduction meters).

Press I/O METER. On line 3 of the screen, you should see DIGITAL IN.

Press G/R METER.

Observe the AGC gain reduction meter (the left meter) on a wide range of program material, voice and music. It should average between -10dB and -15dB.

Also observe the GATE indicator. It should go out when program exceeds a threshold.

If the AGC GAIN REDUCTION meter averages less gain reduction (higher on the meter), or if the GATE indicator stays on when program material is present, go back to the I/O CALIB screen, and re-adjust the D-I REF LVL to a lower level.

If the AGC GAIN REDUCTION meter averages more gain reduction (lower on the meter), go back to the I/O CALIB screen, and re-adjust the D-I REF LVL to a higher level.

When finished, reset STUDIO CHASSIS to YES if required, (e.g., if that was its setting prior to verifying D-I REF LVL).

### 3. Adjust EBS Test Settings.

*[Skip this step if your country does not use the EBS test.]*

Press MODIFY EBS button to access MODIFY EBS screen and adjust EBS TEST settings, as required.

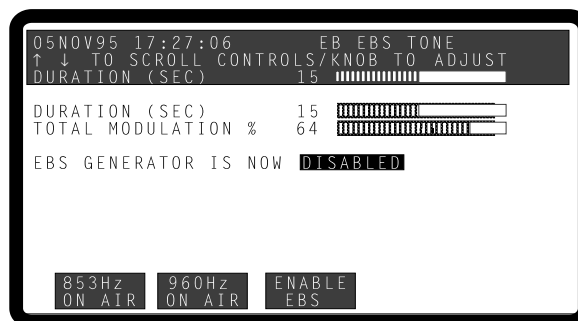

A  DURATION SECS

*The setting of DURATION will not put the EBS TONES on the air.*

Set the duration that the EBS tones will be on the air when the EBS TEST is initiated from the RECALL PRESET screen. Consult the latest issue of the applicable rules and regulations for the minimum duration required by law. At the date of publication of this manual, the FCC required a minimum duration of 20 seconds and a maximum duration of 25 seconds for actual EBS alerts. EBS tests can be as short as 8 seconds.

B  TOTAL MODULATION %

*The setting of TOTAL MODULATION % will not put the EBS TONES on the air.*

Set the total modulation that the two tones will produce.

C  853Hz ON AIR  
960Hz ON AIR

**WARNING:** *Pressing either of these buttons will put a tone on the air.*

The FCC requires that you be able to put each of the two tones on the air independently to assure that each is modulating to the proper level. Consult the latest issue of the applicable rules and regulations for the minimum modulation level required by law. At the date of publication of this manual, the FCC required a minimum modulation of 40% on each tone.

Press the button again to turn the tone off.

D  ENABLE EBS  
DIABLE EBS

Press ENABLE EBS button to provide access to the EBS tone from the RECALL PRESET screen.

Press DISABLE EBS button to deny access. The EBS tone will no longer appear in the RECALL PRESET screen. Note, however, that the EBS tone can still be accessed via remote control interface.

#### 4. Set Modem Initialization String.

*[Skip this step if you are not using 8200 PC Remote Control software.]*

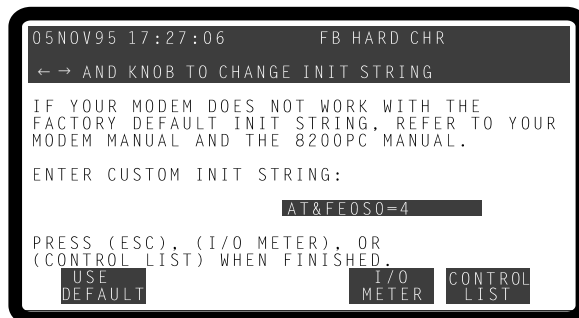
A  Press MODEM INIT button to access MODEM INIT screen.

USE DEFAULT [AT&FE0S0=4] or Adjustable [16cASCII Field]

Always begin by choosing USE DEFAULT.

To verify the MODEM INIT string, complete the 8200PC hardware and installation steps (refer to 8200 PC Operation Manual), then proceed:

With the modem connected to the 8200 (modem plugged into the 8200's RS-232 connector) its AA light comes on within 10 seconds and stays on. If the AA light doesn't come on and/or the received data light (often labeled RD or RX), flashes at regular intervals, something is wrong with the init string.

In this case, reset the MODEM INIT string for the following parameters: recall factory preset, echo off, and auto-answer (Refer to the modem's manual).

If the modem init string is set correctly, and 8200PC and the OPTIMOD-FM 8200 still do not negotiate successfully, make sure the modem is set for V.42 operation only.

**5. End I/O CALIB programming.**

- A  When you are finished adjusting input/output parameters, press the ESC button to return to the SYSTEM SETUP screen. Press the ESC button again to return to the IDLE G/R screen.

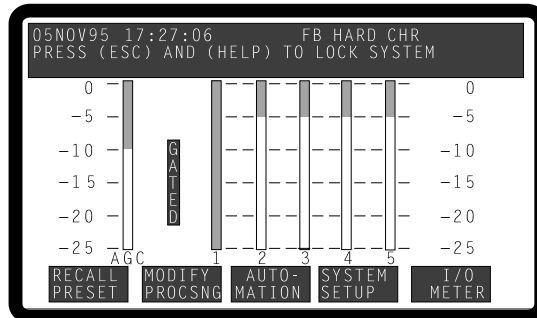



## Time and Date

*Skip this step if you set the time and date in QUICK SETUP and you do not want to change the current settings (as shown on the top line of every screen).*

### 1. Access TIME+ DATE screen.

- A If the IDLE G/R screen (shown below) does not appear, press ESC repeatedly until you see it.

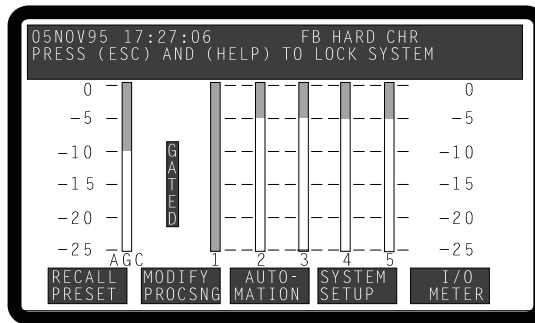

Use the CONTRAST knob to adjust the display for best clarity.

- B Press SYSTEM SETUP button to access SYSTEM SETUP screen. (Press the soft key directly below the words "SYSTEM SETUP.")

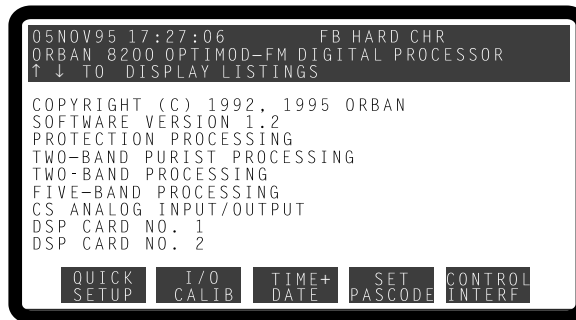

- C Press TIME+ DATE button to access TIME+ DATE screen.  
See next page.



**2. Set time and date.**

- A  Use the ↑, ↓, ← and → arrow keys to scroll through and select (highlight) the time and date settings. Use the front panel control knob to change values.

[24H] or [12H]

The 8200's internal clock is displayed on the top line of the screen, and is used for programmed preset switching using the 8200's built-in AUTOMATION. It can be set for 12 hour (AM and PM) or 24 hour time.

Use the knob to set the 8200 screen display for 12 hour or 24 hour time, then press ENTER CHANGE to initialize the clock. Then return to the TIME+ DATE screen to set the remaining parameters.

- B  TIME

[HRS]:[MINS]:[SECS]

The internal clock is reset to the values entered on the screen when the ENTER CHANGE button is pressed.

- C  DATE

DAY: [01] to [31]

MONTH: [JAN], [FEB], [MAR], [APR], [MAY], [JUN], [JUL], [AUG], [SEP], [OCT], [NOV] or [DEC]

YEAR: [00] to [99]

- D  DAY OF THE WEEK

[SUN], [MON], [TUE], [WED], [THU], [FRI] or [SAT]

- E  DAYLIGHT TIME BEGINS

[OFF], [1ST], [2ND], [3RD], [4TH] or [LAST] WEEK

MONTH: [JAN], [FEB] . . . or [DEC]

If your country uses Daylight Savings Time (Summer Time), the 8200's clock will advance the time one hour on the beginning date that you enter, and turn back the time one hour on the end date that you enter.

Use the ↑, ↓, ← and → arrow keys to scroll through and select (highlight) the parameters. Use the control knob to change values. If your country does not use Daylight Savings Time, set the — WEEK field to OFF.

Page 2-44 lists current rules for daylight savings time for selected countries.

**NOTE:** Both Daylight Begin and End times must be entered to initiate the daylight time program.

**F** DAYLIGHT TIME ENDS

[OFF], [1ST], [2ND], [3RD], [4TH] or [LAST] WEEK  
MONTH: [JAN], [FEB] . . . or [DEC]

**NOTE:** Both Daylight Begin and End times must be entered to initiate the daylight time program.

**G** TIME TO SCREEN SAVER

[1] to [8] HRS

The screen saver automatically turns off the screen backlight after the 8200 front panel controls have not been operated during the period of time set by this control. We strongly recommend that you use the screen saver, as the lifetime of the screen backlighting is about five years. With screen saver, it will last far longer.

The screen backlighting turns on when any button is activated.

### 3. End time and date programming.

- A** When you are finished adjusting time and date parameters, press the ENTER CHANGE button to save changes or press the ESC button to ignore changes. Either action will return you to the SYSTEM SETUP screen.
- B** Press the ESC button again to return to the IDLE G/R screen.

# Security and Pascode Programming

*[Skip this step if you do not wish to change the security level or program pascodes at this time.]*

## 1. Access SET PASCODE screen.

- A  If the IDLE G/R screen (shown below) does not appear, press ESC repeatedly until you see it.

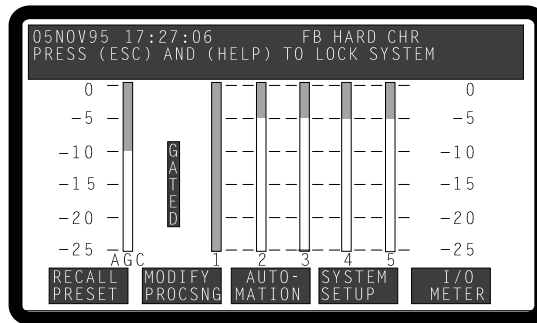

Use the CONTRAST knob to adjust the display for best clarity.

- B  Press SYSTEM SETUP button to access SYSTEM SETUP screen. (Press the soft key directly below the words “SYSTEM SETUP.”)

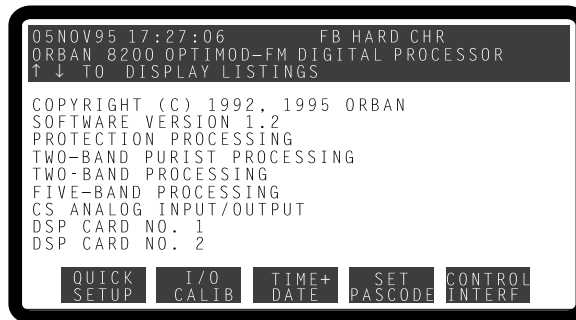

- C  Press SET PASCODE button to access SET PASCODE screen.



## 2. Set the security status of the 8200.

All of the settings on this screen determine whether pascodes are required to access the various functions listed. If a function is listed as NO, the function can be accessed and changed from the front panel without the user having to enter a pascode. If a function is listed as YES, the user must first enter a pascode, and that pascode must be previously programmed to permit access to that function.

When a pascode is entered, only those functions that are permitted by that pascode are displayed on the screen.

Use the ↑ and ↓ arrow keys to scroll through and select (highlight) the settings. Use the front panel control knob to change the setting.

### A RECALL PRESET

[NO] or [YES]

Selects whether a pascode (authorized to RECALL PRESET) is required to recall processing presets.

### B RECALL TEST PRESETS

[NO] or [YES]

Selects whether a pascode (authorized to RECALL TEST PRESETS) is required to recall test presets, such as TO USER TONE and BY BYPASS.

EBS (Emergency Broadcasting System) can be accessed at all times, with or without a pascode.

**NOTE:** If the security status is set so that a pascode is required to recall test presets, and if a test preset has been stored as a user preset, it will be locked out to users not authorized to recall test presets.

### C MODIFY PROCSNG

[NO] or [YES]

Selects whether a pascode (authorized to MODIFY PROCSNG) is required to modify the processing (change the sound of the station) and save those changes to a user preset.

D OBSERVE METERS AND PRESET NAME

[NO] or [YES]

Selects whether a pascode (authorized to OBSERVE METERS AND PRESET NAME) is required to display the metering on the screen. Some stations may wish to restrict meter display from the screen so that their “setup” cannot be copied by another station with a co-located transmitter.

E PROGRAM AUTOMATION

[NO] or [YES]

Selects whether a pascode (authorized to PROGRAM AUTOMATION) is required to change the automation event schedule.

F PROGRAM SYSTEM SETUP

[NO] or [YES]

Selects whether a pascode (authorized to change SYSTEM SETUP) is required to access QUICK SETUP, I/O CALIB, TIME+ DATE and CONTROL INTERF. Note that a pascode authorized for SYSTEM SETUP will automatically be given access to all other functions (except PROGRAM SET PASCODE), even if that pascode is not programmed for those other functions.

G PROGRAM SET PASCODE

[NO] or [YES]

Selects whether a pascode (authorized to PROGRAM SET PASCODE) is required to access SET PASCODE. Note that open access to SET PASCODE gives any user the ability to re-program the security level of the system, and program pascodes.

**NOTE:** A pascode authorized for SET PASCODE will automatically be given access to all other functions, as seen on the screen

H TIMEOUT TO AUTO LOCK, HRS:MINS

[00:10] to [08:50] or [OFF]

Timeout automatically locks the system after the period of time set by this control. We strongly recommend that you set timeout to a reasonable time, so that if the 8200 is left unattended, it will lock itself.

Use the < and > keys to toggle between HRS and MINS.

### 3. Assign pascodes.

*If you do not wish to program pascodes at this time, press the ESC button to return to the SYSTEM SETUP screen. Press the ESC button again to return to the IDLE G/R screen.*

- A  From the SET PASCODE screen, press the ASSIGN PASCODE button.

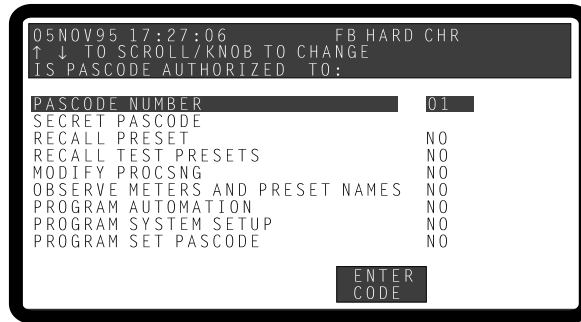

The 8200 allows you to program up to 10 pascodes. Each pascode can be programmed to allow or deny access to the various functions listed.

This screen is used to program each pascode.

PASCODE NUMBER is used to select which of the 10 pascodes you will program.

The rest of the lines show the functions that the pascode is or is not allowed to access. Note that if in the previous step (step 2), you programmed that a pascode is not required for a given function, the user will be allowed access to that function, even if the pascode is programmed NO for that function in this step.

Use the ↑ and ↓ arrow keys to scroll through and select (highlight) the settings. Use the front panel control knob to change the setting.

- B  PASCODE NUMBER

[1] to [10]

Selects which pascode to program. As this number is changed, the other fields will change to reflect the authorization of that code.

- C  SECRET PASCODE

[0] to [99999999]

Allows you to program up to ten secret pascodes, each with one to eight digits.

- D  RECALL PRESET

[NO] or [YES]

Selects whether this pascode (PASCODE NUMBER displayed on the screen) is authorized to recall processing presets.

E  RECALL TEST PRESETS

[NO] or [YES]

Selects whether this pascode (PASCODE NUMBER displayed on the screen) is authorized to recall test presets. EBS (Emergency Broadcasting System) PRESET EB can be accessed at all times, with or without a pascode.

F  MODIFY PROCSNG

[NO] or [YES]

Selects whether this pascode (PASCODE NUMBER displayed on the screen) is authorized to modify the processing (change the sound of the station) and save those changes to a user preset.

G  OBSERVE METERS AND PRESET NAME

[NO] or [YES]

Selects whether this pascode (PASCODE NUMBER displayed on the screen) is authorized to observe meters and preset name.

H  PROGRAM AUTOMATION

[NO] or [YES]

Selects whether this pascode (PASCODE NUMBER displayed on the screen) is authorized to change the automation event schedule.

I  PROGRAM SYSTEM SETUP

[NO] or [YES]

Selects whether this pascode (PASCODE NUMBER displayed on the screen) is authorized to access QUICK SETUP, I/O CALIB, TIME+DATE and CONTROL INTERF. Note that a pascode authorized for system setup will automatically be given access to all other functions (except program set pascode), even if that pascode is not programmed for those other functions.

J  PROGRAM SET PASCODE

[NO] or [YES]

Selects whether a pascode (authorized to PROGRAM SET PASCODE) is required to access SET PASCODE. Note that open access to SET PASCODE gives any user the ability to re-program the security level of the system, and program pascodes.

**NOTE:** At least one of the ten pascodes must be authorized to program set pascode. This user has ultimate control of the 8200's security, and the unit will not lock until this requirement is fulfilled.



- κ □ Push the ENTER CODE button. This screen is used to enter the secret pascode.

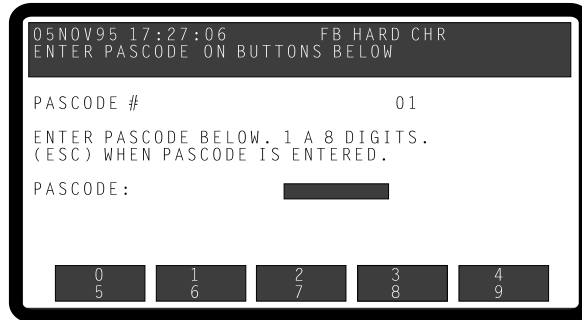

- λ □ Enter the desired pascode, up to eight digits. If the pascode is less than 8 digits, you must press ESC to store the entered pascode and return to the previous screen.

If you enter an undesired code, press the ENTER CODE button from the SET PASCODE screen to access the ENTER PASCODE screen. Then enter the desired code and press ESC to save.

Note that if a pascode has been previously entered, and you do not push any of the number buttons below the screen, the previously entered pascode will remain valid.

#### 4. Program additional pascodes.

Repeat step 3 above for additional codes.

#### 5. End pascode programming.

- A □ When you are finished programming pascodes, press the ESC button to return to the SYSTEM SETUP screen.
- B □ Press the ESC button again to return to the IDLE G/R screen.
- c □ To initiate lockout, hold down ESC button while pressing HELP button.

# Remote Control Interface Programming

*[Skip this step if you do not wish to program the remote control interface at this time.]*

**1. Access CONTROL INTERF screen.**

- A  If the IDLE G/R screen does not appear, press ESC repeatedly until you see it.

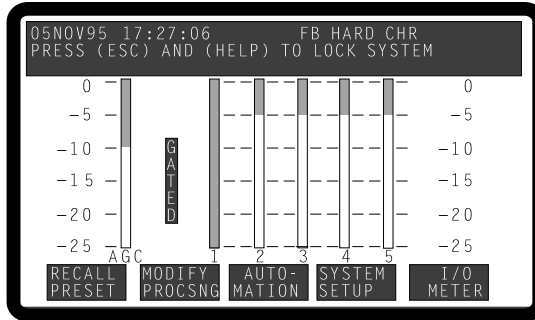

Use the CONTRAST knob to adjust the display for best clarity.

- B  Press SYSTEM SETUP button to access SYSTEM SETUP screen. (Press the soft key directly below the words "SYSTEM SETUP".)

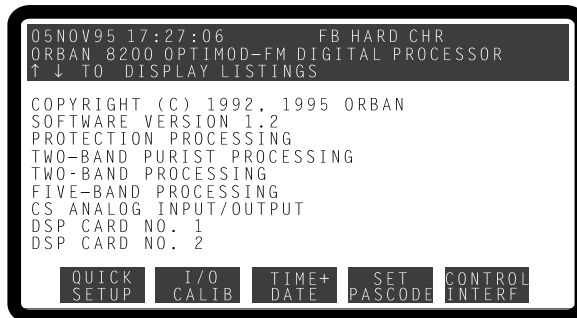

- C  Press CONTROL INTERF button to access CONTROL INTERFACE screen.

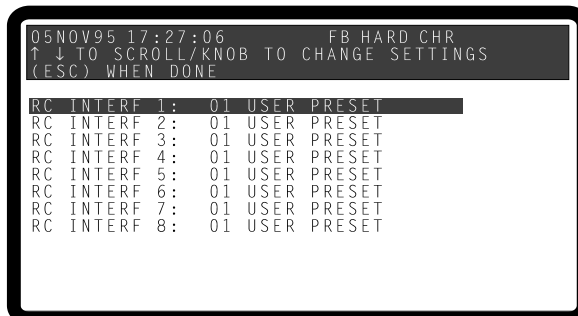

## 2. Program the remote control interface.

The control interface is eight opto-isolated inputs that allow you to direct the 8200 to perform certain functions when a voltage (6-24V) is presented to the input.

This screen is used to program the function of each of the eight control interfaces.

Use the ↑ and ↓ arrow keys to scroll through and select (highlight) each interface. Use the front panel control knob to change the function of that interface. As you turn the control knob, the following functions will appear in the selected (highlighted) field:

**## PRESET NUMBER AND NAME:** Switches that preset on the air. Any test preset, factory or user programming preset may be recalled by the control interface. A momentary pulse of voltage will switch this function.

**ST STEREO:** Switches the 8200's stereo encoder on. A momentary pulse of voltage will switch this function.

**ML MONO FROM LEFT:** Switches the 8200's stereo encoder off, using the left input as the program source. A momentary pulse of voltage will switch this function.

**MR MONO FROM RIGHT:** Switches the 8200's stereo encoder off, using the right input as the program source. A momentary pulse of voltage will switch this function.

**ET EXIT TEST:** If a test preset is switched on the air, EXIT TEST reverts to the previous processing preset.

**01 OSHOOT TX1 COMP:** Reduces the program modulation by the percentage programmed in I/O CALIB. When voltage is removed, this function will be deactivated.

**02 OSHOOT TX2 COMP:** Reduces the program modulation by the percentage programmed in I/O CALIB. When voltage is removed, this function will be deactivated.

**S1 SC1 MOD COMP:** Reduces the program modulation by the percentage programmed in I/O CALIB. When voltage is removed, this function will be deactivated.

**S2 SC2 MOD COMP:** Reduces the program modulation by the percentage programmed in I/O CALIB. When voltage is removed, this function will be deactivated.

**IA INPUT ANALOG:** Selects the analog inputs as the audio source. A momentary pulse of voltage will switch this function.

**ID INPUT DIGITAL:** Selects the AES/EBU digital input as the audio source. A momentary pulse of voltage will switch this function.

**RH RST CLK TO HOUR:** Resets the internal clock to the nearest hour. For example, 3:03:10 would be reset to 3:00:00, while 3:53:10 would be reset to 4:00:00. (NOTE: Times of 20 minutes after the hour thru 20 minutes to the hour are not affected by this function.) A momentary pulse of voltage will switch this function on the leading edge of the pulse.

**RM RST CLOCK 00:00:00:** Resets the internal clock to midnight. In 12 hour time, this is shown as 12:00:00A; in 24 hour time, this is shown as 00:00:00. A momentary pulse of voltage will switch this function on the leading edge of the pulse.

### 3. End remote control interface programming.

- A  When you are finished programming the remote control interface, press the ESC button to return to the SYSTEM SETUP screen.
- B  Press the ESC button again to return to the IDLE G/R screen.