

SYNTHESIZER

SH-1 SERVICE NOTES

CONTENTS

SPECIFICATIONS	1
DISASSEMBLY	2
CIRCUIT DESCRIPTION	3
BLOCK DIAGRAM	4
KCV PCB	5
KCV CIRCUIT	6
VCO PCB	7
VCO CIRCUIT	8
VCF/VCA PCB	9
VCF/VCA CIRCUIT	10
POWER SUPPLY - PSH-26/27/34	11
ADJUSTMENT	12
PARTS	17
PARTS LIST	19
KEYBOARD PARTS	

SPECIFICATIONS

- KEYBOARD.....32 keys, 2-1/2 Octaves
- VCO (Voltage Controlled Oscillator)
 - Modulator
 - Autobend Depth
 - Autobend Time (8msec-360msec)
 - VCO Range (32', 16', 8', 4', 2')
 - Waveform (/ , □ , ▭)
 - Pulsewidth Modulation (5%-50%)
 - PWM Mode Switch (ENV-1/Manual/LFO)
- SUB OSC (Sub-oscillator)
 - 1 OCT DOWN □ / 2 OCT DOWN □ / 2 OCT DOWN □
- NOISE GENERATOR
 - White/Pink Selector
- AUDIO MIXER
 - VCO/SUB OSC/NOISE/EXT SIG
 - Overload Indicator (EXT SIG)
- HPF (High Pass Filter)
 - Cutoff Frequency Control (25Hz-5KHz)
- VCF (Voltage Controlled Filter)
 - Cutoff Frequency Control (5Hz-20KHz)
 - Resonance (Min-Self Oscillation)
 - ENV-1 Polarity Switch (/ ~ /)
 - ENV-1 Control
 - MOD Control
 - KYBD Control
 - EXT SIG ENV FOL'R Control
- VCA (Voltage Controlled Amplifier)
 - Hold Control
 - Envelope Switch (ENV-1/ENV-2)
- ENVELOPE GENERATOR
 - ENV-1
 - Attack Time (1.5msec-2.5sec)
 - Decay Time (1.5msec-8sec)
 - Sustain Level (0-100%)
 - Release Time (1.5msec-8sec)
 - Gate Trigger Selector Switch (Gate+Trig/Gate/LFO)
 - ENV-2
 - Attack Time (1.5msec-3sec)
 - Release Time (1.5msec-8sec)
 - Gate Selector Switch (Gate/LFO)
- MODULATOR
 - Modulation Mode Switch (Random/□, / ~)
 - Rate (0.2Hz-25Hz)
 - Delay Time (0-3sec)
 - Rate Indicator
- KYBD/EXT CV GATE SWITCH
- TUNING (±700 cents)
- PORTAMENTO (0-2.5sec)
- VOLUME
- TRANPOSE SWITCH (L/M/H)
- BENDER
 - Bender Lever (-35° - +35°)
 - Bender Sensitivity (VCO, VCF)
- POWER SWITCH
 - Power Indicator
- CONNECTION JACKS
 - Output Jack
 - Output Level Switch (L/M/H) (standard -20dBm/-8dBm/+4dBm)
 - Phones Jack (8Ω, stereo)
 - Phones Output Level Switch (L=-30dBm/M=-23dBm/H=-18dBm)
 - External Signal Jack
 - External Signal Level Switch (L/M/H) (standard 0dBm/-20dBm/-40dBm)
 - External Control Voltage Input Jack (1V/oct)
 - External Gate Voltage Input Jack (ON with +7.5V or over)
 - Keyboard Control Voltage Output Jack (F1=1.417V, C3=4.000V, 1V/oct)
 - Keyboard Gate Output Jack (OFF - 0V, ON - +14V)
- GENERAL
 - Power Consumption.....10W
 - Dimensions.....610(W) x 370(D) x 135(H)mm
24(W) x 14.6(D) x 5.3(H)in
 - Weight.....6.4kg, 14.1 lbs
 - Accessory.....2.5m connection cord

DISASSEMBLY

Be sure to keep the power plug
off from the outlet.

To open the top cover, remove
five screws (A1 - A5) at the
bottom of the unit.

A1, 3-5: Bind 3x12 Br
A2: Bind 3x6 FeBr

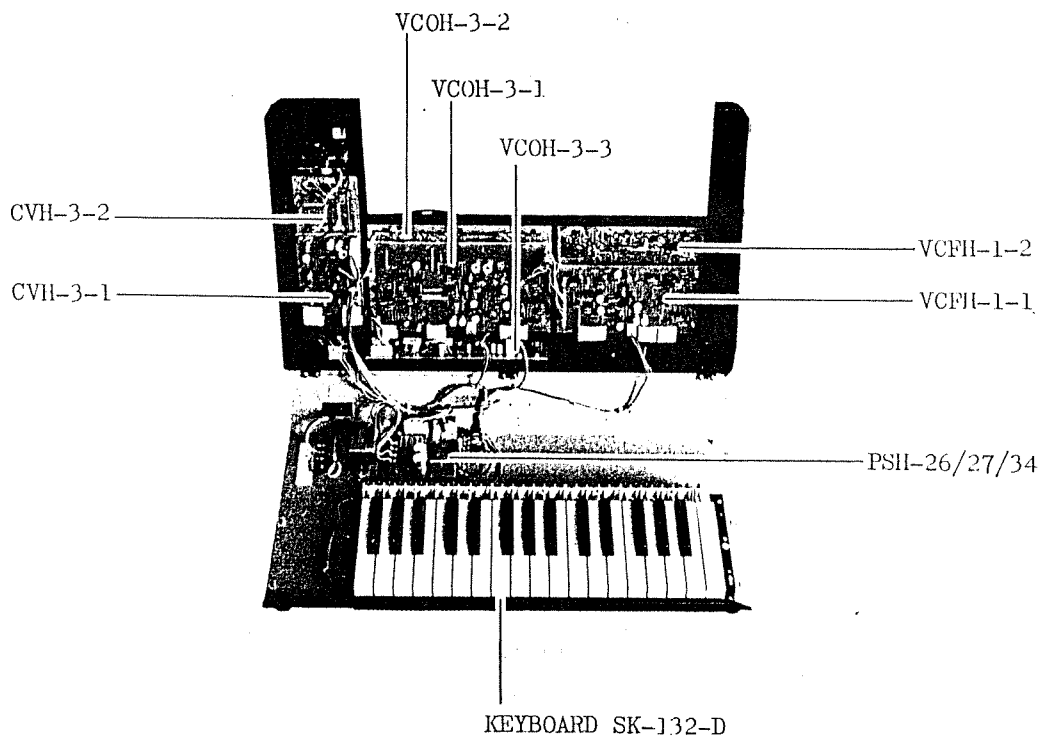
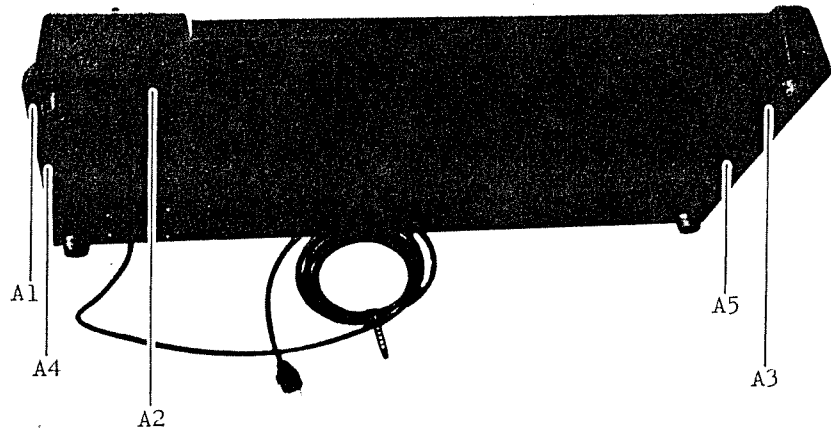

CIRCUIT DESCRIPTION

1. KCV BOARD ASSEMBLY (CVH-3)

1. 1. The current from the constant current source is fed to the resistor chain of 31 resistors connected in series. When a key is depressed, the key voltage develops at the corresponding resistor. (When two keys are depressed, lower key voltage is taken.) The voltage is held by the capacitor in the S & H circuit after the key is released.

The voltage is sent to the portamento circuit. Portamento effect is added by the CR circuit (portamento control pot and the above-mentioned capacitor). The portamento time is varied by changing the time constant with the portamento control.

1. 2. When a lower key is depressed or released while one or more higher keys are held down, the change in the key voltages is detected and differentiated to generate a pulse, which triggers the envelope generator, during legato keying.

1. 3. Bender circuit output voltage can be varied by moving the bender lever, smoothly changing pitch and tone color. The control voltages that are distributed to VCO and VCF can be varied by Sensitivity sliders.

2. VCO BOARD ASSEMBLY (VCOH-3)

2. 1. The VCO is a highly stable and precise oscillator whose frequency is controlled by KCV or EXT CV. Linear voltage at KCV or EXT CV is converted by the exponential convertor to exponential current, which generates sawtooth wave. The sawtooth wave is changed to square waves, too, by waveform convertor. One is the 50% square wave and the other is the square wave whose pulse width is modulated by LFO, ENV-1 or MANUAL.

To produce sub-oscillator sound, the square wave frequency is divided into 1/2 or 1/4 by dividers. The two resulting square waves are combined to produce the third wave. Thus three waves are obtained and one wave selected is applied to Mixer as one of the sound sources.

2. 2. The LFO is a modulating signal oscillator which generates triangular, square and sine waves of low frequencies. Besides, random note is generated by sampling and holding noise signal with LFO frequency. The sine wave only is affected by Delay Time control.

2. 3. Noise is generated from reversely biased base-emitter junction of a transistor. The noise is amplified to the required level and passed through a filter where it is converted to white or pink noise. The resulting noise is used to obtain various effects sounds.

2. 4. The Autobend is a voltage generator which is triggered with GATE+TRIG pulse and has DEPTH and DELAY TIME controls. A resulting voltage envelope controls the VCO.

2. 5. The overload indicator (LED) lights when the external signal level is excessively high.
2. 6. The Mixer has VCO, SUB-OSC, NOISE, and EXT SIG controls.
2. 7. The Envelope Follower integrates external signals to make the voltage envelope. This is used to control the VCF, causing wah effects.
2. 8. The Headphones amplifier is a Class A amplifier that uses an output transformer.
3. VCF/VCA BOARD ASSEMBLY (VCFH-1)
 3. 1. The VCF is a voltage-controlled low pass filter. It comprises the 4-stage Operational Transconductance Amplifier circuits, in which the outoff frequency varies in proportion to the bias current. When Resonance control is raised up beyond a predetermined position, it provides a feed back necessary to start and sustain oscillation.
 3. 2. The VCA is an amplifier whose gain is controlled by the control voltage from ENV-1 or ENV-2.
 3. 3. The ENV-1 is triggered with GATE+TRIG, GATE, and LFO signals. The ENV-1 generates the control voltage which varies with time according to the four control settings: Attack Time, Decay Time, Sustain Level, and Release Time. The resulting voltage envelope is used to control the VCO (FWM), VCF, and VCA.
 3. 4. The ENV-2 is triggered with GATE and LFO signals. The ENV-2 has two control settings: Attack Time and Release Time. The resulting voltage envelope is used to control the VCA.
4. POWER SUPPLY BOARD ASSEMBLY (PSH-26, PSH-34, PSH-27)

Provides regulated, stable +15V and -15V.
PSH-26 (AC 100V), PSH-34 (AC 117V), or PSH-27 (AC 220/240V) is used.

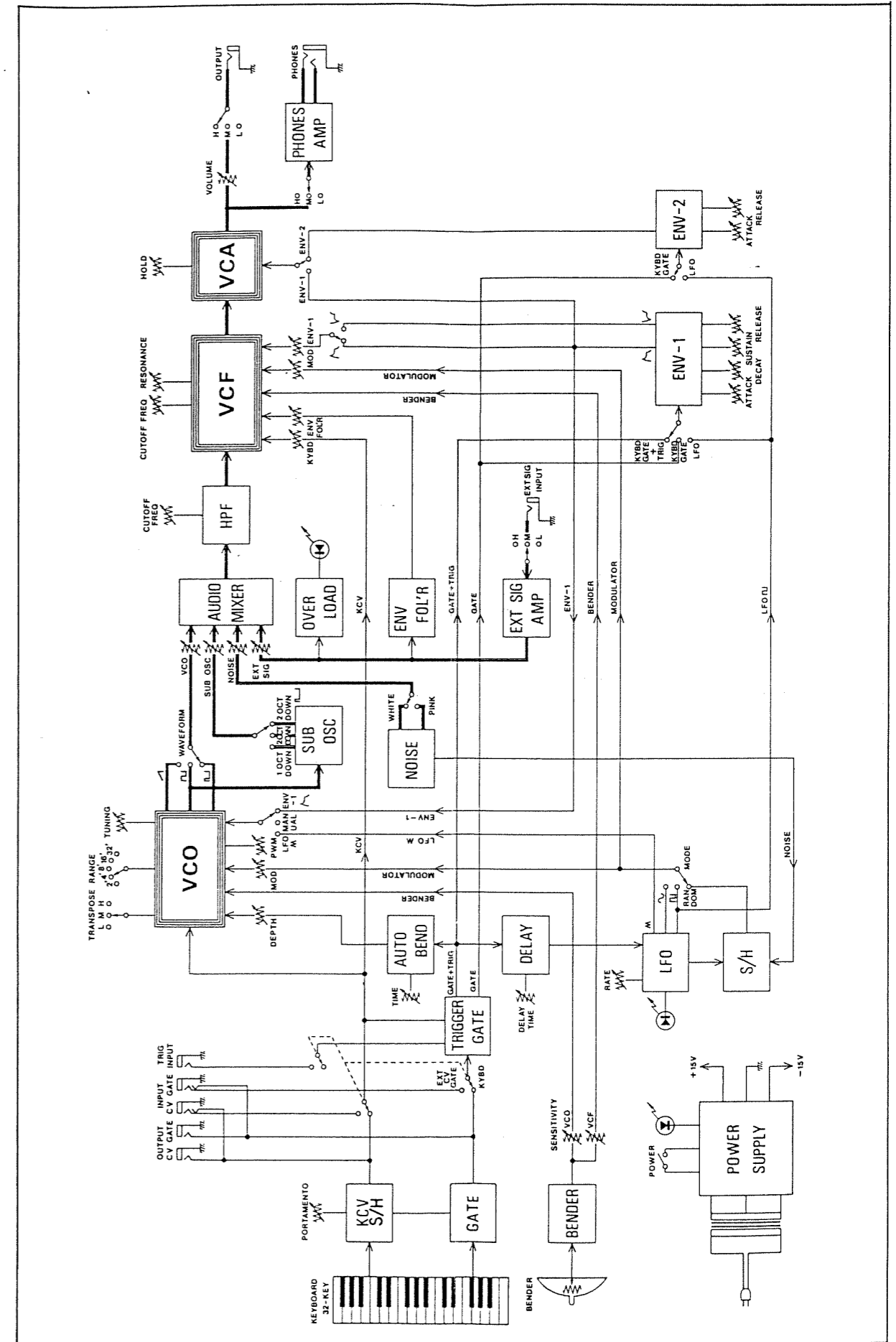

CVH-3A-1 (SERIAL NO. UP TO 700499)

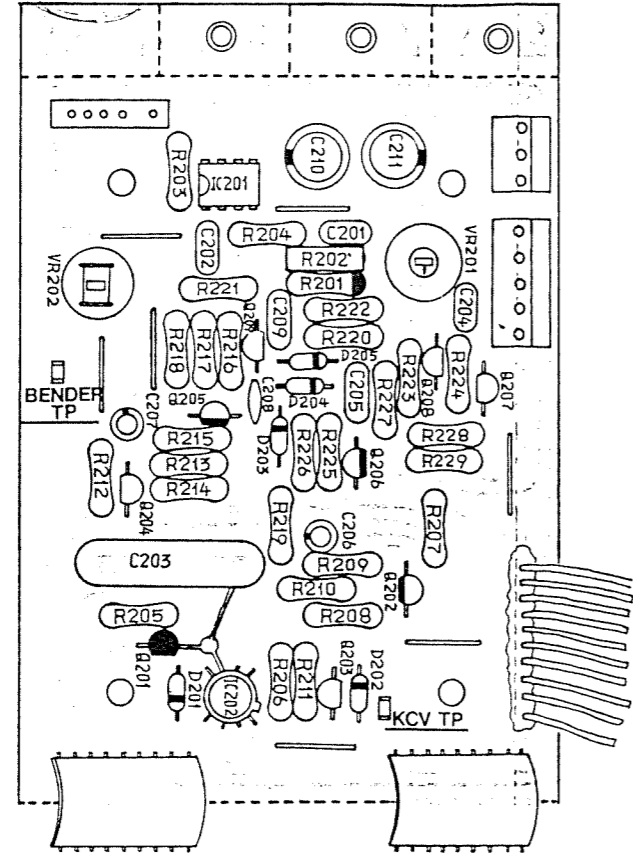

CVH-3A-1 - PARTS ON THE FOIL SIDE

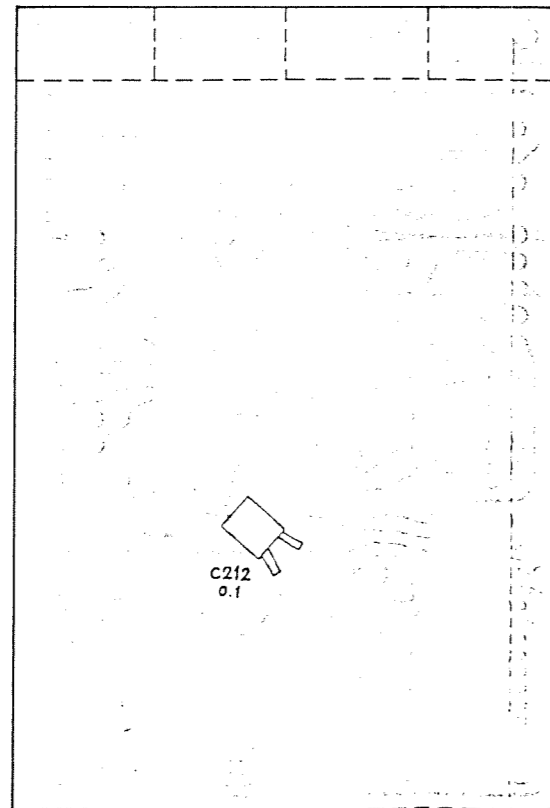

CVH-3B-1 (SERIAL NO. 700500 AND HIGHER) (159H003B-1)

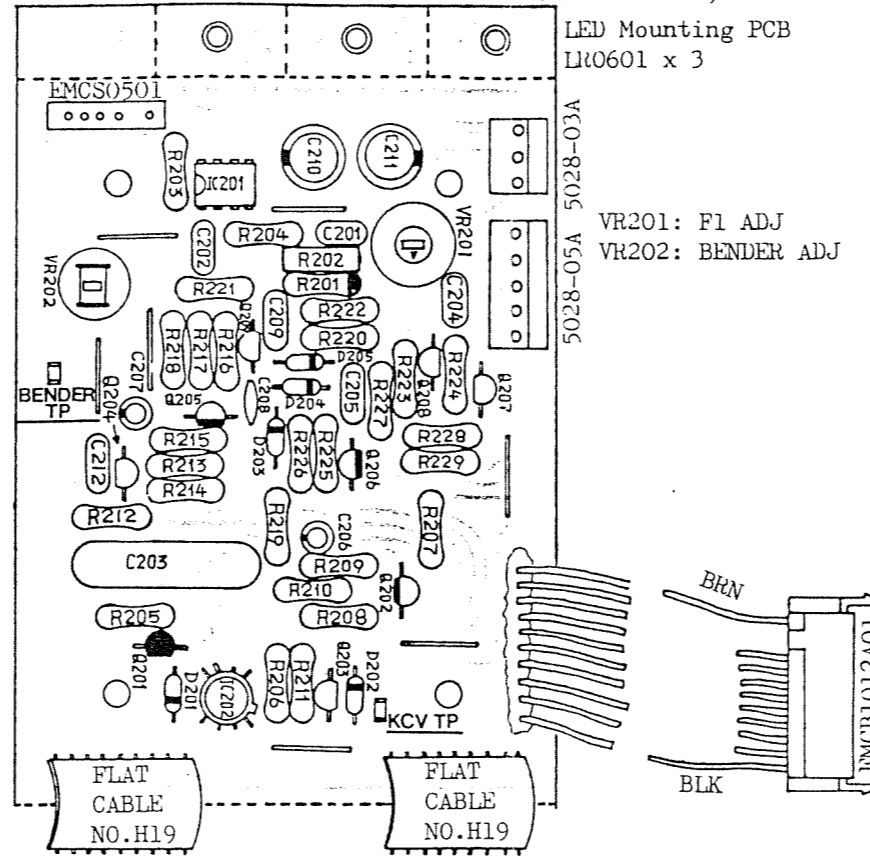

TO CVH-3-2(1-9) TO CVH-3-2(19-27)

- 2SC1740(Q) or 2SC945(Q)
- 2SA826(Q) or 2SA733(Q)
- 2SK30A(GR)
- 1S2473
- Test Point 59BS8806
- 1/4W Resistor
- Metal Film Resistor
- 1/2W Resistor
- Electrolytic
- Mylar
- Ceramic

CAUTION: Be careful when moving the flat cable connections.

VCOH-3B(3A)-3 (152H002B-3)

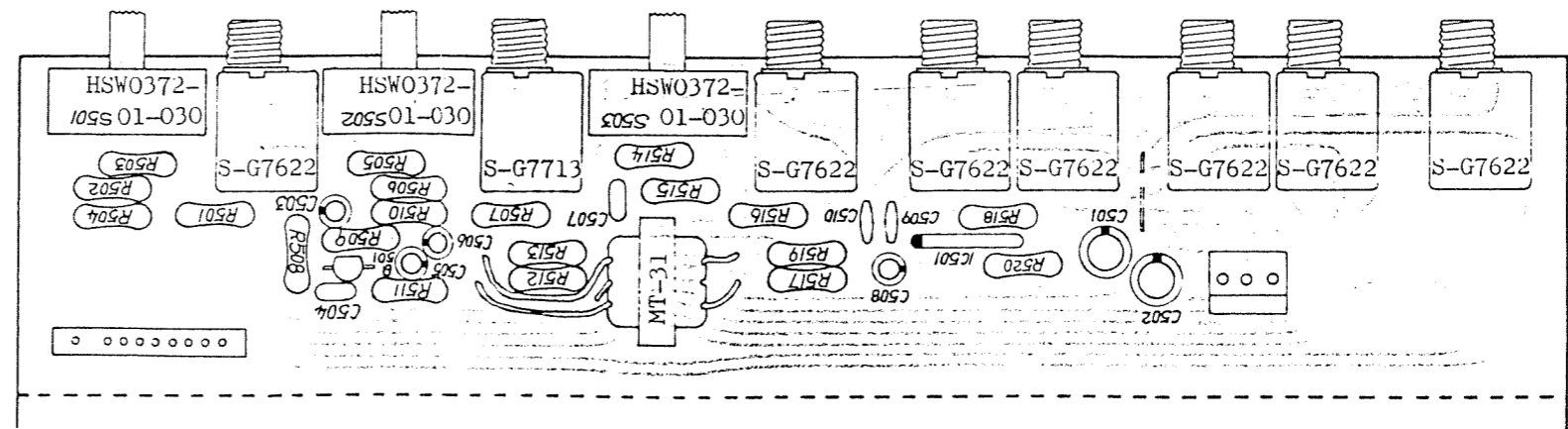

LED Mounting PCB
LR0601 x 3
VR201: F1 ADJ
VR202: BENDER ADJ

CVH-3B-2 (159H003B-2)

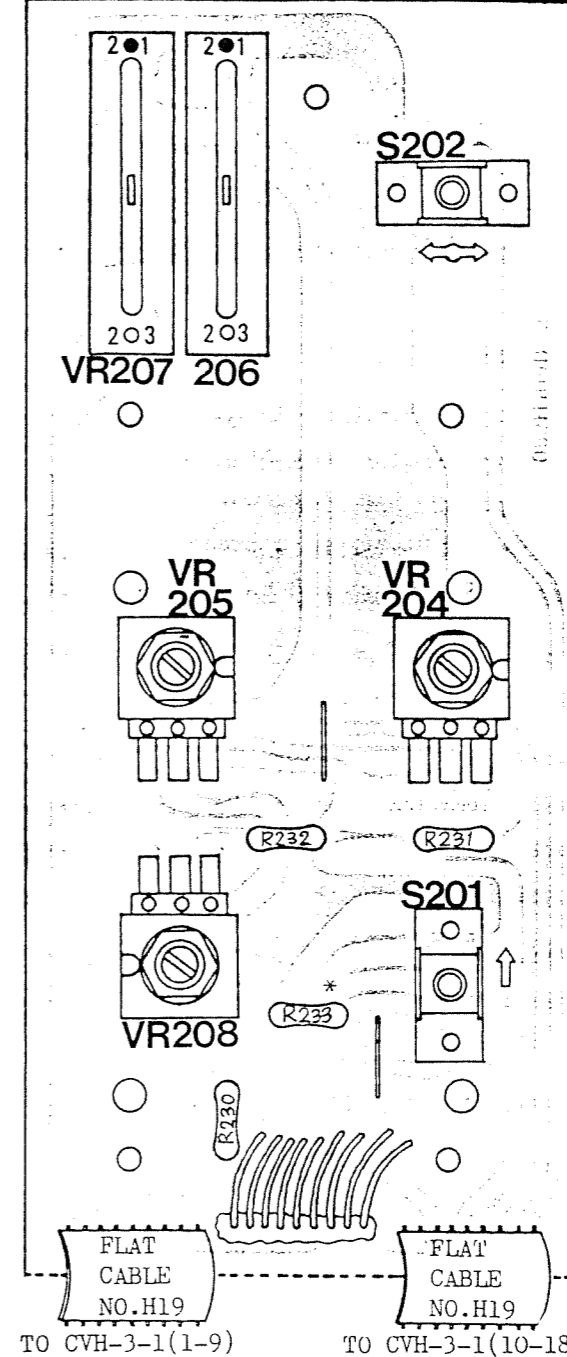

TO CVH-3-1(1-9) TO CVH-3-1(10-18)

- S201 (SLE642-18P):
KYBD/EXT CV GATE
- S202 (SLE623-18P):
TRANSPOSE
- VR204 (VM10R-K15A26 2MA):
PORTAMENTO
- VR205 (VM10R-K20A14 10KA):
VOLUME
- VR206 (LFE9R-C16 100KB):
VCF(SENSITIVITY)
- VR207 (LFE9R-C16 100KB):
VCO(SENSITIVITY)
- VR208 (VM10R-K15B15 100KB):
TUNING

*R233: On the foil side of CVH-3A-2

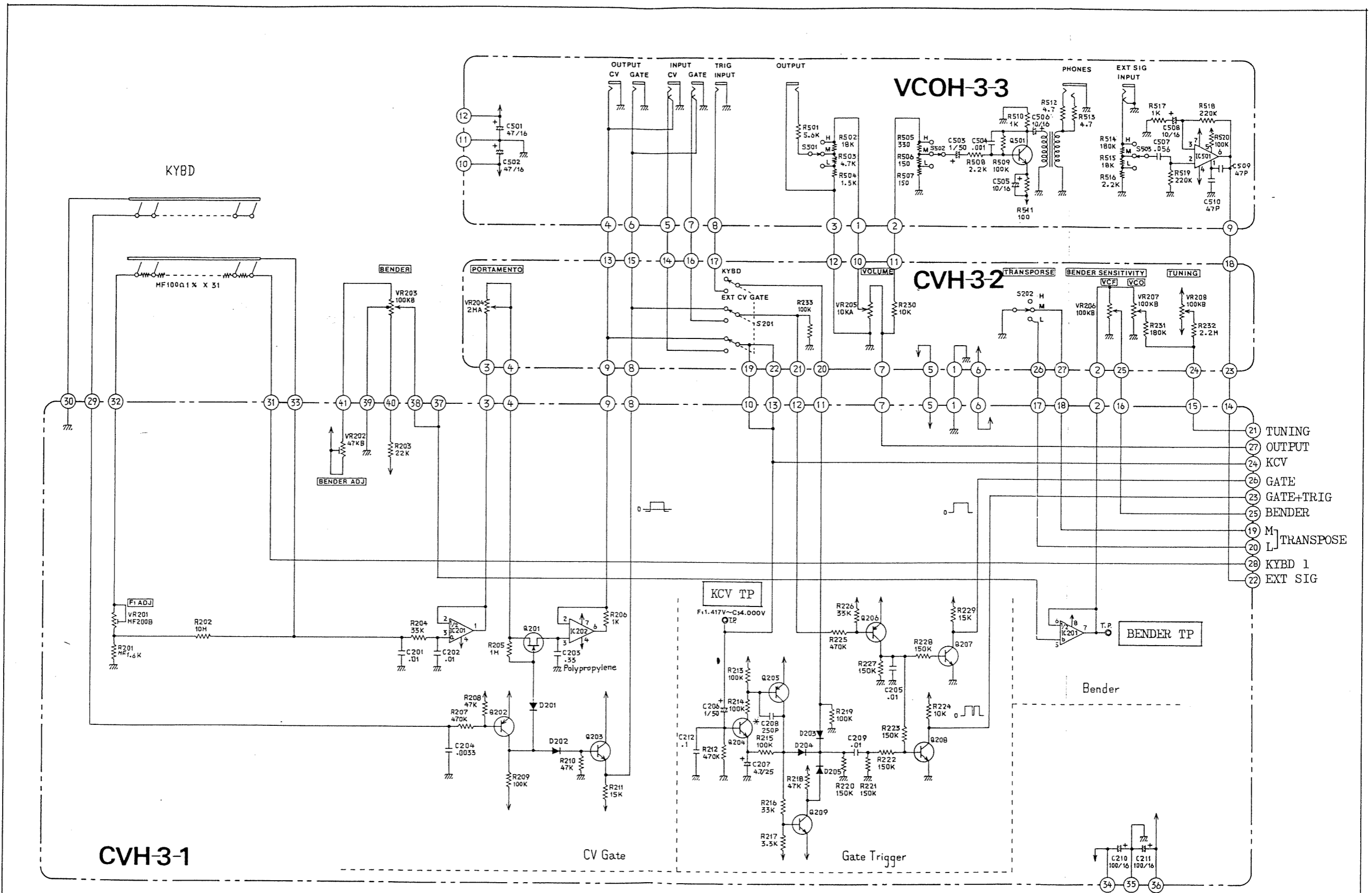

IC201.....μPC1458C
 IC202.....LF13741H
 IC501.....TA7136P

All diodes are 1S2473.
 All PNP Tr's are 2SA826-Q.
 All NPN Tr's are 2SC1740-Q.

*C208: 47p (Up To 711099)

VR307 (LFE9R-C16 100KA): RATE
 VR308 (LFE9R-C16 500KB): DELAY TIME
 VR309 (LFE9R-C16 100KA): TIME
 VR310 (LFE9R-C16 1MA): DEPTH
 VR311 (LFE9R-C16 20KA): MOD
 VR314 (LFE9R-C16 100KB): PULSE WIDTH
 VR315 (LFE9R-C16 100KA): NOISE
 VR316 (LFE9R-C16 100KA): SUB OSC
 VR317 (LFE9R-C16 100KA): VCO
 VR318 (LFE9R-C16 100KA): EXT SIG

S301 (SRM1033-K15): MODE
 S302 (SRM1025-K15): RANGE
 S303 (SSB022-12P): NOISE
 S304 (SSB023-12P): PWM MODE
 S305 (SRM1033-K15): WAVEFORM
 S306 (SSB023-12P): SUB OSC

VR301: NOISE
 VR302: RANGE
 VR303: KCV
 VR304: PWM 5%
 VR305: LINEARITY
 VR306: PWM 50%
 VR312: FREQ
 VR313: WIDTH

VCOH-3A-1 - PARTS ON THE FOIL SIDE

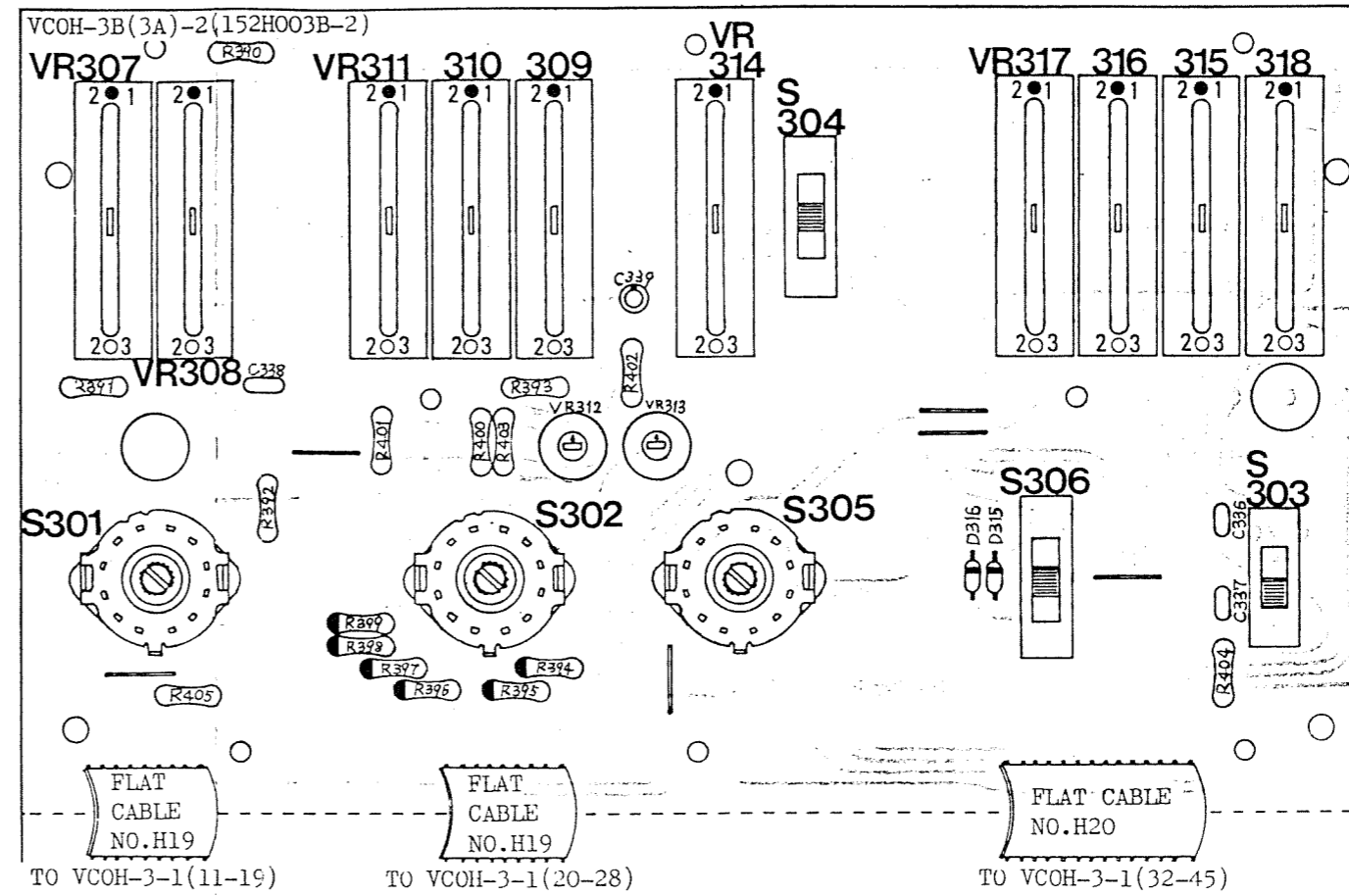
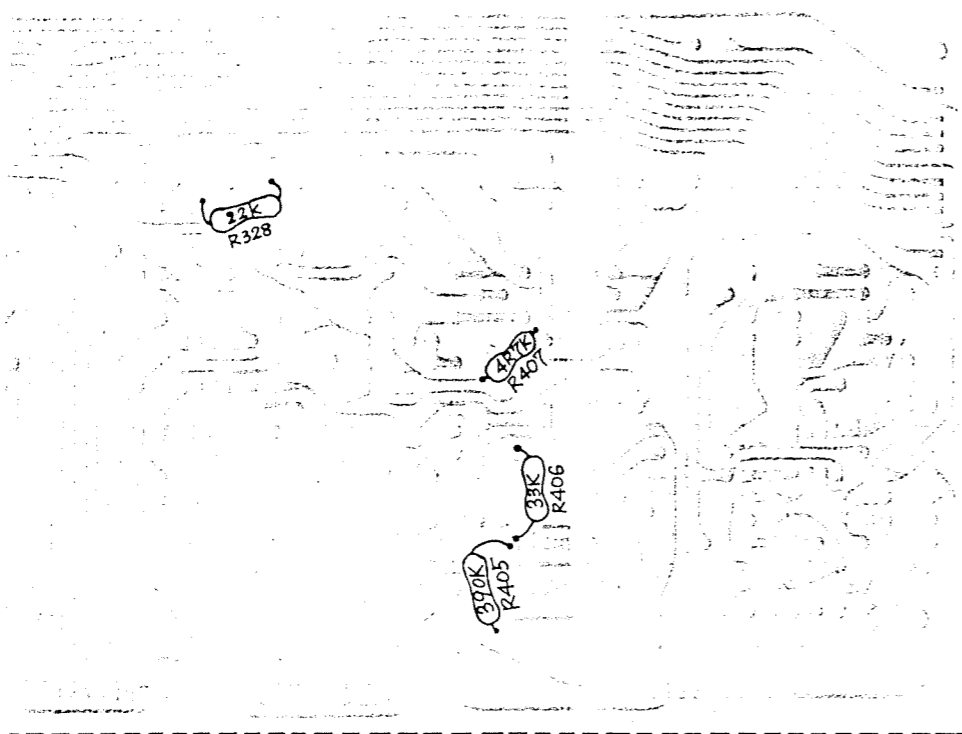

- 2SC1740(Q)
- 2SA826(Q)
- 2SK30A(GR)
- 1S2473
- Test Point 59BS8806
- 2SC828

VCOH-3A-1(SERIAL NO. UP TO 710749) Parts not shown are the same as VCOH-3B-1. VCOH-3B-1(SERIAL NO. 710750 AND HIGHER)(152H003B-1)

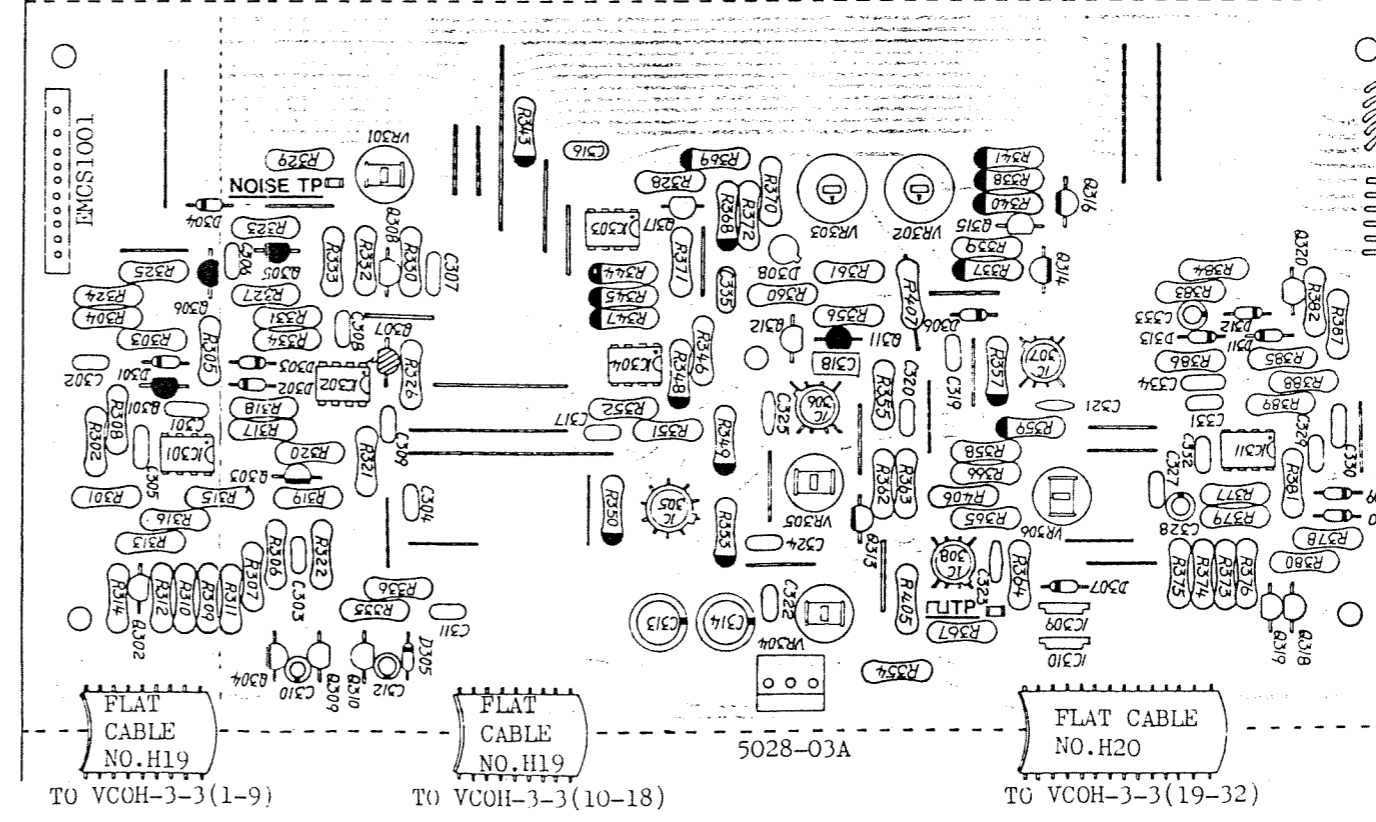
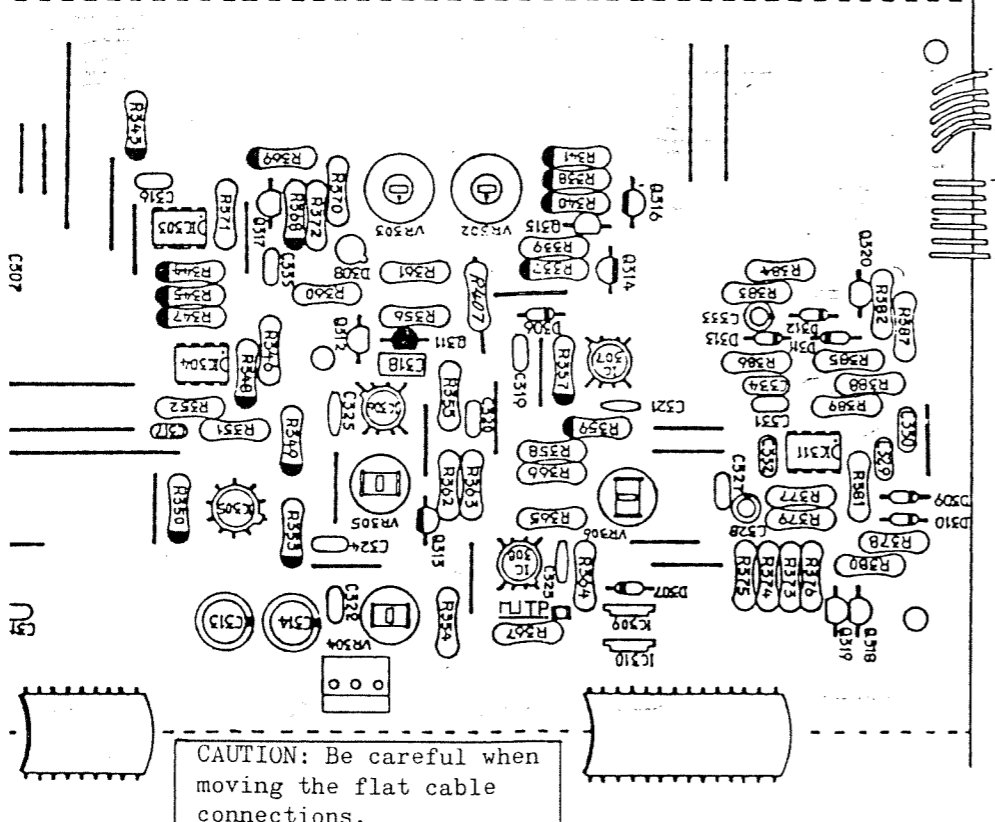

- 1S2453
- 1/4W Resistor
- Metal Film Resistor
- Electrolytic
- Mylar
- Ceramic
- Styrol

CAUTION: Be careful when moving the flat cable connections.

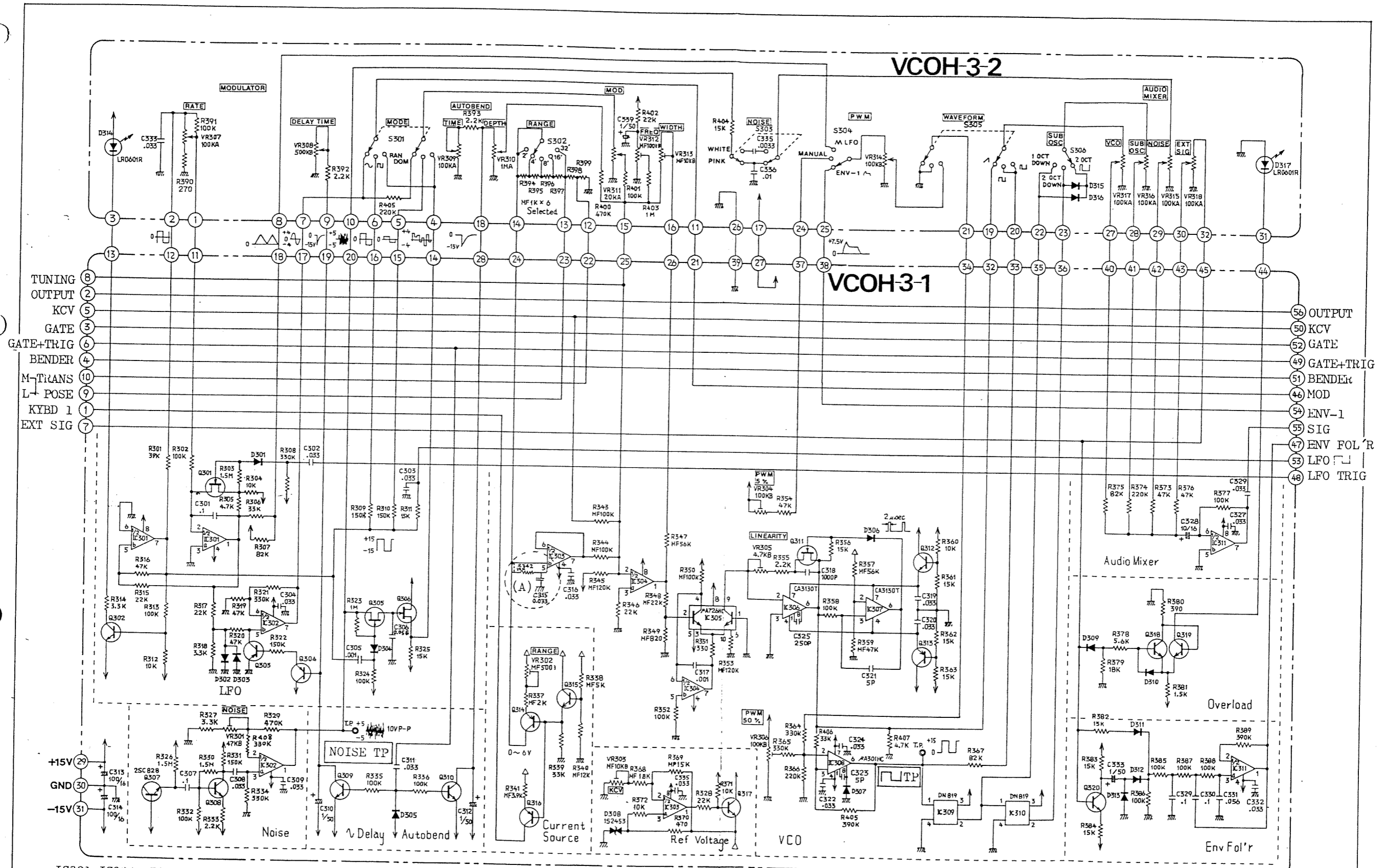

IC301-IC304, IC311.....µPC1458C
 IC305.....µA726HC
 IC306, IC307.....CA3130T
 IC308.....µA301HC
 IC309, IC310.....DN819

All diodes are 1S2473 unless otherwise specified.
 All PNP Tr's are 2SA826-Q.
 All NPN Tr's are 2SC1740-Q unless otherwise specified.
 All FET's are 2SK30A-GR.

SERIAL NO. UP TO 700499:
 C315(0.033), R342(33K)
 (see (A).)
 R327: 5.6K

SERIAL NO. UP TO 700599:
 C306: 0.01
 SERIAL NO. UP TO 710749:
 220K: R329
 VR301: 10K

SERIAL NO. UP TO 711149:
 R369: 5.6K R355: 1K
 R368: 6.8K R367: 68K
 R357: 47K R408: none
 R372: 4.7K R402: 47K
 R370: 330

- | | |
|---|-----------------------------------|
| S601 (SSB022-12P): VCF | VR614 (LFE9R-C16 100KB): S(ENV-1) |
| S602 (SSB022-12P): ENV-1/ENV-2 | VR615 (LFE9R-C16 1MA): R(ENV-1) |
| S603 (SSB023-12P): GATE+TRIG/GATE/LFO (ENV-1) | VR616 (LFE9R-C16 500KA): A(ENV-1) |
| S604 (SSB022-12P): GATE/LFO (ENV-2) | VR617 (LFE9R-C16 1MA): D(ENV-1) |
| VR606 (LFE9R-C16 500KD): CUTOFF FREQ (HPF) | VR618 (LFE9R-C16 1MA): R(ENV-2) |
| VR607 (LFE9R-C16 100KB): CUTOFF FREQ (VCF) | VR619 (LFE9R-C16 500KA): A(ENV-2) |
| VR608 (LFE9R-C16 100KB): KYBD | |
| VR609 (LFE9R-C16 100KA): MOD | VR601: RESONANCE |
| VR610 (LFE9R-C16 100KE): EXT SIG/ENV FCL R | VR602: DC BALANCE |
| VR611 (LFE9R-C16 100KE): ENV-1 | VR603: FREQ |
| VR612 (LFE9R-C16 100KA): RESONANCE | VR604: WIDTH |
| VR613 (LFE9R-C16 100KB): HOLD | VR605: VCA CUTOFF |

VCFH-1A-1 - PARTS ON THE FOIL SIDE

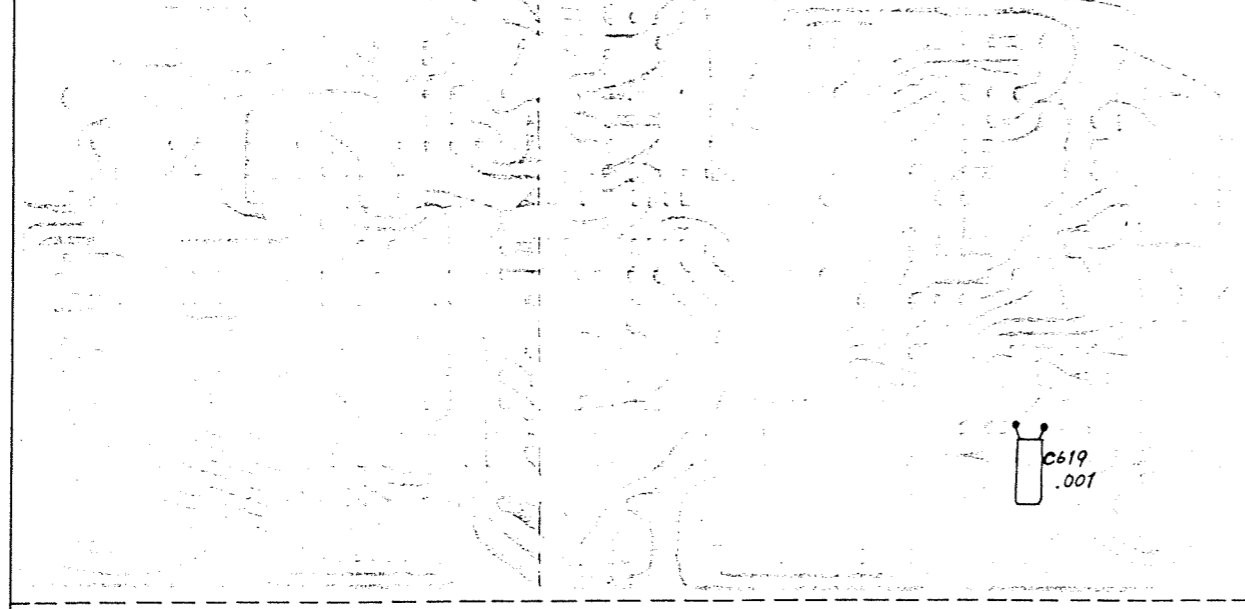

VCFH-1A-1 (SERIAL NO. UP TO 710749)

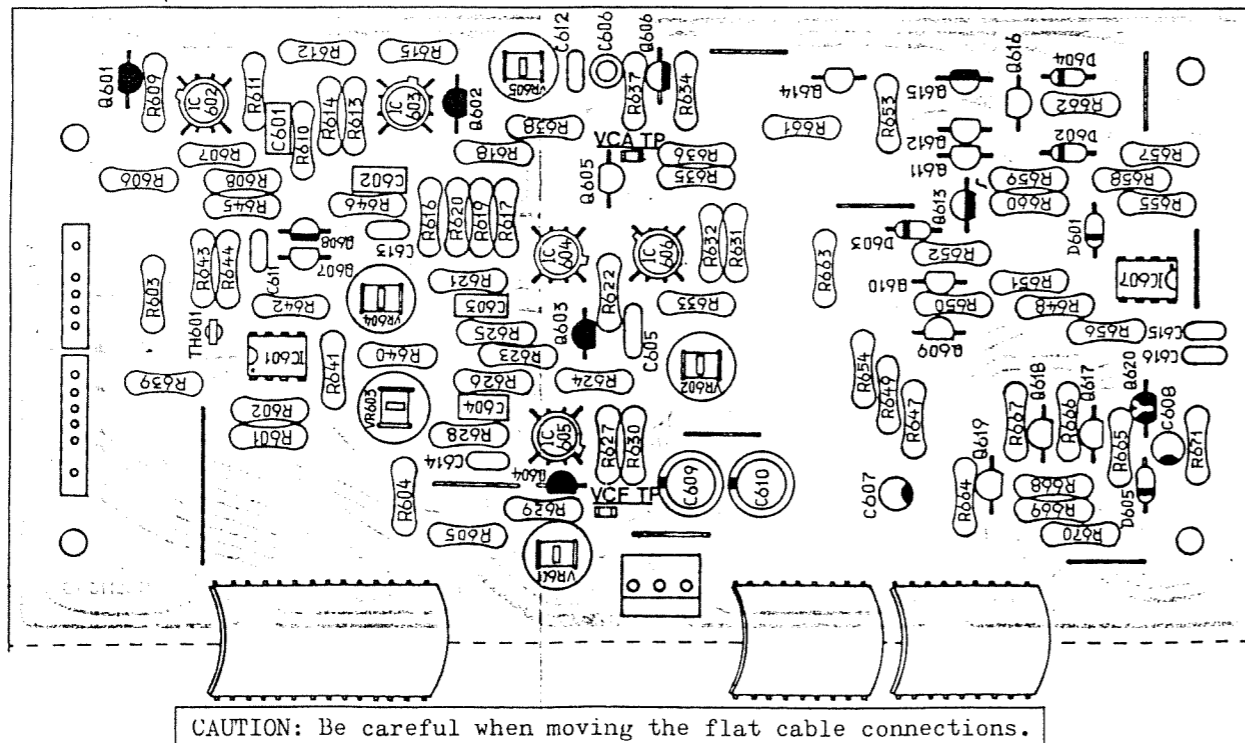

VCFH-1B(1A)-2 (153H001B-2)

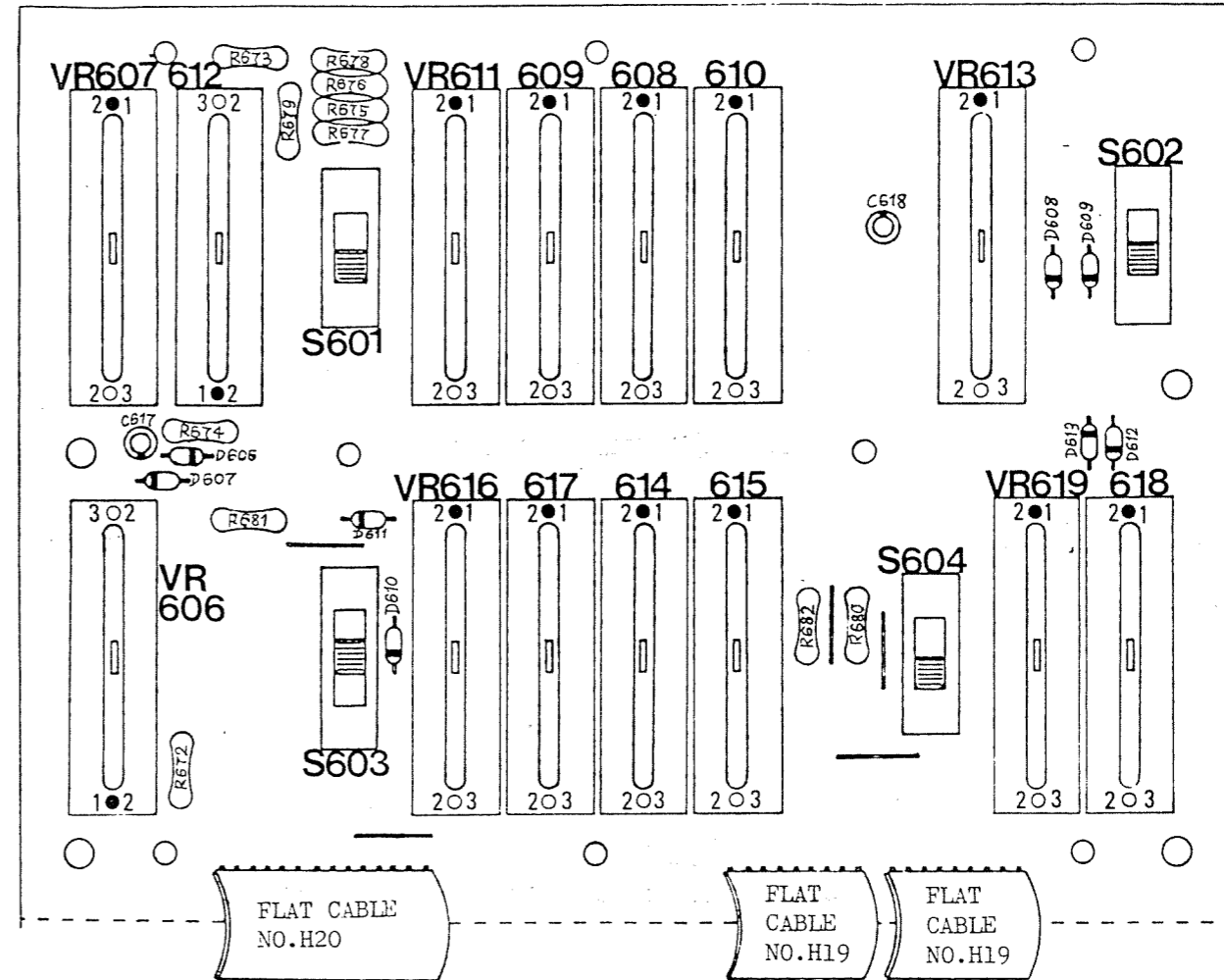

TO VCFH-1-1(12-25)

TO VCFH-1-1(29-37)

TO VCFH-1-1(38-46)

VCFH-1B-1 (SERIAL NO. 710750 AND HIGHER) (153H001B-1)

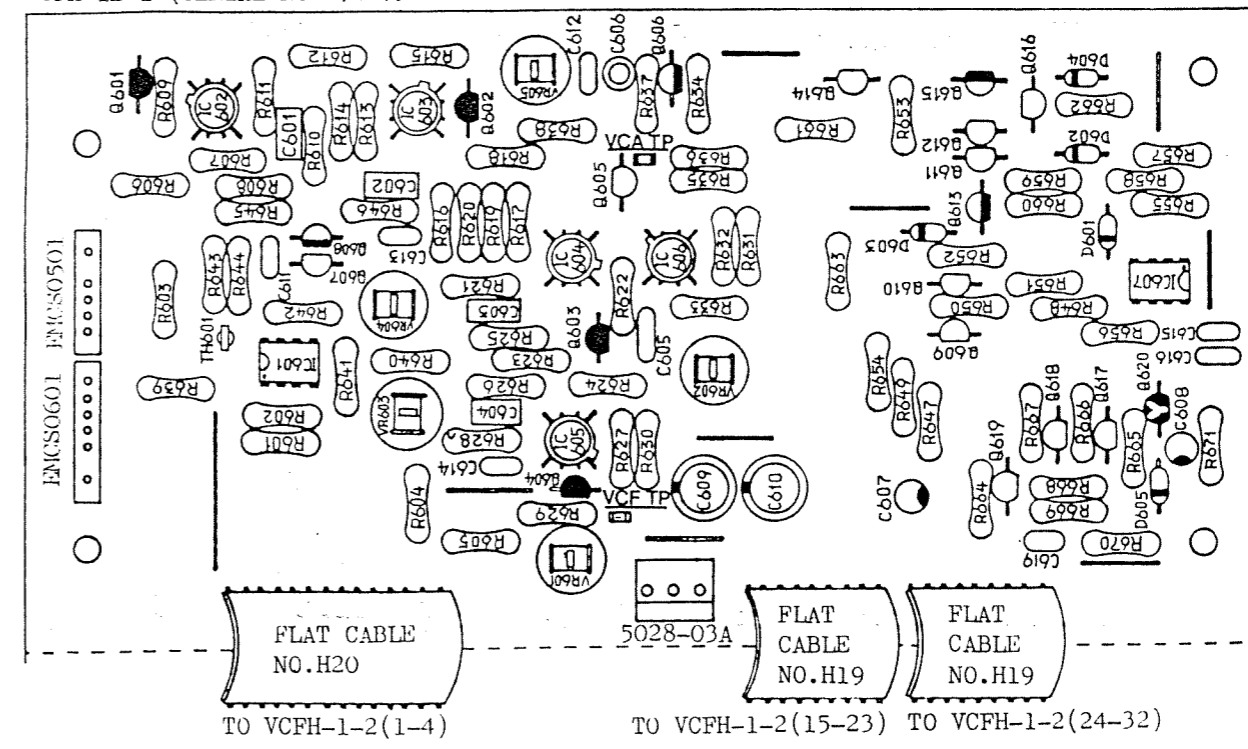

TO VCFH-1-2(1-4)

TO VCFH-1-2(15-23)

TO VCFH-1-2(24-32)

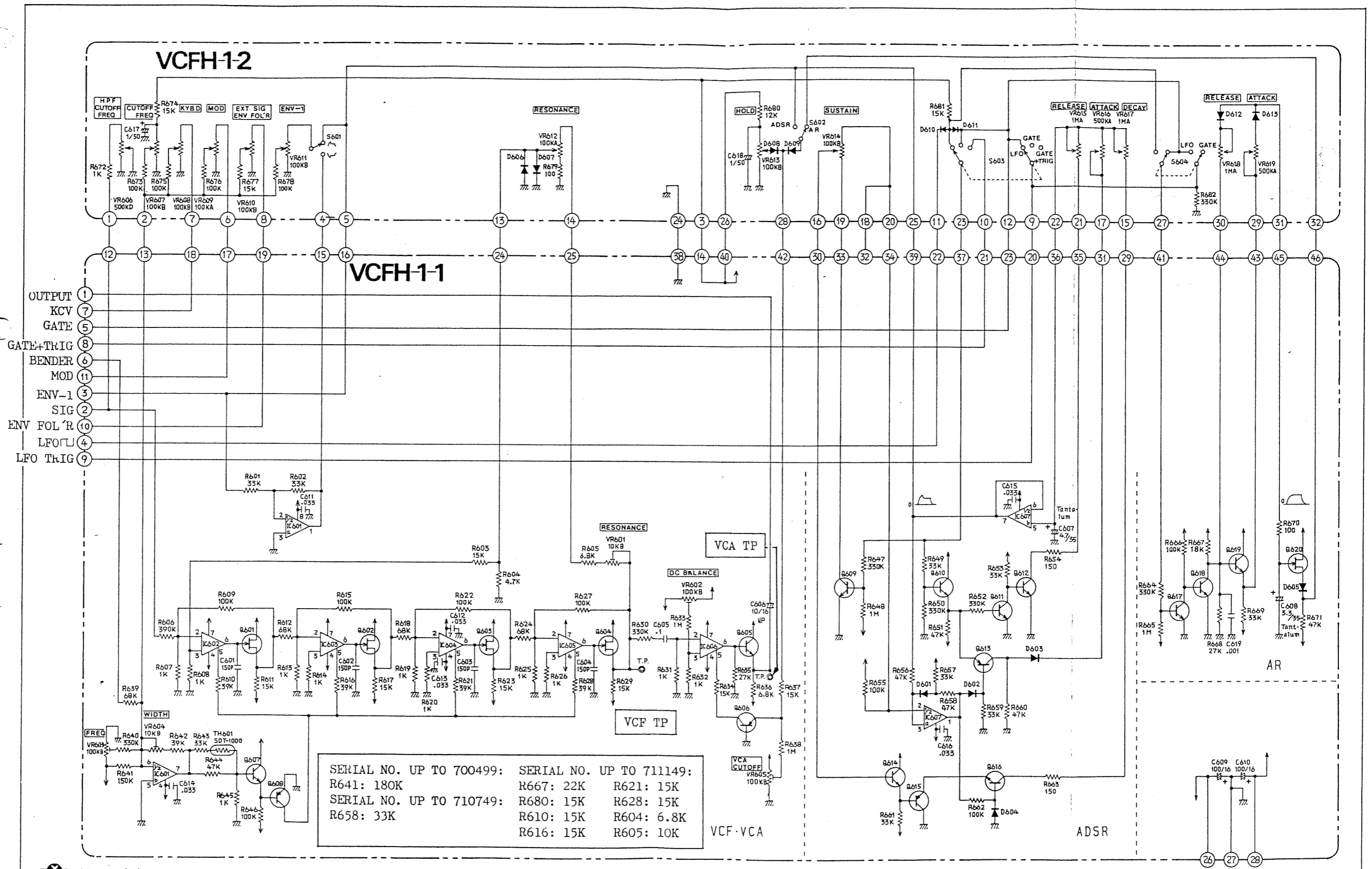

- 2SK30A(Y)
 - 2SC1740(Q)
 - 2SA826(Q)
 - 2SK30A(GR)
 - 1S2473
 - Mylar
 - Tantalum
 - Test Point 59BS8806
 - Thermistor SDT-1000
 - Electrolytic, Non-polar
 - Styrol
 - 1/4W Resistor
 - Electrolytic
- IC601, IC607: μ PC1458C
 IC602-IC606: CA3080A
- All diodes are 1S2473.
 All PNP Tr's are 2SA826-Q.
 All NPN Tr's are 2SC1704-Q.
 All FET's are 2SK30A-GR unless otherwise specified.

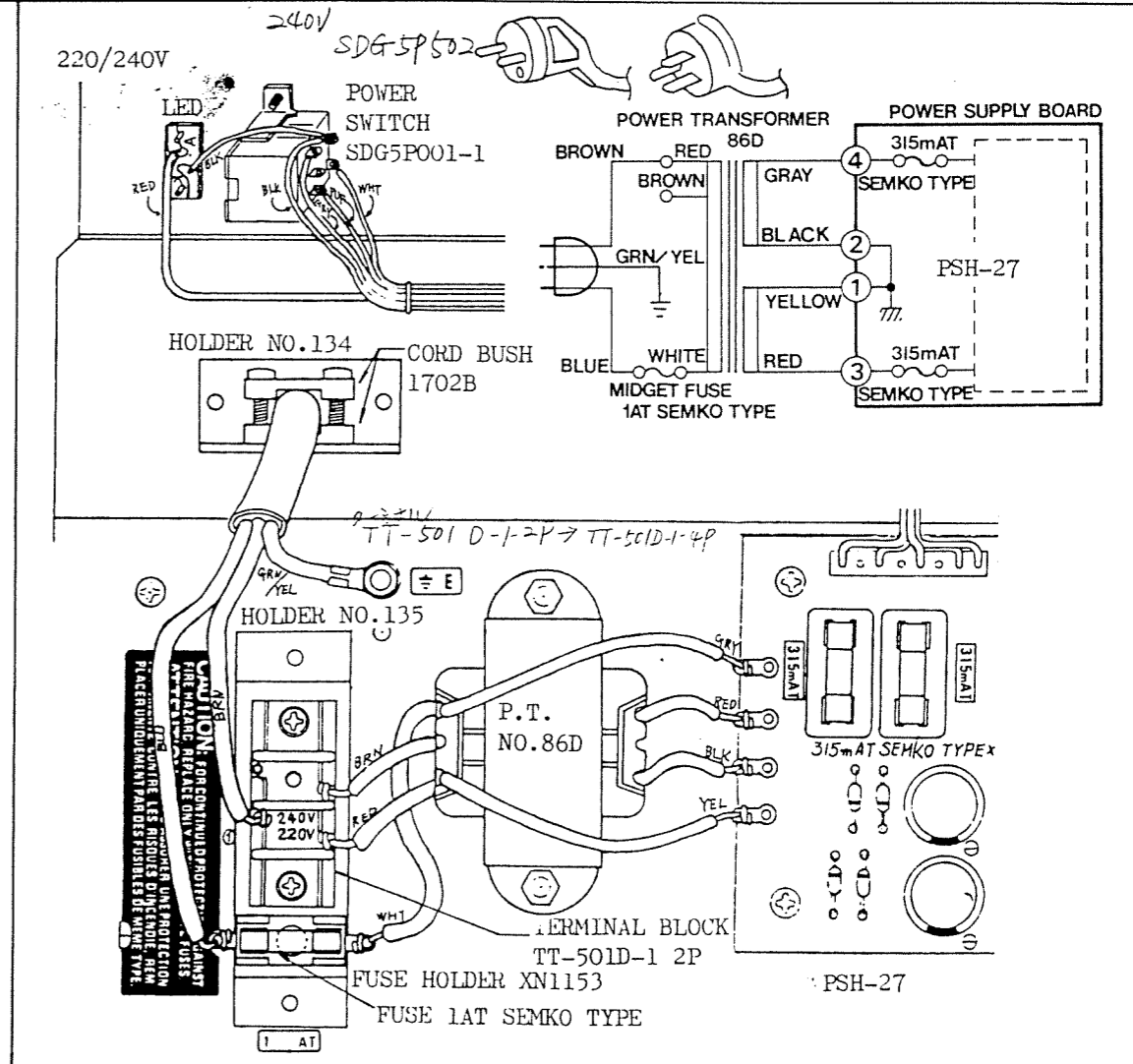
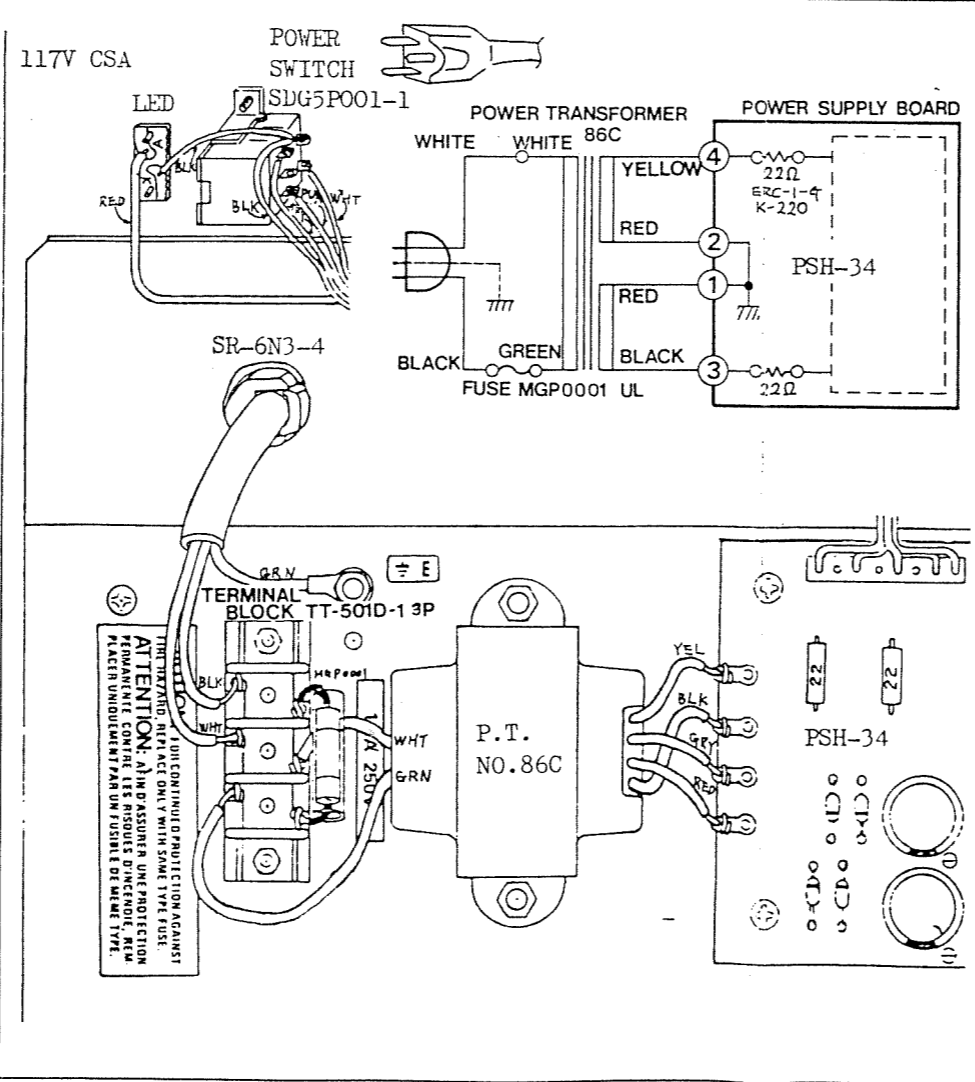
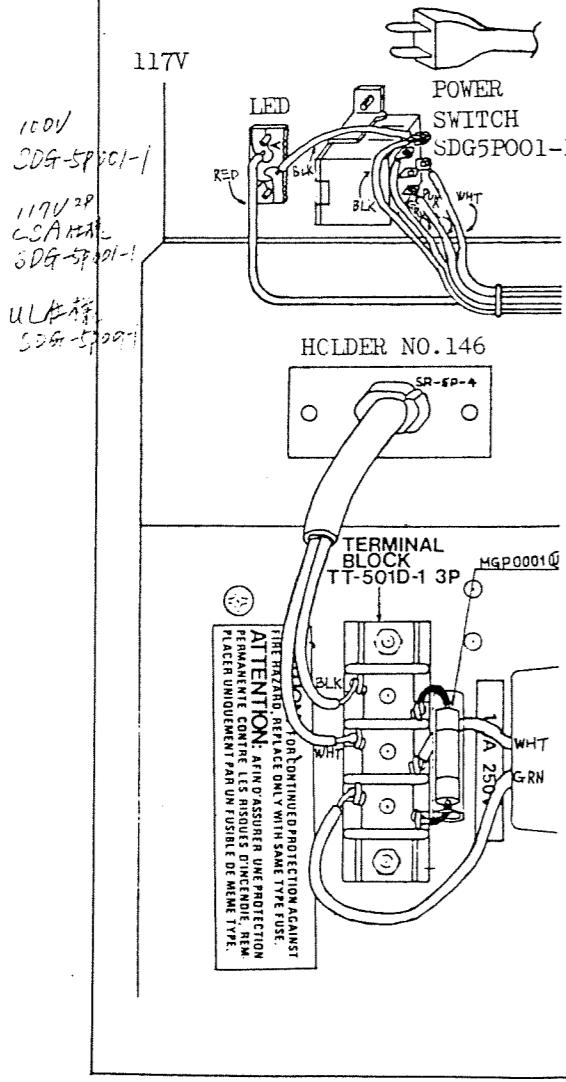
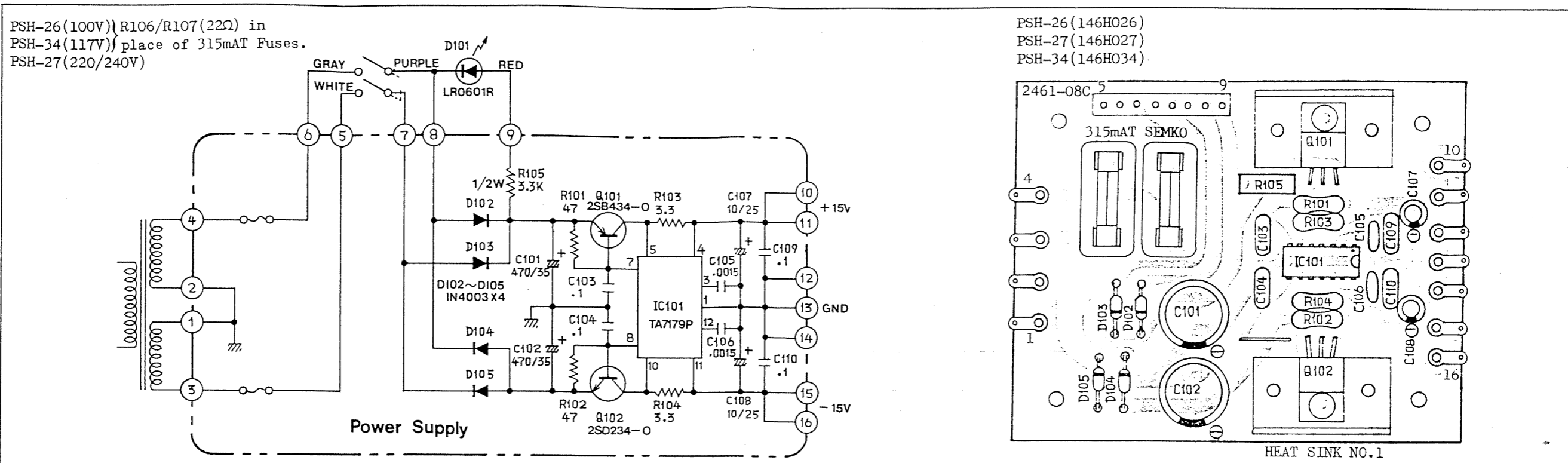

ADJUSTMENT

1. Bender Voltage

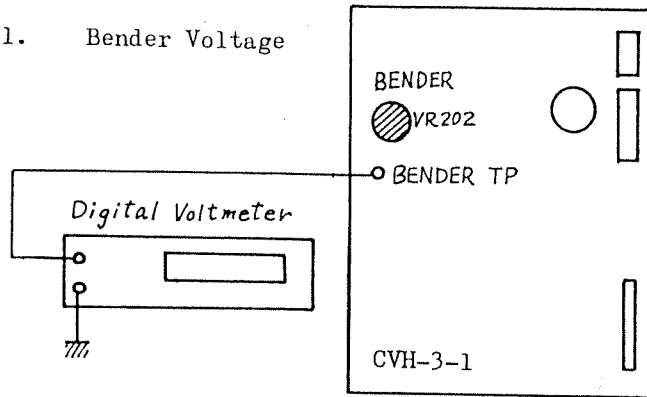

Make adjustment under temperatures where the SH-1 is usually used.
Allow at least 5 minutes as a warm-up period.

Connect a digital voltmeter to BENDER TP.

Set Bender Lever at full - position and read the value (negative).

Then set the Bender Lever at full + position and adjust VR202 so that the same reading (positive) is obtained. Tolerance is $\pm 30\text{mV}$.

2. KCV

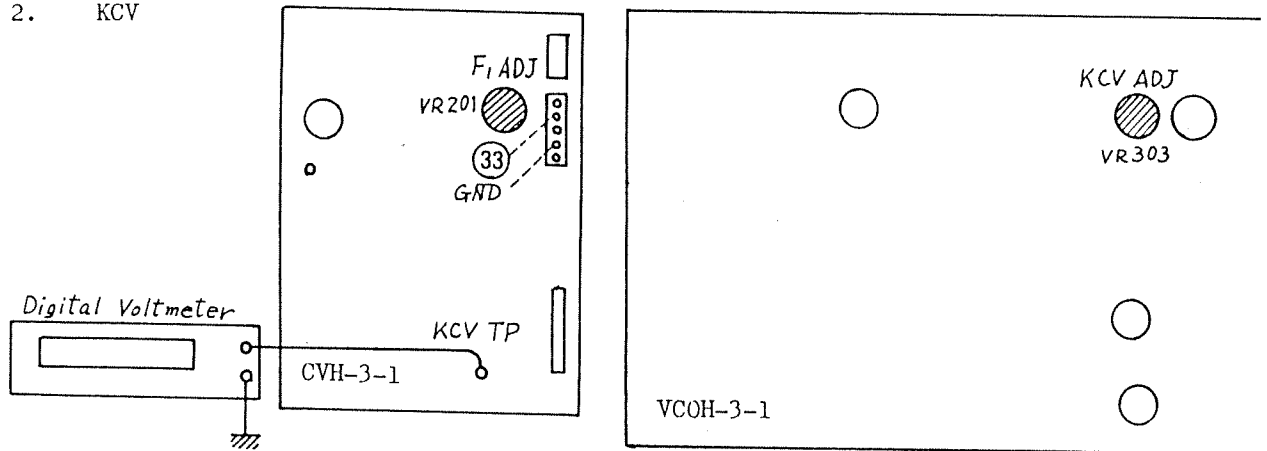

Connect a digital voltmeter to KCV TP.

Connect No.33 terminal to GND. While depressing F1, F2, and F3 in order, adjust VR303 to obtain 1V/oct relation. Tolerance is $\pm 2\text{mV}$.

Next, disconnect F1 from GND. While depressing F1, adjust VR201 to obtain 1.417V. Tolerance is $\pm 1\text{mV}$.

3. Noise

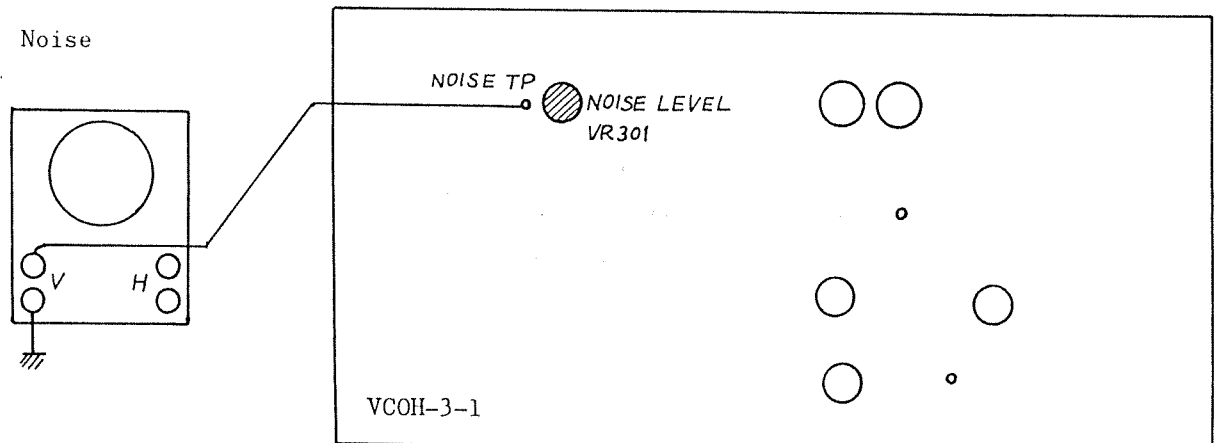

Connect an oscilloscope to NOISE TP.

Adjust VR301 to obtain noise slightly over 10Vp-p.

4. VCO

When adjusting VCO, be sure to continue to depress respective key.

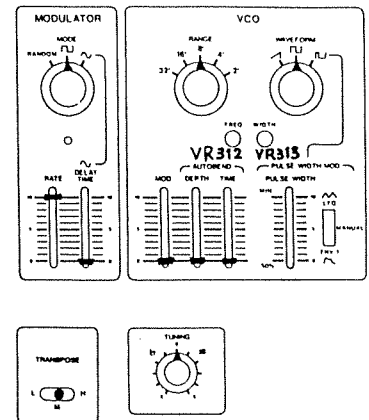
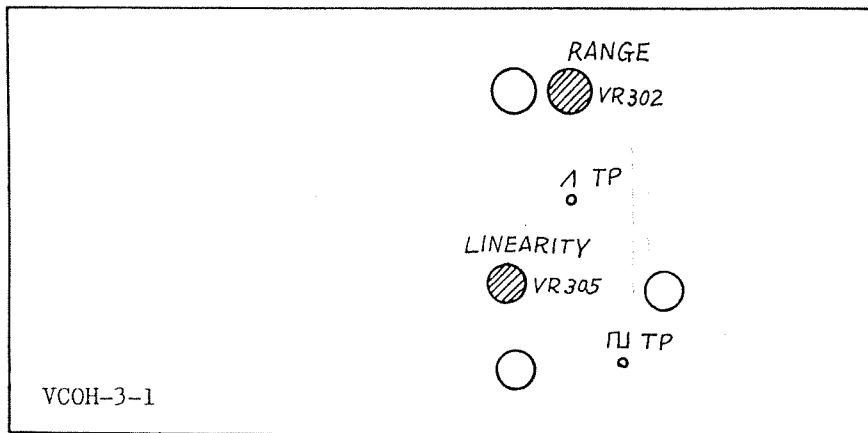

For the adjustment that follows, use a completely tuned electronic instrument or a tuning meter. Adjustment can be made either by checking for the beat sound or by consulting the Lissajous figure on the oscilloscope.

4. a. WIDTH ADJUSTMENT

- 1) Set controls on the control panel as shown above.
- 2) Tune F1 to pitch with TUNING control on the control panel.
(If this tuning is difficult only with TUNING control, adjust VR312 FREQ control, too.)
- 3) Tune F2 to pitch with VR313 WIDTH control.
- 4) Again, tune F1 to pitch with TUNING control.
- 5) Check to see to which F2 is out of tune, to higher pitch or to lower pitch.
- 6) Turn VR313 WIDTH control to make the margin of mistune still bigger.
(If F2 is broadly out of tune, turn VR313 largely.
If F2 is slightly out of tune, turn VR313 only slightly.)
- 7) Tune F1 to pitch over again.
- 8) Repeat steps 5 thru 7 until both F1 and F2 are tuned to pitch roughly.
- 9) Tune F3 to pitch with VR313 WIDTH control.
- 10) Tune F1 to pitch with TUNING control.
- 11) Check to see to which F3 is out of tune, to higher pitch or to lower pitch.
- 12) Turn VR313 WIDTH control to make the margin of mistune still bigger.
(If F3 is broadly out of tune, turn VR313 largely.
If F3 is slightly out of tune, turn VR313 only slightly.)
- 13) Tune F1 to pitch over again.
- 14) Repeat steps 11 thru 13 until F1 and F3 are tuned correctly.
- 15) Set TUNING control the control panel at CENTER position.
- 16) Tune F1 to pitch with VR312 FREQ control.

4. b. LINEARITY ADJUSTMENT

- 1) Set Range at 2' and Transpose at M.
- 2) Tune F1 to pitch with TUNING control on the control panel.
- 3) Check to see to which F2 (F3) is out of tune, to higher pitch or to lower pitch.
- 4) Turn VR305 LINEARITY control so that F2 (F3) is out of tune in the opposite side to the above.
 (If F2 (F3) has been out of tune to a higher pitch, set it to a little lower pitch than standard pitch with VR305 LINEARITY control.
 If F2 (F3) has been out of tune to a lower pitch, set it to a little higher pitch than standard pitch with VR305 LINEARITY control.)
- 5) Repeat above steps 2 thru 4 until each of F1, F2 and F3 is tuned to pitch.

4. c. RANGE ADJUSTMENT

- 1) Set Range at 32' and Transpose at L.
- 2) Tune F1 to pitch with TUNING control on the control panel.
- 3) Raise Range and Transpose switches step by step and adjust VR302 RANGE adj control to tune F1 to pitch.
- 4) Set Range at 8' and Transpose at M.
- 5) Tune F1 to pitch with TUNING control on the control panel.
- 6) Raise Range and Transpose switches step by step and check to see to which the note is out of tune, higher or lower. Then turn VR302 RANGE adj control so that the note is slightly out of tune in the opposite side.
 That is, set VR302 RANGE adj control so that the mistune is bigger at the lower Range/Transpose position.
- 7) Repeat steps 4 thru 6 until the notes are tuned to pitch at every position of the Range/Transpose switches.
- 8) If it is very difficult to perfectly tune the note at all positions of Range/Transpose switches, adjustment should be done so that the notes are out of tune in the same side with Range - 8' and Transpose - M position as the center, and that the mistune is smaller in the higher pitch positions.

5. Square Wave

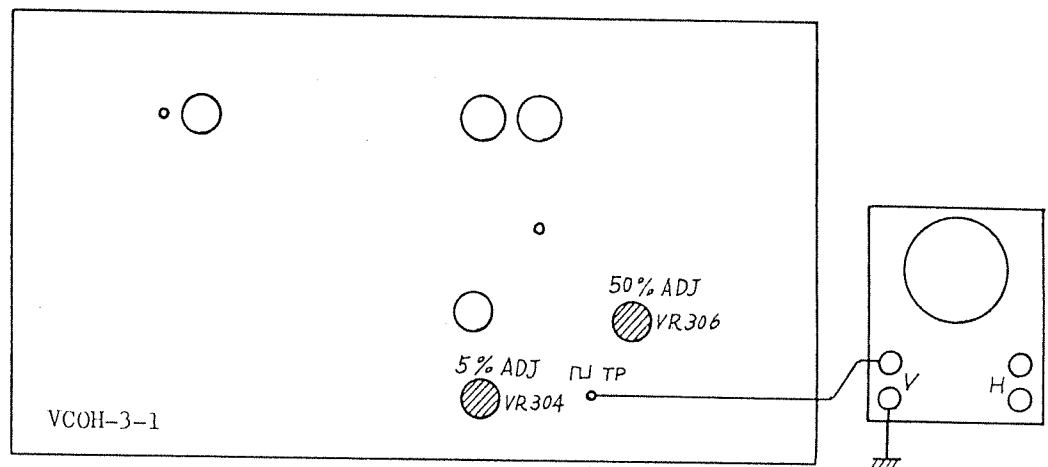

5. a. 50%

Set controls on the control panel and connect an oscilloscope.

Depress a key around the middle of keyboard and adjust VR306 to obtain 50% duty square wave.

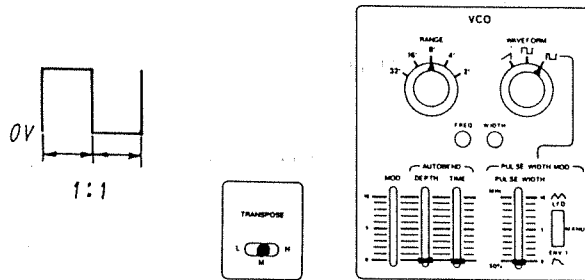

5. b. 5%

Set PULSE WIDTH control at 10.

Depress a key around the middle of keyboard and adjust VR304 to obtain 5% duty square wave.



6. VCF

6. a. Resonance

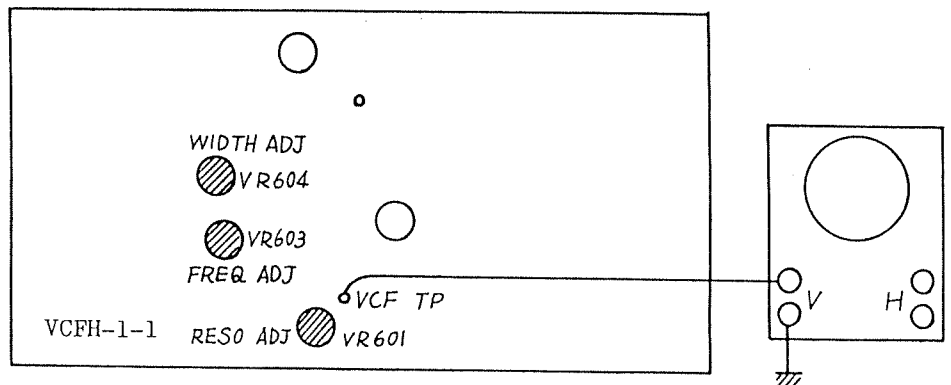

Connect an oscilloscope and set controls on the control panel as shown.

Adjust FREQ control so that VCF oscillates at about 1KHz.

Adjust VR601 so that VCF is at the onset of oscillating with RESONANCE control at 8 as shown at right.

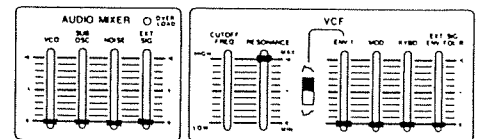

6. b. Width

Set KYBD and RESONANCE controls at MAX.

Depress A2 and adjust FREQ control so that VCF oscillates at about 1KHz.

While depressing C1 and C2 alternately, adjust VR604 to obtain octave relations.

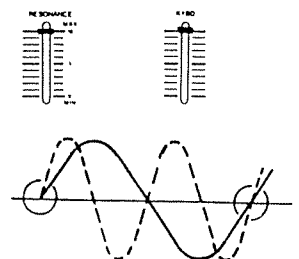

6. c. Frequency

Set KYBD control at 0.

Set CUTOFF FREQ control at HIGH.

Adjust VR603 so that VCF oscillates at 20KHz.

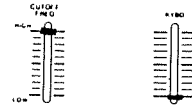

7. VCA

7. a. Cutoff

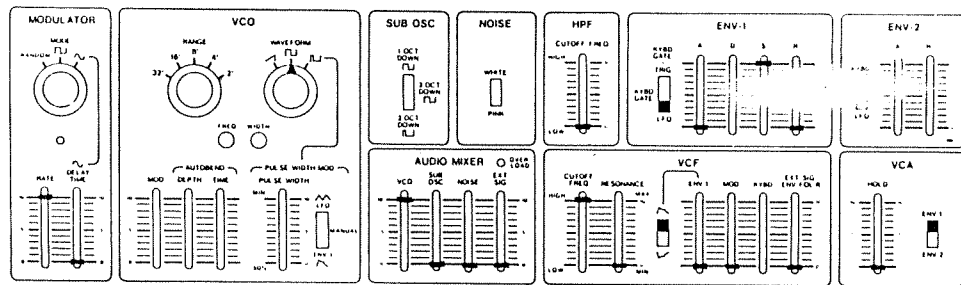
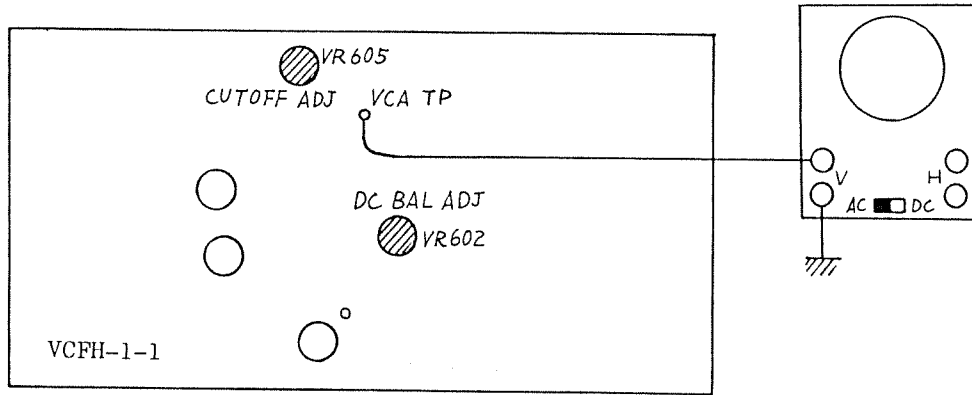

Connect an oscilloscope to VCA TP.

Set controls on the control panel as shown.

While gradually raising the oscilloscope gain to the maximum, adjust VR605 so that output signal is just about to disappear.

7. b. DC Balance

Set VCO control on AUDIO MIXER control panel at 0.

While depressing a key, adjust VR602 so that output variation is minimum.

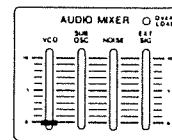

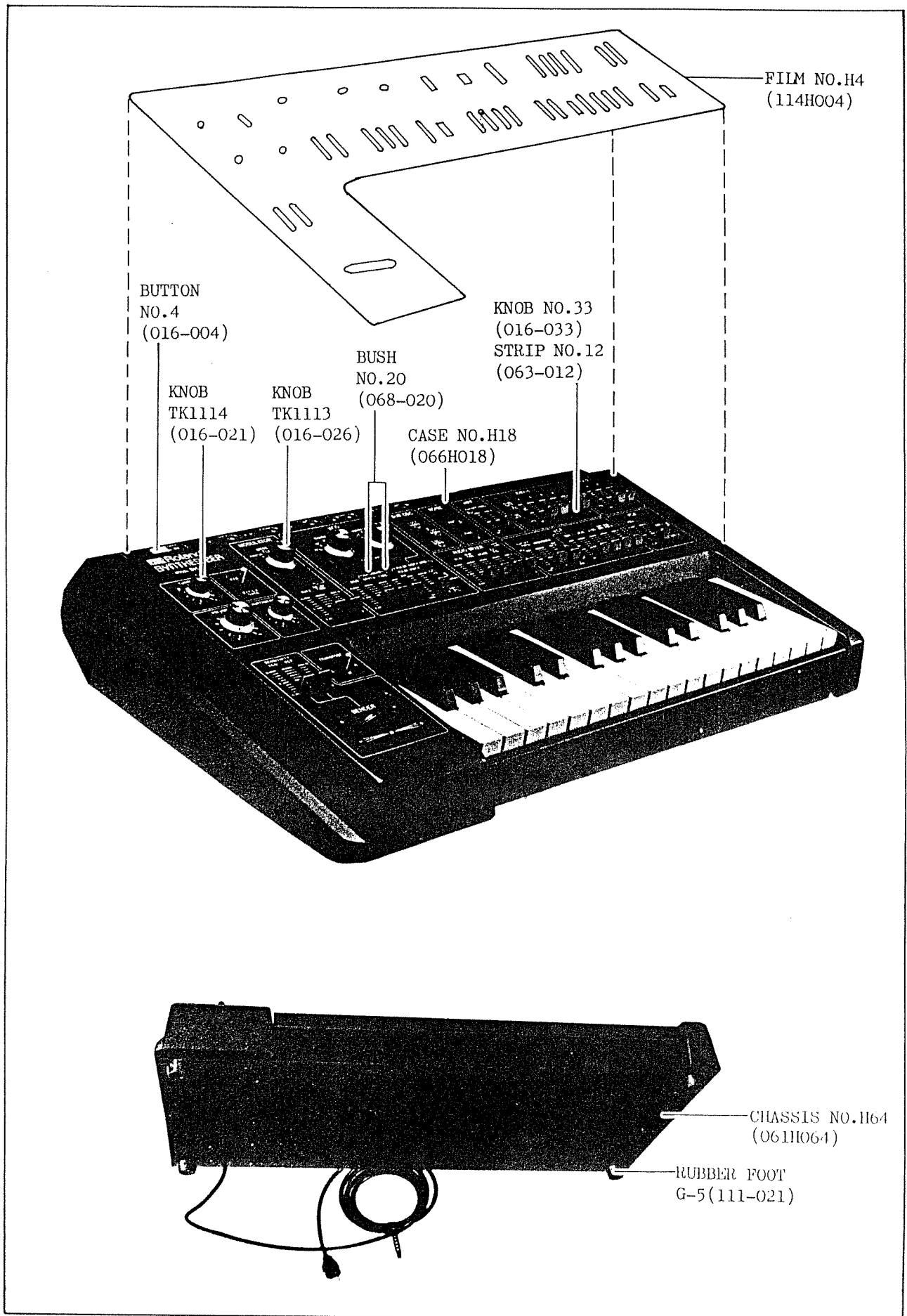

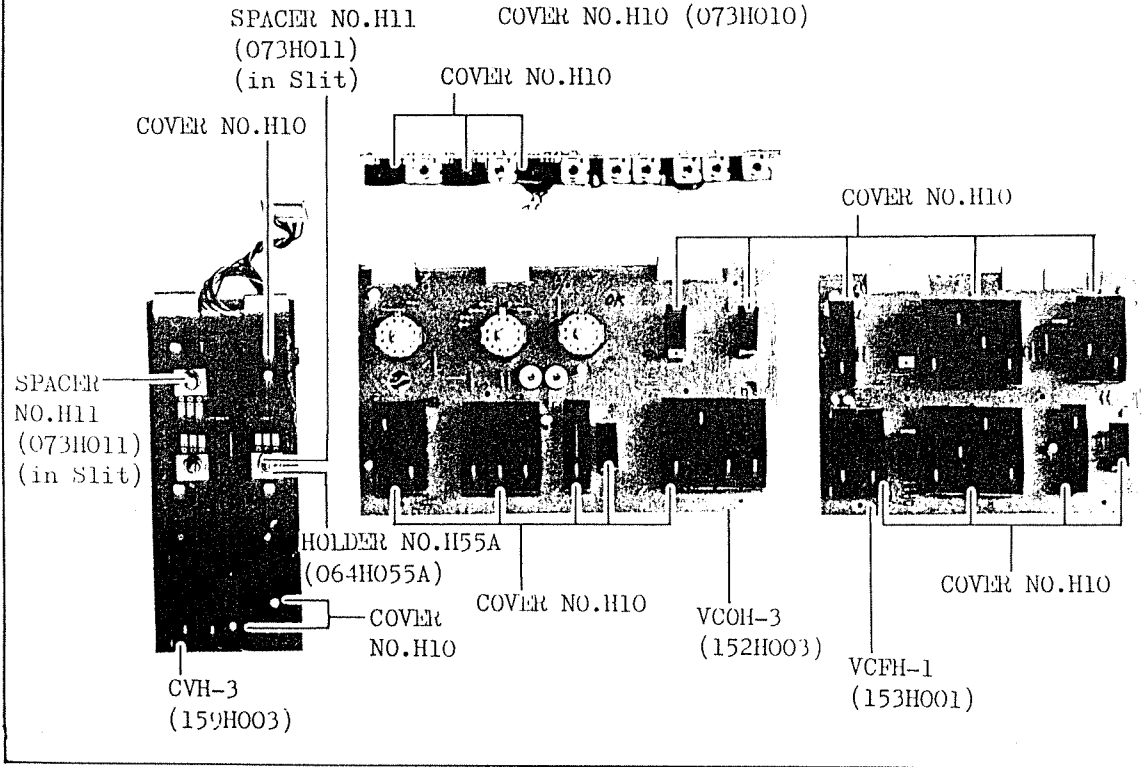
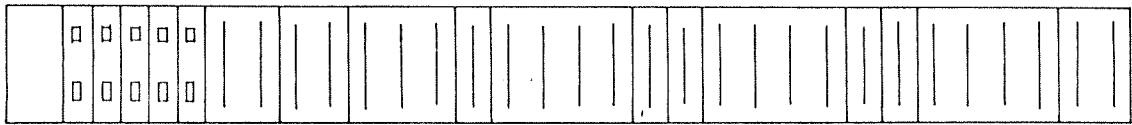
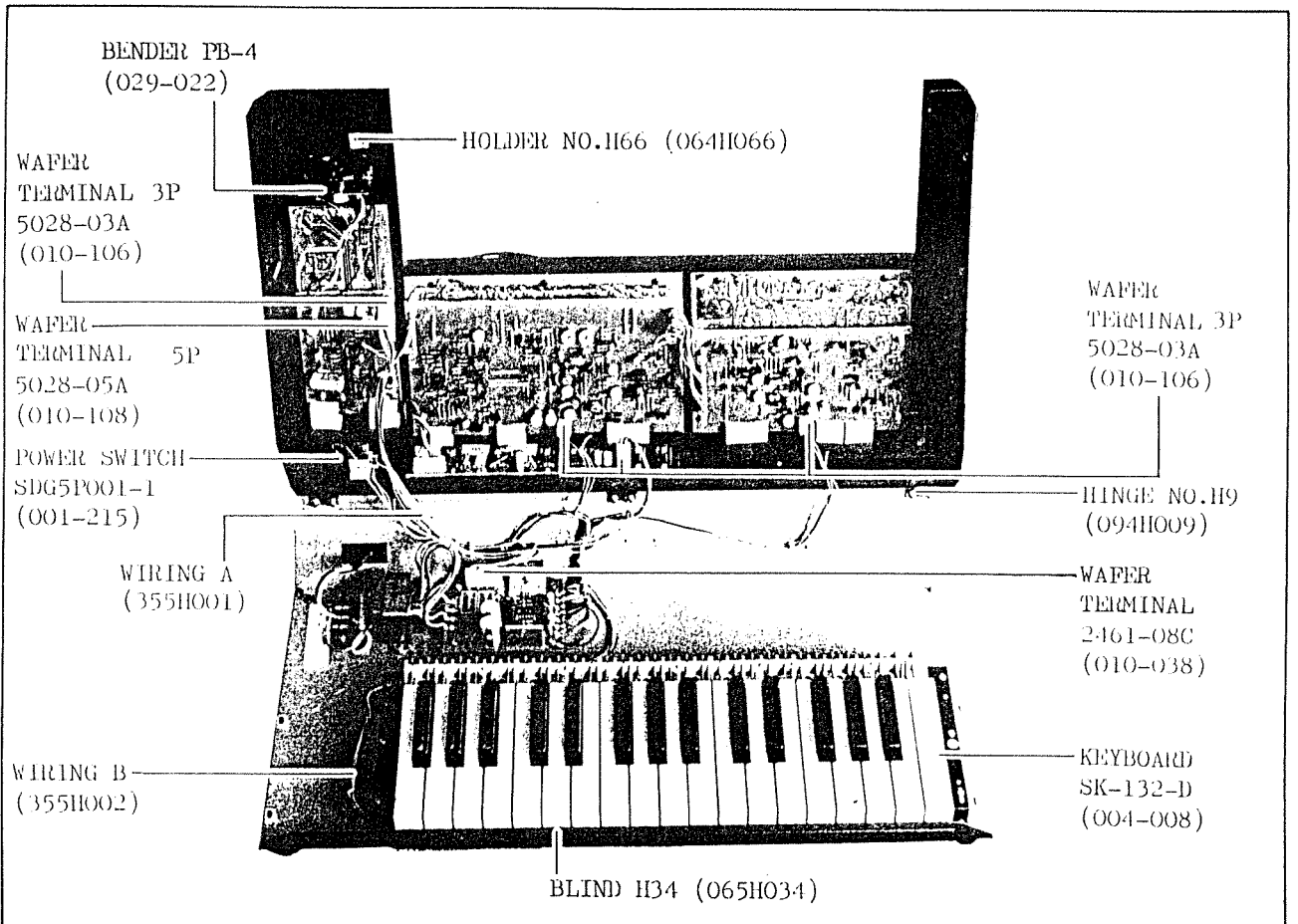

PART NO.	PART AND DESCRIPTION	PART NO.	PART AND DESCRIPTION
	IC		Slide Pot
020-015	CA3080BL, GR	029-304	20KA LFE9R-C16
020-024	μ A301H	029-306	100KA LFE9R-C16
020-025	CA3130T	029-317	100KB LFE9R-C16
020-027	TA7136P	029-308	500KA LFE9R-C16
020-032	μ A726HC	029-319	500KB LFE9R-C16
020-039	DN819	029-340	500KD LFE9R-C16
020-062	μ PC1458C	029-309	1MA LFE9R-C16
020-102	LF13741H		Lever Switch
020-103	TA7179	001-201	SLE623-18P
018-015	Thermistor SDT-1000	001-203	SLE642-18P
	Transistor		Rotary Switch
017-010	2SD234-0	001-213	SRM1033-K15
017-022	2SB434-0	001-214	SRM1025-K15
017-046	2SC828 (NZ)		Slide Switch
017-097	2SA826-Q	001-182	SSB022-12PN
017-118	2SC1740-Q	001-183	SSB023-12PN
019-009	LED LR0601	001-206	HSW0372-01-030
	Diode	001-215	Power Switch SDG5P-001-1
018-014	1S2473		Jack <i>SDG5P-502 240V</i>
018-022	1N4003	009-012	S-G7622 No.08
018-078	1S2453, Zener <i>15019625</i>	009-036	S-G7713 No.08
	FET		Wafer Terminal
017-014	2SK30A-Y	010-106	5028-03A
017-016	2SK30A-GR	010-108	5028-05A
	Resistor	010-038	2461-08C
044-829	820-ohm CRB-1/4FX 1%	042-015	Pin Terminal 2578T
044-908	1.6Kohm CRB-1/4FX 1%		Connector Housing
044-909	2Kohm CRB-1/4FX 1%	010-118	EMCBO516A01
044-834	3.9Kohm CRB-1/4FX 1%	010-123	EMCBO616A01
044-864	5Kohm CRB-1/4FX 1%	010-134	EMCBO920A01
044-913	5.6Kohm CRB-1/4FX 1%	010-137	EMCB1012A01
044-836	6.8Kohm CRB-1/4FX 1%		I-type Plug
044-915	12Kohm CRB-1/4FX 1%	010-143	EMC-S0501
044-840	22Kohm CRB-1/4FX 1%	010-144	EMC-S0601
044-842	47Kohm CRB-1/4FX 1%	010-146	EMC-S0901
044-843	56Kohm CRB-1/4FX 1%	010-147	EMC-S1001
044-846	100Kohm CRB-1/4FX 1%		Flat Cable
044-847	120Kohm CRB-1/4FX 1%	053H019	No.H19
044-830	1Kohm CRB-1/4FX 0.1% selected	053H020	No.H20
044-839	15Kohm CRB-1/4FX 1%	022-122	Output Transformer MT-31
044-905	18Kohm CRB-1/4FX 1%	064H055A	Holder No.H55A (Pot)
044-132	3.3Kohm ERC-12GK (117V)		Capacitor
044-592	22-ohm ERC-1GK (117V)	032-228	4.7 μ 35V Tantalum
	Trimmer Pot	032-227	3.3 μ 35V Tantalum
029-114	200-ohm PNB04C3A201H	035-091	0.33 μ ECQF-2334M Polypropylene
029-113	2Kohm PNB04C3A202H	035-188	1000P Styrole
029-106	10Kohm PNB04C3A103H	035-156	150P Styrole
029-109	100Kohm PNB04C3A104H	032-191	10 μ 16V ECEA16N10 (Non-polar)
030-463	4.7Kohm SR19R 4.7KB	008-061	315mA SEMKO Midget Fuse (220/240V)
030-465	10Kohm SR19R 10KB	008-066	1AT SEMKO Midget Fuse (220/240V)
030-469	47Kohm SR19R 47KB	008-041	1A MGPO001 Pig-tail Fuse (117V)
030-471	100Kohm SR19R 100KB	012-003	TF758 Fuse Holder (220/240V, Sec)
	16 ϕ Pot	012-018	XN1153
028-749	10KA VM10RK20A14		
028-727	100KB VM10RK15B15		
028-756	2MA VM10RK15A26		

PART NO.	PART AND DESCRIPTION
	Use the following PCB's, for replacement for the predecessors.
159H003B-1	CVH-3B-1 (700500 and higher)
052H109B-1	CVH-3B-1 PCB less parts
159H003B-2	CVH-3B-2
052H109B-2	CVH-3B-2 PCB less parts
152H003B-1	VCOH-3B-1 (710750 and higher)
052H110B-1	VCOH-3B-1 PCB less parts
152H003B-2	VCOH-3B-2
052H110B-2	VCOH-3B-2 PCB less parts
152H002B-3	VCOH-3B-3
052H110B-3	VCOH-3B-3 PCB less parts
153H001B-1	VCFH-1B-1 (710750 and higher)
052H111B-1	VCFH-1B-1 PCB less parts
153H001B-2	VCFH-1B-2
052H111B-2	VCFH-1B-2 PCB less parts
146H026	PSH-26 (100V)
146H027	PSH-27 (220/240V)
146H034	PSH-34 (117V)
052H108	PSH-26/27/34 PCB less parts
022-086C	Power Transformer (100/117V)
022-086D	Power Transformer (220/240V)
048-001	Heat Sink No.1
064-147	LCBS-6N (Up To 700499)
064-200	PCB Holder DLCBS-6N
053-041	LP-25 Connection Cord
120-001	Sleeve Nut No.1
064-134	Holder No.134
047-023	Line Cord Strain Relief 1702B
047-003	Line Cord Strain Relief BU-4801
047-031	Line Cord Strain Relief SR-6N3-4 (CSA)
064-146	Holder No.146 (100V/UL)
047-022	Line Cord Strain Relief SR-5P-4
029-022	PB-4 Bender Unit
066H018	Case No.H18
061H064	Chassis No.H64
094H009	Hinge No.H9
111-021	Rubber Foot G-5
042-040	Terminal Block TT501D-1 3P
042-032	Terminal Block TT501D-1 2P
016-021	Knob TK-1114
016-026	Knob TK-1113
016-033	Knob No.33 (Slide Pot)
063-012	Strip No.12 (Slide Pot)
016-004	Button No.4 (Power Switch)

PARTS ORDERING INFORMATION

Name of part number of some of the parts is changed from those printed on previously issued parts list. When ordering replacement parts, be sure to follow the description on the present issue.

When ordering parts, be sure to include the following information:

1. Model and Serial Number
2. Part Number
3. A Description of the Part

This parts list includes all standard stock replacement parts. No attempt has been made to include every nut, bolt and screw. If the necessity for a non-listed part arises, please write describing the parts location and function as well as model and serial number of the unit.

54.76 2P → TT501D-1 4P

KEYBOARD PARTS

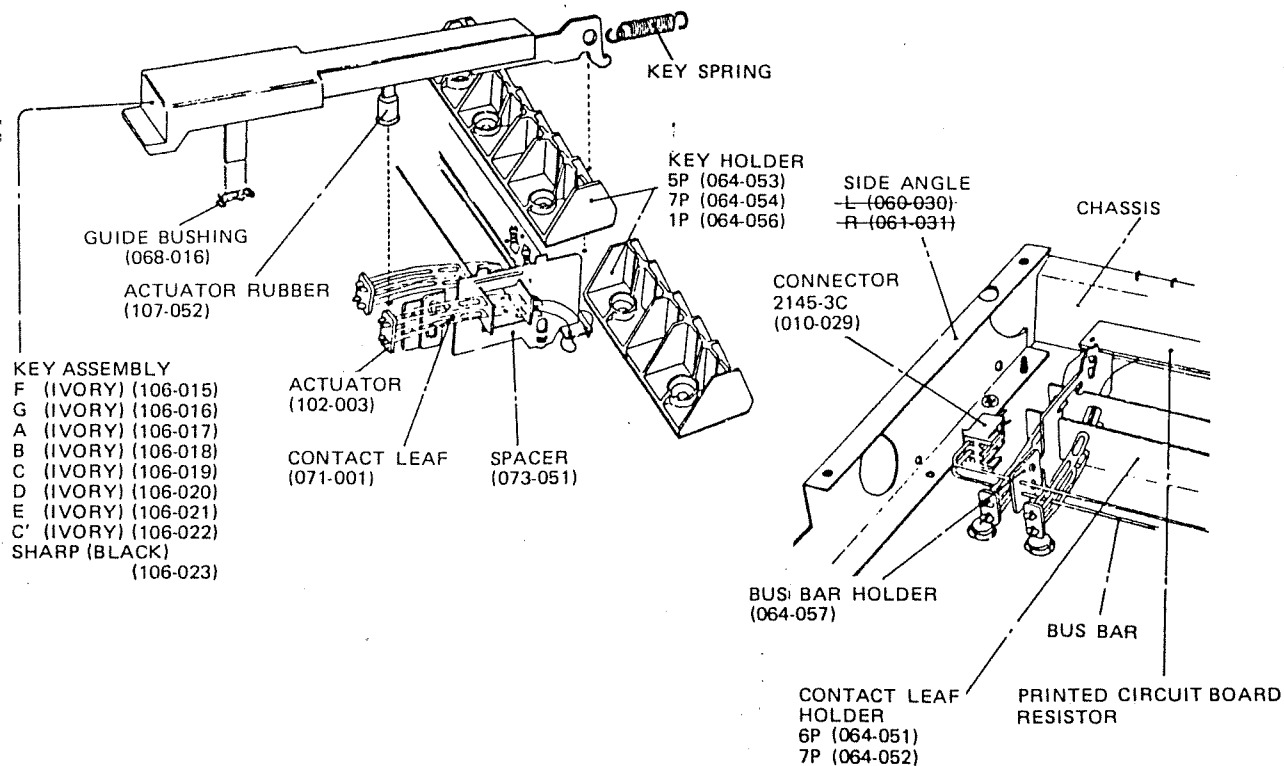

INSTRUMENT MODEL	NO. OF KEYS	KEYBOARD MODEL	KEY SPRING	BUS BAR	PCB		RESISTOR
					6P	7P	
SH-1	32	SK-132-D	070-052	071H034	052-066	052-067	100 1/4W $\pm 1\%$ CRB1/4FX
SH-3A	44	SK-142-A	070-052	071-008	052-066	052-067	100 1/4W $\pm 1\%$ CRB1/4FX
SH-5	44	SK-142-B	070-052	071-008	052-066	052-067	100 1/4W $\pm 1\%$ CRB1/4FX
SH-7	44	SK-142-C	070-052	071-008	052-066	052-067	100 1/4W $\pm 1\%$ CRB1/4FX
SH-1000	37	SK-132-A	070-052	071-006	052-066	052-067	1K 1/4W $\pm 2\%$
SH-2000	37	SK-132-B	070-052	071-006	052-066	052-067	1K 1/4W $\pm 2\%$ SELECTED
SYSTEM-100	37	SK-132-C	070-052	071-006	052-066	052-067	100 1/4W $\pm 1\%$ CRB1/4FX
SYSTEM-700	61	SK-162-C	070-058	071-007	052-066	052-067	100 1/4W $\pm 1\%$ CRA1/4FX
RS-101	61	SK-161-A	070-058	071-007	052-081	052-082	
RS-202	61	SK-161-A	070-058	071-007	052-081	052-082	
EP-10	61	SK-162-A	070-058	071-007			
EP-20	61	SK-162-A	070-058	071-007			
EP-30	61	SK-162B	070-058	071-007	052-081	052-082	

 Roland®

20055

UPC

20055



10961

Roland