

VK-1 SERVICE NOTES

SPECIFICATIONS

TUNE RANGE: ± 30 cents CHORUS-VIBRATO RATE: 0.3-8 Hz
 OUTPUT: L = -24 dB; M = -12 dB; H = 0 dB
 POWER CONSUMPTION: 20 Watts
 DIMENSIONS: 1130 (w) x 148 (h) x 448 (d) mm
 WEIGHT: 16 Kg

Knob no.78 (016-078)

Pot. EVHCOAK15B14 (026-003)
 (EVH8MA360B14)

Top cover H18 (086H018)

Pot. EVHCOAK15A15 (026-176)
 (EVH8MA360A15)

Trim H6 (093H006)

Pot. EVHCOAK15B54 (026-004)
 (EVH8MA360)

Cabinet H221
 (081H221)

Pot. EVHCOAK15B14 (026-003)

Switch 320. 2 E1-1 White (001-315) Orange (001-317) Blue (001-320)

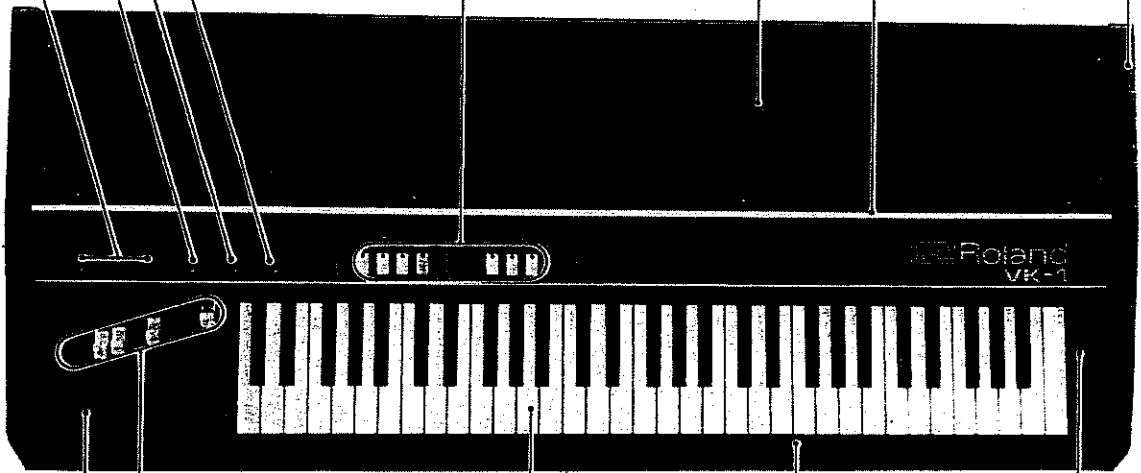

Endblock H21
 (091H021)

Drawbar (set)
 RD-19C

Keyboard
 SK361-A

Panel H67
 (072H067)

Endblock H22
 (091H022)

DISASSEMBLY

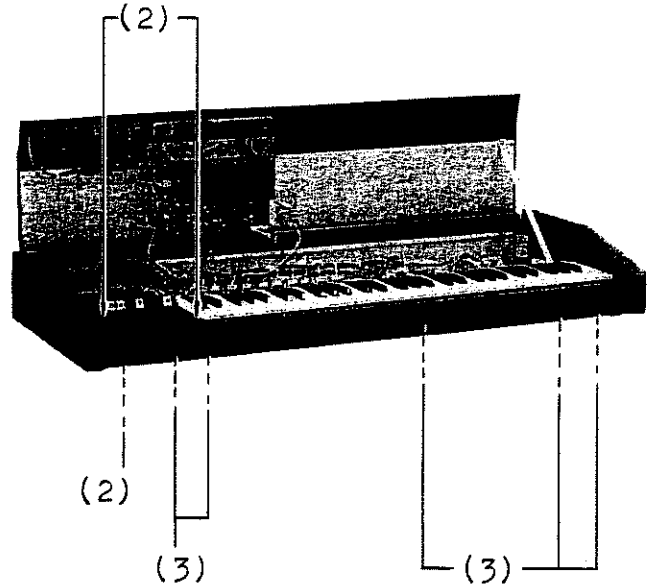
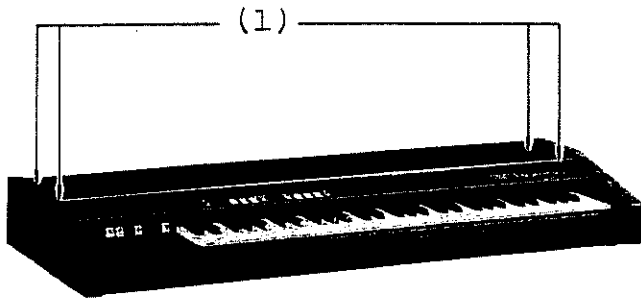

REMOVAL SCREWS:

- (1): Top panel (four machine)
- (2): Left hand Endblock
(two wood, one machine)
- (3): Keyboard (five machine)

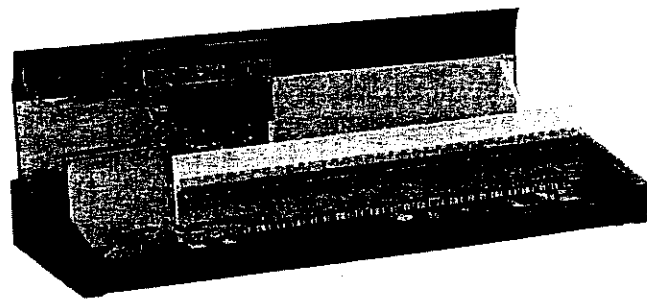

CHANGE to DIFFERENT TYPES

⇒ with SERIAL NUMBER 960900

Detail in PARTS LIST on PAGE 10

Switch HSW0372-1-30 (001-206)

Hinge H11 (059H011)

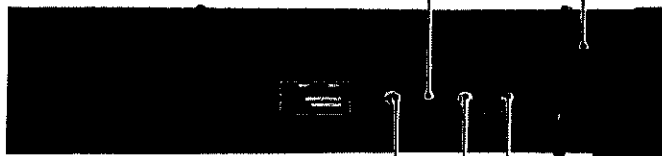

Jack HLJ0259-01-030
(009-021)

Jack HLJ0259-01-020
(009-057)

Switch

SDA1SA-1 (001-258)	100V
SDA2SA-1 (001-259)	117V
SDA4SA-1 (001-260)	220/240V

Rubber foot G-5
(111-021)

MEMO

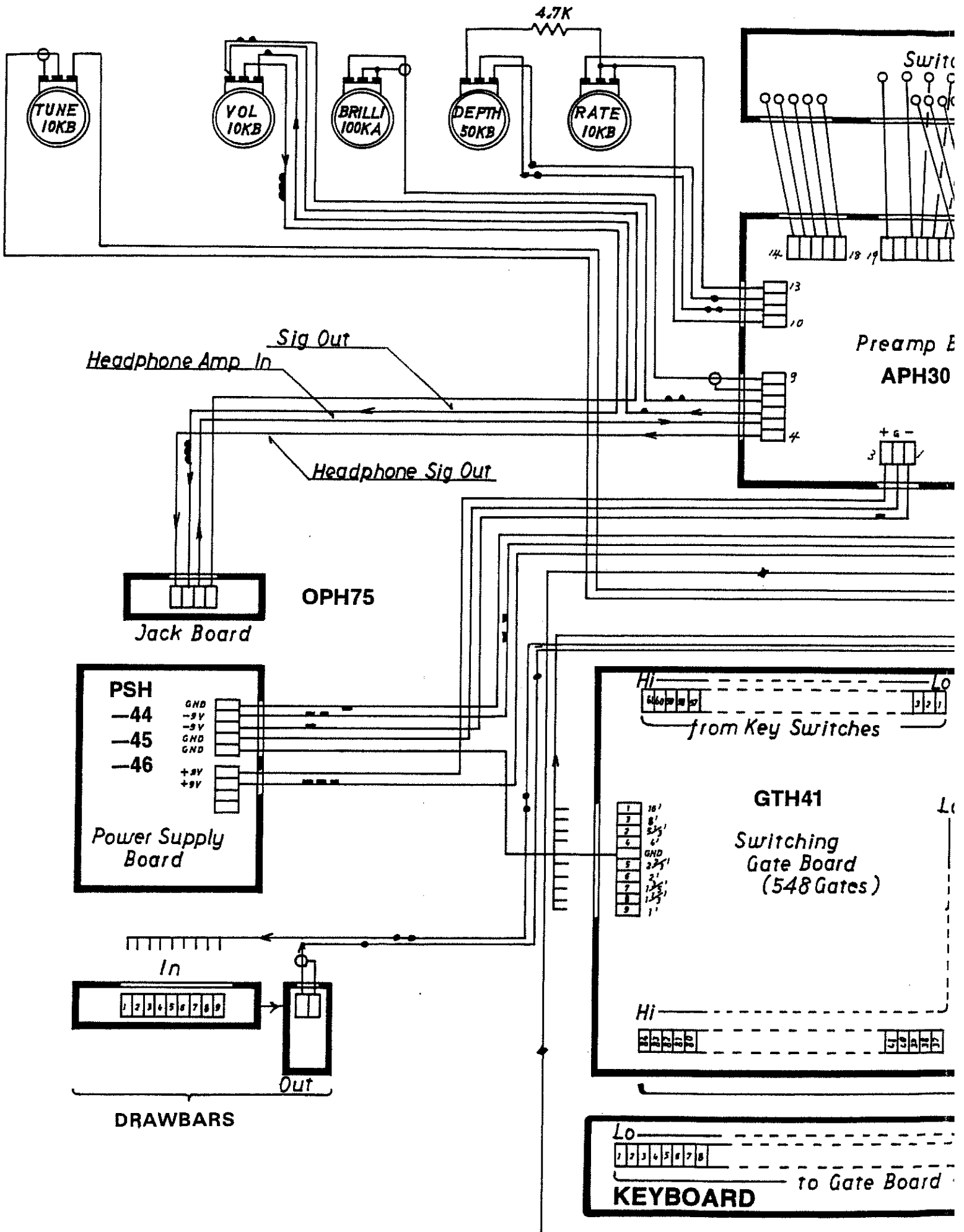

HOW TO FOLD/SPREAD RELATED
PAGES for FACING PAGES

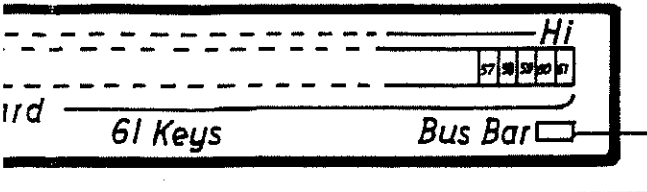
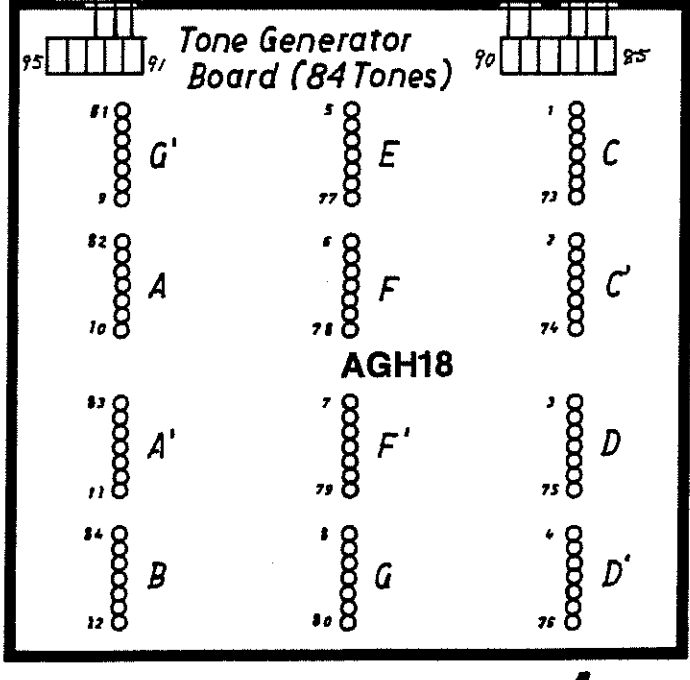
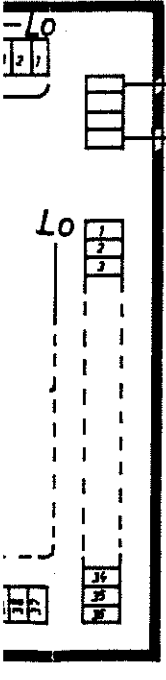
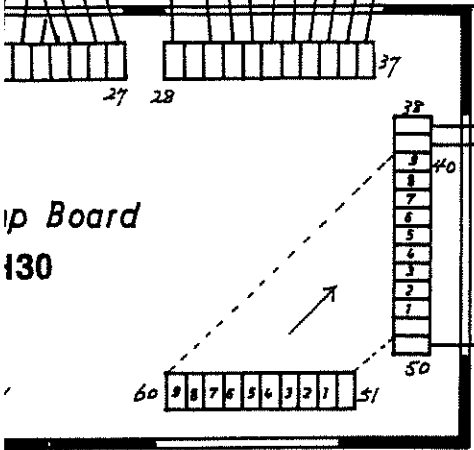
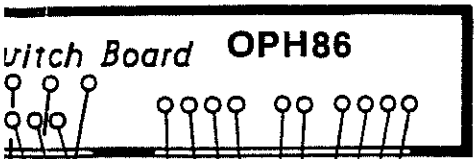

Overall Diagram

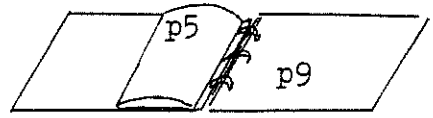

Gate
Circuit-PC layout



Adjustment

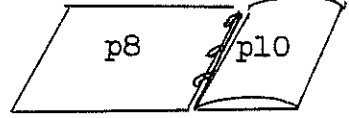

Guide marks for
easier flow line
tracking.

WIRING DIAGRAM

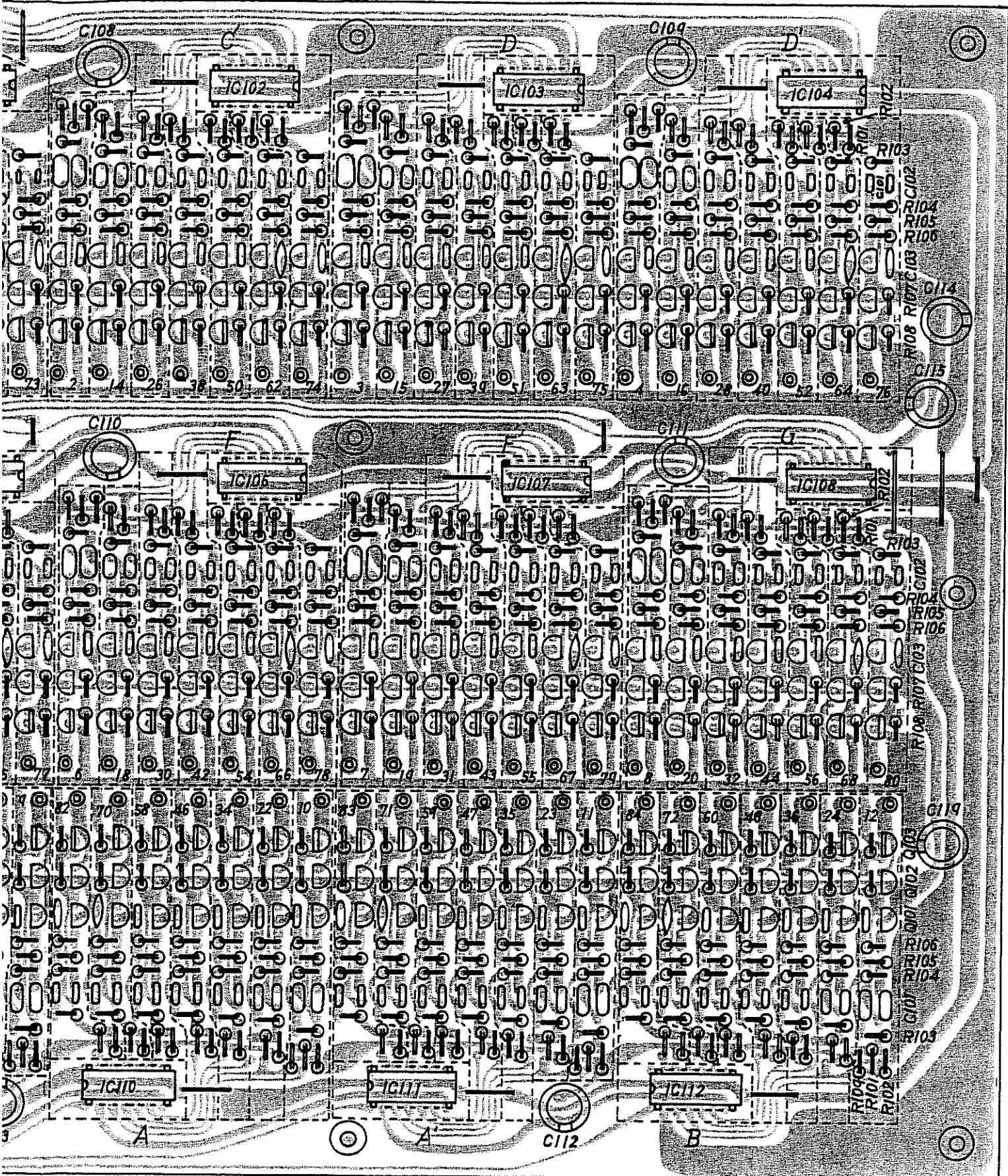

52H198A

AGH18A (144H018A)

Figure 1 shows a clarified Gate-Analog keying circuits with their component- connector- location duplicating those on pc board, GTH41.

Each IC keyer in 16-foot (IC1-16) represents nine circuits in individual column, e. g. IC16-165, to which the same switch numbering is applied.

Control pins (CONT) of the same sw are tied together through foil pat with the others.

All analog keying circuits are ide the following manner:

For example, when C1 key is played

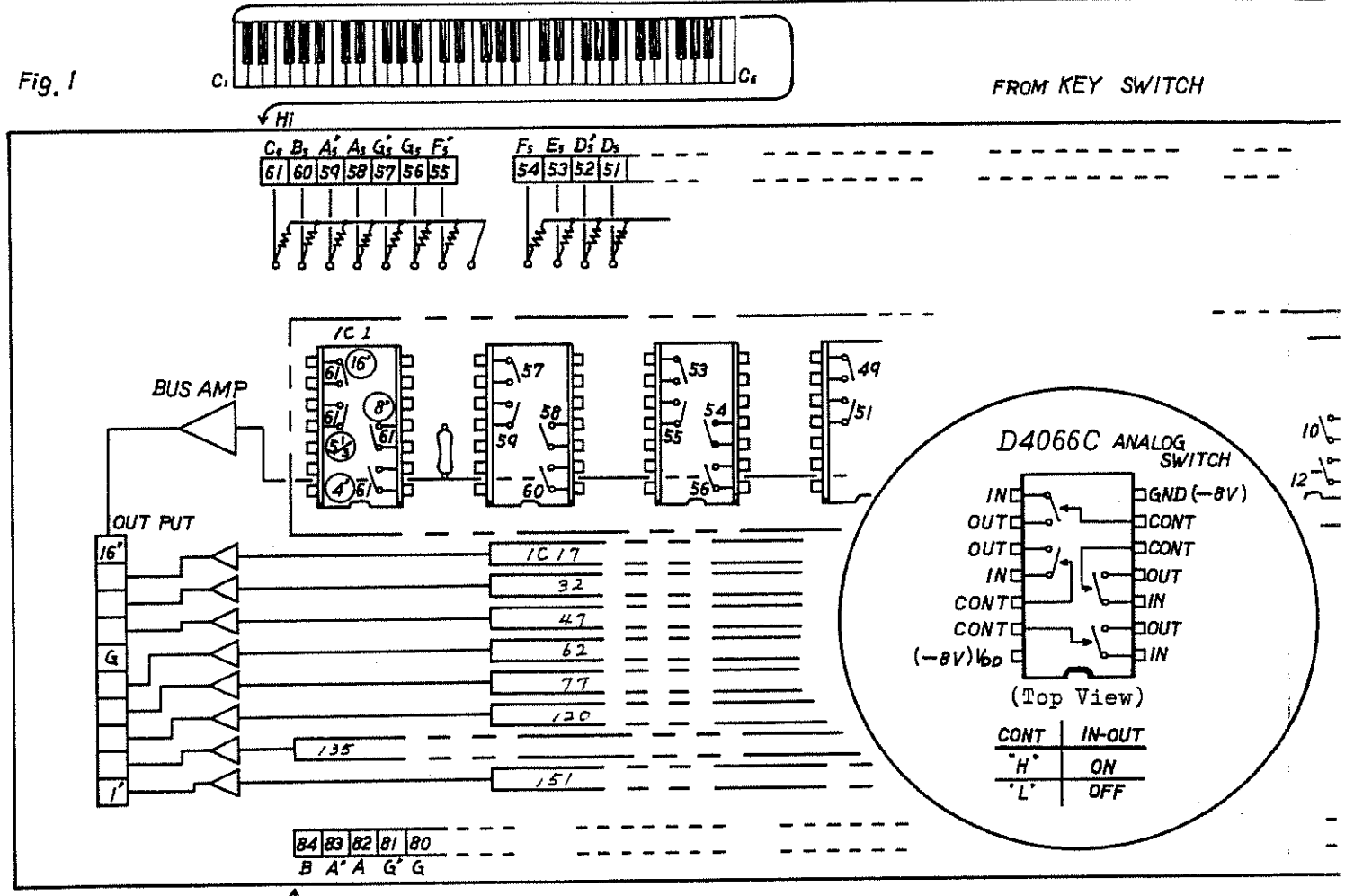

Table 1

TONE GENERATOR OUT PUT NO.	C ₆	B ₅	A ₄	A ₃	G ₂	G ₁	F ₁	F ₂	E ₂	D ₂	D ₁	C ₂	C ₁	B ₅	A ₄	A ₃	G ₂	G ₁	F ₁	F ₂	E ₂	D ₂	D ₁	C ₂	C ₁	B ₅	A ₄	A ₃	G ₂	G ₁	F ₁	F ₂	E ₂	D ₂	D ₁	C ₂	C ₁	B ₅	A ₄	A ₃	G ₂	G ₁	F ₁	F ₂	E ₂	D ₂	D ₁	C ₂	C ₁	B ₅	A ₄	A ₃	G ₂	G ₁	F ₁	F ₂	E ₂	D ₂	D ₁	C ₂	C ₁	B ₅	A ₄	A ₃	G ₂	G ₁	F ₁	F ₂	E ₂	D ₂	D ₁	C ₂	C ₁	B ₅	A ₄	A ₃	G ₂	G ₁	F ₁	F ₂	E ₂	D ₂	D ₁	C ₂	C ₁	B ₅	A ₄	A ₃	G ₂	G ₁	F ₁	F ₂	E ₂	D ₂	D ₁	C ₂	C ₁	B ₅	A ₄	A ₃	G ₂	G ₁	F ₁	F ₂	E ₂	D ₂	D ₁	C ₂	C ₁	B ₅	A ₄	A ₃	G ₂	G ₁	F ₁	F ₂	E ₂	D ₂	D ₁	C ₂	C ₁	B ₅	A ₄	A ₃	G ₂	G ₁	F ₁	F ₂	E ₂	D ₂	D ₁	C ₂	C ₁	B ₅	A ₄	A ₃	G ₂	G ₁	F ₁	F ₂	E ₂	D ₂	D ₁	C ₂	C ₁	B ₅	A ₄	A ₃	G ₂	G ₁	F ₁	F ₂	E ₂	D ₂	D ₁	C ₂	C ₁	B ₅	A ₄	A ₃	G ₂	G ₁	F ₁	F ₂	E ₂	D ₂	D ₁	C ₂	C ₁	B ₅	A ₄	A ₃	G ₂	G ₁	F ₁	F ₂	E ₂	D ₂	D ₁	C ₂	C ₁	B ₅	A ₄	A ₃	G ₂	G ₁	F ₁	F ₂	E ₂	D ₂	D ₁	C ₂	C ₁	B ₅	A ₄	A ₃	G ₂	G ₁	F ₁	F ₂	E ₂	D ₂	D ₁	C ₂	C ₁	B ₅	A ₄	A ₃	G ₂	G ₁	F ₁	F ₂	E ₂	D ₂	D ₁	C ₂	C ₁	B ₅	A ₄	A ₃	G ₂	G ₁	F ₁	F ₂	E ₂	D ₂	D ₁	C ₂	C ₁	B ₅	A ₄	A ₃	G ₂	G ₁	F ₁	F ₂	E ₂	D ₂	D ₁	C ₂	C ₁	B ₅	A ₄	A ₃	G ₂	G ₁	F ₁	F ₂	E ₂	D ₂	D ₁	C ₂	C ₁	B ₅	A ₄	A ₃	G ₂	G ₁	F ₁	F ₂	E ₂	D ₂	D ₁	C ₂	C ₁	B ₅	A ₄	A ₃	G ₂	G ₁	F ₁	F ₂	E ₂	D ₂	D ₁	C ₂	C ₁	B ₅	A ₄	A ₃	G ₂	G ₁	F ₁	F ₂	E ₂	D ₂	D ₁	C ₂	C ₁	B ₅	A ₄	A ₃	G ₂	G ₁	F ₁	F ₂	E ₂	D ₂	D ₁	C ₂	C ₁	B ₅	A ₄	A ₃	G ₂	G ₁	F ₁	F ₂	E ₂	D ₂	D ₁	C ₂	C ₁	B ₅	A ₄	A ₃	G ₂	G ₁	F ₁	F ₂	E ₂	D ₂	D ₁	C ₂	C ₁	B ₅	A ₄	A ₃	G ₂	G ₁	F ₁	F ₂	E ₂	D ₂	D ₁	C ₂	C ₁	B ₅	A ₄	A ₃	G ₂	G ₁	F ₁	F ₂	E ₂	D ₂	D ₁	C ₂	C ₁	B ₅	A ₄	A ₃	G ₂	G ₁	F ₁	F ₂	E ₂	D ₂	D ₁	C ₂	C ₁	B ₅	A ₄	A ₃	G ₂	G ₁	F ₁	F ₂	E ₂	D ₂	D ₁	C ₂	C ₁	B ₅	A ₄	A ₃	G ₂	G ₁	F ₁	F ₂	E ₂	D ₂	D ₁	C ₂	C ₁	B ₅	A ₄	A ₃	G ₂	G ₁	F ₁	F ₂	E ₂	D ₂	D ₁	C ₂	C ₁	B ₅	A ₄	A ₃	G ₂	G ₁	F ₁	F ₂	E ₂	D ₂	D ₁	C ₂	C ₁	B ₅	A ₄	A ₃	G ₂	G ₁	F ₁	F ₂	E ₂	D ₂	D ₁	C ₂	C ₁	B ₅	A ₄	A ₃	G ₂	G ₁	F ₁	F ₂	E ₂	D ₂	D ₁	C ₂	C ₁	B ₅	A ₄	A ₃	G ₂	G ₁	F ₁	F ₂	E ₂	D ₂	D ₁	C ₂	C ₁	B ₅	A ₄	A ₃	G ₂	G ₁	F ₁	F ₂	E ₂	D ₂	D ₁	C ₂	C ₁	B ₅	A ₄	A ₃	G ₂	G ₁	F ₁	F ₂	E ₂	D ₂	D ₁	C ₂	C ₁	B ₅	A ₄	A ₃	G ₂	G ₁	F ₁	F ₂	E ₂	D ₂	D ₁	C ₂	C ₁	B ₅	A ₄	A ₃	G ₂	G ₁	F ₁	F ₂	E ₂	D ₂	D ₁	C ₂	C ₁	B ₅	A ₄	A ₃	G ₂	G ₁	F ₁	F ₂	E ₂	D ₂	D ₁	C ₂	C ₁	B ₅	A ₄	A ₃	G ₂	G ₁	F ₁	F ₂	E ₂	D ₂	D ₁	C ₂	C ₁	B ₅	A ₄	A ₃	G ₂	G ₁	F ₁	F ₂	E ₂	D ₂	D ₁	C ₂	C ₁	B ₅	A ₄	A ₃	G ₂	G ₁	F ₁	F ₂	E ₂	D ₂	D ₁	C ₂	C ₁	B ₅	A ₄	A ₃	G ₂	G ₁	F ₁	F ₂	E ₂	D ₂	D ₁	C ₂	C ₁	B ₅	A ₄	A ₃	G ₂	G ₁	F ₁	F ₂	E ₂	D ₂	D ₁	C ₂	C ₁	B ₅	A ₄	A ₃	G ₂	G ₁	F ₁	F ₂	E ₂	D ₂	D ₁	C ₂	C ₁	B ₅	A ₄	A ₃	G ₂	G ₁	F ₁	F ₂	E ₂	D ₂	D ₁	C ₂	C ₁	B ₅	A ₄	A ₃	G ₂	G ₁	F ₁	F ₂	E ₂	D ₂	D ₁	C ₂	C ₁	B ₅	A ₄	A ₃	G ₂	G ₁	F ₁	F ₂	E ₂	D ₂	D ₁	C ₂	C ₁	B ₅	A ₄	A ₃	G ₂	G ₁	F ₁	F ₂	E ₂	D ₂	D ₁	C ₂	C ₁	B ₅	A ₄	A ₃	G ₂	G ₁	F ₁	F ₂	E ₂	D ₂	D ₁	C ₂	C ₁	B ₅	A ₄	A ₃	G ₂	G ₁	F ₁	F ₂	E ₂	D ₂	D ₁	C ₂	C ₁	B ₅	A ₄	A ₃	G ₂	G ₁	F ₁	F ₂	E ₂	D ₂	D ₁	C ₂	C ₁	B ₅	A ₄	A ₃	G ₂	G ₁	F ₁	F ₂	E ₂	D ₂	D ₁	C ₂	C ₁	B ₅	A ₄	A ₃	G ₂	G ₁	F ₁	F ₂	E ₂	D ₂	D ₁	C ₂	C ₁	B ₅	A ₄	A ₃	G ₂	G ₁	F ₁	F ₂	E ₂	D ₂	D ₁	C ₂	C ₁	B ₅	A ₄	A ₃	G ₂	G ₁	F ₁	F ₂	E ₂	D ₂	D ₁	C ₂	C ₁	B ₅	A ₄	A ₃	G ₂	G ₁	F ₁	F ₂	E ₂	D ₂	D ₁	C ₂	C ₁	B ₅	A ₄	A ₃	G ₂	G ₁	F ₁	F ₂	E ₂	D ₂	D ₁	C ₂	C ₁	B ₅	A ₄	A ₃	G ₂	G ₁	F ₁	F ₂	E ₂	D ₂	D ₁	C ₂	C ₁	B ₅	A ₄	A ₃	G ₂	G ₁	F ₁	F ₂	E ₂	D ₂	D ₁	C ₂	C ₁	B ₅	A ₄	A ₃	G ₂	G ₁	F ₁	F ₂	E ₂	D ₂	D ₁	C ₂	C ₁	B ₅	A ₄	A ₃	G ₂	G ₁	F ₁	F ₂	E ₂	D ₂	D ₁	C ₂	C ₁	B ₅	A ₄	A ₃	G ₂	G ₁	F ₁	F ₂	E ₂	D ₂	D ₁	C ₂	C ₁	B ₅	A ₄	A ₃	G ₂	G ₁	F ₁	F ₂	E ₂	D ₂	D ₁	C ₂	C ₁	B ₅	A ₄	A ₃	G ₂	G ₁	F ₁	F ₂	E ₂	D ₂	D ₁	C ₂	C ₁	B ₅	A ₄	A ₃	G ₂	G ₁	F ₁	F ₂	E ₂	D ₂	D ₁	C ₂	C ₁	B ₅	A ₄	A ₃	G ₂	G ₁	F ₁	F ₂	E ₂	D ₂	D ₁	C ₂	C ₁	B ₅	A ₄	A ₃	G ₂	G ₁	F ₁	F ₂	E ₂	D ₂	D ₁	C ₂	C ₁	B ₅	A ₄	A ₃	G ₂	G ₁	F ₁	F ₂	E ₂	D ₂	D ₁	C ₂	C ₁	B ₅	A ₄	A ₃	G ₂	G ₁	F ₁	F ₂	E ₂	D ₂	D ₁	C ₂	C ₁	B ₅	A ₄	A ₃	G ₂	G ₁	F ₁	F ₂	E ₂	D ₂	D ₁	C ₂	C ₁	B ₅	A ₄	A ₃	G ₂	G ₁	F ₁	F ₂	E ₂	D ₂	D ₁	C ₂	C ₁	B ₅	A ₄	A ₃	G ₂	G ₁	F ₁	F ₂	E ₂	D ₂	D ₁	C ₂	C ₁	B ₅	A ₄	A ₃	G ₂	G ₁	F ₁	F ₂	E ₂	D ₂	D ₁	C ₂	C ₁	B ₅	A ₄	A ₃	G ₂	G ₁	F ₁	F ₂	E ₂	D ₂	D ₁	C ₂	C ₁	B ₅	A ₄	A ₃	G ₂	G ₁	F ₁	F ₂	E ₂	D ₂	D ₁	C ₂	C ₁	B ₅	A ₄	A ₃	G ₂	G ₁	F ₁	F ₂	E ₂	D ₂	D ₁	C ₂	C ₁	B ₅	A ₄	A ₃	G ₂	G ₁	F ₁	F ₂	E ₂	D ₂	D ₁
----------------------------	----------------	----------------	----------------	----------------	----------------	----------------	----------------	----------------	----------------	----------------	----------------	----------------	----------------	----------------	----------------	----------------	----------------	----------------	----------------	----------------	----------------	----------------	----------------	----------------	----------------	----------------	----------------	----------------	----------------	----------------	----------------	----------------	----------------	----------------	----------------	----------------	----------------	----------------	----------------	----------------	----------------	----------------	----------------	----------------	----------------	----------------	----------------	----------------	----------------	----------------	----------------	----------------	----------------	----------------	----------------	----------------	----------------	----------------	----------------	----------------	----------------	----------------	----------------	----------------	----------------	----------------	----------------	----------------	----------------	----------------	----------------	----------------	----------------	----------------	----------------	----------------	----------------	----------------	----------------	----------------	----------------	----------------	----------------	----------------	----------------	----------------	----------------	----------------	----------------	----------------	----------------	----------------	----------------	----------------	----------------	----------------	----------------	----------------	----------------	----------------	----------------	----------------	----------------	----------------	----------------	----------------	----------------	----------------	----------------	----------------	----------------	----------------	----------------	----------------	----------------	----------------	----------------	----------------	----------------	----------------	----------------	----------------	----------------	----------------	----------------	----------------	----------------	----------------	----------------	----------------	----------------	----------------	----------------	----------------	----------------	----------------	----------------	----------------	----------------	----------------	----------------	----------------	----------------	----------------	----------------	----------------	----------------	----------------	----------------	----------------	----------------	----------------	----------------	----------------	----------------	----------------	----------------	----------------	----------------	----------------	----------------	----------------	----------------	----------------	----------------	----------------	----------------	----------------	----------------	----------------	----------------	----------------	----------------	----------------	----------------	----------------	----------------	----------------	----------------	----------------	----------------	----------------	----------------	----------------	----------------	----------------	----------------	----------------	----------------	----------------	----------------	----------------	----------------	----------------	----------------	----------------	----------------	----------------	----------------	----------------	----------------	----------------	----------------	----------------	----------------	----------------	----------------	----------------	----------------	----------------	----------------	----------------	----------------	----------------	----------------	----------------	----------------	----------------	----------------	----------------	----------------	----------------	----------------	----------------	----------------	----------------	----------------	----------------	----------------	----------------	----------------	----------------	----------------	----------------	----------------	----------------	----------------	----------------	----------------	----------------	----------------	----------------	----------------	----------------	----------------	----------------	----------------	----------------	----------------	----------------	----------------	----------------	----------------	----------------	----------------	----------------	----------------	----------------	----------------	----------------	----------------	----------------	----------------	----------------	----------------	----------------	----------------	----------------	----------------	----------------	----------------	----------------	----------------	----------------	----------------	----------------	----------------	----------------	----------------	----------------	----------------	----------------	----------------	----------------	----------------	----------------	----------------	----------------	----------------	----------------	----------------	----------------	----------------	----------------	----------------	----------------	----------------	----------------	----------------	----------------	----------------	----------------	----------------	----------------	----------------	----------------	----------------	----------------	----------------	----------------	----------------	----------------	----------------	----------------	----------------	----------------	----------------	----------------	----------------	----------------	----------------	----------------	----------------	----------------	----------------	----------------	----------------	----------------	----------------	----------------	----------------	----------------	----------------	----------------	----------------	----------------	----------------	----------------	----------------	----------------	----------------	----------------	----------------	----------------	----------------	----------------	----------------	----------------	----------------	----------------	----------------	----------------	----------------	----------------	----------------	----------------	----------------	----------------	----------------	----------------	----------------	----------------	----------------	----------------	----------------	----------------	----------------	----------------	----------------	----------------	----------------	----------------	----------------	----------------	----------------	----------------	----------------	----------------	----------------	----------------	----------------	----------------	----------------	----------------	----------------	----------------	----------------	----------------	----------------	----------------	----------------	----------------	----------------	----------------	----------------	----------------	----------------	----------------	----------------	----------------	----------------	----------------	----------------	----------------	----------------	----------------	----------------	----------------	----------------	----------------	----------------	----------------	----------------	----------------	----------------	----------------	----------------	----------------	----------------	----------------	----------------	----------------	----------------	----------------	----------------	----------------	----------------	----------------	----------------	----------------	----------------	----------------	----------------	----------------	----------------	----------------	----------------	----------------	----------------	----------------	----------------	----------------	----------------	----------------	----------------	----------------	----------------	----------------	----------------	----------------	----------------	----------------	----------------	----------------	----------------	----------------	----------------	----------------	----------------	----------------	----------------	----------------	----------------	----------------	----------------	----------------	----------------	----------------	----------------	----------------	----------------	----------------	----------------	----------------	----------------	----------------	----------------	----------------	----------------	----------------	----------------	----------------	----------------	----------------	----------------	----------------	----------------	----------------	----------------	----------------	----------------	----------------	----------------	----------------	----------------	----------------	----------------	----------------	----------------	----------------	----------------	----------------	----------------	----------------	----------------	----------------	----------------	----------------	----------------	----------------	----------------	----------------	----------------	----------------	----------------	----------------	----------------	----------------	----------------	----------------	----------------	----------------	----------------	----------------	----------------	----------------	----------------	----------------	----------------	----------------	----------------	----------------	----------------	----------------	----------------	----------------	----------------	----------------	----------------	----------------	----------------	----------------	----------------	----------------	----------------	----------------	----------------	----------------	----------------	----------------	----------------	----------------	----------------	----------------	----------------	----------------	----------------	----------------	----------------	----------------	----------------	----------------	----------------	----------------	----------------	----------------	----------------	----------------	----------------	----------------	----------------	----------------	----------------	----------------	----------------	----------------	----------------	----------------	----------------	----------------	----------------	----------------	----------------	----------------	----------------	----------------	----------------	----------------	----------------	----------------	----------------	----------------	----------------	----------------	----------------	----------------	----------------	----------------	----------------	----------------	----------------	----------------	----------------	----------------	----------------	----------------	----------------	----------------	----------------	----------------	----------------	----------------	----------------	----------------	----------------	----------------	----------------	----------------	----------------	----------------	----------------	----------------	----------------	----------------	----------------	----------------	----------------	----------------	----------------	----------------	----------------	----------------	----------------	----------------	----------------	----------------	----------------	----------------	----------------	----------------	----------------	----------------	----------------	----------------	----------------	----------------	----------------	----------------	----------------	----------------	----------------	----------------	----------------	----------------	----------------	----------------	----------------	----------------	----------------	----------------	----------------	----------------	----------------	----------------	----------------	----------------	----------------	----------------	----------------	----------------	----------------	----------------	----------------	----------------	----------------	----------------	----------------	----------------	----------------	----------------	----------------	----------------	----------------	----------------	----------------	----------------	----------------	----------------	----------------	----------------	----------------	----------------	----------------	----------------	----------------	----------------	----------------	----------------	----------------	----------------	----------------	----------------	----------------	----------------	----------------	----------------	----------------	----------------	----------------	----------------	----------------	----------------	----------------	----------------	----------------	----------------	----------------	----------------	----------------	----------------	----------------	----------------	----------------	----------------	----------------	----------------	----------------	----------------	----------------	----------------	----------------	----------------	----------------	----------------	----------------	----------------	----------------	----------------	----------------	----------------	----------------	----------------	----------------	----------------	----------------	----------------	----------------	----------------	----------------	----------------	----------------	----------------	----------------	----------------	----------------	----------------	----------------	----------------	----------------	----------------	----------------	----------------	----------------	----------------	----------------	----------------	----------------	----------------	----------------	----------------	----------------	----------------	----------------	----------------	----------------	----------------	----------------	----------------	----------------	----------------	----------------	----------------	----------------	----------------	----------------	----------------	----------------	----------------	----------------	----------------	----------------	----------------	----------------	----------------	----------------	----------------	----------------	----------------	----------------	----------------	----------------	----------------	----------------	----------------	----------------	----------------	----------------	----------------	----------------	----------------	----------------	----------------	----------------	----------------	----------------	----------------	----------------	----------------	----------------	----------------	----------------	----------------	----------------	----------------	----------------	----------------	----------------	----------------	----------------	----------------	----------------	----------------	----------------	----------------	----------------	----------------	----------------	----------------	----------------	----------------	----------------	----------------	----------------	----------------	----------------	----------------	----------------	----------------	----------------	----------------	----------------	----------------	----------------	----------------	----------------	----------------	----------------	----------------	----------------	----------------	----------------	----------------	----------------	----------------	----------------	----------------	----------------	----------------	----------------	----------------	----------------	----------------	----------------	----------------	----------------	----------------	----------------	----------------	----------------	----------------	----------------	----------------	----------------	----------------	----------------	----------------	----------------	----------------	----------------	----------------	----------------	----------------	----------------	----------------	----------------	----------------	----------------	----------------	----------------	----------------	----------------	----------------	----------------	----------------	----------------	----------------	----------------	----------------	----------------	----------------	----------------	----------------	----------------	----------------	----------------	----------------	----------------	----------------	----------------	----------------	----------------	----------------	----------------	----------------	----------------	----------------	----------------	----------------	----------------	----------------	----------------	----------------	----------------	----------------	----------------	----------------	----------------	----------------	----------------	----------------	----------------	----------------	----------------	----------------	----------------	----------------	----------------	----------------	----------------	----------------	----------------	----------------	----------------	----------------	----------------	----------------	----------------	----------------	----------------	----------------	----------------	----------------	----------------	----------------	----------------	----------------	----------------	----------------	----------------	----------------	----------------

the same switch number in a column through foil pattern to be in parallel. Units are identical and function in the same way. When a key is played, keyboard C1 keyswitch

applies +9 volts to SW-1 gates (CONT, pin 6) of IC16, 31, 46, 61, 76, 91, 134, 150 and 165, turning switches on, allowing audio signals from tone generators to pass the keying groups. Exceptions are IC1 and IC135, they are responsible for keying C6 signals of all footage minus 1'.

The RESISTOR ARRAYS for each IC in a footage are tied together in groups at their output and form IC keying groups connected to a BUS AMP.

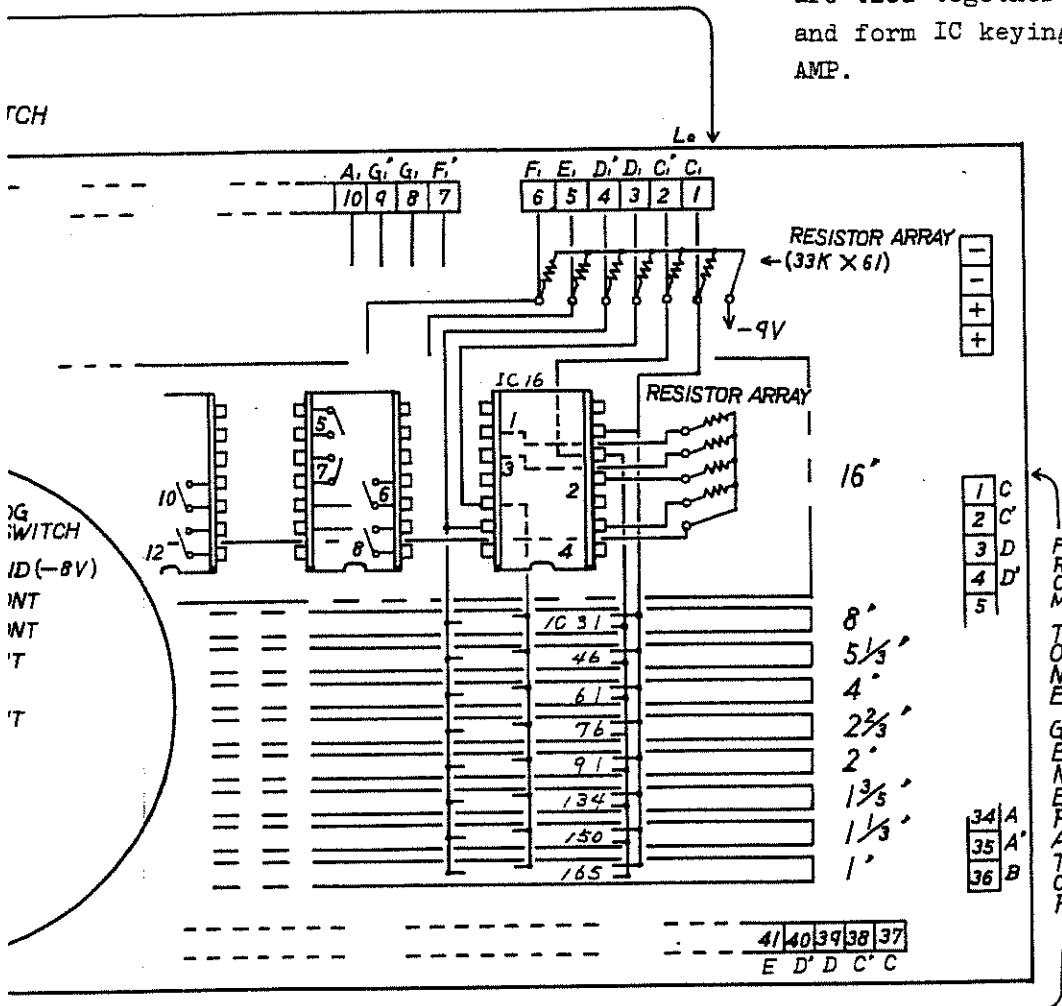

D ₂	C ₂	C ₁	B ₂	A ₂	A ₁	G ₂	G ₁	F ₂	F ₁	E ₂	D ₂	D ₁	C ₂	C ₁	B ₁	A ₁	A ₂	G ₁	G ₂	F ₁	F ₂	E ₁	E ₂	D ₁	D ₂	C ₁	C ₂	B ₁	A ₁	A ₂	G ₁	G ₂	F ₁	F ₂	E ₁	E ₂	D ₁	D ₂	C ₁	C ₂	B ₁	A ₁	A ₂	G ₁	G ₂	F ₁	F ₂	E ₁	E ₂	D ₁	D ₂	C ₁	C ₂	B ₁	A ₁	A ₂	G ₁	G ₂	F ₁	F ₂	E ₁	E ₂	D ₁	D ₂	C ₁	C ₂	B ₁	A ₁	A ₂	G ₁	G ₂	F ₁	F ₂	E ₁	E ₂	D ₁	D ₂	C ₁	C ₂	B ₁	A ₁	A ₂	G ₁	G ₂	F ₁	F ₂	E ₁	E ₂	D ₁	D ₂	C ₁	C ₂	B ₁	A ₁	A ₂	G ₁	G ₂	F ₁	F ₂	E ₁	E ₂	D ₁	D ₂	C ₁	C ₂	B ₁	A ₁	A ₂	G ₁	G ₂	F ₁	F ₂	E ₁	E ₂	D ₁	D ₂	C ₁	C ₂	B ₁	A ₁	A ₂	G ₁	G ₂	F ₁	F ₂	E ₁	E ₂	D ₁	D ₂	C ₁	C ₂	B ₁	A ₁	A ₂	G ₁	G ₂	F ₁	F ₂	E ₁	E ₂	D ₁	D ₂	C ₁	C ₂	B ₁	A ₁	A ₂	G ₁	G ₂	F ₁	F ₂	E ₁	E ₂	D ₁	D ₂	C ₁	C ₂	B ₁	A ₁	A ₂	G ₁	G ₂	F ₁	F ₂	E ₁	E ₂	D ₁	D ₂	C ₁	C ₂	B ₁	A ₁	A ₂	G ₁	G ₂	F ₁	F ₂	E ₁	E ₂	D ₁	D ₂	C ₁	C ₂	B ₁	A ₁	A ₂	G ₁	G ₂	F ₁	F ₂	E ₁	E ₂	D ₁	D ₂	C ₁	C ₂	B ₁	A ₁	A ₂	G ₁	G ₂	F ₁	F ₂	E ₁	E ₂	D ₁	D ₂	C ₁	C ₂	B ₁	A ₁	A ₂	G ₁	G ₂	F ₁	F ₂	E ₁	E ₂	D ₁	D ₂	C ₁	C ₂	B ₁	A ₁	A ₂	G ₁	G ₂	F ₁	F ₂	E ₁	E ₂	D ₁	D ₂	C ₁	C ₂	B ₁	A ₁	A ₂	G ₁	G ₂	F ₁	F ₂	E ₁	E ₂	D ₁	D ₂	C ₁	C ₂	B ₁	A ₁	A ₂	G ₁	G ₂	F ₁	F ₂	E ₁	E ₂	D ₁	D ₂	C ₁	C ₂	B ₁	A ₁	A ₂	G ₁	G ₂	F ₁	F ₂	E ₁	E ₂	D ₁	D ₂	C ₁	C ₂	B ₁	A ₁	A ₂	G ₁	G ₂	F ₁	F ₂	E ₁	E ₂	D ₁	D ₂	C ₁	C ₂	B ₁	A ₁	A ₂	G ₁	G ₂	F ₁	F ₂	E ₁	E ₂	D ₁	D ₂	C ₁	C ₂	B ₁	A ₁	A ₂	G ₁	G ₂	F ₁	F ₂	E ₁	E ₂	D ₁	D ₂	C ₁	C ₂	B ₁	A ₁	A ₂	G ₁	G ₂	F ₁	F ₂	E ₁	E ₂	D ₁	D ₂	C ₁	C ₂	B ₁	A ₁	A ₂	G ₁	G ₂	F ₁	F ₂	E ₁	E ₂	D ₁	D ₂	C ₁	C ₂	B ₁	A ₁	A ₂	G ₁	G ₂	F ₁	F ₂	E ₁	E ₂	D ₁	D ₂	C ₁	C ₂	B ₁	A ₁	A ₂	G ₁	G ₂	F ₁	F ₂	E ₁	E ₂	D ₁	D ₂	C ₁	C ₂	B ₁	A ₁	A ₂	G ₁	G ₂	F ₁	F ₂	E ₁	E ₂	D ₁	D ₂	C ₁	C ₂	B ₁	A ₁	A ₂	G ₁	G ₂	F ₁	F ₂	E ₁	E ₂	D ₁	D ₂	C ₁	C ₂	B ₁	A ₁	A ₂	G ₁	G ₂	F ₁	F ₂	E ₁	E ₂	D ₁	D ₂	C ₁	C ₂	B ₁	A ₁	A ₂	G ₁	G ₂	F ₁	F ₂	E ₁	E ₂	D ₁	D ₂	C ₁	C ₂	B ₁	A ₁	A ₂	G ₁	G ₂	F ₁	F ₂	E ₁	E ₂	D ₁	D ₂	C ₁	C ₂	B ₁	A ₁	A ₂	G ₁	G ₂	F ₁	F ₂	E ₁	E ₂	D ₁	D ₂	C ₁	C ₂	B ₁	A ₁	A ₂	G ₁	G ₂	F ₁	F ₂	E ₁	E ₂	D ₁	D ₂	C ₁	C ₂	B ₁	A ₁	A ₂	G ₁	G ₂	F ₁	F ₂	E ₁	E ₂	D ₁	D ₂	C ₁	C ₂	B ₁	A ₁	A ₂	G ₁	G ₂	F ₁	F ₂	E ₁	E ₂	D ₁	D ₂	C ₁	C ₂	B ₁	A ₁	A ₂	G ₁	G ₂	F ₁	F ₂	E ₁	E ₂	D ₁	D ₂	C ₁	C ₂	B ₁	A ₁	A ₂	G ₁	G ₂	F ₁	F ₂	E ₁	E ₂	D ₁	D ₂	C ₁	C ₂	B ₁	A ₁	A ₂	G ₁	G ₂	F ₁	F ₂	E ₁	E ₂	D ₁	D ₂	C ₁	C ₂	B ₁	A ₁	A ₂	G ₁	G ₂	F ₁	F ₂	E ₁	E ₂	D ₁	D ₂	C ₁	C ₂	B ₁	A ₁	A ₂	G ₁	G ₂	F ₁	F ₂	E ₁	E ₂	D ₁	D ₂	C ₁	C ₂	B ₁	A ₁	A ₂	G ₁	G ₂	F ₁	F ₂	E ₁	E ₂	D ₁	D ₂	C ₁	C ₂	B ₁	A ₁	A ₂	G ₁	G ₂	F ₁	F ₂	E ₁	E ₂	D ₁	D ₂	C ₁	C ₂	B ₁	A ₁	A ₂	G ₁	G ₂	F ₁	F ₂	E ₁	E ₂	D ₁	D ₂	C ₁	C ₂	B ₁	A ₁	A ₂	G ₁	G ₂	F ₁	F ₂	E ₁	E ₂	D ₁	D ₂	C ₁	C ₂	B ₁	A ₁	A ₂	G ₁	G ₂	F ₁	F ₂	E ₁	E ₂	D ₁	D ₂	C ₁	C ₂	B ₁	A ₁	A ₂	G ₁	G ₂	F ₁	F ₂	E ₁	E ₂	D ₁	D ₂	C ₁	C ₂	B ₁	A ₁	A ₂	G ₁	G ₂	F ₁	F ₂	E ₁	E ₂	D ₁	D ₂	C ₁	C ₂	B ₁	A ₁	A ₂	G ₁	G ₂	F ₁	F ₂	E ₁	E ₂	D ₁	D ₂	C ₁	C ₂	B ₁	A ₁	A ₂	G ₁	G ₂	F ₁	F ₂	E ₁	E ₂	D ₁	D ₂	C ₁	C ₂	B ₁	A ₁	A ₂	G ₁	G ₂	F ₁	F ₂	E ₁	E ₂	D ₁	D ₂	C ₁	C ₂	B ₁	A ₁	A ₂	G ₁	G ₂	F ₁	F ₂	E ₁	E ₂	D ₁	D ₂	C ₁	C ₂	B ₁	A ₁	A ₂	G ₁	G ₂	F ₁	F ₂	E ₁	E ₂	D ₁	D ₂	C ₁	C ₂	B ₁	A ₁	A ₂	G ₁	G ₂	F ₁	F ₂	E ₁	E ₂	D ₁	D ₂	C ₁	C ₂	B ₁	A ₁	A ₂	G ₁	G ₂	F ₁	F ₂	E ₁	E ₂	D ₁	D ₂	C ₁	C ₂	B ₁	A ₁	A ₂	G ₁	G ₂	F ₁	F ₂	E ₁	E ₂	D ₁	D ₂	C ₁	C ₂	B ₁	A ₁	A ₂	G ₁	G ₂	F ₁	F ₂	E ₁	E ₂	D ₁	D ₂	C ₁	C ₂	B ₁	A ₁	A ₂	G ₁	G ₂	F ₁	F ₂	E ₁	E ₂	D ₁	D ₂	C ₁	C ₂	B ₁	A ₁	A ₂	G ₁	G ₂	F ₁	F ₂	E ₁	E ₂	D ₁	D ₂	C ₁	C ₂	B ₁	A ₁	A ₂	G ₁	G ₂	F ₁	F ₂	E ₁	E ₂	D ₁	D ₂	C ₁	C ₂	B ₁	A ₁	A ₂	G ₁	G ₂	F ₁	F ₂	E ₁	E ₂	D ₁	D ₂	C ₁	C ₂	B ₁	A ₁	A ₂	G ₁	G ₂	F ₁	F ₂	E ₁	E ₂	D ₁	D ₂	C ₁	C ₂	B ₁	A ₁	A ₂	G ₁	G ₂	F ₁	F ₂	E ₁	E ₂	D ₁	D ₂	C ₁	C ₂	B ₁	A ₁	A ₂	G ₁	G ₂	F ₁	F ₂	E ₁	E ₂	D ₁	D ₂	C ₁	C ₂	B ₁	A ₁	A ₂	G ₁	G ₂	F ₁	F ₂	E ₁	E ₂	D ₁	D ₂	C ₁	C ₂	B ₁	A ₁	A ₂	G ₁	G ₂	F ₁	F ₂	E ₁	E ₂	D ₁	D ₂	C ₁	C ₂	B ₁	A ₁	A ₂	G ₁	G ₂	F ₁	F ₂	E ₁	E ₂	D ₁	D ₂	C ₁	C ₂	B ₁	A ₁	A ₂	G ₁	G ₂	F ₁	F ₂	E ₁	E ₂	D ₁	D ₂	C ₁	C ₂	B ₁	A ₁	A ₂	G ₁	G ₂	F ₁	F ₂	E ₁	E ₂	D ₁	D ₂	C ₁	C ₂	B ₁	A ₁	A ₂	G ₁	G ₂	F ₁	F ₂	E ₁	E ₂	D ₁	D ₂	C ₁	C ₂	B ₁	A ₁	A ₂	G ₁	G ₂	F ₁	F ₂	E ₁	E ₂	D ₁	D ₂	C ₁	C ₂	B ₁	A ₁	A ₂	G ₁	G ₂	F ₁	F ₂	E ₁	E ₂	D ₁	D ₂	C ₁	C ₂	B ₁	A ₁	A ₂	G ₁	G ₂	F ₁	F ₂	E ₁	E ₂	D ₁	D ₂	C ₁	C ₂	B ₁	A ₁	A ₂	G ₁	G ₂	F ₁	F ₂	E ₁	E ₂	D ₁	D ₂	C ₁	C ₂	B ₁	A ₁	A ₂	G ₁	G ₂	F ₁	F<
----------------	----------------	----------------	----------------	----------------	----------------	----------------	----------------	----------------	----------------	----------------	----------------	----------------	----------------	----------------	----------------	----------------	----------------	----------------	----------------	----------------	----------------	----------------	----------------	----------------	----------------	----------------	----------------	----------------	----------------	----------------	----------------	----------------	----------------	----------------	----------------	----------------	----------------	----------------	----------------	----------------	----------------	----------------	----------------	----------------	----------------	----------------	----------------	----------------	----------------	----------------	----------------	----------------	----------------	----------------	----------------	----------------	----------------	----------------	----------------	----------------	----------------	----------------	----------------	----------------	----------------	----------------	----------------	----------------	----------------	----------------	----------------	----------------	----------------	----------------	----------------	----------------	----------------	----------------	----------------	----------------	----------------	----------------	----------------	----------------	----------------	----------------	----------------	----------------	----------------	----------------	----------------	----------------	----------------	----------------	----------------	----------------	----------------	----------------	----------------	----------------	----------------	----------------	----------------	----------------	----------------	----------------	----------------	----------------	----------------	----------------	----------------	----------------	----------------	----------------	----------------	----------------	----------------	----------------	----------------	----------------	----------------	----------------	----------------	----------------	----------------	----------------	----------------	----------------	----------------	----------------	----------------	----------------	----------------	----------------	----------------	----------------	----------------	----------------	----------------	----------------	----------------	----------------	----------------	----------------	----------------	----------------	----------------	----------------	----------------	----------------	----------------	----------------	----------------	----------------	----------------	----------------	----------------	----------------	----------------	----------------	----------------	----------------	----------------	----------------	----------------	----------------	----------------	----------------	----------------	----------------	----------------	----------------	----------------	----------------	----------------	----------------	----------------	----------------	----------------	----------------	----------------	----------------	----------------	----------------	----------------	----------------	----------------	----------------	----------------	----------------	----------------	----------------	----------------	----------------	----------------	----------------	----------------	----------------	----------------	----------------	----------------	----------------	----------------	----------------	----------------	----------------	----------------	----------------	----------------	----------------	----------------	----------------	----------------	----------------	----------------	----------------	----------------	----------------	----------------	----------------	----------------	----------------	----------------	----------------	----------------	----------------	----------------	----------------	----------------	----------------	----------------	----------------	----------------	----------------	----------------	----------------	----------------	----------------	----------------	----------------	----------------	----------------	----------------	----------------	----------------	----------------	----------------	----------------	----------------	----------------	----------------	----------------	----------------	----------------	----------------	----------------	----------------	----------------	----------------	----------------	----------------	----------------	----------------	----------------	----------------	----------------	----------------	----------------	----------------	----------------	----------------	----------------	----------------	----------------	----------------	----------------	----------------	----------------	----------------	----------------	----------------	----------------	----------------	----------------	----------------	----------------	----------------	----------------	----------------	----------------	----------------	----------------	----------------	----------------	----------------	----------------	----------------	----------------	----------------	----------------	----------------	----------------	----------------	----------------	----------------	----------------	----------------	----------------	----------------	----------------	----------------	----------------	----------------	----------------	----------------	----------------	----------------	----------------	----------------	----------------	----------------	----------------	----------------	----------------	----------------	----------------	----------------	----------------	----------------	----------------	----------------	----------------	----------------	----------------	----------------	----------------	----------------	----------------	----------------	----------------	----------------	----------------	----------------	----------------	----------------	----------------	----------------	----------------	----------------	----------------	----------------	----------------	----------------	----------------	----------------	----------------	----------------	----------------	----------------	----------------	----------------	----------------	----------------	----------------	----------------	----------------	----------------	----------------	----------------	----------------	----------------	----------------	----------------	----------------	----------------	----------------	----------------	----------------	----------------	----------------	----------------	----------------	----------------	----------------	----------------	----------------	----------------	----------------	----------------	----------------	----------------	----------------	----------------	----------------	----------------	----------------	----------------	----------------	----------------	----------------	----------------	----------------	----------------	----------------	----------------	----------------	----------------	----------------	----------------	----------------	----------------	----------------	----------------	----------------	----------------	----------------	----------------	----------------	----------------	----------------	----------------	----------------	----------------	----------------	----------------	----------------	----------------	----------------	----------------	----------------	----------------	----------------	----------------	----------------	----------------	----------------	----------------	----------------	----------------	----------------	----------------	----------------	----------------	----------------	----------------	----------------	----------------	----------------	----------------	----------------	----------------	----------------	----------------	----------------	----------------	----------------	----------------	----------------	----------------	----------------	----------------	----------------	----------------	----------------	----------------	----------------	----------------	----------------	----------------	----------------	----------------	----------------	----------------	----------------	----------------	----------------	----------------	----------------	----------------	----------------	----------------	----------------	----------------	----------------	----------------	----------------	----------------	----------------	----------------	----------------	----------------	----------------	----------------	----------------	----------------	----------------	----------------	----------------	----------------	----------------	----------------	----------------	----------------	----------------	----------------	----------------	----------------	----------------	----------------	----------------	----------------	----------------	----------------	----------------	----------------	----------------	----------------	----------------	----------------	----------------	----------------	----------------	----------------	----------------	----------------	----------------	----------------	----------------	----------------	----------------	----------------	----------------	----------------	----------------	----------------	----------------	----------------	----------------	----------------	----------------	----------------	----------------	----------------	----------------	----------------	----------------	----------------	----------------	----------------	----------------	----------------	----------------	----------------	----------------	----------------	----------------	----------------	----------------	----------------	----------------	----------------	----------------	----------------	----------------	----------------	----------------	----------------	----------------	----------------	----------------	----------------	----------------	----------------	----------------	----------------	----------------	----------------	----------------	----------------	----------------	----------------	----------------	----------------	----------------	----------------	----------------	----------------	----------------	----------------	----------------	----------------	----------------	----------------	----------------	----------------	----------------	----------------	----------------	----------------	----------------	----------------	----------------	----------------	----------------	----------------	----------------	----------------	----------------	----------------	----------------	----------------	----------------	----------------	----------------	----------------	----------------	----------------	----------------	----------------	----------------	----------------	----------------	----------------	----------------	----------------	----------------	----------------	----------------	----------------	----------------	----------------	----------------	----------------	----------------	----------------	----------------	----------------	----------------	----------------	----------------	----------------	----------------	----------------	----------------	----------------	----------------	----------------	----------------	----------------	----------------	----------------	----------------	----------------	----------------	----------------	----------------	----------------	----------------	----------------	----------------	----------------	----------------	----------------	----------------	----------------	----------------	----------------	----------------	----------------	----------------	----------------	----------------	----------------	----------------	----------------	----------------	----------------	----------------	----------------	----------------	----------------	----------------	----------------	----------------	----------------	----------------	----------------	----------------	----------------	----------------	----------------	----------------	----------------	----------------	----------------	----------------	----------------	----------------	----------------	----------------	----------------	----------------	----------------	----------------	----------------	----------------	----------------	----------------	----------------	----------------	----------------	----------------	----------------	----------------	----------------	----------------	----------------	----------------	----------------	----------------	----------------	----------------	----------------	----------------	----------------	----------------	----------------	----------------	----------------	----------------	----------------	----------------	----------------	----------------	----------------	----------------	----------------	----------------	----------------	----------------	----------------	----------------	----------------	----------------	----------------	----------------	----------------	----------------	----------------	----------------	----------------	----------------	----------------	----------------	----------------	----------------	----------------	----------------	----------------	----------------	----------------	----------------	----------------	----------------	----------------	----------------	----------------	----------------	----------------	----------------	----------------	----------------	----------------	----------------	----------------	----------------	----------------	----------------	----------------	----------------	----------------	----------------	----------------	----------------	----------------	----------------	----------------	----------------	----------------	----------------	----------------	----------------	----------------	----------------	----------------	----------------	----------------	----------------	----------------	----------------	----------------	----------------	----------------	----------------	----------------	----------------	----------------	----------------	----------------	----------------	----------------	----------------	----------------	----------------	----------------	----------------	----------------	----------------	----------------	----------------	----------------	----------------	----------------	----------------	----------------	----------------	----------------	----------------	----------------	----------------	----------------	----------------	----------------	----------------	----------------	----------------	----------------	----------------	----------------	----------------	----------------	----------------	----------------	----------------	----------------	----------------	----------------	----------------	----------------	----------------	----------------	----------------	----------------	----------------	----------------	----------------	----------------	----------------	----------------	----------------	----------------	----------------	----------------	----------------	----------------	----------------	----------------	----------------	----------------	----------------	----------------	----------------	----------------	----------------	----------------	----------------	----------------	----------------	----------------	----------------	----------------	----------------	----------------	----------------	----------------	----------------	----------------	----------------	----------------	----------------	----------------	----------------	----------------	----------------	----------------	----------------	----------------	----------------	----------------	----------------	----------------	----------------	----------------	----------------	----------------	----------------	----------------	----------------	----------------	----------------	----------------	----------------	----------------	----------------	----------------	----------------	----------------	----------------	----------------	----------------	----------------	----------------	----------------	----------------	----------------	----------------	----------------	----------------	----------------	----------------	----------------	----------------	----------------	----------------	----------------	----------------	----------------	----------------	----------------	----------------	----------------	----------------	----------------	----------------	----------------	----------------	----------------	----------------	----------------	----------------	----------------	----------------	----------------	----------------	----------------	----------------	----------------	----------------	----------------	----------------	----------------	----------------	----------------	----------------	----------------	----------------	----------------	----------------	----------------	----------------	----------------	----------------	----------------	----------------	----------------	----------------	----------------	----------------	----------------	----------------	----------------	----------------	----

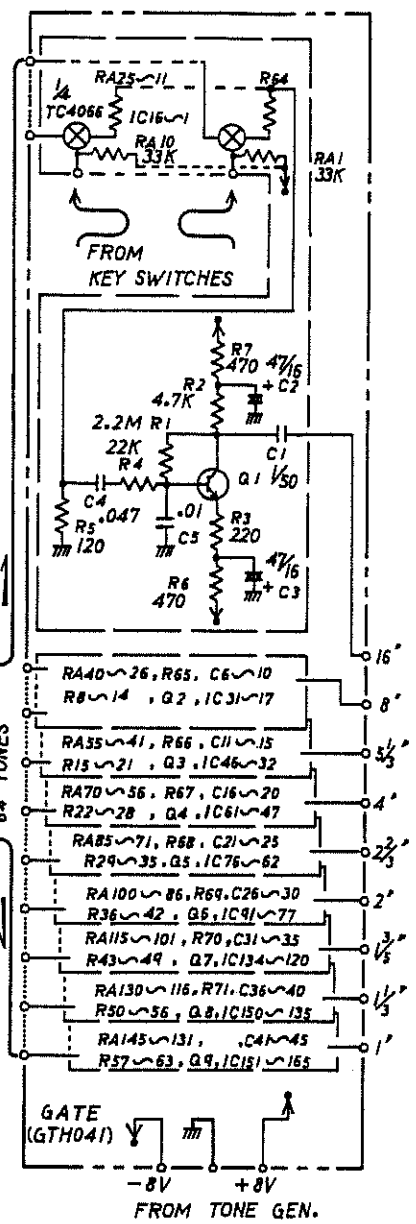
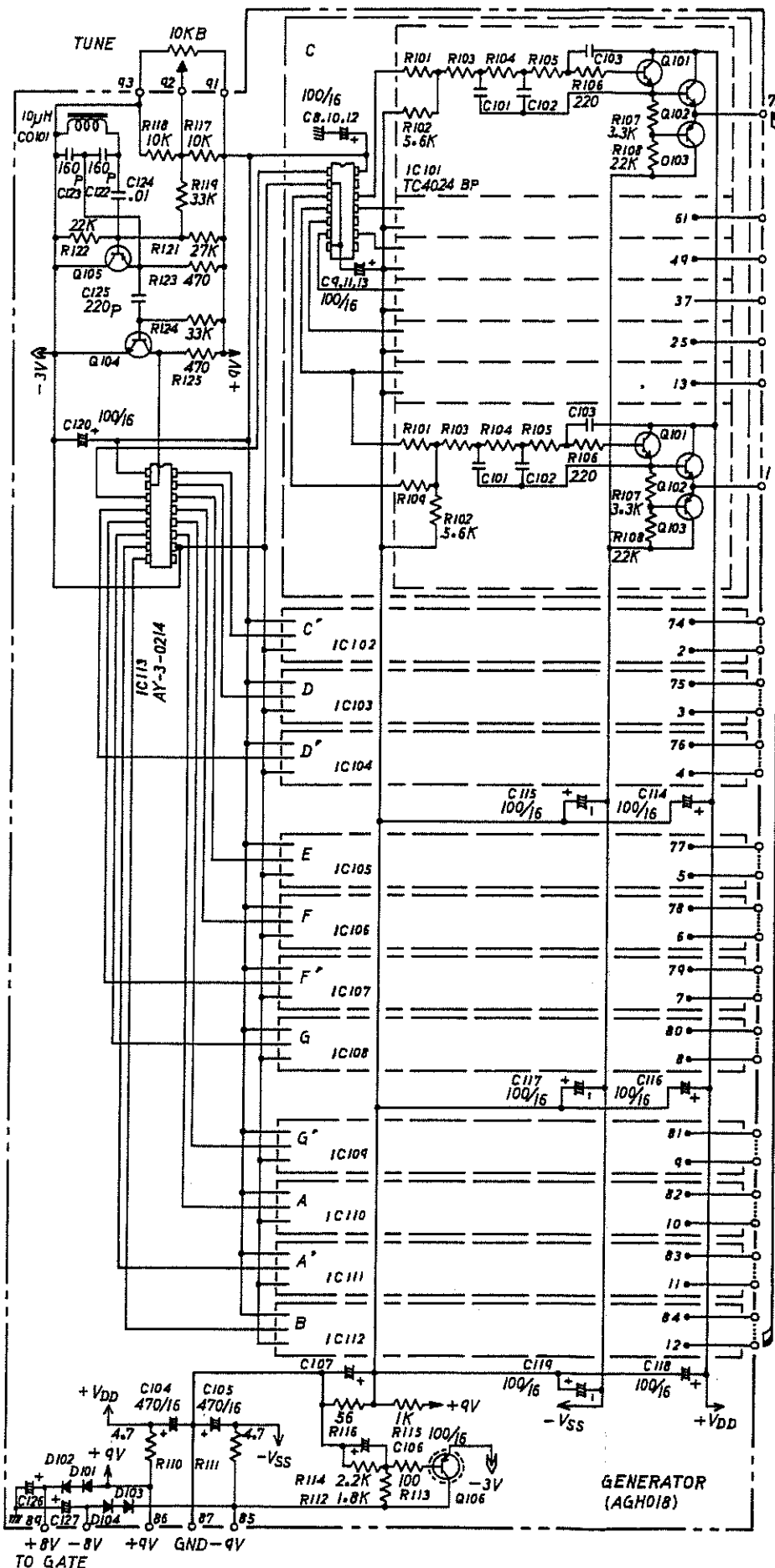

- TRANSISTORS**
- 2SA1015GR Q103(84PCS), 105, 213, 238, 240, 248
 - 2SB434-D Q106, Q603
 - 2SB605-L Q250
 - 2SC2240GR Q223, 224, 226, 228, 230, 232
 - 2SC1815GR Q101(84PCS), 102(84PCS), 104, Q104, 208, 212, 214, 222, 225, 227, 229, 231, 233, 237, 239, 241, 247
 - 2SD234-D Q601
 - 2SD571-L Q249
 - 2SK30AGR Q201, 203, 205
 - 2SK30AY Q202, 204, 206, 207, 215, 221
- IC**
- AY-3-0214 IC113
 - TC4001 BP IC203
 - TC4011 BP IC201, 202
 - TC4024 BP IC101, 112
 - D4066C IC109, 120, 165 (137PCS)
 - BA662A IC207
 - MN3101 IC205
 - MN3009 IC206
 - MPC4558 IC204
- ALL DIODES ARE M8555

+8V -8V +9V GND-9V
TO GATE

BLOCK DIAGRAM

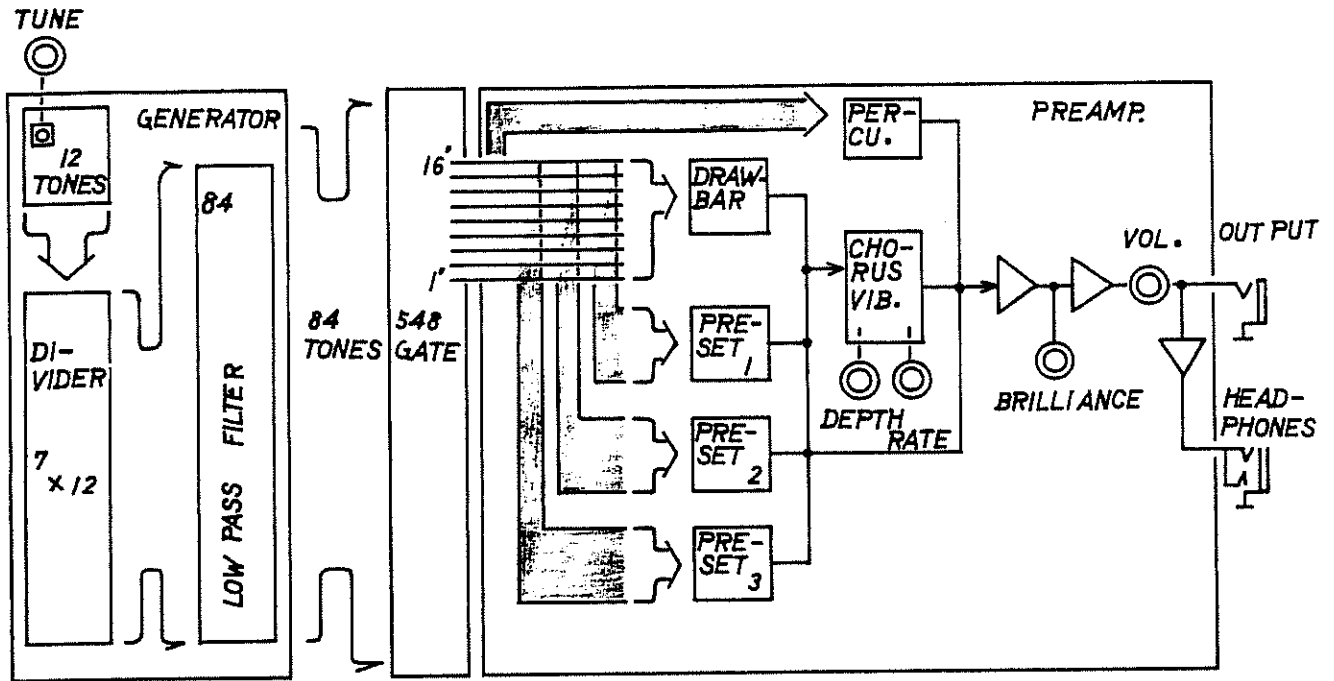

KEYBOARD PARTS

NO.	PART NO.	DESCRIPTION	NO.	PART NO.	DESCRIPTION
1	106H026	Natural key C, F	5	068H004	Guide bush H4
1	106H027	Natural key D	6	101H143	Level felt H143
1	106H028	Natural key E, B	7	071H044	Contact leaf H44
1	106H029	Natural key G	8	071H049	Bus bar 6lp H49
1	106H030	Natural key A	9	043H007	Switch unit 12p H7
1	106H031	Natural key C; F'	9	043H008	Switch unit 13p H8
2	106H032	Sharp key	10	104H029	Holder H29
3	070H029	Key spring H29	11	062H024	Chassis bracket H24
4	061H086A	Chassis H86A	12	098H006	Key stopper H6

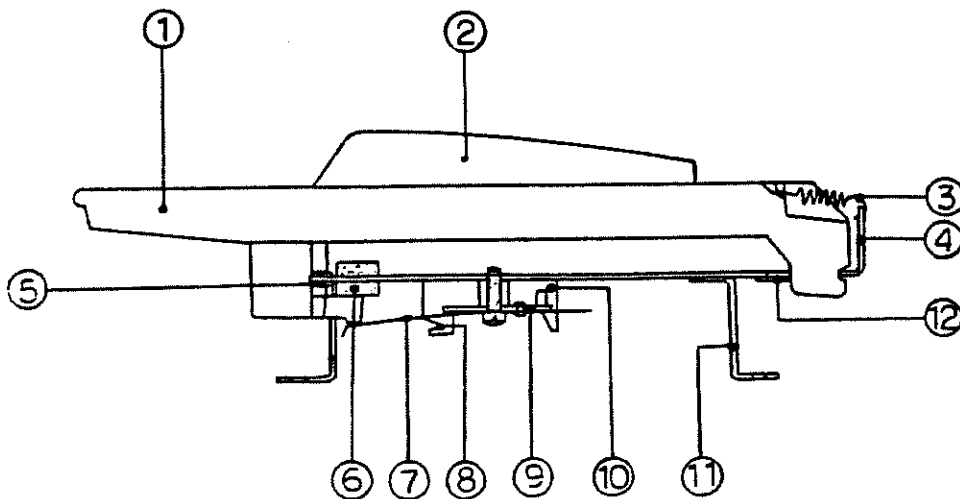

HOW TO REMOVE KEY and KEYSWITCH UNIT

Key (see fig. left below)

1. Remove key stopper (12).
2. Remove key spring (3).
3. Slide key leftwards and lift it out of chassis.
4. When inserting a new key, take care not to bend contact leaf (7) with the key leg.

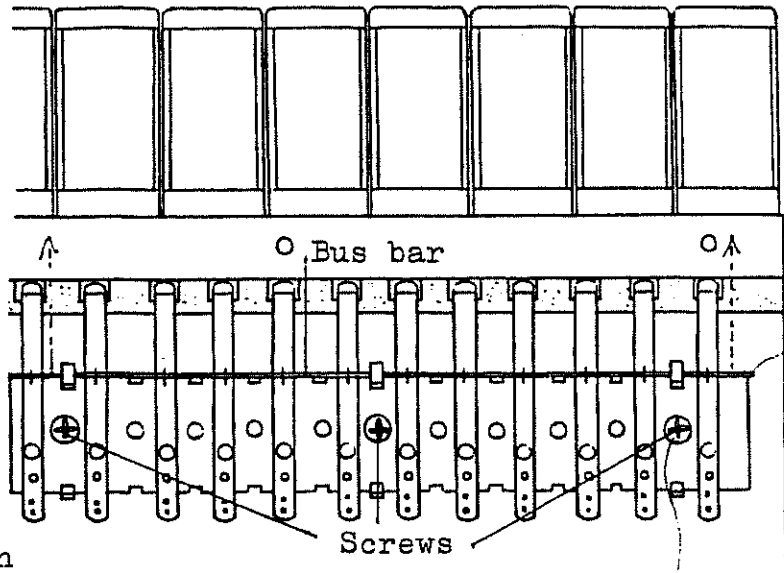

Keyswitch unit (see fig. right)

1. Pull bus bar upward out of hooks.
2. Remove three screws on the switch unit, it's ready to remove.

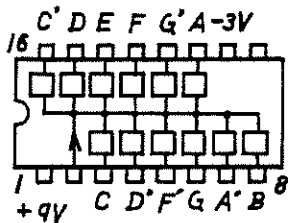

AY-3-0214

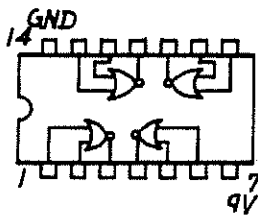

TC4001BP

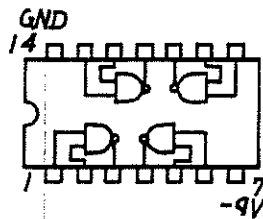

TC4011BP

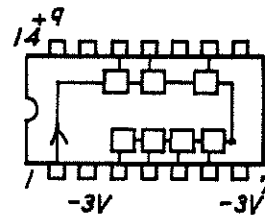

TC4024BP

(Top View)

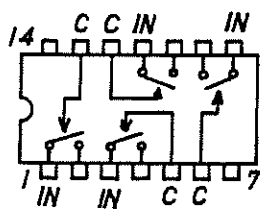

D4066C

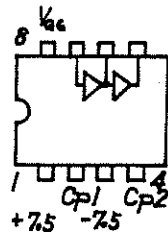

MN3101

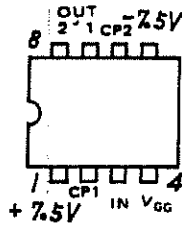

MN3009

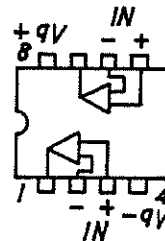

NPC4558

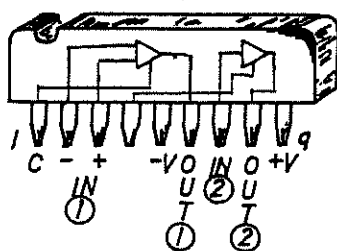

BA662



ECB

2SB605
2SD571



BCE

2SB434
2SD234



ECB

2SA1015
2SC1815
2SC2240



SGD

2SK30A GR
2SK30A Y

GTH41 (147H041)

P.C.B 052H199

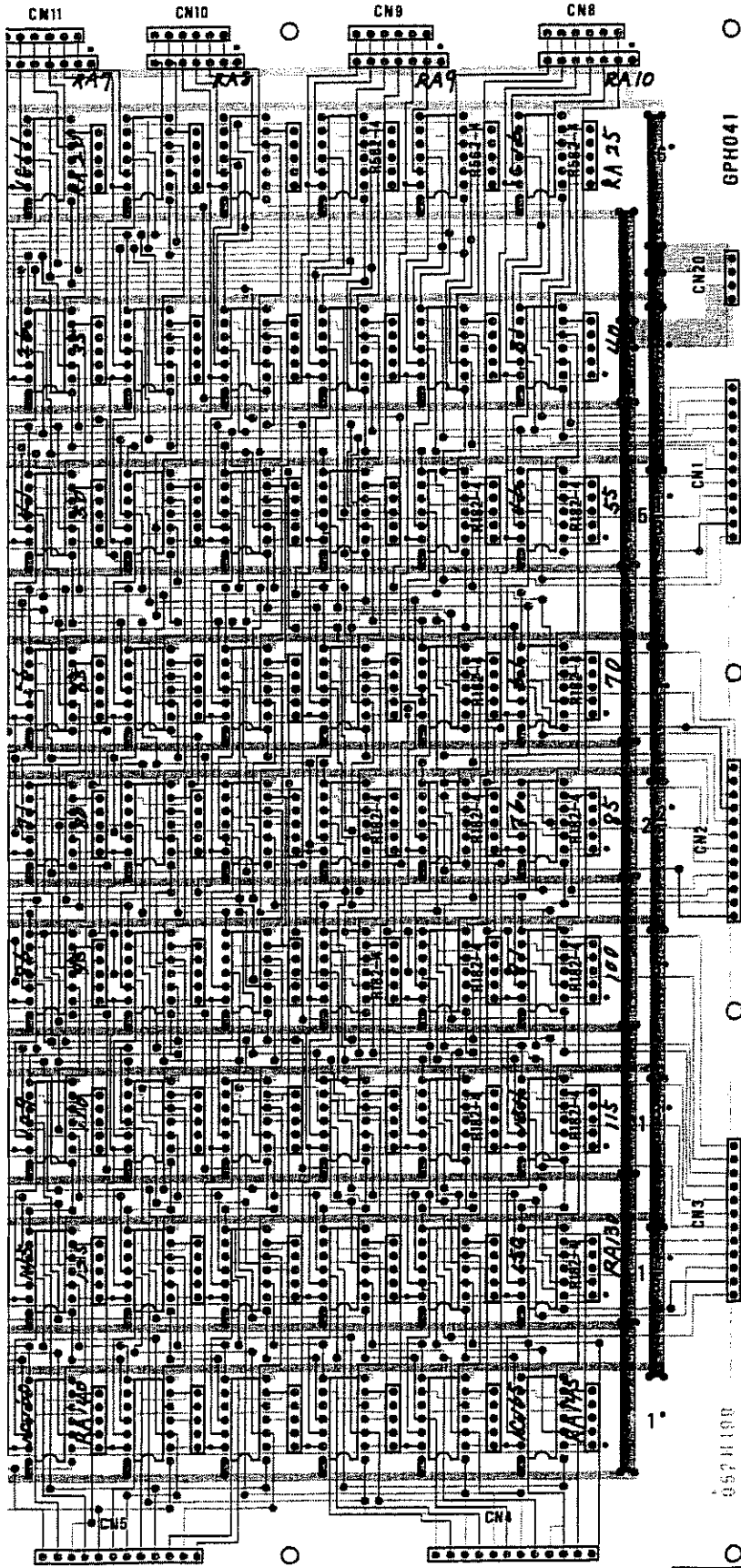

Resistors	2.2M	R1	8	15	22	29	36	43	50	57	
	4.7K	R2	9	16	23	30	37	44	51	58	
	220Ω	R3	10	17	24	31	38	45	52	59	
	22K	R4	11	18	25	32	39	46	53	60	
	120Ω	R5	12	19	26	33	40	47	54	61	
	470Ω	R6	13	20	27	34	41	48	55	62	
	470Ω	R7	14	21	28	35	42	49	56	63	
Electrolytics 100μ/16V	1.8K	R64	65	66	67	68	69	70	71		
		C2	3	7	8	12	13	17	18	22	
			23	27	28	32	33	37	38	42	43

Resistor - Array

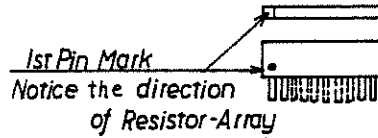

Resistor Array without designation:
RM-4 222 (116pcs)

RA2 ~ RA10 are RM-6 333 (9pcs)

Read designations on the pc board;
R182-4 as RM-4 182, R562-4 as RM-4 392.



- Connectors
- CN1.2,8-16 13PCS : 5045-6A
 - CN17 1PC : 5045-7A
 - CN18 2PCS : 5045-5A
 - CN20 1PC : 5045-4A
 - CN3~7 10PCS : 5046-6A

○ All Transistors are 2SC1815GR (9pcs)



All ICs are NEC 4066 (137pcs)

P.C.B Holders TA305 and TB300 16pairs

A
B
C
D
E
F
G
H
I
J
K
L
M
N
O
P
Q
R
S
T
U
V
W
X
Y
Z
AA
AB
AC
AD
AE
AF
AG
AH
AI
AJ
AK
AL
AM
AN
AO
AP
AQ
AR
AS
AT
AU
AV
AW
AX
AY
AZ
BA
BB
BC
BD
BE
BF
BG
BH
BI
BJ
BK
BL
BM
BN
BO
BP
BQ
BR
BS
BT
BU
BV
BW
BX
BY
BZ
CA
CB
CC
CD
CE
CF
CG
CH
CI
CJ
CK
CL
CM
CN
CO
CP
CQ
CR
CS
CT
CU
CV
CW
CX
CY
CZ
DA
DB
DC
DD
DE
DF
DG
DH
DI
DJ
DK
DL
DM
DN
DO
DP
DQ
DR
DS
DT
DU
DV
DW
DX
DY
DZ
EA
EB
EC
ED
EE
EF
EG
EH
EI
EJ
EK
EL
EM
EN
EO
EP
EQ
ER
ES
ET
EU
EV
EW
EX
EY
EZ
FA
FB
FC
FD
FE
FF
FG
FH
FI
FJ
FK
FL
FM
FN
FO
FP
FQ
FR
FS
FT
FU
FV
FW
FX
FY
FZ
GA
GB
GC
GD
GE
GF
GG
GH
GI
GJ
GK
GL
GM
GN
GO
GP
GQ
GR
GS
GT
GU
GV
GW
GX
GY
GZ
HA
HB
HC
HD
HE
HF
HG
HH
HI
HJ
HK
HL
HM
HN
HO
HP
HQ
HR
HS
HT
HU
HV
HW
HX
HY
HZ
IA
IB
IC
ID
IE
IF
IG
IH
II
IJ
IK
IL
IM
IN
IO
IP
IQ
IR
IS
IT
IU
IV
IW
IX
IY
IZ
JA
JB
JC
JD
JE
JF
JG
JH
JI
JJ
JK
JL
JM
JN
JO
JP
JQ
JR
JS
JT
JU
JV
JW
JX
JY
JZ
KA
KB
KC
KD
KE
KF
KG
KH
KI
KJ
KK
KL
KM
KN
KO
KP
KQ
KR
KS
KT
KU
KV
KW
KX
KY
KZ
LA
LB
LC
LD
LE
LF
LG
LH
LI
LJ
LK
LL
LM
LN
LO
LP
LQ
LR
LS
LT
LU
LV
LW
LX
LY
LZ
MA
MB
MC
MD
ME
MF
MG
MH
MI
MJ
MK
ML
MN
MO
MP
MQ
MR
MS
MT
MU
MV
MW
MX
MY
MZ
NA
NB
NC
ND
NE
NF
NG
NH
NI
NJ
NK
NL
NM
NO
NP
NQ
NR
NS
NT
NU
NV
NW
NX
NY
NZ
OA
OB
OC
OD
OE
OF
OG
OH
OI
OJ
OK
OL
OM
ON
OO
OP
OQ
OR
OS
OT
OU
OV
OW
OX
OY
OZ
PA
PB
PC
PD
PE
PF
PG
PH
PI
PJ
PK
PL
PM
PN
PO
PP
PQ
PR
PS
PT
PU
PV
PW
PX
PY
PZ
QA
QB
QC
QD
QE
QF
QG
QH
QI
QJ
QK
QL
QM
QN
QO
QP
QQ
QR
QS
QT
QU
QV
QW
QX
QY
QZ
RA
RB
RC
RD
RE
RF
RG
RH
RI
RJ
RK
RL
RM
RN
RO
RP
RQ
RR
RS
RT
RU
RV
RW
RX
RY
RZ
SA
SB
SC
SD
SE
SF
SG
SH
SI
SJ
SK
SL
SM
SN
SO
SP
SQ
SR
SS
ST
SU
SV
SW
SX
SY
SZ
TA
TB
TC
TD
TE
TF
TG
TH
TI
TJ
TK
TL
TM
TN
TO
TP
TQ
TR
TS
TT
TU
TV
TW
TX
TY
TZ
UA
UB
UC
UD
UE
UF
UG
UH
UI
UJ
UK
UL
UM
UN
UO
UP
UQ
UR
US
UT
UU
UV
UW
UX
UY
UZ
VA
VB
VC
VD
VE
VF
VG
VH
VI
VJ
VK
VL
VM
VN
VO
VP
VQ
VR
VS
VT
VU
VV
VW
VX
VY
VZ
WA
WB
WC
WD
WE
WF
WG
WH
WI
WJ
WK
WL
WM
WN
WO
WP
WQ
WR
WS
WT
WU
WV
WW
WX
WY
WZ
XA
XB
XC
XD
XE
XF
XG
XH
XI
XJ
XK
XL
XM
XN
XO
XP
XQ
XR
XS
XT
XU
XV
XW
XX
XY
XZ
YA
YB
YC
YD
YE
YF
YG
YH
YI
YJ
YK
YL
YM
YN
YO
YP
YQ
YR
YS
YT
YU
YV
YW
YX
YY
YZ
ZA
ZB
ZC
ZD
ZE
ZF
ZG
ZH
ZI
ZJ
ZK
ZL
ZM
ZN
ZO
ZP
ZQ
ZR
ZS
ZT
ZU
ZV
ZW
ZX
ZY
ZZ

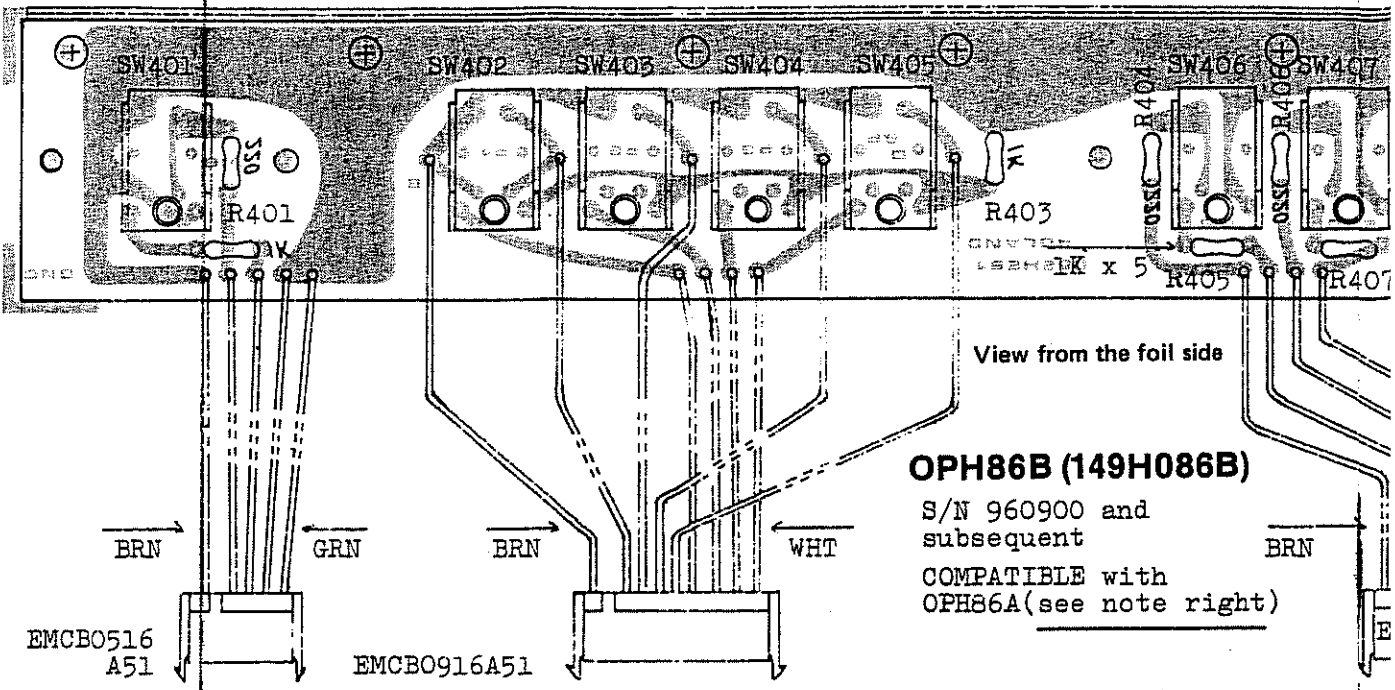

OPH86B (149H086B)

S/N 960900 and subsequent
 COMPATIBLE with OPH86A (see note right)

APH30B (141H030B)

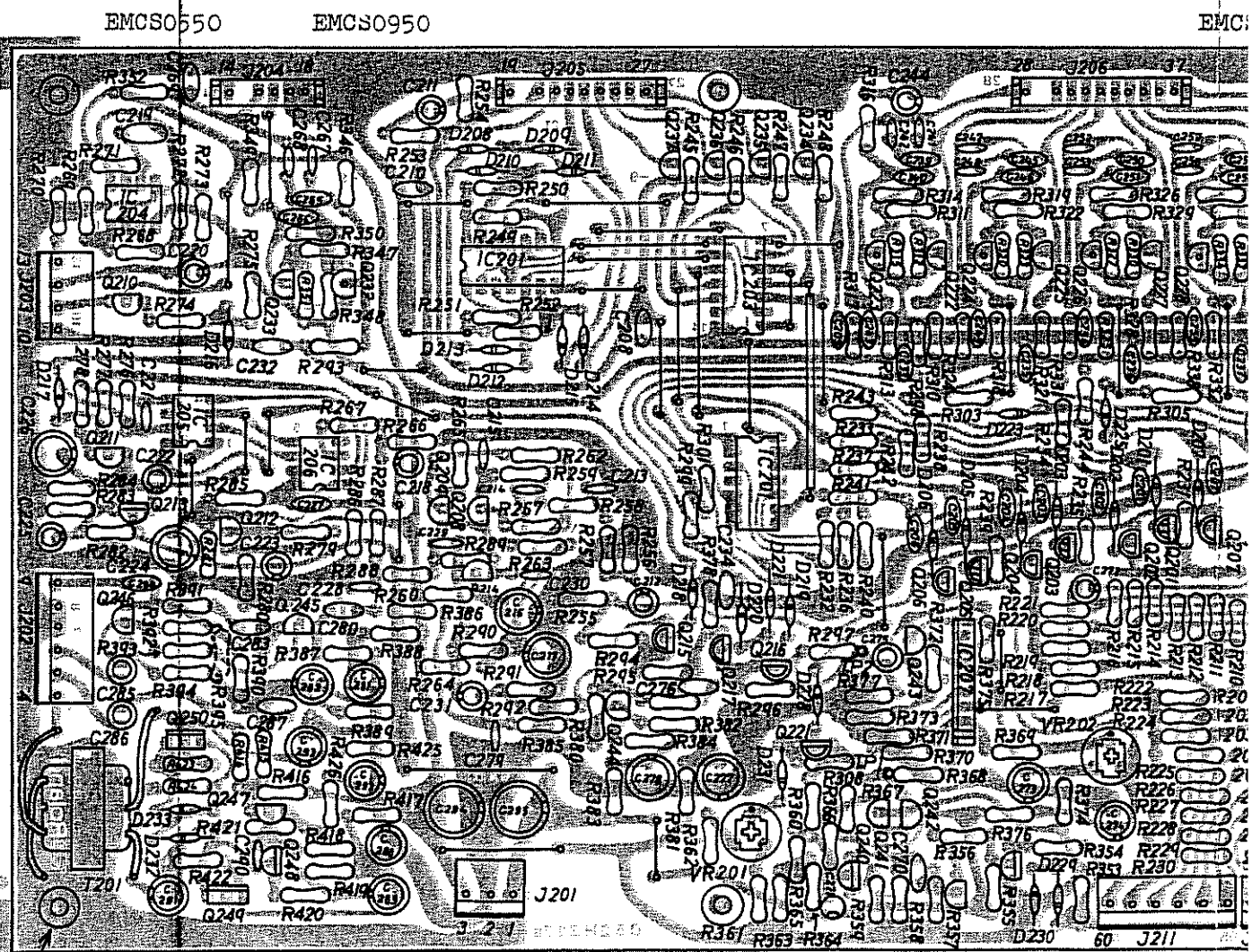

- P.C.B HOLDERS
TA305 • TB300 6Pairs
- PCB O52H217B
- TRANSISTOR
2SA1015GR
- 2SC1815GR
- 2SC2240GR
- 2SK30AY

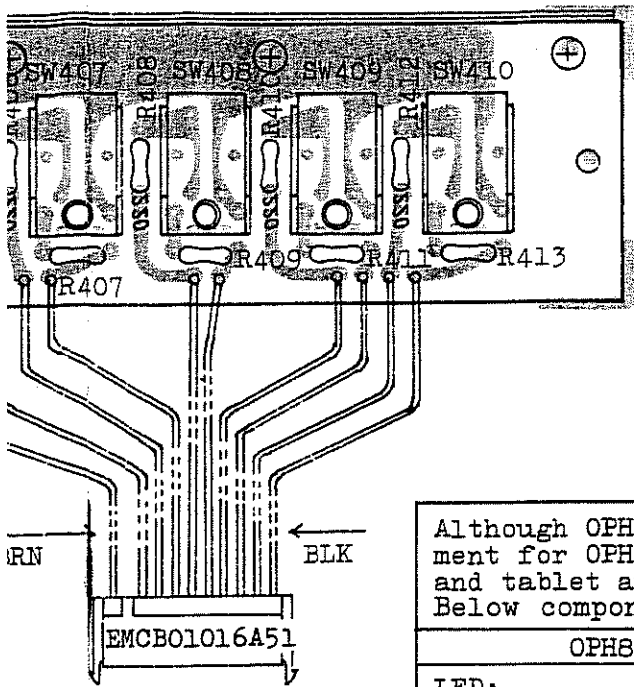

OPH75A (149H075A)

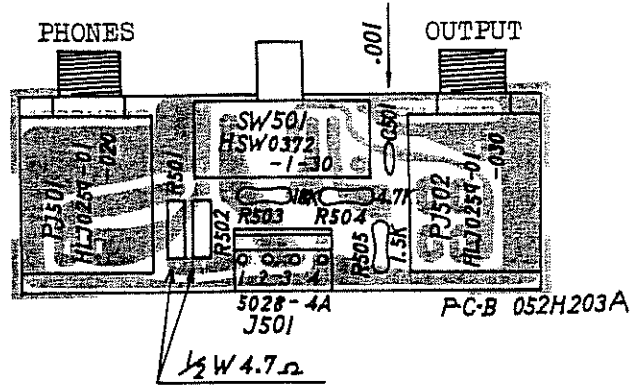

Although OPH86B is direct replacement for OPH86A, individual switch and tablet are not interchangeable. Below components list for both.

OPH86A	OPH86B
LED:	SLP135B
Switch and Tablet	
Given P/N as a set	Given separately
Switch KHC11901	Switch KHC11901
Switch w/tablet	Tablet
SW401, 406, 410	
320. 2 E1-1 blue	H13 blue
SW402-404, 407-409	
320. 2 E1-1 white	H10 white
SW405	
320. 2 E1-1 orange	H12 orange

OPH78A (149H078A)

220V 240V

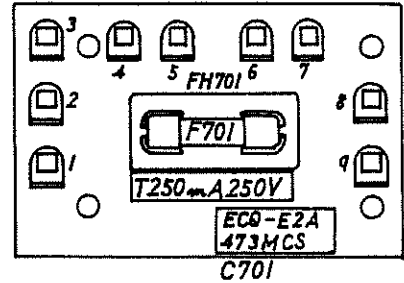

OPH77A (149H077A)

P-C-B 052H185A 117V

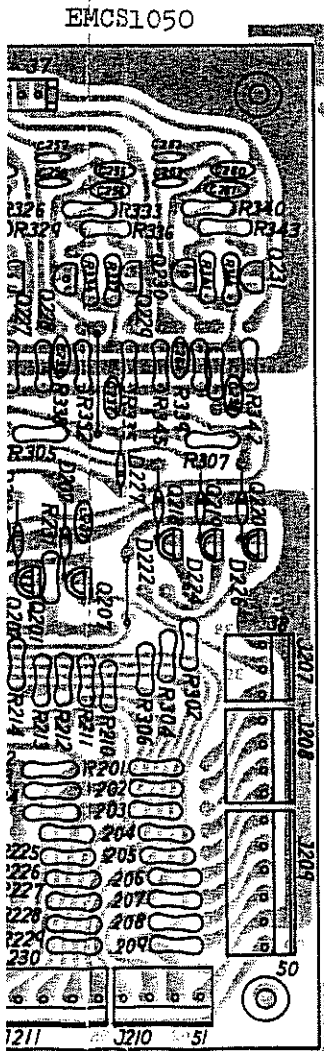
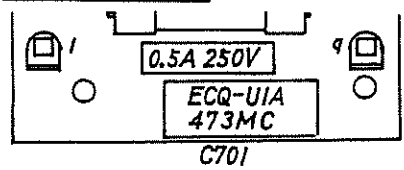

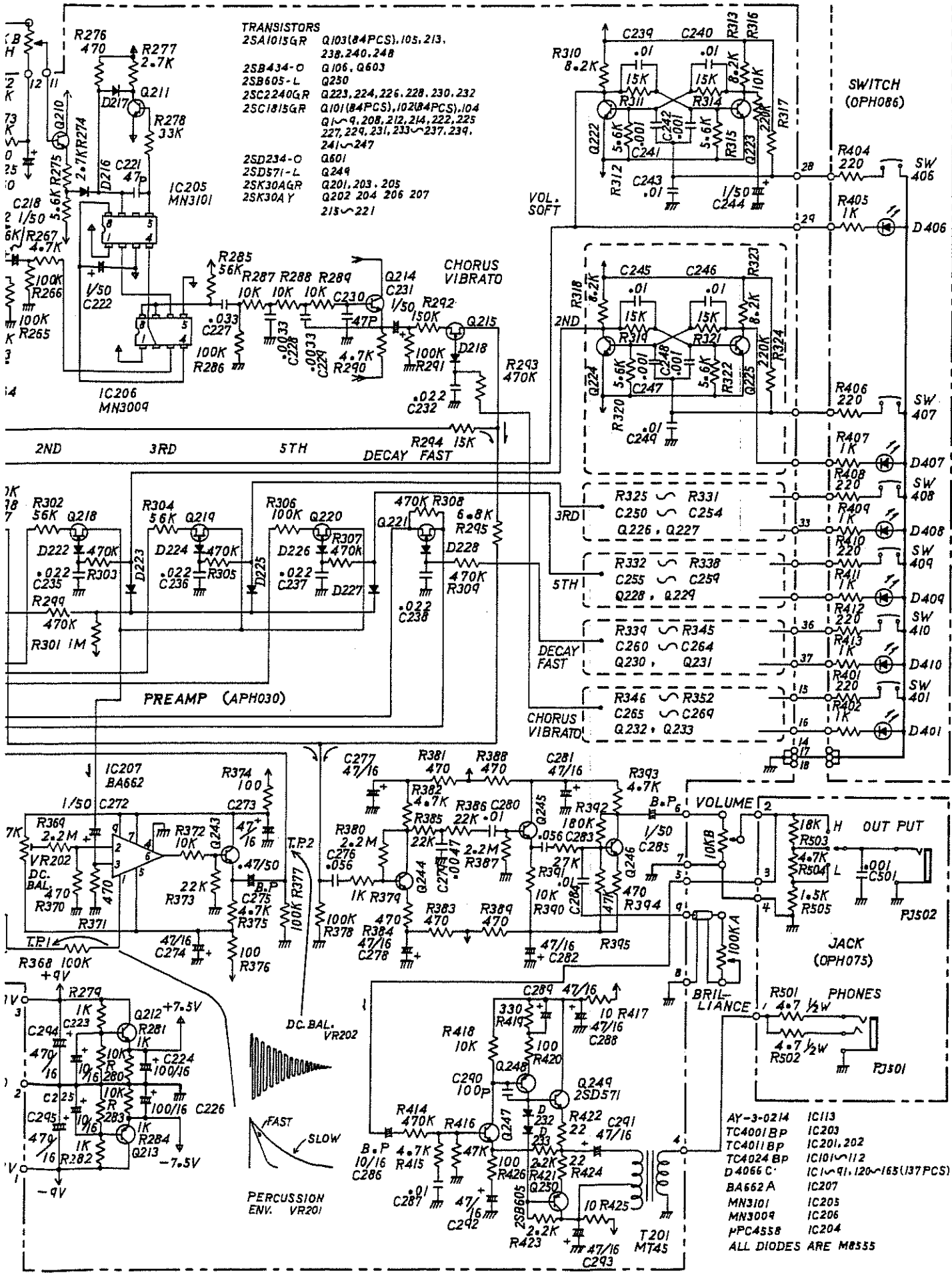

- TRANSISTORS**
- 2SA1015GR Q103(84PCS), 105, 213, 238, 240, 248
 - 2SB434-O Q106, Q603
 - 2SB605-L Q250
 - 2SC2240GR Q223, 224, 226, 228, 230, 232
 - 2SC1815GR Q101(84PCS), 102(84PCS), 104, 109, 208, 212, 214, 222, 225, 227, 229, 231, 233~237, 239, 241~247
 - 2SD234-O Q601
 - 2SD571-L Q249
 - 2SK30AGR Q201, 203, 205
 - 2SK30AY Q202, 204, 206, 207, 218~221

- AY-3-0214 IC113
- TC4001BP IC203
- TC4011BP IC201, 202
- TC4024BP IC101, 112
- D4065 C IC1~91, 120~165(137PCS)
- BA662 A IC207
- MN3101 IC205
- MN3009 IC206
- HPC4558 IC204
- ALL DIODES ARE M8555

ADJUSTMENT

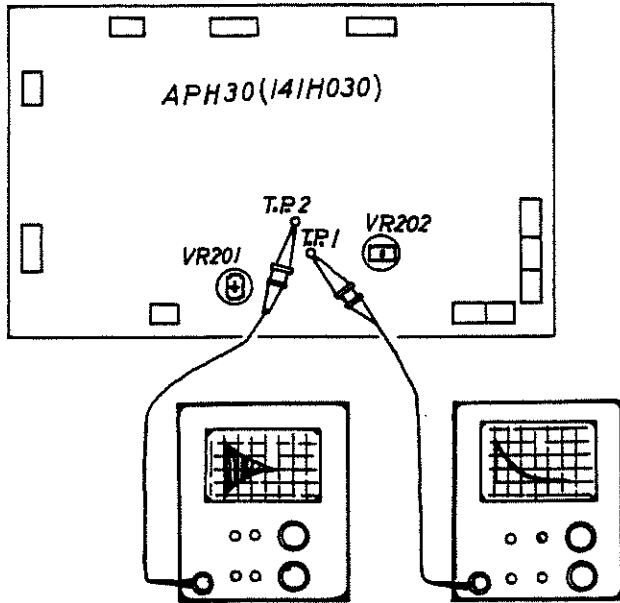

PERCUSSION DECAY

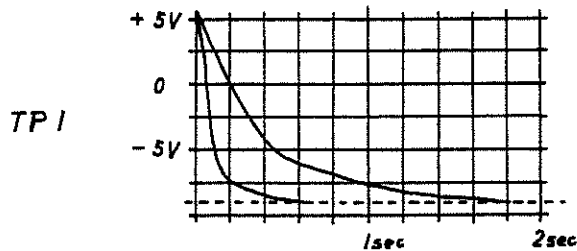

ADJUST VR201 : FAST 0.6 sec
 SLOW 1.7 sec

PERCUSSION DC BALANCE

SET : DRAW BARS PERCUSSION SWITCH:ON
 PERCUSSION 2ND SWITCH:ON
 DECAY FAST SWITCH:ON

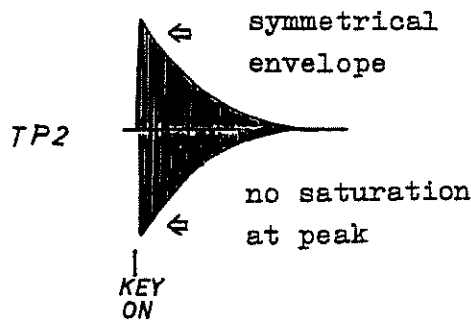

ADJUST VR202 : CENTERD WAVEFORM

PARTS LIST

Keyboard assy SK361-A

Drawbar set RD-109C

CABINET

081H221	Cabinet	H221
111-021	Rubber foot	G-5
059H011	Hinge	H11
086H018	Top cover	H18
093H006	Rim (on cover H18)	H6
072H067	Panel	H67 front
091H021	Endblock	H21 left
091H022	Endblock	H22 right
	* Tablet---	see NOTES
016-078	Knob no.78	
009-057	Jack HLJ0259-01-020	stereo
009-021	Jack HLJ0259-01-030	

SWITCH

001-258	SDA1SA-1	power	100 V
001-259	SDA2SA-1	power	117 V
001-260	SDA4SA-1	power	220/240 V
001-206	HSW0372-1-30		slide
*001-315	320. 2 E1-1	tab. white	
*001-317	320. 2 E1-1	tab. orange	
*001-320	320. 2 E1-1	tab. blue	
* See NOTES			

PCB

144H018A	AGH18A	(pcb 052H198A)
147H041	GTH41	(pcb 052H199)
141H030B	APH30B	(pcb 052H217B)
149H075A	OPH75A	(pcb 052H203A)
*149H086A	OPH86A	(pcb 052H218A)
149H076A	OPH76A	(pcb 052H185A) 100 V
149H077A	OPH77A	(pcb 052H185A) 117 V
149H078A	OPH78A	(pcb 052H185A) 220/240 V
146H044	PSH44	(pcb 052H202) 100 V
146H045	PSH45	(pcb 052H202) 117 V
146H046	PSH46	(pcb 052H202) 220/240 V
* For OPH86, see NOTES		

TRANSFORMER. COIL

O22H029J Pt H29J 100 V
 O22H029C Pt H29C 117 V
 O22H029D Pt H29D 220/240 V
 O22-131 Opt MT(ST)-45
 O22-135 Coil 40M-067-018 10 uH

SEMICONDUCTORTransistor

O17-022 2SB434-0
 O17-010 2SD234-0 or 2SD526-0
 O17-072 2SD571-L
 O17-106 2SC1815-GR
 O17-123 2SC2240-GR
 O17-146 2SB605-L
 O17-155 2SA1015-GR
 O17-014 2SK30A-Y FET
 O17-016 2SK30A-GR FET

Diode

O18-087 M8555
 O18-089 1B4B41 rectifier bridge
 O18-120 O5Z10AL zener
 O19-034 SLP135B LED

IC

O20-156 AY-3-0214
 O20-051 TC4001BP
 O20-040 TC4011BP
 O20-076 TC4024BP
 O20-254 μ PD4066C (NEC) only
 O20-160 BA662A
 O20-224 MN3101 BBD driver
 O20-215 MN3009 BBD 256 stages
 O20-097 μ PC455B

POTENTIOMETER

O26-003 EVHCOAK15B14 10 kB
 O26-004 EVHCOAK15B54 50 kB
 O26-176 EVHCOAK15A15 100 kA
 EVHCOAK15 can be replaced by
 EVH8MA360....
 O30-459 SR19R 1 kB trimmer
 O30-469 SR19R 47 kB trimmer

FUSE. FUSE HOLDER

O08-040 MGP 0.5 A prim. 100.117 V
 O08-060 SEMKO T250 mA prim.220/240 V
 O08-069 SEMKO T1.6 A sec. 220/240 V
 O12-003 Fuse clip TF-758 sec.220/240V

CAPACITORPolyester film

O35-047 ECQE1047MC .047/1000 V 100 V
 O35-108 ECQU1A473MC 047/125AC 117 V
 O35-310 ECQE2A473MCS 047/1000 V
 220/240V

Electrolytic

O32-193 ECEA50NR47 .47 mfd 50 V B.P.
 O32-190 ECEA50N1 1mfd 50 V Bi-polar
 O32-191 ECEA16N10U 10mfd 50 V Bi-po.
 O32-224 CE15E1V010K 1mfd 35 V
 tantalum

OTHERSLine cord strain relief

O47-040 SR-4N-4 100 V
 O47-031 SR-6N3-4 117 V
 O47-003 BU-4801 220/240 V
 O47-023 EA1702B clamp 220/240 V
 O64-134 Holder no.134
 O48H019 Heatsink H19

NOTES:

Changes on Tablet Switches and the PCB
 (with serial number 960900)

The switches are changed along with the
 tablets to the following:

13129712 Switch KHC-11901
 O16H010 Tablet H10 wht
 O16H012 Tablet H12 orn
 O16H013 Tablet H13 blu

Since the pin size and spans are dif-
 ferent between two types, switch PCB
 assembly is also changed to

149H086B OPH86B (pcb 052H261).

Although individual switch and tablet
 are not interchangeable, they are com-
 patible when replaced as a PCB assy.

 Roland®

10603

UPC

10603



10603

 Roland®