

## LIMITED WARRANTY

This product is warranted to the original consumer purchaser to be free from defects in materials and workmanship under normal installation, use and service for a period of one (1) year from the date of purchase as shown on the purchaser's receipt.

The obligation of Rolls Corporation under this warranty shall be limited to repair or replacement (at our option), during the warranty period of any part which proves defective in material or workmanship under normal installation, use and service, provided the product is returned to Rolls Corporation, **TRANSPORTATION CHARGES PREPAID**. Products returned to us or to an authorized Service Center must be accompanied by a copy of the purchase receipt. In the absence of such purchase receipt, the warranty period shall be one (1) year from the date of manufacture.

This warranty shall be invalid if the product is damaged as a result of defacement, misuse, abuse, neglect, accident, destruction or alteration of the serial number, improper electrical voltages or currents, repair, alteration or maintenance by any person or party other than our own service facility or an authorized Service Center, or any use violative of instructions furnished by us.

This one-year warranty is in lieu of all expressed warranties, obligations or liabilities. **ANY IMPLIED WARRANTIES, OBLIGATIONS, OR LIABILITIES, INCLUDING BUT NOT LIMITED TO THE IMPLIED WARRANTIES OF MERCHANTABILITY AND FITNESS FOR A PARTICULAR PURPOSE, SHALL BE LIMITED IN DURATION TO THE ONE YEAR DURATION OF THIS WRITTEN LIMITED WARRANTY.** Some states do not allow limitations on how long an implied warranty lasts, so the above limitation may not apply to you.

IN NO EVENT SHALL WE BE LIABLE FOR ANY SPECIAL, INCIDENTAL OR CONSEQUENTIAL DAMAGES FOR BREACH OF THIS OR ANY OTHER WARRANTY, EXPRESSED OR IMPLIED, WHATSOEVER. Some states do not allow the exclusion or limitation of special, incidental or consequential damages so the above limitation or exclusion may not apply to you. This warranty gives you specific legal rights, and you may also have other rights which vary from state to state.



ROLLS CORPORATION  
SALT LAKE CITY, UTAH  
3/00

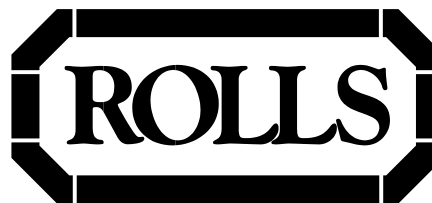

# RM203 Stereo Line Mixer

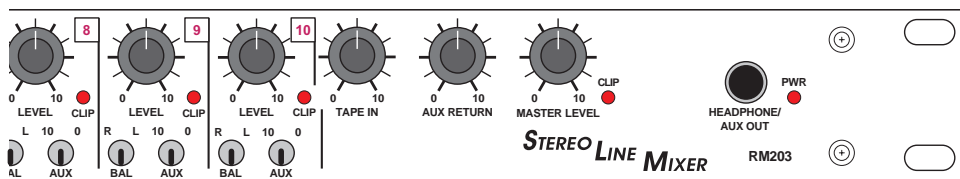
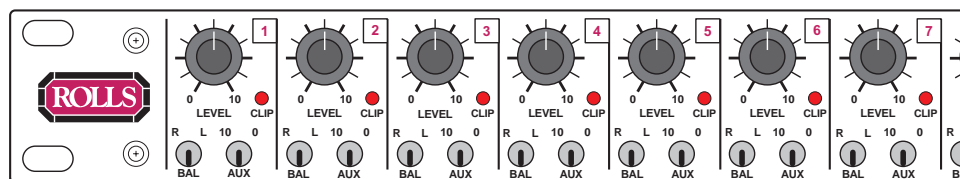

OWNERS MANUAL

Thank you for your purchase of the Rolls RM203 Stereo Line Mixer. The RM203 is a line-level mixer featuring ten channels of stereo inputs, a Tape input and output, and a mono auxiliary send and stereo return. Each channel has a signal level control, a right/left balance control, an auxiliary level control, and a clip LED.

**INSPECTION**

1. Unpack and inspect the RM203 box and package. Your RM203 was carefully packed at the factory in a protective carton. Nonetheless, be sure to examine the unit and the carton for any signs of damage that may have occurred during shipping. If obvious physical damage is noticed, contact the carrier immediately to make a damage claim. We suggest saving the shipping carton and packing materials for safely transporting the unit in the future.
2. Please complete the Warranty Registration Card and return it to the factory.

**FEATURES**

- 10 Stereo Inputs
- RCA Tape Inputs and Outputs
- Balanced 1/4" TRS Outputs
- Mono Auxiliary Send - Stereo Returns
- Clip Indication of each channel
- Balance control on each channel
- Headphone / Auxiliary Output
- External Power Supply included for quieter operation

**TABLE OF CONTENTS**

Introduction	1
Inspection	1
Features	1
Table of Contents	1
Description	
Front Panel	2
Rear Panel	2
Connection/Operation	3 - 4
Specifications	5
Schematic	6
Warranty	Back cover

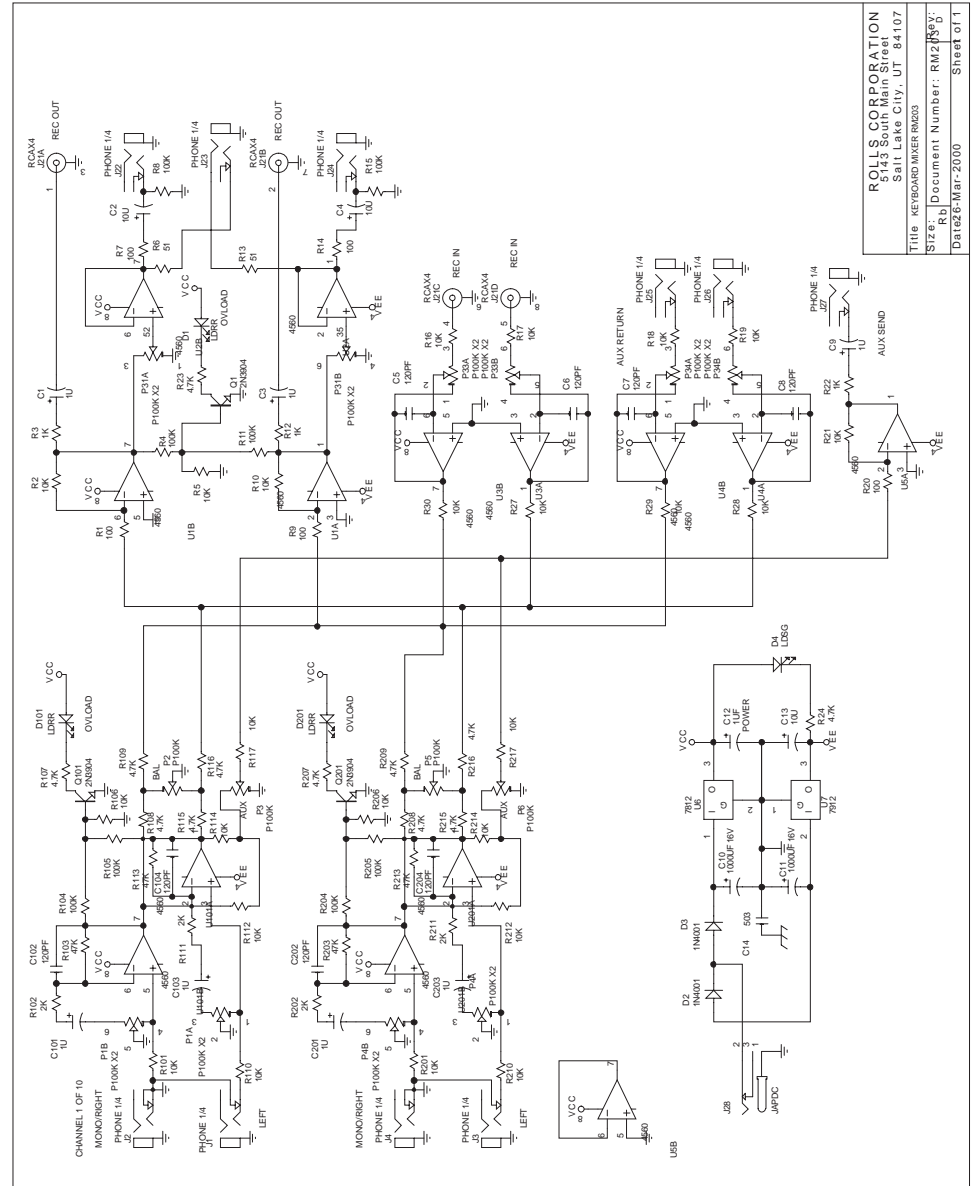

Input Impedance:	10 k Ω unbal.
Output Impedance:	50 Ω bal
Max Input Level:	+18 dBV
Phase Shift:	< 10 deg. 20 Hz - 20 kHz
Connectors:	1/4" and RCA
Max Gain:	26 dB Line 26 dB Aux
S/N Ratio:	>90 dB
THD	< .003%
IMD (SMPTE)	< .003%
Power	120 VAC 50-60 Hz, 15 W
Weight:	7 lbs (3kg)
Size:	19" x 1.75" x 6.5" (48cm x 4.5cm x 17cm)

**FRONT PANEL**



*Note: Channels One through Ten are identical.*

Channel Section

Bal: Adjusts the relative level of the channel signal to the Right and Left outputs.

Aux: Adjusts the amount of signal sent to the Auxiliary Output

Level: Adjusts the overall signal level of the channel.

Clip: When lit, indicates clipping of excessive level into the channel.

Master Section

Tape In: Adjusts the amount of input signal from the rear panel Tape In jacks.

Aux Return: Controls the amount of signal received at the stereo Aux Return jacks.

Master Level : Controls the overall output level of the RM203.

Headphone/Aux out: 1/4" TRS stereo jacks for monitoring the master right and left signals, also may be used as an alternative stereo output for connecting to another stereo amplifier.

PWR: Indicates that the RM203 is connected to an AC outlet and is on.

**REAR PANEL**

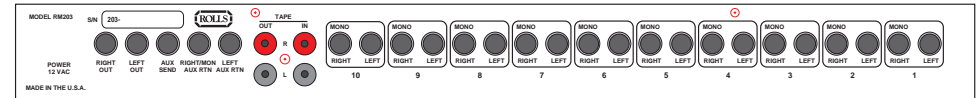

Master Outputs

Right and Left Out: 1/4" TRS balanced main output jacks. For connection to an amplifier, recording device or signal processor.

Right and Left Aux Return: 1/4" unbalanced jack, for connection to the right and left outputs of a signal processor, or they may be used as auxiliary inputs.

Aux Send: 1/4" unbalanced jack, for connection to a signal processor input such as a multi-effects processor. This output may also be used as a monitor send for connection to an amplifier and speakers for monitoring.

Tape Out: Stereo RCA jacks for connection to a stereo input device such as a cassette player or CAT machine, for recording program material. Level is controlled by individual channel volumes.

Tape Inputs: Stereo RCA jacks for connection to a source such as a cassette player or CD player.

Channel Inputs

*Note: Channels One through Ten are identical.*

Right / Left: 1/4" TS unbalanced jacks for connection to the right and left outputs of a stereo instrument, or if nothing is plugged into the Left input, the signal connected to the Right input feeds both sides.

## CONNECTION / OPERATION

The following three sections show examples for:

1. Connecting the inputs
2. Connecting the auxiliary section to a signal processor
3. Connecting the outputs.

### INPUT CONNECTION EXAMPLE

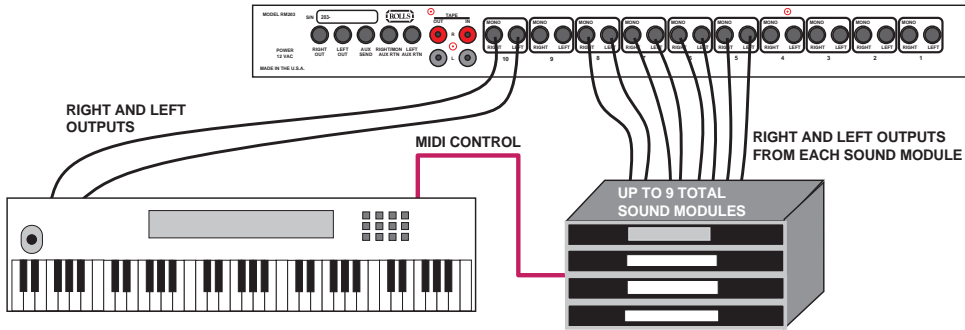

The RM203 is designed to receive line-level signals, thus a microphone or other low input signal will be insufficient to drive the RM203 inputs. Connect the outputs of each instrument or module via a 1/4" cable.

### AUXILIARY SEND/STEREO RETURN CONNECTION EXAMPLE

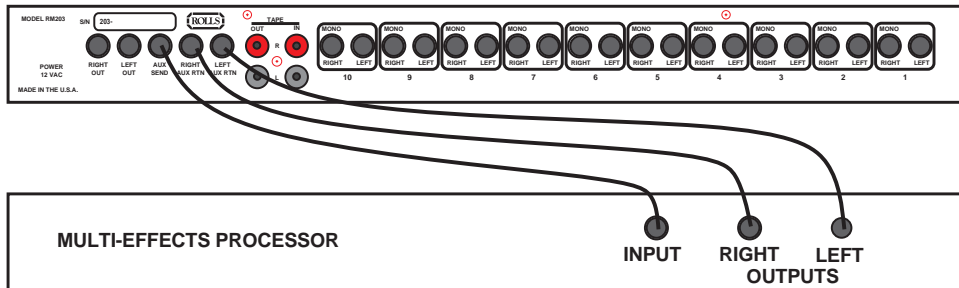

Connect 1/4" unbalanced cables to the Aux Send to the Input of the signal processor, and connect each signal processor output to its corresponding Aux Return jack. Set the "Mix" control on your signal processor to 100% effect since the dry portion of the signal is mixed in the RM203.

**NOTE:** The RM203 Aux Send jack may also be connected to an amplifier, then to speakers and used as a Monitor Send.

### CONNECTING THE OUTPUTS

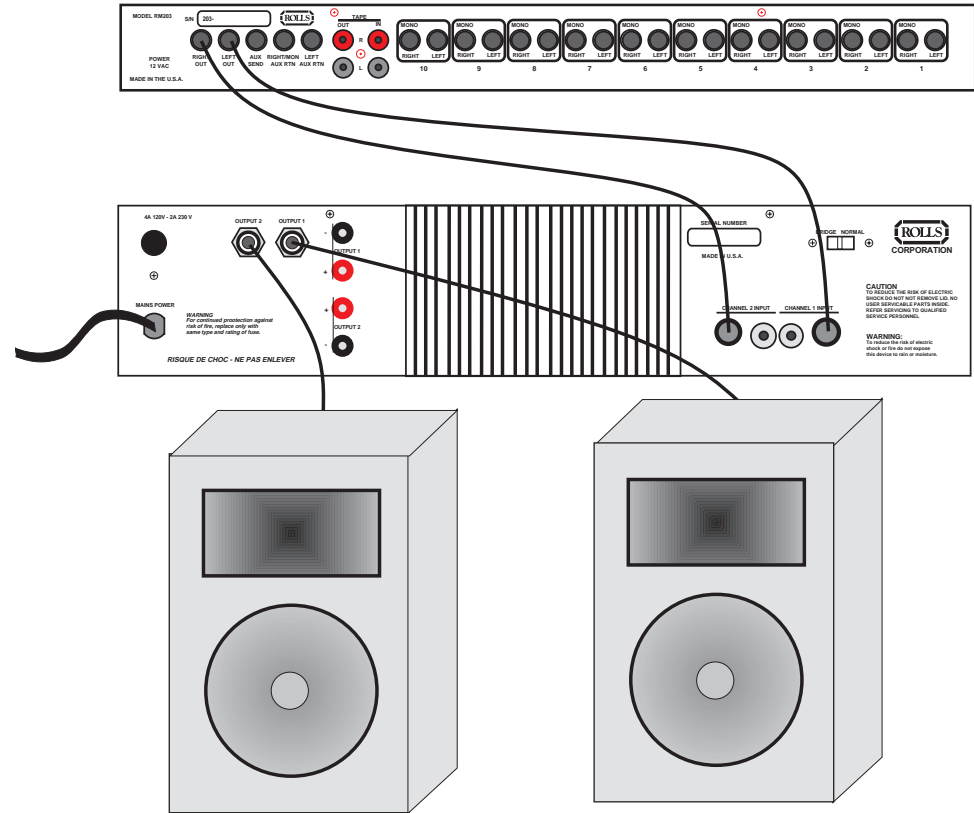

Connect the RM203 Right and Left Outputs to an amplifier via two balanced TRS 1/4" jacks (two TS unbalanced jacks will work as well).