

DPS-V77

SERVICE MANUAL

US Model
Canadian Model
AEP Model
Australian Model

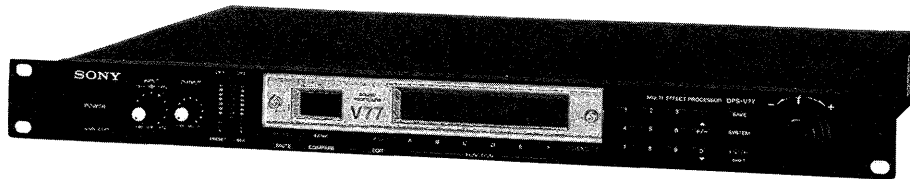

SPECIFICATIONS

A/D Converter	1 Bit / 64 times oversampling (24 bit resolution)		
D/A Converter	Advanced PULSE D/A converter (20 bit resolution)		
Sampling Frequency	Analog input	48 kHz	
	Digital input	44.1/48 kHz (auto-switching)	

Analog Input

Jack type	reference input level	maximum input level	input impedance	circuit type
XLR-3-31	+4 dBs	+21 dBs	20 kilohms	balanced
PHONE	-20 dBs or +4 dBs	-2 dBs or +21 dBs	50 kilohms	unbalanced

0 dBs = 0.775 Vrms

XLR-3-31 connectors (1 : GND 2 : HOT 3 : COLD)

Analog Output

Jack type	reference output level	maximum output level	load impedance	circuit type
XLR-3-32	+4 dBs	+21 dBs	600 ohms or more	balanced
PHONE	-20 dBs or +4 dBs	-2 dBs or +21 dBs	10 kilohms or more	unbalanced

0 dBs = 0.775 Vrms

XLR-3-32 connectors (1 : GND 2 : HOT 3 : COLD)

Digital Input/Output Terminal type: 8 pin mini DIN
Use optional cables RK-V77A (for AES/EBU) or RK-V77S (for SPDIF)

Pedal Input Terminal type: Standard PHONE type
(assignable control terminals x 2)

MIDI Input/Output Jack: 5 pin DIN (IN x 1, OUT/THRU x 1)
OUT/THRU can be set to either OUT or THRU

Frequency Response 10 – 22 kHz +0, -1.0 dB

Signal-to-Noise Ratio Greater than 97 dB

Dynamic Range Greater than 97 dB

Distortion Less than 0.003% (1 kHz)

Memory Preset 198 locations (99 location preset bank x 2)
User 198 locations (99 location user bank x 2)

Power Source AC 120 V, 60 Hz
AC 230 V, 50/60 Hz

Power Consumption 23 W (120 V)
25 W (230 V)

Dimensions 482 x 44 x 320mm (WxHxD not including projections)

Mass approx. 4.7 kg

Design and specifications subject to change without notice.

MULTI-EFFECT PROCESSOR
SONY



TABLE OF CONTENTS

Section	Title	Page
1.	GENERAL	3
2.	TEST MODE	17
3.	CLOCK CONSTRUCTION	19
4.	EXPLANATION OF IC TERMINALS	20
5.	DIAGRAMS	
5-1.	Block Diagram	24
5-2.	Printed Wiring Boards	28
5-3.	Schematic Diagram (1/2)	33
5-4.	Schematic Diagram (2/2)	38
6.	EXPLODED VIEWS	
6-1.	Front Panel Section	48
6-2.	Chassis Section	49
7.	ELECTRICAL PARTS LIST	50

CAUTION

Danger of explosion if battery is incorrectly replaced. Replace only with the same or equivalent type recommended by the equipment manufacturer. Discard used batteries according to manufacturer's instructions.

ADVARSEL !

Lithiumbatteri-Eksplodingsfare ved fejlagtig håndtering. Udskiftning må kun ske med batteri af samme fabrikat og type. Lever det brugte batteri tilbage til leverandøren.

ADVARSEL

Eksplodingsfare ved feilaktig skifte av batteri. Benytt samme batteritype eller en tilsvarende type anbefalt av apparatfabrikanten. Brukte batterier kasseres i henhold til fabrikantens instruksjoner.

VARNING

Explosionsfara vid felaktigt batteribyte. Använd samma batterityp eller en likvärdig typ som rekommenderas av apparattillverkaren. Kassera använt batteri enligt gällande föreskrifter.

VAROITUS

Paristo voi räjähtää, jos se on virheellisesti asennettu. Vaihda paristo ainoastaan laitevalmistajan suosittelemaan tyyppiin. Hävitä käytetty paristo valmistajan ohjeiden mukaisesti.

SAFETY CHECK-OUT (US Model)

After correcting the original service problem, perform the following safety check before releasing the set to the customer:

Check the antenna terminals, metal trim, "metallized" knobs, screws, and all other exposed metal parts for AC leakage. Check leakage as described below.

LEAKAGE TEST

The AC leakage from any exposed metal part to earth ground and from all exposed metal parts to any exposed metal part having a return to chassis, must not exceed 0.5 mA (500 microamperes). Leakage current can be measured by any one of three methods.

1. A commercial leakage tester, such as the Simpson 229 or RCA WT-540A. Follow the manufacturers' instructions to use these instruments.
2. A battery-operated AC milliammeter. The Data Precision 245 digital multimeter is suitable for this job.
3. Measuring the voltage drop across a resistor by means of a VOM or battery-operated AC voltmeter. The "limit" indication is 0.75 V, so analog meters must have an accurate low-voltage scale. The Simpson 250 and Sanwa SH-63Trd are examples of a passive VOM that is suitable. Nearly all battery operated digital multimeters that have a 2V AC range are suitable. (See Fig. A)

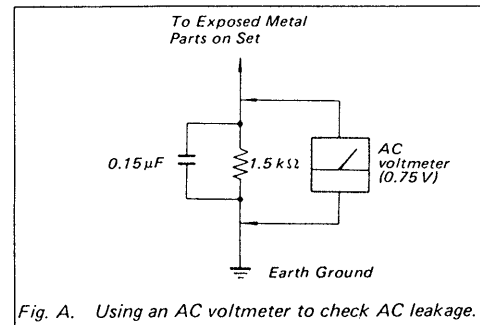





Fig. A. Using an AC voltmeter to check AC leakage.

SAFETY-RELATED COMPONENT WARNING!!

COMPONENTS IDENTIFIED BY MARK  OR DOTTED LINE WITH MARK  ON THE SCHEMATIC DIAGRAMS AND IN THE PARTS LIST ARE CRITICAL TO SAFE OPERATION. REPLACE THESE COMPONENTS WITH SONY PARTS WHOSE PART NUMBERS APPEAR AS SHOWN IN THIS MANUAL OR IN SUPPLEMENTS PUBLISHED BY SONY.

ATTENTION AU COMPOSANT AYANT RAPPORT À LA SÉCURITÉ!

LES COMPOSANTS IDENTIFIÉS PAR UNE MARQUE  SUR LES DIAGRAMMES SCHÉMATIQUES ET LA LISTE DES PIÈCES SONT CRITIQUES POUR LA SÉCURITÉ DE FONCTIONNEMENT. NE REMPLACER CES COMPOSANTS QUE PAR DES PIÈCES SONY DONT LES NUMÉROS SONT DONNÉS DANS CE MANUEL OU DANS LES SUPPLÉMENTS PUBLIÉS PAR SONY.

Getting Started

Names and Functions of Parts

Front panel

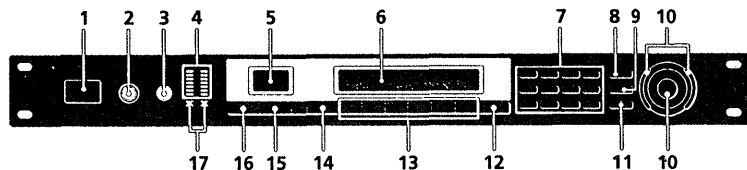

1 POWER ON/OFF switch

Press this switch to turn the power on and off. Turning on the power recalls the last used memorized effect and activates play mode automatically.

2 INPUT level adjustment knob

Turn the knob to the left or right to adjust the input level. Adjustments can be made independently for each channel. The outer knob adjusts channel 1 (CH 1) and the inner knob adjusts channel 2 (CH 2) (page 14).

3 OUTPUT level adjustment knob

Turn to the left or right to adjust the output level from the output jacks.

4 Input level meter

Indicates the strength of the input signal from -36 dB to CLIP (overload) with green, orange, and red indicators (page 14).

5 Memory number display window

Displays the memory number of current effect. 99 different effects are stored in each of the PRESET memory banks and up to 99 effects can be stored in each of the USER memory banks.

6 Multi display

Displays various information, such as the name of the currently selected effect, parameter values, and messages.

7 Number buttons

Use these buttons to recall effects from the currently chosen memory bank directly and input exact parameter values (page 14).

Use ▲ or ▼ while holding down ENTER/SHIFT to make incremental adjustments to parameter values (page 14).

8 SAVE button

Use this button after changing parameter values to save a custom effect in one of the USER memory banks (page 22).

9 SYSTEM button

Use this button to access the system menus and customize the effector's operating environment (pages 24 and 25).

10 Operation dial/Shuttle ring

Use to select memory numbers from the currently selected memory bank and make adjustments to parameter settings. The operation dial lets you advance in one-step increments. The jog dial lets you advance rapidly in larger increments. The rate of advance (or value change) changes according to the angle of the shuttle ring.

11 ENTER/SHIFT button

Use this button to enter a memory number or parameter value input with the numeric buttons (page 14). Hold down while pressing the ▲ or ▼ button to make a one-step adjustment to a memory number or a parameter value (page 14).

12 EXIT button

Press after or during a setting procedure to return to the previous screen or mode, or to de-select an active parameter on the play screen.

13 FUNCTION A-F buttons

Use to select the items displayed above the respective buttons.

14 EDIT/PAGE button

Press during play mode to access the edit screen and make changes to the current effect (page 17). Press to display different pages of multi-page menus (page 17).

15 BANK/COMPARE button

Press to select the memory bank containing the effect you desire (page 14). In edit mode, press to compare alterations in effect parameters to the unaltered effect (page 18).

16 BYPASS/MUTE button

Press to route the signal around the effect processing circuitry so that the signal being input is output unchanged (bypass), or to completely cut output from the effector (mute), (see page 15).

17 Memory bank indicators

Indicate the currently selected memory bank: PRESET 1, PRESET 2, USER 1, or USER 2 (see page 14).

Names and Functions of Parts

Rear panel

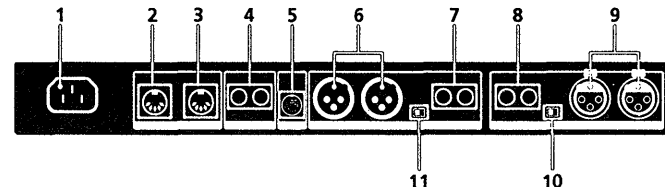

1 AC power cord socket

For connecting the effector to an AC power outlet using the supplied AC power cord.

2 MIDI THRU/OUT terminal

For sending and/or relaying MIDI command signals from the effector to other components (see page 26 to select THRU or OUT).

3 MIDI IN terminal

Input for MIDI command signals. Use a commercially available MIDI cable to connect this terminal to another component's MIDI OUT (or THRU) terminal.

4 PEDAL 1 and 2 jacks

Inputs for pedal switches and/or volume control (pages 21 and 25).

5 DIGITAL I/O terminal

Use digital interface cable RK-V77A (for AES/EBU) or RK-V77S (for SPDIF) to make digital connections between the effector and other components (pages 8, 12, 13 and 29).

6 BALANCED OUTPUT jacks

Balanced output jacks for channel 1 and channel 2 (pages 9 and 10).

7 STANDARD OUTPUT jacks

Standard output jacks for channel 1 and channel 2 (pages 9 and 10).

8 STANDARD INPUT jacks

Standard input jacks for channel 1 and channel 2 (pages 9 and 10).

9 BALANCED INPUT jacks

Balanced input jacks for channel 1 and channel 2 (pages 9 and 10).

10 INPUT level selector switch

Use to set the input level of the STANDARD INPUT jacks (8) to match the output level of the connected equipment. You can select a -20 dB or +4 dB input level.

11 OUTPUT level selector switch

Use to set the output level of the STANDARD OUTPUT jacks (7) to match the input level of the connected equipment. You can select a -20 dB or +4 dB output level.

Getting Started

Understanding the Signal Flow

This unit takes in audio signals from two types of input jacks (digital and analog), processes them using various internal blocks, and outputs them through the analog and digital output jacks. To make the most of this unit, it is essential that you have a firm understanding of the audio signal flow. This section provides an explanation of the internal blocks and how they process the input and output audio signals.

Block and structure

The audio signal processor in this unit is divided into two parts, BLOCK A and BLOCK B. Each of these blocks is composed of an EQ BLOCK and an FX (effect) BLOCK. The EQ BLOCK works as an equalizer. The FX BLOCK contains a large number of multi-effects.

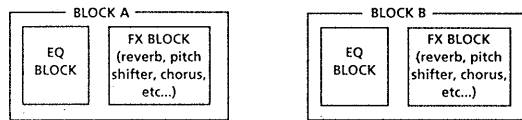

The positioning of the EQ block and the FX block is determined when editing the EQ BLOCK by choosing either "Pre" or "Post" in the [Mode] parameter. In other words, you can choose, independently within BLOCK A and BLOCK B, whether to add the effect to the sound coming from the equalizer, or equalize the sound produced by the effect.

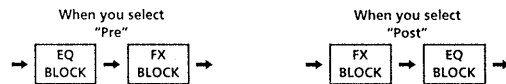

It's also necessary to determine the positions of the larger blocks, BLOCK A and BLOCK B. Their positioning, the way they are connected, is called the "structure." Set the structure according to the kind of sound you want to make. The structure screen not only lets you choose the structure type (see the following chart), but also lets you adjust the output level for each block (represented in the chart by the MIX BLOCK).

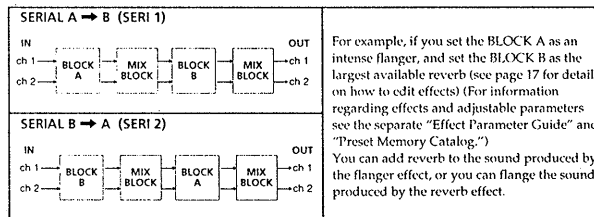

→ See page 17 to EDIT an effect.

→ See page 19 to change the structure.

<p>PARALLEL (PARA)</p>	<p>This structure lets you apply effects, like flanger and reverb, separately and then mix them before output. In this case, there's no undulation from the flanger in the reverb.</p>
<p>DUAL (DUAL)</p>	<p>This structure lets you isolate ch 1 and ch 2. For example, you can connect a guitar to ch 1 and a drum machine to ch 2, then add a flanger effect to the guitar and a reverb effect to the drum machine.</p>
<p>MORPHING (MORPH)</p>	<p>This structure lets you make seamless changes between effects stored in the memory banks. In other words, it keeps the current effect from suddenly cutting out when you change to another effect. For details on morphing, see "Morphing" on page 16.</p>

Setting the INPUT/OUTPUT levels

This chart shows the overall signal flow relationship between this unit's inputs and outputs. The following information is an overview of all you need to know regarding this unit's inputs and outputs.

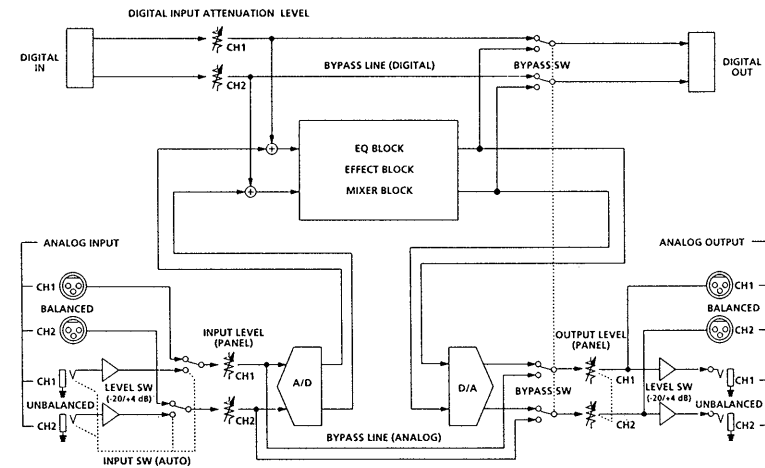

You can use the effector as an A/D or D/A converter by turning off all the effects.

Getting Started

Analog IN/OUT and digital IN/OUT

This unit is provided with both analog and digital inputs and outputs, and you can use both of them at the same time. The input block in the SYSTEM: Setup menu lets you determine whether to use the analog, the digital, or both the analog and the digital INPUT/OUTPUT jacks.

Analog INPUT priority

This unit is provided with both PHONE and XLR type analog INPUT and OUTPUT jacks. Although the signal is always output from both the PHONE and XLR jacks, the PHONE jacks are given priority for the input signal. When the PHONE and XLR INPUT jacks are used at the same time, the XLR signal is automatically cut.

Emphasis

Some older CDs have "emphasized" high frequency sounds. When outputting an analog signal from an "emphasized" digital source, it is necessary to "de-emphasize" the high frequency sounds and bring them back to their original levels. The [Input] block in the SYSTEM: Setup menu lets you determine whether de-emphasis will be carried out automatically, or manually.

Adjusting the INPUT/OUTPUT levels (to prevent clipping)

The numbers on the level meter show, in decibels, how much room is left before the INPUT signal reaches the clip point. If the input signal exceeds the clip point (0 dB), clip noise breaks out. This unit's effect processor incorporates a 12 dB leeway. Therefore, even if you raise the signal level to +12 dB, with the EQ block for example, the internal processor will not clip the signal. It is necessary, however, to reduce levels over 0 dB before they are output. To adjust the effect level, choose [Mixer] in the EDIT mode. See "Changing the effect parameters" on page 17 to edit an effect.



Even though you can decrease levels in the mixer block, the most important factor in preserving sound quality is the input level. The following is a general guide line for adjusting the input level, but your eyes and ears are ultimately the most useful tools in determining and maintaining the appropriate input level.

INPUT jacks	Signal	level meter reading
Digital (with the digital attenuator set to 0 dB)	0 dB digital (full swing)	0 dB
Analog (+ 4 dB) BALANCED or UNBALANCED (with the front panel INPUT knob set to 0 dB)	+ 21 dB signal	0 dB
	+ 4 dB signal	-17 dB
Analog (- 20 dB) UNBALANCED (with the front panel INPUT knob set to 0 dB)	- 2 dB signal	0 dB
	- 20 dB signal	-18 dB

→ See "Setting the DIGITAL IN/OUT" on page 13.

→ See "Names and Functions of Parts" on page 7.

→ See "Setting the DIGITAL IN/OUT" on page 13.

Bypass and Mute

The bypass function outputs the sound of the signal originally input into the effector without adding any effects. Pressing the bypass button turns the bypass function on and off. "Mute" is also available as a form of bypass. When the BYPASS button is set to mute, the sound of the originally signal is cut in addition to the sound of the effects. Therefore, no sound comes from the unit. You can set BYPASS button to operate as either "Mute" or "Bypass" in the SYSTEM: Setup menu.

→ See "Names and Functions of Parts" on page 6.

→ See "Outputting Without Effects (BYPASS/MUTE)" on page 15 to set the bypass mode.



Muting the sound is more than just turning the volume to "0." It is designed to prevent sound from returning to the mixer when the unit is connected in a send-return loop with a mixer. Ideally, when this unit is connected to a mixer, the sound of the input signal is should not be output from this unit, only the sound of the effects should be output (see "Cutting the Direct Sound (Dry On/Off)" on page 25). In this situation, however, using bypass only cuts the sound of the effects, and the sound input into the effector goes back to the mixer, producing a double signal. Using mute prevents the sound input into the effector from returning to the mixer and insures that only the sound generated from the original source (guitar, keyboard, etc.) reaches the mixer. In other words, it is the same as bypass.

When using effects

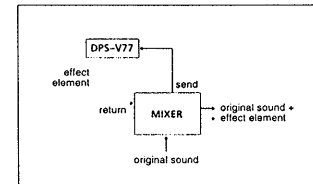

When NOT using effects

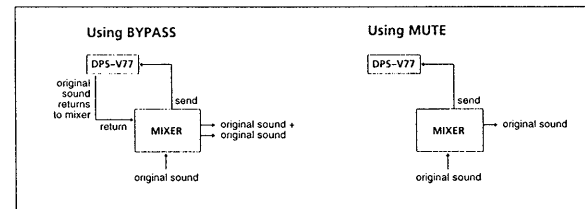

Hooking Up

Basic Hookups

- Before connecting this unit to another device, be sure to unplug the AC power cord from the power outlet.
- Turn off the power switch on this unit and all components to be connected, such as keyboards and active speakers (speakers with built in amplifiers).
- After all the connections, double check that the connections are correct before plugging the AC power cord back into the power outlet.
- If the connected components output large signals that cause distortion, adjust the INPUT knob on this unit to lower the input level, or lower the output level of the connected component.

Example 1: Hooking up to an instrument

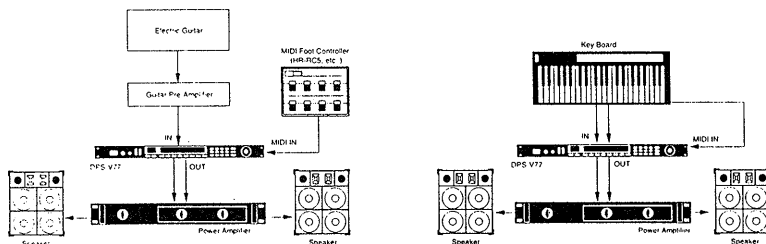

Example 2: Hooking up to a mixer (cutting the direct sound)

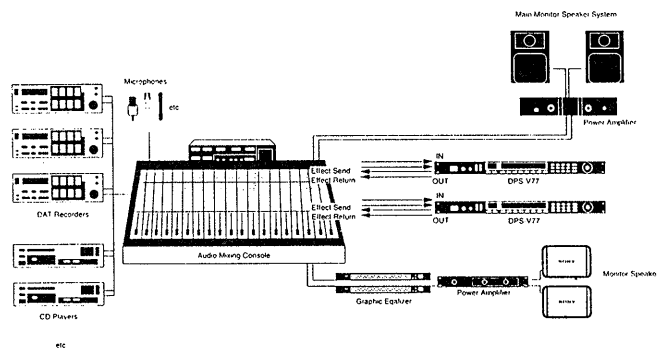

When using the effector in a send-return loop

- We recommend setting the direct output level to $-\infty$ (minus infinity). (See "Cutting the Direct Sound (Dry On/Off)" on page 25.)
- We also recommend setting the BYPASS function to MUTE (as shown on page 15).

Digital Hookups

By taking advantage of the DPS-V77's DIGITAL I/O connectors, you can make digital recordings on DAT recorders, input digital signals from CD, and make digital connections to mixers (see page 29).

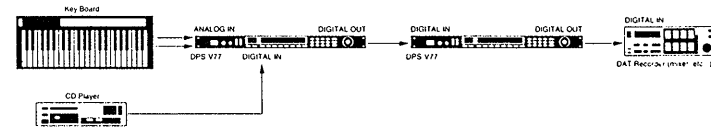

Setting the Digital IN/OUT

To obtain the best possible sound quality when using the DIGITAL I/O jack, we recommend setting the input mode to digital, instead of both (digital and analog).

The following steps show you how to set the input mode, adjust the digital input level, and select the "de-emphasis" mode. Refer to "Understanding the Signal flow on page 8 for details regarding the digital signal flow. Also, see "Input Settings and the Input Signal" and "Digital I/O Terminal Chart" on page 29 for additional information.

1 Press SYSTEM.

2 Press FUNCTION A to choose "Set Up."

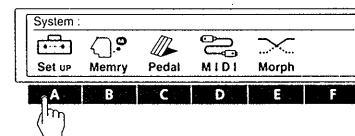

3 Press FUNCTION A to choose "Input."

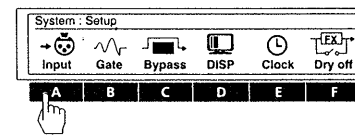

4 Press FUNCTION A [Mode] and use the operation dial to select "DIGTL" (digital).

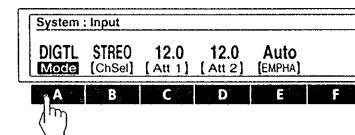

You can select analog (ANALG), digital (DIGTL), or both analog and digital (Both) jacks for input and output.

5 Press FUNCTION B [ChSel] and use the operation dial to select the input channel(s).

To use both CH1 and CH2, choose stereo (STREO).
To use only CH1, choose monaural 1 (MONO 1).
To use only CH2, choose monaural 2 (MONO 2).

This setting can also be made when using the analog inputs.

6 Press FUNCTION C [Att 1] or D [Att 2] and use the operation dial to adjust the digital input levels.

[Att 1] lets you adjust the digital input level for CH 1. [Att 2] lets you adjust the digital input level for CH 2. Press FUNCTION C or D twice to link the parameters and adjust both digital input levels at the same time.

See pages 9 and 10 for details regarding the input level.

7 Press FUNCTION E [EMPHA] and use the operation dial to select the de-emphasis mode.

"Auto" activates de-emphasis automatically according to the type of digital signal being input.
"On" de-emphasizes all signals input through the DIGITAL I/O jack.
"Off" turns de-emphasis off and does not alter signals input through the DIGITAL I/O jack.

See page 10 for details on the emphasis function.

Note

This unit's digital input only accepts signals with either 44.1 kHz or 48 kHz sampling frequencies. It cannot be used with 32 kHz signals.

Choosing an Effect

Recalling Effects from the Memory

The effector comes with 198 different effects stored in the preset memory as well as a 198 effect memory capacity for storing the effects you create.

You can use the following procedure to select effects from either the preset memory or the user memory banks.

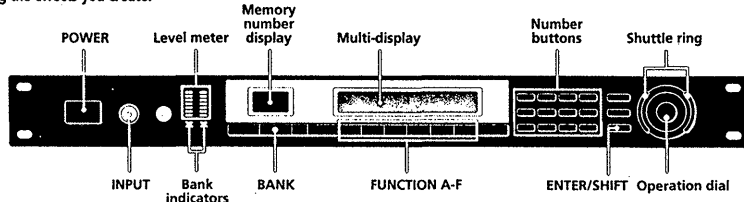

1 Press POWER to turn on the power.

The PLAY screen is displayed.

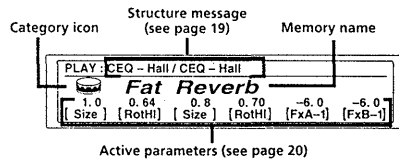

2 Turn INPUT to adjust the analog input levels (for digital levels, see page 13).

If the CLIP indicators light, the input level is set too high. Be sure to set the input level correctly since it has a direct relationship to the quality of the effects (see page 10 for details).

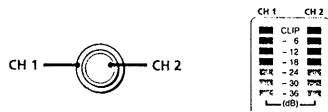

3 Press BANK to select the memory bank containing the effect you want (PRESET/USER 1 or 2).

Only the bottom indicator lights for PRESET or USER bank 1.

Both the top and bottom indicators light for PRESET or USER bank 2.



PRESET banks 1 and 2 hold preset effects. USER banks 1 and 2 are for user memory.

4 Select the effect you desire (1-99).

To select effects using the operation dial/shuttle ring, rotate the dial or ring to display the number of the effect you desire.

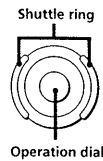

To select effects using the number buttons, input the number of the effect you want, then press ENTER. (If you press the wrong number, input the number again before pressing ENTER.)

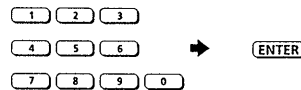

To select effects using the arrow buttons, hold down SHIFT and press either ▲ or ▼ until the number you desire appears in the display.

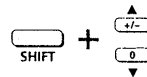

Before you turn on the connected components

Be sure to turn the volume level down to avoid an unexpected output of massive volume.

To change effect parameters from the PLAY screen

See "Editing in PLAY Mode (direct edit)" on page 20.

Outputting Without Effects (BYPASS/MUTE)

The effector comes with two different bypass modes, Bypass and Mute. Therefore, you can use the BYPASS button to cut output of the original sound or to output the original sound without effects depending on which bypass mode you select. Once you set the BYPASS mode, just press BYPASS to activate Bypass or Mute. Press again to cancel the bypass or mute.

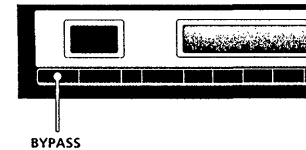

Choosing the bypass mode

1 Press SYSTEM.

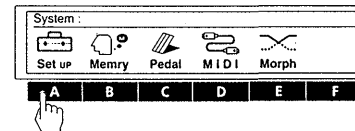

2 Press FUNCTION A to choose "Set Up."

3 Press FUNCTION C to choose "Bypass."

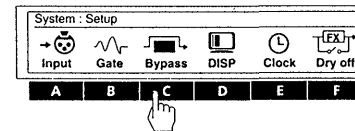

4 Use the operation dial to select BYPAS or Mute.

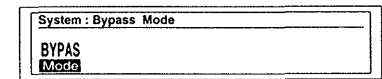

select	when
BYPAS	you want to output the original signal without adding any effects. Only the original signal is output (see "Bypass and Mute" on page 11).
Mute	you want to completely cut the sound output from the effector (including the input signal). We especially recommend using mute when connecting the effector in a send-return loop with a mixer (as shown on page 12).

Press EXIT a few times to return to the PLAY screen.

Choosing an Effect

Morphing

When the structure is set to [MORPH] (see page 8 for details on the system structure, see page 19 to change the structure), the effector creates a seamless change between effects when you select other memory numbers whose structures are also set to [MORPH].

Note

The effector does not respond to any commands (including MIDI) during the morphing process. It will not respond until the preset morphing time has elapsed (see below).

Setting the morphing time and curve

1 Press SYSTEM.

2 Press FUNCTION E to select "Morph."

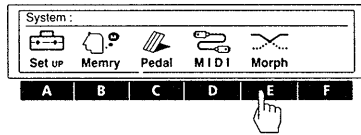

3 Press FUNCTION A [Time] and use the operation dial to set the morphing time.

The morphing time is the length of time from the beginning to the end of the morphing process. The effector will not respond to any commands (including MIDI) during this period.

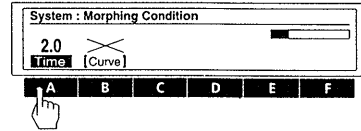

4 Press FUNCTION B [Curve] to select the morphing curve.

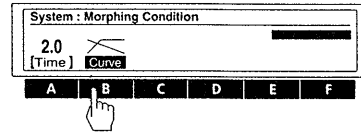

- Provides a gradual transition to the next sound.
- Brings the next sound in quickly while the first sound fades out.

Note

You cannot set the morphing time and curve independently for each effect.

Processing Effects (EDIT)

Changing Effect Parameters

The effector comes with 198 different effects stored in the preset memory as well as a 198 effect memory capacity for storing the effects you create by altering parameter values.

Use the following procedure to create original effects by editing the effects stored in the preset memory banks.

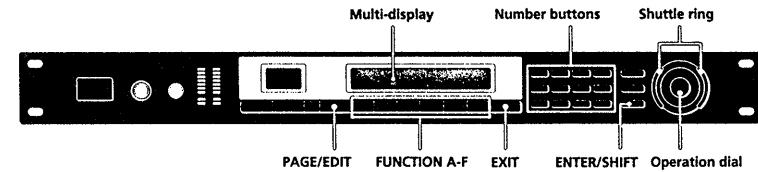

1 Choose an effect.

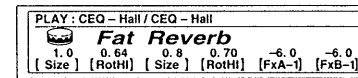

2 Press EDIT/PAGE.

The EDIT SELECT screen appears in the display.

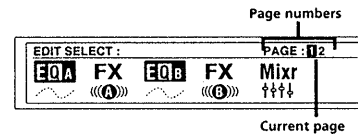

The numbers in the upper right corner of the display indicate the number of pages (basic screens) in the current block. The number in the black square indicates the current page. Press EDIT/PAGE again to switch to the next page. Press EDIT/PAGE while holding down ENTER/SHIFT to page backwards.

3 Use the FUNCTION buttons (A-F) to choose the block you want to change.

The screen for the chosen block appears in the display. For example, pressing FUNCTION A selects "EQ A" and the EDIT: EQ A screen appears (the example below shows a shelving equalizer).

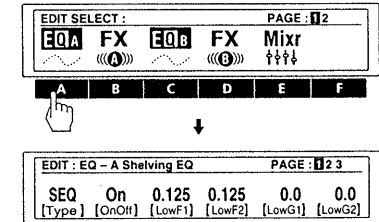

4 Use the FUNCTION buttons (A-F) to select the parameter you want to change.

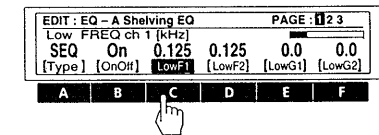

(Continued)

Processing Effects (EDIT)

- 5 Turn the operation dial to choose the setting you desire.

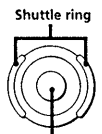

Operation dial

To change numerical values

Use the number buttons and ENTER to input the value you want directly. If you press the wrong number, input the number again before pressing ENTER.

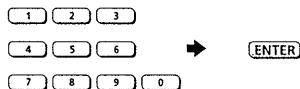

To change numerical values using the arrow buttons, hold down SHIFT and press either ▲ or ▼ until the value you desire appears in the display.

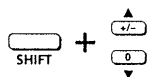

To change another parameter on the same page of the same block
Repeat steps 4 and 5 above.

To change a parameter on a different page of the same block

Press PAGE/EDIT and follow steps 4 and 5 above.

To make changes to another block in the same effect

Press EXIT to return to the EDIT SELECT screen, then follow steps 2 through 4 above.

To return to the PLAY screen after changing parameters

Press EXIT a few times.

Changes made to the parameter settings are replaced by the original settings when you select another effect from the memory. To save the new parameter settings, use the SAVE function (page 22).

To return to the original parameter settings after making changes which have not yet been saved

Press EXIT a few times to get to the PLAY screen, then select another effect from the memory. The settings for the previous effect return to the original values automatically.

Convenient Ways to Edit

To change the same parameter for CH1 and CH 2 at the same time (LINK)

Press the FUNCTION button for the parameter you want to change twice. The characters for the other channel's parameter also reverse and you can adjust both parameters at the same time.

Tapping in a parameter setting (Tap Tempo)

Certain parameters, like Delay Time, can be set by tapping on the ENTER button. After choosing the parameter you want to set, press the ENTER button repeatedly to tap in the tempo you desire. The processor measures the timing of the last two taps and sets the parameter accordingly.

This function can only be used with parameters whose parameter name display is followed by an asterisk (*).

Comparing Effect Parameters

Press BANK/COMPARE while editing an effect to compare the sound of the current parameter settings with the sound of the original, unedited effect.

Press BANK/COMPARE or EXIT to return to the current parameter settings.

Copying Effect Parameters

In EDIT mode, you can copy the parameter settings from an effect block in a given USER or PRESET memory to the same kind of effect block in the current USER memory. For example, you can copy the EQA parameter settings from another USER (or PRESET) memory number into the EQA (or EQB) block of the USER memory number you are currently editing.

1 Follow steps 1 through 3 on the previous page to select the block (e.g. EQA) you want to copy to.

2 Press FUNCTION A [Type] twice.

Confirmation for entering the "parameter copy" screen appears in the display. (Pressing [Type] twice during another edit operation will also activate this function.)

Press FUNCTION F [Yes] to proceed.

Press FUNCTION A [No] to cancel and return to the EDIT mode.

3 Use FUNCTION button A [MEM#] to select the memory number you want to copy from.

4 Use FUNCTION button B or C to select the effect block you want to copy the parameters from.

5 Press FUNCTION F [EXEC] to copy the parameter settings from the effect block you selected in step 4.

To copy an entire effect, see page 23.

Changing the Structure

The effector contains two main effect blocks which perform signal processing to add effects to the incoming signals. You can produce different sounds by changing the structure (configuration) of these two blocks (see page 8 for details).

- 1 Choose the effect you want to edit.



- 2 Press EDIT/PAGE.

- 3 Press FUNCTION E to choose "Mixr."

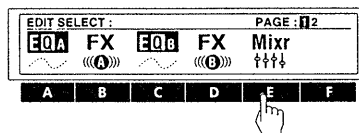

- 4 Press FUNCTION A [STRUCT].

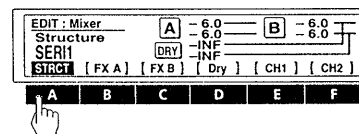

- 5 Turn the operation dial to choose the structure you desire.

SERI 1 (serial processing from FX A to FX B)
SERI 2 (serial processing from FX B to FX A)
PARA (parallel processing of FX A and FX B)
DUAL (processes CH 1 into FX A and CH 2 into FX B)
MORPH (morphing, see page 16)

See pages 8 and 9 for descriptions of each structure.

- 6 Use FUNCTION B [FX A], C [FX B], or D [Dry], if you want to change the output levels.

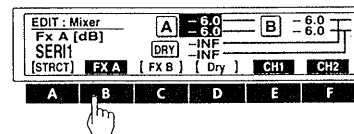

Press FUNCTION E or F after choosing FX A, FX B, or Dry to adjust the levels for each channel independently.

- 7 Turn the operation dial to choose the setting you desire.

See page 10 for additional information regarding the output levels.

Press SAVE to store the new structure settings (see page 22).

Press EXIT a few times to return to the play screen.

Checking the Structure in PLAY Mode

The symbol in the center of the title bar changes according to the structure of the effect.

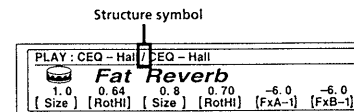

Effect names dimmed in the PLAY bar are effects that are currently set to [OFF].

symbol	structure
>	SERI 1 (serial 1) FX A → FX B
<	SERI 2 (serial 2) FX B → FX A
/	PARA (parallel) FX A + FX B
:	DUAL (dual) FX A (ch 1) + FX B (ch 2)
No Block B	MORPH (morphing) FX A → next memory

See pages 8 and 9 for descriptions of each structure.

Processing Effects (EDIT)

Editing in PLAY Mode (direct edit)

With direct edit you can edit up to 6 different parameters directly from the PLAY screen. These parameters are called Active Parameters.

The following steps show you how to edit from the play screen once you've designated the Active Parameters. To designate Active Parameters, see "Selecting the Active Parameters" below.

1 Choose an effect from the memory banks.

The parameters available for direct editing (Active Parameters) appear directly above their corresponding FUNCTION button.

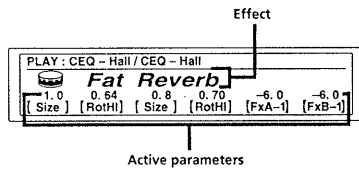

2 Press the FUNCTION button (A-F) of the parameter you want to adjust.

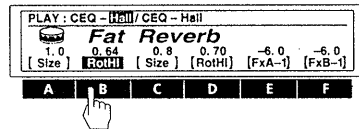

To adjust parameters not displayed in the PLAY screen, see "Changing Effect Parameters" on page 17.

3 Use the operation dial or shuttle ring to adjust the parameter.

When changing numerical values, you can use the number buttons to input the value directly, or hold SHIFT and press ▲ or ▼ to change the value one unit at a time.

Selecting the Active Parameters

The following steps show you how to select the parameters that will appear in the PLAY screen for direct editing.

1 Choose an effect from the memory banks.

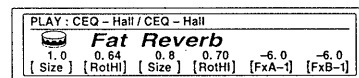

2 Press PAGE/EDIT twice.

3 Press FUNCTION B to choose "Active P."

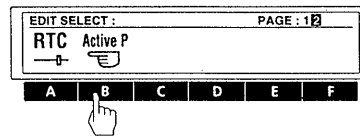

4 Press a FUNCTION button (A-F) to choose a location (1-6).

Active P1-Active P6 correspond to FUNCTION buttons A-F respectively. (e.g., FUNCTION B is used to select Active P2 from the PLAY screen.)

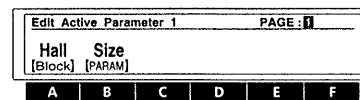
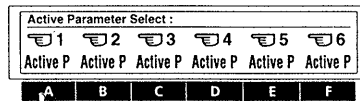

5 Press FUNCTION A [Block] and use the operation dial to select the effect block containing the parameter you want to appear on the PLAY screen.

6 Press FUNCTION B [PARAM] and use the operation dial to select the parameter that will appear on the PLAY screen.

Press EXIT a few times to return to the PLAY screen.

Setting the Real Time Control (RTC)

By using MIDI controls, such as dampers and modulation wheels, you can control various characteristics of an effect in real time. Since control conditions vary for each type of effect, control assignments are made separately for each effect block parameter in the RTC block. The effector is provided with 6 MIDI RTC channels, each carrying independent control source and destination (parameter) information.

1 Choose an effect from the memory banks.

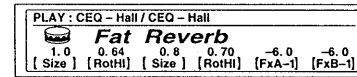

2 Press PAGE/EDIT twice.

3 Press FUNCTION A to choose "RTC."

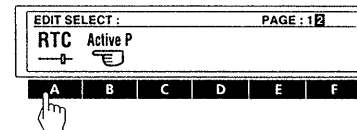

4 Use the FUNCTION buttons (A-F) to choose an RTC channel (1-6).

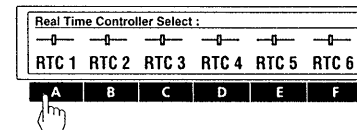

5 Use page 1 to specify the parameter you want to control.

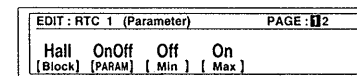

[Block]: selects the block to be controlled, select OFF if you don't want to use that RTC channel.

[PARAM]: specifies the parameter to be controlled from the selected block.

[Min]: specifies the minimal value of the parameter's adjustable range.

[Max]: specifies the maximal value of the parameter's adjustable range.

6 Press PAGE/EDIT and use page 2 to specify kind of controller you will use.

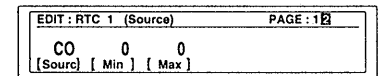

[Source]: selects the control source.

CO-C31 : To use a MIDI control change number.

C64-C120 : To use a MIDI control change number.

Note N : To use a note number

Note V : To use note velocity (Note Off is obtained by setting note velocity to 0.)

BENDR : To use a pitch bender

CH-PR : To use channel pressure

M.CLK : To use the MIDI clock (tempo display) as a control source. Settings can be made within the range of 30 to 250.

PEDL 1 : To use pedal 1 (Be sure to select "Pedal" on the System: Pedal screen, page 25).

PEDL 2 : To use pedal 2 (Be sure to select "Pedal" on the System: Pedal screen, page 25).

[Min]: specify the minimal value of the control source's adjustable range.

[Max]: specify the maximal value of the control source's adjustable range.

Press EXIT a few times to return to the PLAY screen.

EXAMPLE

Suppose you want to set RTC 1 to use the MIDI control change number 8 (balance control) to change the Hall Reverb effect balance from 75:25 to 25:75 :

EDIT: RTC 1 (Parameter) screen (step 5) :

Set [Block] to "HALL" and set [PARAM] to "E. BAL" (effect balance). Then set [Min] to "75:25" and [Max] to "25:75."

EDIT: RTC 1 (Source) screen (step 6) :

Set [Source] to "C8" (control 8), [Min] to "0" and [Max] to "127."

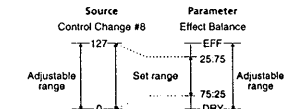

Now you can adjust the effect balance from 75:25 to 25:75 when you adjust control change number 8 (balance control) from 0 to 127.

Saving Processed Effects (SAVE)

Saving an Effect

Effects created by changing the parameter values with the edit function can be stored in one of the two USER memory banks for later use. Each USER bank has room for 99 effects, so you can store up to 198 different effects

The following procedure shows you how to store an effect in one of the USER memory banks.

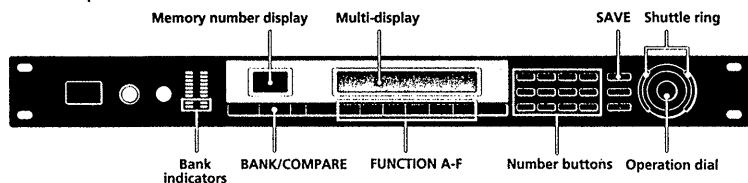

1 Press SAVE.

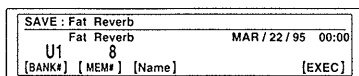

2 Press FUNCTION A [BANK#] and use the operation dial to select the user memory bank (USER 1 or USER 2) where you want to save the effect.

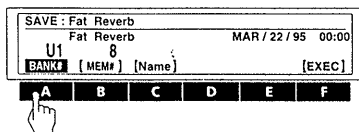

3 Press FUNCTION B [MEM#] and use the operation dial or number buttons to select the memory number (1-99) where you want to save the effect.

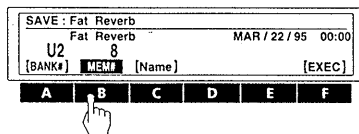

4 Press FUNCTION C [Name].

The Save: name screen appears in the display.

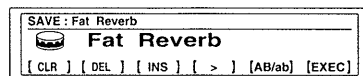

Use the	to																		
Operation dial (shuttle ring)	select icons and characters.																		
Number buttons	select characters. The display changes as shown below each time you press each button:																		
	<table border="0"> <tr><td>[1]</td><td>1 → A → B → C → 1</td></tr> <tr><td>[2]</td><td>2 → D → E → F → 2</td></tr> <tr><td>[3]</td><td>3 → G → H → I → 3</td></tr> <tr><td>[4]</td><td>4 → J → K → L → 4</td></tr> <tr><td>[5]</td><td>5 → M → N → O → 5</td></tr> <tr><td>[6]</td><td>6 → P → Q → R → 6</td></tr> <tr><td>[7]</td><td>7 → S → T → U → 7</td></tr> <tr><td>[8]</td><td>8 → V → W → X → 8</td></tr> <tr><td>[9]</td><td>9 → Y → Z → → 9</td></tr> </table>	[1]	1 → A → B → C → 1	[2]	2 → D → E → F → 2	[3]	3 → G → H → I → 3	[4]	4 → J → K → L → 4	[5]	5 → M → N → O → 5	[6]	6 → P → Q → R → 6	[7]	7 → S → T → U → 7	[8]	8 → V → W → X → 8	[9]	9 → Y → Z → → 9
[1]	1 → A → B → C → 1																		
[2]	2 → D → E → F → 2																		
[3]	3 → G → H → I → 3																		
[4]	4 → J → K → L → 4																		
[5]	5 → M → N → O → 5																		
[6]	6 → P → Q → R → 6																		
[7]	7 → S → T → U → 7																		
[8]	8 → V → W → X → 8																		
[9]	9 → Y → Z → → 9																		
FUNCTION A [←/CLR]	move the cursor backward. When the cursor is all the way to the left, [CLR] (clear) appears instead of [←] and lets you erase the entire name.																		
FUNCTION B [DEL]	delete the character at the cursor position.																		
FUNCTION C [INS]	insert a space at the cursor position.																		
FUNCTION D [>]	move the cursor forward.																		
FUNCTION E [AB/ab]	switch between capital or small letters.																		
FUNCTION F [EXEC]	execute the save operation.																		

Use EXIT to go back to the previous screen if necessary.

5 Press FUNCTION F [EXEC] to execute the save operation.

The PLAY screen appears in the display.

Protecting USER Memory

This function locks the contents of the specified USER memory number so that new effects cannot be saved to that number and the contents of that memory number cannot be deleted or written over by a copy command.

- 1 Press SYSTEM.
 - 2 Press FUNCTION B to choose "MEMORY."
 - 3 Press FUNCTION E to choose "PROTECT."
- The operation dial or shuttle ring selects the memory number. FUNCTION F [EXEC] turns protection on or off.

Organizing USER Memory

Since each of the USER memory banks can hold up to 99 effects, you may find it difficult to keep track of where certain effects are located. The following procedures show you how to copy, move, swap, and erase effects in the user memory so that you can organize the effects into a comfortable configuration.

Copying a memory file (Copy)

This function lets you copy the contents of a selected USER or PRESET memory number to a specified USER memory number.

- 1 Press SYSTEM.
 - 2 Press FUNCTION B to choose "MEMORY."
 - 3 Press FUNCTION A to choose "Copy."
- FUNCTION A [SOURC] selects the source memory number to be copied. FUNCTION B [DEST] specifies the destination. FUNCTION F [EXEC] executes the copy operation.

Moving USER memory (Move)

This function lets move the contents of a specified USER memory number to another USER memory number.

- 1 Press SYSTEM.
 - 2 Press FUNCTION B to choose "MEMORY."
 - 3 Press FUNCTION B to choose "Move."
- FUNCTION A [SOURC] selects the source memory number to be moved. FUNCTION B [DEST] selects the destination. FUNCTION F [EXEC] executes the move operation.

Exchanging USER memory (XCHG)

This function lets you exchange the contents of two USER memory numbers.

- 1 Press SYSTEM.
 - 2 Press FUNCTION B to choose "MEMORY."
 - 3 Press FUNCTION C to choose "XCHG."
- FUNCTION A [MEM1#] selects the first memory number to be exchanged. FUNCTION B [MEM2#] selects the second memory number to be exchanged. FUNCTION F [EXEC] Executes the exchange operation.

Deleting USER memory (DEL)

This function lets you delete the contents of a USER memory number.

- 1 Press SYSTEM.
 - 2 Press FUNCTION B to choose "MEMORY."
 - 3 Press FUNCTION D to choose "DEL."
- The operation dial or shuttle ring selects the memory number. FUNCTION F [EXEC] executes the delete operation.

Setting the System Environment

In the system mode lets you set up the effector's operating environments. To go back to the previous screen during setup, press EXIT once. To return to the play mode after making adjustments, press EXIT a few times until you reach the PLAY screen.

The following steps describe how to make changes in the system setup.

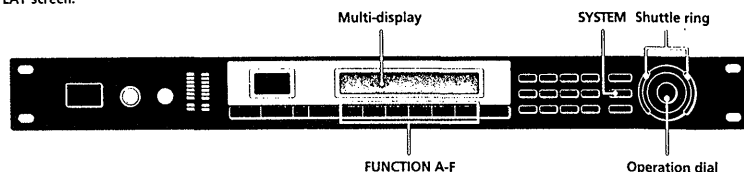

1 Press SYSTEM.

2 Press FUNCTION A to select "Set Up."

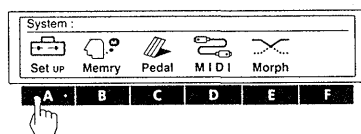

3 Use FUNCTION buttons (A-F) to choose the items you want to adjust.

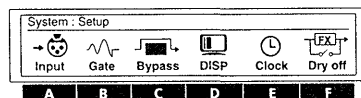

4 Use FUNCTION buttons (A-F), operation dial, shuttle ring, number buttons, or the SHIFT and ▲ and ▼ buttons to make the adjustments you desire.

Setting the Clock (Clock)

The clock function lets you set the time and date of the effector's built in clock. Once the clock is set, the date and time are automatically stored in the user memory when you save a processed effect.

- 1 Press SYSTEM.
 - 2 Press FUNCTION A "Set Up."
 - 3 Press FUNCTION E "Clock."
- FUNCTION A [Month] sets the Month.
 FUNCTION B [Day] sets the Day.
 FUNCTION C [Year] sets the Year.
 FUNCTION D [Hour] sets the Hour.
 FUNCTION E [MIN] sets the Minute.
 FUNCTION F [Start] starts the clock.

Setting the Display Mode

The display function lets you adjust the display mode and display contrast.

- 1 Press SYSTEM.
 - 2 Press FUNCTION A "Set Up."
 - 3 Press FUNCTION D "DISP."
- FUNCTION A [Mode] selects the display mode.
 Name : displays the name of the memory file in large characters and the Active Parameter settings in small characters.
 Value : displays the memory name in small characters and the Active Parameter settings in large characters.
 FUNCTION B [LCD] adjusts the contrast of the display.

Setting the Noise Gate (Gate)

Use the noise gate function when the source of the input signal generates a lot of noise. Running the input signal through the noise gate before processing reduces noise when no sound is being output.

- 1 Press SYSTEM.
 - 2 Press FUNCTION A "Set Up."
 - 3 Press FUNCTION B "Gate."
- FUNCTION A [ATK] sets the attack time (the rate at which the gate opens).
 FUNCTION B [REL] sets the release time (the rate at which the gate closes).
 FUNCTION C [THR] sets the threshold level (the level at which the gate will close). The larger the value, the larger the signal that will enter the gate.

Cutting the Direct Sound (Dry On/Off)

This setting lets you cut the direct sound and output only the sound of the effect, regardless of the MIXER block's DRY LEVEL setting. When using this unit is connected to a mixer in a send/return loop, as shown on page 12, be sure cut the direct sound.

- 1 Press SYSTEM.
- 2 Press FUNCTION A "Set Up."
- 3 Press FUNCTION F "Dry On/Off."

The operation dial selects the dry mode.

OFF : forcibly cuts the direct level (to $-\infty$) regardless of the direct level setting.
 PGM : the direct level determined by the value stored in the mixer block of each effect.

Setting up the Pedal Parameters

Pedals connected to the PEDAL 1 and/or PEDAL 2 jacks on the rear panel can be used to control the functions listed below.

- 1 Press SYSTEM.
 - 2 Press FUNCTION C "Pedal."
 - 3 Press FUNCTION A or B to choose "Pedal 1" or "Pedal 2."
- FUNCTION A [Type] sets the type of pedal function.
 MEM +/MEM - : changes memory numbers up/down.
 Bank +/Bank - : changes bank numbers up/down.
 TBL +/TBL - : changes the table numbers specified in the pedal program table up/down.
 Bypass : sets the pedal to work as the bypass switch
 RTC : sets the pedal to control the parameters set in RTC (see page 21).
 FUNCTION B [MIN] lets you input the setting for when the pedal is in the "up" position (minimum).
 FUNCTION C [MAX] lets you input the setting for when the pedal is in the "down" position (maximum).
 FUNCTION D [Curve] lets you select the MIN to MAX transition curve.
 FUNCTION E [TBL#] lets you select the pedal program table numbers (1-10) when you set FUNCTION A to TBL+/- .
 FUNCTION F [MEM#] lets you select the memory bank and memory number that will respond to the table number set at FUNCTION E.

Other Settings

To set "Bypass," see page 15.
 To set "Input," see page 13.
 To set the MIDI functions see pages 21 and 26.
 To organize the user memory, see page 23.
 To set the morphing function, see page 16.

Using MIDI

You can use the MIDI interface to control various aspects of this unit. For example, you can switch between memorized effects by using the program table, or save USER memory data onto an external storage device.

In addition, MIDI controls, like wheels and velocity effect controllers, can be used to control things like effect depth in real time. (See "Setting the Real Time Control (RTC)" on page 21.)

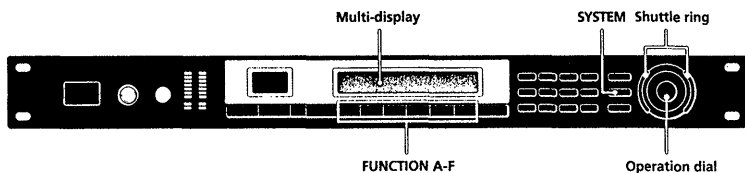

MIDI Transmit Switch Setup (Tx-Sw)

Tx-Sw lets you control how MIDI exclusive data is output from this unit (except when using Bulk-Tx).

- 1 Press SYSTEM.
- 2 Press FUNCTION D to choose "MIDI."
- 3 Press FUNCTION D to choose "Tx-Sw."
 - FUNCTION A [PANEL] selects the whether or not exclusive messages that appear when buttons on the front panel are pressed will be sent via MIDI OUT.

- 1 Press SYSTEM.

- 2 Press FUNCTION D to select "MIDI."

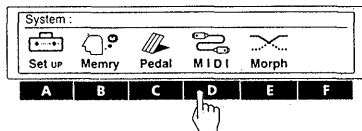

- 3 Use the FUNCTION buttons (A-F) to choose the MIDI block you want to adjust.

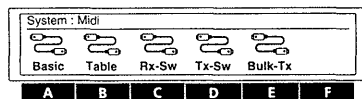

Select	to
Basic	set basic MIDI functions.
Table	determine the MIDI command table.
Rx-SW	determine how MIDI data will be received.
Tx-SW	determine how MIDI data will be transmitted.
Bulk-Tx	send MIDI data in bulk.

- 4 Use FUNCTION buttons (A-F), operation dial, shuttle ring, number buttons, or the SHIFT and ▲ and ▼ buttons to make the adjustments you desire.

Preparing a Basic MIDI Setup (Basic)

Use "Basic" to set basic MIDI functions.

- 1 Press SYSTEM.
- 2 Press FUNCTION D to choose "MIDI."
- 3 Press FUNCTION A to choose "Basic."
 - FUNCTION A [CH] specifies the MIDI channel (1-16).
 - FUNCTION B [OMNI] turns the OMNI function ON/OFF.
 - FUNCTION C [OUT] sets the MIDI function OUT/THRU.

MIDI Program Table Setup (Table)

TABLE lets you decide how the MIDI commands will effect a given memory number, memory bank.

- 1 Press SYSTEM.
- 2 Press FUNCTION D to choose "MIDI."
- 3 Press FUNCTION B to choose "Table."
 - FUNCTION A [MIDI#] selects the MIDI program change number.
 - FUNCTION B [BANK#] selects the memory bank or bypass.
 - FUNCTION C [MEM#] selects the memory number.

MIDI Receive Switch Setup (Rx-Sw)

Rx-Sw lets you decide how this unit will receive MIDI data.

- 1 Press SYSTEM.
- 2 Press FUNCTION D to choose "MIDI."
- 3 Press FUNCTION C to choose "Rx-Sw."
 - FUNCTION A [EXCLV] turns exclusive reception ON/OFF.
 - FUNCTION B [P.Chg.] turns program change reception ON/OFF.
 - FUNCTION C [C.Chg.] turns control change reception ON/OFF.
 - FUNCTION D [CH-P.R] turns channel pressure reception ON/OFF.
 - FUNCTION E [BENDR] turns pitch bender reception ON/OFF.

Transmitting MIDI Data in Bulk (Bulk-Tx)

Bulk-Tx lets you transmit MIDI data in bulk.

- 1 Press SYSTEM.
- 2 Press FUNCTION D to choose "MIDI."
- 3 Press FUNCTION E to choose "Bulk-Tx."
 - FUNCTION A [Type] selects the type of data that will be transmitted (U1, U2, U1+U2, SYSTEM, or ALL).
 - FUNCTION B [NUM] selects whether to transmit all the contents of a memory bank, or only individual memory numbers (when you select U1 or U2 for the [Type]).
 - FUNCTION F [EXEC] to sends the data.

Note

Be sure that both the sending and receiving MIDI channels are set to the same values. If the sending and receiving channels are different, the data will not be received even if OMNI is set to ON.

Additional Information

Troubleshooting

If this unit does not operate as expected, the problem may simply be an oversight, a disconnected cable or a setting error. Before calling a service technician, compare the symptoms of the problem with those listed below to see if you can correct the problem yourself.

No sound is heard, or the sound is small.

- Press BYPASS to cancel mute.
- When inputting analog signals, check to see if the INPUT knob is set to the appropriate level.
- When inputting digital signals, check the Input levels in the System: Setup.
- Check that all the cables are connected correctly.
- Make sure the appropriate input mode is selected on the System: Setup input screen. You cannot input analog signals if the input mode is set to "DIGTL."
- Make sure the effect levels in the mixer block are not set excessively low.
- Check the volume of the connected amplifier or mixer.

The sound is not modified by the selected effect.

- Press BYPASS to cancel bypass.
- Is the effect set to "OFF"?

The morphing effect does not work.

- Make sure to SAVE the effect after changing the structure to [MORPH].
- Make sure the structures of all the effects you want to morph between are set to [MORPH].

The input level CLIP indicator lights.

- Turn INPUT to the left to reduce the input level.
- Reduce the output level of the source component.
- Set the INPUT level selector switch to +4 dB and use the INPUT adjustment knob to re-adjust the input level.

MIDI operations cannot be carried out.

- Make sure the MIDI receive channel matches the transmit channel of the MIDI device.
- Make sure the MIDI control number is set correctly.
- Make sure the MIDI cable is connected securely.

Block Diagram

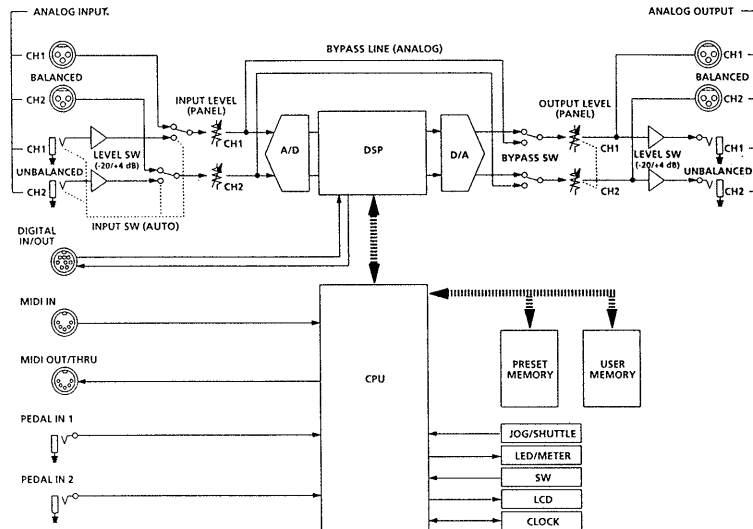

Regarding the options

Two types of digital I/O cables are separately sold.
(Dedicated cables)

① RK-V77A

- Connection cable for AES/EBU
- No. 1-769-782-11

② RK-V77S

- Connection cable for SPDIF
- No. 1-769-783-11

* Outline of optional cables

Special cables used when connecting DPS-V77 and a digital audio format. Depending on the type of the digital audio format, there are two types of dedicated cables, the RK-V77A for professional use and the RK-V77S for consumers using SPDIF (general CD players, DAT, etc.).

Digital I/O Terminal Chart

AES/EBU type

	XLR type	Mini DIN (rear panel)
IN	HOT: 2	5
	COLD: 3	8
	GND: 1	1, 2, 4, 7
OUT	HOT: 2	3
	COLD: 3	6
	GND: 1	1, 2, 4, 7

SPDIF type

	RCA type	Mini DIN (rear panel)
IN	HOT	5
	COLD	8
OUT*	HOT	3
	COLD	6
		1, 2, and 7 are shorted 4 is open

* Note

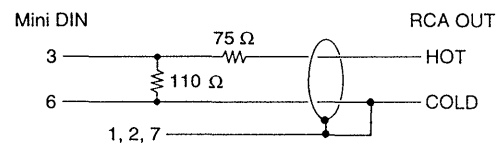

Mini DIN terminal

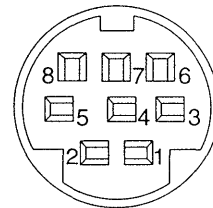

Functional Hierarchy

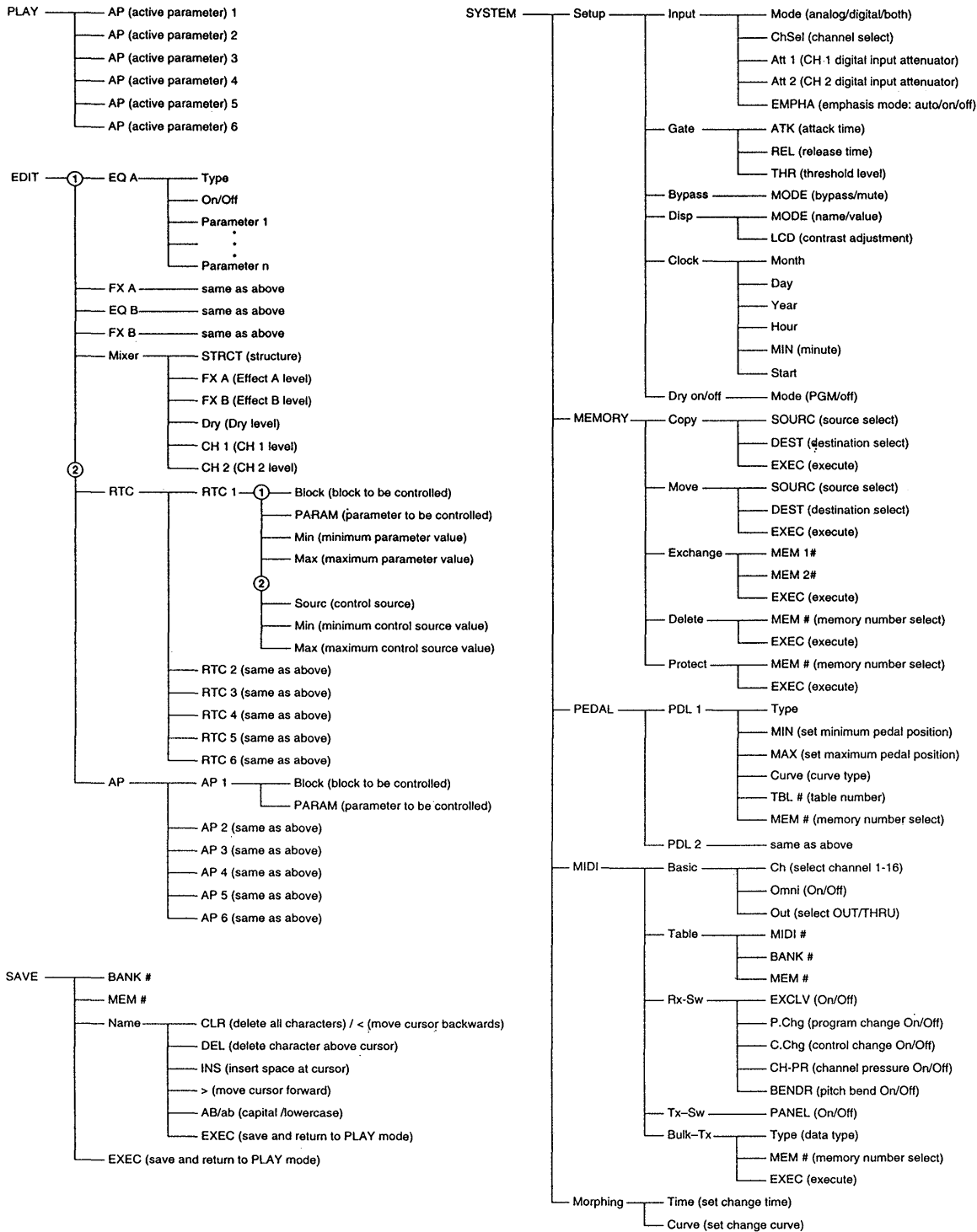

SECTION 2 TEST MODE

- This product uses a microcomputer and is equipped with a MIDI interface for musical instruments and computers, and it has specifications that make possible rewriting of the internal memory with external MIDI equipment.

Due to this, when required, the internal data can be rewritten by the use of external equipment, etc., and in case the internal data should break down at the time of repair (Example: when the power is cut off), it may happen that the operation becomes unstable. Therefore, when carrying out service, make sure to pay attention to the following matters.

⟨Inspection when carrying out repair⟩

A self-test mode function has been provided to carry out inspection of each function without having to use a special jig when the repair has been completed. Make absolutely sure to carry out these inspections before returning the unit to your customer.

⟨Regarding the test mode⟩

All of the inspections should be carried out, but in case some of them have already been completed they may be skipped upon proper judgment.

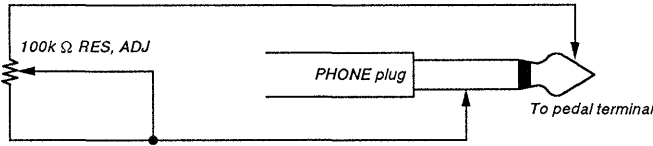
Subject	Operation and Display
1. Entering the test mode. <ul style="list-style-type: none"> ● Initialization of the memory 	Turn the POWER switch ON while depressing the 3 keys of [BANK], [EDIT] and [C]. The following display will appear and the test mode menu will be activated. <div style="border: 1px dashed black; padding: 10px; margin: 10px auto; width: fit-content;"> <p style="text-align: center;">TEST MODE MENU</p> <p style="text-align: center;">> Initialize User Memory?</p> <p style="text-align: center;">YES NO</p> </div> <p style="text-align: center;">[EDIT] [A] [B] [C] [D] [E] [F] [EXIT]</p> <p>1) When initializing the user memory, select YES. 2) When you do not want to initialize the user memory, select NO. Note : Concerning initialization, please refer to <Examples when initialization has to be carried out> on page 16.</p>
2. Inspection of each function (No. 1) <ul style="list-style-type: none"> ● Battery ● Pedal ● Jog&Shuttle ● Switch 	The following display will appear and test mode No. 1 will be activated. <div style="border: 1px dashed black; padding: 10px; margin: 10px auto; width: fit-content;"> <p style="text-align: center;">TEST MODE 1 * 1</p> <p style="text-align: center;">Battery [3.0]</p> <p style="text-align: center;">PDL 1 [] PDL 2 [] J & S []</p> <p style="text-align: center;">SW []</p> </div> <p style="text-align: center;">[EDIT] [A] [B] [C] [D] [E] [F] [EXIT]</p> <p>1) The voltage of the internal lithium battery (BA601) is displayed. As the data of the internal SRAM cannot be maintained if the voltage is lower than 2V, replace the BA601.</p> <p>2) PEDAL1/PEDAL2 terminal (check on the rear panel).</p> <ul style="list-style-type: none"> ● The pedal terminal A/D conversion value is displayed in the range of 000 – 127 within brackets [] by adding the circuit shown below. ● Turn the semifixture and confirm that the figures change. ● If not especially required, this procedure may be skipped. ● If there is no connection at all, 127 will be displayed. <div style="text-align: center; margin: 10px 0;">  </div> <p>3) Checking the Jog & Shuttle dial (front panel)</p> <ul style="list-style-type: none"> ● When rotating the dial, “ * ” will be displayed within the brackets []. When turning the Jog dial once to the left and once to the right, the brackets [] will be fully filled by “ * ” when turning the Shuttle dial fully to the left and right. <p>4) Checking the switch (front panel) When pressing the switch, “ * ” will be displayed within the brackets []. When fully turning the switch, the brackets [] will be fully filled by “ * ”.</p>

Subject	Operation and Display
<ul style="list-style-type: none"> ● Others 	5) Other checks <ul style="list-style-type: none"> ● Other error messages are displayed in * 1. [DRAM1 ERR] or [DRAM2 ERR] Automatic inspection of the soldered bridge, etc., of IC601, IC602, IC603 is carried out. If this display appears, apply a soldering iron to the terminal of each IC and check the application of the solder. In case of [DRAM1 ERR], check IC601 and IC602, and in case of [DRAM2 ERR], check IC603 and IC604. [MIDI PORT ERROR] By using a DIN cable to connect the MIDI IN/OUT terminals on the rear panel, the automatic inspection of the MIDI terminals is carried out. When there is no special requirement to make a connection, this display will appear but it may be ignored.
3. Inspection of each function (No. 2) <ul style="list-style-type: none"> ● LCD #1 ● LCD #2 ● LED 	<ul style="list-style-type: none"> ● If the brackets [] were fully filled with asterisks " * " in the preceding checks of the switch and Jog & Shuttle, press the [ENTER] key. The following display will appear and test mode No. 2 will be activated. <div style="text-align: center; border: 1px dashed black; padding: 10px; margin: 10px auto; width: fit-content;"> <p>TEST MODE 2</p> <p>[LCD] [LED]</p> <p>[EDIT] [A] [B] [C] [D] [E] [F] [EXIT]</p> </div> <ul style="list-style-type: none"> 1) When pressing the [A] key, check that all LCD dots become black. 2) When all the LCD dots have become black, check that the contrast changes when you rotate the Jog & Shuttle dials. 3) When pressing the [B] key, check that each dot and segment light up between the 8 segments, meters and LEDs.
4. Completion of the inspection	When pressing the [EXIT] key, reactivating is carried out and the test mode is completed.

〈Examples when initialization has to be carried out〉

1. When reconnecting the power supply and the keys do not have any effect, and when there are distortions in the display due to unstable operation of the software.
2. When the version of the ROM (IC607) has been changed. (Including change of circuit board.)
3. When the power supply has been changed or removed once.

* Even except for the above, when there are no special instructions from the customer, carry out the initialization operation. The following notes are included in the "Instruction Manual". (See step 3.)

【Notes on being requested to carry out repair】

When requesting a repair, data in the USER memory may be reverted to the original factory data settings. Be sure to save any important data in an external MIDI data file, or make written notes of the parameter settings.

- * Method of initializing without entering the test mode
 - Turn the POWER switch ON while simultaneously keeping the [SAVE] and [ENTER] keys depressed.
 - After the title screen has been shown and "Initialized!" is displayed, the initialization is completed.
 - * In this case, the data of the internal clock is not initialized.

* The following shows the initialization method and the content that is actually initialized.

Initialization method Content being initialized	[SAVE] + [ENTER]	Initialization with the test mode	
		Memory initialization (YES)	Memory initialization (NO)
Initialization of the internal system	○	○	○
Initialization of the user memory	○	○	×
Initialization of the clock data*	×	○	○

* As to setting of the clock, please refer to page 24 in the Instruction Manual.

SECTION 3 CLOCK CONSTRUCTION

[Regarding the clock source of this unit]

1. The clock source for IC614 (CPU : HD6413002) is X601 (10 MHz).
2. The clock source for IC613 (Clock IC : NJU6355) is X603 (32.768 kHz).
3. The clock sources for the digital audio system (A/D, D/A, DPS, etc.) are X301 (48.6 MHz) and X901 (12.288 MHz).

[Regarding the clock of the digital audio system]

The condition of the digital audio system clock differs depending on whether the digital audio interface input is used (external) or not (internal).

The difference between internal (System Setup Input = Analog) and external (System Setup Input = Digital or both, and input is made into Digital IN) is the use of 12,288 MHz or the output of IC901 (Digital Audio Interface Receiver: pin ⑨ MCK (256 fs) of CS8412. This is selected by the EXT/INT of pin ② of IC906 (HC153). (When internal it is L.)

- * Pin ⑨ MCK of IC901 differs according to the sampling frequency of the signal that is input to the digital audio interface. In case of 48 kHz it is 12.288 MHz and in case of 44.1 kHz it is 11.2896 MHz.
- * When the clock source is external, the oscillation of the internal crystal X901 (12.288 MHz) is stopped in order to prevent interference between the clocks.

IC305 (Digital Filter : CXD8482), which is based on this master clock, outputs LRCK (=1fs), which is the sampling frequency for the whole system, from pin ⑤ or 64 fs BCK from pin ④.

IC304 (A/D converter : CXD8493) receives a clock of 128 fs from pin ⑥ of IC305 (Digital Filter : CXD8482) and operates.

The master clock (1024 fs) of IC307 (D/A converter : CXD8505) is generated by the VCO block (Q904, Q905 and IC909, etc.). It uses IC910 (PLL : TC8051AP) from LRCK, which is created by IC305 (Digital Filter : CXD8482), to lock. The 1024 fs clock that is oscillated by VCO becomes the 256 fs output from pin ④ (256 fso) of IC307 (D/A converter : CXD8505), and it is further divided by IC907 and IC908 (Prescaler : HC163) to become 1fs, after which it is fed back to IC910 (PLL : TC8051AP) to form a loop.

The master clock of IC602 and 604 (DSP : CXD2707) is fixed at X301 (48.6 MHz). The master clock of DSP is asynchronous with the sampling frequency, but the processing of the DPS signal is carried out at a LRCK (1fs) cycle.

- * At the time of digital input (clock source = external) the master clock that is input to IC305 (Digital Filter : CXD8482) is changed to 256 fs which is output from pin ⑨ of IC901 (Digital Audio Interface Receiver : CS8412), but all sequences besides that are the same as for the internal operation.

SECTION 4 EXPLANATION OF IC TERMINALS

IC602, 604 CDX2707Q (DSP)

Pin No.	Pin name	I/O	Description
1	EA9	O	External install RAM address. Not used (OPEN)
2	EC0	O	External install RAM address. Not used (OPEN)
3	V _{DD}	–	Power supply. (+5V)
4	V _{SS}	–	Power supply. (GND)
5, 6	EC1 – 2	O	External install RAM address. Not used (OPEN)
7 – 9	EA13 – 15	O	External install RAM address. Not used (OPEN)
10	TST	I	Test data input. “L” : Normal
11	TDR	I	Test data input. “L” : Normal
12	BFOT	O	Master clock buffer output. Not used (OPEN)
13	CLKO	O	Master clock output. Not used (OPEN)
14	CLKI	I	Master clock input.
15	V _{SS}	–	Power supply. (GND)
16	TS0	I	Test data input. “L” : Normal
17	TS1	I	Test data input. “L” : Normal
18	TSA	I	Test data input. “L” : Normal
19	LRK0	I	LRCK input.
20	LRK1	I	LRCK input.
21	BCK0	I	BCK input.
22	BCK1	I	BCK input.
23	BCT	O	Frequency divider BCK output.
24	LCT	I/O	Counter input/frequency divider LRCK output for SYNC DET.
25	SIA	I	Serial data input.
26	SIB	I	Serial data input.
27	SIC	I	Serial data input.
28	V _{DD}	–	Power supply. (+5V)
29	V _{SS}	–	Power supply. (GND)
30	SOA	O	Serial data output.
31	SOB	O	Serial data output.
32	SOC	O	Serial data output.
33	ECJ0	I/O	Terminal input/test data output for conditional jump.
34	ECJ1	I/O	Terminal input/test data output for conditional jump.
35	ECJ2	I/O	Terminal input/test data output for conditional jump. Not used (GND connection)
36	ECJ3	I/O	Terminal input/test data output for conditional jump. Not used (GND connection)
37	REDY	O	HCIF Ready signal output. (Open drain)
38	TRDT	O	HCIF data output.
39	XLAT	I	HCIF data • mode identification signal input.
40	V _{SS}	–	Power supply. (GND)
41	SCK	O	HCIF shift clock output.
42	RVDT	I	HCIF data input.
43	SCL0	O	Test data output. Not used (OPEN)
44	SCL1	O	Test data output. Not used (OPEN)

Pin No.	Pin name	I/O	Description
45	LR0F	O	Test data output. Not used (OPEN)
46	LR1F	O	Test data output. Not used (OPEN)
47	XRST	I	System reset input. (Active “L”)
48	ED0	I/O	External RAM data input/output. Not used (L level)
49	ED16	I/O	External RAM data input/output.
50	ED1	I/O	External RAM data input/output. Not used (L level)
51	ED17	I/O	External RAM data input/output.
52	ED2	I/O	External RAM data input/output. Not used (L level)
53	V _{DD}	–	Power supply. (+5V)
54	V _{SS}	–	Power supply. (GND)
55	ED18	I/O	External RAM data input/output.
56	ED3	I/O	External RAM data input/output. Not used (L level)
57	ED19	I/O	External RAM data input/output.
58	ED4	I/O	External RAM data input/output. Not used (L level)
59	ED20	I/O	External RAM data input/output.
60	ED5	I/O	External RAM data input/output. Not used (L level)
61	ED21	I/O	External RAM data input/output.
62	V _{SS}	–	Power supply. (GND)
63	ED6	I/O	External RAM data input/output. Not used (L level)
64	ED22	I/O	External RAM data input/output.
65	ED7	I/O	External RAM data input/output. Not used (L level)
66	ED23	I/O	External RAM data input/output.
67	ED8	I/O	External RAM data input/output. Not used (L level)
68	ED24	I/O	External RAM data input/output.
69	ED9	I/O	External RAM data input/output. Not used (L level)
70	V _{SS}	–	Power supply. (GND)
71	ED25	I/O	External RAM data input/output.
72	ED10	I/O	External RAM data input/output. Not used (L level)
73	ED26	I/O	External RAM data input/output.
74	ED11	I/O	External RAM data input/output. Not used (L level)
75	ED27	I/O	External RAM data input/output.
76	ED12	I/O	External RAM data input/output. Not used (L level)
77	ED28	I/O	External RAM data input/output.
78	V _{DD}	–	Power supply. (+5V)
79	V _{SS}	–	Power supply. (GND)
80	ED13	I/O	External RAM data input/output. Not used (L level)
81	ED29	I/O	External RAM data input/output.
82	ED14	I/O	External RAM data input/output. Not used (L level)
83	ED30	I/O	External RAM data input/output.
84	ED15	I/O	External RAM data input/output. Not used (L level)
85	ED31	I/O	External RAM data input/output.
86	XOE	O	External RAM OE output.
87	V _{SS}	–	Power supply. (GND)
88	CAS	O	External DRAM CAS output.
89	XWE	O	External RAM WE output.
90	RAS	O	External DRAM CAS/external (P) SRAM CE.
91 – 94	EA0 – 3	O	External RAM address output.
95	V _{SS}	–	Power supply. (GND)
96 – 99	EA4 – 7	O	External RAM address output.
100	EA8	O	External RAM address output. Not used (OPEN)

IC614 HD6413002F10 (MASTER CONTROLER)

Pin No.	Pin name	I/O	Description
1	V _{cc}	–	Power supply. (+5V)
2 – 8	PB0 – PB7	O	Key decoder matrix output.
9	PB7	O	Data enable output to parallel I/O (IC903).
10	$\overline{\text{RESO}}$	O	Reset signal output. (Not used)
11	V _{ss}	–	GND
12	TXD0	O	Serial data output for communications.
13	TXD1	O	Serial data output for communications.
14	RXD0	I	Serial data input for communications.
15	RXD1	I	Serial data input for communications.
16	P94	I	REDY signal input.
17	SCK1	O	Serial data timing clock output.
18	P40 (O)	O	Data I/O select signal output to clock IC (IC613).
19	P41 (I/O)	I/O	Data I/O terminal to clock IC (IC613).
20	P42 (O)	O	Serial data timing clock output.
21	P43 (O)	O	Chip enable output to clock IC (IC613).
22	V _{ss}	–	GND
23	P44 (BYPSS)	O	Bypass relay switch output.
24	P45 (MUTE)	O	Bypass mute switch output.
25	P46 (XRST)	O	Reset output terminal.
26	P47 (AD_PD)	O	Power down mode signal output to A/D converter IC (IC304).
27 – 34	D0 – D7	I/O	Data signal input/output terminal to data bus line.
35	V _{cc}	–	Power supply. (+5V)
36 – 43	A0 – A7	O	Address data output to address bus line.
44	V _{ss}	–	GND
45 – 55	A9 – A18	O	Address data output to address bus line.
56	A19	O	Not used.
57	V _{ss}	–	GND
58	P60 (RELAY MUTE)	O	Initial mute output.
59	P61 (ECJ0_0)	O	Conditional jump output to DSP (IC602).
60	P62 (ECJ0_1)	O	Conditional jump output to DSP (IC604).
61	PHA1	O	System clock output.
62	$\overline{\text{STBY}}$	I	Standby input. (Fixed “H” level)
63	$\overline{\text{RES}}$	I	Reset signal input.
64	NM1	I	Non maskable intrude signal input. (Fixed “L” level)
65	V _{ss}	–	GND

Pin No.	Pin name	I/O	Description
66	EXTAL	O	System clock. (10MHz)
67	XTAL	I	System clock. (10MHz)
68	V _{cc}	–	Power supply.
69	\overline{AS}	O	Not used.
70	\overline{RD}	O	Lead signal output to digital meter (IC605), gate alley (IC606), master program ROM (IC607) and master RAM (IC608, 609)
71	\overline{HWR}	O	Upper rank byte light output to the digital meter (IC605), gate array (IC606), master RAM (IC608, 609).
72	\overline{LWR}	O	Not used.
73	MD0	I	Operation mode select input. (Fixed “H” level)
74	MD1	I	Operation mode select input. (Fixed “H” level)
75	MD2	I	Operation mode select input. (Fixed “L” level)
76	AV _{cc}	–	A/D converter power supply. (+5V)
77	VREF	I	Reference voltage input to A/D converter.
78	AN0	I	Battery input terminal.
79	AN1	I	Error condition input from digital input IC (IC901).
80	AN2	I	FREQ REPORT 0 input from digital input IC (IC901).
81	AN3	I	FREQ REPORT 1 input from digital input IC (IC901).
82	AN4	I	FREQ REPORT 2 input from digital input IC (IC901).
83	AN5	I	ERROR FLAG input from digital input IC (IC901).
84	AN6	I	Padal switch 2 input terminal.
85	AN7	I	Padal switch 1 input terminal.
86	AV _{ss}	–	GND (A/D converter)
87	$\overline{IRQ0}$	I	Interrupt request signal input from LCD controller (IC610).
88	P81	O	Conditional jump output to DSP (IC602).
89	P82	O	Conditional jump output to DSP (IC604).
90	$\overline{CS1}$	O	Address data output to gate alley (IC606).
91	$\overline{CS0}$	O	Chip enable output to EEPROM (IC607).
92	V _{ss}	–	GND
93	PA0	O	LCD data output.
94	PA1	O	LCD data output.
95	PA2	O	LCD data output.
96	PA3	O	Clock change signal output.
97	PA4	O	LCD data output.
98	PA5	O	Latch output to D/A converter.
99	PA6	O	MIDI THRU/OUT change signal output.
100	A20	O	Not used.

SECTION 5
DIAGRAMS

5-1. BLOCK DIAGRAM

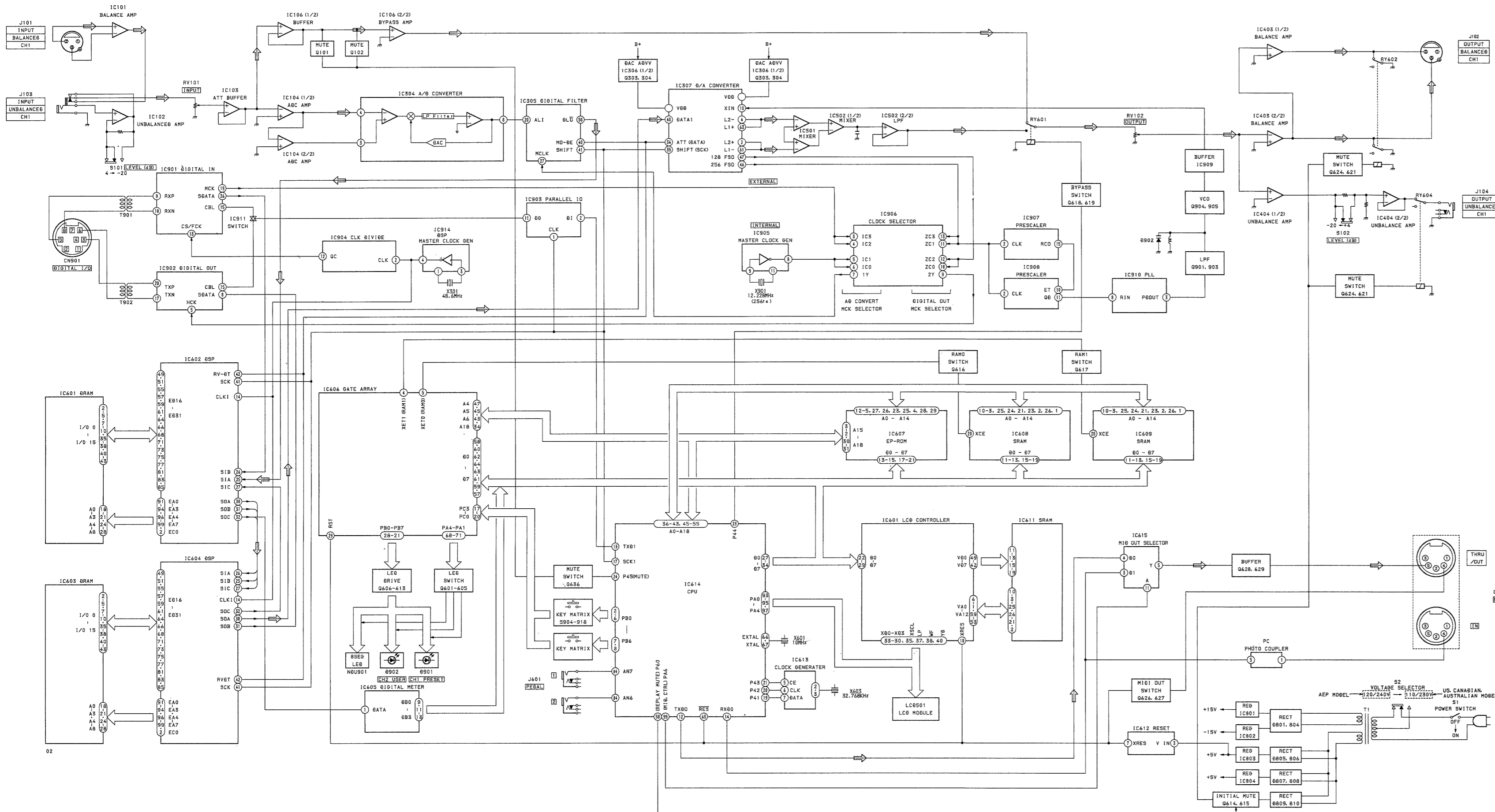

● CIRCUIT BOARD LOCATION

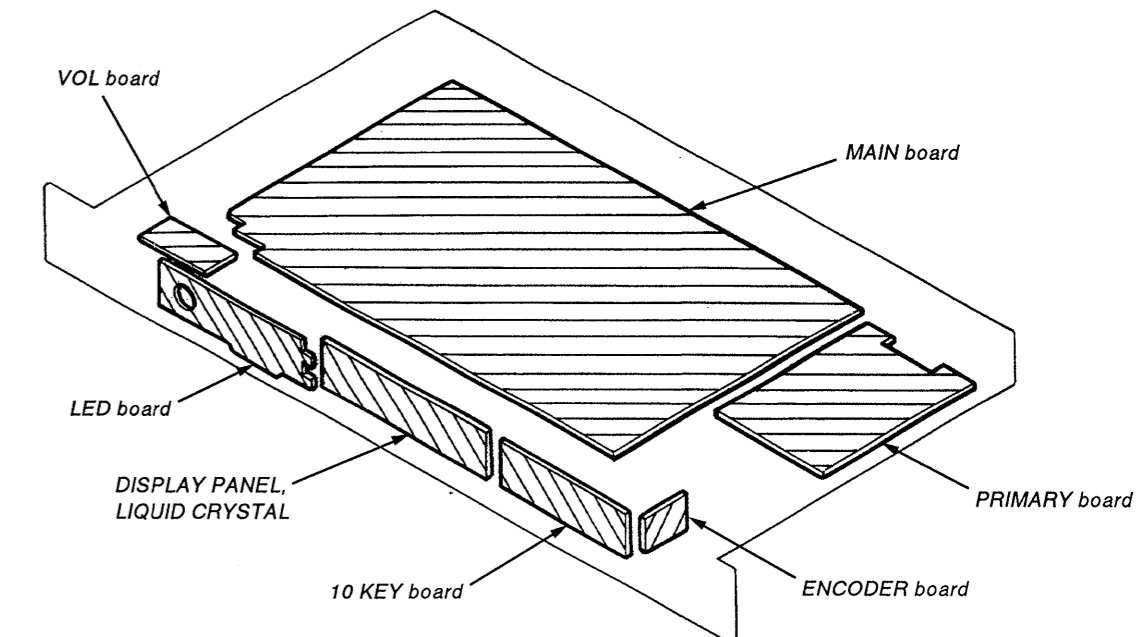

5-2. PRINTED WIRING BOARDS

● SEMICONDUCTOR LOCATION

Ref. No.	Location	Ref. No.	Location	Ref. No.	Location
D301	H-3	IC106	E-2	Q101	E-2
D302	H-4	IC107	E-3	Q102	E-2
D801	B-12	IC301	G-11	Q201	E-2
D802	D-5	IC302	G-10	Q202	E-2
D803	C-8	IC303	I-10	Q301	I-4
D604	C-8	IC304	H-2	Q302	I-4
D605	C-6	IC305	I-2	Q303	H-4
D606	C-12	IC306	H-4	Q304	H-4
D607	C-11	IC307	G-5	Q801	H-9
D801	F-15	IC401	F-5	Q802	H-9
D802	F-15	IC402	E-5	Q803	H-9
D803	F-15	IC403	D-8	Q804	H-10
D804	F-15	IC404	B-7	Q805	H-10
D805	I-16	IC501	F-6	Q806	J-7
D806	I-16	IC502	E-6	Q807	J-7
D807	I-16	IC503	D-8	Q808	J-7
D808	I-16	IC504	B-7	Q809	J-8
D809	H-13	IC601	J-4	Q810	J-8
D810	I-13	IC602	J-5	Q811	J-8
D811	H-13	IC603	J-6	Q812	J-8
D812	H-13	IC604	I-6	Q813	J-8
D813	G-13	IC605	I-21	Q814	H-13
D901	F-9	IC606	H-11	Q815	H-13
	(LED BOARD)	IC607	G-2	Q816	D-13
	(MAIN BOARD)	IC608	F-11	Q817	D-14
D902	F-7	IC609	E-11	Q818	D-5
	(LED BOARD)	IC610	I-9	Q819	D-5
	(MAIN BOARD)	IC611	I-9	Q820	C-9
	(MAIN BOARD)	IC612	C-13	Q821	C-9
	(MAIN BOARD)	IC613	D-10	Q822	C-9
D903	J-37	IC814	D-11	Q823	C-9
D904	J-36	IC815	C-13	Q824	C-9
D905	K-36	IC816	C-9	Q825	C-9
D906	J-36	IC817	D-9	Q826	B-13
D907	J-36	IC818	H-16	Q827	B-13
D908	K-36	IC819	J-16	Q828	B-14
D909	J-35	IC820	D-9	Q829	B-14
D910	J-35	IC821	D-8	Q830	G-10
D911	K-35	IC822	E-9	Q901	F-8
D912	J-35	IC823	J-2	Q902	F-8
D913	J-35	IC824	F-9	Q903	G-8
D914	K-35	IC825	F-8	Q904	F-7
D915	J-34	IC826	E-8	Q905	G-7
D916	J-34	IC827	F-8		
D917	K-34	IC828	G-7		
IC101	C-1	IC910	H-5		
IC102	B-3	IC911	D-9		
IC103	E-2	IC912	G-9		
IC104	F-2	IC913	J-3		
IC105	F-3	IC914	J-3		

Note:
 • ○ : Through hole.
 • [Pattern] : Pattern from the side which enables seeing.
 (The other layers' patterns are not indicated)

Caution:
 Pattern face side : Parts on the pattern face side seen from (Conductor Side) the pattern face are indicated.
 Parts face side : Parts on the parts face side seen from the (Component side) parts face are indicated.

• Abbreviation
 CND : Canadian
 AUS : Australian

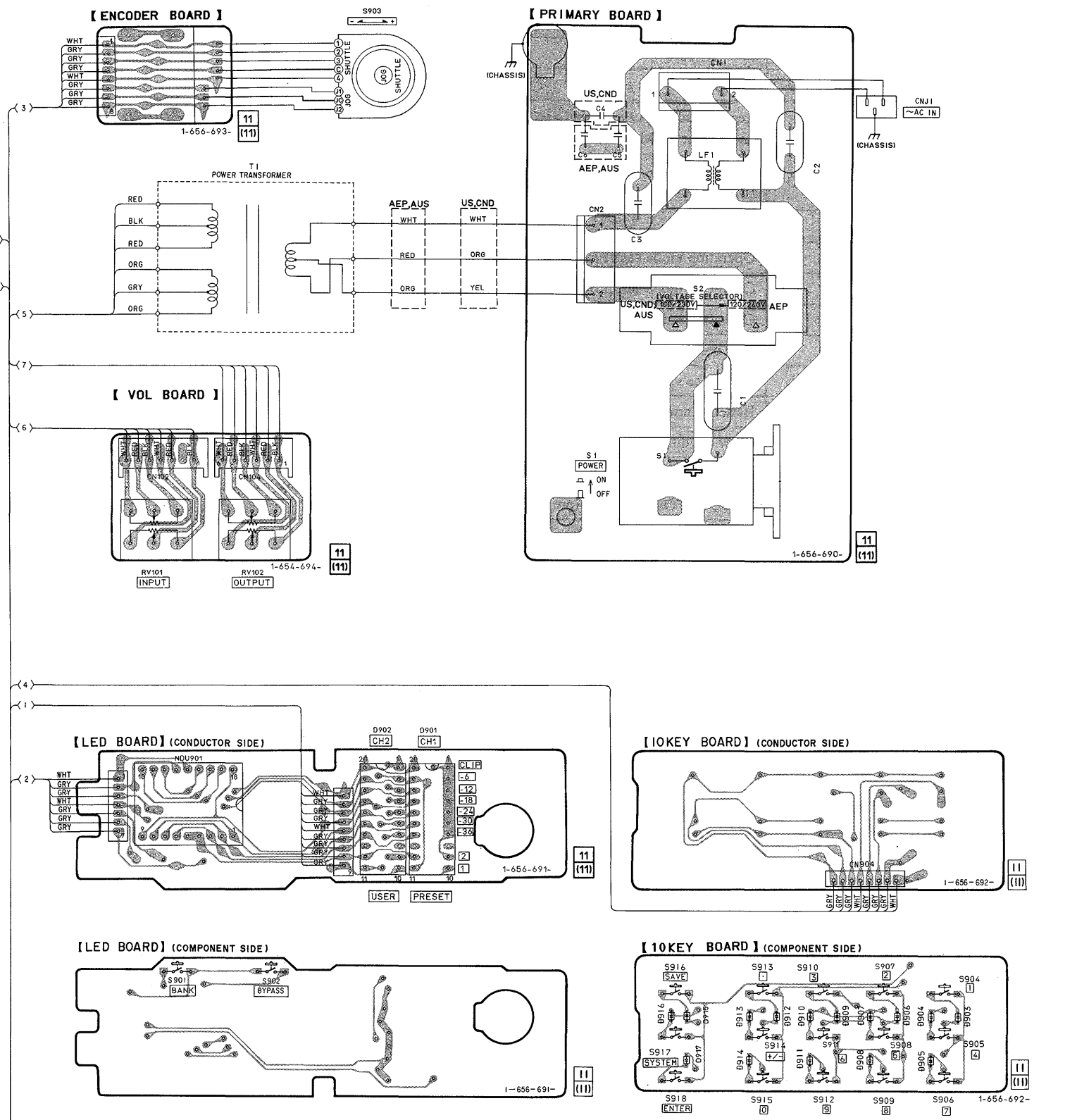
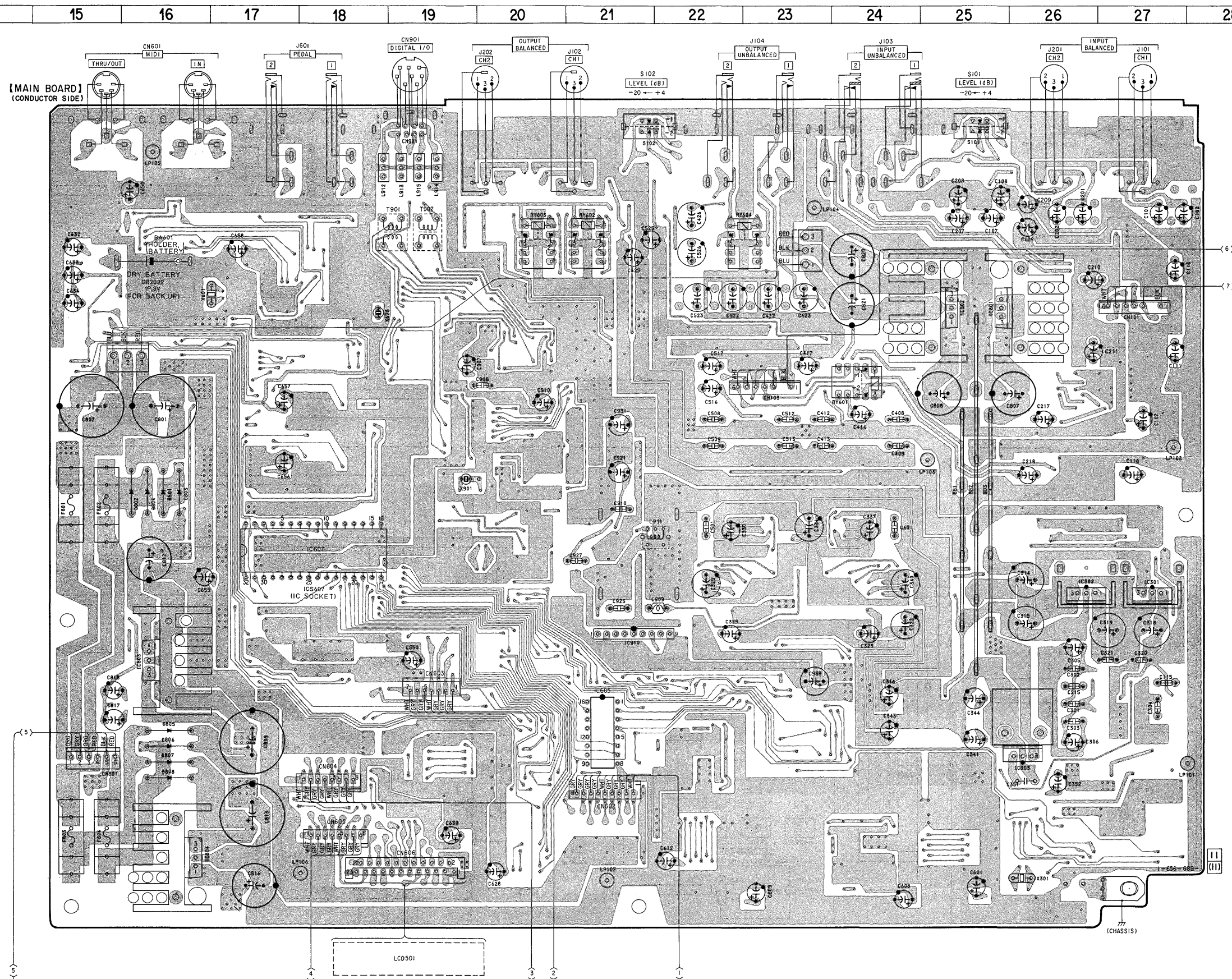
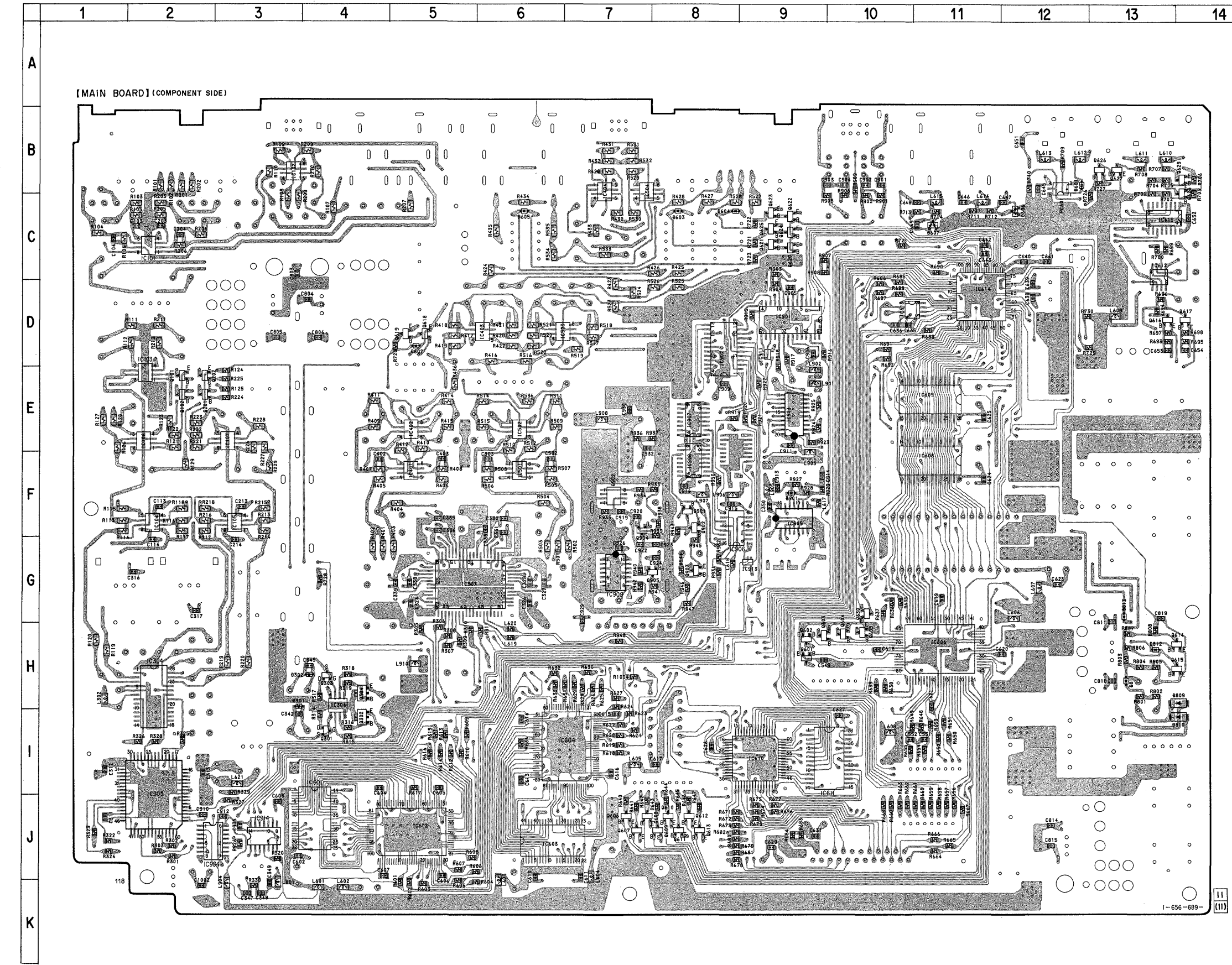

• WAVEFORMS

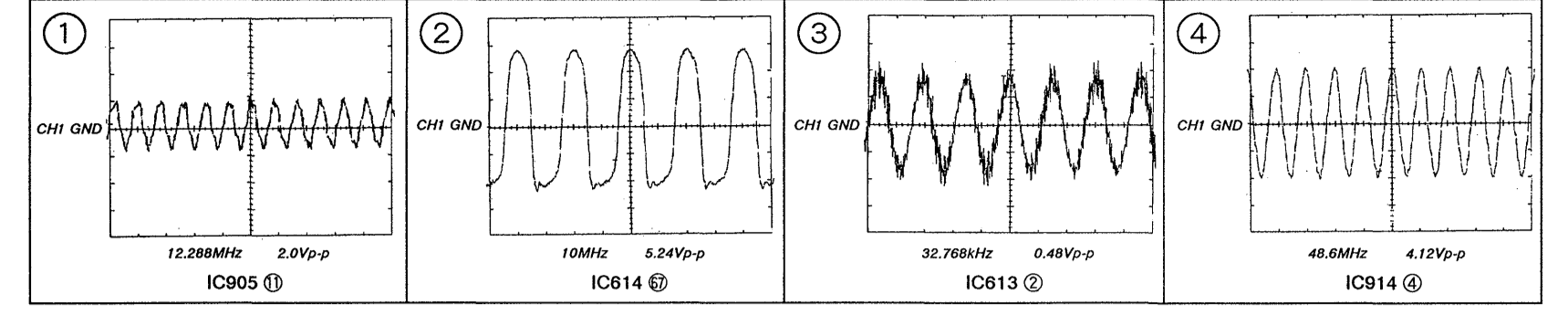

- Note:**
- All capacitors are in μ F unless otherwise noted; pF: μ μ F
 - 50WV or less are not indicated except for electrolytics and tantalums.
 - All resistors are in Ω and $\frac{1}{2}W$ or less unless otherwise specified.
 - Waveforms are taken with an oscilloscope.
 - Voltage variations may be noted due to normal production tolerances.
 - Δ : Internal component.
 - **B+** : B+ Line
 - **B-** : B- Line
 - Voltage and waveforms are dc with respect to ground under no-signal (detuned) conditions.
 - Voltages are taken with a VOM (Input impedance 10M Ω). Voltage variations may be noted due to normal production tolerances.

5-3. SCHEMATIC DIAGRAM (1/2) • Refer to page 43 for IC Block Diagrams.

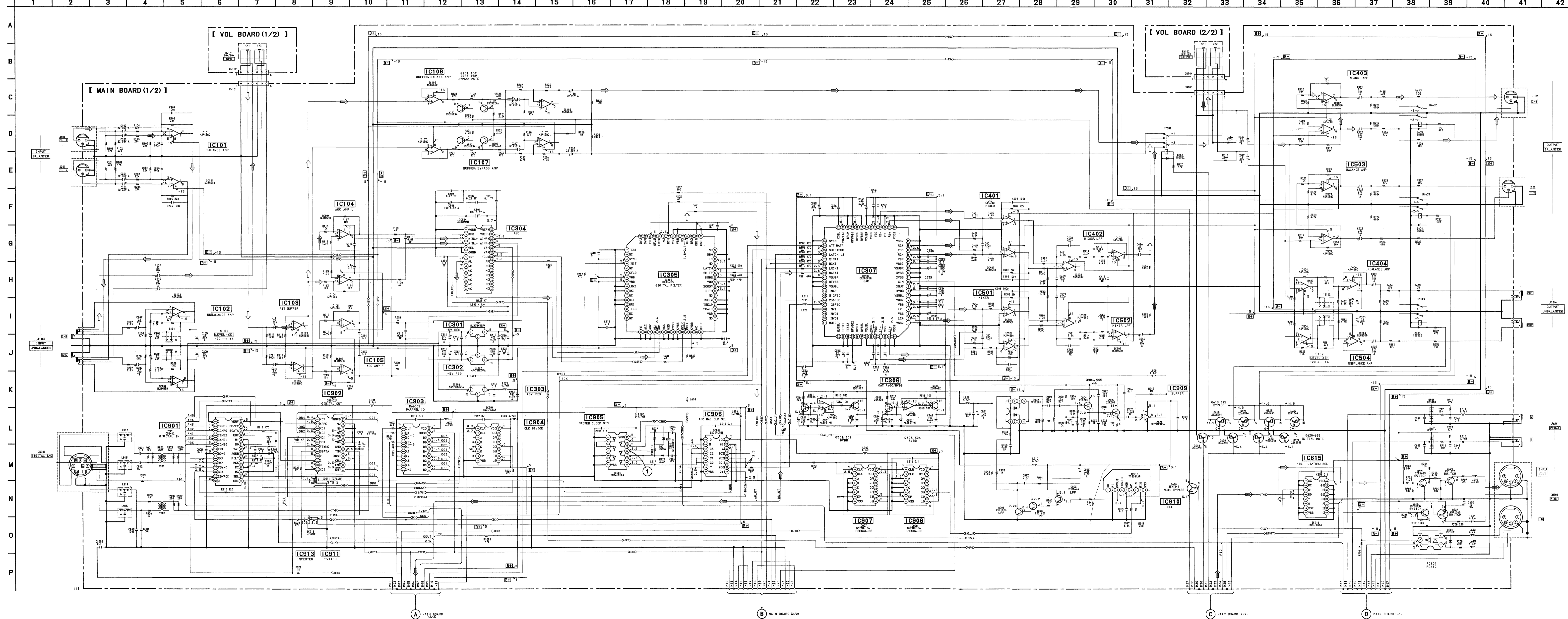

Note :

- All capacitors are in μ F unless otherwise noted. pF: μ μ F 50WV or less are not indicated except for electrolytics and tantalums.
- All resistors are in Ω and $\text{k}\Omega$ or less unless otherwise specified.

- [B+]** : B+ Line
- [B-]** : B- Line

- Abbreviation CND : Canadian AUS : Australian

Note :
The components identified by mark Δ or ∇ are critical for safety. Ne les remplacer que par une pièce portant le numéro spécifié.

Note :
Les composants identifiés par une marque Δ sont critiques pour la sécurité. Ne les remplacer que par une pièce portant le numéro spécifié.

- Voltage and waveforms are dc with respect to ground under no-signal (detuned) conditions.
- Waveforms are taken with a VOM (Input impedance 10M Ω). Voltage variations may be noted due to normal production tolerances.
- Waveforms are taken with a oscilloscope. Voltage variations may be noted due to normal production tolerances.
- Circled numbers refer to waveforms.

5-4. SCHEMATIC DIAGRAM (2/2) Refer to page 35 for Waveforms. Refer to page 43 for IC Block Diagrams.

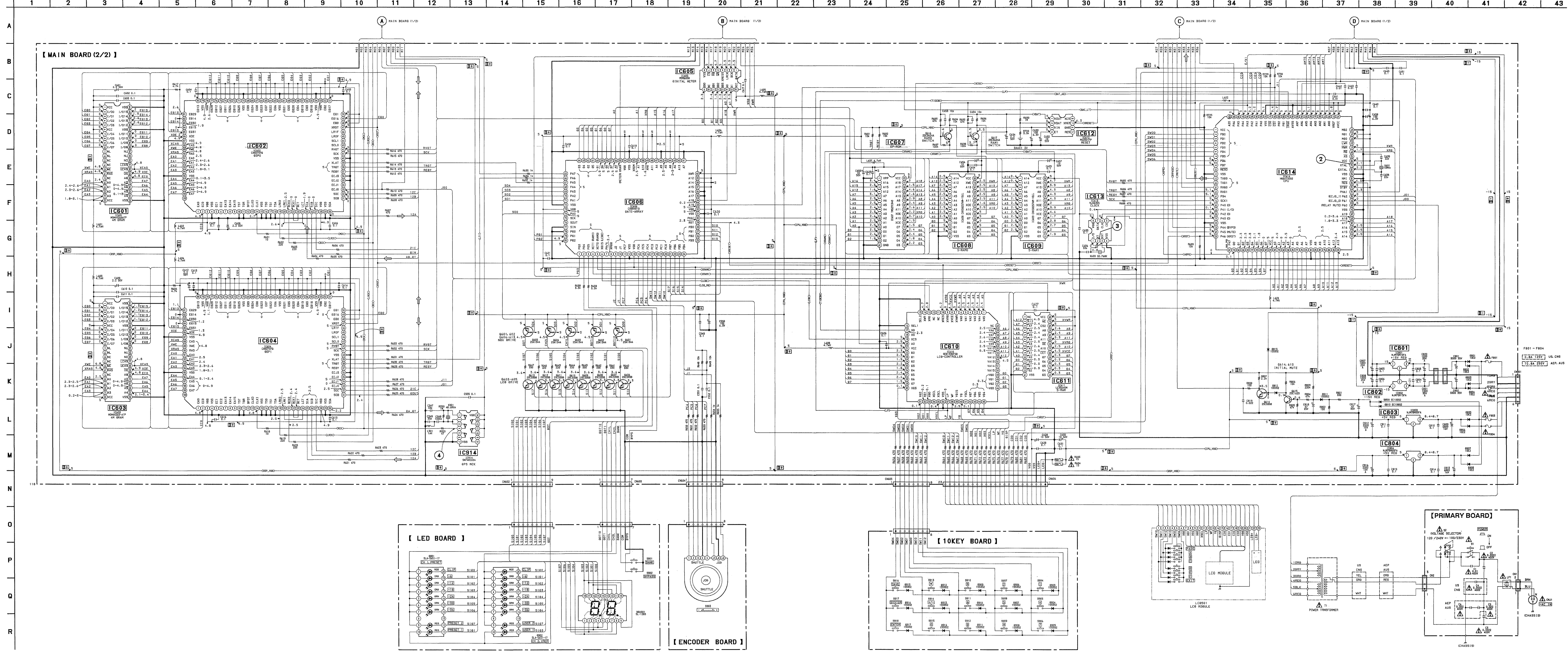

ICBLOCK DIAGRAMS

IC304 CXD8493M-E1

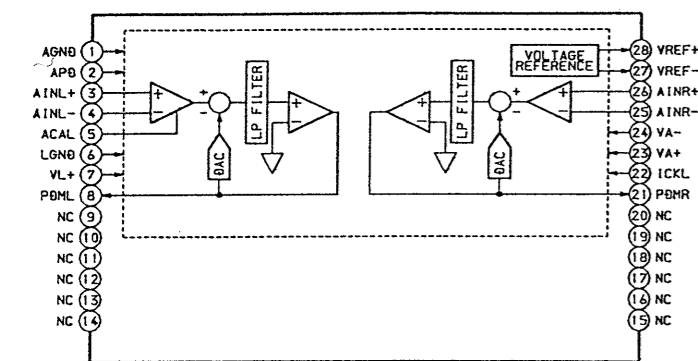

IC612 M62021FP-600C

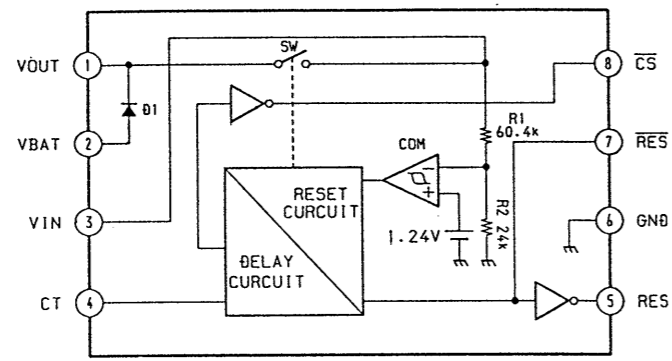

IC601, 603 M5M44260ATP-7L

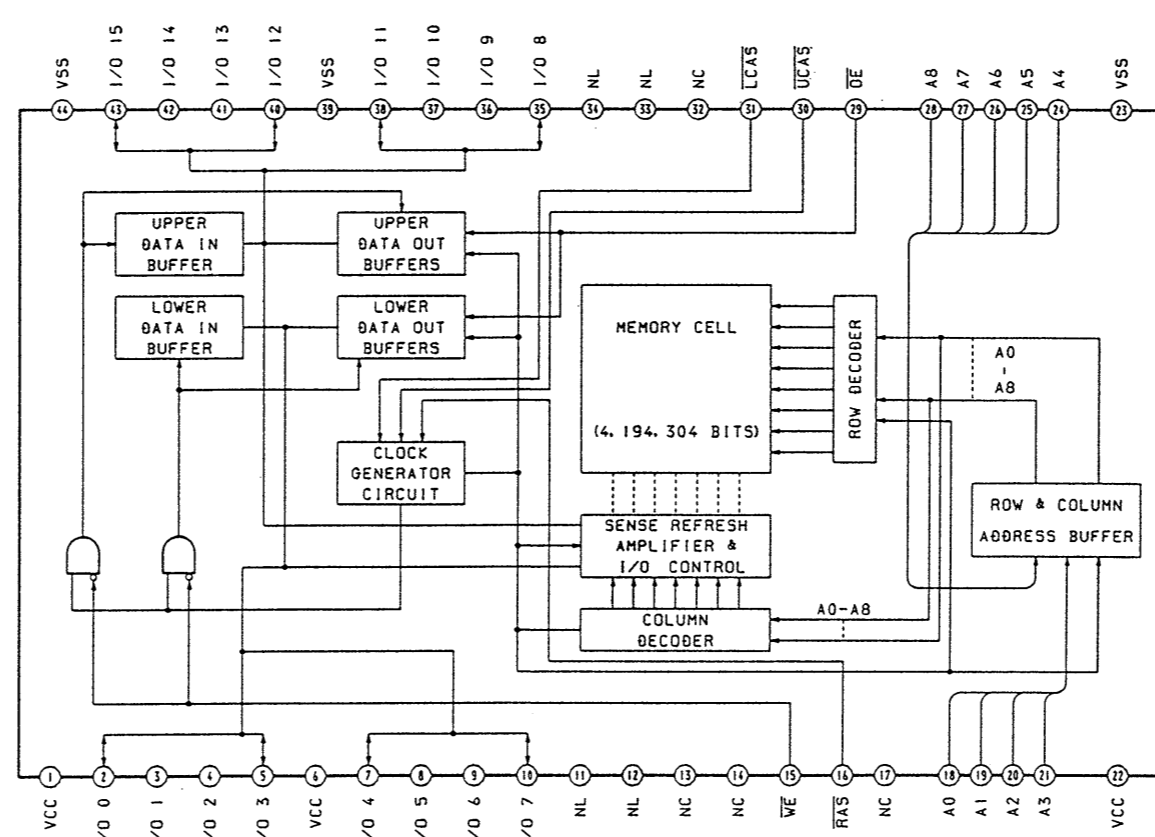

IC606 CXD8481Q

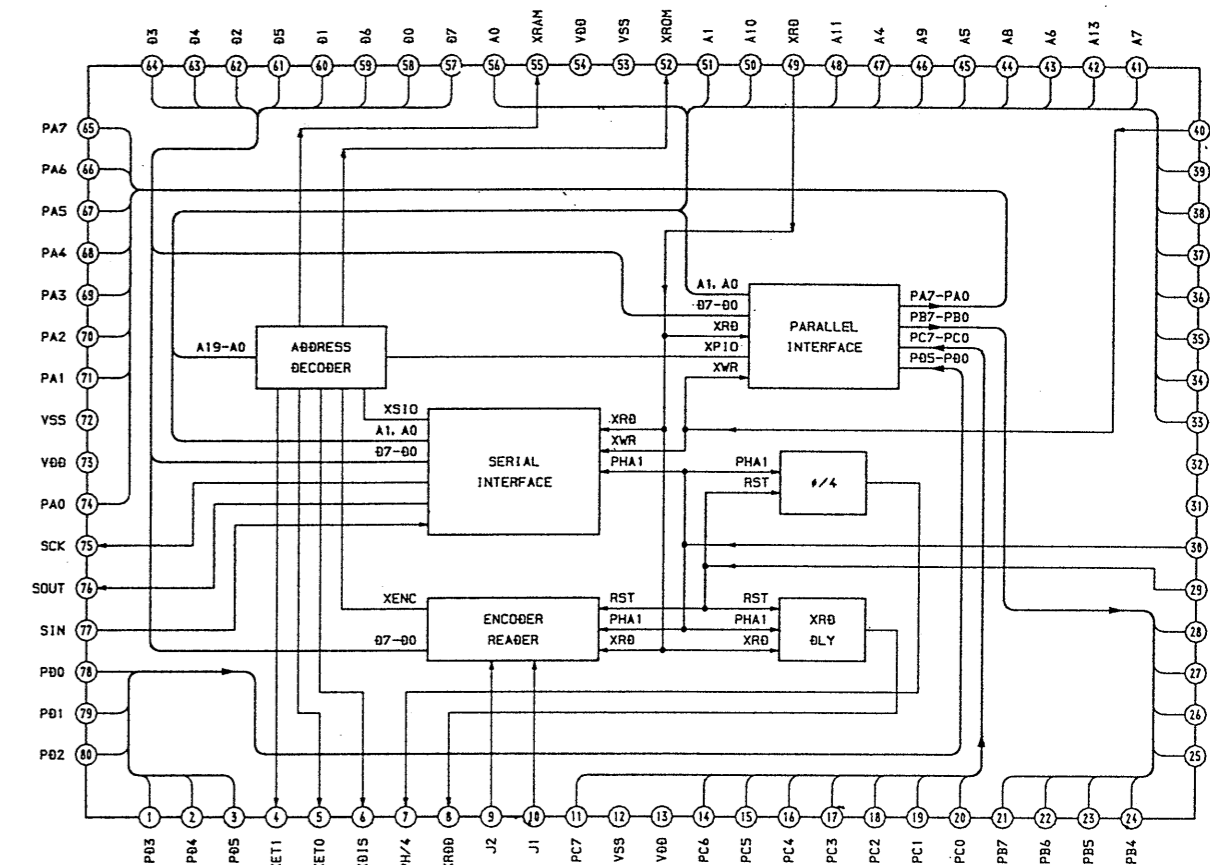

IC307 CXD8505AQ

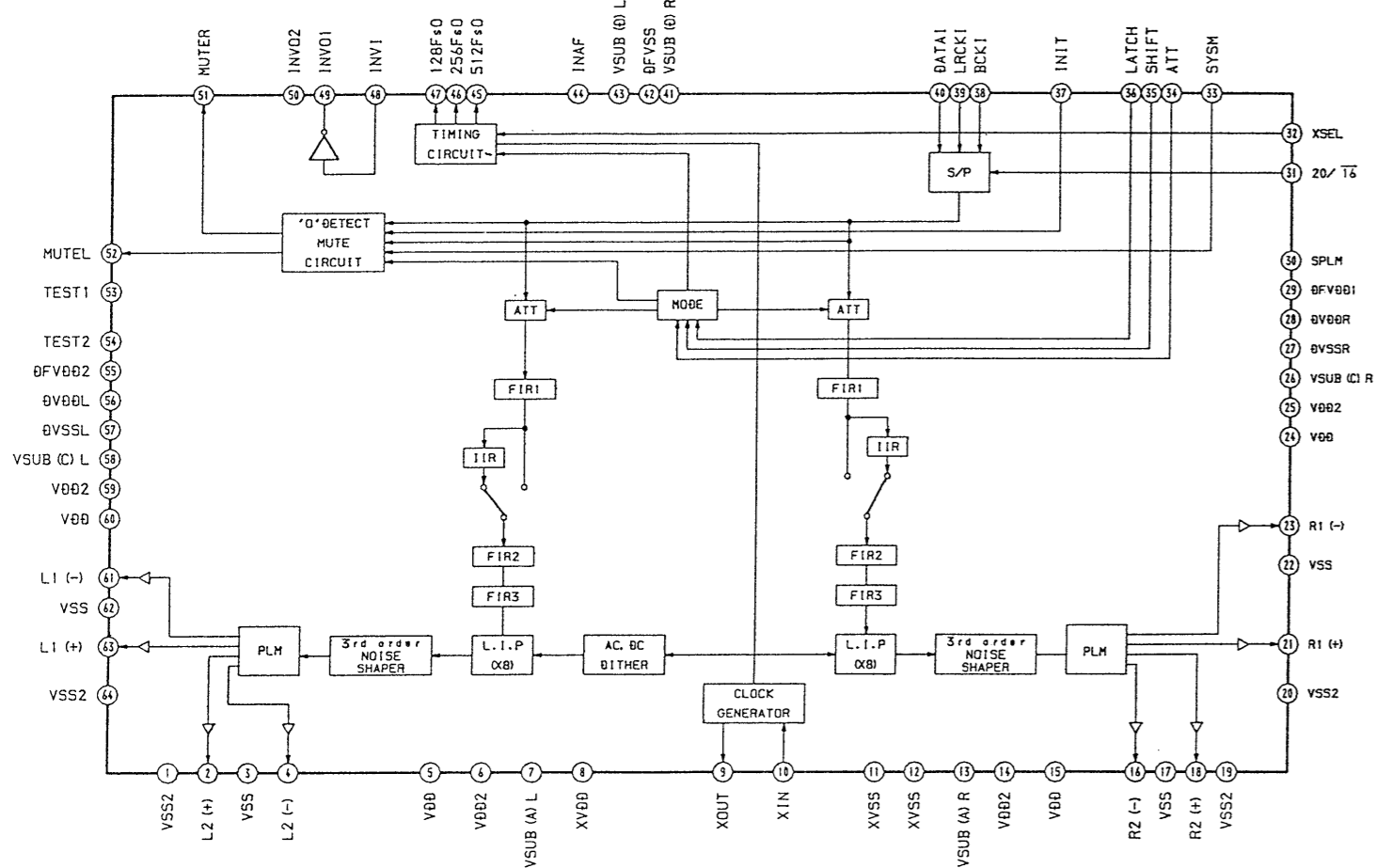

IC605 MSM6338RS

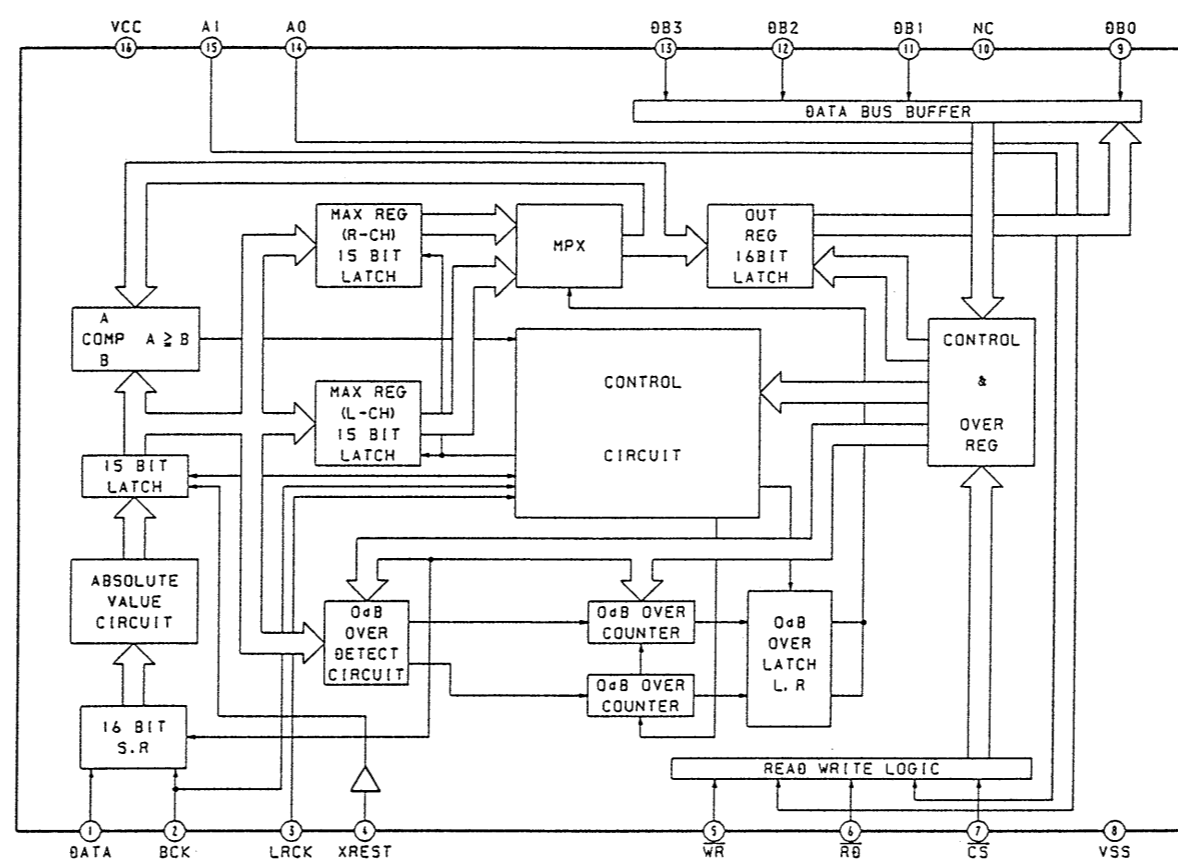

IC608, 609 CXK58257AM-10LL-T6

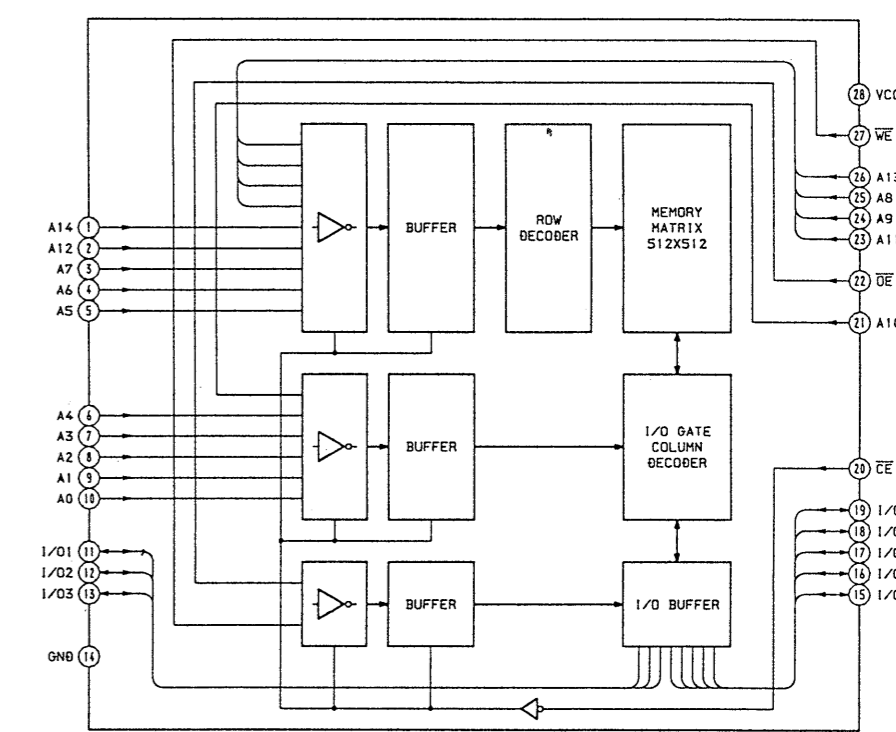

IC613 NJU6355EM-T1

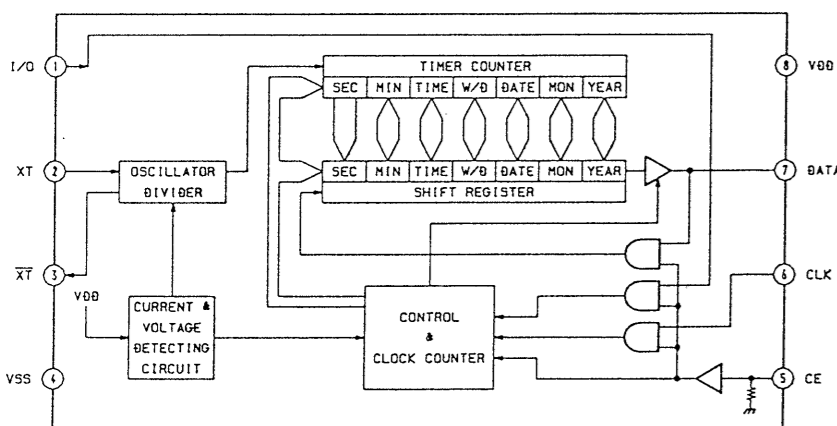

IC615 SN74HC151ANS-E20

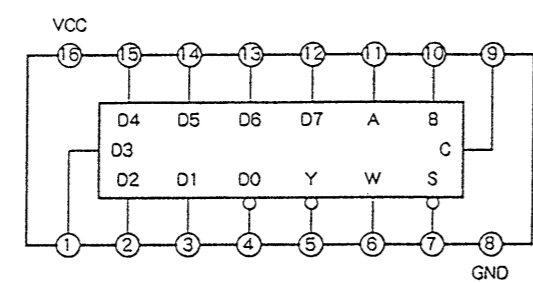

IC610 SED1335F0B

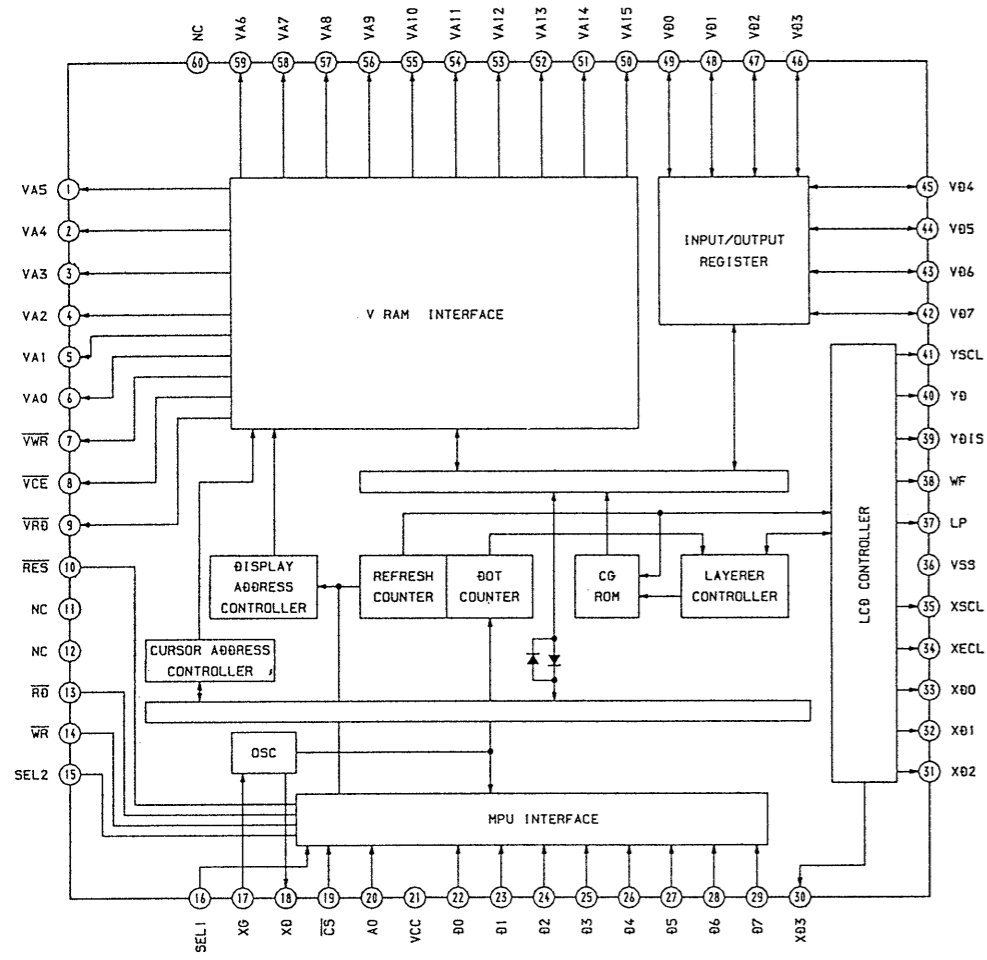

IC611 LC3564SM-10-TRM

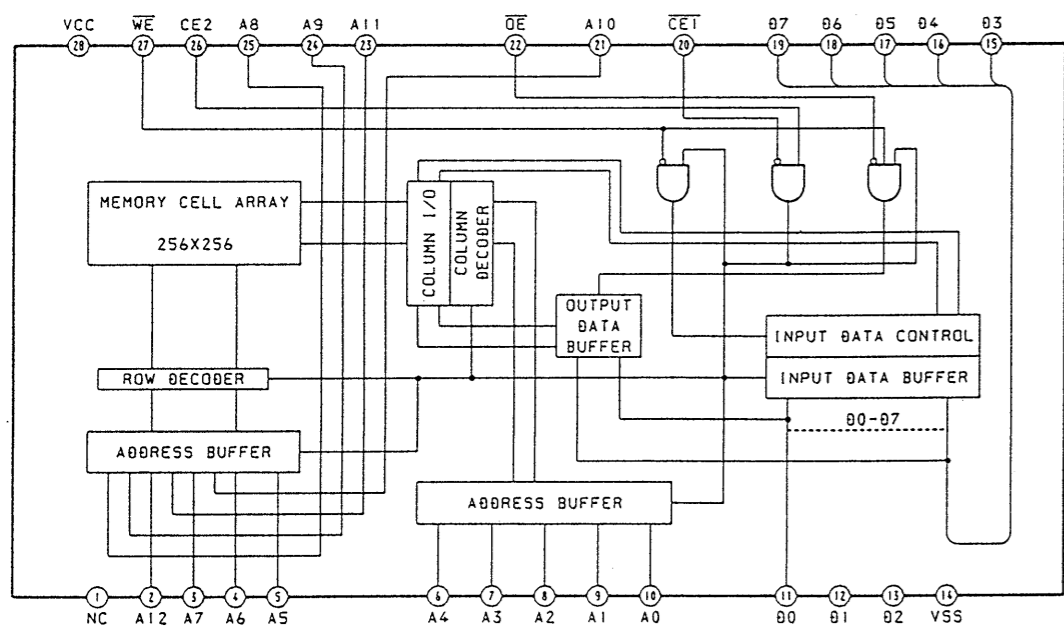

IC901 CS8412-CS

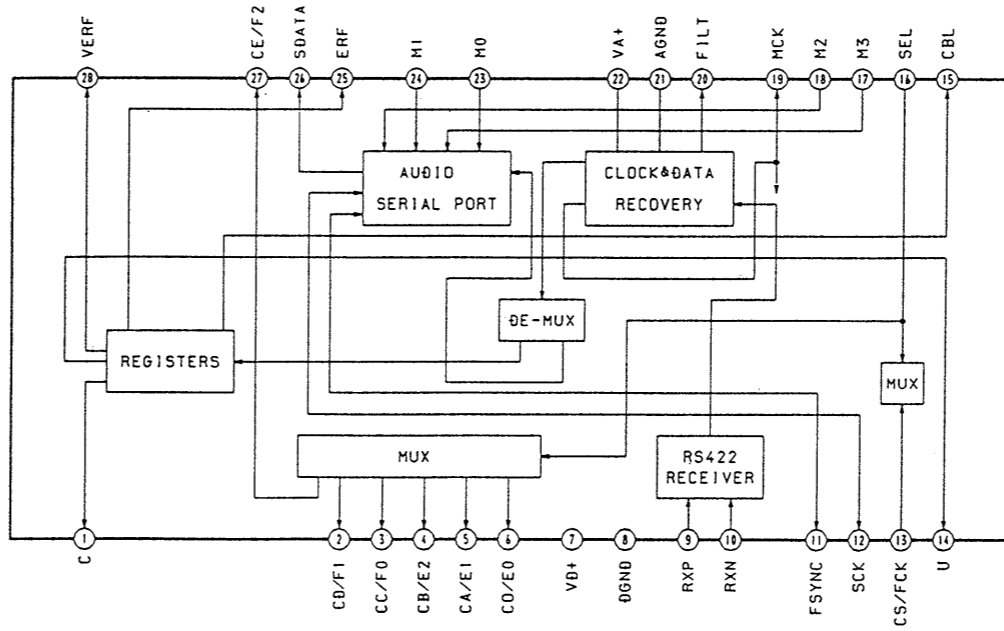

IC903 M66009FP

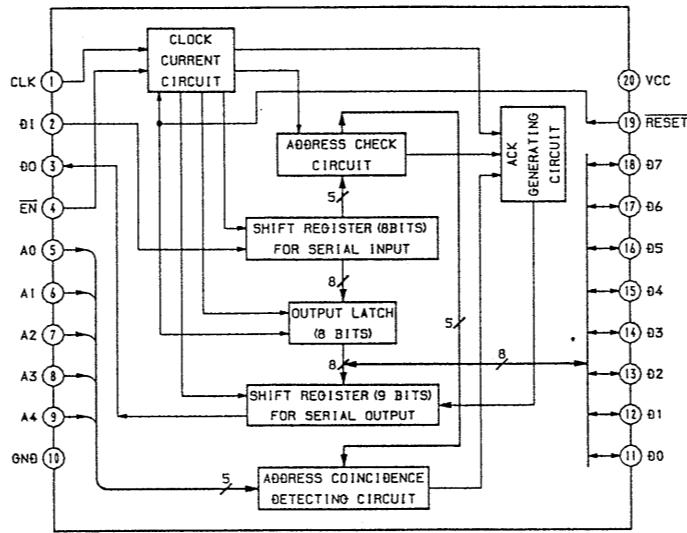

IC910 TC5081AP

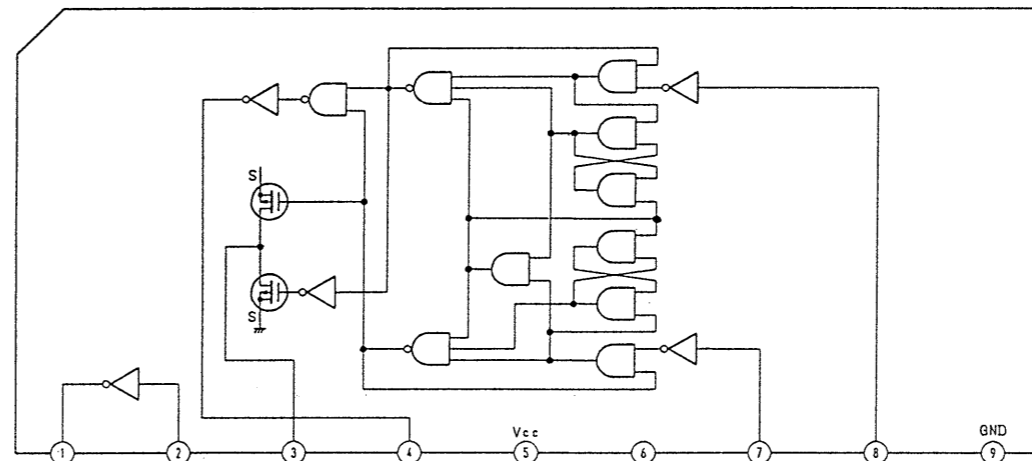

IC905 SN74HC04ANS-E20

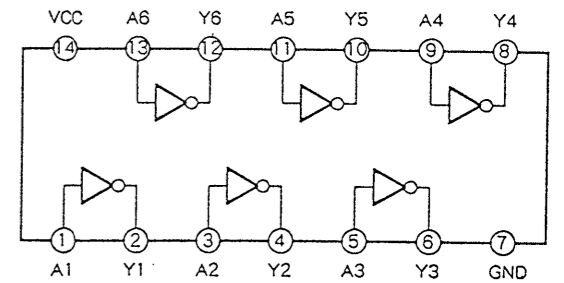

IC906 SN74HC153ANS

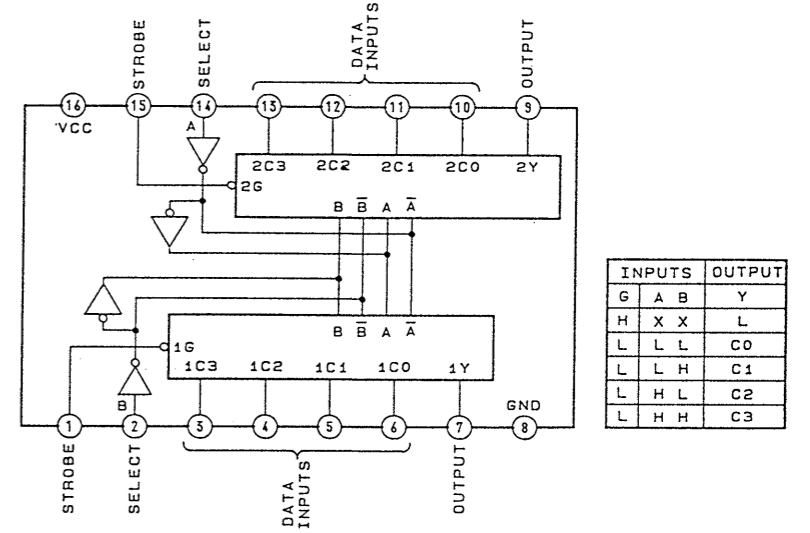



SECTION 6 EXPLODED VIEWS

NOTE :

- -XX, -X mean standardized parts, so they may have some difference from the original one.
- The construction parts of an assembled part are indicated with a collation number in the remark column.

- Items marked “ * ” are not stocked since they are seldom required for routine service. Some delay should be anticipated when ordering these items.
- The mechanical parts with no reference number in the exploded views are not supplied.
- Hardware (# mark) list and accessories and packing materials are given in the last of this parts list.

The components identified by mark  or dotted line with mark  are critical for safety. Replace only with part number specified.

Les composants identifiés par une marque  sont critiques pour la sécurité. Ne les remplacer que par une pièce portant le numéro spécifié.

6-1. FRONT PANEL SECTION

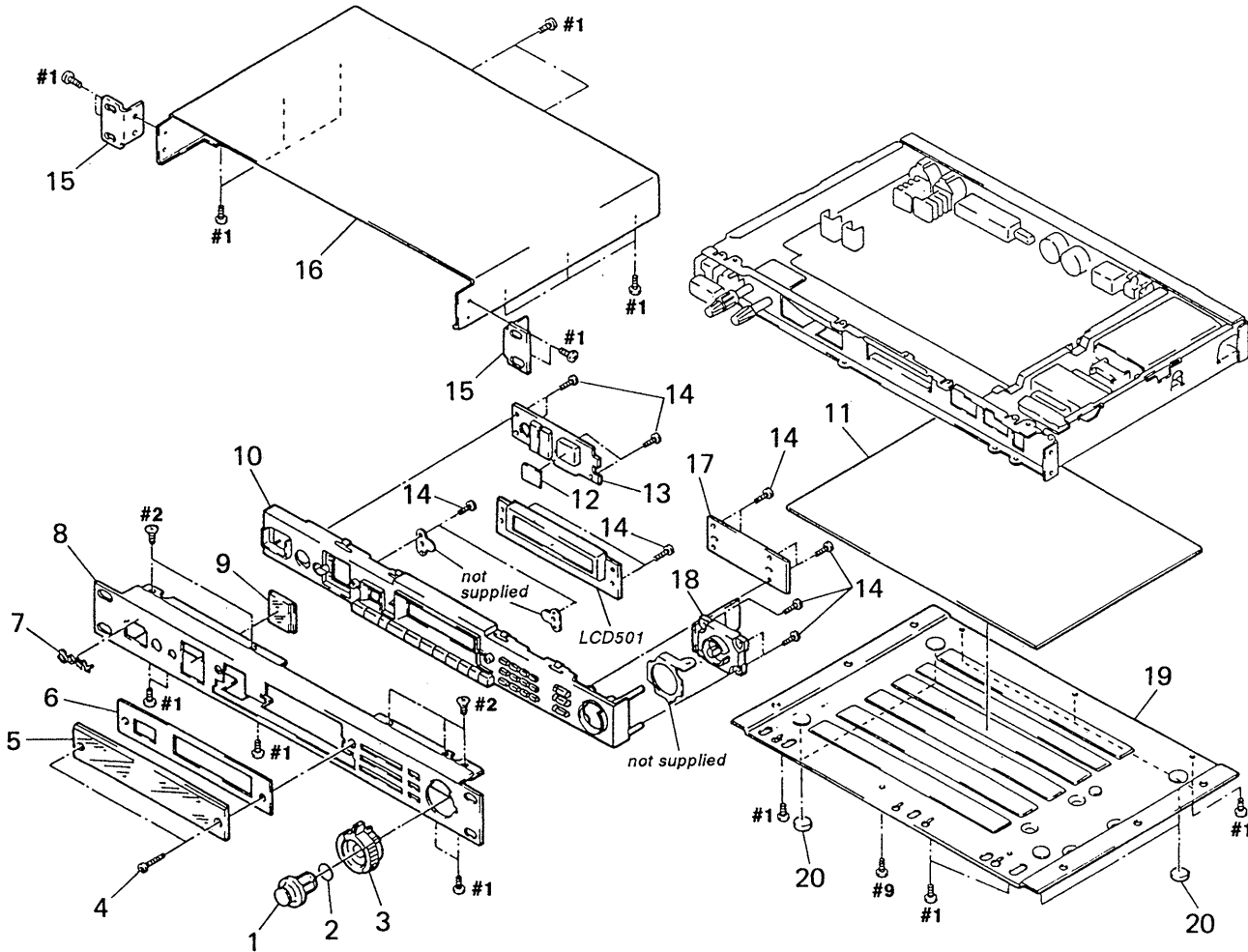

Ref. No.	Part No.	Description	Remark	Ref. No.	Part No.	Description	Remark
1	4-973-987-01	KNOB (B)		12	4-973-990-01	FILTER	
2	4-973-995-02	STOPPER (B)		* 13	1-656-691-11	LED BOARD	
3	4-973-986-01	KNOB (A)		14	4-951-620-01	SCREW (2.6×8), +BVTP	
4	4-961-104-01	BOLT, HEXAGON SOCKET		* 15	4-916-305-01	REINFORCEMENT	
5	4-973-988-01	PLATE (A), INDICATION		16	4-916-342-32	CASE	
6	4-973-991-01	PLATE, ORNAMENTAL		* 17	1-656-692-11	10 KEY BOARD	
7	4-969-961-01	EMBLEM (NO. 4), SONY		* 18	1-656-693-11	ENCODER BOARD	
8	4-973-985-01	PANEL, FRONT		* 19	4-916-320-11	PLATE, BOTTOM	
9	4-973-989-01	PLATE (B), INDICATION		* 20	4-907-980-01	FOOT	
10	X-4946-025-1	BASE ASSY, PANEL		LCD501	1-810-771-11	DISPLAY PANEL, LIQUID CRYSTAL	
* 11	4-916-327-01	SHEET, INSULATING					

6-2. CHASSIS SECTION

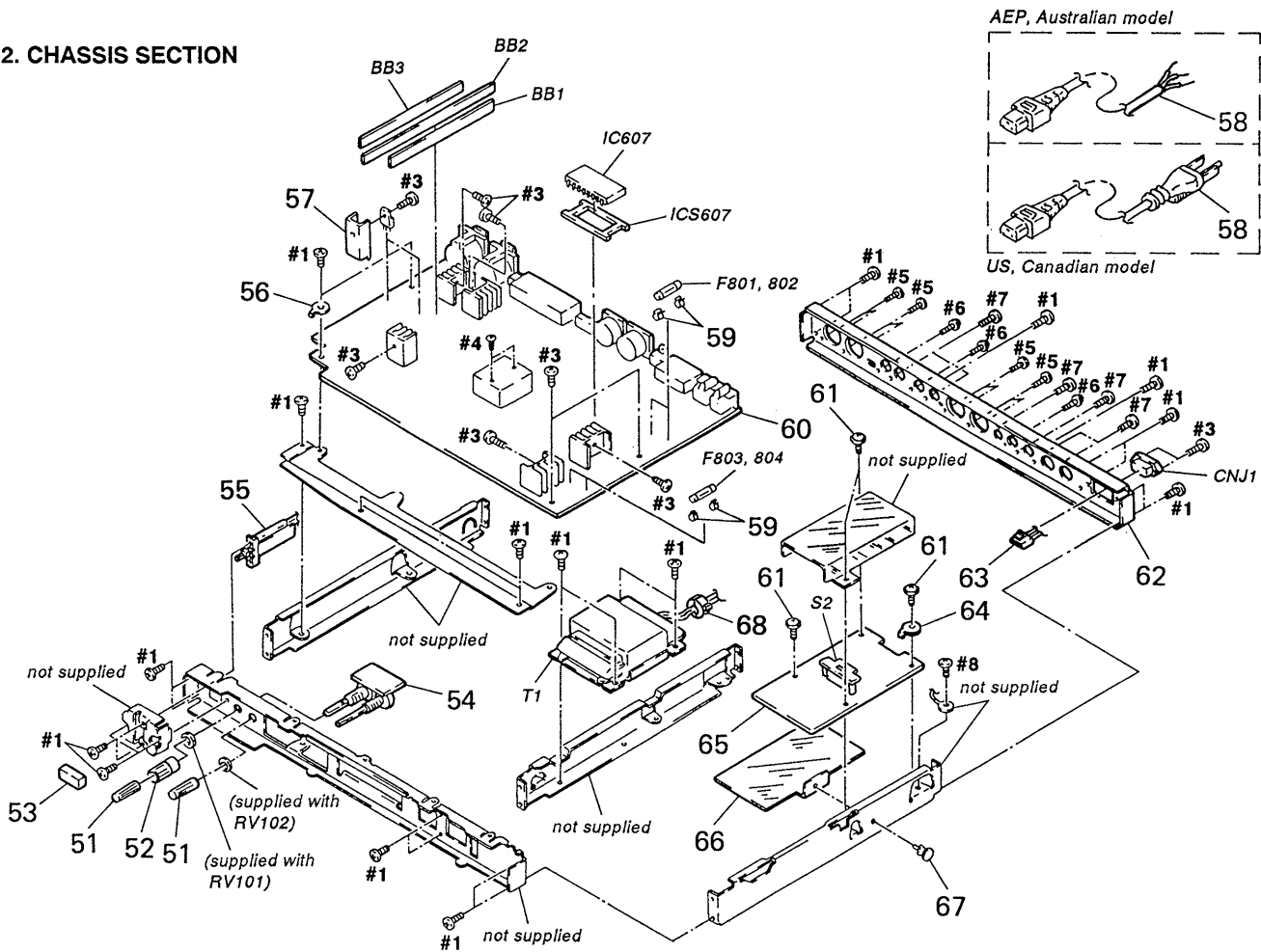

The components identified by mark \triangle or dotted line with mark \triangle are critical for safety. Replace only with part number specified.

Les composants identifiés par une marque \triangle sont critiques pour la sécurité. Ne les remplacer que par une pièce portant le numéro spécifié.

Ref. No.	Part No.	Description	Remark	Ref. No.	Part No.	Description	Remark
51	4-941-142-01	KNOB (A)		* BB3	1-580-302-11	BAR, BUS 4P	
52	4-941-136-01	KNOB (B)		\triangle CNJ1	1-580-375-21	INLET 3P (AC IN~)	
53	4-922-921-21	BUTTON (POWER)		\triangle F801	1-532-215-00	FUSE, TIME-LAG (T0. 8A 250V)	(AEP, Australian)
* 54	1-656-694-11	VOL BOARD		\triangle F801	1-532-739-11	FUSE, GLASS TUBE (0. 8A 125V)	(US, Canadian)
\triangle 55	1-762-363-11	SWITCH, POWER (POWER)		\triangle F802	1-532-215-00	FUSE, TIME-LAG (T0. 8A 250V)	(AEP, Australian)
56	1-537-770-21	TERMINAL BOARD, GROUND		\triangle F802	1-532-739-11	FUSE, GLASS TUBE (0. 8A 125V)	(US, Canadian)
* 57	4-875-327-01	HEAT SINK		\triangle F803	1-532-215-00	FUSE, TIME-LAG (T0. 8A 250V)	(AEP, Australian)
\triangle 58	1-551-812-11	CORD, POWER (US, Canadian)		\triangle F803	1-532-739-11	FUSE, GLASS TUBE (0. 8A 125V)	(US, Canadian)
\triangle 58	1-590-910-11	CORD SET, POWER (AEP, Australian)		\triangle F804	1-532-215-00	FUSE, TIME-LAG (T0. 8A 250V)	(AEP, Australian)
59	1-533-293-11	FUSE HOLDER		\triangle F804	1-532-739-11	FUSE, GLASS TUBE (0. 8A 125V)	(US, Canadian)
* 60	A-4377-982-A	MAIN BOARD, COMPLETE		IC607	8-759-350-85	IC TMS27C040-V77-E1	
61	4-886-821-01	SCREW, S TIGHT, +PTTWH 3x6		ICS607	1-540-107-11	SOCKET, IC 32P	
* 62	4-973-996-01	PANEL, BACK		\triangle S2	1-570-173-11	SELECTOR, POWER VOLTAGE	(VOLTAGE SELECTOR)
* 63	1-690-057-11	LEAD (WITH CONNECTOR) (2 CORE)		\triangle T1	1-429-097-11	TRANSFORMER, POWER (US, Canadian)	
* 64	4-870-539-00	PLATE, GROUND		\triangle T1	1-429-098-11	TRANSFORMER, POWER (AEP, Australian)	
* 65	1-656-690-11	PRIMARY BOARD					
* 66	4-916-303-01	SHEET, INSULATING					
* 67	3-531-576-51	RIVET					
68	1-500-278-11	FILTER, CLAMP (FERRITE CORE)	(US, Canadian)				
* BB1	1-580-302-11	BAR, BUS 4P					
* BB2	1-566-940-11	BUS BAR 6P					

SECTION 7 ELECTRICAL PARTS LIST

10 KEY

ENCODER

LED

MAIN

NOTE :

- Due to standardization, replacements in the parts list may be different from the parts specified in the diagrams or the components used on the set.
- -XX, -X mean standardized parts, so they may have some difference from the original one.
- RESISTORS
All resistors are in ohms
METAL : Metal-film resistor
METAL OXIDE : Metal oxide-film resistor
F : nonflammable

- Items marked " * " are not stocked since they are seldom required for routine service. Some delay should be anticipated when ordering these items.
- SEMICONDUCTORS
In each case, u : μ , for example :
uA..... : μ A....., uPA..... : μ PA.....
uPB..... : μ PB....., uPC..... : μ PC.....
uPD..... : μ PD.....
- CAPACITORS
uF : μ F
- COILS
uH : μ H

The components identified by mark Δ or dotted line with mark Δ are critical for safety. Replace only with part number specified.

Les composants identifiés par une marque Δ sont critiques pour la sécurité. Ne les remplacer que par une pièce portant le numéro spécifié.

When indicating parts by reference number, please include the board.

Ref. No.	Part No.	Description	Remark	Ref. No.	Part No.	Description	Remark
*	1-656-692-11	10 KEY BOARD *****				< SWITCH >	
		< DIODE >		S901	1-762-400-11	SWITCH (BANK)	
				S902	1-762-400-11	SWITCH (BYPASS)	

D903-917				*	A-4377-982-A	MAIN BOARD, COMPLETE *****	
	8-719-016-74	DIODE 1SS352				1-537-770-21	TERMINAL BOARD, GROUND
		< SWITCH >				1-533-293-11	FUSE HOLDER
S904	1-762-400-11	SWITCH (1)				< BATTERY HOLDER >	
S905	1-762-400-11	SWITCH (4)		BA601	1-550-414-21	HOLDER, BATTERY	
S906	1-762-400-11	SWITCH (7)				< BUS BAR >	
S907	1-762-400-11	SWITCH (2)		* BB1	1-580-302-11	BAR, BUS 4P	
S908	1-762-400-11	SWITCH (5)		* BB2	1-566-940-11	BUS BAR 6P	
S909	1-762-400-11	SWITCH (8)		* BB3	1-580-302-11	BAR, BUS 4P	
S910	1-762-400-11	SWITCH (3)				< CAPACITOR >	
S911	1-762-400-11	SWITCH (6)		C101	1-126-851-11	ELECT 22uF	20% 35V
S912	1-762-400-11	SWITCH (9)		C102	1-126-851-11	ELECT 22uF	20% 35V
S913	1-762-400-11	SWITCH (*)		C103	1-163-251-11	CERAMIC CHIP 100PF	5% 50V
S914	1-762-400-11	SWITCH (+/-)		C104	1-163-251-11	CERAMIC CHIP 100PF	5% 50V
S915	1-762-400-11	SWITCH (0)		C107-111			
S916	1-762-400-11	SWITCH (SAVE)			1-126-049-11	ELECT 22uF	20% 25V
S917	1-762-400-11	SWITCH (SYSTEM)		C113	1-163-038-91	CERAMIC CHIP 0.1uF	25V
S918	1-762-400-11	SWITCH (ENTER)		C114	1-163-038-91	CERAMIC CHIP 0.1uF	25V
*****				C115	1-136-153-00	FILM 0.01uF	5% 50V
*	1-656-693-11	ENCODER BOARD *****		C117	1-126-049-11	ELECT 22uF	20% 25V
		< SWITCH >		C118	1-126-049-11	ELECT 22uF	20% 25V
S903	1-473-124-11	ENCODER, ROTARY (- \leftrightarrow +)		C201	1-126-851-11	ELECT 22uF	20% 35V
*****				C202	1-126-851-11	ELECT 22uF	20% 35V
*	1-656-691-11	LED BOARD *****		C203	1-163-251-11	CERAMIC CHIP 100PF	5% 50V
		< DIODE >		C204	1-163-251-11	CERAMIC CHIP 100PF	5% 50V
D901	8-719-053-62	LED SLA-5651-17 (CH1, PRESET)		C207-211			
D902	8-719-053-62	LED SLA-5651-17 (CH2, USER)			1-126-049-11	ELECT 22uF	20% 25V
NDU901	8-719-018-45	DIODE SL1283		C213	1-163-038-91	CERAMIC CHIP 0.1uF	25V
				C214	1-163-038-91	CERAMIC CHIP 0.1uF	25V

Ref. No.	Part No.	Description	Remark
C215	1-136-153-00	FILM	0. 01uF 5% 50V
C217	1-126-049-11	ELECT	22uF 20% 25V
C218	1-126-049-11	ELECT	22uF 20% 25V
C301	1-136-165-00	FILM	0. 1uF 5% 50V
C302	1-136-169-00	FILM	0. 22uF 5% 50V
C303	1-136-169-00	FILM	0. 22uF 5% 50V
C304	1-136-165-00	FILM	0. 1uF 5% 50V
C305	1-124-443-00	ELECT	100uF 20% 10V
C306	1-124-443-00	ELECT	100uF 20% 10V
C310-313			
	1-163-038-91	CERAMIC CHIP	0. 1uF 25V
C314	1-126-012-11	ELECT	470uF 20% 16V
C315	1-126-012-11	ELECT	470uF 20% 16V
C316	1-163-038-91	CERAMIC CHIP	0. 1uF 25V
C317	1-163-038-91	CERAMIC CHIP	0. 1uF 25V
C318	1-124-472-11	ELECT	470uF 20% 10V
C319	1-124-472-11	ELECT	470uF 20% 10V
C320	1-136-165-00	FILM	0. 1uF 5% 50V
C321	1-136-165-00	FILM	0. 1uF 5% 50V
C322	1-124-472-11	ELECT	470uF 20% 10V
C323	1-126-049-11	ELECT	22uF 20% 25V
C324	1-163-038-91	CERAMIC CHIP	0. 1uF 25V
C325	1-126-049-11	ELECT	22uF 20% 25V
C326-328			
	1-163-038-91	CERAMIC CHIP	0. 1uF 25V
C329	1-124-472-11	ELECT	470uF 20% 10V
C330	1-124-443-00	ELECT	100uF 20% 10V
C331-333			
	1-163-038-91	CERAMIC CHIP	0. 1uF 25V
C334	1-124-472-11	ELECT	470uF 20% 10V
C335	1-163-038-91	CERAMIC CHIP	0. 1uF 25V
C336	1-163-038-91	CERAMIC CHIP	0. 1uF 25V
C337	1-124-443-00	ELECT	100uF 20% 10V
C338	1-163-038-91	CERAMIC CHIP	0. 1uF 25V
C339	1-163-038-91	CERAMIC CHIP	0. 1uF 25V
C340	1-124-472-11	ELECT	470uF 20% 10V
C341	1-124-478-11	ELECT	100uF 20% 25V
C342	1-163-038-91	CERAMIC CHIP	0. 1uF 25V
C343	1-124-443-00	ELECT	100uF 20% 10V
C344	1-124-478-11	ELECT	100uF 20% 25V
C345	1-163-038-91	CERAMIC CHIP	0. 1uF 25V
C346	1-124-443-00	ELECT	100uF 20% 10V
C347	1-163-239-11	CERAMIC CHIP	33PF 5% 50V
C348	1-163-141-00	CERAMIC CHIP	0. 001uF 5% 50V
C349	1-163-239-11	CERAMIC CHIP	33PF 5% 50V
C350	1-163-038-91	CERAMIC CHIP	0. 1uF 25V
C351	1-136-165-00	FILM	0. 1uF 5% 50V
C352	1-124-443-00	ELECT	100uF 20% 10V
C401	1-130-467-00	MYLAR	470PF 5% 50V

Ref. No.	Part No.	Description	Remark
C402	1-163-251-11	CERAMIC CHIP	100PF 5% 50V
C403	1-163-251-11	CERAMIC CHIP	100PF 5% 50V
C408	1-110-339-11	MYLAR	220PF 5% 50V
C409	1-110-339-11	MYLAR	220PF 5% 50V
C412	1-130-475-00	MYLAR	0. 0022uF 5% 50V
C413	1-130-471-00	MYLAR	0. 001uF 5% 50V
C416	1-126-049-11	ELECT	22uF 20% 25V
C417	1-126-049-11	ELECT	22uF 20% 25V
C422	1-126-024-11	ELECT	220uF 20% 16V
C423	1-126-024-11	ELECT	220uF 20% 16V
C425	1-126-049-11	ELECT	22uF 20% 25V
C426	1-126-024-11	ELECT	220uF 20% 16V
C501	1-130-467-00	MYLAR	470PF 5% 50V
C502	1-163-251-11	CERAMIC CHIP	100PF 5% 50V
C503	1-163-251-11	CERAMIC CHIP	100PF 5% 50V
C508	1-110-339-11	MYLAR	220PF 5% 50V
C509	1-110-339-11	MYLAR	220PF 5% 50V
C512	1-130-475-00	MYLAR	0. 0022uF 5% 50V
C513	1-130-471-00	MYLAR	0. 001uF 5% 50V
C516	1-126-049-11	ELECT	22uF 20% 25V
C517	1-126-049-11	ELECT	22uF 20% 25V
C522	1-126-024-11	ELECT	220uF 20% 16V
C523	1-126-024-11	ELECT	220uF 20% 16V
C525	1-126-049-11	ELECT	22uF 20% 25V
C526	1-126-024-11	ELECT	220uF 20% 16V
C549	1-163-038-91	CERAMIC CHIP	0. 1uF 25V
C550	1-126-968-11	ELECT	100uF 20% 6. 3V
C551	1-163-038-91	CERAMIC CHIP	0. 1uF 25V
C552	1-163-038-91	CERAMIC CHIP	0. 1uF 25V
C601	1-126-961-11	ELECT	2. 2uF 20% 50V
C602-607			
	1-163-038-91	CERAMIC CHIP	0. 1uF 25V
C608	1-126-961-11	ELECT	2. 2uF 20% 50V
C609	1-126-961-11	ELECT	2. 2uF 20% 50V
C610	1-163-038-91	CERAMIC CHIP	0. 1uF 25V
C611	1-163-038-91	CERAMIC CHIP	0. 1uF 25V
C612	1-126-961-11	ELECT	2. 2uF 20% 50V
C613-621			
	1-163-038-91	CERAMIC CHIP	0. 1uF 25V
C623-627			
	1-163-038-91	CERAMIC CHIP	0. 1uF 25V
C628	1-124-907-11	ELECT	10uF 20% 50V
C629	1-163-038-91	CERAMIC CHIP	0. 1uF 25V
C630	1-124-907-11	ELECT	10uF 20% 50V
C631	1-163-038-91	CERAMIC CHIP	0. 1uF 25V
C632	1-124-907-11	ELECT	10uF 20% 50V
C633	1-126-968-11	ELECT	100uF 20% 6. 3V
C634	1-126-961-11	ELECT	2. 2uF 20% 50V
C635	1-163-038-91	CERAMIC CHIP	0. 1uF 25V

MAIN

Ref. No.	Part No.	Description	Remark
C636	1-163-239-11	CERAMIC CHIP 33PF	5% 50V
C638	1-163-235-11	CERAMIC CHIP 22PF	5% 50V
C639	1-163-235-11	CERAMIC CHIP 22PF	5% 50V
C640	1-163-038-91	CERAMIC CHIP 0.1uF	25V
C641-643	1-164-232-11	CERAMIC CHIP 0.01uF	50V
C645-649	1-163-038-91	CERAMIC CHIP 0.1uF	25V
C650	1-124-907-11	ELECT 10uF	20% 50V
C651	1-163-038-91	CERAMIC CHIP 0.1uF	25V
C652	1-163-038-91	CERAMIC CHIP 0.1uF	25V
C653	1-163-227-11	CERAMIC CHIP 10PF	0.5PF 50V
C654	1-163-227-11	CERAMIC CHIP 10PF	0.5PF 50V
C655-657	1-124-907-11	ELECT 10uF	20% 50V
C658	1-126-968-11	ELECT 100uF	20% 6.3V
C801	1-128-549-11	ELECT 3300uF	20% 35V
C802	1-128-549-11	ELECT 3300uF	20% 35V
C803-806	1-163-038-91	CERAMIC CHIP 0.1uF	25V
C807	1-126-027-11	ELECT 1000uF	20% 25V
C808	1-126-027-11	ELECT 1000uF	20% 25V
C809	1-126-946-11	ELECT 6800uF	20% 16V
C810	1-163-038-91	CERAMIC CHIP 0.1uF	25V
C811	1-163-038-91	CERAMIC CHIP 0.1uF	25V
C812	1-124-999-11	ELECT 2200uF	20% 10V
C813	1-126-946-11	ELECT 6800uF	20% 16V
C814	1-163-038-91	CERAMIC CHIP 0.1uF	25V
C815	1-163-038-91	CERAMIC CHIP 0.1uF	25V
C816	1-124-999-11	ELECT 2200uF	20% 10V
C817	1-126-967-11	ELECT 47uF	20% 35V
C818	1-124-477-11	ELECT 47uF	20% 25V
C819	1-163-037-11	CERAMIC CHIP 0.022uF	10% 25V
C820	1-126-105-11	ELECT 1000uF	20% 35V
C821	1-126-105-11	ELECT 1000uF	20% 35V
C901	1-163-038-91	CERAMIC CHIP 0.1uF	25V
C902	1-163-038-91	CERAMIC CHIP 0.1uF	25V
C903	1-163-251-11	CERAMIC CHIP 100PF	5% 50V
C904	1-163-251-11	CERAMIC CHIP 100PF	5% 50V
C905	1-163-038-91	CERAMIC CHIP 0.1uF	25V
C906	1-163-038-91	CERAMIC CHIP 0.1uF	25V
C907	1-126-049-11	ELECT 22uF	20% 25V
C908	1-136-161-00	FILM 0.047uF	5% 50V
C909	1-163-038-91	CERAMIC CHIP 0.1uF	25V
C910	1-126-049-11	ELECT 22uF	20% 25V
C911	1-163-038-91	CERAMIC CHIP 0.1uF	25V
C912	1-163-038-91	CERAMIC CHIP 0.1uF	25V
C913	1-163-235-11	CERAMIC CHIP 22PF	5% 50V
C914	1-163-235-11	CERAMIC CHIP 22PF	5% 50V

Ref. No.	Part No.	Description	Remark
C915	1-163-038-91	CERAMIC CHIP 0.1uF	25V
C916	1-163-038-91	CERAMIC CHIP 0.1uF	25V
C918	1-136-153-00	FILM 0.01uF	5% 50V
C919	1-163-249-11	CERAMIC CHIP 82PF	5% 50V
C920	1-163-227-11	CERAMIC CHIP 10PF	0.5PF 50V
C921	1-124-478-11	ELECT 100uF	20% 25V
C922	1-163-227-11	CERAMIC CHIP 10PF	0.5PF 50V
C923	1-163-239-11	CERAMIC CHIP 33PF	5% 50V
C924	1-163-038-91	CERAMIC CHIP 0.1uF	25V
C925	1-136-157-00	FILM 0.022uF	5% 50V
C926	1-163-038-91	CERAMIC CHIP 0.1uF	25V
C927	1-136-173-00	FILM 0.47uF	5% 50V
C929	1-163-038-91	CERAMIC CHIP 0.1uF	25V
C930	1-163-038-91	CERAMIC CHIP 0.1uF	25V
C931	1-124-478-11	ELECT 100uF	20% 25V
C932	1-163-038-91	CERAMIC CHIP 0.1uF	25V
C933	1-124-472-11	ELECT 470uF	20% 10V
C935	1-163-038-91	CERAMIC CHIP 0.1uF	25V
C1002	1-163-038-91	CERAMIC CHIP 0.1uF	25V

< CONNECTOR >

CN101	1-691-768-11	PLUG (MICRO CONNECTOR) 6P
CN103	1-691-768-31	PLUG (MICRO CONNECTOR) 6P
CN601	1-750-971-11	CONNECTOR, DIN 5P (MIDI)
* CN602	1-506-503-11	PIN, CONNECTOR 9P
* CN603	1-564-341-11	PIN, CONNECTOR 7P
* CN604	1-564-342-11	PIN, CONNECTOR 8P
* CN605	1-564-342-61	PIN, CONNECTOR 8P
* CN606	1-568-839-11	SOCKET, CONNECTOR 23P
* CN801	1-560-064-00	PIN, CONNECTOR 6P
* CN901	1-569-003-11	SOCKET, CONNECTOR 8P (DIGITAL I/O)

< DIODE >

D301	8-719-420-90	DIODE MA8051-M
D302	8-719-420-90	DIODE MA8051-M
D601-605	8-719-016-74	DIODE 1SS352
D606	8-719-800-76	DIODE 1SS226
D607	8-719-800-76	DIODE 1SS226
D801-808	8-719-200-02	DIODE 10E2
D809	8-719-210-33	DIODE EC10DS2
D810	8-719-210-33	DIODE EC10DS2
D811-813	8-719-016-74	DIODE 1SS352
D901	8-719-016-74	DIODE 1SS352
D902	8-719-928-03	DIODE KV1260M

Ref. No.	Part No.	Description	Remark
		< FUSE >	
△F801	1-532-215-00	FUSE, TIME-LAG (T0. 8A 250V) (AEP, Australian)	
△F801	1-532-739-11	FUSE, GLASS TUBE (0. 8A 125V) (US, Canadian)	
△F802	1-532-215-00	FUSE, TIME-LAG (T0. 8A 250V) (AEP, Australian)	
△F802	1-532-739-11	FUSE, GLASS TUBE (0. 8A 125V) (US, Canadian)	
△F803	1-532-215-00	FUSE, TIME-LAG (T0. 8A 250V) (AEP, Australian)	
△F803	1-532-739-11	FUSE, GLASS TUBE (0. 8A 125V) (US, Canadian)	
△F804	1-532-215-00	FUSE, TIME-LAG (T0. 8A 250V) (AEP, Australian)	
△F804	1-532-739-11	FUSE, GLASS TUBE (0. 8A 125V) (US, Canadian)	
		< IC >	
IC101-107			
	8-759-711-82	IC NJM4580E	
IC301	8-759-701-56	IC NJM78M05FA	
IC302	8-759-701-65	IC NJM79M05FA	
IC303	8-759-701-56	IC NJM78M05FA	
IC304	8-759-330-53	IC CXD8493M-E1	
IC305	8-759-196-21	IC CXD8482Q	
IC306	8-759-711-82	IC NJM4580E	
IC307	8-759-334-75	IC CXD8505Q	
IC401-404			
	8-759-711-82	IC NJM4580E	
IC501-504			
	8-759-711-82	IC NJM4580E	
IC601	8-759-283-51	IC M5M44260ATP-7L	
IC602	8-752-362-00	IC CXD2707Q	
IC603	8-759-283-51	IC M5M44260ATP-7L	
IC604	8-752-362-00	IC CXD2707Q	
IC605	8-759-995-09	IC MSM6338RS	
IC606	8-759-188-95	IC CXD8481Q	
IC607	8-759-350-85	IC TMS27C040-V77-E1	
IC608	8-752-337-79	IC CXK58257AM-10LL-T6	
IC609	8-752-337-79	IC CXK58257AM-10LL-T6	
IC610	8-759-188-96	IC SED1335FOB	
IC611	8-759-336-84	IC LC3564SM-10-TRM	
IC612	8-759-637-07	IC M62021FP-600C	
IC613	8-759-188-93	IC NJU46355EM-T1	
IC614	8-759-283-49	IC HD6413002F10	
IC615	8-759-269-44	IC SN74HC151ANS-E20	
IC801	8-759-982-36	IC RC78M15FA	
IC802	8-759-701-70	IC NJM79M15FA	
IC803	8-759-701-56	IC NJM78M05FA	

Ref. No.	Part No.	Description	Remark
IC804	8-759-701-56	IC NJM78M05FA	
IC901	8-759-355-06	IC CS8412-CS	
IC902	8-759-330-78	IC CS8402A-CS-E1	
IC903	8-759-191-15	IC M66009FP	
IC904	8-759-232-74	IC TC74HC163AF	
IC905	8-759-269-92	IC SN74HCU04ANS-E20	
IC906	8-759-926-17	IC SN74HC153ANS	
IC907	8-759-232-74	IC TC74HC163AF	
IC908	8-759-232-74	IC TC74HC163AF	
IC909	8-759-269-92	IC SN74HCU04ANS-E20	
IC910	8-759-250-81	IC TC5081AP	
IC911	8-759-062-66	IC TC7S66F	
IC913	8-759-031-84	IC SC7S04F	
IC914	8-759-269-92	IC SN74HCU04ANS-E20	
		< SOCKET >	
ICS607	1-540-107-11	SOCKET, IC 32P	
		< JACK >	
J101	1-568-006-11	CONNECTOR, XLR TYPE 3P (INPUT, BALANCED (CH1))	
J102	1-568-005-11	CONNECTOR, XLR TYPE 3P (OUTPUT, BALANCED (CH1))	
J103	1-580-041-11	JACK, LARGE (2 GANG) (INPUT, UNBALANCED)	
J104	1-750-973-11	JACK (LARGE TYPE) (2 GANG) (OUTPUT, UNBALANCED)	
J201	1-568-006-11	CONNECTOR, XLR TYPE 3P (INPUT, BALANCED (CH2))	
J202	1-568-005-11	CONNECTOR, XLR TYPE 3P (OUTPUT, BALANCED (CH2))	
J601	1-750-973-11	JACK (LARGE TYPE) (2 GANG) (PEDAL)	
		< COIL >	
L301	1-410-369-11	INDUCTOR CHIP 1uH	
L302	1-410-377-31	INDUCTOR CHIP 4. 7uH	
L601-615			
	1-410-377-31	INDUCTOR CHIP 4. 7uH	
L617-620			
	1-414-235-11	INDUCTOR, FERRITE BEAD	
L621	1-410-377-31	INDUCTOR CHIP 4. 7uH	
L901-908			
	1-410-377-31	INDUCTOR CHIP 4. 7uH	
L909	1-410-397-21	FERRITE BEAD INDUCTOR	
L910	1-410-377-31	INDUCTOR CHIP 4. 7uH	
L911	1-426-850-11	COIL (RF)	
L912-915			
	1-236-129-11	ENCAPSULATED COMPONENT	
		< PHOTO COUPLER >	
PC601	8-749-924-62	PHOTO COUPLER PC410	

The components identified by mark △ or dotted line with mark △ are critical for safety. Replace only with part number specified.	Les composants identifiés par une marque △ sont critiques pour la sécurité. Ne les remplacer que par une pièce portant le numéro spécifié.
---	--

MAIN

Ref. No.	Part No.	Description	Remark	Ref. No.	Part No.	Description	Remark
< TRANSISTOR >				R117	1-260-008-11	CARBON MELF	10K 2% 1/8W
Q101	8-729-422-29	TRANSISTOR 2SD601A-S		R118	1-260-004-11	CARBON MELF	4.7K 2% 1/8W
Q102	8-729-422-29	TRANSISTOR 2SD601A-S		R119	1-259-979-11	CARBON MELF	47 2% 1/8W
Q201	8-729-422-29	TRANSISTOR 2SD601A-S		R120	1-259-979-11	CARBON MELF	47 2% 1/8W
Q202	8-729-422-29	TRANSISTOR 2SD601A-S		R121-123			
Q301	8-729-205-38	TRANSISTOR 2SK208-Y			1-259-991-11	CARBON MELF	470 2% 1/8W
Q302	8-729-808-01	TRANSISTOR 2SD1622-S		R124	1-216-057-00	METAL CHIP	2.2K 5% 1/10W
Q303	8-729-205-38	TRANSISTOR 2SK208-Y		R125	1-216-057-00	METAL CHIP	2.2K 5% 1/10W
Q304	8-729-808-01	TRANSISTOR 2SD1622-S		R126	1-260-004-11	CARBON MELF	4.7K 2% 1/8W
Q601-605				R127	1-260-004-11	CARBON MELF	4.7K 2% 1/8W
	8-729-805-65	TRANSISTOR 2SA1344		R128	1-260-016-11	CARBON MELF	47K 2% 1/8W
Q606-614				R129	1-260-020-11	CARBON MELF	100K 2% 1/8W
	8-729-805-41	TRANSISTOR 2SC3398		R201	1-260-016-11	CARBON MELF	47K 2% 1/8W
Q615	8-729-120-28	TRANSISTOR 2SC1623-L5L6		R202	1-260-016-11	CARBON MELF	47K 2% 1/8W
Q616	8-729-422-29	TRANSISTOR 2SD601A-S		R203-206			
Q617	8-729-422-29	TRANSISTOR 2SD601A-S			1-260-012-11	CARBON MELF	22K 2% 1/8W
Q618	8-729-805-41	TRANSISTOR 2SC3398		R207	1-259-999-11	CARBON MELF	2.2K 2% 1/8W
Q619	8-729-805-65	TRANSISTOR 2SA1344		R208	1-260-016-11	CARBON MELF	47K 2% 1/8W
Q620	8-729-805-41	TRANSISTOR 2SC3398		R209	1-260-016-11	CARBON MELF	47K 2% 1/8W
Q621	8-729-805-65	TRANSISTOR 2SA1344		R210	1-260-002-11	CARBON MELF	3.3K 2% 1/8W
Q622	8-729-805-41	TRANSISTOR 2SC3398		R211	1-260-020-11	CARBON MELF	100K 2% 1/8W
Q623	8-729-805-65	TRANSISTOR 2SA1344		R212	1-260-020-11	CARBON MELF	100K 2% 1/8W
Q624	8-729-805-41	TRANSISTOR 2SC3398		R213	1-260-008-11	CARBON MELF	10K 2% 1/8W
Q625	8-729-805-65	TRANSISTOR 2SA1344		R214	1-260-008-11	CARBON MELF	10K 2% 1/8W
Q626	8-729-422-29	TRANSISTOR 2SD601A-S		R215	1-260-004-11	CARBON MELF	4.7K 2% 1/8W
Q627	8-729-805-65	TRANSISTOR 2SA1344		R216	1-260-008-11	CARBON MELF	10K 2% 1/8W
Q628	8-729-120-28	TRANSISTOR 2SC1623-L5L6		R217	1-260-008-11	CARBON MELF	10K 2% 1/8W
Q629	8-729-120-28	TRANSISTOR 2SC1623-L5L6		R218	1-260-004-11	CARBON MELF	4.7K 2% 1/8W
Q630	8-729-805-65	TRANSISTOR 2SA1344		R219	1-259-979-11	CARBON MELF	47 2% 1/8W
Q901-903				R220	1-259-979-11	CARBON MELF	47 2% 1/8W
	8-729-120-28	TRANSISTOR 2SC1623-L5L6		R221-223			
Q904	8-729-232-07	TRANSISTOR 2SK302-Y			1-259-991-11	CARBON MELF	470 2% 1/8W
Q905	8-729-232-07	TRANSISTOR 2SK302-Y		R224	1-216-057-00	METAL CHIP	2.2K 5% 1/10W
< RESISTOR >				R225	1-216-057-00	METAL CHIP	2.2K 5% 1/10W
R101	1-260-016-11	CARBON MELF	47K 2% 1/8W	R226	1-260-004-11	CARBON MELF	4.7K 2% 1/8W
R102	1-260-016-11	CARBON MELF	47K 2% 1/8W	R227	1-260-004-11	CARBON MELF	4.7K 2% 1/8W
R103-106				R228	1-260-016-11	CARBON MELF	47K 2% 1/8W
	1-260-012-11	CARBON MELF	22K 2% 1/8W	R229	1-260-020-11	CARBON MELF	100K 2% 1/8W
R107	1-259-999-11	CARBON MELF	2.2K 2% 1/8W	R301	1-216-049-91	METAL GLAZE	1K 5% 1/10W
R108	1-260-016-11	CARBON MELF	47K 2% 1/8W	R302	1-216-025-91	METAL GLAZE	100 5% 1/10W
R109	1-260-016-11	CARBON MELF	47K 2% 1/8W	R303	1-216-013-00	METAL CHIP	33 5% 1/10W
R110	1-260-002-11	CARBON MELF	3.3K 2% 1/8W	R305-311			
R111	1-260-020-11	CARBON MELF	100K 2% 1/8W		1-216-041-00	METAL CHIP	470 5% 1/10W
R112	1-260-020-11	CARBON MELF	100K 2% 1/8W	R314	1-216-033-00	METAL CHIP	220 5% 1/10W
R113	1-260-008-11	CARBON MELF	10K 2% 1/8W	R315	1-216-025-91	METAL GLAZE	100 5% 1/10W
R114	1-260-008-11	CARBON MELF	10K 2% 1/8W	R316	1-216-025-91	METAL GLAZE	100 5% 1/10W
R115	1-260-004-11	CARBON MELF	4.7K 2% 1/8W	R317	1-216-033-00	METAL CHIP	220 5% 1/10W
R116	1-260-008-11	CARBON MELF	10K 2% 1/8W	R318	1-216-025-91	METAL GLAZE	100 5% 1/10W
				R319	1-216-025-91	METAL GLAZE	100 5% 1/10W

Ref. No.	Part No.	Description	Remark		
R320	1-216-017-91	METAL GLAZE	47	5%	1/10W
R322-324					
	1-216-041-00	METAL CHIP	470	5%	1/10W
R325	1-216-017-91	METAL GLAZE	47	5%	1/10W
R326	1-216-017-91	METAL GLAZE	47	5%	1/10W
R327	1-216-041-00	METAL CHIP	470	5%	1/10W
R328	1-216-017-91	METAL GLAZE	47	5%	1/10W
R329	1-216-017-91	METAL GLAZE	47	5%	1/10W
R330	1-216-121-91	METAL GLAZE	1M	5%	1/10W
R401-404					
	1-249-427-11	CARBON	6.8K	5%	1/4W
R405	1-260-004-11	CARBON MELF	4.7K	2%	1/8W
R406	1-260-004-11	CARBON MELF	4.7K	2%	1/8W
R407	1-260-012-11	CARBON MELF	22K	2%	1/8W
R408	1-260-012-11	CARBON MELF	22K	2%	1/8W
R409-412					
	1-259-999-11	CARBON MELF	2.2K	2%	1/8W
R414	1-259-999-11	CARBON MELF	2.2K	2%	1/8W
R415	1-259-999-11	CARBON MELF	2.2K	2%	1/8W
R416	1-216-254-00	CARBON MELF	220K	2%	1/8W
R417	1-260-008-11	CARBON MELF	10K	2%	1/8W
R418	1-260-008-11	CARBON MELF	10K	2%	1/8W
R419	1-260-004-11	CARBON MELF	4.7K	2%	1/8W
R420	1-260-008-11	CARBON MELF	10K	2%	1/8W
R421	1-260-008-11	CARBON MELF	10K	2%	1/8W
R422	1-260-004-11	CARBON MELF	4.7K	2%	1/8W
R423	1-260-028-11	CARBON MELF	470K	2%	1/8W
R424	1-260-028-11	CARBON MELF	470K	2%	1/8W
R425	1-259-991-11	CARBON MELF	470	2%	1/8W
R426	1-259-991-11	CARBON MELF	470	2%	1/8W
R427	1-259-983-11	CARBON MELF	100	2%	1/8W
R428	1-259-983-11	CARBON MELF	100	2%	1/8W
R429	1-260-008-11	CARBON MELF	10K	2%	1/8W
R430	1-260-008-11	CARBON MELF	10K	2%	1/8W
R431	1-260-016-11	CARBON MELF	47K	2%	1/8W
R432	1-260-002-11	CARBON MELF	3.3K	2%	1/8W
R433	1-260-028-11	CARBON MELF	470K	2%	1/8W
R434	1-259-991-11	CARBON MELF	470	2%	1/8W
R435	1-259-983-11	CARBON MELF	100	2%	1/8W
R436	1-260-020-11	CARBON MELF	100K	2%	1/8W
R501-504					
	1-249-427-11	CARBON	6.8K	5%	1/4W
R505	1-260-004-11	CARBON MELF	4.7K	2%	1/8W
R506	1-260-004-11	CARBON MELF	4.7K	2%	1/8W
R507	1-260-012-11	CARBON MELF	22K	2%	1/8W
R508	1-260-012-11	CARBON MELF	22K	2%	1/8W
R509-512					
	1-259-999-11	CARBON MELF	2.2K	2%	1/8W
R514	1-259-999-11	CARBON MELF	2.2K	2%	1/8W
R515	1-259-999-11	CARBON MELF	2.2K	2%	1/8W

Ref. No.	Part No.	Description	Remark		
R516	1-216-254-00	CARBON MELF	220K	2%	1/8W
R517	1-260-008-11	CARBON MELF	10K	2%	1/8W
R518	1-260-008-11	CARBON MELF	10K	2%	1/8W
R519	1-260-004-11	CARBON MELF	4.7K	2%	1/8W
R520	1-260-008-11	CARBON MELF	10K	2%	1/8W
R521	1-260-008-11	CARBON MELF	10K	2%	1/8W
R522	1-260-004-11	CARBON MELF	4.7K	2%	1/8W
R523	1-260-028-11	CARBON MELF	470K	2%	1/8W
R524	1-260-028-11	CARBON MELF	470K	2%	1/8W
R525	1-259-991-11	CARBON MELF	470	2%	1/8W
R526	1-259-991-11	CARBON MELF	470	2%	1/8W
R527	1-259-983-11	CARBON MELF	100	2%	1/8W
R528	1-259-983-11	CARBON MELF	100	2%	1/8W
R529	1-260-008-11	CARBON MELF	10K	2%	1/8W
R530	1-260-008-11	CARBON MELF	10K	2%	1/8W
R531	1-260-016-11	CARBON MELF	47K	2%	1/8W
R532	1-260-002-11	CARBON MELF	3.3K	2%	1/8W
R533	1-260-028-11	CARBON MELF	470K	2%	1/8W
R534	1-259-991-11	CARBON MELF	470	2%	1/8W
R535	1-259-983-11	CARBON MELF	100	2%	1/8W
R536	1-260-020-11	CARBON MELF	100K	2%	1/8W
R601	1-216-001-00	METAL CHIP	10	5%	1/10W
R602	1-216-033-00	METAL CHIP	220	5%	1/10W
R603	1-216-033-00	METAL CHIP	220	5%	1/10W
R604-610					
	1-216-041-00	METAL CHIP	470	5%	1/10W
R612-616					
	1-216-041-00	METAL CHIP	470	5%	1/10W
R617	1-216-065-00	METAL CHIP	4.7K	5%	1/10W
R618	1-216-001-00	METAL CHIP	10	5%	1/10W
R619	1-216-033-00	METAL CHIP	220	5%	1/10W
R620	1-216-033-00	METAL CHIP	220	5%	1/10W
R621-633					
	1-216-041-00	METAL CHIP	470	5%	1/10W
R634	1-216-065-00	METAL CHIP	4.7K	5%	1/10W
R635-637					
	1-216-049-91	METAL GLAZE	1K	5%	1/10W
R638	1-216-061-00	METAL CHIP	3.3K	5%	1/10W
R639	1-216-061-00	METAL CHIP	3.3K	5%	1/10W
R640-643					
	1-216-037-00	METAL CHIP	330	5%	1/10W
R644-646					
	1-216-033-00	METAL CHIP	220	5%	1/10W
R647	1-216-037-00	METAL CHIP	330	5%	1/10W
R648	1-216-073-00	METAL CHIP	10K	5%	1/10W
R649	1-216-073-00	METAL CHIP	10K	5%	1/10W
R650-653					
	1-216-041-00	METAL CHIP	470	5%	1/10W
R654	1-216-049-91	METAL GLAZE	1K	5%	1/10W
R655	1-216-049-91	METAL GLAZE	1K	5%	1/10W

MAIN

Ref. No.	Part No.	Description	Remark
R656-682	1-216-041-00	METAL CHIP	470 5% 1/10W
△R683	1-219-212-11	FUSIBLE	15 5% 1/8W F
△R684	1-219-212-11	FUSIBLE	15 5% 1/8W F
R685-688	1-216-041-00	METAL CHIP	470 5% 1/10W
R689	1-216-073-00	METAL CHIP	10K 5% 1/10W
R690	1-216-017-91	METAL GLAZE	47 5% 1/10W
R691	1-216-073-00	METAL CHIP	10K 5% 1/10W
R692	1-216-073-00	METAL CHIP	10K 5% 1/10W
R693	1-216-089-91	METAL GLAZE	47K 5% 1/10W
R694	1-216-073-00	METAL CHIP	10K 5% 1/10W
R695	1-216-089-91	METAL GLAZE	47K 5% 1/10W
R696	1-216-073-00	METAL CHIP	10K 5% 1/10W
R697	1-216-097-91	METAL GLAZE	100K 5% 1/10W
R698	1-216-097-91	METAL GLAZE	100K 5% 1/10W
R699	1-216-121-91	METAL GLAZE	1M 5% 1/10W
R700	1-216-061-00	METAL CHIP	3.3K 5% 1/10W
R701	1-216-073-00	METAL CHIP	10K 5% 1/10W
R702	1-216-065-00	METAL CHIP	4.7K 5% 1/10W
R703	1-216-073-00	METAL CHIP	10K 5% 1/10W
R704	1-216-073-00	METAL CHIP	10K 5% 1/10W
R705	1-216-065-00	METAL CHIP	4.7K 5% 1/10W
R706	1-216-073-00	METAL CHIP	10K 5% 1/10W
R707-709	1-216-033-00	METAL CHIP	220 5% 1/10W
R710	1-216-049-91	METAL GLAZE	1K 5% 1/10W
R711	1-216-089-91	METAL GLAZE	47K 5% 1/10W
R712	1-216-073-00	METAL CHIP	10K 5% 1/10W
R713	1-216-089-91	METAL GLAZE	47K 5% 1/10W
R714	1-216-073-00	METAL CHIP	10K 5% 1/10W
R720-723	1-216-041-00	METAL CHIP	470 5% 1/10W
R725	1-216-073-00	METAL CHIP	10K 5% 1/10W
R726	1-216-089-91	METAL GLAZE	47K 5% 1/10W
R727	1-216-097-91	METAL GLAZE	100K 5% 1/10W
R728	1-216-121-91	METAL GLAZE	1M 5% 1/10W
R729	1-216-073-00	METAL CHIP	10K 5% 1/10W
R730	1-216-073-00	METAL CHIP	10K 5% 1/10W
R801	1-216-037-00	METAL CHIP	330 5% 1/10W
R802	1-216-029-00	METAL CHIP	150 5% 1/10W
R803	1-216-105-91	METAL GLAZE	220K 5% 1/10W
R804	1-216-089-91	METAL GLAZE	47K 5% 1/10W
R805	1-216-089-91	METAL GLAZE	47K 5% 1/10W
R806	1-216-073-00	METAL CHIP	10K 5% 1/10W
R807	1-216-057-00	METAL CHIP	2.2K 5% 1/10W
R808	1-216-025-91	METAL GLAZE	100 5% 1/10W
R901-904	1-216-033-00	METAL CHIP	220 5% 1/10W
R905	1-216-017-91	METAL GLAZE	47 5% 1/10W

Ref. No.	Part No.	Description	Remark
R906	1-216-017-91	METAL GLAZE	47 5% 1/10W
R907	1-216-033-00	METAL CHIP	220 5% 1/10W
R908	1-216-033-00	METAL CHIP	220 5% 1/10W
R909	1-216-049-91	METAL GLAZE	1K 5% 1/10W
R915	1-216-033-00	METAL CHIP	220 5% 1/10W
R916	1-216-041-00	METAL CHIP	470 5% 1/10W
R917	1-216-049-91	METAL GLAZE	1K 5% 1/10W
R918	1-216-017-91	METAL GLAZE	47 5% 1/10W
R919	1-216-017-91	METAL GLAZE	47 5% 1/10W
R920	1-216-041-00	METAL CHIP	470 5% 1/10W
R921	1-216-049-91	METAL GLAZE	1K 5% 1/10W
R922	1-216-017-91	METAL GLAZE	47 5% 1/10W
R923-925	1-216-041-00	METAL CHIP	470 5% 1/10W
R926	1-216-033-00	METAL CHIP	220 5% 1/10W
R927	1-216-049-91	METAL GLAZE	1K 5% 1/10W
R928	1-216-121-91	METAL GLAZE	1M 5% 1/10W
R929	1-216-057-00	METAL CHIP	2.2K 5% 1/10W
R931	1-216-017-91	METAL GLAZE	47 5% 1/10W
R932	1-216-017-91	METAL GLAZE	47 5% 1/10W
R933	1-216-049-91	METAL GLAZE	1K 5% 1/10W
R934	1-216-097-91	METAL GLAZE	100K 5% 1/10W
R935	1-216-097-91	METAL GLAZE	100K 5% 1/10W
R936	1-216-073-00	METAL CHIP	10K 5% 1/10W
R937	1-216-073-00	METAL CHIP	10K 5% 1/10W
R938	1-216-097-91	METAL GLAZE	100K 5% 1/10W
R939-941	1-216-049-91	METAL GLAZE	1K 5% 1/10W
R942	1-216-121-91	METAL GLAZE	1M 5% 1/10W
R943	1-216-057-00	METAL CHIP	2.2K 5% 1/10W
R944	1-216-049-91	METAL GLAZE	1K 5% 1/10W
R945	1-216-017-91	METAL GLAZE	47 5% 1/10W
R946	1-216-065-00	METAL CHIP	4.7K 5% 1/10W
R947	1-216-061-00	METAL CHIP	3.3K 5% 1/10W
R948	1-216-033-00	METAL CHIP	220 5% 1/10W
R950	1-216-017-91	METAL GLAZE	47 5% 1/10W
R1004	1-216-041-00	METAL CHIP	470 5% 1/10W
		< RELAY >	
RY601-604	1-755-061-11	RELAY	
		< SWITCH >	
S101	1-762-175-11	SWITCH, SLIDE (LEVEL dB)	
S102	1-762-175-11	SWITCH, SLIDE (LEVEL dB)	
		< TRANSFORMER >	
T901	1-423-800-11	TRANSFORMER, PULSE	
T902	1-423-800-11	TRANSFORMER, PULSE	

The components identified by mark △ or dotted line with mark △ are critical for safety. Replace only with part number specified.

Les composants identifiés par une marque △ sont critiques pour la sécurité. Ne les remplacer que par une pièce portant le numéro spécifié.

MAIN	PRIMARY	VOL
-------------	----------------	------------

Ref. No.	Part No.	Description	Remark
< VIBRATOR >			
X301	1-760-032-11	VIBRATOR, CRYSTAL (48.6MHZ)	
X601	1-579-358-11	VIBLATOR, CRYSTAL (10MHZ)	
X603	1-567-098-41	VIBRATOR, CRYSTAL (32.768KHZ)	
X901	1-567-908-11	VIBRATOR, CRYSTAL (12.288MHZ)	

*	1-656-690-11	PRIMARY BOARD	

< CAPACITOR >			
△C1	1-161-744-51	CERAMIC	0.01uF 400V
△C2	1-161-742-00	CERAMIC	0.0022uF 20% 400V
△C3	1-161-742-00	CERAMIC	0.0022uF 20% 400V
△C4	1-161-742-00	CERAMIC	0.0022uF 20% 400V
(US, Canadian)			
△C5	1-161-742-00	CERAMIC	0.0022uF 20% 400V
(AEP, Australian)			
△C6	1-161-742-00	CERAMIC	0.0022uF 20% 400V
(AEP, Australian)			
< CONNECTOR >			
CN1	1-580-629-11	PIN, CONNECTOR 2P	
* CN2	1-564-687-11	PIN, CONNECTOR 3P	
< LINE FILTER >			
△LF1	1-421-915-11	COIL, LINE FILTER	
< SWITCH >			
△S1	1-762-363-11	SWITCH, POWER (POWER)	
△S2	1-570-173-11	SELECTOR, POWER VOLTAGE	
(VOLTAGE SELECTOR)			

*	1-656-694-11	VOL BOARD	

< CONNECTOR >			
* CN102	1-564-522-11	PLUG, CONNECTOR 7P	
* CN104	1-564-521-11	PLUG, CONNECTOR 6P	
< VARIABLE RESISTOR >			
RV101	1-241-170-11	RES, VAR, CARBON 20K/20K (INPUT)	
RV102	1-237-306-11	RES, VAR, CARBON 10K/10K (OUTPUT)	

Ref. No.	Part No.	Description	Remark
MISCELLANEOUS			

△55	1-762-363-11	SWITCH, POWER (POWER)	
56	1-537-770-21	TERMINAL BOARD, GROUND	
△58	1-551-812-11	CORD, POWER (US, Canadian)	
△58	1-590-910-11	CORD SET, POWER (AEP, Australian)	
59	1-533-293-11	FUSE HOLDER	
* 63	1-690-057-11	LEAD (WITH CONNECTOR) (2 CORE)	
68	1-500-278-11	FILTER, CLAMP (FERRITE CORE)	
(US, Canadian)			
△CNJ1	1-580-375-21	INLET 3P (AC IN~)	
△F801	1-532-215-00	FUSE, TIME-LAG (T0.8A 250V)	
(AEP, Australian)			
△F801	1-532-739-11	FUSE, GLASS TUBE (0.8A 125V)	
(US, Canadian)			
△F802	1-532-215-00	FUSE, TIME-LAG (T0.8A 250V)	
(AEP, Australian)			
△F802	1-532-739-11	FUSE, GLASS TUBE (0.8A 125V)	
(US, Canadian)			
△F803	1-532-215-00	FUSE, TIME-LAG (T0.8A 250V)	
(AEP, Australian)			
△F803	1-532-739-11	FUSE, GLASS TUBE (0.8A 125V)	
(US, Canadian)			
△F804	1-532-215-00	FUSE, TIME-LAG (T0.8A 250V)	
(AEP, Australian)			
△F804	1-532-739-11	FUSE, GLASS TUBE (0.8A 125V)	
(US, Canadian)			
LCD501	1-810-771-11	DISPLAY PANEL, LIQUID CRYSTAL	
△T1	1-429-097-11	TRANSFORMER, POWER (US, Canadian)	
△T1	1-429-098-11	TRANSFORMER, POWER (AEP, Australian)	

ACCESSORIES & PACKING MATERIALS			

1-551-812-11 CORD, POWER (US, Canadian)			
1-590-910-11 CORD SET, POWER (AEP, Australian)			
3-703-450-01 INSTRUCTION			
(ENGLISH/FRENCH) (US, Canadian)			
3-798-760-11 MANUAL, INSTRUCTION			
(ENGLISH, FRENCH, DANISH)			
3-798-784-11 GUIDE (ENGLISH, FRENCH, DANISH)			
3-798-785-11 LIST, PRESET MEMORY			
*	4-941-101-01	CUSHION (L)	
*	4-941-102-01	CUSHION (R)	
*	4-950-766-01	LABEL, FCC DIGITAL DEVICE (US, Canadian)	

The components identified by mark △ or dotted line with mark △ are critical for safety. Replace only with part number specified.	Les composants identifiés par une marque △ sont critiques pour la sécurité. Ne les remplacer que par une pièce portant le numéro spécifié.
--	--

<u>Ref.No.</u>	<u>Part No.</u>	<u>Description</u>	<u>Remark</u>
		***** HARDWARE LIST *****	
#1	7-682-547-09	SCREW +BV 3×6, S TIGHT	
#2	7-682-247-09	SCREW +K 3×6	
#3	7-682-548-09	SCREW +BVTT 3×8 (S)	
#4	7-621-255-35	SCREW +P 2×5	
#5	7-621-284-10	SCREW +P 2.6×5	
#6	7-621-771-06	SCREW, LOCK	
#7	7-621-849-00	SCREW, TAPPING	
#8	7-682-661-01	SCREW +PS 4×8	
#9	7-685-646-79	SCREW +BVTP 3×8 TYPE2 N-S	

DPS-V77

SONY

SERVICE MANUAL

*US Model
Canadian Model
AEP Model
Australian Model*

CORRECTION-1

Correct your service manual as shown below.

Subject: CORRECTION OF PARTS LIST

(RPC-97001)

 : indicates corrected portion.

Page	INCORRECT			CORRECT	
	<u>Ref. No.</u>	<u>Part No.</u>	<u>Description</u>	<u>Part No.</u>	<u>Description</u>
57	X901	1-567-908-11	VIBRATOR, CRYSTAL (12.288MHz)	1-567- 908 -11 	VIBRATOR, CRYSTAL (12.288MHz)