



Broadway Assignable Audio Console

System Overview

Digital Control of Analogue Audio

INPUT AUDIO RACK
40 Inputs

INPUT AUDIO RACK
40 Inputs

OUTPUT AUDIO RACK
20 Inputs (optional)
32 Graux Outputs
5 Main Outputs
20 Matrix Outputs (optional)

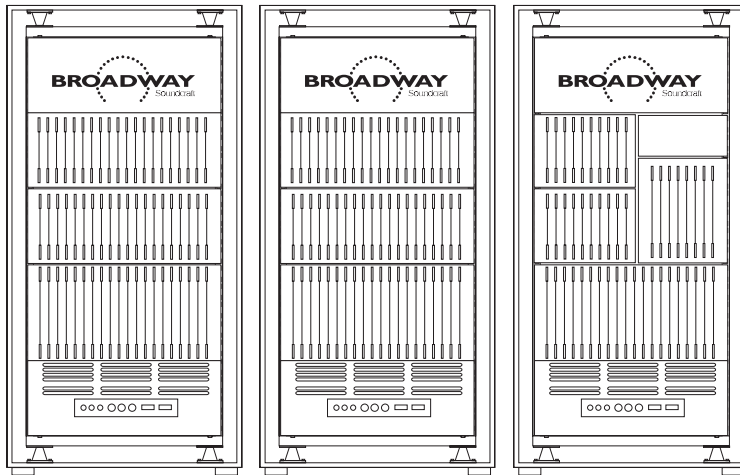

OPTIONAL PC
For Local Control

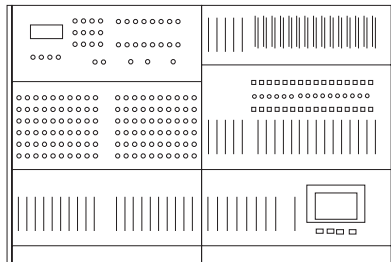
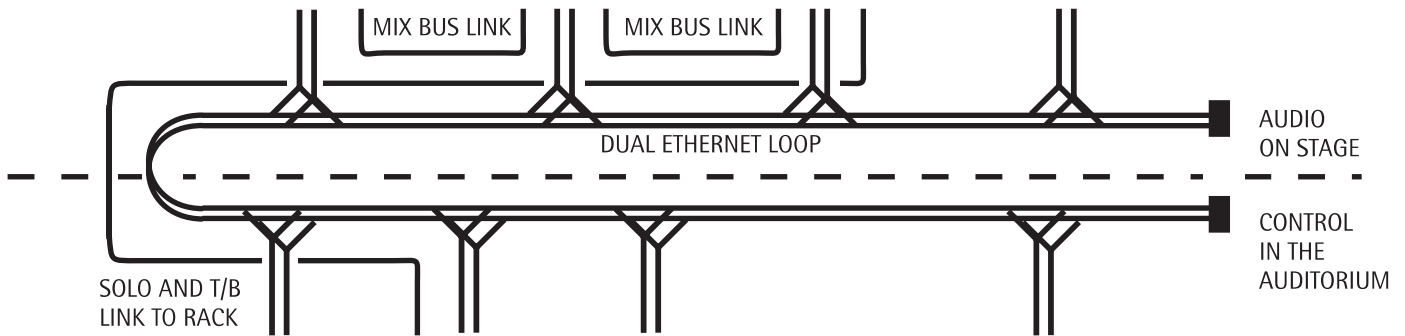
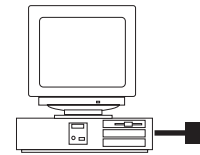

INPUT CONTROL SURFACE MASTER CONTROL SURFACE
Primary Mix Position



OPTIONAL PC
For Cue List
Display with Notes

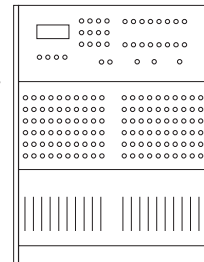

INPUT CONTROL SURFACE
Secondary Mix Position

Introduction.....	4
INPUT CONTROL SURFACE.....	5
Input Control Surface.....	6
ACS.....	6
Encoder Panel.....	8
Fader Tray.....	8
Rear Panel.....	9
MASTER CONTROL SURFACE	10
Master Control Surface.....	11
Meterbridge.....	11
GrAux Fader tray.....	11
VCA Fader tray.....	11
Control Presets.....	13
Bank Select.....	13
Cue Presets.....	13
CPU Housing and Touchscreen.....	13
Main Cue Transport Controls.....	13
Rear Panel.....	14
VCA Extender Surface	15
Input Audio Rack.....	17
Input Card.....	17
EQ Card.....	17
Buffer Card.....	17
Mix Bus Card.....	17
Rear Panel.....	18
PSU and Network Interface.....	18
Output Audio Rack.....	21
Configuration Options.....	21
Input Card.....	21
EQ Card.....	21
Buffer Card.....	21
Mix Bus Card.....	21
Output Card.....	21
Rear Panel.....	22
Network Interface.....	22
Software	24
VCAs.....	25
Offset Groups.....	27
Show Storage.....	30
Touchscreen Software.....	30
MIDI.....	30
External PC compatibility.....	30
Installing and Moving the System.....	33
Installation.....	33
Transportation.....	34
Internal Rack Dimensions (without flightcase).....	35

Introduction

Sound designers are accustomed to being asked for the impossible. Today's top dramatic and musical productions call for large sound reinforcement systems, sophisticated cues and effects, and crystal-clear sound reproduction. To the problems of total repeatability on every night of a production might be added the challenge of taking that same show on tour.

On top of that, the cost to a theatre of giving up even a single seat means that installations must be as small as possible. Engineers and operators know only too well that the integration, automation and flexibility to achieve all this is rarely seen in audio systems - and certainly not in a mixer with a small footprint.

Until now, that is. Thanks to its advanced implementation of digitally controlled analogue technology, and a modular system design, the Soundcraft Broadway rewrites the rulebook for theatre sound. Without compromising either quality or the system's operational limits, both the control hardware and audio electronics can be independently configured to your precise requirements, and located wherever the situation demands.

Broadway is the last word in audio production tools for theatre. With its modular analogue audio components, you can add as many inputs as you need, without limits. Rather than tie you down with a fixed configuration, Broadway's 32 'GrAux' busses can be used as groups or auxes as required. Outputs come in modular form so you may add further outputs as required, to suit even the most complex system design.

No matter how you configure your audio, you are still free to put together whatever combination of input and master control surfaces best fits your system requirements and your space constraints. For example, a number of extra control surfaces could be added during rehearsals, then this number could be cut back to a basic control configuration for the first production night, or for taking the show on the road.

Motorised moving faders are used throughout, while powerful snapshot automation helps both the sound designer and engineer to achieve their creative goals. An unlimited number of 'cues' are available to reset the desk, recalling not just the routing and EQ, but the complete desk configuration right down to a custom control layout for each scene or sound cue.

Familiarity and ease of use are also strong points of Broadway's design, combining traditional mixer hardware with the complete assignability required by such a flexible design.

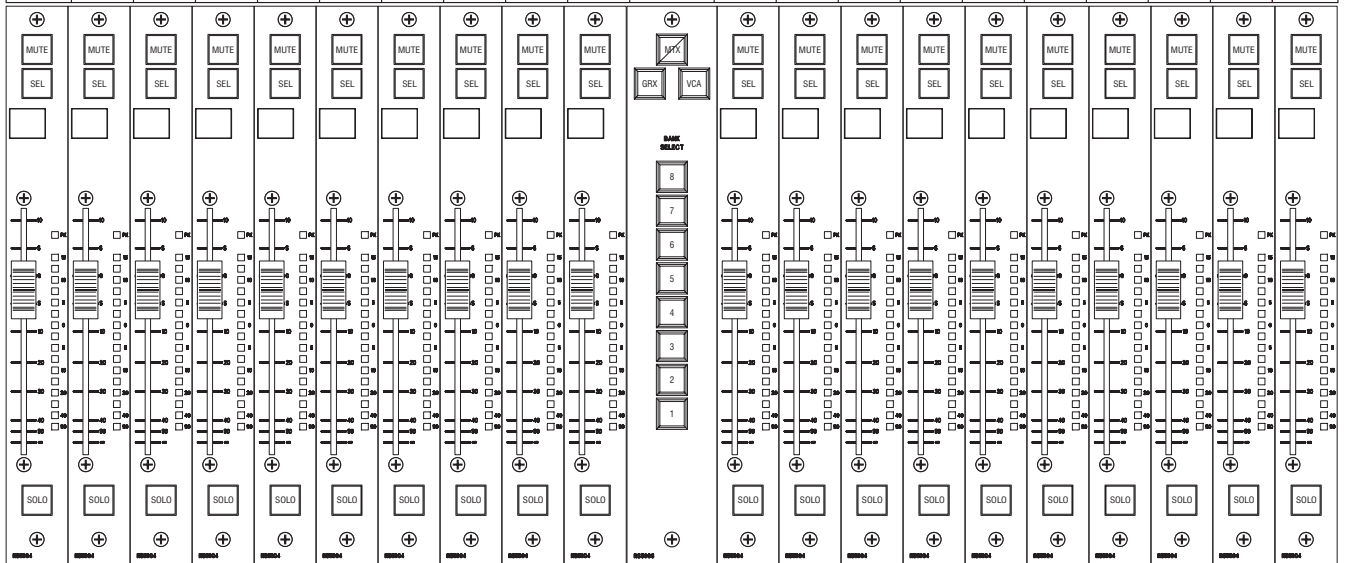
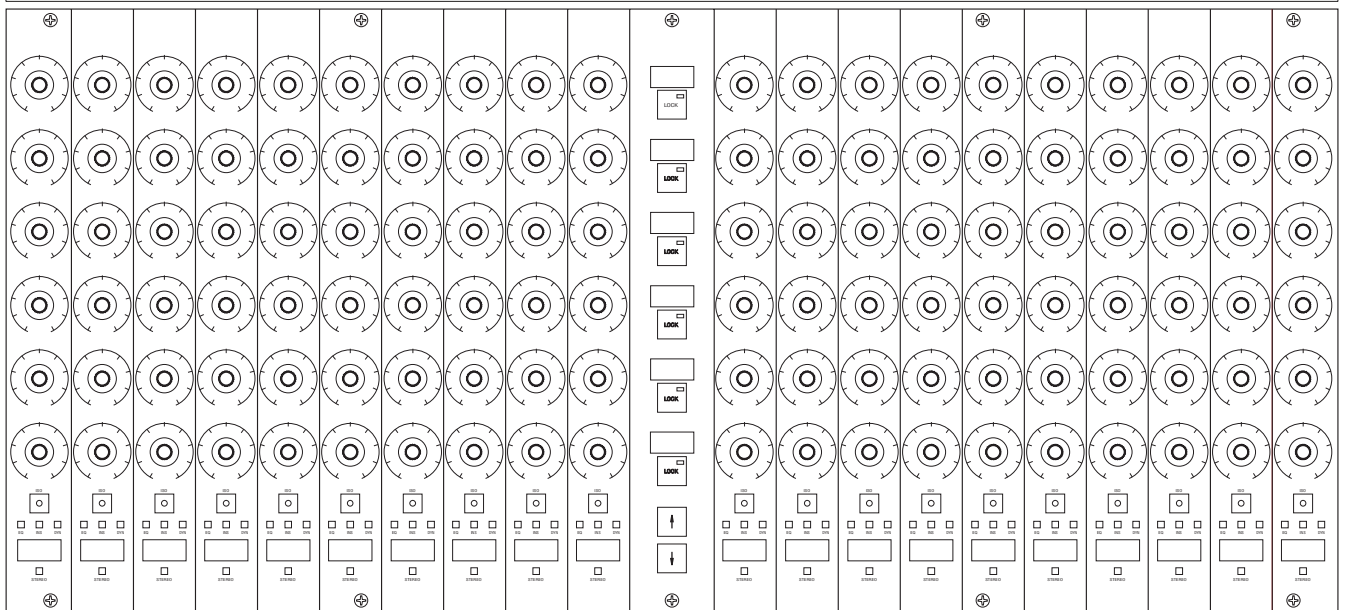
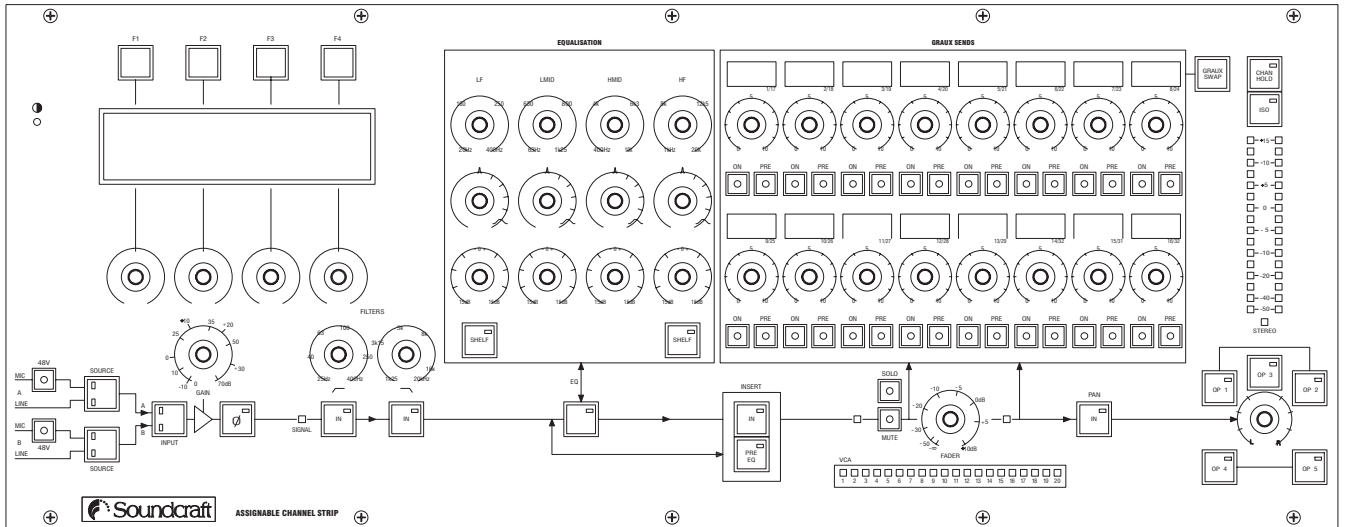

Input Control Surface

Though the Input section is normally used to control the levels, EQ, and routing of any 20 channels (or, using the BANKS, up to 160 channels), it may alternatively be used as the control surface for GrAux (Group / Aux) or Matrix outputs, enabling effects sends, foldback feeds and matrix mixes to be set up from a single control surface. A fourth mode enables the 20 faders on the Input surface to be used as 20 VCA master faders, giving the user access to all 20 VCA groups on a single surface.

Normally used in 'Input' mode, if the Input Control Surface is selected to 'GrAux mode', the 20 faders become the first 20 (or, on bank two, the last 12) GrAux master faders, and the six rows of encoders above become the sends from that GrAux INTO the appropriate matrices. Conversely, in Matrix mode, the 20 faders become the first 20 matrix sends, and the rotaries display and edit the contributions FROM the appropriate GrAuxes.

These modes, combined with the assignability of the console, allow the full audio path of the largest possible system (100+ into 32+5 into 40+) from input to matrix output, to be controlled from a single 600 x 800mm footprint Input Control Surface. This is the extreme, of course, and most users will doubtless choose to have more Input Surfaces to have greater visibility at any given time, but the flexibility to have all or just 20 channels visible depending on space, financial resources etc., allows the designer and producer of a show to work together to provide a desirable but affordable audio system. It might be appropriate to have, say, 80 physical faders during the production period, and just 20 when the show is up and running, thus reducing running costs once the design has settled down. The spare Input Surfaces could then be placed back into hire stock, and sent out with a different Master Surface for the next event.

ACS

The Assignable Channel Strip gives the operator a view of every function of a particular stereo or mono input channel, simply by pressing the SEL (ect) button on that channel. Dedicated controls are offered for every function, with the GrAux routing controlled by sixteen groups of controls which may be selected to represent GrAux 1-16 or 17-32. Each GrAux is identified by name by the four-digit displays above each control.

The four-band fully parametric EQ is accessed by dedicated rotary controls and displays; the EQ curve may be displayed in graphical form on the ACS LCD screen, where the exact EQ values are also displayed as digits. This LCD display is also used to identify the channel being affected by the ACS, and may be used in conjunction with the four multi-function rotary controls and switches for a variety of further facilities, such as setting up pan mode and Surface mode (**Input / GrAux / Matrix or VCA**).

Panning is provided between any combination of the five main busses, enabling true LCR, LCRS and quad + 1 images to be created. Dual meters are provided for use where channels are linked in stereo.

The ACS is normally located at the top of each Input Control Surface, but may be demounted and used remotely, connected to the main surface via a simple multiway cable. Since the currently selected channel may be changed on the ACS itself, and the majority of functions accessed from this small panel, this facility enables the user to "take the console into the auditorium", and set up level sends, Eq etc. whilst seated where it really matters - i.e. where the audience will be.

The channel under the control of the ACS may be isolated from the rest of the console so that it will not respond to changes caused by recalling new scenes, and may be 'locked' to prevent another operator from inadvertently selecting a different channel to act under ACS control. Locking the ACS in such a way will also permit ACS channel selection to be performed locally on the ACS itself.

As with the main body of the Input Surface, the ACS may be used to affect one of the GrAux mixes (either in stereo or mono). The sixteen rotary controls are used as 'Send' level controls with a master GrAux control and routing into the five main busses for subgrouping. In 'Matrix' mode the operation is reversed, with rotary controls feeding from a number of GrAux mixes to a single Matrix output.

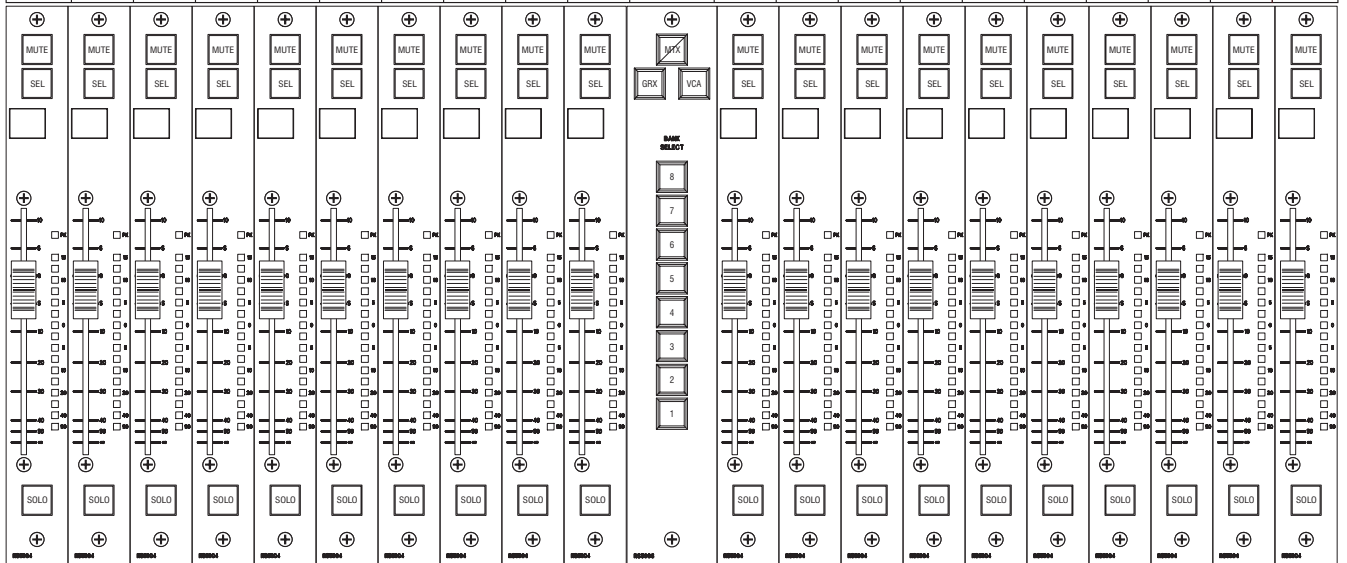
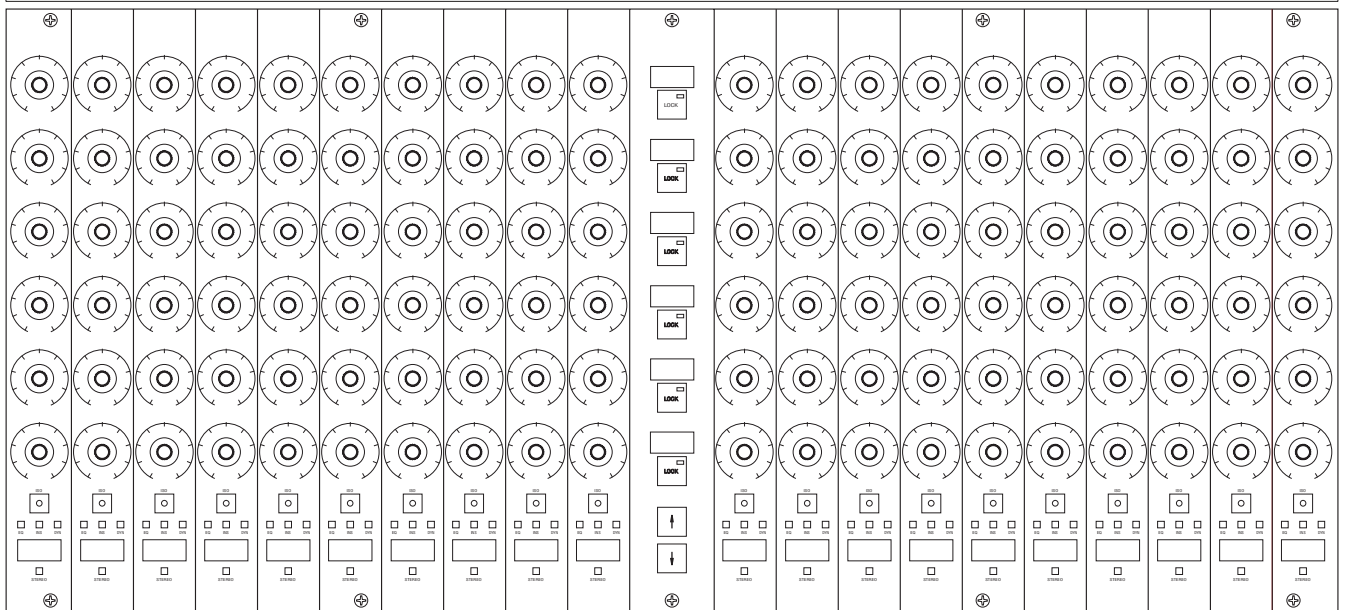
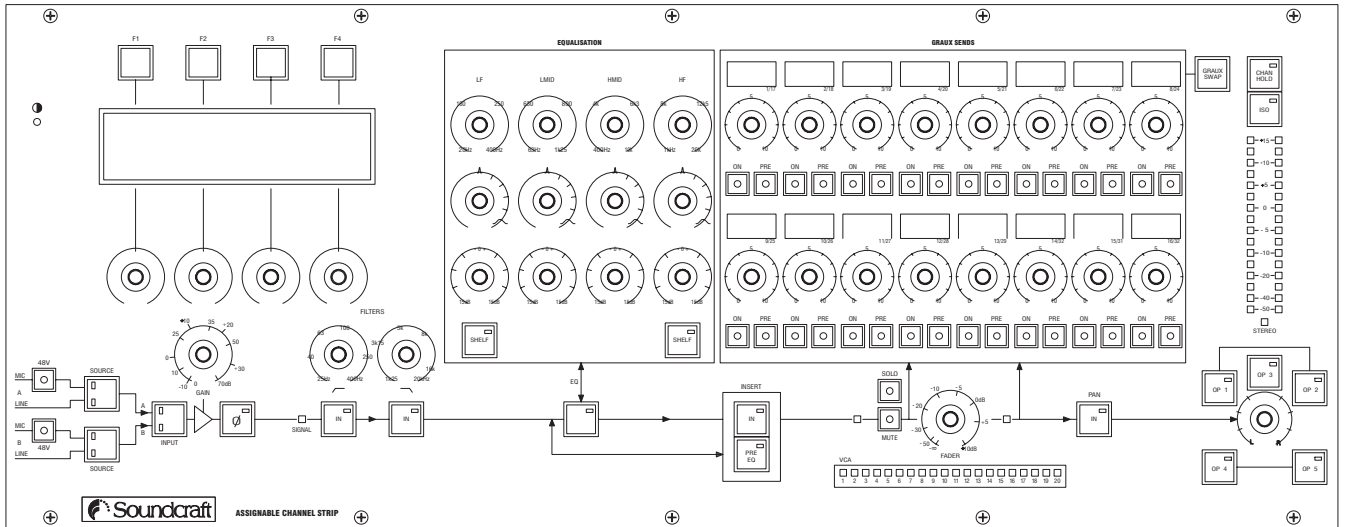

Input Control Surface (continued)

Encoder Panel

This section of the Input Control Surface contains six assignable rotary controls for each of the channels displayed. Indication of EQ, Insert Dynamics¹ and Stereo status are provided, as well as a four-digit display showing each channel's name or number.

Each row of controls above the fader acts on a single rotary function of the twenty visible inputs, such as GrAux sends, Eq parameters, or Input gain. The up and down arrows may be used to scroll the row through all available parameters, and the function of a particular row may be 'locked' to prevent its deselection.

Once a useful setup has been achieved, the eight Control Assignment buttons located on the Master surface are 8 user-programmable memory locations, into which the operator may store 8 favourite arrangements of the Input Surface Encoder Tray (i.e. 8 "Views" of chosen functions).

There is also an ISO(late) switch in this section, which will protect the appropriate channel from replayed sceneset automation data, effectively putting it into "manual" control.

Fader Tray

The fader tray is the last of the three component sections of the Input control surface. 20 modular faders are housed in the fader tray. These faders may, if necessary, be removed and/or replaced while the surface is running ("hot-plugged").

A SOLO button is located below each of the faders. Operating much as the solo on a conventional console, this will put the associated channel into PFL, AFL, SOLO-IN-PLACE or DIM SOLO-IN-PLACE. The primary metering for each channel is adjacent to the 100mm motorised fader, and is of the 16-led type.

SOLO switching may be momentary, intercancelling or additive.

The twin seven-segment LED's above each fader display the VCA to which the channel is currently assigned, or, if multiple VCAs have been assigned, the Primary VCA (i.e. the lowest-numbered) is shown, and a decimal point appears after the second numeric.

The SEL(ect) button is used to bring the relevant channel up onto the ACS. The MUTE button operates as on a conventional console, muting all sends from that channel (except to those GrAuxes which are configured as PRE-CUT).

¹ Although the integrated dynamic processing was not available at the time of writing, all surfaces have been designed to cope with the arrival of dynamics should the need arise.

Rear Panel

The rear panel of the input surface offers IEC mains input, the main power switch, voltage selection, fader and main power fuses, serial and barcode number labels, and the local connector to the ACS. Littlite connections are via 4-pin connectors.

There are also two "trays" which may be removed by the user when servicing or upgrading the surface. The power supply tray, once mated with the power distribution backplane inside the Surface, organises the routing of appropriate power to the relevant areas of the unit. The processor tray contains the main processing power of the surface, and contains all the interconnection ports required for network and system connection: C3, RS422, MIDI IN, OUT, THRU, and BNC network connections.

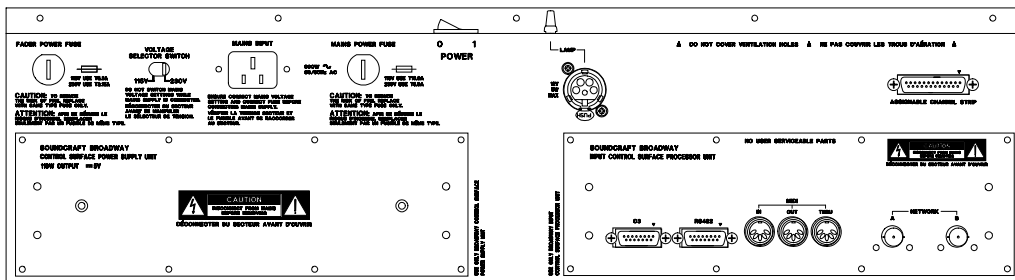

Master Control Surface

Meterbridge

This allows metering of all 32 GrAuxes, plus the main outputs. Via a MTX METER switch, it is also possible to swap the GRAUX meter section to meter the matrix outputs. The STEREO led below each pair of matrices denotes that the pair of GRAUX or MATRIX outputs is linked into stereo.

MASTER MUTE sets all MUTE switches on the system to MUTE ON.

LIVE locks out those functions which could be detrimental to a live performance, such as MASTER MUTE, talkback, solo in place and cue editing.

GrAux Fader tray

These controls allow access to the 32 GRAUX or MATRIX outputs (switchable GRAUX/MATRIX in banks of 16). The first 16 outputs are controlled via faders, and the last 16 are available on rotary encoders. Each output has a 4-character LED matrix display for name information, a MUTE button, a FUNC(tion) button, and a SOLO button. SOLO operates as on the input faders, except that they will not function in SOLO IN PLACE mode.

The FUNC button toggles the current function on or off - the function mode being selected via the four FUNC buttons to the left of the 16 GRAUX master faders. When in INS mode, for example, the FUNC button toggles the insert IN/OUT for its associated output.

Talkback and Monitoring functions are available from this panel. All master outputs, two external inputs plus the listen mic may be monitored, either with a self-cancelling or additive law, dependent upon the selection made. Talkback may be performed with an external system, a monitor desk, the audio racks and the comms loop. The user may set up talkback to desired GrAuxes and Matrices, via the use of the FUNC button in TB ASSN mode. TALK TO BUSS then arms all the relevant outputs for talkback.

In addition to the 16 GRAUX faders, there are four Master Output faders, controlling outputs 1, 2, 3, and 4/5. The last fader is paired to facilitate stereo surround level setting.

The 8 control assignment buttons allow the user to store 8 user-defined arrangements of the 6 assignable encoders on the input surfaces.

VCA Fader tray

This houses the 8 VCA faders. Of course, being a digital control system, the term "VCA" on the control surface is not strictly correct - these are master faders for "links" or "groups" of other faders, and the value of the master fader will be added to all slave faders. Any one of the faders may be assigned to GRAND MASTER status, and the value of this fader will be added to each of the SLAVE VCAs, above each of which the VCA led's will now be illuminated to denote slave status.

It is also possible to set any or all of the 8 VCA faders to generate outgoing MIDI continuous controller information, to be sent via any MIDI OUT port on the system (each unit on the network has its own set of MIDI ports).

An eight-character dot matrix display is housed above each of the 8 faders for name information, or to display the current MIDI continuous controller assigned to that fader. The SOLO and MUTE switches above the VCA faders will solo or mute all channels under the control of that fader.

To the right of the 8 VCA faders lies the Cross-Fader (X-FADE). This allows the user to create a smooth transition from the parameters of one cue to those of another. This transition may be automated, or performed manually by the user. Touching the X-FADEr during an automated crossfade will result in the user taking manual control of that fade.

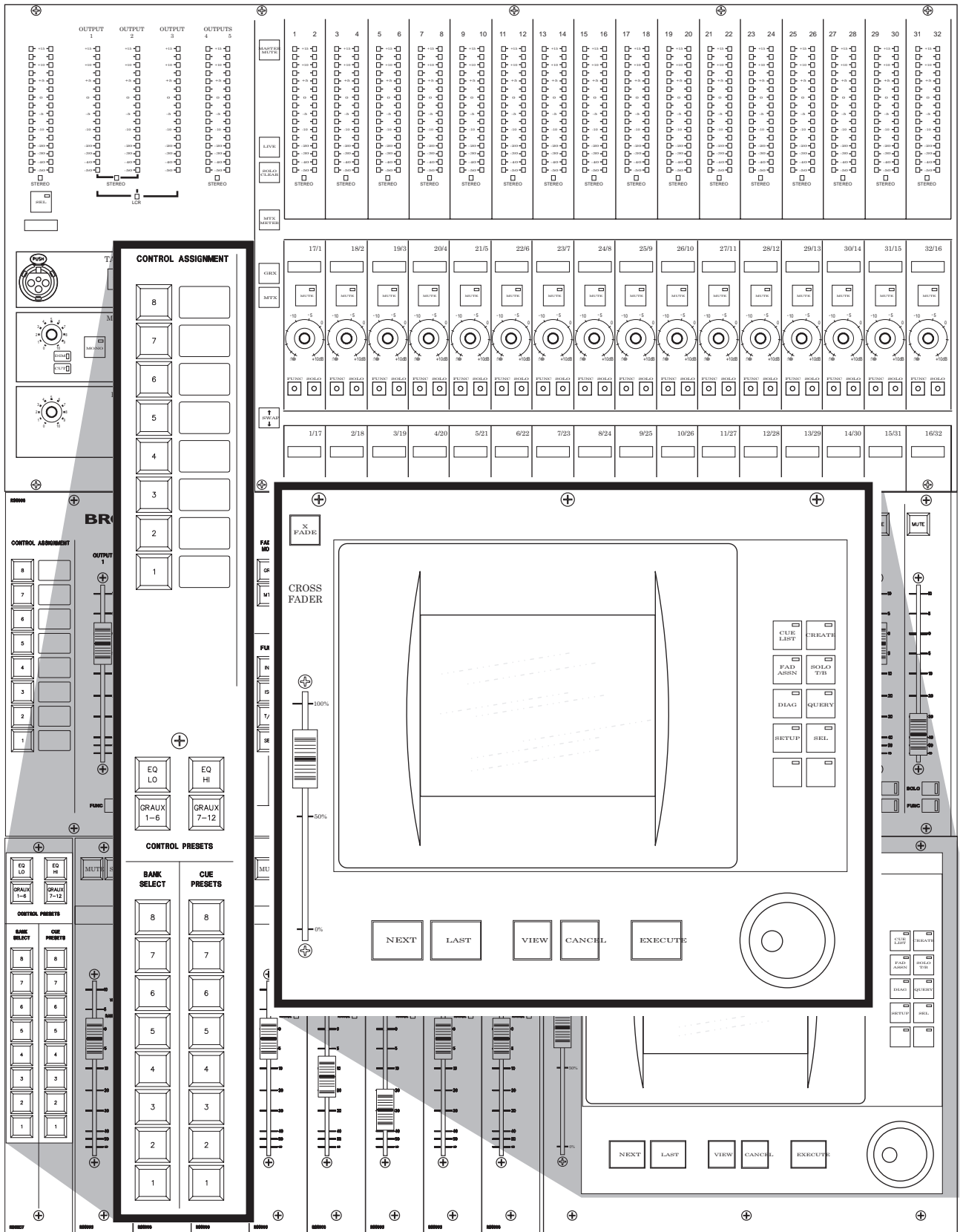

Master Control Surface (continued)

Control Presets

These operate in conjunction with the 8 user-definable CONTROL ASSIGNMENT switches, into which the settings on the 6 rows of rotary encoders on the Input Surfaces may be stored. These four switches offer 4 ROM presets of useful combinations - Eq Low (Freq, Q and gain of the first two bands of Eq), Eq High (Freq, Q and gain of the remaining two bands), GRAUX 1-6 and GRAUX 7-12.

Bank Select

These buttons mirror the function of the similar switches on the Input Surfaces, but affect ALL surfaces. It therefore has the same effect as pressing the appropriate BANK button on each of the Input Surfaces individually. Used in conjunction with careful channel to Bank assignments, these allow the operator to switch, for example, between sections of a choir or orchestra across the whole console, or perhaps to switch between several band setups in a festival environment.

Cue Presets

Each of these switches may be assigned to any one of the automation "Cues" (or "scenes"), for quick location to 8 pre-defined points in the show. These might be used to mark rehearsal points, or even to set 8 start points in the show programming for up to 8 different bands in one evening.

CPU Housing and Touchscreen

This is where the operator interfaces with the automation system. Although most of the functions on Broadway are intuitive and instigated by various combinations of "touch" and selection via faders and switches, there are some functions, such as naming of channels and general housekeeping utilities, which require a more conventional user interface. The screen is a CFL backlit unit, with a touch-sensitive 10x6 switch panel overlaid for touch functions. A QWERTY keyboard is presented on the touchscreen whenever necessary, facilitating quick naming of channels with no additional hardware.

There are 10 "Page" switches to the right of the screen, which assist in the speedy location of various pages within the software. As a rule, there are no "performance" functions (i.e. those to which access is critical to the live operation of a show) in the software pages which are not available through surface hardware. The touchscreen is therefore only used for system configuration and diagnostics, and as a last resort in the case of surface failures.

Main Cue Transport Controls

The jog wheel and the switches control the triggering of sequential cues, and movement through the cue list. The jog wheel includes a "press" switch, which allows a parameter to be selected and edited in one fluid movement.

Master Control Surface (continued)

Rear Panel

As on the input surface, the rear panel of the master surface offers IEC mains input, the main power switch, voltage selection, fader and main power fuses, and serial and barcode number labels.

Talkback and Monitoring audio is brought from the rack into the Master surface via a multipin connector.

Control Room (CRM) Outputs

LCR Control room monitor outputs are on Male XLR's ("CRM L, C, R"). By default, these carry the selection made on the front panel "MONITOR SOURCE", but SOLO will override these settings. A "MONITOR SAFE" function is included in the touchscreen, which prevents the SOLOs from overriding the Monitors if this is preferred.

The CRM outputs are configured by default as stereo, using only L + R outputs (with no output appearing in the centre), but will also support LCR mode for LCR monitoring.

PFL / AFL Outputs

3 stereo/mono AFL/PFL mixes appear on 5-pin Neutrik connectors. These are derived from appropriate software mixing of the 3 mono SOLO busses in the racks, and are at line level.

The Headphone connector is an amplified duplicate of the stereo "PFL(/AFL) 1" mix, as it appears at the rear of the Master surface.

Talkback

A talkback mic may be connected to the rear panel, which is paralleled with the mic input on the upper surface. Littlite connections are via 4-pin connectors. See Output Rack below for more information on Talkback.

Processing and PSU

Again, there are also two "trays" which may be removed by the user when servicing or upgrading the surface. The power supply tray organises the routing of appropriate power to the relevant areas of the unit. The processor tray contains the main processing area of the surface, and contains all the interconnection ports required for network and system connection: Printer port, RS232, C3, ESBUS, MIDI IN, OUT, THRU, BNC network connections, and LTC IN/OUT (XLR). An earthing point is also provided.

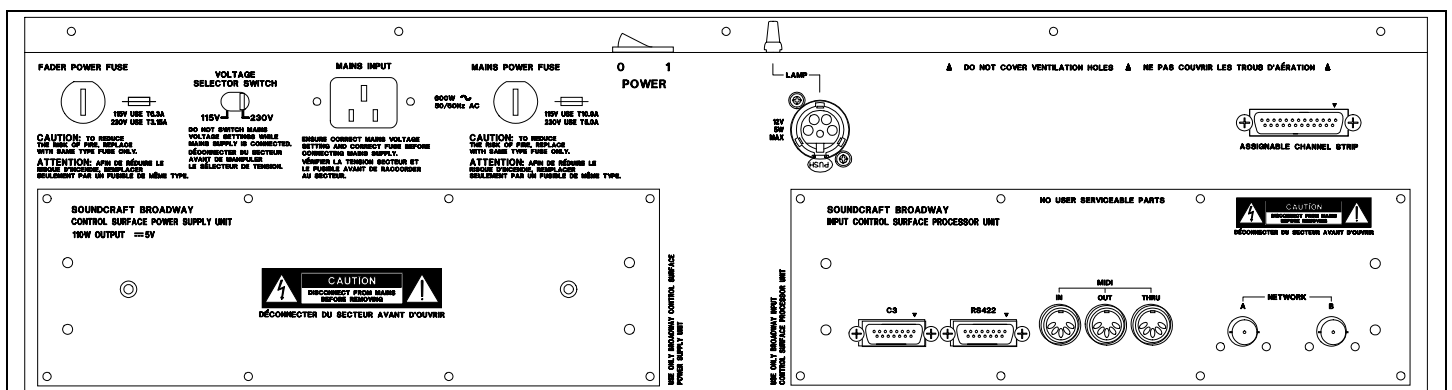

VCA Extender Surface

This surface is designed into the same frame as the Input surface. The fader tray contains 12 additional VCA faders at the same pitch as those on the Master surface, a second crossfade fader and NEXT / LAST / VIEW switches (linked to those on the Master Surface).

The middle section of this surface is left blank, allowing an open folder to be placed here containing rehearsal notes, scripts etc.. An embedded PC option will be available, which will replace this blank panel.

Above this, in the top section, the ACS is replaced with a second bank of 20 LED meters. Each pair of meters will be matched up with a 4-character dot-matrix display. This area allows the user to program a series of inputs to be metered scene by scene, such as Radio mics, certain important instruments, etc.. The names and meter assignments may be recalled with each scene.

Since the 20 meters are aligned with the input channels on an Input Control Surface, the VCA Extender meterbridge may be used to replace the ACS on an Input surface and thus offer sight-line metering for selected channels, if appropriately programmed.

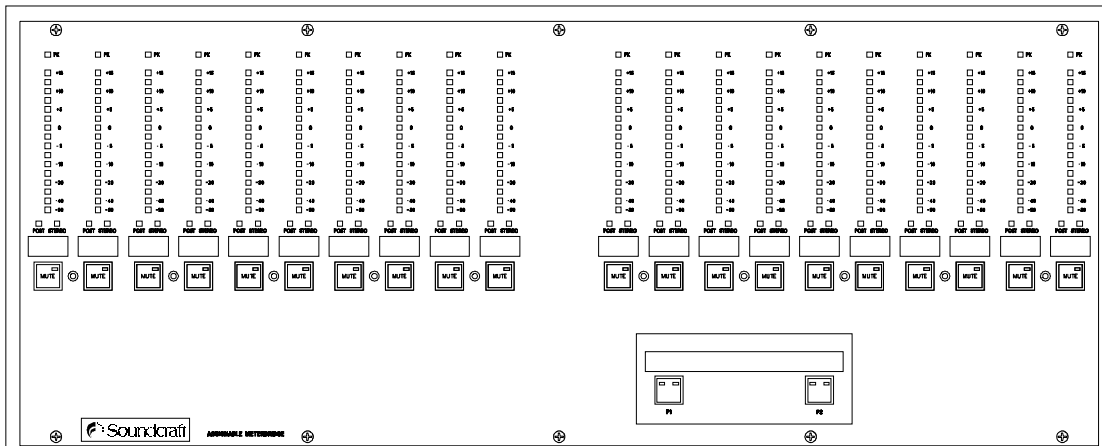

(CENTRE SECTION SCRIPT TRAY OMITTED)

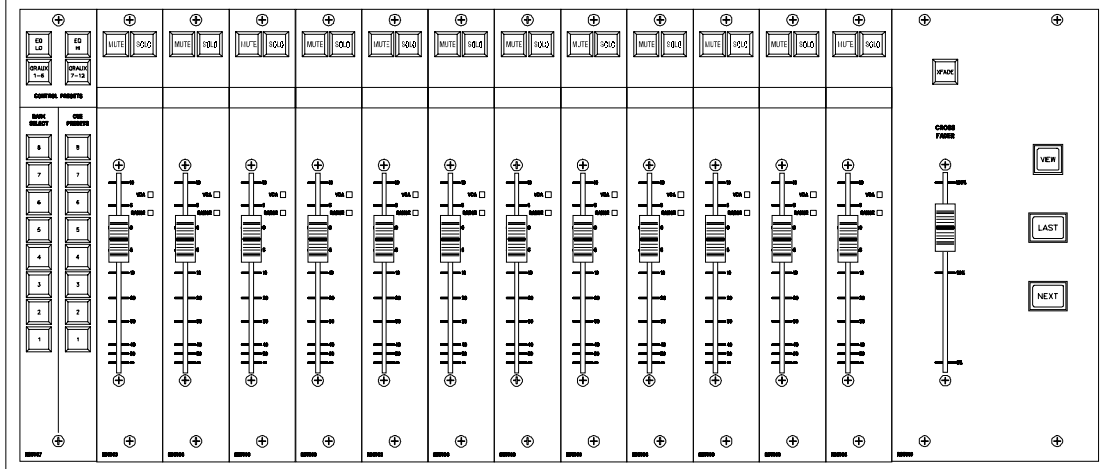

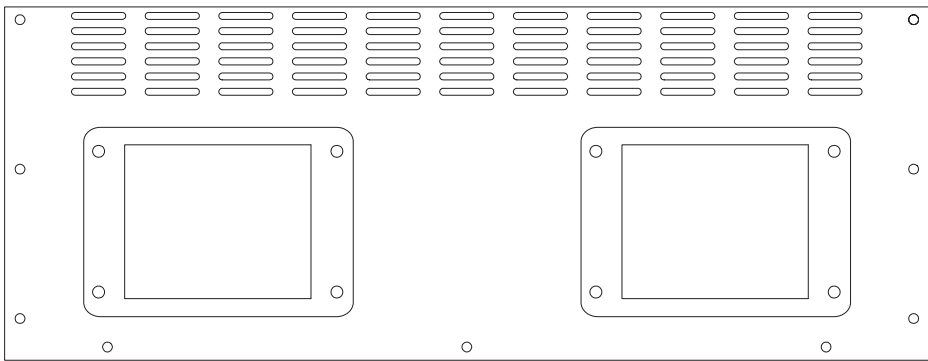
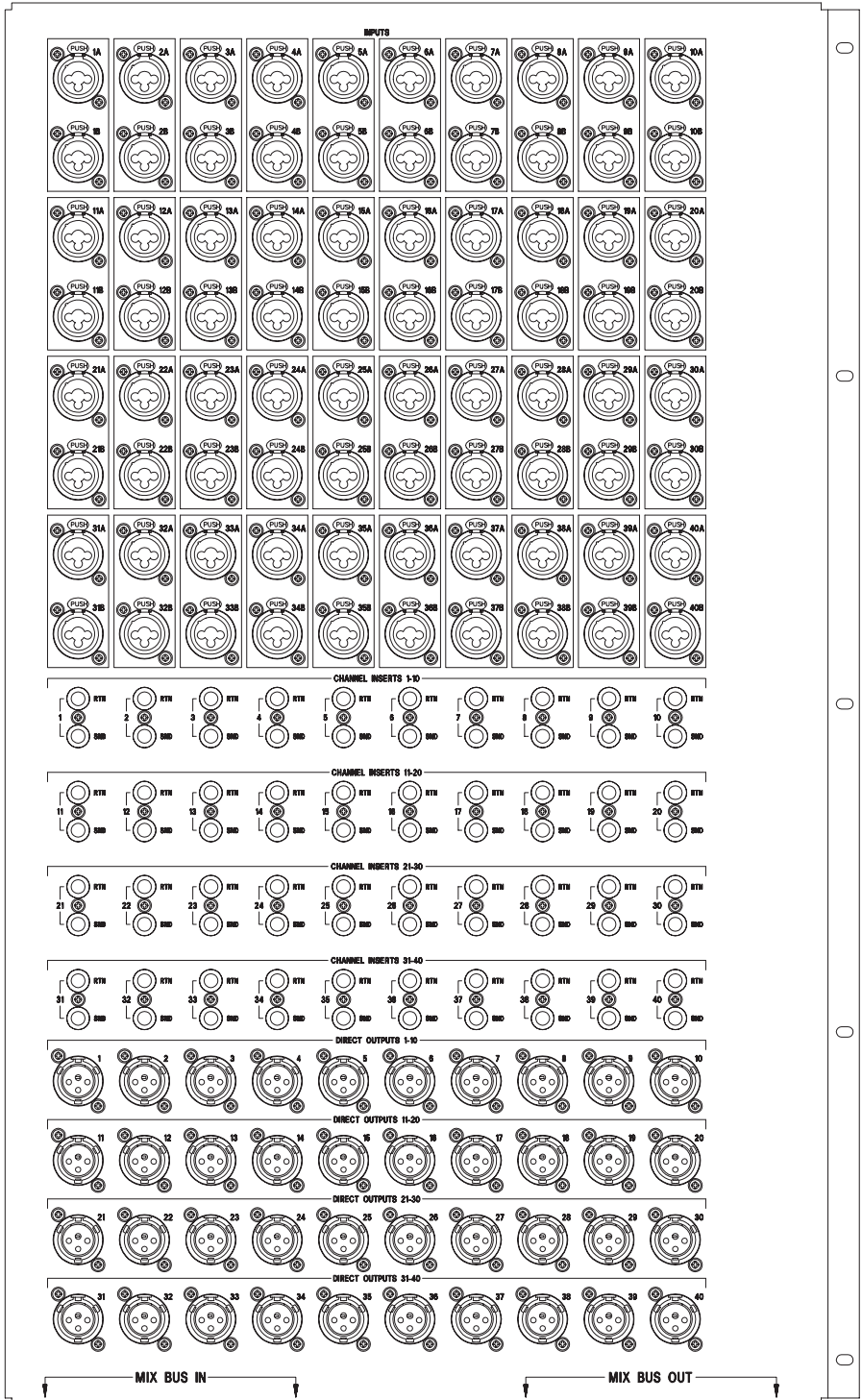

The Audio Racks

These 19U units contain all of the primary audio inputs and outputs for the system. The racks consist of a series of PCB cards, which mount firmly into a backplane board. The backplanes are then brought out to the rear panel via a number of wireforms. The type of physical connector on the rear panel is not therefore restricted to the standard XLR / 1/4" Jack combination.

Input Audio Rack

Input Card

The input card contains all the necessary electronics for two input stages (so 20 cards in an Input Rack gives the 40 inputs).

Each of these channels has "A" and "B" input selection ("A" and "B" cannot operate simultaneously), and a gain control which is ranged with the MIC / LINE switch. Note that MIC / LINE does NOT select inputs, but simply the gain, so the full range of gain may be applied to the XLR or 1/4" jack inputs.

Thanks to the A and B inputs, a 60 input system actually has 120 input connections, but may only use 60 of these simultaneously. Since all other audio parameters are under the control of the automation along with A/B switching, the A/B switch is no longer just an input selector for similar channel settings, but can be used for two completely different sources in different scenes.

It would be possible, for example, to use the 60 A inputs for one band in a festival, then with a single button press switch to the 60 B inputs for a second band, with entirely new EQ, routing, naming etc.. Alternatively, a guitarist might have two inputs to the desk for two different guitars, but only use one at any given time - scenes could be set up to accommodate these requirements using just a single A/B channel strip.

EQ Card

2 of Broadway's four-band fully parametric EQ's are located on each of these 4U Eurocards, which use low-distortion digitally-controlled attenuators under C3 control to produce accurate, repeatable tonal adjustment. The two extreme bands may be switched to shelving EQ.

The electronics for the insert point (which may be taken pre or post EQ) are also located on this card.

Buffer Card

These 10-channel cards are used to provide the direct outputs and connections to the Mix Routing and Bussing card (see below). Each input rack has 4 Buffer cards.

Mix Bus Card

The Mix Bus card provides variable level routing from 10 inputs to 10 busses. These are effectively large crosspoint matrices, feeding ultimately into the Output Audio Rack. 16 Mix Bus cards (each with their associated Buffer card) are required to route 40 channels to 40 busses. All internal audio busses are balanced to minimise noise and crosstalk, with mix bus routing being controlled by high-grade digitally-controlled attenuators (DCAs).

Rear Panel

The rear connector panel for the racks is fitted as standard with Combination XLR/1/4" jacks on the inputs, balanced 1/4" jack connectors on the inserts and balanced XLRs for the direct outputs. Although the XLR/Combi connectors must always be fitted, additional connectors in parallel may be specified by the customer.

PSU and Network Interface

The PSU in the racks is a dual redundant design - that is, should one of the two units fail, the other is capable of running the whole rack until the failed supply can be replaced.

Fitted to the front of the integral power supply is the network card, which allows communication between the input rack, control surfaces and any other devices on the Broadway network. BNC connectors are provided for dual parallel Ethernet connection, as well as 5-pin MIDI connectors and 15-pin D-types for future applications.

The PSU assembly also contains fans for the PSU itself, and for the cards in the rack above.

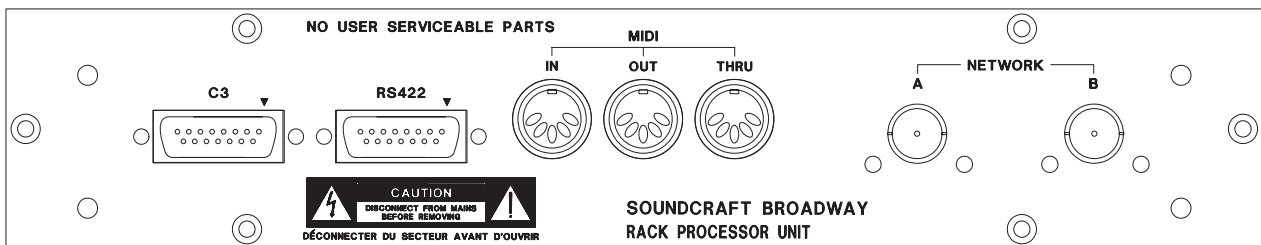

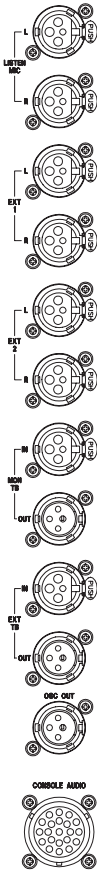
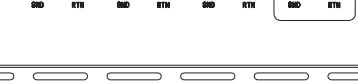
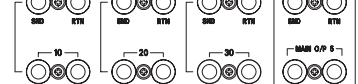
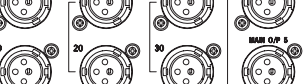
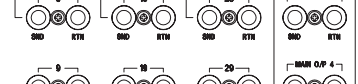
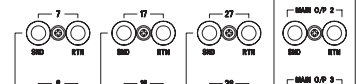
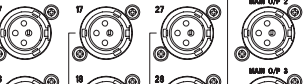
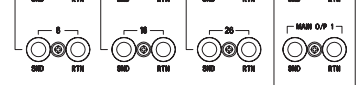
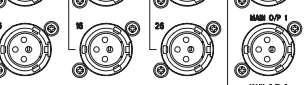
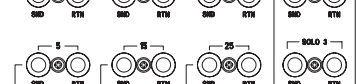
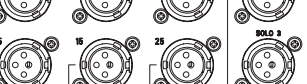
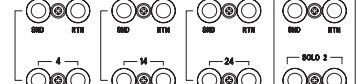
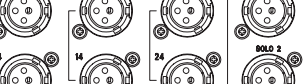
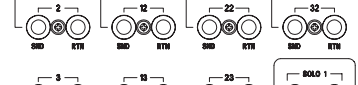
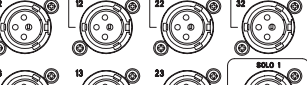
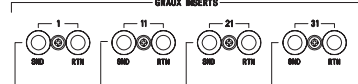
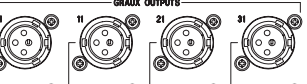
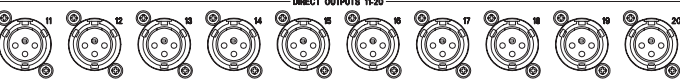
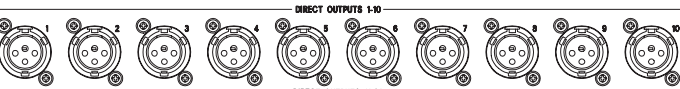
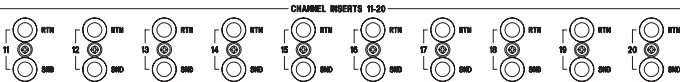
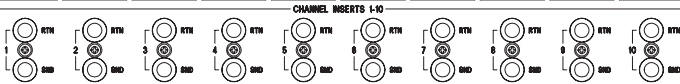
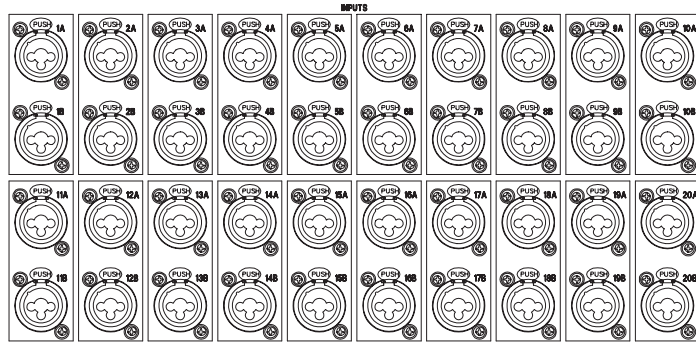

MIX BUS IN

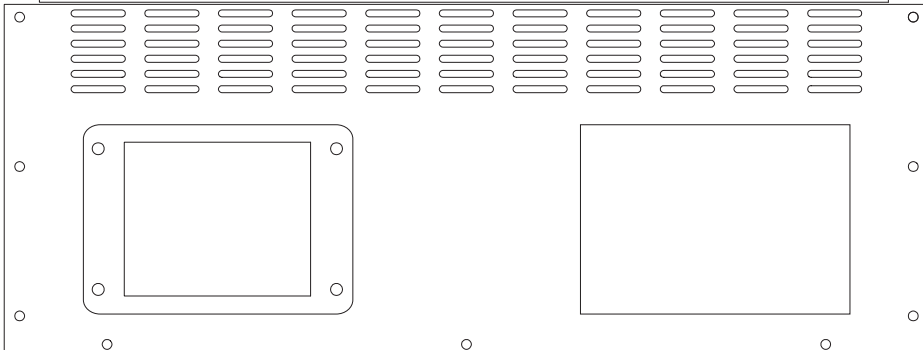

Output Audio Rack

Configuration Options

The Output Rack for any Broadway system is supplied in one of four formats. All formats include the 5 Main Outputs, and the 32 GrAux Outputs, but the remaining options are:

- 0 Inputs, 0 Matrix Outputs
- 20 Inputs, 0 Matrix Outputs
- 0 Inputs, 20 Matrix Outputs
- 20 Inputs, 20 Matrix Outputs (multiway output connectors must be fitted to this option)

Input Card

(See above) The Input card contains all the necessary electronics for two inputs, with the exception of the EQ components. 10 of these cards may be fitted into the Master rack to give 20 inputs in addition to those in the Input audio rack.

EQ Card

(See above for details) 10 standard EQ cards are fitted to the Master rack (with the 20 input option only), to complement the 20 inputs.

Buffer Card

Two Buffer cards provide the direct outputs and Mix Bus sources for the twenty inputs.

Mix Bus Card

(See above) Eight Mix Bus card are used to route the twenty inputs housed in this rack to the 40 busses.

Additional cards may be added to mix the 40 system busses to the optional matrix. Broadway may be fitted with a 20- or 40-output matrix. The feeds onto the matrix outputs are derived from Main Outputs 1-5 and the 32 GrAux outputs.

Output Card

8 Quint Output cards are fitted to the Master rack.

These carry the 40 busses, offering master level control and balanced outputs for the 32 GrAux outputs, and the 5 Main outputs and the three Solo busses. Insert points under software control are available for all these busses (including the SOLOs).

Rear Panel

The rear connector panel for the Master Audio Rack is fitted with XLR's on the outputs and balanced 1/4" Jack connectors on the inserts, unless the customer specifies otherwise.

Certain talkback elements of the system appear on the rear of the Output rack - namely EXTERNAL and MONITOR DESK IN and OUT. Talkback is also available from the Master Surface to the output audio rack and vice versa. The Output rack I/O for this talkback appears on the front of the rack, behind one of the hinged panels.

Network Interface

(See Input Rack above)

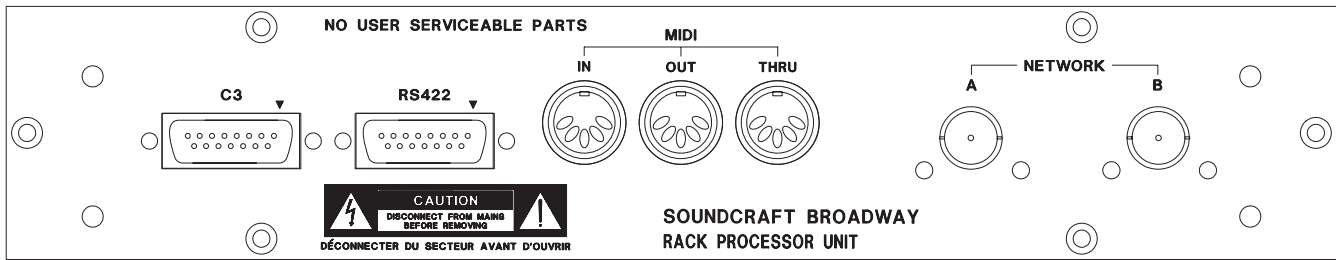

Software

Touchscreen Displays

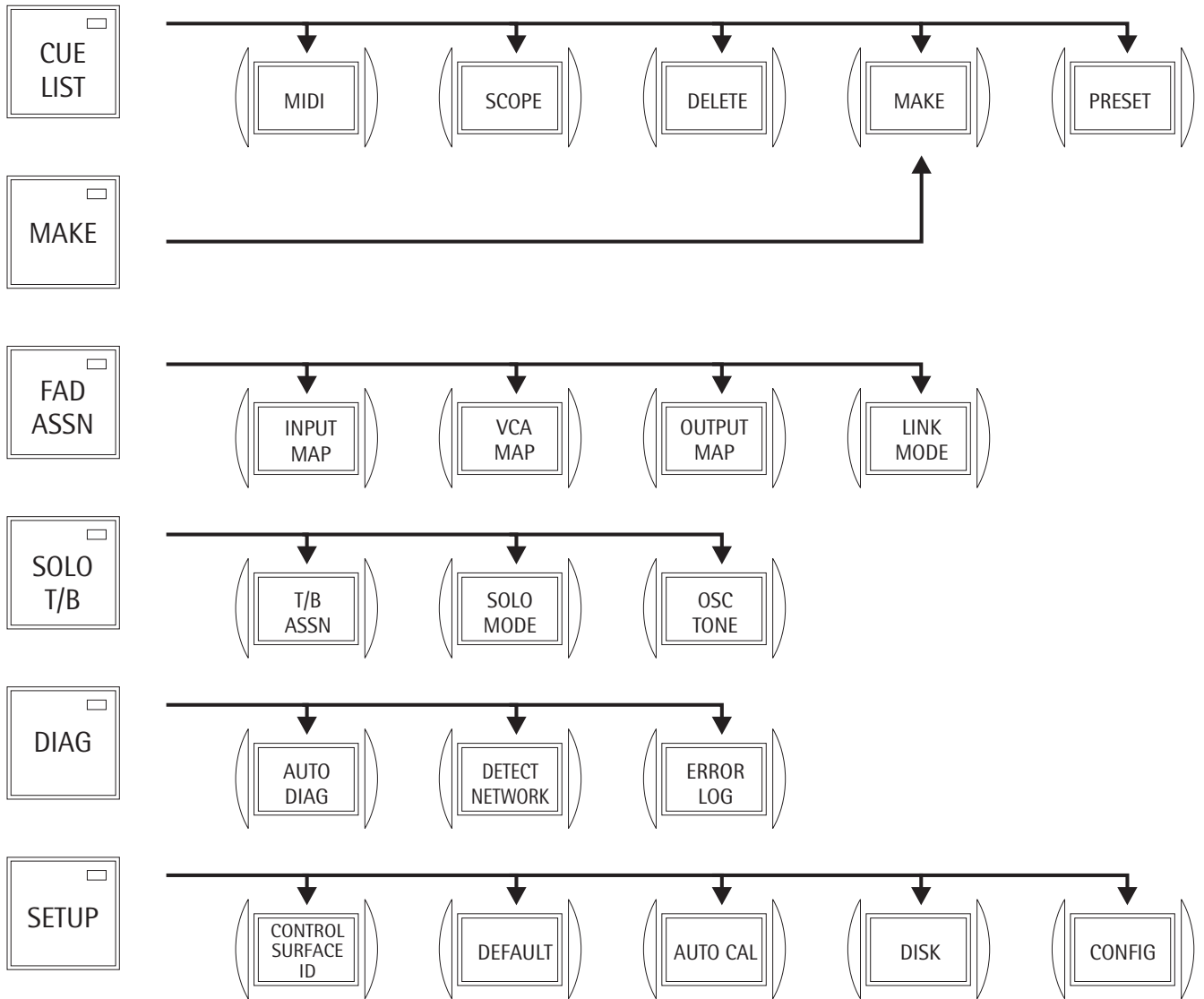

FRONT
PANEL
SWITCHES

TOUCHSCREEN DISPLAYS

Software

There is a fundamental concept which is the key to understanding Broadway fader assignments - the fact that PHYSICAL INPUTS (i.e. rack elements) are named, and NOT the faders. Inputs are NAMED, then NAMES are assigned to FADERS. So, when assigning faders, the console will ask the user to select a fader, then give a list of all available NAMES. Every input will either have a user-defined name, or its name will default to being simply its rack and input number.

Once a fader has been chosen (selected on the touchscreen), pressing the NAME column in the fader information will bring up a list of all possible names for that channel (i.e. all names available on the system). The Jog wheel will scroll through these, until it is pressed down, at which point the currently-selected name is put onto that fader. If no user names have been defined, the list of names will simply be a list of all the inputs, sorted numerically.

If the inputs have been named in advance (see above), then the process of assigning inputs to faders is as simple as selecting a name from a list, and the physical location of the input is no longer an issue (as the console "knows" this information already).

All audio parameters on Broadway, including switches, rotaries, faders and text displays, are included in the snapshot automation system. "View" parameters, such as the current BANK, SEL settings, solo's etc. are not stored or recalled. VCA master fader positions are stored on a per-cue basis, as are the assignments of slave faders to VCAs.

VCAs

VCA master faders are included in the automation system, but may be "scoped" out, effectively leaving them in manual mode. The idea is that the relative balance between a group of faders (perhaps a group of radio microphones) can be set up on the input faders, and these may all be "moved" together, retaining the relative balance, via a single fader - the VCA master. The slaves will not move physically, but the dB value of the VCA will be added in software to the visible value of the slave fader.

The dB offset applied via the VCA master will almost certainly be different from day to day. When a scene is recalled, therefore, the input faders are returned to their stored values (as long as their "scope" is switched in), and the appropriate VCA master fader values are added to the gain for each of the inputs slaved to that VCA.

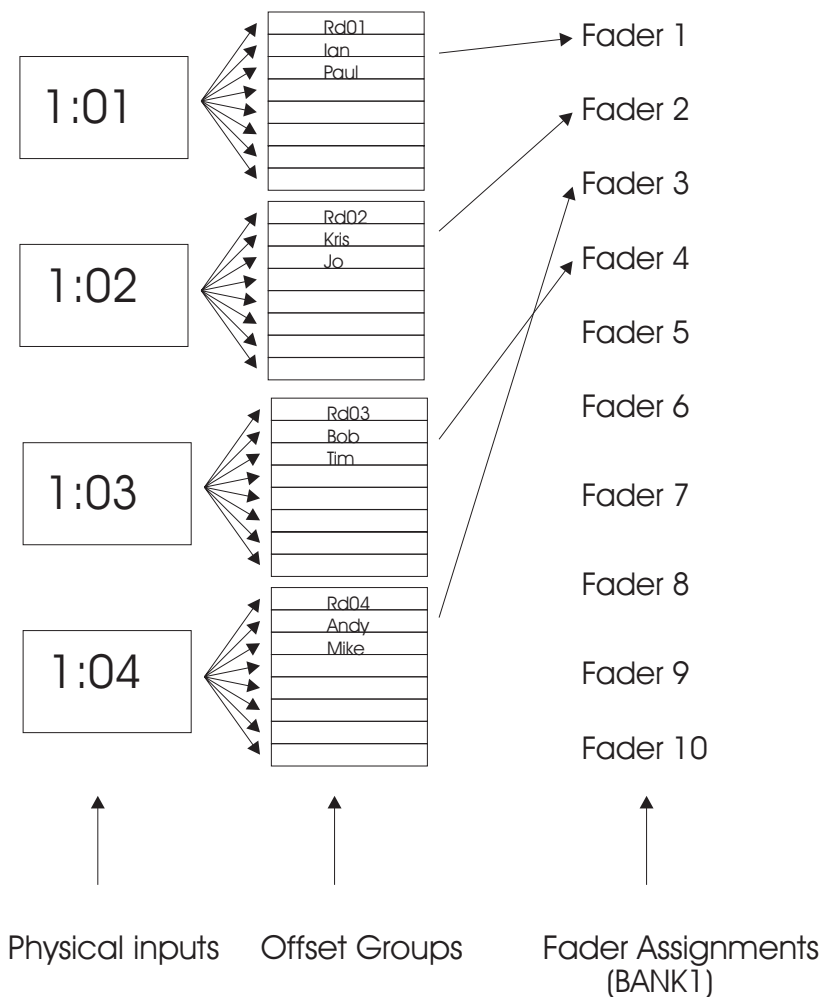

CUE 1

Note that the 8 "Offset Group" names for each physical input do not change from cue to cue, but that the offset group used in each cue can change.

See "Offset Groups" below for a description to the Offset functions in Broadway.

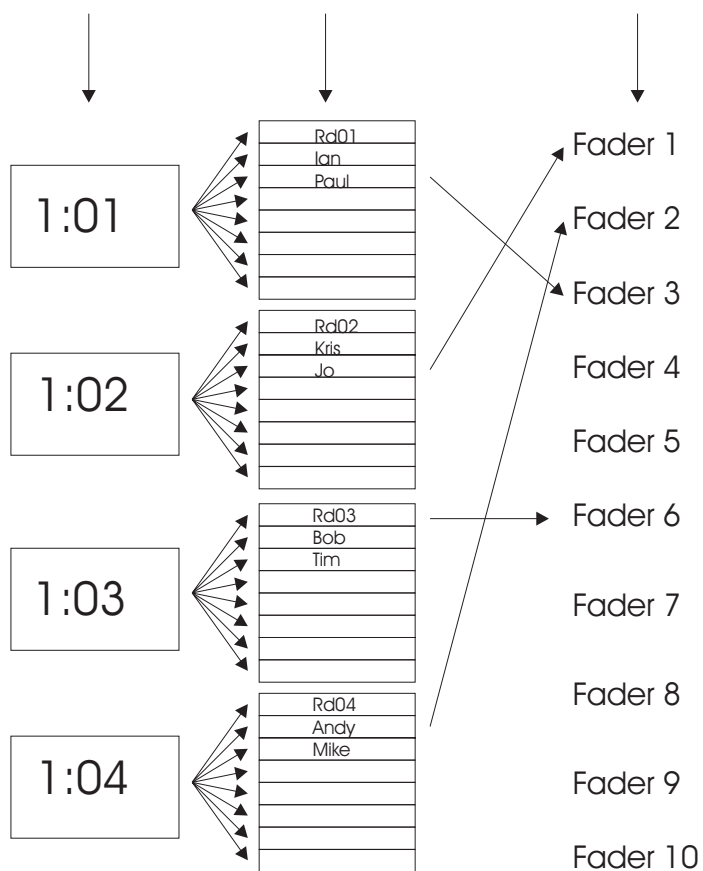

CUE 2

Offset Groups

Live sound is highly unpredictable. Actors, musicians, and even sometimes the audience can vary from night to night to such a degree that stored automation data can become at best inappropriate, and at worst completely wrong.

With a conventional analogue console, there is no problem. If a mic slips, for example, the operator of a traditional desk can simply make an adjustment to a gain, and that change will not be removed until another adjustment is made to the same control.

Unfortunately, this is not the case with an automated console. Taking the example above, the operator of Broadway could easily change a gain setting on the appropriate channel, and the sound would be corrected. As soon as the next cue was selected, however, the stored value for the gain on the affected channel (which, in all likelihood is the same as it was in the previous console) will be recalled to the console, thus "undoing" the change which was so carefully made.

Broadway deals with this problem by using "Offset Groups". The idea is that, during run-time (i.e. whenever "Live" mode is selected), any changes made to the parameters on any channel will be stored as *offsets* to the stored data, rather than *absolute* values. The changes will be related to the name of the channel which was edited, and any further instances of that name from scene to scene will result in the appropriate offset being added to the stored parameters when the cue is recalled.

Recall ue 1

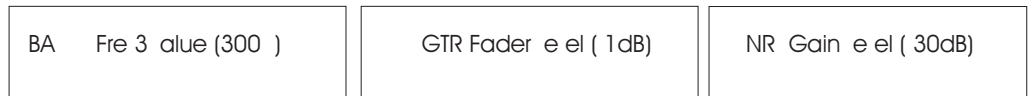

Make changes

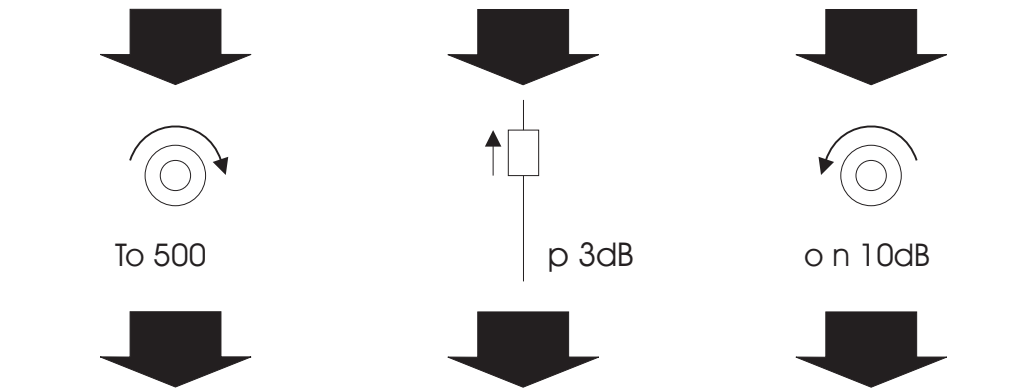

changes tored
Against Names

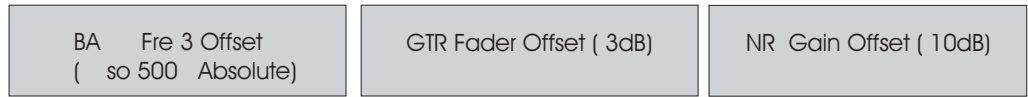

Recall ue 2

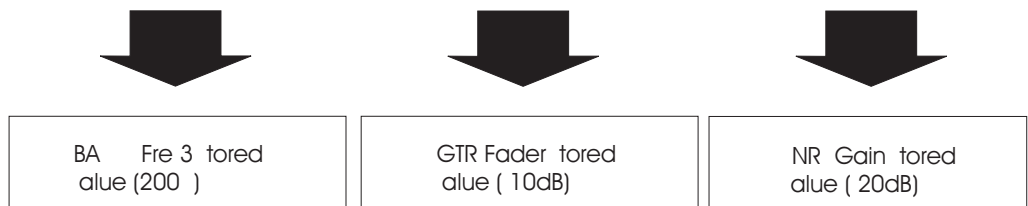

Add Offsets to
to red ata

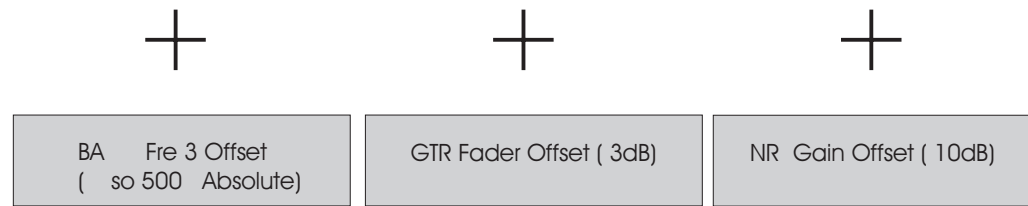

Resulting alues
ent to esk

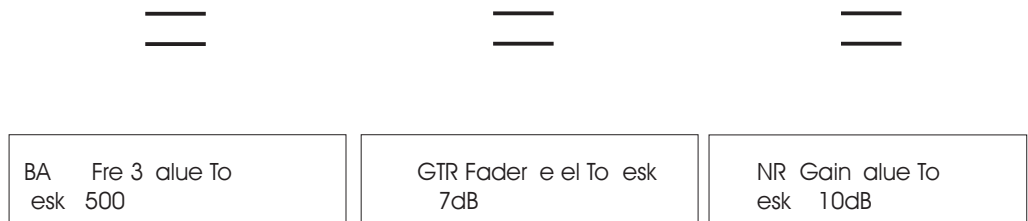

The only exception to the offset rule is in the EQ section - since it makes no sense to "offset" frequencies and widths, EQ parameters are treated as absolute values, which will supersede any stored data for that name. The console effectively "isolates" any EQ parameters which are manually adjusted, removing them from the automation. Remember that this isolation is unique to THAT PARAMETER on THAT CHANNEL for THAT NAME (offset group). It will not affect any other parameters or channels.

At the end of the cue list (i.e. at the end of the performance), the system will ask whether the user wishes to write the offset values permanently to disk (on a per-name basis), or to lose them with power-down. The former is required when the changes are considered general improvements, the latter when the changes have been to counteract some kind of unusual problem or circumstance.

There is, however, a further complication to all of this. There is every possibility that a radio microphone will be used by more than one person during the course of the performance, and the offsets for one user may not be appropriate for the next. To counteract this, Broadway allows up to *eight* names per physical rack input. It is therefore possible to cater for up to eight users of a radio mic (each with their own offsets to stored data), or even eight different instances of the first user.

The latter case would be particularly useful if dramatic changes in costume changed the characteristics of the sound such that different input channel configurations were required for each costume. A mask, for example, or a large hat could have a serious effect on tonal characteristics. The user would not necessarily want input adjustments for one costume to affect other costumes later on.

The solution is to assign a new name for the same input for each different "style" required. BOB, BOBH and BOBM might cater for BOB on his own, Bob with a hat on, and Bob in a mask. Each name would automatically have its own offset group, and therefore any changes made would be associated with the correct settings.

The Offset system is much easier to use than it is to explain. To the uninitiated, the system is completely transparent - the fact that every input has a unique name by default means that all inputs have unique offset groups, and any changes made once the "LIVE" switch is pressed will be stored as offsets against the name, and used to affect upcoming automation data. Changes will appear to "stay" from scene to scene, thus rendering the console similar in operation to a conventional analogue desk.

Show Storage

Broadway generates three file types when a show is saved to disk. These deal with the console automation, operating preferences and external device information.

.PRJ files contain a number of Cues. Each cue includes snapshot storage of all audio functions, all control positions and layouts, VCA assignments and layouts, and control information for external devices (MIDI).

Each Cue may be recalled in one of two ways:

- Manually (single button-press, instant change to snapshot, all messages sent immediately)
- Automatically (momentary SMPTE timecode trigger or MIDI program change)

Transitions between cues may be instant, timed cross-fades or manual cross-fades as required.

.ENV files contain a designer or engineer's preferred working environment; global preference commands, action confirmation and security access to saved files. Designers and engineers can then move this information from one Broadway to another, regardless of any show parameters stored, giving them a familiar working environment even with an unknown automation file.

.SYX files are MIDI Sysex dumps, which contain information for external processors, synthesisers, or any other MIDI Sysex-compatible device - this ensures that similar processors follow show design even if replaced or hired in.

Touchscreen Software

The Master control surface Touchscreen is used for system setup. The areas covered include:

Cue List:	MIDI, Scope, Delete, Create, Preset
Fader Assign:	Input Map, VCA Map, Output Map, Link Mode
Solo/Talkback:	TB Assign, Solo Mode, Osc Tone
Diagnostics:	Auto Diagnostics, Detect Network, Error Log
Setup:	Control Surface ID, Default, Auto Calibration, Disk, Configuration

MIDI

Each of the "nodes" on the Broadway network (i.e. each Surface or Rack) has its own MIDI IN / OUT and THRU, which are independently addressable. That is, if a MIDI command is to be sent when a Cue is recalled, the user may select not only the type of MIDI event (PRG CHG, NOTE ON/OFF, Continuous Controllers on VCA Faders), but also the MIDI OUT port from which the message is to be sent.

This system greatly increases the number of available MIDI channels, since **16 x X** MIDI channels are available, where "X" is the number of Network units.

External PC compatibility

Whilst the Broadway system has been designed to be fully operational from the single touchscreen and the ACS display, there will be applications where a larger, clearer screen would be beneficial. Broadway will support any number of standard IBM² compatible PC's on the network, which will be fully conversant with the whole system, and will have access to all parameters³.

Each of these may be configured (using passwords) to have access to limited areas of the system for various operator types. A radio mic operator, for example, might have access via a local PC to a graphic of the rear panel of the audio racks, and, should it be necessary to repatch a channel, or hand the microphone to another performer, the new name may be entered on the screen, and the name will simultaneously be updated on the FOH console surface. Another operator might have access to all real-time functions, but no access to sceneset automation.

² IBM is a registered trademark - all rights acknowledged

³ At the time of writing, the Broadway PC software was not complete. The information presented here is subject to change

It is planned that the PC, if fitted with a modem, will allow remote "dial-in" access to the Broadway system. Future software developments could, for example, allow the designer to check that the system is still as it was left after the production period. Alternatively, the system might dial up the PA company main office computer with show reports on a regular basis.

Installing and Moving the System

Installation

POWER REQUIREMENTS:

- 1 x Rack 800W
- 1 x Surface 150W

Audio racks may be sited on-stage to minimise cabling

Most audio electronics are on plug-in Eurocards

Simple rack interconnection using multipins

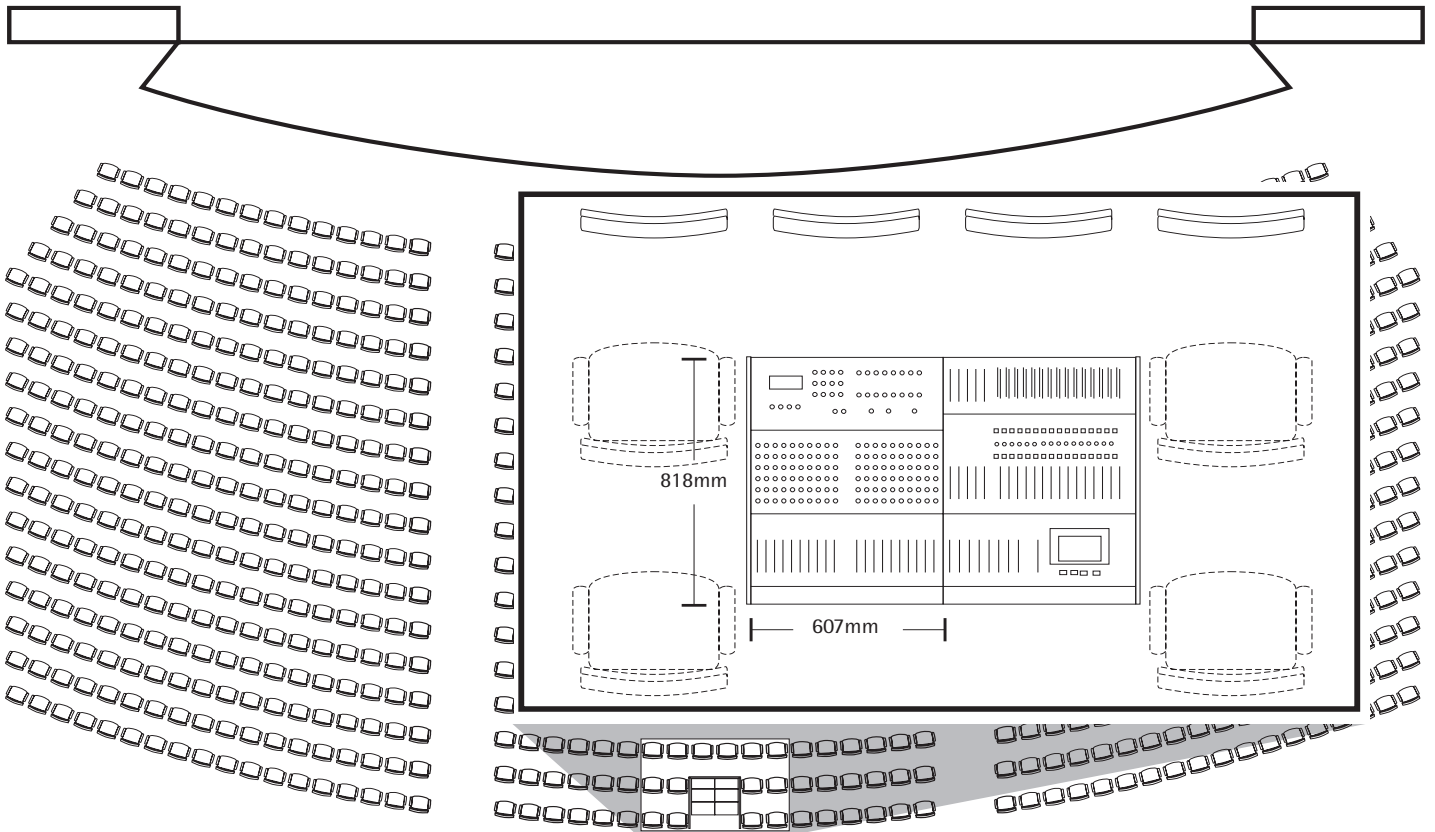
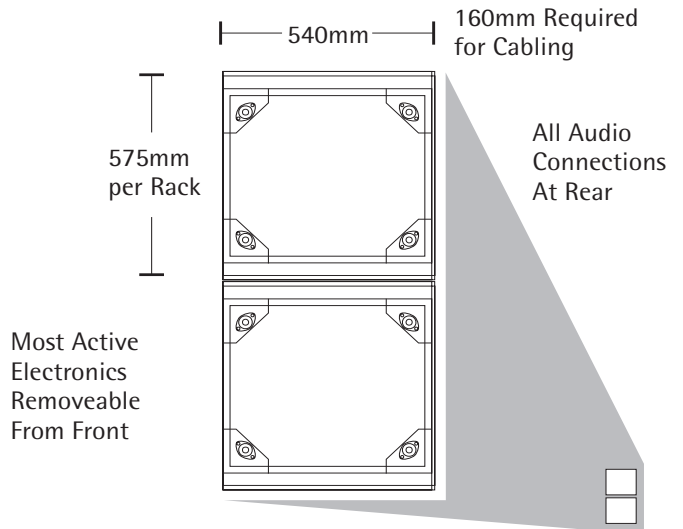

Control Surface built up from 600mm-wide sections (1 seat per section)

Limited depth requires only two rows of average seating

Simple, low profile cabling from control surface to racks

Outboard equipment may be sited remotely

Transportation

Flightcase and Transit Details

Audio racks are permanently housed in suspended 22U frames
 Control surfaces are housed and shipped in anti-static padded trunks
 All flightcases are finished in strong 12mm ABS/birch ply composite
 Handles are provided for lifting in any orientation

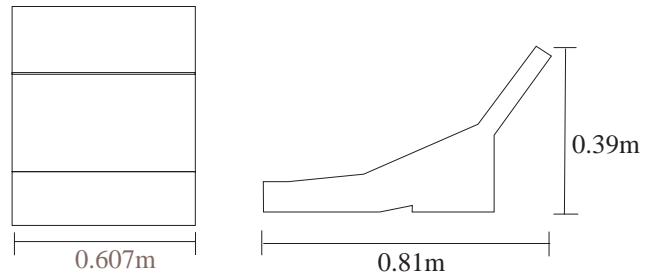

Input/Master Control Surface Flightcase

Dual Input Control Surface Flightcase

Input/Output Audio Rack Flightcase

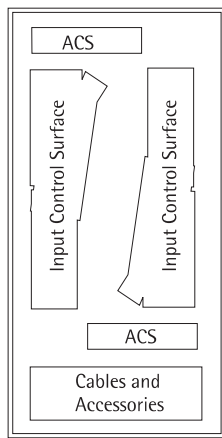
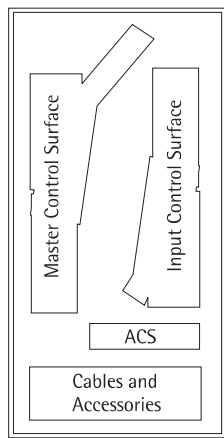
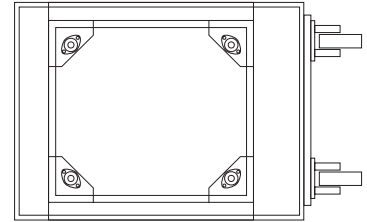

8 Calibrated Suspension Mounts

25mm Rigid Steel Chassis

22U x 19" Rack Allows Future Expansion

Removeable Front and Rear Lids for Clear Access

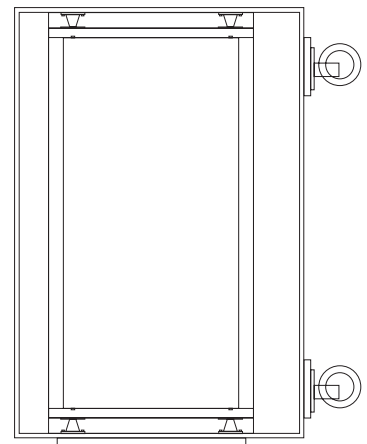
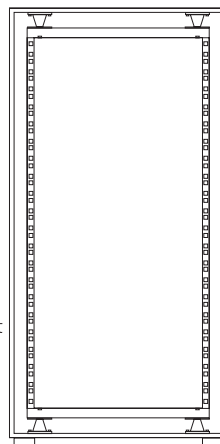

RACK CASES

SURFACE CASES

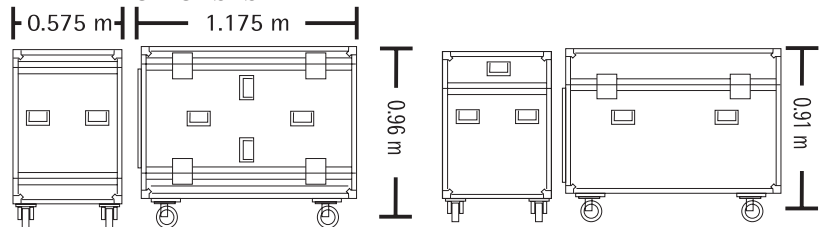

Efficient packing in UK, European and US Trailers
 All flightcases may ship upright or on wheels
 All flightcases share a similar footprint

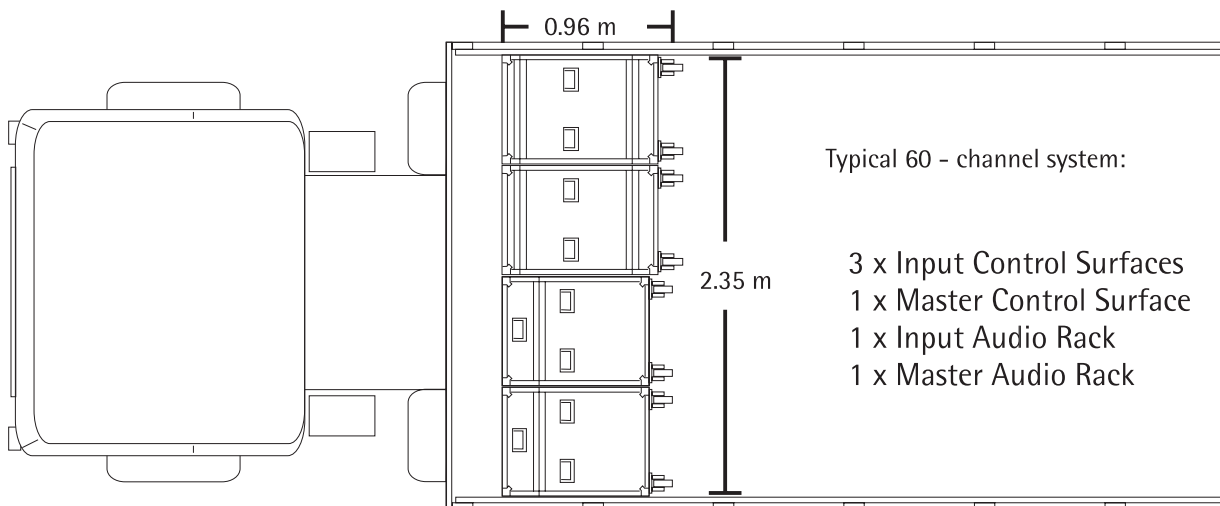

Internal Rack Dimensions (without flightcase)

RACK DIMENSIONS

