SOUNDCRAFT CPS1000

Console Power Supply

User and Technical Manual

For your own safety and to avoid invalidation of the warranty all text marked with these Warning Symbols should be read carefully.



IMPORTANT: please read this manual carefully before connecting your Soundcraft console power supply to the mains for the first time.



© Soundcraft Electronics Ltd. 1995

All rights reserved

Part No. ZM0101 - 01

Information in this manual is subject to change without notice and does not represent a commitment on the part of the vendor. Soundcraft Electronics Ltd. shall not be liable for any loss or damage whatsoever arising from the use of information or any error contained in this manual.

No part of this manual may be reproduced, stored in a retrieval system, or transmitted, in any form or by any means, electronic, electrical, mechanical, optical, chemical, including photocopying and recording, for any purpose without the express written permission of Soundcraft Electronics Ltd.

It is recommended that all maintenance and service on the product should be carried out by Soundcraft Electronics Ltd. or its authorised agents. Soundcraft Electronics Ltd. cannot accept any liability whatsoever for any loss or damage caused by service, maintenance or repair by unauthorised personnel.

Soundcraft Electronics Ltd.
Cranborne House
Cranborne Industrial Estate
Cranborne Road
Potters Bar
Herts.
EN6 3JN
England

Tel: 01707 665000
Fax: 01707 660482

Contents

| | |
|---|-----------|
| Introduction | 1 |
| <i>Mains Voltage Selection</i> | <i>2</i> |
| <i>Operating Voltage Range</i> | <i>4</i> |
| <i>Replacing Mains Fuse</i> | <i>4</i> |
| | |
| Recommendations for Installation | 5 |
| <i>Dimensions</i> | <i>8</i> |
| | |
| Technical Specification | 9 |
| | |
| Circuit Description | 11 |
| <i>Circuit Diagrams</i> | <i>16</i> |
| | |
| Servicing | 27 |
| <i>Servicing Components</i> | <i>28</i> |
| <i>Connector Configurations</i> | <i>30</i> |
| <i>PCB Layouts</i> | <i>31</i> |
| | |
| Spare Parts List | 35 |
| | |
| Warranty | 43 |

Introduction

Introduction



WARNING: THIS APPARATUS MUST BE EARTHED

The CPS1000 is a linear power supply which, like other linear supplies, produces DC voltages by rectifying, smoothing and regulating AC voltages from the secondary windings of a mains transformer. Soundcraft mixing consoles employ a number of dc voltage supply levels in their operation and these are all provided at the output of each supply unit.

In regulating these voltages there is considerable heat generated, the dissipation of which is achieved through a substantial heat sink on each side of the unit. An electronically controlled fan is incorporated which draws air over the heatsinks to provide adequate heat dissipation for the regulators and reduce the outer case temperature.

The CPS1000 is designed for installation in a 19" rack unit, occupying 4U of rack height. Refer to the section "RECOMMENDATIONS FOR INSTALLATION" on Page 5.

LED indication is provided on the front panel to show operation of the regulating circuits, and to monitor the mains supply voltage.

MAINS VOLTAGE SELECTION.

Special attention should be paid to the following information:



Do not change the voltage setting without first turning the unit off and unplugging the mains lead. Ensure that the cover plate over the mains voltage selection switches is replaced after correct voltage selection has been made and that the cover plate is positioned to show the correct mains voltage.

This unit is capable of operating over a wide range of mains voltages by means of a comprehensive set of selectable voltage settings. It is important to ensure that the correct voltage setting has been selected for the level of local mains voltage supply, for safe, uninterrupted operation of the unit.

There are three mains voltage selection switches behind a cover plate on the front of the unit. Voltage selection is achieved by moving the switches using a screwdriver blade, into the correct positions, as shown by the symbols marked on the front panel. In this way the unit is set up for operation at one of the following ranges of mains supply:

| NOMINAL VOLTAGE | OPERATING VOLTAGE RANGE |
|-----------------|-------------------------|
| <i>Vrms AC</i> | <i>Vrms AC</i> |
| 240 UK | 216-264 |
| 220 EUROPE | 198-242 |
| 200 | 180-220 |
| 120 | 108-132 |
| 110 USA | 99-121 |
| 100 | 90-110 |
| 90 | 81-99 |

Mains Voltage Selector Positions

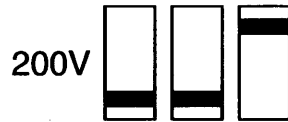
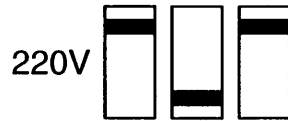
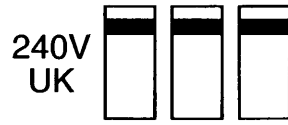

OPERATING VOLTAGE RANGE

It is very important to use the correct mains voltage selection. A wide operating range of mains voltages is provided to enable the unit to function down to only 81 Vrms on the mains supply. This facility is incorporated to overcome the problems that some power supplies have with internal regulation when operating from a poorly regulated mains supply.



Do not operate the PSU with a consistently high (above nominal) reading on the mains meter. Operation with the mains higher than +10% may cause serious damage

The mains meter is essentially a peak-reading device, as it is the peak value of the mains waveform which is the most important factor in providing the correct mains voltage to the power supply. For this reason, and because with long power cables it is common for the mains waveform to become distorted, the indication of the meter may not agree with readings taken with the usual types of quasi-RMS reading testmeter.



Note that the meter measures the voltage actually available at the PSU, and therefore will indicate any voltage drop on mains supply wiring.

REPLACING MAINS FUSE.

In the event of incorrect switching of the mains voltage selectors, a mains power surge or underrated fuse value, the mains fuse in the front panel will blow and the CPS1000 will not function. Switch the ON/OFF switch to the OFF position. Check the fuse and replace if necessary; also check that the voltage selection is correct for the mains supply level before switching the unit ON again.



To avoid risk of fire replace only with the correct value fuse, as indicated on the unit.

In the event of repeated failure of the mains fuse consult the Soundcraft dealer from where the unit was purchased.



This unit contains no user serviceable parts. Refer all servicing to a qualified service engineer, through the appropriate Soundcraft dealer.



Note that the cooling fan is thermostatically controlled and will therefore not switch on when the unit is cool, for instance when initially turned on or with no load connected.

Recommendations for Installation of the CPS 1000

FOR UK USERS ONLY



IMPORTANT WARNING
THIS APPLIANCE MUST BE EARTHED

The wires in the mains lead are coloured in accordance with the following code:

| | |
|-------------------|---------|
| Green and Yellow: | Earth |
| Blue: | Neutral |
| Brown: | Live |

As the colours of the wires in the mains lead may not correspond with the coloured markings identifying the terminals in your plug, proceed as follows:

- The wire which is coloured Green and Yellow must be connected to the terminal in the plug which is marked with the letter E or by the earth symbol.
- The wire which is coloured Blue must be connected to the terminal in the plug which is marked with the letter N or coloured Black.
- The wire which is coloured Brown must be connected to the terminal in the plug which is marked with the letter L or coloured Red.

Recommendations for Installation

The CPS1000 power supply is provided with front panel fixing holes for 19" rack-mounting and will occupy 4U of rack space. Rear support should be provided when fitted in a 19" rack.



The CPS1000 is a heavy unit (34kg, 78lb) and should be regarded as a two-man lift. Take suitable precautions when lifting

As with any power supply that contains a large mains-voltage transformer, it is preferable to provide a degree of physical isolation of the unit from other electronic equipment, particularly that which carries low level audio signals, to avoid any possible hum pick-up. For this reason the unit is used with a long (6.5 metres) output cable to enable it to be positioned away from the mixing console.

For the same reason, when rack-mounting it is preferable to avoid locating the unit adjacent to signal processing equipment.

It should be noted that if a complete rack containing a CPS1000 unit is to be operated from a different mains supply level, then the unit should be withdrawn from the rack in order to reselect the mains voltage setting, at the same time as resetting any other equipment.

The other important consideration when rack-mounting the unit is the need for natural convection of air over the case and an unrestricted air flow through the unit. Note that air is drawn in at the rear of the unit and expelled through the front panel.

Good ventilation **BELOW** the unit, in the floor or back of the rack, and similarly **ABOVE** the unit, at the top of the rack, will ensure a path for continuous air flow.

Other equipment in the rack which is known **NOT** to produce a significant amount of heat should be mounted **BELOW** the unit. Equipment that also relies on good air flow within the rack (ie. most power amplifiers and other power supplies) should be given due consideration and some space should be provided between such units and between these and the CPS1000 unit. Forced convection, by means of a fan-tray, may be desirable in this situation.



The CPS1000 will operate as a free-standing unit without requiring any special cooling arrangement, but should not be allowed to be accidentally or deliberately covered over in any way.



Do not operate the unit with the top cover removed as this disrupts the forced airflow through the heatsinks.



The filter on the cooling fan must be inspected regularly and cleaned if necessary to maintain good airflow through the unit. This will be particularly important if the unit is used in a dusty environment.

Finally, some consideration should be given to the earthing arrangement of the system at the centre of which are the console and the CPS1000 (and any other Soundcraft power supply units). The console chassis is earthed, through the mains earth, via the power supply. When rack-mounting the CPS1000 (and any other Soundcraft power supply units) care should be taken to avoid any possible 'ground loops' in the system which would introduce audible hum to otherwise clean audio signals. Ground loops may occur where signal processing equipment, patched to the console, has its signal earth commoned to the equipment chassis. The ground loop is formed if this chassis and the power supply chassis are in electrical contact through the fixing rails they share in the rack. To avoid this situation, standard isolating washers may be employed when fixing the power supply (or supplies) or any other unit into the rack.



W A R N I N G : THIS APPARATUS MUST BE EARTHED. Under no circumstances should the mains earth be disconnected from the CPS1000 power supply unit.

GENERAL

As with all electrical/electronic equipment care should be taken when handling this unit. Avoid general mishandling and do not drop. Avoid storage and operation in dusty locations and do not expose to corrosive atmospheres.



To avoid risk of fire do not expose this unit to rain or moisture.

Retain all packaging for transportation in the event of the unit requiring servicing. Retain this manual safely, along with all other relevant documents.

For touring/mobile transportation it is advisable to install the CPS1000 in a flight case to provide mechanical protection. Refer to your Soundcraft dealer for a suitable case.

Where the CPS1000 is enclosed in a touring case, provision must be made for adequate ventilation to the rear of the unit to ensure unrestricted supply of air for the cooling fan.



Use only the high-current mains lead supplied, not the more common 5A type supplied with other equipment.

The PSU is intended for use with the high-current version of the 16-way DC output lead, which is identified by a RED sleeve at one end. Although the normal lead would usually be satisfactory, the extra voltage drop may affect console operation in some marginal circumstances.



Note that the cooling fan is thermostatically controlled and will therefore not be operating when the unit is first switched on, or when no load is connected.

Dimensions

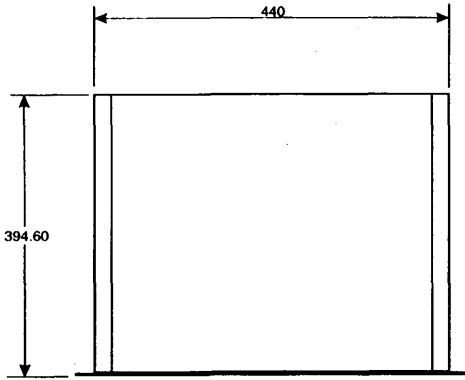

Top View

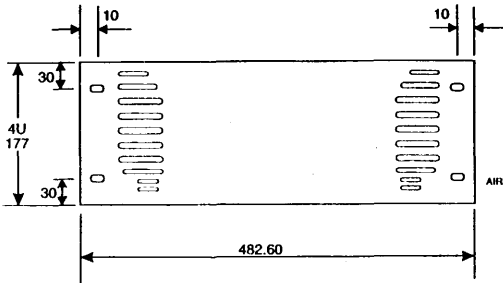

Front View

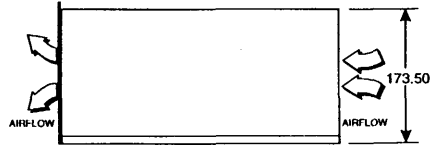

Side View

CPS1000 DIMENSIONS

All dimensions in millimeters

Technical Specification

Technical Specification

MAINS INPUT VOLTAGE RANGE:

240/220/200/120/110/100/90 V AC +/-10% @ 50/60Hz

RATED INPUT POWER (Max):

980 WATTS

MAINS FUSE RATING:

Use T6.3A/250V (slow-blow) for 240-200V

Use T10A/250V (slow-blow) for 120-90V

OUTPUTS

| DC. VOLTAGE RAIL | MAX. OUTPUT CURRENT |
|------------------|---------------------|
| +17V (A) | 6.00 AMPS |
| -17V (A) | 6.00 AMPS |
| +17V (B) | 6.00 AMPS |
| -17V (B) | 6.00 AMPS |
| +48V | 0.35 AMPS |
| +24V (A) | 3.00 AMPS |
| +24V (B) | 1.50 AMPS |
| +7.5V | 2.2 AMPS |
| -7.5V | 2.2 AMPS |
| +15V | 2.5 AMPS |



All voltage and current measurements are to be taken at the console-end of the power supply cable.

OPERATING TEMPERATURE RANGE (Ambient):

-10 TO +40°C.

HUMIDITY:

Similar unit tested at 0-90% RH non-condensing +/-5% Relative Humidity at 40 °C for 16 hours. Load switched between 20% and 100% at regular 30 minute intervals.

OVERALL DIMENSIONS:

| | | |
|---------|--------------------|----------------|
| HEIGHT: | | 177.00mm. (4U) |
| WIDTH: | Chassis | 440.00mm. |
| | Front panel | 482.60mm. |
| DEPTH: | (excl. connectors) | 394.60mm. |

WEIGHT:

(Excl. packing): 34Kg

Circuit Description

Circuit Description

General

The CPS1000 is a linear power supply, the operation of which avoids the induction of switching noise, associated with switch-mode designs, in audio paths. The unit incorporates state-of-the-art solid state regulators to deliver high output currents from a wide range of mains supply voltages. A variable speed fan is controlled by the amount of cooling required for the load and ambient temperature, and begins operation when the temperature of either heatsink exceeds 35°C

Left-Hand Regulator PCB (SC3546-Z)

This PCB carries the +48V regulator, the two regulators for +/-17V A, and the positive regulator for +/-17V B. It also carries the L.H heatsink temperature sensor.

The +48v regulator REG1 is based on a specialised high-voltage regulator chip called the TL783C. The regulator maintains a constant 1.27V across R1, and therefore the total output voltage is set by the potential divider (R1)-(PR1+R2+R50) with PR1 allowing for a limited range of output adjustment. LED1 indicates that the supply is good; note that it is placed in the potential divider to avoid having to draw further current from the regulated +48V. C20 improves ripple rejection, and C1 ensures HF stability of the regulator. D1 will conduct to prevent REG1 from being reverse-biased if a large capacitance remains charged across the output when the PSU is turned off. D2 will conduct to prevent the ADJ pin of REG1 from being reverse-biased by the charge on C20, if the output should be short-circuited. The transformer secondary is protected by F2.

The 17V regulators are all based on the LT1083, a high-performance high-current device that improves the efficiency of the supply by allowing operation with a minimum voltage of 1.5V across it. The protection diodes described in the 48V regulator are built into the LT1083, but otherwise operation is very similar. The bridge rectifiers for the 17V supplies are mounted on their associated heatsinks, as at these current levels their dissipation is substantial.



It is essential that the graphite-foil heat-conduction material is retained between the rectifiers and the heatsink.

In the case of +17V A, the regulator is REG2, which maintains a constant 1.25V across R3 and therefore the total output voltage is set by the potential divider (R3)-(PR2+R7) with PR2 allowing for a limited range of output adjustment. C2 and C22 ensure HF stability of the regulator. The transformer secondary is protected by F3.

If the +17V supply should fail for any reason, it is essential that its matching -17V supply is also shut down, to avoid damage to equipment being powered. This is assured by the mutual-shutdown circuitry TR1,TR3,D3,R5,R6. Normally D3 is conducting, with both ends close to 0V, and TR1,TR3 are both off. If the positive supply falls then D3 goes negative and TR3 is turned on via R6, shunting the bottom arm of the REG3 potential divider, and reducing the output to approx 1.5 V, which is harmless to external equipment. Similarly, if the negative supply collapses then D3 goes high, allowing TR1 to be turned on via R5, and shunting the REG2 potential divider to close down the positive rail.

LED2 indicates that the supply is good; no LED is provided for the -17V as the failure of either rail causes the other to close down.

The +/-17V B supplies operate exactly as for the +/- 17V A supplies, the only difference being that the -17V B regulator is on the RH PCB, and the mutual-shutdown line must therefore be carried between them in the wiring loom. If this line is disconnected then both positive and negative 17V B regulators remain permanently shut down.

Right-Hand Regulator PCB (SC3546-Y)

This PCB carries the negative +/-17V B regulator, the 24V A and 24V B regulators, and the unregulated +12V supply for the fan and mains meter. It also carries the RH heatsink temperature sensor.

The -17V B regulator is exactly as for the -17V A regulator, described above.

The +24V A supply (3 Amp) is based on TO3 regulator REG7, and operates in the same way as the regulators described above. D13,D14 protect the regulator from reverse-biasing, as for the +48V regulator, and F7 protects the transformer secondary.

The +24V B supply (1.5 Amp) is based on 24V regulator REG6. This is a fixed-output device with no voltage adjustment. D15 will conduct to prevent REG6 from being reverse-biased if a large capacitance remains charged across the output when the PSU is turned off.

The +7.5V supply (REG8), -7.5V supply (REG9) and +15V supply (remote mounted LM338K) are essentially identical circuits to that described for the +24V A supply above. Full-wave rectification and smoothing for these circuits is fitted on a separate PCB, SC3221.

Fan-Control & Mains Meter PCB (SC3546-W)

Both fan-control and mains meter are powered from an unregulated supply at approx +12V, and therefore make use of accurate reference voltages generated by IC reference IC4 and IC1-A. IC4 is a band-gap reference that generates a precise +5.00V across itself when fed with unregulated current via R23. C55 removes HF noise. This voltage is used directly by the mains meter, and also scaled up by IC1-A to 7.4V, which is used both by the mains meter, and also as a "half-rail" by the fan controller.

The fan-control system monitors the temperature of the two heat sinks, and sets the fan speed to be appropriate to the hotter of the two. Heatsink temperature is measured by IC temperature sensors TS1 and TS2 (LM35DZ) mounted on the LH and RH regulator PCBs, where they are held in thermal contact with the heat sinks by small metal clips. The LM35DZ is in a transistor-style package, but is in reality an IC that provides a DC output proportional to temperature in degrees Centigrade (Celsius) at the rate of +10mV per degree C. This voltage is amplified by a factor of 10x, set by R27,R31 and R28,R32. Diodes D21,D22 ensure that only the most negative of the two op-amp outputs is applied to R29. If the output of IC2-A is marginally lower than that of IC2-B, due to its associated temperature sensor being hotter, then D21 remains forward-biased, and its forward-voltage is servoed out by the open-loop gain of IC2-A. D22 then becomes reverse-biased as the output of IC2-B saturates positively due to the voltage being applied through R32 to its inverting input.

IC1-B compares the temperature-proportional voltage provided by either IC2-A or B with the reference voltage set up by R30,R26, and amplifies the difference by a further 10 times. The relevant voltage is that across R30, which defines the temperature at which the fan starts to run. This is approximately 3.5V, and corresponds to 35°C. The fan is controlled by TR7, driven from the output of IC1-B via D26 & R36, which voltage-shift the op-amp output so it can fall low enough to turn TR7 properly off. C56 prevents any HF oscillation.

If the +12V supply voltage falls significantly, for example if the mains tappings are set incorrectly, the operation of the temperature sensors becomes uncertain, and the fan speed unpredictable. To ensure that the fan will be in its safest state (ie running at maximum speed) in this abnormal condition, a safety circuit is provided in the form of TR5,D25 etc. The 7.4V rail remains unchanged as the supply voltage drops, and when the difference between them falls below about 2V, TR5 is no longer kept conducting by R35, and its collector voltage falls until D25 turns on and drives the output of IC1-B high, driving the fan with the full available voltage.

In some applications maximum cooling may be more important than minimising fan noise, and so jumper J1 is provided so that TR7 can be shorted out, leaving the fan running continuously at maximum speed.

The mains meter reads the voltage across a tap of one of the transformer primaries, so that voltage tapping changes are automatically taken into account. Safety isolation is provided by R48,49 on the voltage-select PCB. These are specially-approved resistor types that limit the maximum current that can be drawn from the CON14 pins to a safe amount.



To maintain safety it is essential that these resistors are only replaced with the correct type

IC3-A is a differential amplifier that scales down the transformer primary voltage to a more manageable level. Its DC operating point is set by the 7.4V half-rail, via R42. The attenuated and isolated mains voltage is peak-rectified by D23,24, with C58 as a reservoir capacitor. Calibration is set by preset PR7, with R44 limiting the adjustment range.

IC5 (LM3914) is a multi-comparator IC normally used for driving audio bargraph meters. It contains ten comparator/led-drivers, with their switching points set by an internal potential divider (10x 1K resistors) connected between pins 4 & 6 (DIVL & DIVHI). This potential divider is connected between the +5.00V reference and the +7.4V half-rail to define the range over which the comparators switch.

If the mains voltage is more than 10% low, all comparators are off, and the top four LEDs (LED6-9) are not illuminated. TR6 is off and so LED10 is powered through R45. When the rectified voltage applied to the I/P pin of IC5 rises above the first trip point, (which is -7.5%; halfway between -10% and -5%) pin 1 goes low and LED9 comes on, drawing current through R47, and turning on TR6 via R41, thus shunting current from LED10 and extinguishing it. As the input voltage rises further, pin 1 goes high again and pin 18 now goes low to turn on LED8; this "one LED at a time" action is handled internally by IC5.

As the input voltage rises further, successive LEDs come on, until if the mains exceeds +10%, LED6 remains on, due to pins 10-16 being commoned together.



When testing this circuit, do not apply a mains voltage to the psu that is more than 10% above nominal or damage may result

R46 sets the current through LED6-9, and C60 locally decouples the supply rail.

Mains Voltage-select PCB

This board carries the transformer tapping switches, the mains backup fuse, inrush suppressor, and the mains-meter isolation resistors.

The mains voltage switching is conventional. On the 240,220, & 200 Volt settings the two transformer primaries are connected in series.



Note that there are two switch settings that give 220V, and these are functionally equivalent.

For the 120,110,100 & 90 Volt settings the transformer primaries are operated in parallel.

The mains backup fuse provides safety protection if the front panel fuse is replaced with an incorrectly high value. Under normal conditions a fault will only cause the front panel fuse to open, as the backup fuse has a higher rating.

Note that the front panel fuse should be replaced when changing from 240-200V ranges to 120-90V.



The correct value for 240-200V is T6.3A/250V (slow-blow) and for 120-90V is T10A/250V (slow-blow)

A large PSU such as this takes a sizeable inrush transient when first switched on. To minimise the chance of this operating external circuit-breakers, etc, an inrush suppressor is connected in series with the mains input. The resistance of this is high enough to limit the inrush current but drops to a very low value as the device heats up. **The inrush suppressor inherently runs very hot, at approx 160 deg C, and also carries mains live.**



Exercise great caution when working on this board.

Mains-meter safety isolation is provide by R48,49 on the voltage-select PCB. These are specially-approved resistor types that limit the maximum current that can be drawn from the CON14 pins to a safe amount.



To maintain safety it is essential that these resistors are only replaced with the correct type.

ED3546-Y RH PCB (SHEET 2 of 2)

WIREFORM
COLOURS

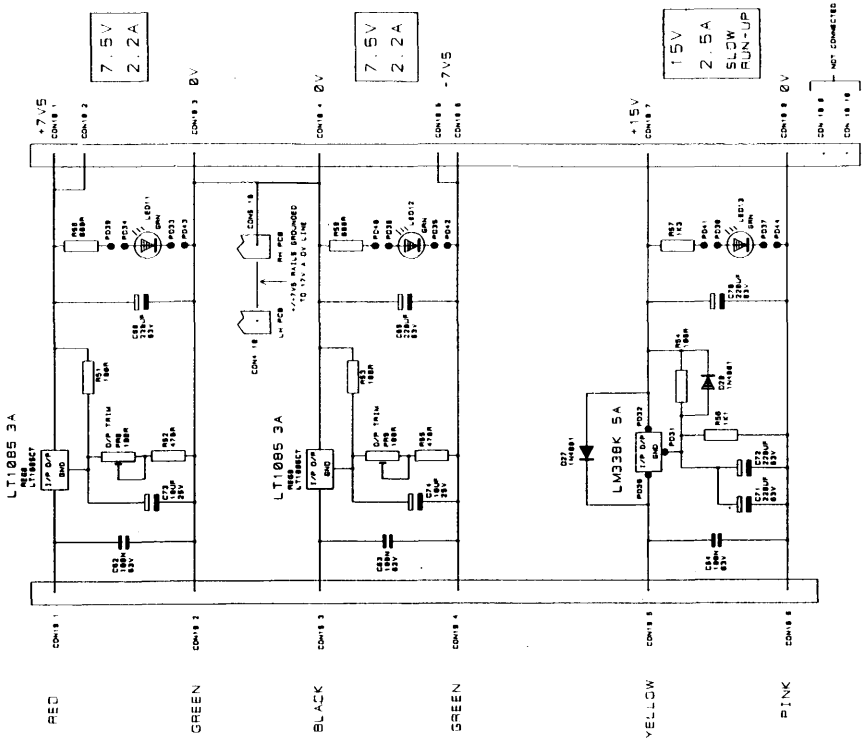

LM338K

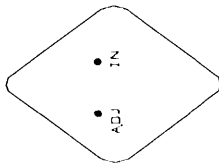

LT1085



CPS1088 PSU
EXTRA RAILS RH PCB 35460

ED3221 Rectifier PCB

TRANSFORMER
SECONDARIES

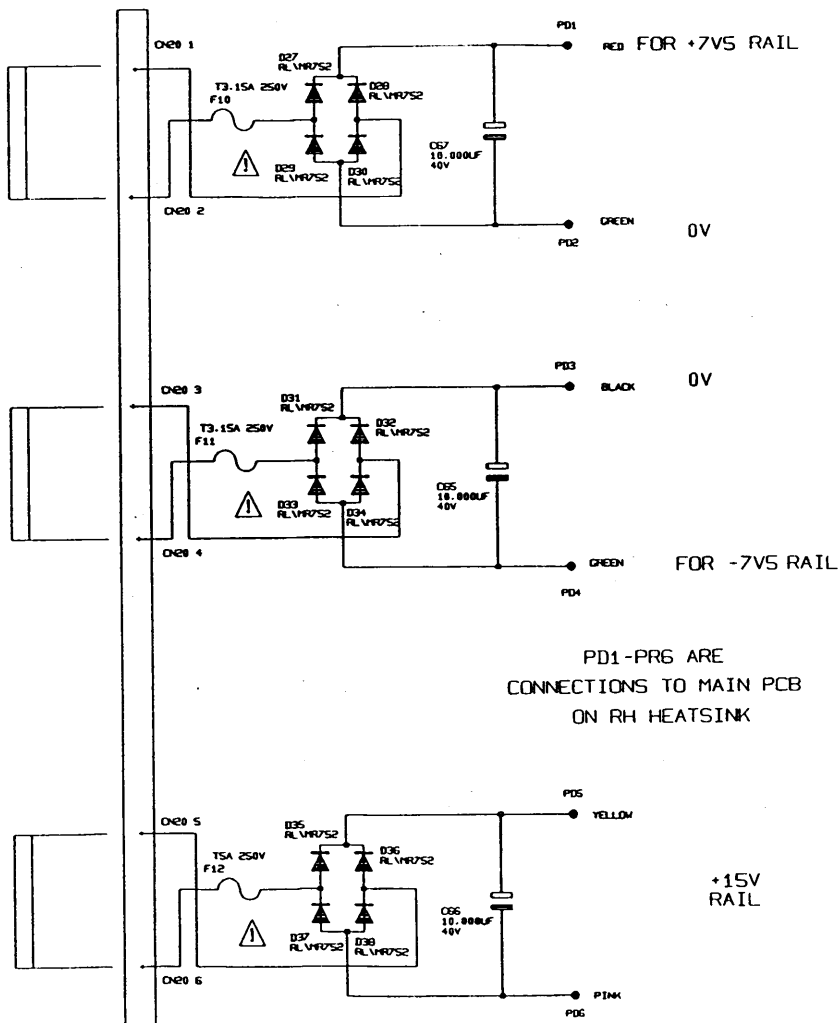

SRC Wireform Assembly

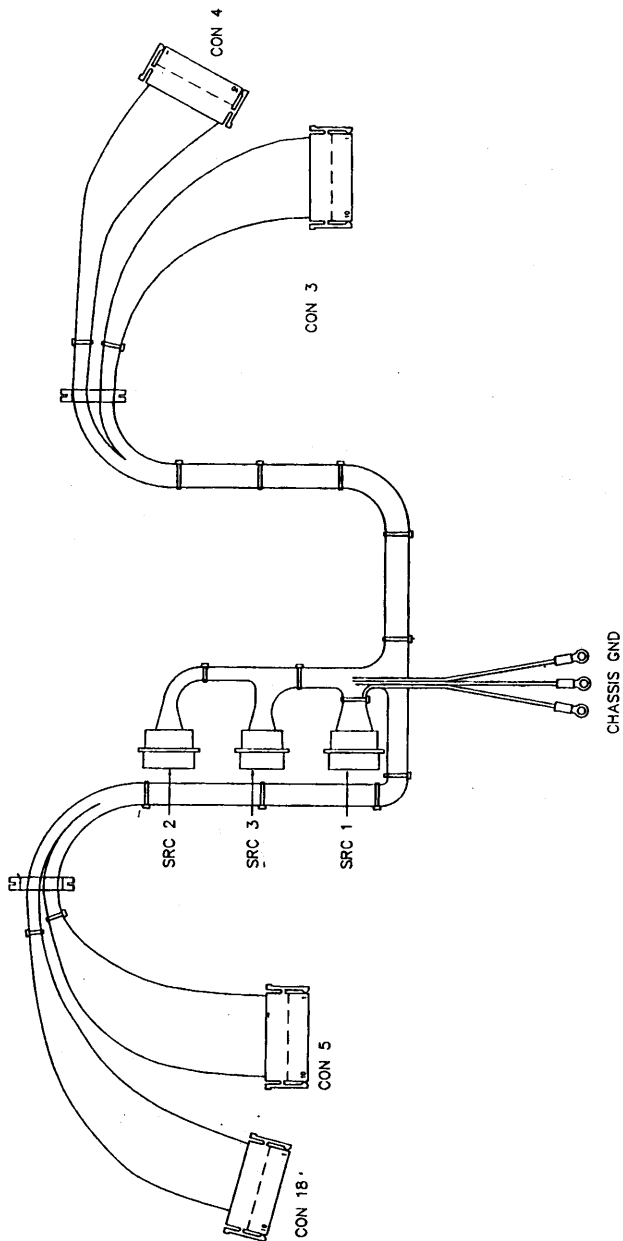

FRONT VIEW OF SRC's

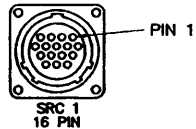
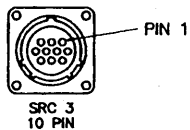
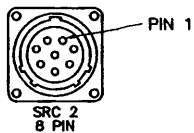

SRC Connections

| FROM | TO | COLOUR |
|----------------|----------------|---------|
| SRC 1 - PIN 1 | CON 3 - PIN 1 | BRN |
| SRC 1 - PIN 2 | CON 18 - PIN 1 | RED |
| SRC 1 - PIN 3 | CON 3 - PIN 5 | BLU |
| SRC 1 - PIN 4 | CON 3 - PIN 3 | GRN |
| SRC 1 - PIN 5 | CON 18 - PIN 5 | BLK |
| SRC 1 - PIN 6 | CON 18 - PIN 3 | GRN |
| SRC 1 - PIN 7 | CON 5 - PIN 6 | WHT |
| SRC 1 - PIN 8 | CON 5 - PIN 2 | VIO |
| SRC 1 - PIN 9 | CON 18 - PIN 4 | GRN |
| SRC 1 - PIN 10 | CON 3 - PIN 9 | ORG |
| SRC 1 - PIN 11 | CON 5 - PIN 5 | GRY |
| SRC 1 - PIN 12 | CON 5 - PIN 4 | GRN |
| SRC 1 - PIN 13 | CON 3 - PIN 7 | GRN |
| SRC 1 - PIN 14 | CHASSIS GND | GRN/YEL |
| SRC 1 - PIN 15 | CON 18 - PIN 8 | PINK |
| SRC 1 - PIN 16 | CON 18 - PIN 7 | YEL |
| SRC 2 - PIN 1 | CON 4 - PIN 1 | BRN |
| SRC 2 - PIN 2 | CON 4 - PIN 3 | GRN |
| SRC 2 - PIN 3 | CON 4 - PIN 5 | BLU |
| SRC 2 - PIN 4 | CON 4 - PIN 2 | BRN |
| SRC 2 - PIN 5 | CON 4 - PIN 4 | GRN |
| SRC 2 - PIN 6 | CON 4 - PIN 6 | BLU |
| SRC 2 - PIN 7 | CHASSIS GND | GRN/YEL |
| SRC 2 - PIN 8 | | |
| SRC 3 - PIN 1 | CON 3 - PIN 2 | BRN |
| SRC 3 - PIN 2 | CON 18 - PIN 2 | RED |
| SRC 3 - PIN 3 | CON 3 - PIN 6 | BLU |
| SRC 3 - PIN 4 | CHASSIS GND | GRN/YEL |
| SRC 3 - PIN 5 | CON 3 - PIN 4 | GRN |
| SRC 3 - PIN 6 | CON 3 - PIN 8 | GRN |
| SRC 3 - PIN 7 | CON 5 - PIN 3 | GRN |
| SRC 3 - PIN 8 | CON 5 - PIN 1 | VIO |
| SRC 3 - PIN 9 | CON 18 - PIN 6 | BLK |
| SRC 3 - PIN 10 | CON 3 - PIN 10 | ORG |
| CON 4 - PIN 7 | CON 5 - PIN 7 | BLU |
| CON 4 - PIN 8 | CON 5 - PIN 8 | GRN |
| CON 4 - PIN 9 | CON 5 - PIN 9 | YEL |
| CON 4 - PIN 10 | CON 5 - PIN 10 | GRN |

WIRE MARK BOTH ENDS.

Fan & Mains Meter Wiring Diagram

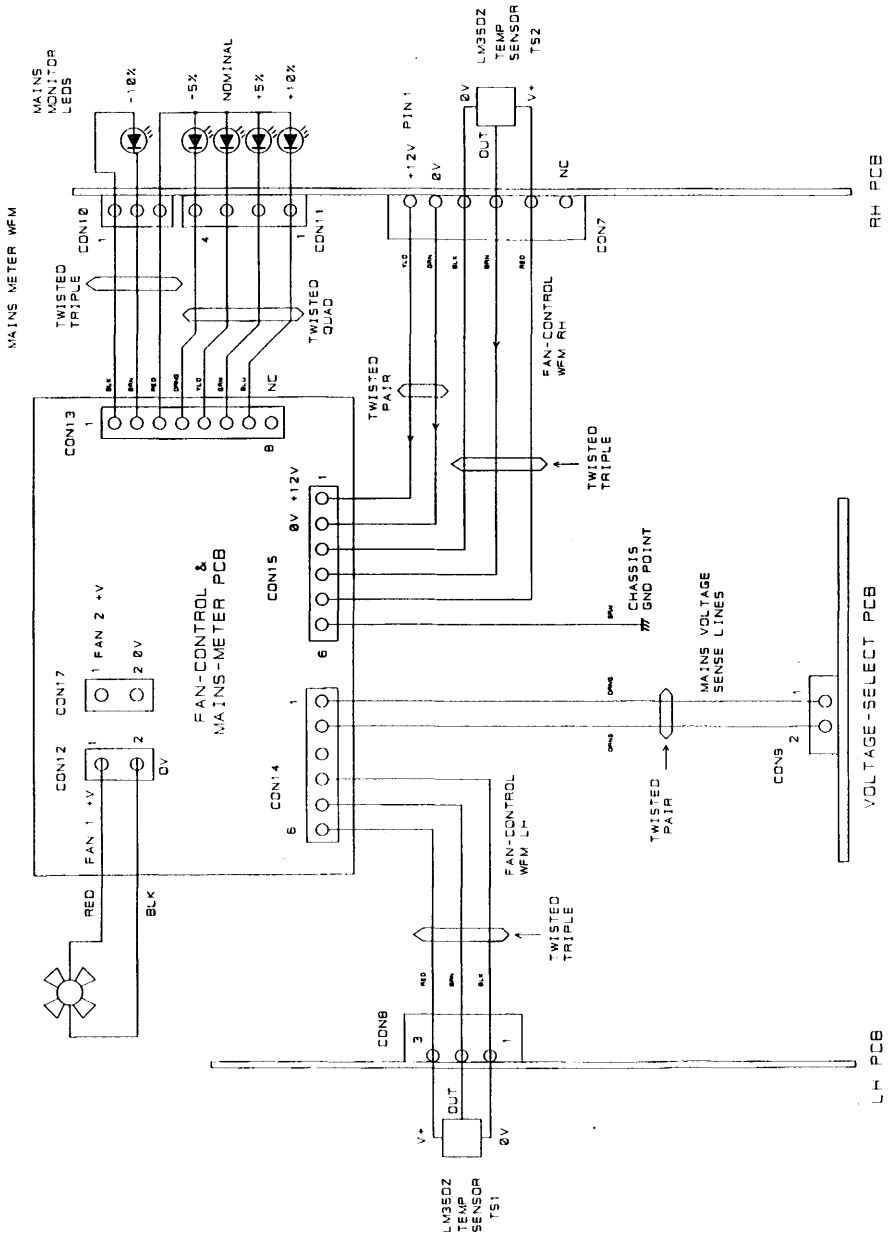

Transformer Wireform

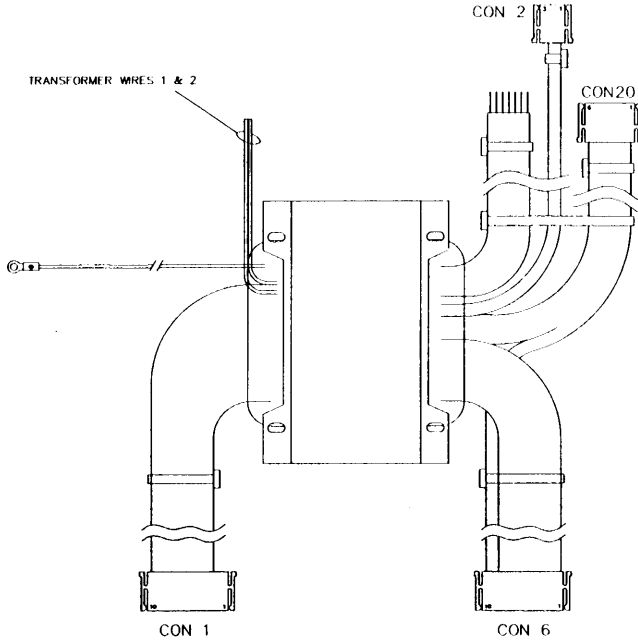

| WIRE LIST | | |
|--------------------------|------------------|---------|
| FROM | TO | COLOUR |
| TRANSFORMER WIRE No. 11 | CON 1 - PIN 3 | BLK |
| TRANSFORMER WIRE No. 12 | CON 1 - PIN 4 | BLK |
| TRANSFORMER WIRE No. 13 | CON 1 - PIN 5 | BLK |
| TRANSFORMER WIRE No. 14 | CON 1 - PIN 6 | BLK |
| TRANSFORMER WIRE No. 21 | CON 1 - PIN 7 | BLK |
| TRANSFORMER WIRE No. 22 | CON 1 - PIN 8 | BLK |
| TRANSFORMER WIRE No. 23 | CON 1 - PIN 9 | BLK |
| TRANSFORMER WIRE No. 24 | CON 1 - PIN 10 | BLK |
| TRANSFORMER WIRE WHI | CON 2 - PIN 1 | WHI |
| TRANSFORMER WIRE WHI | CON 2 - PIN 2 | WHI |
| TRANSFORMER WIRE No. 1 | F3 FUSE TIP | BLK |
| TRANSFORMER WIRE No. 1 | RECT BRG AC PD3 | BLK |
| TRANSFORMER WIRE No. 2 | F4 FUSE TIP | BLK |
| TRANSFORMER WIRE No. 2 | RECT BRG AC PD7 | BLK |
| TRANSFORMER WIRE No. 3 | F5 FUSE TIP | BLK |
| TRANSFORMER WIRE No. 3 | RECT BRG AC PD11 | BLK |
| TRANSFORMER WIRE YEL | CON 6 - PIN 1 | YEL |
| TRANSFORMER WIRE YEL | CON 6 - PIN 2 | YEL |
| TRANSFORMER WIRE BLU | F7 FUSE TIP | BLU |
| TRANSFORMER WIRE BLU | RECT BRG AC PD22 | BLU |
| TRANSFORMER WIRE RED | CON 6 - PIN 5 | RED |
| TRANSFORMER WIRE RED | CON 6 - PIN 6 | RED |
| TRANSFORMER WIRE BLK4 | F9 FUSE TIP | BLK |
| TRANSFORMER WIRE BLK4 | RECT BRG AC PD15 | BLK |
| TRANSFORMER WIRE GRN/YEL | EARTH TAG | GRN/YEL |
| CON 6 - PIN 9 | CON 20 - PIN 1 | ORG |
| CON 6 - PIN 10 | CON 20 - PIN 2 | ORG |
| TRANSFORMER WIRE GRY | CON 20 - PIN 3 | GRY |
| TRANSFORMER WIRE GRY | CON 20 - PIN 4 | GRY |
| TRANSFORMER WIRE BLK | CON 20 - PIN 5 | BLK |
| TRANSFORMER WIRE BLK | CON 20 - PIN 6 | BLK |

Servicing

Servicing Components

Connector Configuration

PCB Layouts

Servicing

This operation should only be carried out by a competent service engineer.

Initial operational tests on the power supply can be carried out by switching the unit ON and checking the voltages present on the output connectors on the back of the unit. While the unit remains disconnected from the mixing console the DC voltage rails are floating with respect to each other, that is they do not all have a common reference within the unit. When connection is made to the mixing console various output pins become earthed to a common star-point, which has a mains earth return in the power supply cable itself.

An indication of obvious fault condition is the failure of one or more of the front-panel LED's to light.

Any fault condition, with the exception of simple mains fuse failure due to underrating or an unusual mains input condition, will require removal of the top cover to enable fault correction. This is achieved using a cross-head screwdriver to remove the six retaining screws and washers. Carefully lift the cover to avoid the earth connecting lead to the cover from snagging. Place the cover face down behind the unit.

WARNING: At the front of the unit just behind the front panel is the MAINS VOLTAGE SELECT PCB, which carries HIGH VOLTAGES directly from the mains input. Care MUST be taken when carrying out any servicing operation with the top cover removed.



SERVICING COMPONENTS

Replacement of any components should be undertaken only after switching the power supply unit OFF and disconnecting the mains supply lead from the power supply unit.



Replacement of any of the fuses and regulators in the power supply units is possible without the removal of circuit boards.

The fuses are held in open fuseholders close to the top of the boards. These can be carefully removed by hand. Ensure that the insulating fuse covers are replaced with the new fuses. The exceptions to this are fuses F3, F4, F5, F7 and F9. These are held on the Fuse Support Plate which is mounted on the transformer.

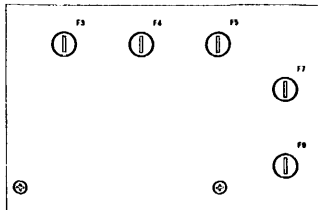

The regulators are mounted along the top edge of the heatsink extrusions and may be replaced without removing the circuit boards. They can be removed by desoldering the 3 pins and unscrewing the M3 fixing screw, taking care to retain the small

insulating bush beneath the head of the screw. The correct high efficiency mounting pad must be used, and this should be replaced if it appears to be damaged (see the Parts Lists for the relevant Soundcraft Part Numbers). Use heatsink compound on both sides of the pad to ensure good thermal contact. When refixing or replacing the device, it is important to screw the device down before resoldering the pins to avoid stressing the pads on the circuit board.

NOTE : The heatsink bracket is earthed through its mechanical contact with the rest of the chassis and so a faulty mounting pad may cause the output of its regulator to be connected to earth.

To replace any other components in a regulation circuit it is necessary to gain access to both sides of the circuit board. Disassembly should be carried out carefully as follows, after removing power from the unit and disconnecting the output cables:

- Remove the top and bottom covers of the unit by releasing the six screws on each cover.
- Release the front and rear panels from the heatsink assemblies by unscrewing the 8 screws at the front and 4 screws at the rear. Lay the panels down, taking care not to strain any of the cable assemblies.

Each of the main circuit boards is released as follows:

- Remove the fixing screws on each regulator. Retain carefully the mounting pads and plastic insulating bushes where fitted. **THESE MUST BE CORRECTLY REFITTED TO AVOID DAMAGE TO THE UNIT.**
- Remove the fixing screws along the top of the circuit board and lift slightly to release the bottom of the board from the channel in the heatsink. The board may now be moved clear of the heatsink to gain access to both sides of the board.



Take care not to bend the pins on the regulators, or to strain the corresponding pads on the circuit board

- The PSU may be tested under load with the heatsinks removed from the chassis, but for no longer than 5 minutes since there is no forced airflow through the heatsinks when the unit is disassembled and they will soon warm up.
- Reassembly is simply a reverse of the procedure above. Particular care should be taken when fixing the regulators, ensuring that the pins are not bent or the circuit board pads strained when the fixing screws are tightened. The regulator screws are tapped into a relatively soft aluminium heatsink. **DO NOT OVER-TIGHTEN** or you will strip the thread in the heatsink. High performance mounting pads must be fitted between the regulators and the heatsink and it is recommended that mounting compound is smeared on both faces of the pad to ensure good thermal contact. The regulators must be checked for isolation from the heatsink using a multimeter.
- Re-dress cable forms in their original positions and secure where applicable with cable ties.

GENERAL

Before replacing the top cover on the unit, carefully remove any dust from surfaces within the unit.



Carefully check all wiring connections and ensure that there are no loose parts lying around inside the unit.

Connector Configurations:

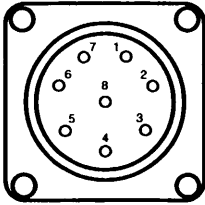

8W SRC Connector
viewed from rear of PSU

| PIN No. | Description |
|---------|-----------------------|
| 1 | + 17V Audio Supply B |
| 2 | Ground Audio Supply B |
| 3 | -17V Audio Supply B |
| 4 | + 17V Audio Supply B |
| 5 | Ground Audio Supply B |
| 6 | -17V Audio Supply B |
| 7 | Chassis Ground |
| 8 | No Connection |

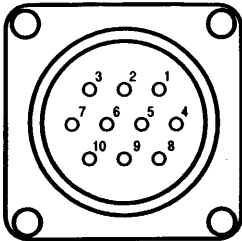

10W SRC Connector
viewed from rear of PSU

| PIN No. | Description |
|---------|----------------------|
| 1 | + 17V Audio Supply A |
| 2 | + 7.5 Volts |
| 3 | -17V Audio Supply A |
| 4 | Chassis Ground |
| 5 | 17V & 7V5 0V |
| 6 | 0V (48V Supply) |
| 7 | + 24V A (GND) |
| 8 | + 24V Supply A |
| 9 | -7.5 Volts |
| 10 | + 48V Supply |

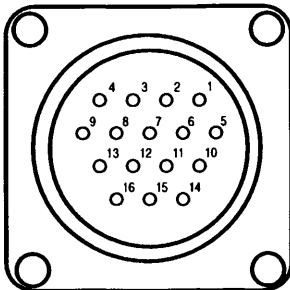

16W SRC Connector
Viewed from rear of PSU

| PIN No. | Description |
|---------|---------------------|
| 1 | + 17 Volts A |
| 2 | + 7.5 Volts |
| 3 | -17 Volts A |
| 4 | +/-17 Volts A (GND) |
| 5 | -7.5 Volts |
| 6 | + 7.5 Volts (GND) |
| 7 | + 24 Volts B(GND) |
| 8 | + 24 Volts A |
| 9 | -7.5 Volts (GND) |
| 10 | + 48 Volts |
| 11 | + 24 Volts B |
| 12 | + 24 Volts A(GND) |
| 13 | + 48 Volts(GND) |
| 14 | Chassis Ground |
| 15 | + 15 Volts (GND) |
| 16 | + 15 Volts |

Note: In some diagrams the A and B supplies are referred to as No.1 and No.2. Please regard A & No.1 as synonymous terms, and B & No.2 also as synonymous terms.

SC3546B-X Mains Voltage Select Switches PCB

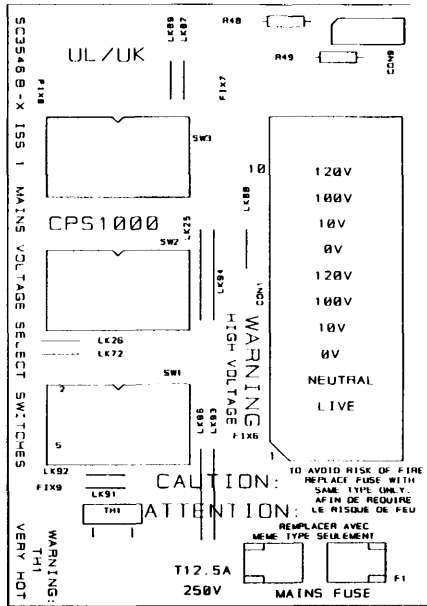

SC3546B-W Mains Meter & Fan Control PCB

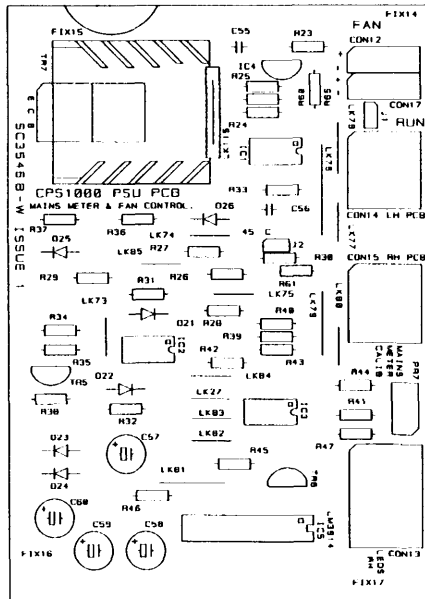

SC3221 Rectifier PCB

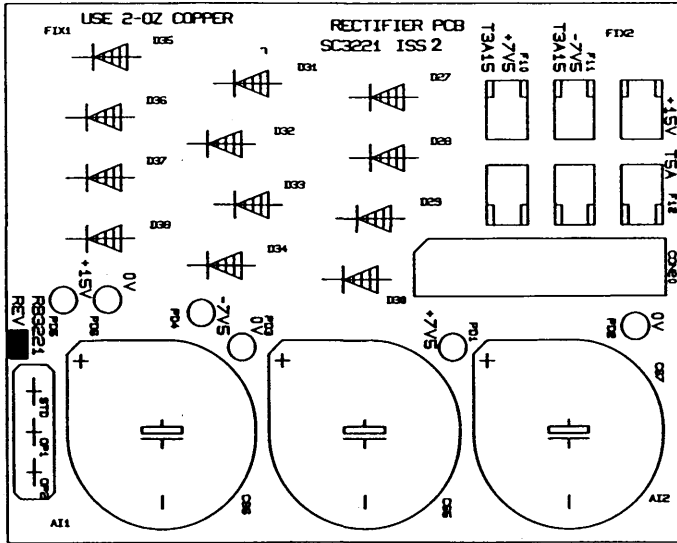

Spare Parts

| | | |
|--------|--|-----------|
| --- | M6X12MM PAN POZI SCREW | NA0096 |
| --- | M3 X 8MM PAN POZI BLCK SCRWB | NA0130 |
| --- | M3.5X10 PAN POZI ZINC PLATED | NA0133 |
| --- | M4X10MM PAN POZI STL SCR BLACK | NA0146 |
| --- | NO.10X1" PAN POZI ST AB BL CH | NA0209 |
| --- | NO10X1" TYP AB PAN POZI PLTD | NA0215 |
| --- | NO6X1/2" CSK POZI TYPE B CLEAR | NA0256 |
| --- | M4 NYLON INSERT NUT TYPE T | NB0127 |
| --- | M6 CAGE NUT | NB0138 |
| --- | M3 BLACK NYLON WASHER | NC0231 |
| --- | M4 BLACK PLASTIC WASHER | NC0250 |
| --- | 1"X0.25" PCH M3.5 MS TPD STP | NZ2214 |
| --- | M3 1"X0.250 PITCH TAPPED STRIP | NZ2232 |
| --- | BARBED SPIRE CLIP DA/ENG/A/2P | NZ2251 |
| --- | CPS900/950 LH REAR BRACKET | PG1151 |
| --- | CPS900/950 RH REAR BRACKET | PG1152 |
| --- | CPS900/950 SUPPORT BRACKET | PG1153 |
| --- | CPS900 PSU CVR | PJ1251 |
| --- | CPS950 TX AIR DEFLECTER | PZ2295 |
| --- | CPS1000 CHASSIS ASSY | RS5798 |
| --- | MTHD 2WY .1" FML | FF0585 |
| --- | IEC INLET SKT 16A PNL MNT | FJ8010 |
| --- | FAN 120MM 12V DC (SUNON) | HD0001 |
| --- | CABLE TIE 4.3" | LF0501 |
| --- | M3 X 10MM PAN/POZI | NA0157 |
| --- | M4X20 CSK POZI ZINC PLT SCR | NA0272 |
| --- | M6X10MM PAN POZI CLR SCR | NA0315 |
| --- | M3 NYLON INSERT NUT | NB0113 |
| --- | M6 NYLON INSERT NUT | NB0117 |
| --- | M4 NYLON INSERT NUT TYPE T | NB0127 |
| --- | M4 PLAIN NUT ZINC CLEAR | NB0144 |
| --- | M6 PLAIN WASHER | NC0219 |
| --- | RIVET 1/8"X0.310" DOME HEAD | NF0505 |
| --- | P-CLIP (9-14.3MM) | NZ2286 |
| --- | P-CLIP (6.4MM) | NZ2287 |
| --- | CPS950 PSU FAN CHASSIS | PG1149 |
| --- | CPS950 RECTIFIER PCB ASSY | RB3221 |
| D27-38 | DIODE RL/MR752 200V 6A PRFM.6" | BA0007 |
| C65 | VERT ELEC 10MM 10,000MF/40V | CE0427 |
| C66 | VERT ELEC 10MM 10,000MF/40V | CE0427 |
| C67 | VERT ELEC 10MM 10,000MF/40V | CE0427 |
| F10 | SCHURTER FUSE CLIP | ZD0317 |
| F11 | SCHURTER FUSE CLIP | ZD0317 |
| F12 | SCHURTER FUSE CLIP | ZD0317 |
| --- | CPS950 BAFFLE PLATE ASSY | RS5393B |
| --- | CPS900/950 BAFFLE PLATE | PA0237 |
| --- | CPS1000 FUSE SUPPORT PLT ASSY | RS5802 |
| --- | H20X20MM HELSYN SLEEVE BLUE | LF0512 |
| --- | CPS1000 FUSE SUPPORT PLATE | PC1231-01 |
| --- | CPS1000 F3/5-BRIDGE WFM | RV3242 |
| --- | CPS1000 F4-BRIDGE WFM | RV3243 |
| --- | CPS1000 F9-BRIDGE WFM | RV3244 |
| --- | CPS1000 F7-BRIDGE WFM | RV3245 |
| --- | SCHRTR FUSEHOLDER F100031-1362 | ZD8011 |
| --- | SHRTR FUSECARR'R FEK0031-1371 | ZD8012 |
| --- | 5X20MM T5A/250V AS FUSE | ZD8105 |
| --- | 5X20MM T10A/250V AS FUSE | ZD8110 |
| --- | CPS900 T/FAN MAINS WFM | RV2706 |

| | | |
|-------|-------------------------------|--------|
| --- | CPS950 SRC WFM | RV2713 |
| --- | CPS950 RECTIFIER PCB WFM | RV2719 |
| --- | CPS1000 TRANFORMER WFM | RV3240 |
| F10 | FUSE COVER SCHURTER 853-9561 | ZD8013 |
| F11 | FUSE COVER SCHURTER 853-9561 | ZD8013 |
| F12 | FUSE COVER SCHURTER 853-9561 | ZD8013 |
| F10 | 5X20MM T3.15A/250V AS FUSE | ZD8103 |
| F11 | 5X20MM T3.15A/250V AS FUSE | ZD8103 |
| F12 | 5X20MM T5A/250V AS FUSE | ZD8105 |
| --- | FAN FILTER & GUARD (120MM) | ZZ2833 |
| --- | CPS1000 LH HEATSINK ASSY | RS5799 |
| --- | BDG RECT KBPC3502 | BC0215 |
| C5-16 | MICRO-BOX 5MM 5% 100V 100N | CC0250 |
| --- | M5X16MM PAN POZI SCREW | NA0092 |
| --- | M3 X 8MM PAN POZI PLTD SCREW | NA0116 |
| --- | M3.5X10 PAN POZI ZINC PLATED | NA0133 |
| --- | M3.5 X 4MM PAN POZI SCREW BLK | NA0193 |
| --- | NO6X3/8" TYP B PAN POZI ZINC | NA0217 |
| --- | NO 6X1/2" AB PAN POZI ZINC | NA0298 |
| --- | M5 S/PROOF WASHER | NC0217 |
| --- | PLASTIC SPACER 04X3.18 THICK | ND0354 |
| --- | 1"X0.25" PCH M3.5 MS TPD STP | NZ2214 |
| --- | TENSION RETAINING CLIP | NZ2284 |
| --- | CPS900 PSU H/SINK EXTRU | PE1285 |
| --- | CPS900 PSU H/SINK COVER EXTRU | PE1286 |
| --- | CPS900 48V REG INSULATION | PZ2291 |
| --- | CPS1000 PSU PCB ASSY | RA3546 |
| R1 | MF 0.25W RES 2% 82R | AD0423 |
| R47 | MF 0.25W RES 2% 100R | AD0425 |
| R51 | MF 0.25W RES 2% 100R | AD0425 |
| R53 | MF 0.25W RES 2% 100R | AD0425 |
| R54 | MF 0.25W RES 2% 100R | AD0425 |
| R3 | MF 0.25W RES 2% 120R | AD0427 |
| R4 | MF 0.25W RES 2% 120R | AD0427 |
| R11 | MF 0.25W RES 2% 120R | AD0427 |
| R14 | MF 0.25W RES 2% 120R | AD0427 |
| R16 | MF 0.25W RES 2% 120R | AD0427 |
| R63 | MF 0.25W RES 2% 120R | AD0427 |
| R36 | MF 0.25W RES 2% 150R | AD0429 |
| R52 | MF 0.25W RES 2% 470R | AD0441 |
| R55 | MF 0.25W RES 2% 470R | AD0441 |
| R58 | MF 0.25W RES 2% 680R | AD0445 |
| R59 | MF 0.25W RES 2% 680R | AD0445 |
| R45 | MF 0.25W RES 2% 1K | AD0449 |
| R46 | MF 0.25W RES 2% 1K | AD0449 |
| R50 | MF 0.25W RES 2% 1K | AD0449 |
| R56 | MF 0.25W RES 2% 1K1 | AD0450 |
| R5 | MF 0.25W RES 2% 1K3 | AD0452 |
| R6 | MF 0.25W RES 2% 1K3 | AD0452 |
| R7 | MF 0.25W RES 2% 1K3 | AD0452 |
| R8 | MF 0.25W RES 2% 1K3 | AD0452 |
| R12 | MF 0.25W RES 2% 1K3 | AD0452 |
| R13 | MF 0.25W RES 2% 1K3 | AD0452 |
| R21 | MF 0.25W RES 2% 1K3 | AD0452 |
| R22 | MF 0.25W RES 2% 1K3 | AD0452 |
| R57 | MF 0.25W RES 2% 1K3 | AD0452 |
| R2 | MF 0.25W RES 2% 1K6 | AD0454 |
| R9 | MF 0.25W RES 2% 1K6 | AD0454 |
| R10 | MF 0.25W RES 2% 1K6 | AD0454 |

| | | |
|-----|--------------------------------|--------|
| R19 | MF 0.25W RES 2% 1K8 | AD0455 |
| R23 | MF 0.25W RES 2% 1K8 | AD0455 |
| R64 | MF 0.25W RES 2% 1K8 | AD0455 |
| R24 | MF 0.25W RES 2% 2K | AD0456 |
| R17 | MF 0.25W RES 2% 2K2 | AD0457 |
| R18 | MF 0.25W RES 2% 2K2 | AD0457 |
| R37 | MF 0.25W RES 2% 2K2 | AD0457 |
| R65 | MF 0.25W RES 2% 3K3 | AD0461 |
| R30 | MF 0.25W RES 2% 8K2 | AD0471 |
| R26 | MF 0.25W RES 2% 10K | AD0473 |
| R27 | MF 0.25W RES 2% 10K | AD0473 |
| R28 | MF 0.25W RES 2% 10K | AD0473 |
| R29 | MF 0.25W RES 2% 10K | AD0473 |
| R39 | MF 0.25W RES 2% 10K | AD0473 |
| R40 | MF 0.25W RES 2% 10K | AD0473 |
| R41 | MF 0.25W RES 2% 10K | AD0473 |
| R61 | MF 0.25W RES 2% 15K | AD0477 |
| R25 | MF 0.25W RES 2% 22K | AD0481 |
| R44 | MF 0.25W RES 2% 22K | AD0481 |
| R38 | MF 0.25W RES 2% 47K | AD0489 |
| R60 | MF 0.25W RES 2% 47K | AD0489 |
| R31 | MF 0.25W RES 2% 100K | AD0497 |
| R32 | MF 0.25W RES 2% 100K | AD0497 |
| R33 | MF 0.25W RES 2% 100K | AD0497 |
| R34 | MF 0.25W RES 2% 220K | AD0505 |
| R42 | MF 0.25W RES 2% 330K | AD0509 |
| R43 | MF 0.25W RES 2% 330K | AD0509 |
| R35 | MF 0.25W RES 2% 680K | AD0517 |
| R48 | RES MF 10M 2% 0.25W VR37 | AD8107 |
| R49 | RES MF 10M 2% 0.25W VR37 | AD8107 |
| D3 | DIODE 1N4148 | BA0001 |
| D4 | DIODE 1N4148 | BA0001 |
| D21 | DIODE 1N4148 | BA0001 |
| D22 | DIODE 1N4148 | BA0001 |
| D23 | DIODE 1N4148 | BA0001 |
| D24 | DIODE 1N4148 | BA0001 |
| D25 | DIODE 1N4148 | BA0001 |
| D26 | DIODE 1N4148 | BA0001 |
| D1 | DIODE 1N4001 | BA0005 |
| D2 | DIODE 1N4001 | BA0005 |
| D13 | DIODE 1N4001 | BA0005 |
| D14 | DIODE 1N4001 | BA0005 |
| D15 | DIODE 1N4001 | BA0005 |
| D27 | DIODE 1N4001 | BA0005 |
| D28 | DIODE 1N4001 | BA0005 |
| D17 | DIODE RL/MR752 200V 6A PRFM.6" | BA0007 |
| D18 | DIODE RL/MR752 200V 6A PRFM.6" | BA0007 |
| D19 | DIODE RL/MR752 200V 6A PRFM.6" | BA0007 |
| D20 | DIODE RL/MR752 200V 6A PRFM.6" | BA0007 |
| D5 | DIODE 1N5402 200V 3A PRFMD .6" | BA0009 |
| D6 | DIODE 1N5402 200V 3A PRFMD .6" | BA0009 |
| D7 | DIODE 1N5402 200V 3A PRFMD .6" | BA0009 |
| D8 | DIODE 1N5402 200V 3A PRFMD .6" | BA0009 |
| D9 | DIODE 1N5402 200V 3A PRFMD .6" | BA0009 |
| D10 | DIODE 1N5402 200V 3A PRFMD .6" | BA0009 |
| D11 | DIODE 1N5402 200V 3A PRFMD .6" | BA0009 |
| D12 | DIODE 1N5402 200V 3A PRFMD .6" | BA0009 |
| TR3 | PNP TRANS 2SA970GR (TAPED) | BD0301 |
| TR4 | PNP TRANS 2SA970GR (TAPED) | BD0301 |
| TR5 | PNP TRANS 2SA970GR (TAPED) | BD0301 |

| | | |
|-----|--------------------------------|--------|
| TR6 | PNP TRANS 2SA970GR (TAPED) | BD0301 |
| TR1 | NPN TRANS 2SC2240BL(TAPED) | BD0302 |
| TR2 | NPN TRANS 2SC2240BL(TAPED) | BD0302 |
| TR7 | NPN TRANS BD139 | BD0337 |
| IC1 | TL072CP/NJM072BD DUAL OP AMP | BE0413 |
| IC2 | TL072CP/NJM072BD DUAL OP AMP | BE0413 |
| IC3 | TL072CP/NJM072BD DUAL OP AMP | BE0413 |
| IC5 | LED BAR DRIVER IC LM3914 | BE0427 |
| IC4 | REF50Z 5V VOLTAGE REF IC | BE0478 |
| C1 | POLY-CAP 5MM 5% 63V 100N | CC0252 |
| C2 | POLY-CAP 5MM 5% 63V 100N | CC0252 |
| C3 | POLY-CAP 5MM 5% 63V 100N | CC0252 |
| C4 | POLY-CAP 5MM 5% 63V 100N | CC0252 |
| C44 | POLY-CAP 5MM 5% 63V 100N | CC0252 |
| C45 | POLY-CAP 5MM 5% 63V 100N | CC0252 |
| C46 | POLY-CAP 5MM 5% 63V 100N | CC0252 |
| C55 | POLY-CAP 5MM 5% 63V 100N | CC0252 |
| C56 | POLY-CAP 5MM 5% 63V 100N | CC0252 |
| C62 | POLY-CAP 5MM 5% 63V 100N | CC0252 |
| C63 | POLY-CAP 5MM 5% 63V 100N | CC0252 |
| C64 | POLY-CAP 5MM 5% 63V 100N | CC0252 |
| C57 | VERT ELEC 0.2" TPD 47MF 25V | CE0401 |
| C58 | VERT ELEC 0.2" TPD 47MF 25V | CE0401 |
| C60 | VERT ELEC 0.2" TPD 47MF 25V | CE0401 |
| C20 | VERT ELEC 0.2" 47UF 63V | CE0402 |
| C21 | VERT ELEC 0.2" 47UF 63V | CE0402 |
| C40 | VERT ELEC 0.2" 47UF 63V | CE0402 |
| C41 | VERT ELEC 0.2" 47UF 63V | CE0402 |
| C53 | VERT ELEC 10MM 4700UF 50V | CE0414 |
| C54 | VERT ELEC 10MM 4700UF 50V | CE0414 |
| C59 | VERT ELEC 0.2"TPD 2.2MF 50V | CE0416 |
| C17 | VERT ELEC 0.2"TPD L-L 10MF 25V | CE0417 |
| C18 | VERT ELEC 0.2"TPD L-L 10MF 25V | CE0417 |
| C19 | VERT ELEC 0.2"TPD L-L 10MF 25V | CE0417 |
| C42 | VERT ELEC 0.2"TPD L-L 10MF 25V | CE0417 |
| C51 | VERT ELEC 0.2"TPD L-L 10MF 25V | CE0417 |
| C73 | VERT ELEC 0.2"TPD L-L 10MF 25V | CE0417 |
| C74 | VERT ELEC 0.2"TPD L-L 10MF 25V | CE0417 |
| C25 | VERT ELEC 10MM 1000MF/100V | CE0426 |
| C26 | VERT ELEC 10MM 10,000MF/40V | CE0427 |
| C27 | VERT ELEC 10MM 10,000MF/40V | CE0427 |
| C28 | VERT ELEC 10MM 10,000MF/40V | CE0427 |
| C29 | VERT ELEC 10MM 10,000MF/40V | CE0427 |
| C30 | VERT ELEC 10MM 10,000MF/40V | CE0427 |
| C31 | VERT ELEC 10MM 10,000MF/40V | CE0427 |
| C47 | VERT ELEC 10MM 10,000MF/40V | CE0427 |
| C48 | VERT ELEC 10MM 10,000MF/40V | CE0427 |
| C49 | VERT ELEC 10MM 10,000MF/40V | CE0427 |
| C22 | VERT ELEC 5MM 220MF/63V | CE0429 |
| C23 | VERT ELEC 5MM 220MF/63V | CE0429 |
| C24 | VERT ELEC 5MM 220MF/63V | CE0429 |
| C43 | VERT ELEC 5MM 220MF/63V | CE0429 |
| C68 | VERT ELEC 5MM 220MF/63V | CE0429 |
| C69 | VERT ELEC 5MM 220MF/63V | CE0429 |
| C70 | VERT ELEC 5MM 220MF/63V | CE0429 |
| C71 | VERT ELEC 5MM 220MF/63V | CE0429 |
| C72 | VERT ELEC 5MM 220MF/63V | CE0429 |
| C52 | VERT ELEC 4700MF/50V(22MM DIA) | CE0450 |
| PR7 | CERMET TRIMMER VERT 90V 22K | DE0404 |
| PR8 | CERMET TRIMMER VERT 90V 100R | DE0408 |

| | | |
|------|---------------------------------|---------------|
| PR9 | CERMET TRIMMER VERT 90V 100R | DE0408 |
| PR6 | CERMET VERTICAL TRIMMER 90V 1K | DE0409 |
| PR10 | CERMET VERTICAL TRIMMER 90V 1K | DE0409 |
| PR1 | CERMET TRIMMER VERT 470R | DE0418 |
| PR2 | CERMET TRIMMER VERT 470R | DE0418 |
| PR3 | CERMET TRIMMER VERT 470R | DE0418 |
| PR4 | CERMET TRIMMER VERT 470R | DE0418 |
| PR5 | CERMET TRIMMER VERT 470R | DE0418 |
| SW1 | ITW VOLTAGE SELECTOR SWT | DJ8000 |
| SW2 | ITW VOLTAGE SELECTOR SWT | DJ8000 |
| SW3 | ITW VOLTAGE SELECTOR SWT | DJ8000 |
| J1 | HONDA .1" 2WY SIL HDR (GOLD) | FF0613 |
| J2 | HONDA .1" 2WY SIL HDR (GOLD) | FF0613 |
| TR7 | M3 X 10MM PAN/POZI | NA0157 |
| TR7 | M3 NYLON INSERT NUT | NB0113 |
| TR7 | TO220,126 PWR FIN H/SNK TV1500 | PN1224 |
| --- | 1/4"CRIMP RCPTCLE CCT(CHAINED) | FG0629 |
| --- | CABLE TIE 4.3" | LF0501 |
| --- | CABLE TIE 4.3" | LF0501 |
| --- | H20X20MM HELSYN SLEEVE BLUE | LF0512 |
| --- | M3 SOLDER TAG STARRED | NE0410 |
| --- | H20X20MM HELSYN SLEEVE BLUE | LF0512 |
| --- | M3 SOLDER TAG STARRED | NE0410 |
| --- | 24 AWG WIRE BLACK UL1007 | LA8000 |
| --- | 24 AWG WIRE BLUE UL1007 | LA8001 |
| --- | 24 AWG WIRE GREEN UL1007 | LA8003 |
| --- | 24 AWG WIRE ORANGE UL1007 | LA8005 |
| --- | 24 AWG WIRE VIOLET UL1007 | LA8007 |
| --- | 24 AWG WIRE YELLOW UL1007 | LA8009 |
| --- | CABLE TIE 4.3" | LF0501 |
| --- | 1/4"CRIMP RCPTCLE CCT(CHAINED) | FG0629 |
| --- | CABLE TIE 4.3" | LF0501 |
| --- | 1/4"CRIMP RCPTCLE CCT(CHAINED) | FG0629 |
| --- | CABLE TIE 4.3" | LF0501 |
| --- | CPS1000 PSU PCB | SC3546-01 |
| F1 | SCHURTER FUSE CLIP | ZD0317 |
| F2 | SCHURTER FUSE CLIP | ZD0317 |
| F6 | SCHURTER FUSE CLIP | ZD0317 |
| F8 | SCHURTER FUSE CLIP | ZD0317 |
| --- | TIP INS BUSH | ZC0215 |
| --- | KOOL PAD LM317T/337T | ZC0217 |
| --- | 30CMX30CM THERMALLY CONDCTV SHT | ZC0223 |
| --- | KOOL PAD TO3P (HI-EFFICIENCY) | ZC0227 |
| F2 | FUSE COVER SCHURTER 853-9561 | ZD8013 |
| F2 | 5X20MM T1A/250V AS FUSE | ZD8101 |
| --- | CPS1000 RH HEATSINK ASSY | RS5800 |
| --- | BDG RECT KBPC3502 | BC0215 |
| C32 | MICRO-BOX 5MM 5% 100V 100N | CC0250 |
| C33 | MICRO-BOX 5MM 5% 100V 100N | CC0250 |
| C34 | MICRO-BOX 5MM 5% 100V 100N | CC0250 |
| C35 | MICRO-BOX 5MM 5% 100V 100N | CC0250 |
| C36 | MICRO-BOX 5MM 5% 100V 100N | CC0250 |
| C37 | MICRO-BOX 5MM 5% 100V 100N | CC0250 |
| C38 | MICRO-BOX 5MM 5% 100V 100N | CC0250 |
| C39 | MICRO-BOX 5MM 5% 100V 100N | CC0250 |
| --- | H20X20MM HELSYN SLEEVE BLUE | LF0512 |
| --- | M5X16MM PAN POZI SCREW | NA0092 |
| --- | M3 X 8MM PAN POZI PLTD SCREW | NA0116 |
| --- | NO10X1/2" PANPOZ TY A/B BLK S/T | NA0128 |
| --- | M3.5X10 PAN POZI ZINC PLATED | NA0133 |

| | | |
|-----|--|-------------------------------------|
| --- | M5 X 12 PAN/POZI SCREWS | NA0159 |
| --- | M3.5 X 4MM PAN POZI SCREW BLK | NA0193 |
| --- | NO6X3/8" TYP B PAN POZI ZINC | NA0217 |
| --- | M3X16MM PAN POZI SCRW ZNC | NA0245 |
| --- | M3 NYLON INSERT NUT | NB0113 |
| --- | M5 PLAIN WASHER | NC0216 |
| --- | M5 S/PROOF WASHER | NC0217 |
| --- | 1"X0.25" PCH M3.5 MS TPD STP | NZ2214 |
| --- | TENSION RETAINING CLIP | NZ2284 |
| --- | CPS950 HEATSINK ANGLE BRKT | PD0427 |
| --- | CPS900 PSU H/SINK COVER EXTRU | PE1286 |
| --- | CPS900/950 RH H/SINK EXTRU FIN | PE1372 |
| --- | CPS900 RH H/S FLOW RESTRICTOR | PZ2293 |
| --- | CPS1000 PSU PCB ASSY | RA3546 |
| | <i>for details see earlier listing</i> | |
| --- | CPS1000 FRONT PNL ASSY | RS5801 |
| --- | NON.IL RK SWT DPST(2600HM11E) | DL8003 |
| --- | M3X6MM PAN POZI BLK SCREW | NA0084 |
| --- | M3 X 8MM PAN POZI BLCK SCRW | NA0130 |
| --- | M3 BLACK NYLON WASHER | NC0231 |
| --- | NYLON SPCR L=3.2, ID=3.7, OD=6.4 | ND0376 |
| --- | CPS900 SWITCH COVER PLATE | PB0618 |
| --- | CPS1000 PSU FRONT FSC PNL | PJ1386-01 |
| --- | CPS900 SWITCH PCB INSULATION | PZ2292 |
| --- | CPS1000 PSU PCB ASSY | RA3546 |
| | <i>for details see earlier listing</i> | |
| | F1 | SCHURTER FUSE CLIP ! ZD0317 |
| | F2 | SCHURTER FUSE CLIP ! ZD0317 |
| | F6 | SCHURTER FUSE CLIP ! ZD0317 |
| | F8 | SCHURTER FUSE CLIP ! ZD0317 |
| --- | CPS1000 T/FAN FRONT PNL WFM | RV3241 |
| --- | 1/4" CRIMP RCPTCLE CCT (BLUE) | FG0645 |
| --- | H20X20MM HELSYN SLEEVE BLUE | LF0512 |
| --- | FUSE COVER SCHURTER 853-9561 | ZD8013 |
| --- | SCHRTR FUSEHOLDER | ZD8014 |
| --- | SCHRTR FUSE CARRIER | ZD8015 |
| --- | SCHRTR FUSEHOLDER INSULATOR | ZD8016 |
| | F1 | 5X20MM T12.5A/250V AS FUSE ! ZD8112 |
| --- | CPS900 FAN CONTROL LH WFM | RV2674 |
| --- | CPS900 MAINS METER WFM | RV2676 |
| --- | CPS950 FAN CONTROL RH WFM | RV2784 |

Warranty

SOUNDCRAFT RECOMMENDED WARRANTY

This warranty applies to sales within the UK and should form the basis of the warranty offered by the overseas vendor of Soundcraft products.

Soundcraft means Soundcraft Electronics Ltd.

End User means the person who first puts the equipment into regular

Dealer means the person other than Soundcraft (if any) from whom the End User purchased the Equipment, provided such a person is authorised for this purpose by Soundcraft or its accredited Distributor.

Equipment means the equipment supplied with this manual.

If within the period of twelve months from the date of delivery of the Equipment to the End User it shall prove defective by reason only of faulty materials and/or workmanship (but not faulty design) to such an extent that the effectiveness and/or usability thereof is materially affected the Equipment or the defective component should be returned to the Dealer or to Soundcraft and subject to the following conditions the Dealer or Soundcraft will repair or at its option replace the defective components. Any components replaced will become the property of Soundcraft. Any Equipment or component returned will be at the risk of the End User whilst in transit (both to and from the Dealer or Soundcraft) and postage must be prepaid.

This warranty shall only be available if:-

- a) The Equipment has been properly installed in accordance with instructions contained in Soundcraft's manual; and
- b) The End User has notified Soundcraft or the Dealer within 14 days of the defect appearing; and
- c) No persons other than authorised representatives of Soundcraft or the Dealer have effected any replacement of parts maintenance adjustments or repairs to the Equipment; and
- d) The End User has used the Equipment only for such purposes as Soundcraft recommends, with only such operating supplies as meet Soundcraft's specifications and otherwise in all respects in accordance with Soundcraft's recommendations.

Defects arising as a result of the following are not covered by this Warranty: faulty or negligent handling, chemical or electro-chemical or electrical influences, accidental damage, Acts of God, neglect, deficiency in electrical power, air-conditioning or humidity control.

The benefit of this Warranty may not be assigned by the End User.

End Users who are consumers should note their rights under this Warranty are in addition to and do not affect any other rights to which they may be entitled against the seller of the Equipment.

