SOUNDCRAFT CPS150

Console Power Supply

User and Technical Manual

For your own safety and to avoid invalidation of the warranty all text marked with these Warning Symbols should be read carefully.



IMPORTANT: please read this manual carefully before connecting your Soundcraft console power supply to the mains for the first time.



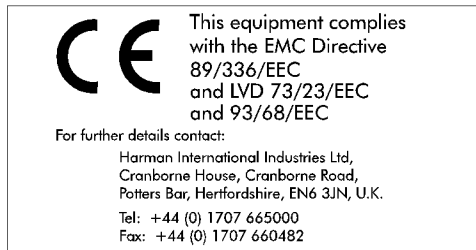

©Harman International Industries Ltd. 1991, 1996

All rights reserved

Parts of the design of this product may be protected by worldwide patents.

Part No. ZZ2739 Issue 2

Soundcraft is a trading division of Harman International Industries Ltd.

Information in this manual is subject to change without notice and does not represent a commitment on the part of the vendor. Soundcraft shall not be liable for any loss or damage whatsoever arising from the use of information or any error contained in this manual, any mis-operation or fault in hardware contained in the product.

No part of this manual may be reproduced, stored in a retrieval system, or transmitted, in any form or by any means, electronic, electrical, mechanical, optical, chemical, including photocopying and recording, for any purpose without the express written permission of soundcraft.

It is recommended that all maintenance and service on the product should be carried out by soundcraft., or its authorised agents. Soundcraft cannot accept any liability whatsoever for any loss or damage caused by service, maintenance or repair by unauthorised personnel.



Harman International Industries Ltd.

Cranborne House

Cranborne Road

Potters Bar,

Hertfordshire,

EN6-3JN,

England

Tel: 44 (0) 1707 665000 Fax: +44 (0) 1707 660482

CPS150 User & Technical Manual

IMPORTANT: PLEASE READ THIS MANUAL CAREFULLY BEFORE CONNECTING YOUR SOUNDCRAFT CPS150 POWER SUPPLY TO THE MAINS FOR THE FIRST TIME.

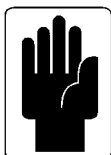

WARNING SYMBOLS

For your own safety and to avoid invalidation of the warranty all text marked as this paragraph should be read carefully.

FOR UK USERS ONLY

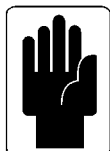

**IMPORTANT WARNING
THIS APPLIANCE MUST BE EARTHED**

The wires in the mains lead are coloured in accordance with the following code:

Green and Yellow:	Earth
Blue:	Neutral
Brown:	Live

As the colours of the wires in the mains lead may not correspond with the coloured markings identifying the terminals in your plug, proceed as follows:

- The wire which is coloured Green and Yellow must be connected to the terminal in the plug which is marked with the letter E or by the earth symbol.
- The wire which is coloured Blue must be connected to the terminal in the plug which is marked with the letter N or coloured Black.
- The wire which is coloured Brown must be connected to the terminal in the plug which is marked with the letter L or coloured Red.

Table Of Contents

Introducing the CPS150 1

Mains Voltage Selection 2

Replacing Mains Fuse 3

Recommendations for Installation 4

Location 4

Ventilation 4

Free standing 4

Earthing 4

Optional Rackmount fixing 5

General Precautions 5

CPS150 Technical Specification 6

Circuit Description 7

Mains Input 7

Secondary Circuits 7

Circuit description 7

Negative Supply Rails 9

Servicing 10

General 11

Application Guide 13

Warranty 14

Spare Parts

Introducing the CPS150

The CPS150 is a linear power supply which, like other linear supplies, produces DC voltages by rectifying, smoothing and regulating AC voltages from the secondary windings of a mains transformer.

In regulating these voltages there is some heat generated, the dissipation of which is achieved through a ventilated cover.

The CPS150 is designed to be free standing or it can be installed in a 19" rack. For rack mounting, an optional front panel provided with the necessary fixing holes can be obtained from Soundcraft (Part No. PP2288). Refer to the section "RECOMMENDATIONS FOR INSTALLATION" for details.

LED indication is provided on the front panel to show indication of operation of all regulating circuits.

FRONT PANEL OF CPS 150
NOTE: THREE SUPPLY INDICATION LEDS

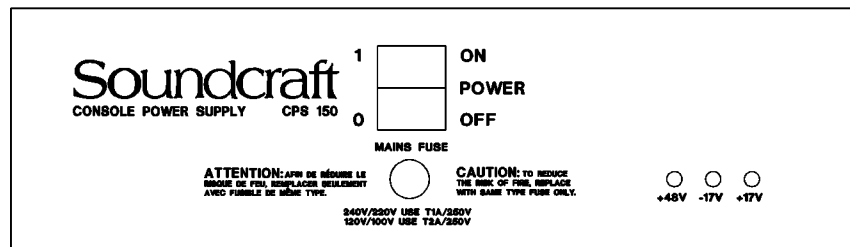

SAFETY APPROVAL: HD 195 S6 TYPE TESTED

This manual covers the CPS 150 unit, that has been type tested and conforms to the CENELEC Harmonised Document HD195 S6, consisting of IEC 65 (1985)ed 5 and BS 415 1990, with CENELEC deviations.

EMC CONDUCTED EMISSION

Certification of Conformity has been received for both:

USA Statutory Emission Requirements (FCC CFR47 Part 15J, A and B)

German Statutory Emission Requirements (VDE0871, A and B)

Mains Voltage Selection

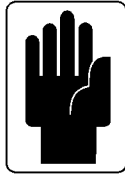

Special attention should be given to the following information:

This unit is capable of operating over a wide range of mains voltages by means of a comprehensive set of selectable voltage settings. It is important to ensure that the **correct** voltage setting has been selected for the level of local mains voltage supply, for safe, uninterrupted operation of the unit.

A **COVER PLATE** is secured to the back panel over the **VOLTAGE SELECTION** switches. A cut out in one corner of the cover plate indicates one of the mains voltages. It is essential that the **MAINS VOLTAGE** displayed by the cover plate corresponds to both the **LOCAL MAINS VOLTAGE** and the **VOLTAGE SELECTION** switches position.

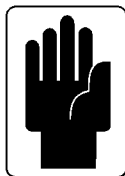

Do not change the voltage setting without first unplugging the mains lead.

There are two **MAINS VOLTAGE SELECTION** switches at the rear of the unit. Voltage selection is achieved by moving the switches using a screwdriver blade, into the correct positions, as shown by the symbols above the switches. In this way the unit is set up for operation at one of the following ranges of mains supply:

NOMINAL VOLTAGE	OPERATING VOLTAGE RANGE
Vrms AC	Vrms AC

240

216-264

220

198-242

120 (115)

108-132

100 NORM.

90-110

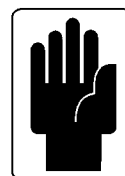

NOTE: The cover plate must be replaced after setting of the VOLTAGE SELECTION switches.

Replacing Mains Fuse

In the event of incorrect switching of the mains voltage selectors, a mains power surge or underrated fuse value, the mains fuse in the front panel will blow and the CPS150 will not function. Switch the ON/OFF switch back to the OFF position. Check the fuse and replace if necessary; also check that the voltage selection is correct for the mains supply level before switching the unit ON again.

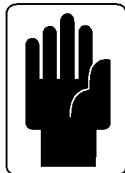

**TO AVOID RISK OF FIRE
REPLACE ONLY WITH THE
CORRECT VALUE FUSE, AS
INDICATED ON THE UNIT**

In the event of repeated failure of the mains fuse consult the Soundcraft dealer from where the unit was purchased.

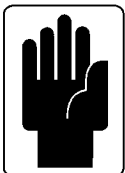

**THIS UNIT CONTAINS NO USER SERVICE-ABLE PARTS.
REFER ALL SERVICING TO A QUALIFIED SERVICE ENGINEER,
THROUGH THE APPROPRIATE SOUNDCRAFT DEALER.**

BACK PANEL OF CPS 150 SHOWING VOLTAGE SELECTION SWITCHES

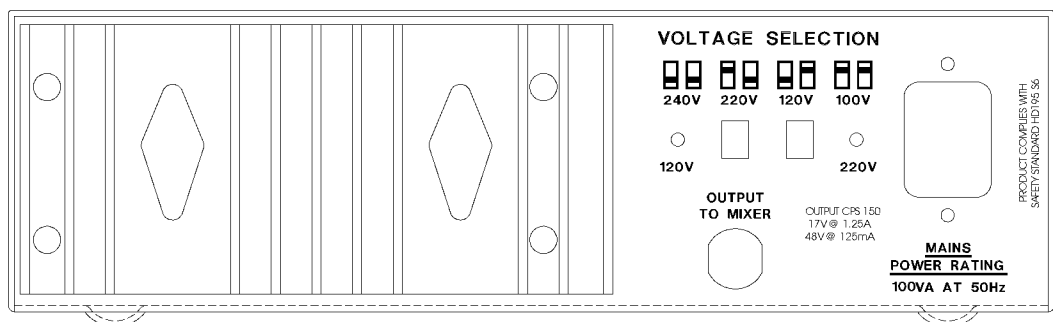

Voltage selector Cover Plates Indication



Recommendations for Installation

The CPS150 power supply can be provided with an optional front panel with fixing holes for 19" rack-mounting and will occupy 2U of rack space.

Location

As with any power supply that contains a large mains voltage transformer, it is preferable to provide a degree of physical isolation of the unit from other electronic equipment, particularly that which carries low level audio signals, to avoid any possible hum pick-up. For this reason the unit is provided with a long (3.0 metres) output cable to enable it to be positioned away from the mixing console.

For the same reason, when rack-mounting it is preferable to avoid locating the unit near to signal processing equipment.

It should be noted that if a complete rack containing a CPS150 unit is to be operated from a different mains supply level, then the unit should be withdrawn from the rack in order to reselect the mains voltage setting, at the same time as resetting any other equipment.

Ventilation

The other important consideration when rack-mounting the unit is the need for natural convection of air over the heatsink cooling fins.

Good ventilation *below* the unit, in the floor or back of the rack, and similarly *above* the unit, at the top of the rack, will ensure a path for continuous air flow.

Other equipment in the rack which is known *not* to produce a significant amount of heat should be mounted *below* the unit. Equipment that also relies on good air flow within the rack (i.e.. most power amplifiers and other power supplies) should be given due consideration and some space should be provided between such units and between these and the CPS150 unit. Forced convection, by means of a fan-tray, may be desirable in this situation.

Free standing

The CPS150 is designed to operate as a free-standing unit without requiring any special cooling arrangement, but should not be allowed to be accidentally or deliberately covered in any way.

Earthing

Finally, some consideration should be given to the earthing arrangement of the system at the centre of which are the console and the CPS150. The console chassis is earthed, to the mains earth, via the power supply. When rack-mounting the CPS150 care should be taken to avoid any possible 'ground loops' in the system which would introduce audible hum to otherwise clean audio signals. Ground loops may occur where signal processing equipment, patched to the console, has its signal earth commoned to the equipment chassis. The ground loop is formed if this chassis and the CPS150 chassis are in electrical contact through the fixing rails they share in the rack.

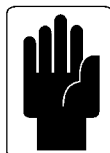

W A R N I N G
**UNDER NO CIRCUMSTANCES SHOULD THE MAINS EARTH
BE DISCONNECTED FROM THE CPS150 POWER SUPPLY UNIT**

Optional Rackmount fixing

- Remove the four front cover fixing screws.
- Place the rack mounting panel over the CPS 150.
- Secure the rack mounting panel to the CPS 150, fitting two screws to the top, and one to each side of the unit.

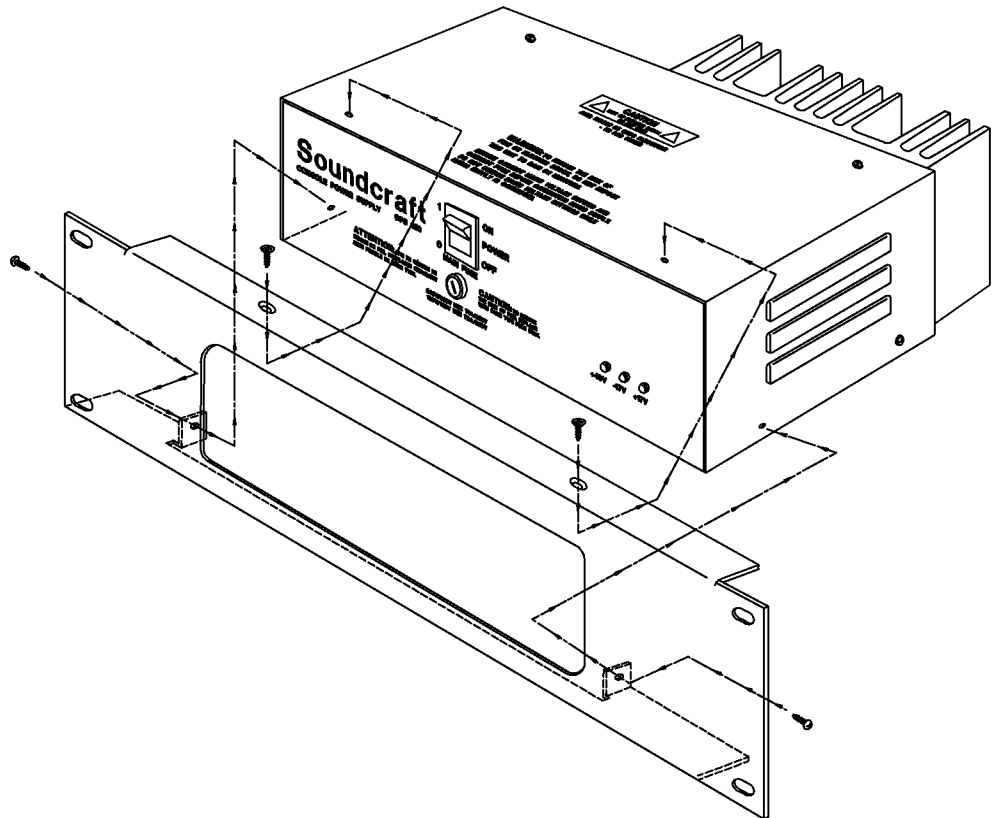

General Precautions

As with all electrical/electronic equipment some care should be taken when handling this unit. Avoid general mishandling and do not drop. Avoid storage and operation in dusty locations and do not expose to corrosive atmospheres.

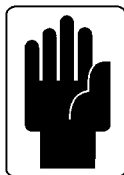

**TO AVOID RISK OF FIRE DO NOT EXPOSE
THIS UNIT TO RAIN OR MOISTURE.**

Retain all packaging for transportation in the event of the unit requiring servicing. Retain this manual, along with all other relevant documents, safely.

CPS150 Technical Specification

Mains input voltage range

240/220/120/100 V AC +/-10% @ 50/60Hz

Rated input power (max.)

100 VA

Mains fuse rating:

T1.0A 120/240 V AC

T2.0A 110/120 V AC(115V)

Outputs

DC Voltage rails	Max output current	Max noise
+17V	1.25 AMPS	-68 dBu
-17V	1.25 AMPS	-68 dBu
+48V	0.125 AMPS	-80 dBu

NOTE: All voltage current measurements are to be taken at the console end of the power supply cable

Operating temperature range (ambient)

-10 TO +50 C.

Humidity

Similar unit tested to 92% Relative Humidity at 40 C for 16 Hours. Load switched between 20% and 100% at regular 30 minute intervals.

Mechanical

Similar unit Drop tested to Military DEF.STAN 07-55 (part 2) Section 1/1.

Overall Dimensions

CHASSIS

HEIGHT: 85mm

WIDTH: (Chassis) 287mm

DEPTH: 190mm

OPTIONAL FRONT PANEL:

HEIGHT: 87mm (2U)

WIDTH: 482mm

WEIGHT:

Excl. Packaging: 4.0Kg

Packed incl. lead: 5.0Kg

Circuit Description

The CPS150 is a *Linear* power supply, the operation of which avoids the induction of switching noise, associated with switch-mode designs, in audio signal paths. It has been possible to produce a design which is silent in operation, and which will function over a greatly improved range of mains input voltages. Additionally, the design of each supply is very similar and of a *modular* format that will assist when servicing.

Mains Input

Refer to circuit diagram ED2770 which accompanies this section.

The mains supply is applied to the unit via the 3-pin IEC inlet on the unit back plate. The earth feed is led directly to the chassis earth stud: **AT NO TIME SHOULD THIS CONNECTION BE BROKEN**. The **LIVE** (black) and **NEUTRAL** (white) feeds are led to the double-pole rocker switch on the front of the unit, so that live and neutral switching to the following circuitry is made simultaneously.

From this switch, the neutral feed is led directly to the **MAINS PCB**. The live feed passes through the mains fuse (T1.0A 250V: 240V/220V or T2.0A 250V: 120V/100V) situated in the fuseholder on the front, below the ON-OFF switch, and from there to the **MAINS PCB**.

Secondary Circuits

The design of the regulator circuitry is essentially the same for each supply rail, but with different component values for the different voltage levels and power requirements of the rails.

Each regulator circuit is fused at the input from the transformer secondary winding, to protect against an over-current condition, in the event of component failure in the regulator circuit.

Regulation is achieved using positive, adjustable voltage regulators, each housed in a standard TO3 package, with the exception of the high voltage regulator for the +48v rail, which is in a TO220 package.

Circuit description

Each regulator circuit is essentially similar, and the following general description applies in each case. Component references are given for the +17V rail as a guide.

The **Mains Transformer** steps-down the mains voltage to produce the required alternating voltage across each **secondary winding**. The appropriate pair of lead-outs (same colour) are connected to the **REGULATOR PCB**. One side of this secondary feed is led directly to the bridge rectifier **BR1**, while the other is routed via the secondary protective fuse **F1** to the bridge rectifier. The level of the secondary voltage may be measured by applying an AC voltmeter across the desired pair of secondary lead-outs.

The voltage waveform between points 3 and 4 is full-wave rectified, and smoothed by a high value electrolytic capacitor **C1**, so that it appear as a DC voltage with a small AC 'ripple' element. This level may be measured with the voltmeter set for DC. A 100nF capacitor **C2** in parallel with the smoothing capacitor but closer to the regulator ensures its stability under any condition of capacitive load.

The regulator **REG1** is adjustable, the output voltage being set by a preset potentiometer in series with a fixed resistance **R2** between the adjustment pin and the "0V" reference. This allows a degree of adjustment equal to:

NOMINAL RATED OUTPUT VOLTAGE (V.dc) -10% +(10% + 0.7 V
(each preset is set and fixed at the factory test stage)

The actual regulated output voltage level is given by:

$$V_{out} = V_{ref} \times (1 + R_{adj}/R1) + I_{adj} \times R2$$

~ $V_{ref} \times (1 + R_{adj}/R1)$ as I_{adj} is negligible (~100uA)

The value of R1 is optimised for each regulator type:

For **LM338 REGULATORS REG 1, REG 2 R1 = 120R**

FOR **TL783C REGULATOR R1 = 82R**

The electrolytic capacitor **C3** in parallel with the adjustment resistor, **PR1 + R2** (R_{adj}), improves ripple rejection in the regulator, and also produces a time constant that causes the DC output of the regulator to rise more slowly when the unit is switched on. In the case of the +17V and -17 V rails the rise time is about 3 seconds.

The output filter capacitor **C4**, between the regulator output and the '0V' reference, eliminates 'ringing' and a slow regulator shut-down time in the event of the output becoming short-circuited.

The two diodes **D2** and **D1** around the regulator, situated between the adjust-output and output-input terminals, provide protection for low-current paths within the regulator in the event of a reverse-bias condition. This occurs when the regulator input voltage is less than the voltage present at the regulator output, causing the output filter capacitor **C4** and the capacitor across the adjustment resistor **C3** to discharge 'backwards' through the circuit. In this situation the reverse current would pass through the diodes instead of the regulator.

The **LED** and series resistor **R3**, across the output of the regulator provide a visual indication that the regulator circuit is operational, with the LED situated on the forward edge of the circuit board, projecting through the front panel of the unit.

The resistor **R3** provides a current limit of approximately 10mA through the LED in normal operation.

The regulated output voltage between the regulator output and the "0V" reference line is fed to the **DC OUTPUT CONNECTOR** on the back of the unit by a pair of 24/0.2 insulated wires that are soldered directly to solder pads on the circuit board.

Negative Supply Rails

All direct audio signal paths in the console require +17V and -17V supplies. The negative rail is derived using the same basic regulator circuit described above, but the regulator output is connected to the '0V' reference of the complementary positive supply rail through a link on the circuit board. This means that the '0V' reference of the negative supply rail becomes the negative output with respect to the regulator output terminal (for LM338 regulators the terminal is the case).

Shutdown Method for +/- 17V Outputs

Under normal operating conditions **TR1** and **TR2** are both inoperative, due to the potential divider **R4**, **R24** and **D7**.

If the +17V output shuts down due to fault conditions, this will cause a negative potential on the base of **TR1** to increase, and **TR1** will conduct. The voltage on the adjust pin of **REG2** will decrease and will close down **REG2** and the -17V output.

The same principle of operation will also apply to the +17V output if the -17V output should shut down under fault conditions.

<p style="text-align: center;">CAUTION UNDER NO CIRCUMSTANCES SHOULD TR1 OR TR2 BE REMOVED AS THIS WILL RESULT IN DAMAGE TO THE CONSOLE UNDER SOME FAULT CONDITIONS.</p>
--

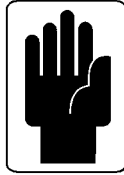

**THIS OPERATION SHOULD ONLY BE CARRIED OUT
BY A COMPETENT SERVICE ENGINEER.**

Initial operational tests on the power supply can be carried out by switching the unit ON and checking the voltages present on the output connector on the back of the unit. While the unit remains disconnected from the mixing console the DC voltage rails are floating with respect to each other, i.e. they do not all have a common reference within the unit. When connection is made to the mixing console various output pins become earthed to a common star-point, which has a mains earth return in the power supply cable itself.

An indication of obvious fault condition is the failure of one or more of the front-panel LED's to light. Note that due to the automatic shutdown circuit on the $\pm 17V$ rails, if a fault causes one rail to fail then the other rail will also shut down., and neither LED will be illuminated.

Any fault condition, with the exception of simple mains fuse failure due to underrating or an unusual mains input condition, will require removal of the top cover to enable correction of the fault. This is achieved using a No. 1 or No. 2 cross-head screwdriver to remove the eight retaining screws and washers.

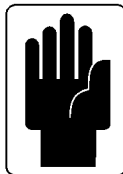

**ENSURE THAT MAINS POWER IS REMOVED FROM THE UNIT
BEFORE REMOVING THE TOP COVER**

Carefully lift the cover to avoid the earth connecting lead to the cover from snagging. Place the cover face down behind the unit.

SERVICING COMPONENTS

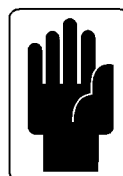

**REPLACEMENT OF ANY COMPONENTS SHOULD BE
UNDERTAKEN ONLY AFTER DISCONNECTING THE MAINS
SUPPLY LEAD FROM THE POWER SUPPLY UNIT.**

Replacement of any of the fuses and regulators in the power supply units is possible without the removal of the circuit board.

The fuses are held in open fuseholders on the board, close to the other components associated with that circuit. These can be carefully removed by hand.

The regulators that are in metal T03 packages can be removed by unscrewing the two M3 screws on each end and lifting them by hand.

If the electrically insulating SIL pad between the regulator and the heatsink bracket looks damaged then it should be replaced before installing the new regulator. Note that the regulators rely on good thermal contact with the heatsinks to dissipate heat. The regulator fixing screws are used for an electrical connection between the regulator output and the rest of the circuit on the PCB: the case of the T03 package is at the output potential of the device.

The +48V regulator is a TL783C high voltage device housed in a TO220 package. It can be removed by first withdrawing the PCB, desoldering the three legs and unscrewing the M3 fixing screw, taking care to retain the small insulating bush beneath the head of the screw. Again, an insulating SIL pad is used and this should be replaced if it appears to be damaged. The metal tab at the top of the package is at the output potential of the device, as is the centre lead. When refixing or replacing the device, it is preferable to screw the device down before resoldering the leads, to avoid placing a strain on the circuit board pads.



NOTE that the heatsink bracket is earthed through its mechanical contact with the rest of the chassis and so a faulty SIL pad may cause the output of its regulator to be connected to earth. In the case of a positive voltage rail the output then becomes short circuited when the mixing console is connected. In this case the regulator will shut down safely, unless faulty, and the associated front-panel LED will not light. In the case of a negative voltage rail the regulator output is normally earthed at the console anyway, and so a faulty SIL pad may not be so apparent. It may, however, affect the noise performance of the supply rail by producing a ground loop. This can be checked against the maximum expected noise figures listed in the 'Technical Specification'. Alternatively, if necessary the negative supply rail can be isolated from its complementary positive rail by removing the link on the circuit board, and an individual load can be applied across the output of the supply rail with the '0V' reference side commoned to the chassis. The front-panel LED will not light if the output is short-circuited.

To replace any other components in a regulation circuit it is also necessary to withdraw the circuit board.

First disconnect the leads to REG 1 and REG 2 by unplugging CN 1 and CN 2. Unscrew the three No. 4 self-tapping screws holding down the PCB. Remove the PCB, taking care not to damage the 3 LED indicators.

After servicing, re-assemble the unit in reverse, ensuring that all screws are fixed tightly and that the PCB supports are latched onto the board. Re-dress cable forms in their original positions and secure where applicable with cable ties.

General

Before replacing the top cover on the unit, carefully remove any dust from surfaces within the unit.



**CAREFULLY CHECK ALL WIRING CONNECTIONS
AND ENSURE THAT THERE ARE NO LOOSE PARTS
LYING AROUND INSIDE THE UNIT.**

INITIAL	ISSUE	DATE
DCB	3	12/11/95

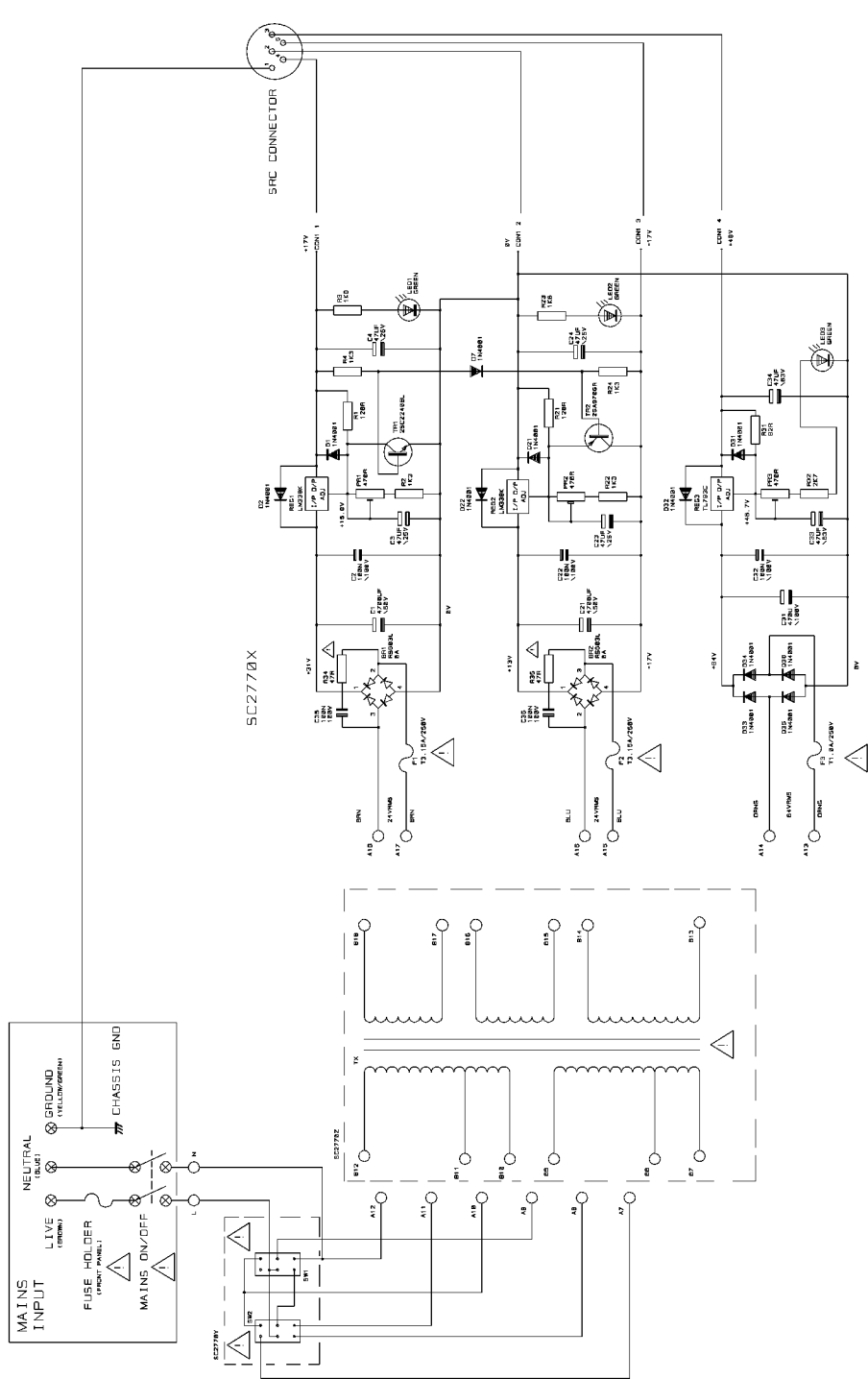

NOTES
 THE FRONT PANEL MAINS FUSE IS RATED AT:
 T1 . 8A/250V MAINS INPUT 220V/240V AC
 T2 . 8A/250V MAINS INPUT 110V/120V AC
 N.B. VOLTAGES SHOWN FOR NO LOAD.

DRN. J.H.

TITLE	CPS150
	POWER SUPPLY
DRG NO.	ED2770

Application Guide

Use only with recommended SOUNDCRAFT consoles

Power Connector Pinouts

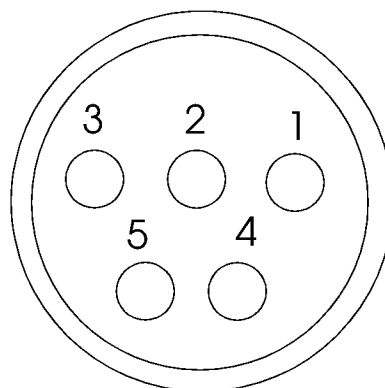

DC POWER INPUT

(viewed from cable end)

Pin	Function	Colour	PCB No
1	Protected Earth	(Green/Yellow)	Chassis
2	0V	(White)	CON1-2
3	+48v	(Grey)	CON1-4
4	+17V	(Brown)	CON1-1
5	-17V	(Blue)	CON1-3

Warranty

1 **Soundcraft** is a trading division of Harman International Industries Ltd.

End User means the person who first puts the equipment into regular operation.

Dealer means the person other than Soundcraft (if any) from whom the End User purchased the Equipment, provided such a person is authorised for this purpose by Soundcraft or its accredited Distributor.

Equipment means the equipment supplied with this manual .

2 If within the period of twelve months from the date of delivery of the Equipment to the End User it shall prove defective by reason only of faulty materials and/or workmanship to such an extent that the effectiveness and/or usability thereof is materially affected the Equipment or the defective component should be returned to the Dealer or to Soundcraft. Subject to the following conditions the Dealer or Soundcraft will repair or replace the defective components. Any components replaced will become the property of Soundcraft.

3 Any Equipment or component returned will be at the risk of the End User whilst in transit (both to and from the Dealer or Soundcraft) and postage must be prepaid.

4 This warranty shall only be available if:

a) the Equipment has been properly installed in accordance with instructions contained in Soundcraft's manual; and

b) the End User has notified Soundcraft or the Dealer within 14 days of the defect appearing; and

c) no persons other than authorised representatives of Soundcraft or the Dealer have effected any replacement of parts maintenance adjustments or repairs to the Equipment; and

d) the End User has used the Equipment only for purposes which Soundcraft recommends, with only such operating supplies as meet specifications and otherwise in all respects in accordance with Soundcraft's recommendations.

5 Defects arising as a result of the following are not covered by this Warranty: faulty or negligent handling, chemical or electro-chemical or electrical influences, accidental damage, Acts of God, neglect, deficiency in electrical power, air-conditioning or humidity control.

6 The benefit of this Warranty may not be assigned by the End User.

7 End Users who are consumers should note their rights under this Warranty are in addition to and do not affect any other rights to which they may be entitled against the seller of the Equipment.

Spare Parts

Spare Parts

Notes:

- 1) The 'Module/PCB Assemblies' section is indented to show those items which are part of another, higher level, item.
- 2) Some of the descriptions are followed by one of the following 3 symbols:
 - # - STATIC SENSITIVE. Anti-static precautions must be taken whilst handling this part.
 - ! - SAFETY CRITICAL PART. A part of a different type may not be substituted.
 - @ - A part from a specific Manufacturer. Using an equivalent from another manufacturer may lead to loss of performance.

Top-Level Structures

CPS150 POWER SUPPLY

RW8000

ISSUE 0	***PROCESS SHEET ISSUE***	AA
---	!NON ILL.RK SWT DPST(2600M11E)	DL8000
---	CON MTA.156 4WY CBL F/THRU	FC0255
---	!PNL MNT IEC MNS SKT	FJ8000
---	CABLE TIE 4.3"	LF0501
---	H20X20MM HELSYN SLEEVE BLUE	LF0512
---	NO.6X1/2"TYPE B CSK POZI BLACK	NA0073
---	M3X6MM PAN POZI BLK SCREW	NA0084
---	M3 X 8MM PAN POZI BLCK SCRW	NA0130
---	M3X12MM PAN POZI SCREW BLACK	NA0237
---	NO6X3/8" TYP B PAN POZI BLK SCR	NA0250
---	M3X25MM CSK POZI BLK SCR	NA0274
---	M3 NYLON INSERT NUT	NB0113
---	M4 NYLON INSERT NUT TYPE T	NB0127
---	M3 BLACK NYLON WASHER	NC0231
---	M3.5 BLACK NYLON WASHER	NC0232
---	M4 PLAIN STEEL WASHER ZNC CLR	NC0249
---	M3X16MM CLRNC SPCR NCKL PLT BR	ND0350
---	NO6 SPIRE CLIP SNU1219-17-4	NZ2249
---	!CPS150 COVER	PC8000
---	!CPS150 CHASSIS	PJ8000
---	!CPS150 COVER PLATE EUR	PJ8001
---	CPS150 PSU WFM	PV0446
---	!CPS150 PCB ASSY	RB8000
---	CPS150 HEATSINK ASSY	RS5080
---	DCP125 DC CABLE ASSY	RV3261
---	PSU EARTH SYMBOL SLF-ADH	ZA0078
---	!EARTH WARNING LABEL	ZA8005
---	!SERIAL NO/FRAGILE LBL"CE"	ZA8015
---	!5X20MM T1AX250V FUSE	ZD8001
---	!SCHRTR FUSEHOLDR F100031-1362	ZD8011
---	!SHRTR FUSECARR'R FEK0031-1371	ZD8012
---	HEYCO 1217 STRN RELIEF BUSH BL	ZZ2608
---	CPS150 CARTON	TA0143
---	CPS150 ETHA FOAM END CAP	TB0165
---	SLF SEAL BAGS+PNLS 31/2X41/2"	TZ2297
---	SLF SEAL BAGS PLN 123/4X123/4"	TZ2299
---	15"X 20" PLAIN POLY BAG 250GM	TZ2310
---	'FRAGILE LABEL' SELF ADHESIVE	ZA0075
---	"THIS WAY UP" LABEL SLF-ADH	ZA0084
F3	!5X20MM T1AX250V FUSE	ZD8001
SUPPLIE	!5X20MM T2AX250V FUSE	ZD8002
F1	!5X20MM T3.15X250V FUSE	ZD8003
F2	!5X20MM T3.15X250V FUSE	ZD8003
---	CPS150 MANUAL(SAFETY APPROVED)	ZZ2739

Main Assemblies

ISSUE 0

PROCESS SHEET ISSUE

AA

---	!NON ILL.RK SWT DPST(2600M11E)	DL8000
---	CON MTA.156 4WY CBL F/THRU	FC0255
---	!PNL MNT IEC MNS SKT	FJ8000
---	CABLE TIE 4.3"	LF0501
---	H20X20MM HELSYN SLEEVE BLUE	LF0512
---	NO.6X1/2"TYPE B CSK POZI BLACK	NA0073
---	M3X6MM PAN POZI BLK SCREW	NA0084
---	M3 X 8MM PAN POZI BLCK SCRW	NA0130
---	M3X12MM PAN POZI SCREW BLACK	NA0237
---	NO6X3/8" TYP B PAN POZI BLK SCR	NA0250
---	M3X25MM CSK POZI BLK SCR	NA0274
---	M3 NYLON INSERT NUT	NB0113
---	M4 NYLON INSERT NUT TYPE T	NB0127
---	M3 BLACK NYLON WASHER	NC0231
---	M3.5 BLACK NYLON WASHER	NC0232
---	M4 PLAIN STEEL WASHER ZNC CLR	NC0249
---	M3X16MM CLRNC SPCR NCKL PLT BR	ND0350
---	NO6 SPIRE CLIP SNU1219-17-4	NZ2249
---	!CPS150 COVER	PC8000
---	!CPS150 CHASSIS	PJ8000
---	!CPS150 COVER PLATE EUR	PJ8001
---	CPS150 PSU WFM	PV0446
1 X 320	32/0.2 BLACK WIRE	LA0012
1 X .33	32/0.2 WHITE WIRE	LA0021
1 X 300	32/0.2 YELLOW/GREEN WIRE	LA0023
---	1/4"CRIMP RCPTCLE CCT(CHAINED)	FG0629
---	3BA RING CRIMP TERMINAL	FG0634
---	H20X20MM HELSYN SLEEVE BLUE	LF0512

!CPS150 PCB ASSY

RB8000

ISSUE 0	***PROCESS SHEET ISSUE***	AA
R31	MF 0.25W RES 2% 82R	AD0423
R1, R21	MF 0.25W RES 2% 120R	AD0427
R2, R4, R22, R24	MF 0.25W RES 2% 1K3	AD0452
R3, R23	MF 0.25W RES 2% 1K6	AD0454
R32	MF 0.25W RES 2% 2K7	AD0459
R34, R35	!MF 0.25W RES 2% 47R FP 1/4	AD8000
---	!CPS150 PCB	GB8000
D1, D2, D7, D21, D22, D31, D32, D33, D34, D35, D36.	DIODE 1N4001	BA0005
---	BRIDGE RECTIFIER RS603L 6A	BC0216
TR2	PNP TRANS 2SA970GR (TAPED)	BD0301
TR1	NPN TRANS 2SC2240BL(TAPED)	BD0302
C2, C22, C32.35, C36	MICRO-BOX 5MM 5% 100V 100N	CC0250
C3, C4, C23, C24	VERT ELEC 0.2" TPD 47MF 25V	CE0401
C33, C34	VERT ELEC 0.2" 47UF 63V	CE0402
C1, C21	VERT ELEC 10MM 4700UF 50V	CE0414
C31	VERT ELEC 470MF/100V 16MM O/D	CE0436
LED1-3,	T1 3/4 5MM LED GREEN	JA0034
PR1, PR2, PR3	CERMET TRIMMER HORIZ 90H 470R	DE0407
SW1, SW2	!TW VOLTAGE SELECTOR SWT	DJ8000
CN1, CN2	MTHD 3WY .1" ML LCKG PLRSD HDR	FF0627
CON1,	MLX.156"4WY VRT M LCK HDR SQ P	FF0752

WT01148	!CPS150 MAINS TX	HB8005
HSK,REG	CPS150 REGULATOR/HEATSINK ASSY	RS5000
LED1,2,	HOLDER FOR 5MM LED PC MNT	ZC0222
F1, F2, F3, (2PER)	!SCHURTER FUSE CLIP	ZD0317
---	CPS150 PCB WFM KIT	PV0469

--- **CPS150 HEATSINK ASSY**

RS5080

REG1,2,	V.REG LM338K+1.2/32V 5A (T03)	BE0438
---	4BAX1/2" PAN POZI SCREW	NA0024
---	4BA NYLON INSERT NUT	NB0103
---	CPS150 MACHINED HEATSINK	PN1226
---	CPS150 HEATSINK REGULATOR WFM	PV0467
REG1,2,	T03 TRANS CLIP-ON COVER	ZC0211
---	KOOL PAD T03	ZC0219
---	T03 INSUL BUSH (BQ 2224)	ZC0220

--- **DCP125 DC CABLE ASSY**

RV3261

ISSUE 1	***PROCESS SHEET ISSUE***	AA
---	3BA RING CRIMP TERMINAL	FG0634
---	5WAY CABLE MOUNT SOCKET PLUG	FJ0820
---	6WY X.5MM GRY PVC COLOUR CODED	LD0311
---	H20X20MM HELSYN SLEEVE BLUE	LF0512
---	H50 WHT SLEEVE	LF0524
---	CPS150 CARTON	TA0143
---	CPS150 ETHA FOAM END CAP	TB0165
---	SLF SEAL BAGS+PNLS 31/2X41/2"	TZ2297
---	SLF SEAL BAGS PLN 123/4X123/4"	TZ2299
---	15"X 20" PLAIN POLY BAG 250GM	TZ2310
---	'FRAGILE LABEL' SELF ADHESIVE	ZA0075
---	PSU EARTH SYMBOL SLF-ADH	ZA0078
---	"THIS WAY UP"LABEL SLF-ADH	ZA0084
---	!EARTH WARNING LABEL	ZA8005
---	!SERIAL NO/FRAGILE LBL"CE"	ZA8015
---	!5X20MM T1AX250V FUSE	ZD8001
SUPPLIE	!5X20MM T2AX250V FUSE	ZD8002
F1, F2	!5X20MM T3.15X250V FUSE	ZD8003
---	!SCHRTR FUSEHOLDR F100031-1362	ZD8011
---	!SHRTR FUSECARR'R FEK0031-1371	ZD8012
---	HEYCO 1217 STRN RELIEF BUSH BL	ZZ2608
---	CPS150 MANUAL(SAFETY APPROVED)	ZZ2739

