

**Bargraph Display**

---

---

**Contents**

page

---

1. Technical Description .....	1
2. Technical Data .....	4
3. Alignments and Settings.....	6
3.1 Adjustments .....	6
3.2 Connections.....	7
3.3 Function Settings.....	9
4. Block Diagram.....	10
5. Schematics.....	11

REFERENCE

---

This manual refers to the following units:

Dual Bar Graph PPM	1.913.111
Dual Bar Graph VU	1.913.112
8 Channel Bar Graph PPM	1.913.411
8 Channel Bar Graph VU	1.913.412

## 1. Technical Description

---

---

The output meter, whatever it may be called, is one of the most important tools in audio engineering. Wherever audio signals are being processed, it is an essential, because the output level is an important criterion. On the one hand, maximum output level is needed for achieving the best signal-to-noise ratio, on the other hand the reference level should not be exceeded, particularly in digital recordings, otherwise distortion will increase dramatically.

Two types of output meters with different dynamic characteristics have proven themselves useful in recording studios:

### Volume Unit Meter (VU)

The most frequently used instrument for measuring audio frequency signal levels is the VU-meter. In the ANSI standard (American National Standards Institute, Inc.), the mechanical and electrical behavior of the VU-meter was already defined in 1954. The rule is that the indication shall be 99% of the ultimate value (0 VU) when a signal of 0.3 s (300 ms) duration is applied. The overshooting of the indication shall be between 1...1.5%. The rise and decay time are identical in the VU-meter.

In the conventional version a VU-meter consists of a suitable moving coil instrument and a full-wave rectifier connected to the input.

### Peak Program Meter (PPM)

The PPM is a more recent instrument. Its behavior is defined in the applicable DIN or IEC standards. The principal difference to the VU-meter is in the integration time: the PPM is a quasi peak value instrument with a long release time. A peak value will be indicated even for very short peaks in a music program.

If a sine wave voltage is applied for 10 ms that yields a level of 0dB, the indication should be -1dB. A release time of 1.7 s is desired for levels down to -20dB (IEC).

### Instrument Types

An advanced alternative to electromechanical analog displays are the gas discharge bargraph displays. Neon gas that is induced to glow between two glass plates emits visible light. The plasma display has some decisive advantages over all the other displays. For example: large reading angle and high contrast combined with low power consumption and long life. Its disadvantages are: high anode voltage (250 V), high price, and sophisticated electronic circuitry. Despite these drawbacks this excellent type of display has become the de-facto standard in professional studio applications.

### Implementation of the Studer Bargraph Output Meters

The design specifications for a precision metering instrument that would not be too costly but still have a modular design resulted in the following arrangement; two individual circuit boards, one for the two-channel signal processing paths and one for the digital section with the switching power supply. In this way it became feasible to achieve a modular design: four signal modules for eight channels but only one digital module.

## BARGRAPH

The operating principle of the individual elements that make up the bargraph display is depicted in the following picture:

## Plasma Tube

After the 250 VDC supply voltage has been applied, a continuous glow discharge is triggered between the pre-ionization anode and cathode. Since the area around the pre-ionization segment is not physically isolated from the neighboring segments, the charge carriers diffuse into the area of the reset cathode. When the latter is energized first, a glow discharge occurs also here. The same effect causes the first segment to light up (ignite), if the reset cathode is switched off while cathode 1 is switched on. Although each 5th segment is electrically interconnected, only the lowest one glows because sufficient charge carriers are located in its vicinity.

The cathodes 1-2-3-4-5 / 1-2-3-4...etc. are now controlled in this order. The glow discharge migrates segment by segment to the last segment. A new cycle is then initiated by means of the reset segment.

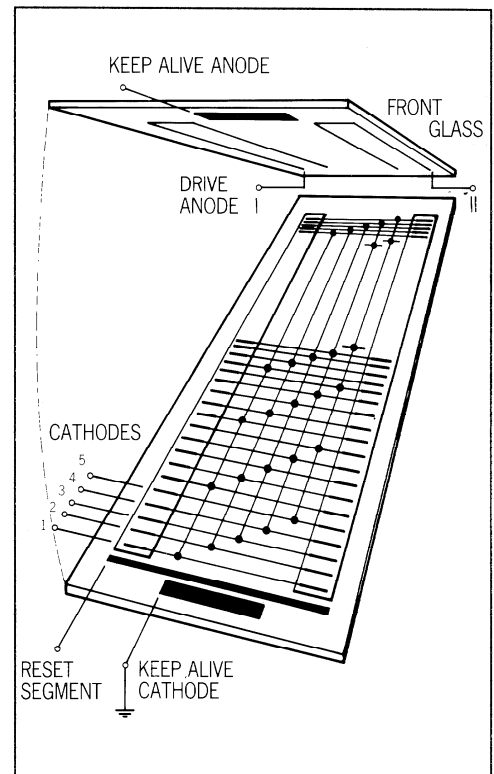

Plasma tube

The length of the bargraph is controlled by the power-on duration of the corresponding anode while the cathodes are controlled cyclically in the dark segment. This design requires only 8 connections or driver stages (2 anodes, 1 reset cathode and 5 write cathodes) for controlling the 2 x 200 segments. In order to create a flicker-free bargraph the refresh rate must be at least 70 Hz. Unnoticeable to the viewer is, however, that only one segment glows at any one moment!

## Analog Electronics

The audio section is shown in the block diagram (see p.12). The isolated AF signal is taken to the level stage; the large working range permits the connection of almost any level. For very small levels a +20 dB amplifier is provided. The low-pass filter of the 3rd order attenuates frequencies of over 20 kHz. This circuit is followed by a sophisticated rectifier stage that compensates very carefully with respect to the offset voltages.

For the VU representation, the rectified signal is fed to a filter that duplicates the characteristic of mechanical moving coil instruments. For the PPM representation, the peak value of the rectified signal is formed.

### Digital Electronics

The digital section performs various functions. Not only does it process the signals for the plasma tube, it also is responsible for generating the ramp. A totally new approach has been selected for the ramp generation. Normally the audio signal is converted to logarithmic characteristic in an amplifier in order to achieve dB representation. The resulting signal is subsequently compared with a time-linear ramp. However, the same can be accomplished by comparing the linear AF signal with an exponential ramp, without the typical problems of a logarithmic circuit (temperature dependence, offset). In addition, more instruments can be controlled by means of a ramp (in the digital section); no logarithmic circuits are required.

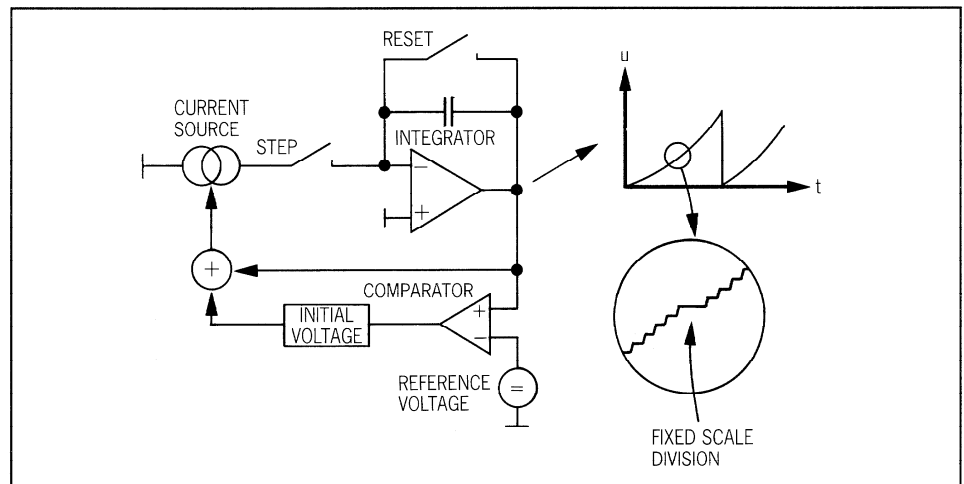

**Ramp generator**

While a capacitor is charged with a constant current, the terminal voltage rises linearly. If this source is equipped with a positive feedback that converts the continually rising voltage to a continually increasing current, we obtain an exponentially progressing terminal voltage.

If the capacitor is discharged after a while, the initial voltage for starting the cycle is missing. A control circuit is available that prepares the initial voltage in such a way that a reference value is achieved after a certain time.

For inserting fixed scale divisions, the capacitor charging is interrupted during three cycle units. As a result the corresponding segment glows three times longer and consequently appears to be brighter.

By disconnecting the above mentioned positive feedback, the linear ramp is again obtained for representing VU values or representable DC values.

The ramp oscillator also supplies the input signal for a binary counter that increments until reset. The outputs of the counter are address lines for an EPROM which generates the 5-phase signal and a reset signal for creating the fixed scale divisions as well as a reset signal for the counter. With the two remaining address lines it is possible to insert different scale divisions.

### Future Application

The new bargraph instrument also features a LED column for indicating limiter or compressor gain reduction signals. With the externally controllable selection of VU or PPM characteristic it is also possible to display DC voltages on linear or logarithmic scale. The built-in switching power supply supports a large range of DC supply voltages.

For PCM recordings a faster response time ( $t = 0.1 \text{ ms}$ ) may be selected by a switch.

## BARGRAPH

## 2. Technical Data

## PEAK PROGRAM METER SPECIFICATION

Reference Indication	0 dB = 0 dBu .... + 15 dBu
Indicating Range	+ 5 dB .... - 40 dB
Error	± 0.2 dB (± 2 segments) within + 5 dB and - 40 dB
Frequency Response	± 0.5 dB between 31.5 Hz and 16 kHz at 0° C .... 50° C
Dynamic Response	according to IEC publication 268-10 1974:

SINGLE BURST	FREQUENCY	DEFLECTION VALUE	SLOW TOLERANCE	DEFLECTION FAST
10 ms	3 kHz	- 1 dB	± 0.5 dB	-0,3 dB
5 ms	3 kHz	- 2 dB	± 1 dB	-0,6 dB
3 ms	3 kHz	- 4 dB	± 1 dB	-0,8 dB
0.4 ms	10 kHz	- 15 dB	± 3 dB	-1,0 dB

Overswing	none
Return Time	0 dB .... - 20 dB: 1.7 ± 0.3 seconds

## VU-METER SPECIFICATION

Reference Indication	0 VU = - 4 dBu .... + 11 dBu
Indicating Range	+ 3 VU .... - 20 VU, voltage linear
Frequency Response	+ 1.0/- 0.0 dB at 0 VU and 31.5 Hz; Temperature range 0° C .... 50° C
Response Time	207 ms (± 30 ms) to - 1 VU of reference indication
Overswing	1 ... 1.5 %
Return Time	207 ms (± 30 ms).

**DC METER SPECIFICATION****Display Range**

INDICATION	NORMAL			REVERSE
	TOP END	0 V	0 V	- 1 V
BOTTOM	+ 10 V	+ 6 V	+ 6 V	- 10 V

There is mutual influence between the alignment of 'Top End' and 'Bottom' indication. The values in the row 'Normal' are ment to be examples for possible settings.

**GENERAL SPECIFICATIONS**

<b>Input Impedance</b>	> 10 kOhm
<b>Source Impedance</b>	< 1 kOhm
<b>Reversibility Error</b>	< 0.5 dB
<b>Temperature Range</b>	error $\pm$ 0.5 dB in the range - 10° C ... + 60° C (reference: 1 kHz at 25° C)
<b>Supply Voltage</b>	24 V ... 34 V (or $\pm$ 15 V)
<b>Power Consumption</b>	dual unit: 3.5 W typ., 5.0 W max. 8 channels: 9.5 W typ., 14.5 W max.
<b>Mechanical Dimensions</b>	dual unit: 40 mm(W) x 170 mm(H) x 130 mm(D) 8 channel unit: 160 mm(W) x 170 mm(H) x 130 mm(D)
<b>Weight</b>	dual unit: 640 g 8 channel unit: 1600 g

**GR METER SPECIFICATION**

<b>Input Range</b>	$\pm$ 2 V ... $\pm$ 5 V for + 20 dB indication
--------------------	--

## BARGRAPH

### 3. Alignments and Settings

---

**Note:** The Analog Print 1.913.117 contains two channels, so each adjustment pot exists twice. All adjustments have to be performed on all channels.

The Digital Print 1.913.118 exists only once per unit, be it a two or eight channel device.

#### 3.1 Adjustments

---

##### Level Setting

For adaptation to different line levels only the following adjustment is necessary:

- Feed reference level 1 kHz (e.g. +6 dBu)
- adjust 0 dB indication on bargraph with R 5 (R 105) Potentiometer is marked **AUDIO GAIN**

##### Complete Adjustment

In case of part exchange a full adjustment procedure may be necessary. In this case proceed in the following steps:

**AC Input:** Set unit to "PPM", "+20 dB off", and "Not fast" (see below)

- Disconnect input, terminate input with 200 Ohm
- adjust minimal level ( $0 \pm 1$  mV) at pin 7 of IC 6 (internal potentiometer)
- Feed reference level 1 kHz (e.g. +6 dBu)
- adjust 0 dB indication on bargraph with R 5 (R 105). Potentiometer is marked **AUDIO GAIN**
- Feed 20 dB below reference level 1 kHz (e.g. -14 dBu)
- adjust -20 dB indication with R 64 (potentiometer on digital print; do not readjust after the first channel has been properly adjusted)
- Feed 30 dB below reference level 1 kHz (e.g. -24 dBu)
- adjust -30 dB indication with R 30 (R 130). Potentiometer is marked **AUDIO OFFSET**
- Repeat all steps until all indications are correct.

**DC Input:** Set unit to "DC" and adjust the wanted input phase configuration (see below).

- Feed maximum DC voltage.
- Adjust maximum indication with R 55 (R 155). Potentiometer is marked **DC GAIN**
- Feed minimum DC voltage
- Adjust minimum indication with R 63 (R 163). Potentiometer is marked **DC REF**
- Repeat all steps until all indications are correct.

- GRM Input:**
- Feed level 1 kHz required for a indication of +20 dB on the gain reduction meter.
  - Adjust indication with R 60 (R 160). Potentiometer is marked **GRM**

3.2 Connections

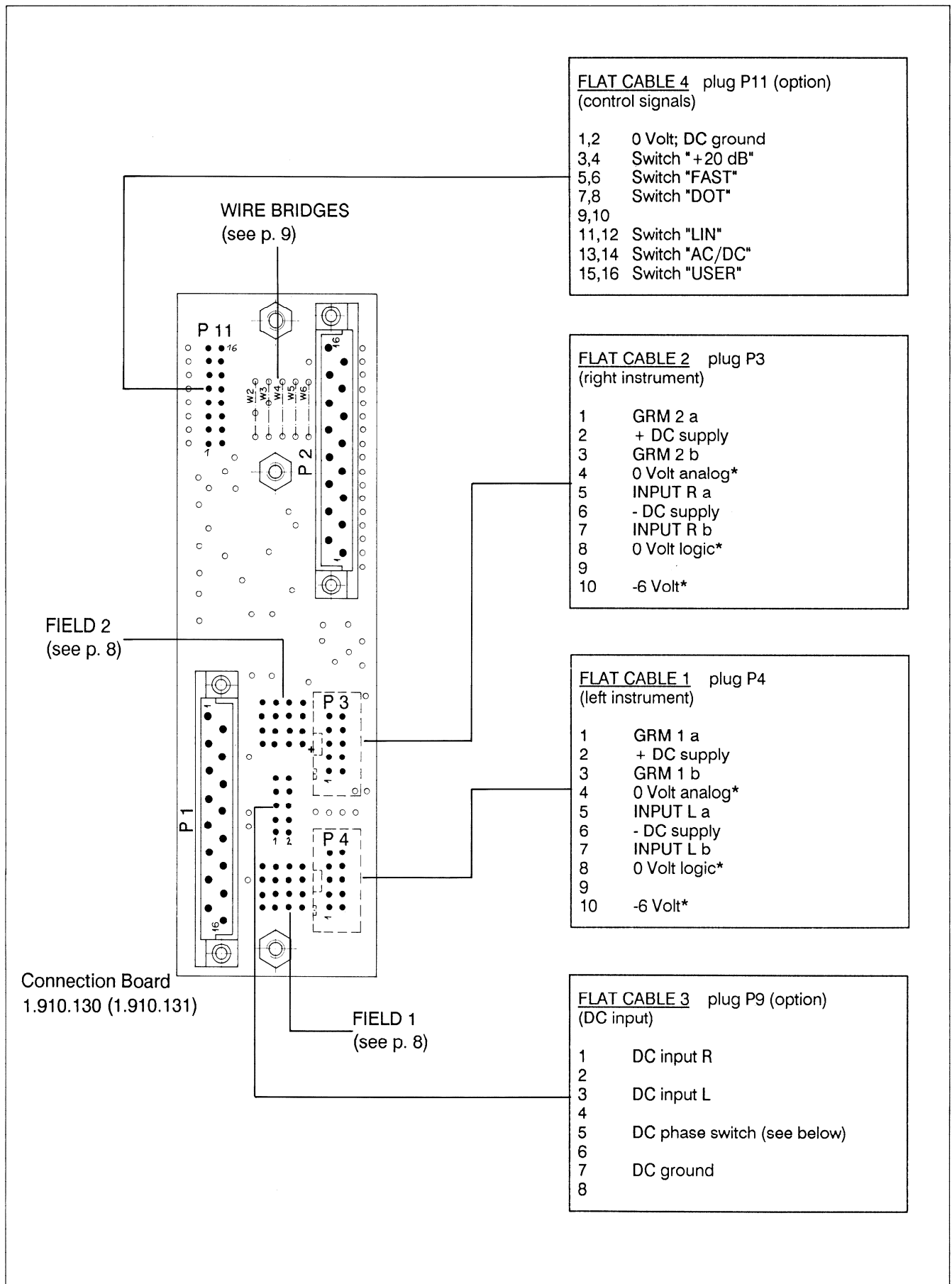

- FLAT CABLE 4** plug P11 (option)  
(control signals)
- 1,2 0 Volt; DC ground
  - 3,4 Switch "+20 dB"
  - 5,6 Switch "FAST"
  - 7,8 Switch "DOT"
  - 9,10
  - 11,12 Switch "LIN"
  - 13,14 Switch "AC/DC"
  - 15,16 Switch "USER"

- FLAT CABLE 2** plug P3  
(right instrument)
- 1 GRM 2 a
  - 2 + DC supply
  - 3 GRM 2 b
  - 4 0 Volt analog\*
  - 5 INPUT R a
  - 6 - DC supply
  - 7 INPUT R b
  - 8 0 Volt logic\*
  - 9
  - 10 -6 Volt\*

- FLAT CABLE 1** plug P4  
(left instrument)
- 1 GRM 1 a
  - 2 + DC supply
  - 3 GRM 1 b
  - 4 0 Volt analog\*
  - 5 INPUT L a
  - 6 - DC supply
  - 7 INPUT L b
  - 8 0 Volt logic\*
  - 9
  - 10 -6 Volt\*

- FLAT CABLE 3** plug P9 (option)  
(DC input)
- 1 DC input R
  - 2
  - 3 DC input L
  - 4
  - 5 DC phase switch (see below)
  - 6
  - 7 DC ground
  - 8



BARGRAPH

If the unit is powered by an unstabilized DC supply, an additional C may be installed (1000  $\mu$ F, 40 Volt, Order No. 59.22.6102).

Signals marked with an asterisk (\*) are not required for the bargraph.

The lines carrying the AC bargraph input and the GRM input signals may also be soldered to the unit (instead of feeding those signals via the flat cables; especially useful for operation outside STUDER mixers). The connection points are:

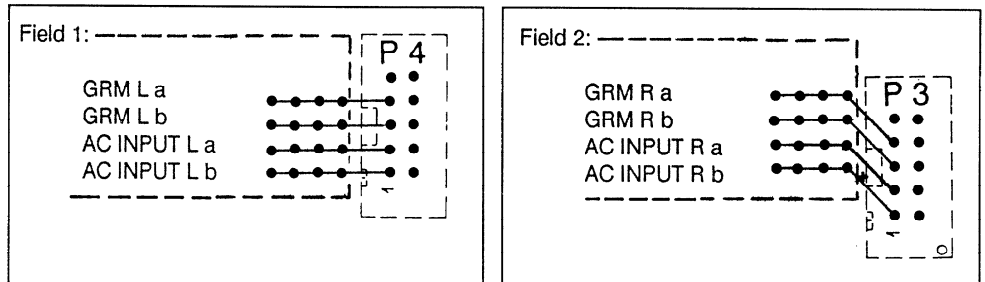

DC Supply

DC can be fed either via flat cable 1 or 2 or directly to the pins marked "+" and "-".

### 3.3 Function Settings

Some functions can be set both by wire bridges and by external switches. Do not duplicate!

#### Wire Bridges

BRIDGE	ON	OFF	
W2	■	■	INSTRUMENT ATTACK TIME 0.1 ms STANDARD ATTACK TIME (10 ms in PPM mode)
W3	■	■	GRM INDICATION AS SINGLE DOT GRM INDICATION AS BAR
W4			(reserved for future use)
W5 W6		■ ■	PPM INDICATION
W5 W6	■	■	VU INDICATION
W5 W6		■	DC LOG INDICATION
W5 W6	■	■	DC LIN INDICATION

#### External Switches

"ON" means that either the pin is connected to ground (pin 1/2) or that a TTL low level is connected. "OFF" means that either the switch is open (internal pull-up resistor) or that a TTL high level is connected.

All external switches are connected via flat cable 4 (see above).

PIN	ON	OFF	
1,2			0 VOLT
3,4	■	■	AC GAIN +20 dB AC GAIN 0 dB
5,6	■	■	INSTRUMENT ATTACK TIME 0.1 ms STANDARD ATTACK TIME (10 ms in PPM mode)
7,8	■	■	GRM INDICATION AS SINGLE DOT GRM INDICATION AS BAR
11,12	■	■	LIN INDICATION (if DC selected), VU INDICATION (if AC selected, see 13/14) LOG INDICATION (if DC selected), PPM INDICATION (if AC selected, see 13/14)
13,14	■	■	DC AC
15,16	■	■	USER SWITCH: LED ON FRONT PLATE ON LED ON FRONT PLATE OFF



---

---

## 5. SCHEMATICS

---

---

1. **Bar Graph 1 Unit (VU or PPM)**
  - General..... 1.913.111 / 112
  - Display Board..... 1.913.119
  - Connection Board ..... 1.910.130
  
2. **Bar Graph 4 Units (VU or PPM)**
  - General..... 1.913.411 / 412
  - Display Board..... 1.913.419
  - Connection Board ..... 1.910.131
  
3. **Dual Bargraph circuit diagram..... 1.913.111/112**
  - Digital Board (1 Unit and 4 Units)..... 1.913.117
  - Analog Board (1 Unit and 4 Units) ..... 1.913.118

Bargraph 1 Unit (PPM or VU) 1.913.111.81 / 112.81

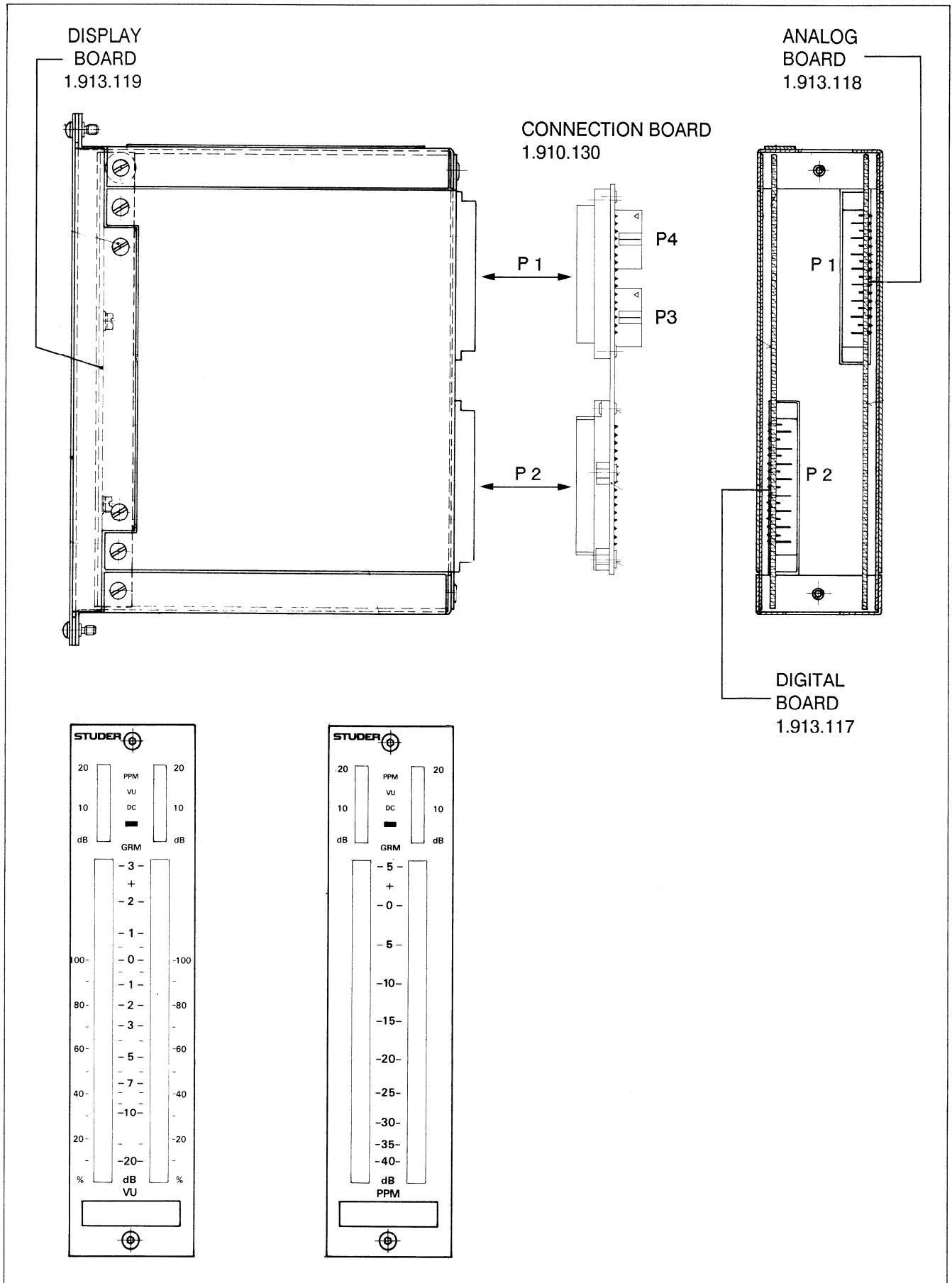

BARGRAPH

Display Board 1 Unit 1.913.119.00

**Bestückungsseite**

**Lötseite**

IND.	POS.NO.	PART NO.	VALUE	SPECIFICATIONS / EQUIVALENT	MANUF.
B.....1		89.01.4800		PLASMA-BAR-GRAPH 200 BARS, 5 PHASES	
C.....1			not used		
C.....2		59.31.8333	33 nF	+5% 400V MPC	
C.....3			not used		
DL.....1		50.04.2119	MV57124	red	
DL.....2		50.04.2119	MV57124	red	
DL.....3		50.04.2119	MV57124	red	
DL.....4		50.04.2119	MV57124	red	
DLZ...1		50.04.2150		led bar-graph red	
DLZ...2		50.04.2150		led bar-graph red	
IC....1		50.11.0119	LM3914N	led bar driver linear	NS
IC....2		50.11.0119	LM3914N	led bar driver linear	NS
L.....1		62.03.0005	250uH	coil	
L.....2		62.03.0005	250uH	coil	
MP....1		53.03.0175	2 pcs	IC-socket 18 pin	
MP....2		1.913.119.11	1 pcs	Print	
MP....3		1.913.111.03	1 pcs	Chassis 1E	0
MP....4		1.913.111.07	1 pcs	Isolation 1E	
MP....5		21.01.0352	2 pcs	Zylinder-schrauben M3x4	
MP....6		24.16.1030	2 pcs	Schnorr M3	
MP....7		23.01.1032	2 pcs	Unterlagsscheiben M3	
P.....5		54.01.0215		Cis Stecker 12 Pol	
P.....6		54.01.0241		Cis Stecker 4 Pol	
P.....7		54.01.0294		Cis Stecker 16 Pol	
P.....8		54.01.0289		Cis Stecker 8 Pol	
R.....1		57.11.3472	4.7 kOhm	5% 0.25W	
R.....2		57.11.3242	2.4 kOhm	5% 0.25W	
R.....3		57.11.3472	4.7 kOhm	5% 0.25W	
R.....4		57.11.3105	1 MOhm	5% 0.25W	

STUDER (00) 87/11/24 AE DISPLAY UNIT 1E PL 1.913.119.00 PAGE 1

IND.	POS.NO.	PART NO.	VALUE	SPECIFICATIONS / EQUIVALENT	MANUF.
MANUFACTURER: Bu=Burdny, Ex=Exer, Fc=Fairchild, GI=General Instrument, HP=Hewlett Packard, IIT=Intermetall, Mot=Motorola, Nat=National (Matsushita), NS=National Semiconductors, Ph=Philips, Ra=Raytheon, Sig=Signetics, Six=Siliconix, St=Studer, TI=Texas Instrument, Si=Siemens, Ie=Intersil, Un=Unitrode					

ORIG 87/11/24  
STUDER (00) 87/11/24 AE DISPLAY UNIT 1E PL 1.913.119.00 PAGE 2

Bargraph Connection Board 1 Unit 1.913.130.00

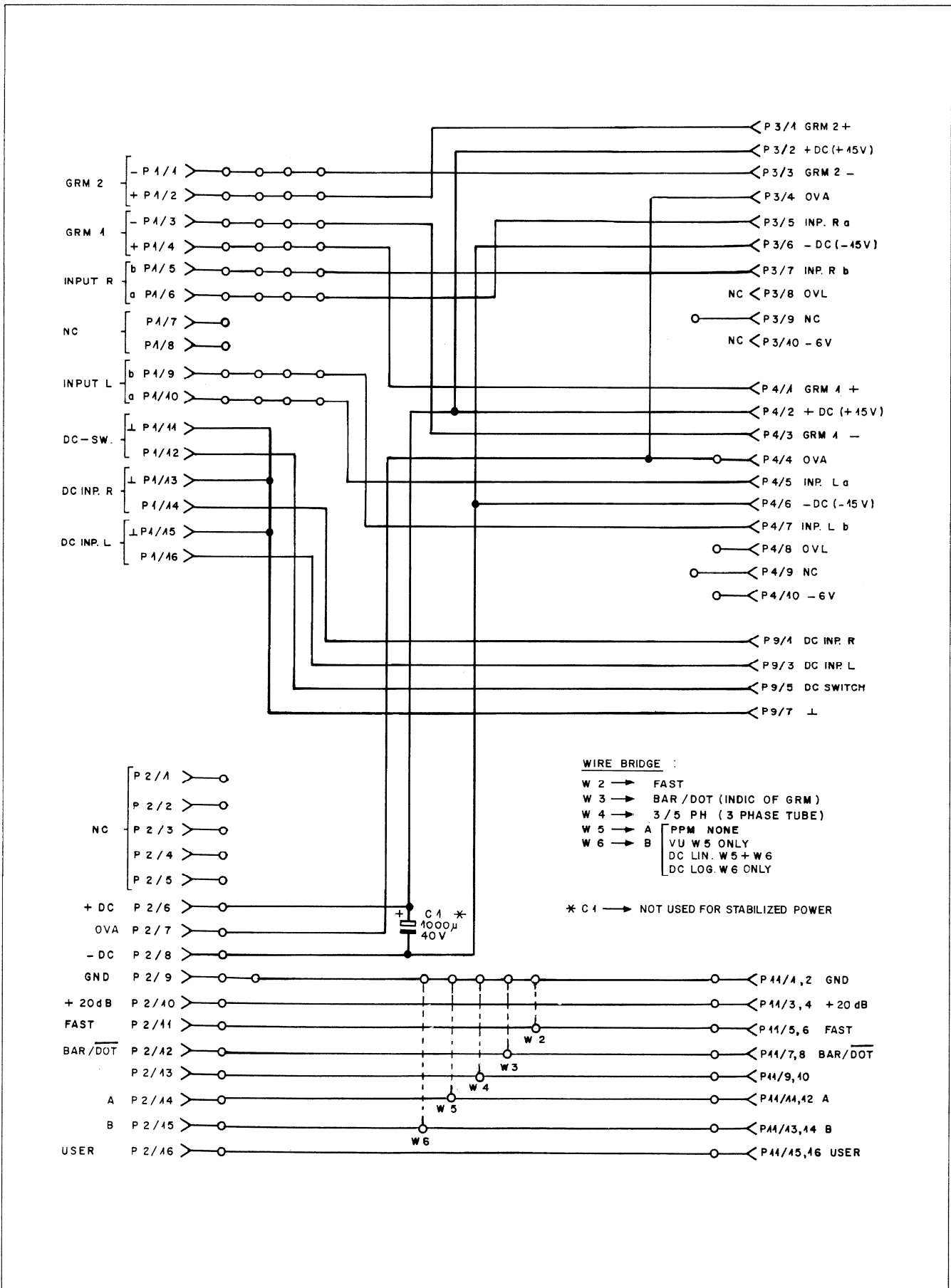

BARGRAPH

Bargraph Connection Board 1 Unit 1.913.130.00

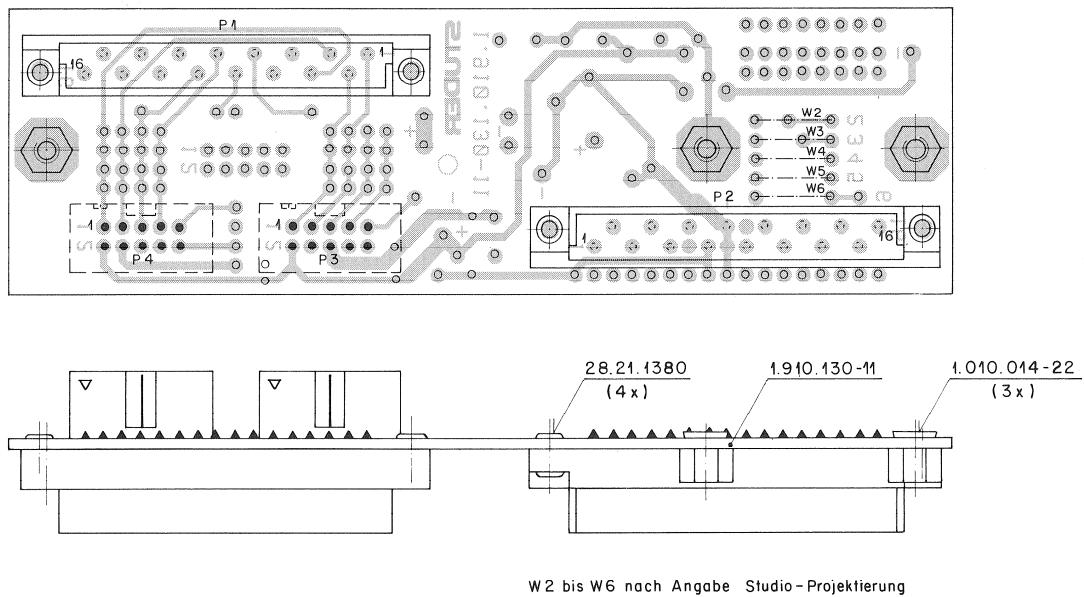

W2 bis W6 nach Angabe Studio-Projektierung



Bargraph 4 Units (PPM or VU) 1.913.411.81 / 412.81

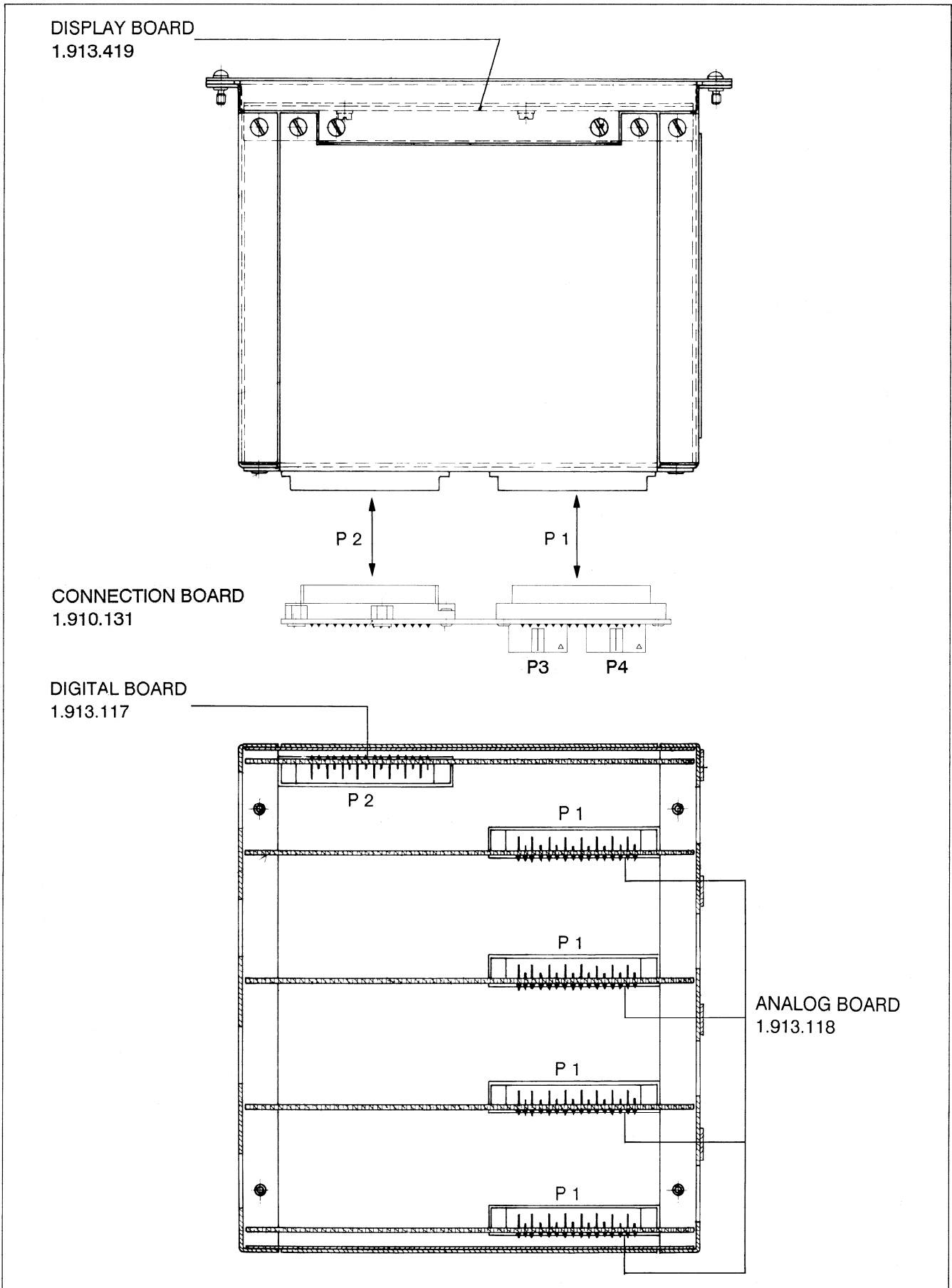

BARGRAPH

Display Board 4 Units 1.913.419.00

The Display Board 4 Units is adequate to four display boards for one unit each.  
For details see schematic number 1.913.119.

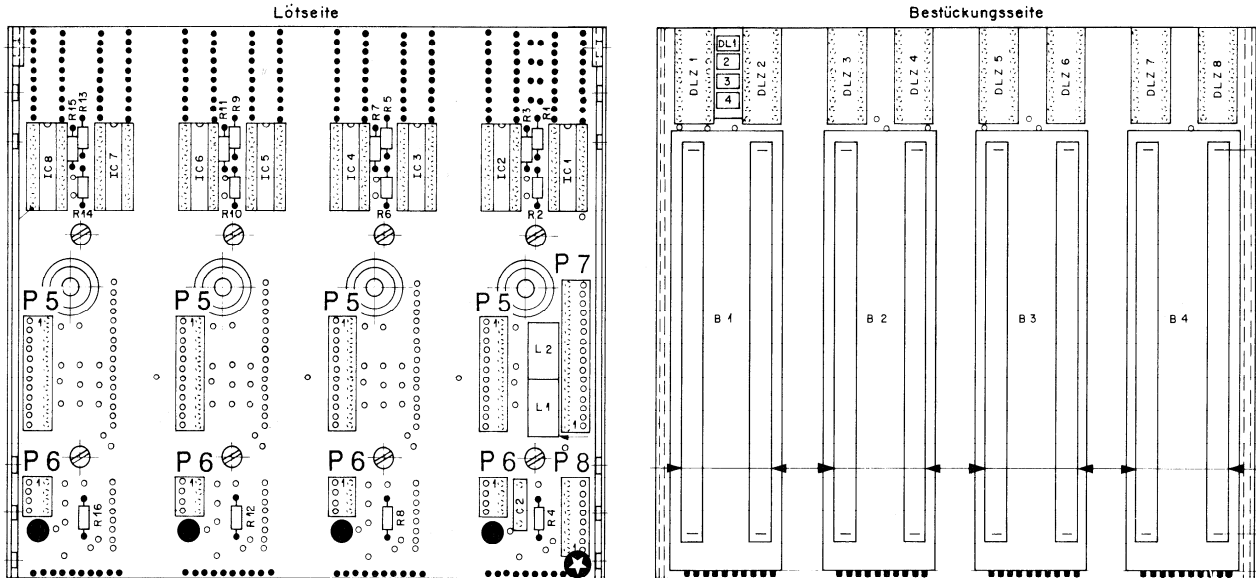

- ANALOG BOARD  
1.913.118
- ★ DIGITAL BOARD  
1.913.117

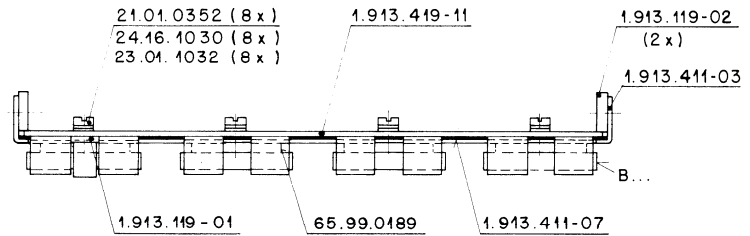

Bargraph Connection Board 4 Units 1.910.131

This Board combines four connection boards for one unit on a single print.  
For details please see 'Connection Board 1 Unit 1.910.130'.

IND.	POS.NO.	PART NO.	VALUE	SPECIFICATIONS / EQUIVALENT	MANUF.	IND.	POS.NO.	PART NO.	VALUE	SPECIFICATIONS / EQUIVALENT	MANUF.
B....1		89.01.4800		PLASMA-BAR-GRAPH 200 BARS, 5 PHASES		MP....3			1 pcs	Chassis 4E	
B....2		89.01.4800		PLASMA-BAR-GRAPH 200 BARS, 5 PHASES		MP....4			1 pcs	Isolation 4E	
B....3		89.01.4800		PLASMA-BAR-GRAPH 200 BARS, 5 PHASES		MP....5	21.01.0352		2 pcs	Zylinderschrauben M3*4	
B....4		89.01.4800		PLASMA-BAR-GRAPH 200 BARS, 5 PHASES		MP....6	24.16.1030		2 pcs	Schraur M3	
C....1			not used			MP....7	23.01.1032		2 pcs	Unterlagscheiben M3	
C....2		59.31.8333	33 nF	+-5% 400V MFC		P....5	54.01.0215			Cia Stecker 12 Pol	4 Stueck
C....3			not used			P....6	54.01.0241			Cia Stecker 4 Pol	4 Stueck
DL....1		50.04.2119	MV57124	red		P....7	54.01.0294			Cia Stecker 16 Pol	1 Stueck
DL....2		50.04.2119	MV57124	red		P....8	54.01.0289			Cia Stecker 8 Pol	1 Stueck
DL....3		50.04.2119	MV57124	red		R....1	57.11.3472	4.7 kOhm	5%	0.25W	
DL....4		50.04.2119	MV57124	red		R....2	57.11.3242	2.4 kOhm	5%	0.25W	
DLZ...1		50.04.2150		led bar-graph red		R....3	57.11.3472	4.7 kOhm	5%	0.25W	
DLZ...2		50.04.2150		led bar-graph red		R....4	57.11.3105	1 MOhm	5%	0.25W	
DLZ...3		50.04.2150		led bar-graph red		R....5	57.11.3472	4.7 kOhm	5%	0.25W	
DLZ...4		50.04.2150		led bar-graph red		R....6	57.11.3242	2.4 kOhm	5%	0.25W	
DLZ...5		50.04.2150		led bar-graph red		R....7	57.11.3472	4.7 kOhm	5%	0.25W	
DLZ...6		50.04.2150		led bar-graph red		R....8	57.11.3105	1 MOhm	5%	0.25W	
DLZ...7		50.04.2150		led bar-graph red		R....9	57.11.3472	4.7 kOhm	5%	0.25W	
DLZ...8		50.04.2150		led bar-graph red		R....10	57.11.3242	2.4 kOhm	5%	0.25W	
IC....1		50.11.0119	LM3914N	led bar driver linear	NS	R....11	57.11.3472	4.7 kOhm	5%	0.25W	
IC....2		50.11.0119	LM3914N	led bar driver linear	NS	R....12	57.11.3105	1 MOhm	5%	0.25W	
IC....3		50.11.0119	LM3914N	led bar driver linear	NS	R....13	57.11.3472	4.7 kOhm	5%	0.25W	
IC....4		50.11.0119	LM3914N	led bar driver linear	NS	R....14	57.11.3242	2.4 kOhm	5%	0.25W	
IC....5		50.11.0119	LM3914N	led bar driver linear	NS	R....15	57.11.3472	4.7 kOhm	5%	0.25W	
IC....6		50.11.0119	LM3914N	led bar driver linear	NS	R....16	57.11.3105	1 MOhm	5%	0.25W	
IC....7		50.11.0119	LM3914N	led bar driver linear	NS						
IC....8		50.11.0119	LM3914N	led bar driver linear	NS						
L....1		62.03.0005	250uH	coil							
L....2		62.03.0005	250uH	coil							
MP....1		53.03.0175	8 pcs	IC-socket 18 pin							
MP....2		1.913.419.11	1 pcs	Print							

MANUFACTURER: Bu=Burdny, Ex=Exner, Fc=Fairchild, G=General Instrument  
 HP=Hewlett Packard, ITT=Internatell, Mot=Motorola, Nat=National  
 (Matsushita), NS=National Semiconductors, Ph=Philips,  
 Ra=Raytheon, Sig=Signetics, Six=Siliconix, St=Studer,  
 TI=Texas Instrument, S=Siemens, In=Intersil, Un=Unitecra

ORIG 87/11/24

S T U D E R (00) 87/11/24 AE DISPLAY UNIT 4E PL 1.913.419.00 PAGE 1 S T U D E R (00) 87/11/24 AE DISPLAY UNIT 4E PL 1.913.419.00 PAGE 2

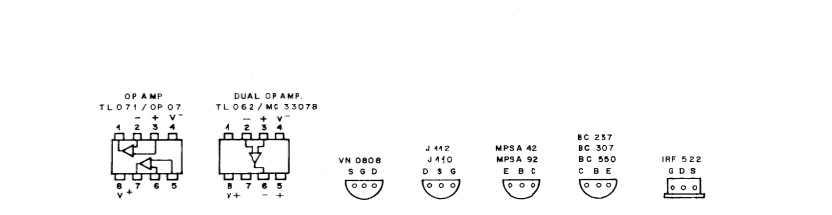
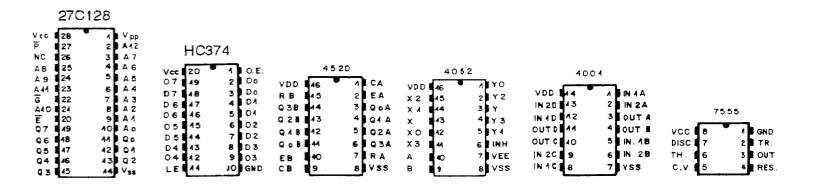
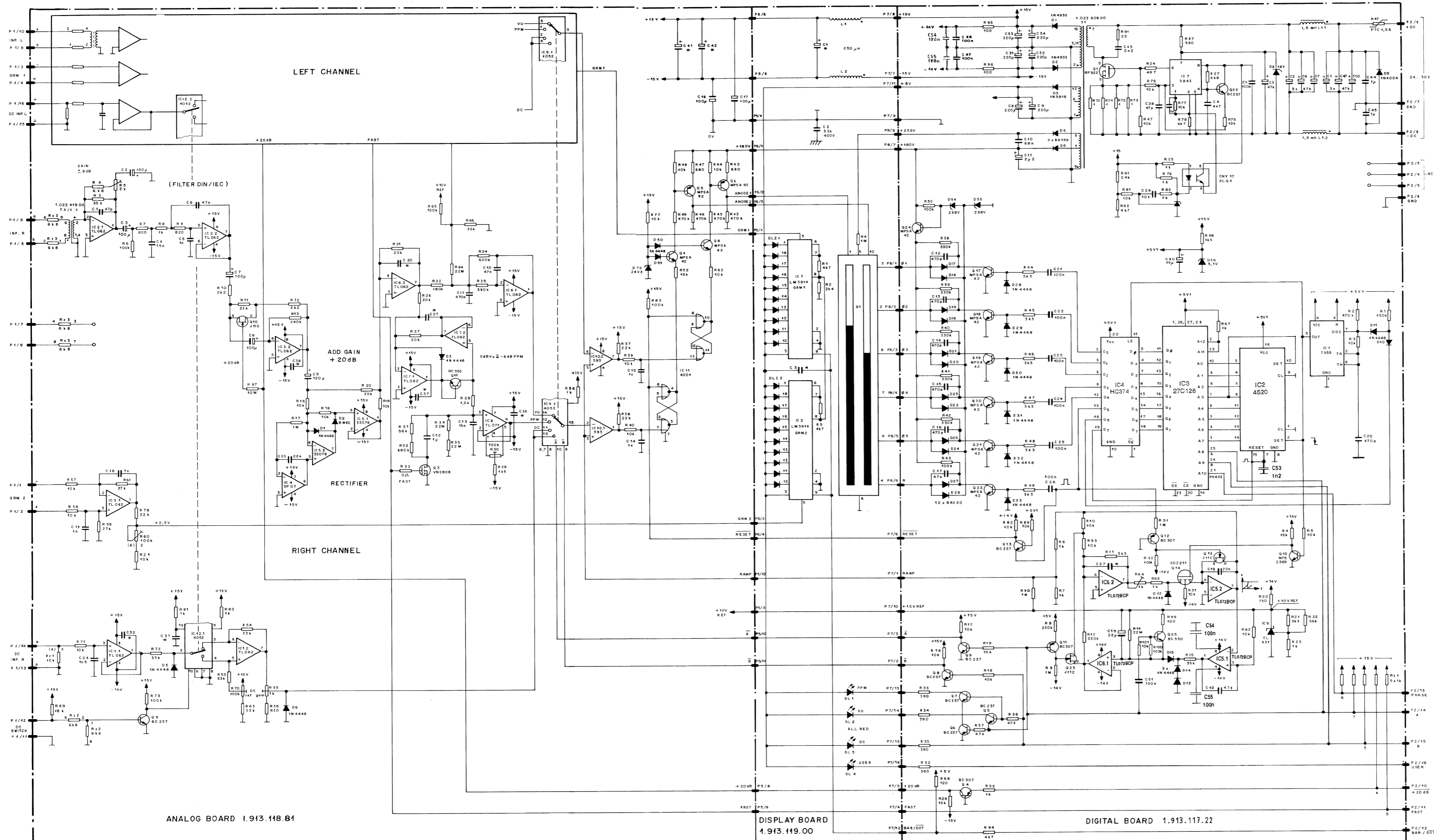

ANALOG BOARD 1.913.118.81

DISPLAY BOARD 1.913.119.00

DIGITAL BOARD 1.913.117.22

REGISDORF ZÜRICH	DUAL BAR GRAPH PPM	SC 1.913.111.81
	DUAL BAR GRAPH VU	SC 1.913.112.81



Bargraph Digital Board 1.913.117.21

Idx. Pos.	Part No.	Qty.	Type/Val.	Description	Idx. Pos.	Part No.	Qty.	Type/Val.	Description
0 D 15	50.04.0125	1N4448		75V, 150mA, 4ns, DO-35	0 R 18	57.11.3103	10k		MF, 1%, 0207
0 D 16	50.04.0133	BAV20		D BAV 20, SI	0 R 17	57.11.3103	10k		MF, 1%, 0207
0 D 17	50.04.0133	BAV20		D BAV 20, SI	0 R 18	57.11.3103	10k		MF, 1%, 0207
0 D 18	50.04.0133	BAV20		D BAV 20, SI	0 R 19	57.11.3103	10k		MF, 1%, 0207
0 D 19	50.04.0133	BAV20		D BAV 20, SI	0 R 20	57.11.3751	750R		MF, 1%, 0207
0 D 20	50.04.0133	BAV20		D BAV 20, SI	0 R 21	57.11.3332	3k3		MF, 1%, 0207
0 D 21	50.04.0133	BAV20		D BAV 20, SI	0 R 22	57.11.3363	38k		MF, 1%, 0207
0 D 22	50.04.0133	BAV20		D BAV 20, SI	0 R 23	57.11.3102	1k0		MF, 1%, 0207
0 D 23	50.04.0133	BAV20		D BAV 20, SI	0 R 24	57.11.3479	47R7		MF, 1%, 0207
0 D 24	50.04.0133	BAV20		D BAV 20, SI	0 R 25	57.11.3102	1k0		MF, 1%, 0207
0 D 25	50.04.0133	BAV20		D BAV 20, SI	0 R 27	57.11.3682	68k		MF, 1%, 0207
0 D 26	50.04.0133	BAV20		D BAV 20, SI	0 R 29	57.11.3103	10k		MF, 1%, 0207
0 D 27	50.04.0133	BAV20		D BAV 20, SI	0 R 30	57.11.3102	1k0		MF, 1%, 0207
0 D 28	50.04.0125	1N4448		75V, 150mA, 4ns, DO-35	0 R 31	57.11.3103	10k		MF, 1%, 0207
0 D 29	50.04.0125	1N4448		75V, 150mA, 4ns, DO-35	0 R 32	57.11.3391	390R		MF, 1%, 0207
0 D 30	50.04.0125	1N4448		75V, 150mA, 4ns, DO-35	0 R 33	57.11.3391	390R		MF, 1%, 0207
0 D 31	50.04.0125	1N4448		75V, 150mA, 4ns, DO-35	0 R 34	57.11.3391	390R		MF, 1%, 0207
0 D 32	50.04.0125	1N4448		75V, 150mA, 4ns, DO-35	0 R 35	57.11.3391	390R		MF, 1%, 0207
0 D 33	50.04.0125	1N4448		75V, 150mA, 4ns, DO-35	0 R 37	57.11.3473	47k		MF, 1%, 0207
0 D 34	50.04.1168	68V		Zener, 5%, 0.5W, DO-35	0 R 37	57.11.3473	47k		MF, 1%, 0207
0 D 35	50.04.1168	68V		Zener, 5%, 0.5W, DO-35	0 R 38	57.11.3334	330k		MF, 1%, 0207
0 D 36	50.04.1112	5V1		Zener, 5%, 0.5W, DO-35	0 R 39	57.11.3334	330k		MF, 1%, 0207
0 DLQ 1	50.04.3200	CNY17-2		Optic-coupler	0 R 40	57.11.3334	330k		MF, 1%, 0207
0 IC 1	50.07.0039	7555		IC LM7555 IPA A	0 R 41	57.11.3334	330k		MF, 1%, 0207
0 IC 2	50.07.0520	4520		Dual 4Bit binary counter	0 R 42	57.11.3334	330k		MF, 1%, 0207
0 IC 3	1.913.999.22			SW BAR-GRAPH DIGITAL BOARD A	0 R 43	57.11.3104	100k		MF, 1%, 0207
0 IC 4	50.17.1374	74HC374		IC -74 HC 374, A	0 R 44	57.11.3332	3k3		MF, 1%, 0207
0 IC 5	50.09.0121	TL072B		IC TL072 BCP A	0 R 45	57.11.3332	3k3		MF, 1%, 0207
0 IC 6	50.09.0121	TL072B		IC TL072 BCP A	0 R 46	57.11.3332	3k3		MF, 1%, 0207
0 IC 7	50.10.0113	3843		IC P 3843 N	0 R 47	57.11.3332	3k3		MF, 1%, 0207
0 IC 8	50.10.0108	TL431		Shunt regulator	0 R 48	57.11.3332	3k3		MF, 1%, 0207
0 IC 9	50.10.0108	TL431		Shunt regulator	0 R 49	57.11.3332	3k3		MF, 1%, 0207
0 P 1	50.03.0126	2A		2A Tantalum Capacitor compensated 1.5mH	0 R 50	57.11.3102	1k0		MF, 1%, 0207
0 MP 1	1.913.117.12	1 pce		BA-GRAPH DIGITAL PCB	0 R 51	57.11.3105	100k		MF, 1%, 0207
0 MP 2	1.913.117.04	1 pce		NR-ETIKETTE 5 * 20	0 R 52	57.11.5106	10M		MF, 5%, 0207
0 MP 3	43.01.0108	1 pce		Label	0 R 51	57.11.3243	24k		MF, 1%, 0207
0 MP 4	1.101.001.22	1 pce		TEXT-ETIK. 5*20 HARDWARE-22	0 R 62	57.11.3472	4k7		MF, 1%, 0207
0 MP 5	1.913.117.01	1 pce		ABSCHIRMHAUBE	0 R 64	58.01.8102	1k0		Carmer, 10%, 0.5W, horizontal
0 MP 6	28.99.0119	2 pcs		ROHRNETE D 2.5*10*15 9	0 R 65	57.11.3102	1k0		MF, 1%, 0207
0 MP 7	50.20.0314	1 pce		Dimmerrelais, zu Clip	0 R 67	57.11.3102	1k0		MF, 1%, 0207
0 MP 8	50.20.2003	1 pce		Montagesch. zu T20, N150L	0 R 70	57.11.3109	1R0		MF, 1%, 0207
0 MP 9	53.03.0165	1 pce		20p	0 R 71	57.11.3109	1R0		MF, 1%, 0207
0 MP 10	53.03.0168	4 pcs		8p	0 R 72	57.11.3109	1R0		MF, 1%, 0207
0 MP 11	53.03.0168	1 pce		16p	0 R 73	57.11.3109	1R0		MF, 1%, 0207
0 MP 12	53.03.0173	1 pce		28p	0 R 74	57.11.3103	10k		MF, 1%, 0207
0 P 2	54.11.2007	2*8p		EU-BK 2* 8 at 12 male	0 R 75	57.11.3103	10k		MF, 1%, 0207
0 P 7	54.01.0270	2 pcs		Stecker C15 parallelsteck	0 R 76	57.11.3103	10k		MF, 1%, 0207
0 P 8	54.01.0270	1 pce		Stecker C15 parallelsteck	0 R 77	57.11.3103	10k		MF, 1%, 0207
0 Q 1	50.03.1502	IRF522		N-VMO5-FET 100V, 7A	0 R 78	57.11.3472	4k7		MF, 1%, 0207
0 Q 4	50.03.0515	BC307B		PNP 100mA 45V	0 R 79	57.11.3102	1k0		MF, 1%, 0207
0 Q 5	50.03.0438	BC237B		NPN 100mA 45V	0 R 80	57.11.3102	1k0		MF, 1%, 0207
0 Q 6	50.03.0438	BC237B		NPN 100mA 45V	0 R 81	57.11.3103	10k		MF, 1%, 0207
0 Q 7	50.03.0438	BC237B		NPN 100mA 45V	0 R 82	57.11.3103	10k		MF, 1%, 0207
0 Q 8	50.03.0438	BC237B		NPN 100mA 45V	0 R 87	57.11.3561	560R		MF, 1%, 0207
0 Q 9	50.03.0438	BC237B		NPN 100mA 45V	0 R 88	57.11.3220	22R		MF, 1%, 0207
0 Q 10	50.03.0508	NPS2369		NPN	0 R 89	57.11.3103	10k		MF, 1%, 0207
0 Q 11	50.03.0515	BC307B		PNP 100mA 45V	0 R 90	57.11.3105	100k		MF, 1%, 0207
0 Q 12	50.03.0515	BC307B		PNP 100mA 45V	0 R 91	57.11.3220	22R		MF, 1%, 0207
0 Q 13	50.03.0438	BC237B		NPN 100mA 45V	0 R 92	57.11.3103	10k		MF, 1%, 0207
0 Q 14	50.11.0108	SD214		Analog Switch	0 R 93	57.11.3103	10k		MF, 1%, 0207
0 Q 15	50.03.0350	J112		JFET N-Channel	0 R 94	57.11.3471	470R		MF, 1%, 0207
0 Q 16	50.03.0484	MPSA42		MPSA 42	0 R 95	57.11.3101	100R		MF, 1%, 0207
0 Q 17	50.03.0484	MPSA42		MPSA 42	0 R 96	57.11.3101	100R		MF, 1%, 0207
0 Q 18	50.03.0484	MPSA42		MPSA 42	0 R 97	57.02.7003	1.0A		PTC
0 Q 19	50.03.0484	MPSA42		MPSA 42	0 R 98	57.11.3152	1k5		MF, 1%, 0207
0 Q 20	50.03.0484	MPSA42		MPSA 42	0 R 99	57.11.3101	100R		MF, 1%, 0207
0 Q 21	50.03.0484	MPSA42		MPSA 42	0 R 100	57.11.3104	100k		MF, 1%, 0207
0 Q 22	50.03.0438	BC237B		NPN 100mA 45V	0 R 101	57.11.3103	10k		MF, 1%, 0207
0 Q 23	50.03.0350	J112		JFET N-Channel	0 R 12	57.11.3103	10k		MF, 1%, 0207
0 Q 24	50.03.0484	MPSA42		MPSA 42	0 R 24	57.11.3102	1k0		MF, 1%, 0207
0 Q 25	50.03.0407	BC550C		BC 550 C	0 R 21	57.88.4102	1k0		BFR Resistor-Netz 21 S1PS
0 R 1	57.11.3154	150k		MF, 1%, 0207	0 T 1	1.022.606.00			SCHALTRAFO ZU BAR-GRAPH
0 R 2	57.11.3474	470k		MF, 1%, 0207					
0 R 3	57.11.3103	10k		MF, 1%, 0207					
0 R 4	57.11.3103	10k		MF, 1%, 0207					
0 R 5	57.11.3103	10k		MF, 1%, 0207					
0 R 6	57.11.3102	1k0		MF, 1%, 0207					
0 R 7	57.11.3102	1k0		MF, 1%, 0207					
0 R 8	57.11.3224	220k		MF, 1%, 0207					
0 R 9	57.11.3105	100k		MF, 1%, 0207					
0 R 10	57.11.3103	10k		MF, 1%, 0207					
0 R 11	57.11.3332	3k3		MF, 1%, 0207					
0 R 12	57.11.3334	330k		MF, 1%, 0207					
0 R 14	57.11.8226	22M		MF, 10%, 0207					
0 R 15	57.11.3333	33k		MF, 1%, 0207					

Comments:  
[23] IC3 same SW, but shifted in address-range

End of List

