

- P8.1-
- 12
  - 14
  - 10
  - 9
  - 8
  - 7
  - 6
  - 5
  - 4
  - 3
  - 2
  - 1
  - AUX B R
  - AUX B L
  - AUX 7
  - NC
  - 15V
  - OVA
  - NC
  - +15V
  - NC
  - a
  - b
  - HL-IN (PF)
  - a
  - b
  - HL-IN (AF)
  - 29
  - 30
  - 31
  - 32
  - NC

- P8.2-
- 24
  - 23
  - 22
  - 21
  - 20
  - 19
  - 18
  - 17
  - 16
  - 15
  - 14
  - 13
  - 12
  - 11
  - 10
  - 9
  - 8
  - 7
  - 6
  - 5
  - 4
  - 3
  - 2
  - AUX 6
  - AUX 5

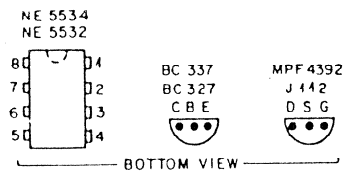

27 6.86			
STUDEF REGENDORF ZURICH		24 CH SEL. MONO	SC 1.913.177

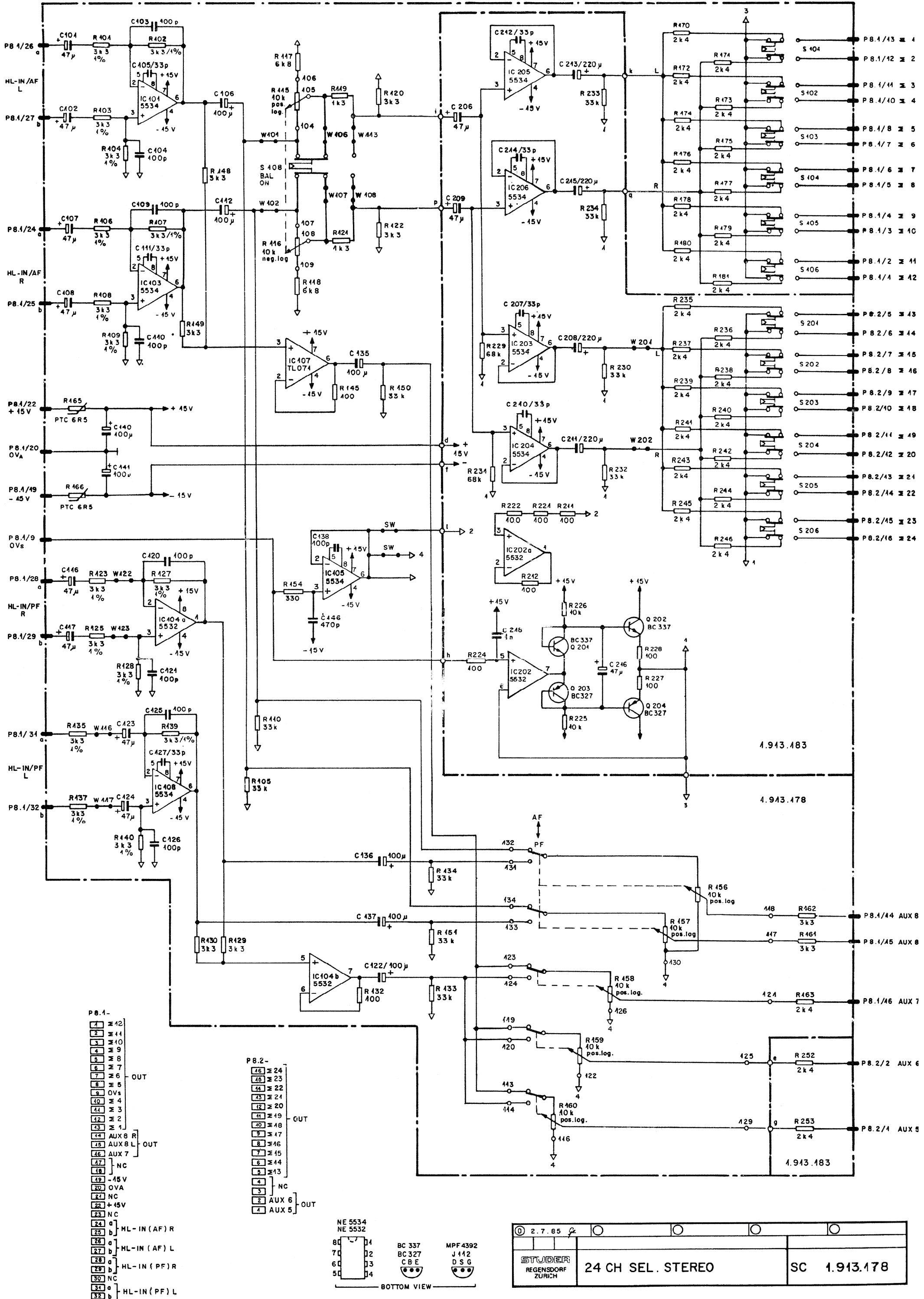

- PB.1-
- 1 ≙ 42
  - 2 ≙ 11
  - 3 ≙ 10
  - 4 ≙ 9
  - 5 ≙ 8
  - 6 ≙ 7
  - 7 ≙ 6
  - 8 ≙ 5
  - 9 OVs
  - 10 ≙ 4
  - 11 ≙ 3
  - 12 ≙ 2
  - 13 ≙ 1
  - 14 AUX 8 R
  - 15 AUX 8 L
  - 16 AUX 7
  - 17 ≙ 1
  - 18 ≙ 2
  - 19 ≙ 3
  - 20 ≙ 4
  - 21 ≙ 5
  - 22 ≙ 6
  - 23 ≙ 7
  - 24 a HL-IN (AF) R
  - 25 b HL-IN (AF) L
  - 26 a HL-IN (PF) R
  - 27 b HL-IN (PF) L
  - 28 a HL-IN (PF) R
  - 29 b HL-IN (PF) L
  - 30 NC
  - 31 a
  - 32 b

- PB.2-
- 46 ≙ 24
  - 48 ≙ 23
  - 44 ≙ 22
  - 43 ≙ 21
  - 42 ≙ 20
  - 41 ≙ 19
  - 40 ≙ 18
  - 39 ≙ 17
  - 38 ≙ 16
  - 37 ≙ 15
  - 36 ≙ 14
  - 35 ≙ 13
  - 34 ≙ 12
  - 33 ≙ 11
  - 32 ≙ 10
  - 31 ≙ 9
  - 30 ≙ 8
  - 29 ≙ 7
  - 28 ≙ 6
  - 27 ≙ 5
  - 26 ≙ 4
  - 25 ≙ 3
  - 24 ≙ 2
  - 23 ≙ 1
  - 22 ≙ 0
  - 21 ≙ 0
  - 20 ≙ 0
  - 19 ≙ 0
  - 18 ≙ 0
  - 17 ≙ 0
  - 16 ≙ 0
  - 15 ≙ 0
  - 14 ≙ 0
  - 13 ≙ 0
  - 12 ≙ 0
  - 11 ≙ 0
  - 10 ≙ 0
  - 9 ≙ 0
  - 8 ≙ 0
  - 7 ≙ 0
  - 6 ≙ 0
  - 5 ≙ 0
  - 4 ≙ 0
  - 3 ≙ 0
  - 2 ≙ 0
  - 1 ≙ 0

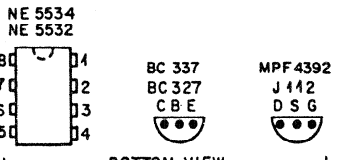

2.7.85			
STUDER REGENSDORF ZÜRICH		24 CH SEL. STEREO	
		SC 1.913.178	

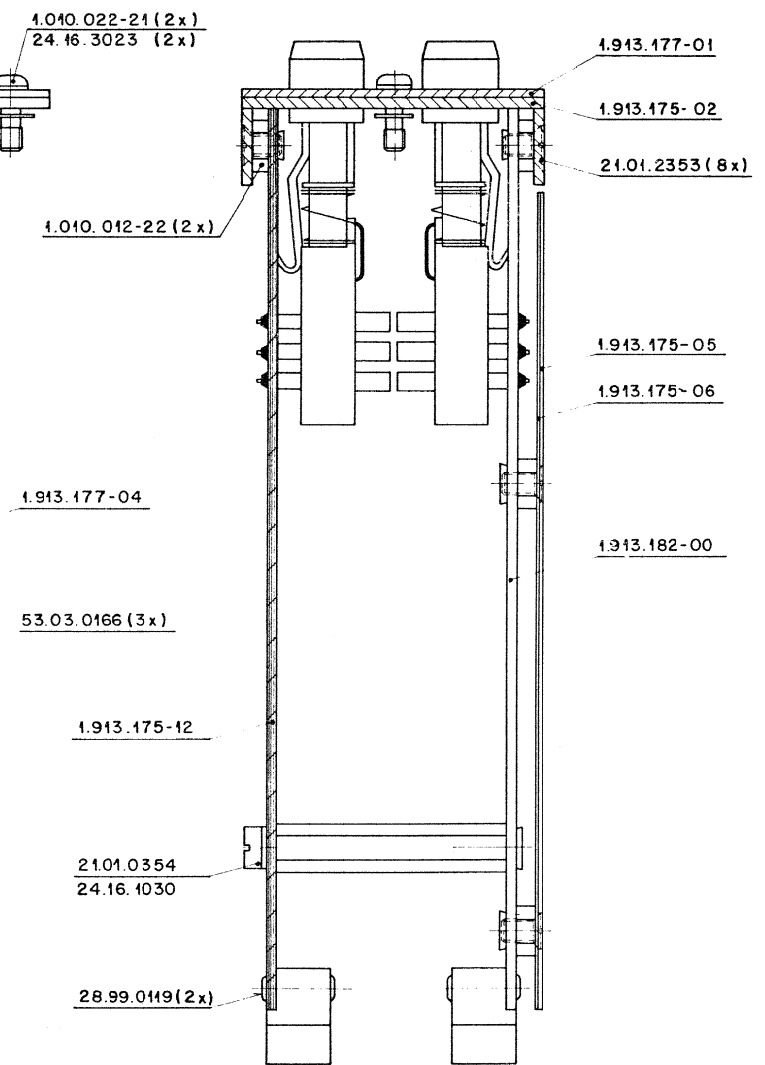
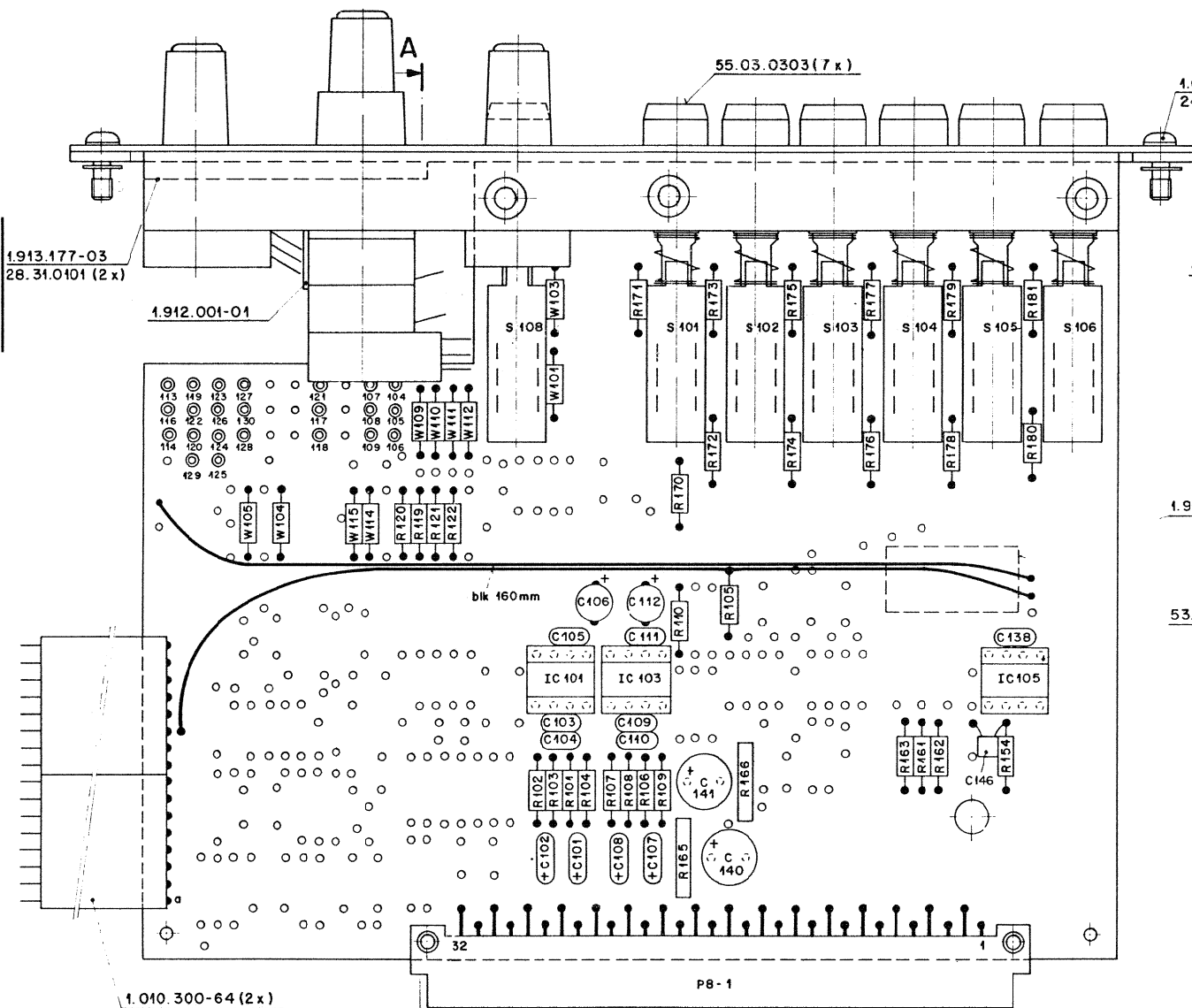

Schnitt A-A

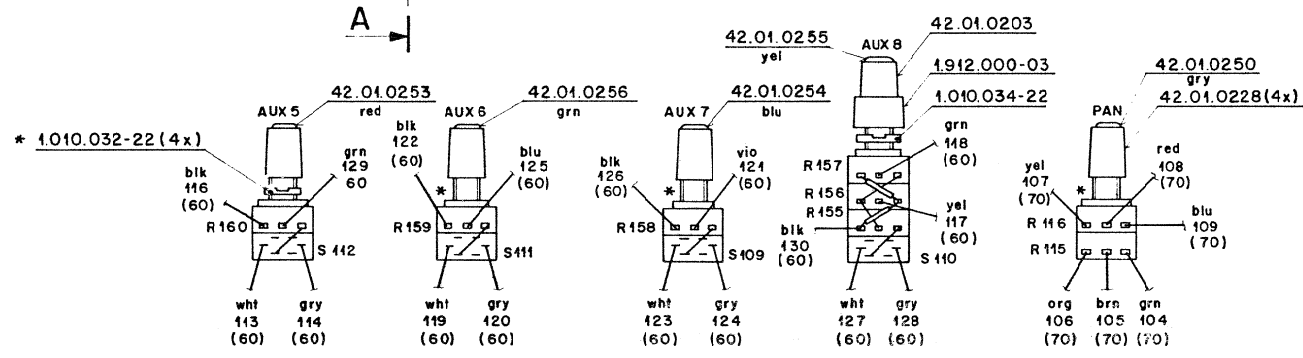

Werkstoff	Norm-Nr.:	Gute:	Änderung	③
	DIN-Bez.:	Oberfläche		②
	Abmessung:	Beh.:		①
Zugehörige Unterlagen:	PL	Freimasstoleranz:	Maßstab:	13.3.86 A Ho
		+	4:1; 2:1	PL
Ersatz für:		Ersetzt durch:		Kopie für:
<b>STUDER</b> REGENSDORF ZÜRICH		Benennung: <b>24-CH SEL. MONO</b>		Nummer: <b>1.913.177-00</b>

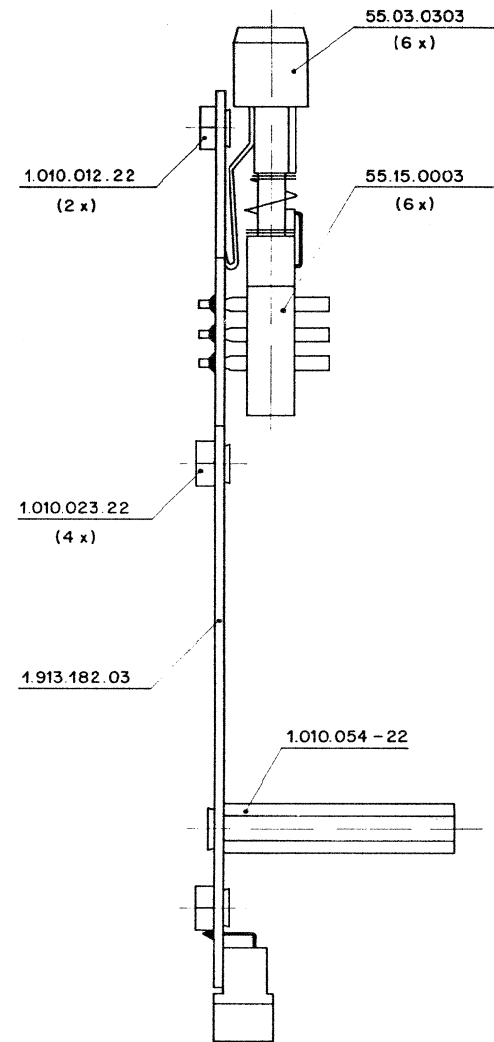
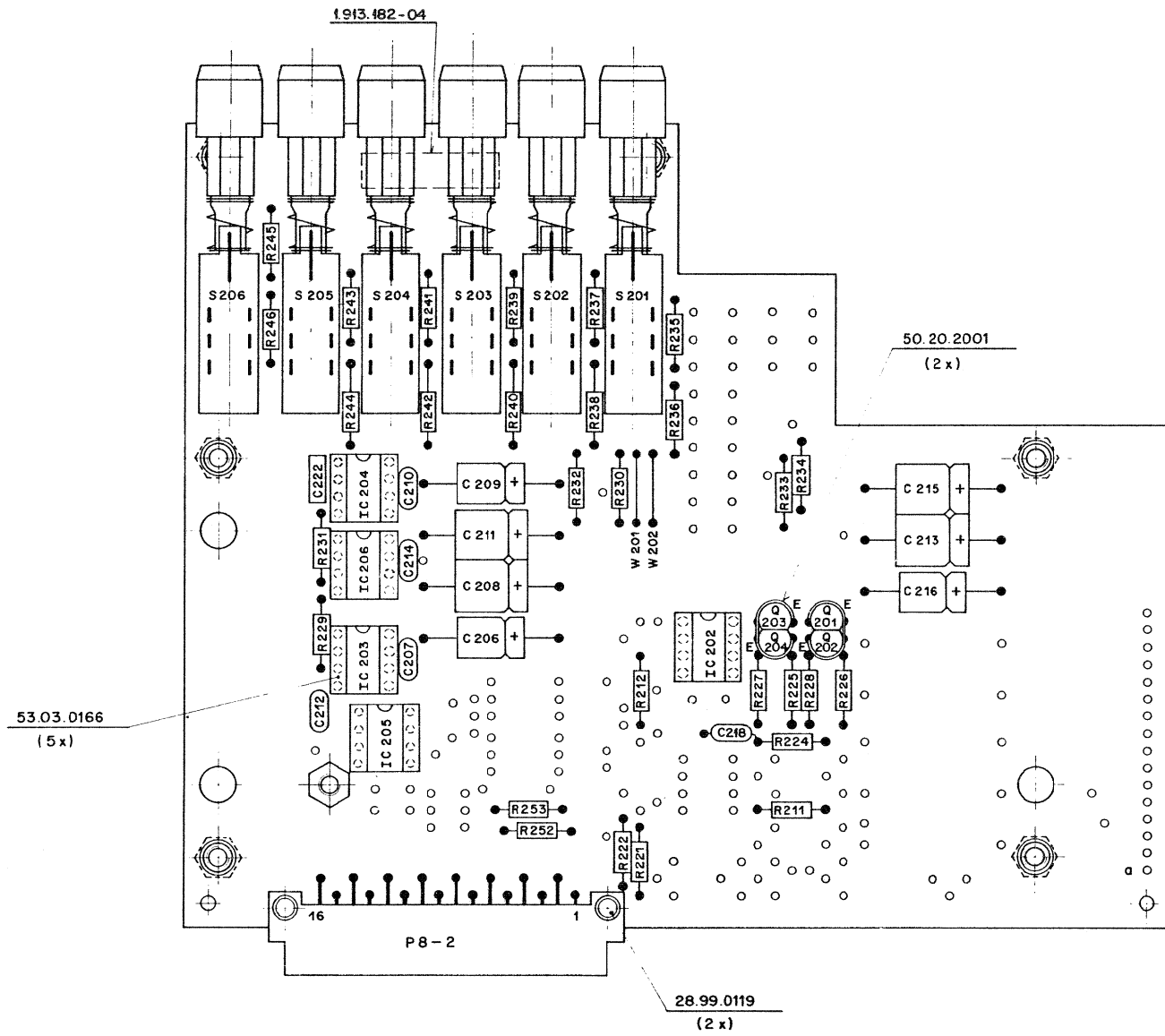

Werkstoff	Norm-Nr.:	Oberfläche	Güte.	Änderung	③
	DIN-Bez.:		Beh.		②
	Abmessung:				①
Zugehörige Unterlagen:	Freimasstoleranz:	Maßstab:	Ausgabe	19.11.85	①
PL 1.913.177-00	±	2:1	Datum	Gez. Gepr. Ges. Index	
Ersatz für:	Ersetzt durch:	Kopie für:			
STUDER REGENSDORF ZÜRICH	Benennung:	6 SWITCH MONO			Nummer:
					1.913.182-00

Ae.-Index CU Ae.-Datum 03.05.85  
 Kopieausgabe 16.44 Uhr am 15.04.86

Visum TA

Ae. Nummer Titel Bemerkungen  
 -----  
 GO 1.913.177.00 24-CH-SEL. MOND  
 -----

Ind.	Pcs.Nr.	Teil Nr.	Wert (Menge)	Bezeichnung	Hersteller
-----					
00	C...101	59.26.0470	47 uF	20% 6.3V	SAL
00	C...102	59.26.0470	47 uF	20% 6.3V	SAL
00	C...103	59.34.4101	100 pF		CE
00	C...104	59.34.4101	100 pF		CE
00	C...105	59.34.2330	33 pF		CE
00	C...106	59.22.3101	100 uF	-20% 10V	EL
00	C...107	59.26.0470	47 uF	20% 6.3V	SAL
00	C...108	59.26.0470	47 uF	20% 6.3V	SAL
00	C...109	59.34.4101	100 pF		CE
00	C...110	59.34.4101	100 pF		CE
00	C...111	59.34.2330	33 pF		CE
00	C...112	59.22.3101	100 uF	-20% 10V	EL
00	C...113		not used		
00	C...114		not used		
00	C...115		not used		
00	C...116		not used		
00	C...117		not used		
00	C...118		not used		
00	C...119		not used		
00	C...120		not used		
00	C...121		not used		
00	C...122		not used		
00	C...123		not used		
00	C...124		not used		
00	C...125		not used		
00	C...126		not used		
00	C...127		not used		
00	C...128		not used		
00	C...129		not used		
00	C...130		not used		
00	C...131		not used		
00	C...132		not used		
00	C...133		not used		
00	C...134		not used		
00	C...135		not used		
00	C...136		not used		
00	C...137		not used		
00	C...138	59.34.4101	100 pF		CE
00	C...139		not exist		
00	C...140	59.22.4101	100 uF	-20% 16V	EL
00	C...141	59.22.4101	100 uF	-20% 16V	EL
00	C...142		not used		
00	C...143		not used		
00	C...144		not used		
00	C...145		not used		
02	C...146	59.34.5471	470 pF		CE
00	IC...101	50.05.0243	NE5534N	single op. amp.	Sig,Ra
00	IC...102		not used		

Ae.-Index 00 Ae.-Datum 03.05.85  
 Kopieausgabe 16.44 Uhr am 15.04.86

Visum 7A

Ind.	Pos.Nr.	Teil Nr.	Wert (Menge)	Bezeichnung	Hersteller
00	IC..103	50.05.0243	NE5534N	single op. amp.	Sig,Ra
00	IC..104		not used		
00	IC..105	50.05.0243	NE5534N	single op. amp.	Sig,Ra
00	IC..106		not used		
00	IC..107		not used		
00	IC..108		not used		
00	MP....1	53.03.0166	3 pcs	IC-socket 8 pin	
00	P...8.1	54.01.0359	2*16pin	euroconnector	Bu
00	R...101	57.11.3332	3.3 kOhm	1% 0.25W	
00	R...102	57.11.3332	3.3 kOhm	1% 0.25W	
00	R...103	57.11.3332	3.3 kOhm	1% 0.25W	
00	R...104	57.11.3332	3.3 kOhm	1% 0.25W	
00	R...105	57.11.4333	33 kOhm	5% 0.25W	
00	R...106	57.11.3332	3.3 kOhm	1% 0.25W	
00	R...107	57.11.3332	3.3 kOhm	1% 0.25W	
00	R...108	57.11.3332	3.3 kOhm	1% 0.25W	
00	R...109	57.11.3332	3.3 kOhm	1% 0.25W	
00	R...110	57.11.4333	33 kOhm	5% 0.25W	
00	R...111		not used		
00	R...112		not used		
00	R...113		not used		
00	R...114		not used		
00	R...115	1.912.001.35	10 kOhm	pos.log. combined with R116	St
00	R...116		10 kOhm	neg.log. see R115	
00	R...117		not used		
00	R...118		not used		
00	R...119	57.11.4332	3.3 kOhm	5% 0.25W	
00	R...120	57.11.4332	3.3 kOhm	5% 0.25W	
00	R...121	57.11.4332	3.3 kOhm	5% 0.25W	
00	R...122	57.11.4332	3.3 kOhm	5% 0.25W	
00	R...123		not used		
00	R...124		not used		
00	R...125		not used		
00	R...126		not used		
00	R...127		not used		
00	R...128		not used		
00	R...129		not used		
00	R...130		not used		
00	R...131		not used		
00	R...132		not used		
00	R...133		not used		
00	R...134		not used		
00	R...135		not used		
00	R...136		not used		
00	R...137		not used		
00	R...138		not used		
00	R...139		not used		
00	R...140		not used		
00	R...141		not used		
00	R...142		not used		
00	R...143		not used		

Ae.-Index 00 Ae.-Datum 03.05.85  
 Kopieausgabe 16.44 Uhr am 15.04.86

Visum TA

Ind.	Pos.Nr.	Teil Nr.	Wert(Menge)	Bezeichnung	Hersteller
00	R...144		not used		
00	R...145		not used		
00	R...146		not used		
00	R...147		not used		
00	R...148		not used		
00	R...149		not used		
00	R...150		not used		
00	R...151		not used		
00	R...152		not used		
00	R...153		not used		
00	R...154	57.11.4331	330 Ohm	5% 0.25W	
00	R...155	1.912.001.43	4.7 kOhm		
			10% pos.log.	combined with R156/R157	St
00	R...156		10 kOhm	10% pos.log.	see R155
00	R...157		10 kOhm	10% neg.log.	see R155
00	R...158	1.912.001.42	1C kOhm		
			10% pos.log.	variable resistor	St
00	R...159	1.912.001.42	10 kOhm		
			10% pos.log.	variable resistor	St
00	R...160	1.912.001.42	10 kOhm		
			10% pos.log.	variable resistor	St
00	R...161	57.11.4332	3.3 kOhm	5% 0.25W	
00	R...162	57.11.4332	3.3 kOhm	5% 0.25W	
00	R...163	57.11.4332	3.3 kOhm	5% 0.25W	
00	R...164		not used		
00	R...165	57.92.1271	6.5 Ohm		
			I = 270mA	PTC Philips Nr.2322 662 12711	
00	R...166	57.92.1271	6.5 Ohm		
			I = 270mA	PTC Philips Nr.2322 662 12711	
00	R...167		not used		
00	R...168		not used		
00	R...169		not used		
00	R...170	57.11.4332	3.3 kOhm	2% 0.25W	
00	R...171	57.11.4332	3.3 kOhm	2% 0.25W	
00	R...172	57.11.4332	3.3 kOhm	2% 0.25W	
00	R...173	57.11.4332	3.3 kOhm	2% 0.25W	
00	R...174	57.11.4332	3.3 kOhm	2% 0.25W	
00	R...175	57.11.4332	3.3 kOhm	2% 0.25W	
00	R...176	57.11.4332	3.3 kOhm	2% 0.25W	
00	R...177	57.11.4332	3.3 kOhm	2% 0.25W	
00	R...178	57.11.4332	3.3 kOhm	2% 0.25W	
00	R...179	57.11.4332	3.3 kOhm	2% 0.25W	
00	R...180	57.11.4332	3.3 kOhm	2% 0.25W	
00	R...181	57.11.4332	3.3 kOhm	2% 0.25W	
00	R...182		not used		
00	R...183		not used		
00	R...184		not used		
00	R...185		not used		
00	S...101	55.15.0003	2*U	3u Au	button : red ITT
00	S...102	55.15.0003	2*U	3u Au	button : red ITT
00	S...103	55.15.0003	2*U	3u Au	button : red ITT
00	S...104	55.15.0003	2*U	3u Au	button : red ITT
00	S...105	55.15.0003	2*U	3u Au	button : red ITT

Ae.-Index 00 Ae.-Datum 03.05.85  
 Kopieausgabe 16.44 Uhr am 15.04.86

Visum TA

Ind.	Pos.-Nr.	Teil Nr.	Wert (Menge)	Bezeichnung	Hersteller
00	S...106	55.15.0003	2*U	3u Au button : red	ITT
00	S...107		not used		
00	S...108	55.15.0003	2*U	3u Au button : red	ITT
00	W...101				
00	W...102		not used		
00	W...103				
00	W...104				
00	W...105				
00	W...106		not used		
00	W...107		not used		
00	W...108		not used		
00	W...109				
00	W...110				
00	W...111				
00	W...112				
00	W...113		not used		
00	W...114				
00	W...115				
00	W...116		not used		
00	W...117		not used		
00	W...118		not used		
00	W...119		not used		
00	W...120	1.010.300.64	8-wire	flatcable	40 mm
00	W...121	1.010.300.64	8-wire	flatcable	40 mm
00	W...122		not used		
00	W...123		not used		
00	W...124		not used		
00	W...125		not used		
00	C...201		not used		
00	C...202		not used		
00	C...203		not used		
00	C...204		not used		
00	C...205		not used		
00	C...206	59.25.3470	47 uF	-20% 16V	EL
00	C...207	59.34.2330	33 pF		CE
00	C...208	59.25.1221	220 uF	-20% 6.3V	EL
00	C...209	59.25.3470	47 uF	-20% 16V	EL
00	C...210	59.34.2330	33 pF		CE
00	C...211	59.25.1221	220 uF	-20% 6.3V	EL
00	C...212	59.34.2330	33 pF		CE
00	C...213	59.25.1221	220 uF	-20% 6.3V	EL
00	C...214	59.34.2330	33 pF		CE
00	C...215	59.25.1221	220 uF	-20% 6.3V	EL
00	C...216	59.25.3470	47 uF	-20% 16V	EL
00	C...217		not used		
01	C...218	59.32.4102	1 nF		CE
00	C...219		not used		
00	C...220		not used		
00	C...221		not used		
00	C...222	59.06.0223	22 nF		PE
00	C...223		not used		
00	C...224		not used		



Ae.-Index 00 Ae.-Datum 03.05.85  
 Kopieausgabe 16.44 Uhr am 15.04.86

Visum TA

Ind.	Pos.Nr.	Teil Nr.	Wert (Menge)	Bezeichnung	Hersteller
00	IC..201		not used		
00	IC..202	50.09.0105	NE5532	dual op. amp.	Sig,Ex,Ra
00	IC..203	50.05.0243	NE5534N	single op. amp.	Sig,Ra
00	IC..204	50.05.0243	NE5534N	single op. amp.	Sig,Ra
00	IC..205	50.05.0243	NE5534N	single op. amp.	Sig,Ra
00	IC..206	50.05.0243	NE5534N	single op. amp.	Sig,Ra
00	MP....1	53.03.0166	5 pcs	IC-socket 8 pin	
00	MP....2	50.20.2001	2 pcs	CLIP ; 2 * TD 92	St
00	P...8.2	54.11.2007	2*8 pin	euroconnector	Bu
00	C...201	50.03.0516	BC 337	NPN matched with Q 202	Sie
00	Q...202	50.03.0516	BC 337	NPN	Sie
00	C...203	50.03.0625	BC 327	PNP matched with Q 204	Sie
00	C...204	50.03.0625	BC 327	PNP	Sie
00	R...201		not used		
00	R...202		not used		
00	R...203		not used		
00	R...204		not used		
00	R...205		not used		
00	R...206		not used		
00	R...207		not used		
00	R...208		not used		
00	R...209		not used		
00	R...210		not used		
00	R...211	57.11.4101	100 Ohm	2% 0.25W	
00	R...212	57.11.4101	100 Ohm	2% 0.25W	
00	R...213		not used		
00	R...214		not used		
00	R...215		not used		
00	R...216		not used		
00	R...217		not used		
00	R...218		not used		
00	R...219		not used		
00	R...220		not used		
00	R...221	57.11.4101	100 Ohm	5% 0.25W	
00	R...222	57.11.4101	100 Ohm	5% 0.25W	
00	R...223		not used		
00	R...224	57.11.4101	100 Ohm	5% 0.25W	
00	R...225	57.11.4103	10 kOhm	5% 0.25W	
00	R...226	57.11.4103	10 kOhm	5% 0.25W	
00	R...227	57.11.4101	100 Ohm	5% 0.25W	
00	R...228	57.11.4101	100 Ohm	5% 0.25W	
00	R...229	57.11.4683	68 kOhm	5% 0.25W	
00	R...230	57.11.4333	33 kOhm	5% 0.25W	
00	R...231	57.11.4683	68 kOhm	5% 0.25W	
00	R...232	57.11.4333	33 kOhm	5% 0.25W	
00	R...233	57.11.4333	33 kOhm	5% 0.25W	
00	R...234	57.11.4333	33 kOhm	5% 0.25W	
00	R...235	57.11.4332	3.3 kOhm	2% 0.25W	
00	R...236	57.11.4332	3.3 kOhm	2% 0.25W	

Ae.-Index 00 Ae.-Datum 03.05.85  
 Kopieausgabe 16.44 Uhr am 15.04.86

Visum TA

Ind.	Pos.Nr.	Teil Nr.	Wert (Menge)	Bezeichnung		Hersteller
00	R...237	57.11.4332	3.3 kOhm	2%	0.25W	
00	R...238	57.11.4332	3.3 kOhm	2%	0.25W	
00	R...239	57.11.4332	3.3 kOhm	2%	0.25W	
00	R...240	57.11.4332	3.3 kOhm	2%	0.25W	
00	R...241	57.11.4332	3.3 kOhm	2%	0.25W	
00	R...242	57.11.4332	3.3 kOhm	2%	0.25W	
00	R...243	57.11.4332	3.3 kOhm	2%	0.25W	
00	R...244	57.11.4332	3.3 kOhm	2%	0.25W	
00	R...245	57.11.4332	3.3 kOhm	2%	0.25W	
00	R...246	57.11.4332	3.3 kOhm	2%	0.25W	
00	R...247		not used			
00	R...248		not used			
00	R...249		not used			
00	R...250		not used			
00	R...251		not used			
00	R...252	57.11.4332	3.3 kOhm	5%	0.25W	
00	R...253	57.11.4332	3.3 kOhm	5%	0.25W	
00	S...201	55.15.0003	2*U	3u Au	button : red	ITT
00	S...202	55.15.0003	2*U	3u Au	button : red	ITT
00	S...203	55.15.0003	2*U	3u Au	button : red	ITT
00	S...204	55.15.0003	2*U	3u Au	button : red	ITT
00	S...205	55.15.0003	2*U	3u Au	button : red	ITT
00	S...206	55.15.0003	2*U	3u Au	button : red	ITT
00	W...201					
00	W...202					

CE=Ceramic, CF=Carbon Film, EL=Electrolytic, MF=Metal Film,  
 PE=Polyester, PP=Polypropylen, PS=Polystyrol

MANUFACTURER: Bu=Burdy, Ex=Exar, Fc=Fairchild, GI=General Instrument  
 HP=Hewlett Packard, ITT=Intermetall, Mot=Motorola, Nat=N  
 (Matsushita), NS=National Semiconductors, Ph=Philips,  
 Ra=Raytheon, Sig=Signetics, Six=Siliconix, St=Studer,  
 TI=Texas Instrument

Ende der Positions Liste.

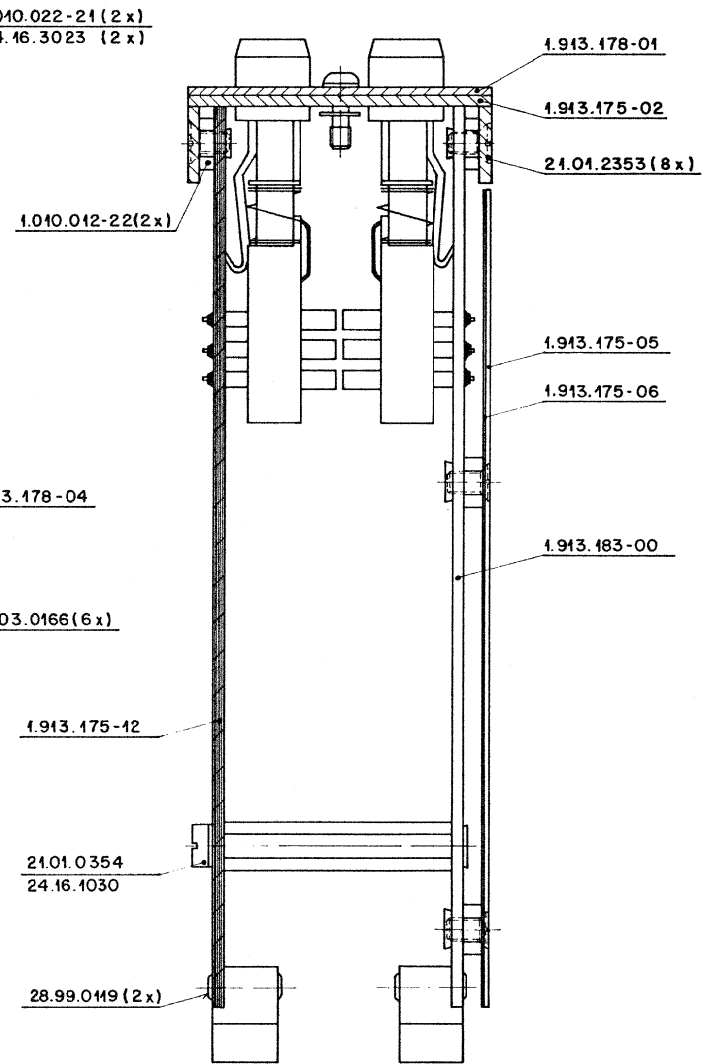
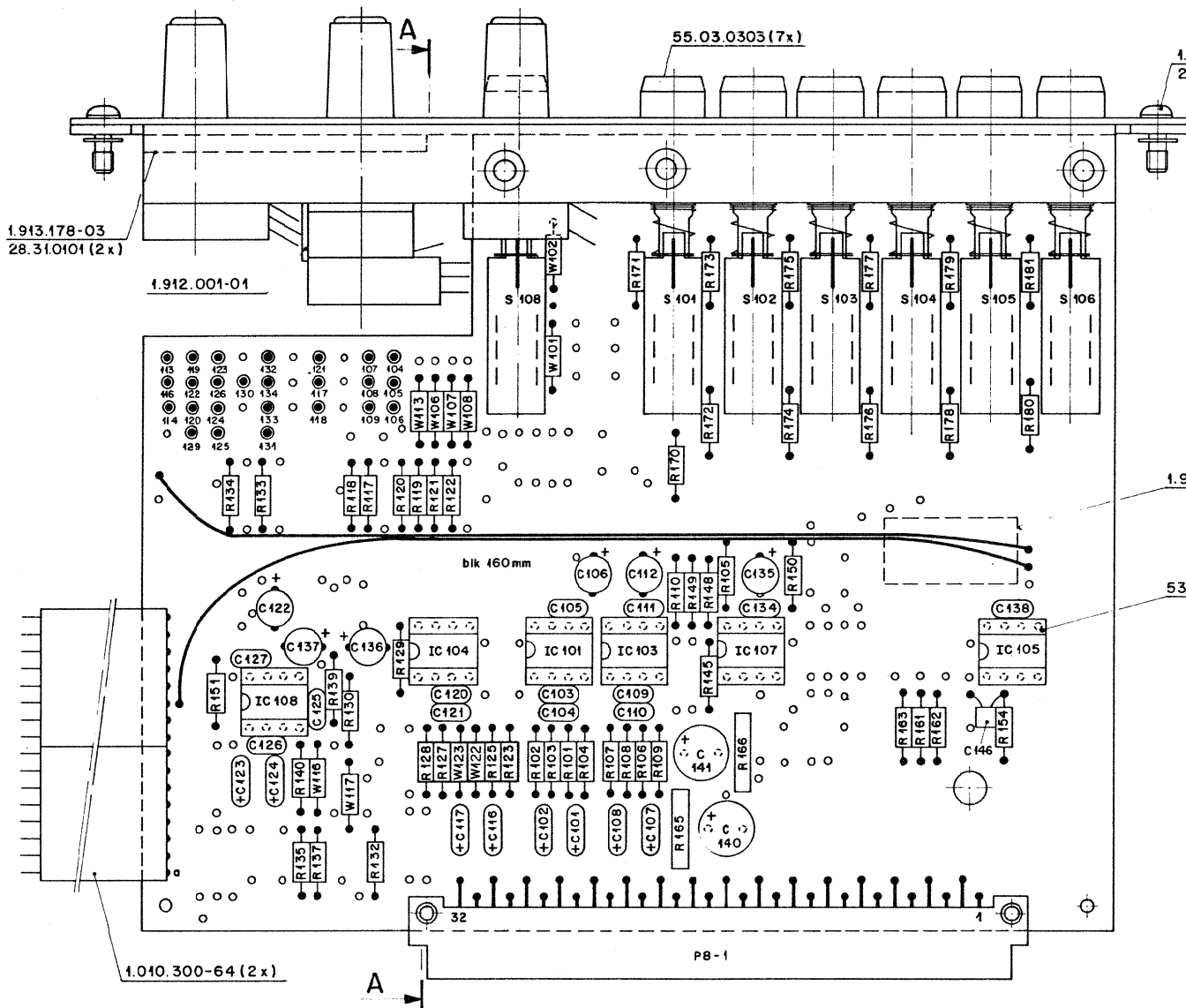

Schnitt A-A

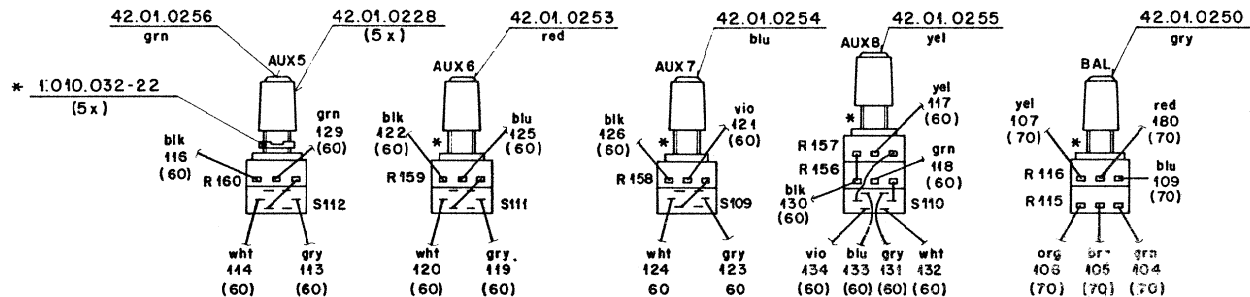

Norm-Nr.:	Güte:		Änderung
DIN-Bez.:	Oberfläche:		
Abmessung:	Beh.:		
Zugehörige Unterlagen:	Freimasstoleranz:	Maßstab:	12.3.86 A.Ho <i>7/</i>
PL	+	1:4; 2:1	Ausgabe Datum Gez. Gepr. Ges. Index
Ersatz für:	Ersatz durch:	Kopie für:	
<b>STUDER</b> REGENSDORF ZÜRICH		Benennung: <b>24-CH SEL. STEREO</b>	Nummer: <b>1.913.178-00</b>

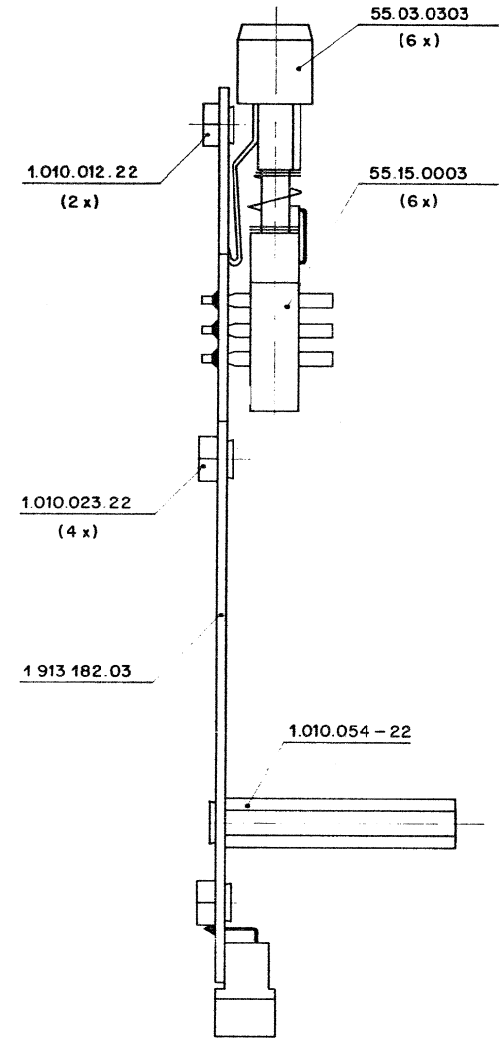
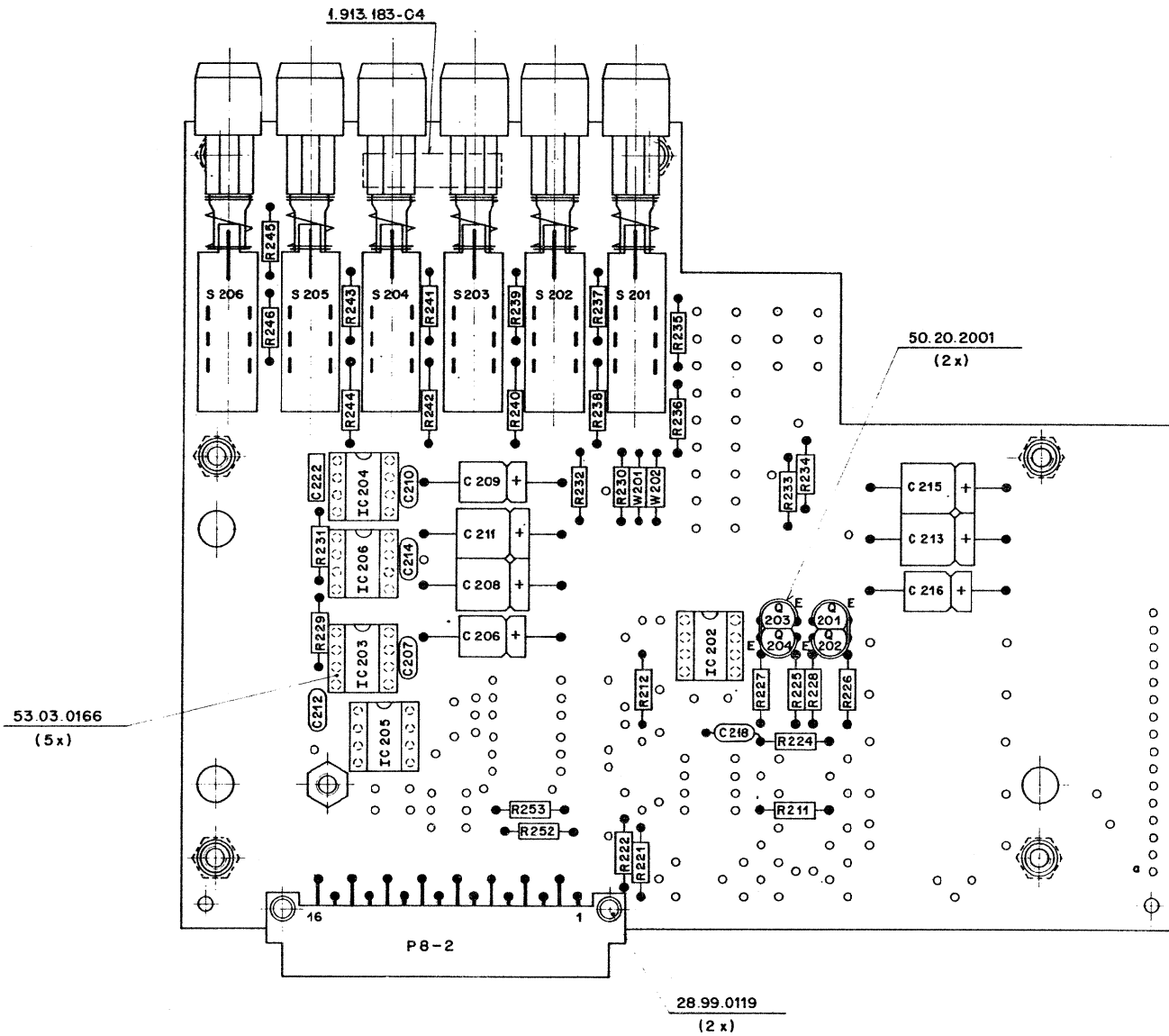

Werkstoff DIN-Bez Abmessung	Norm-Nr Güte		Änderung
	Oberfläche Beh		
Zugehörige Unterlagen PL 1.913.478-00	Freimasstoleranz	Maßstab 2 : 1	19.11.85 Ausgabe Datum
Ersatz für	Ersetzt durch	Kopie für	
Benennung STUDER REGENSDORF ZÜRICH	6 SWITCH STEREO		1.913.183 - 00 Nummer

Ae.-Index 00 Ae.-Datum 03.05.85  
 Kopieausgabe 16.44 Uhr am 15.04.86

Visum TA

Ae.	Nummer	Titel	Bemerkungen
00	1.913.178.00	24-CH-SEL. STEREO	

Indo	Pcs.Nr.	Teil Nr.	Wert(Menge)	Bezeichnung	Hersteller
00	C...101	59.26.0470	47 uF	20% 6.3V	SAL
00	C...102	59.26.0470	47 uF	20% 6.3V	SAL
00	C...103	59.34.4101	100 pF		CE
00	C...104	59.34.4101	100 pF		CE
00	C...105	59.34.2330	33 pF		CE
00	C...106	59.22.3101	100 uF	-20% 10V	EL
00	C...107	59.26.0470	47 uF	20% 6.3V	SAL
00	C...108	59.26.0470	47 uF	20% 6.3V	SAL
00	C...109	59.34.4101	100 pF		CE
00	C...110	59.34.4101	100 pF		CE
00	C...111	59.34.2330	33 pF		CE
00	C...112	59.22.3101	100 uF	-20% 10V	EL
00	C...113		not used		
00	C...114		not used		
00	C...115		not used		
00	C...116	59.26.0470	47 uF	20% 6.3V	SAL
00	C...117	59.26.0470	47 uF	20% 6.3V	SAL
00	C...118		not used		
00	C...119		not used		
00	C...120	59.34.4101	100 pF		CE
00	C...121	59.34.4101	100 pF		CE
00	C...122	59.22.3101	100 uF	-20% 10V	EL
00	C...123	59.26.0470	47 uF	20% 6.3V	SAL
00	C...124	59.26.0470	47 uF	20% 6.3V	SAL
00	C...125	59.34.4101	100 pF		CE
00	C...126	59.34.4101	100 pF		CE
00	C...127	59.34.2330	33 pF		CE
00	C...128		not used		
00	C...129		not used		
00	C...130		not used		
00	C...131		not used		
00	C...132		not used		
00	C...133		not used		
00	C...134	59.34.2330	33 pF		CE
00	C...135	59.22.3101	100 uF	-20% 10V	EL
00	C...136	59.22.3101	100 uF	-20% 10V	EL
00	C...137	59.22.3101	100 uF	-20% 10V	EL
00	C...138	59.34.4101	100 pF		CE
00	C...139		not exist		
00	C...140	59.22.4101	100 uF	-20% 16V	EL
00	C...141	59.22.4101	100 uF	-20% 16V	EL
00	C...142		not used		
00	C...143		not used		
00	C...144		not used		
00	C...145		not used		
C2	C...146	59.34.5471	470 pF		CE
00	IC...101	50.05.0243	NE5534N	single op. amp.	Sig.Ra
00	IC...102		not used		

Ae.-Index 00 Ae.-Datum 03.05.85  
 Kopieausgabe 16.44 Uhr am 15.04.86

Visum TA

Ind.	Pos.Nr.	Teil Nr.	Wert(Menge)	Bezeichnung	Hersteller
00	IC..103	50.05.0243	NE5534N	single op. amp.	Sig,Ra
C0	IC..104	50.09.0105	NE5532	dual op. amp.	Sig,Ex,Ra
00	IC..105	50.05.0243	NE5534N	single op. amp.	Sig,Ra
00	IC..106		not used		
C0	IC..107	50.05.0243	NE5534N	single op. amp.	Sig,Ra
00	IC..108	50.05.0243	NE5534N	single op. amp.	Sig,Ra
00	MP....1	53.03.0166	6 pcs	IC-socket 8 pin	
C0	P...8.1	54.01.0359	2*16pin	euroconnector	Bu
C0	R...101	57.11.3332	3.3 kOhm	1% 0.25W	
C0	R...102	57.11.3332	3.3 kOhm	1% 0.25W	
00	R...103	57.11.3332	3.3 kOhm	1% 0.25W	
C0	R...104	57.11.3332	3.3 kOhm	1% 0.25W	
00	R...105	57.11.4333	33 kOhm	5% 0.25W	
00	R...106	57.11.3332	3.3 kOhm	1% 0.25W	
C0	R...107	57.11.3332	3.3 kOhm	1% 0.25W	
00	R...108	57.11.3332	3.3 kOhm	1% 0.25W	
C0	R...109	57.11.3332	3.3 kOhm	1% 0.25W	
00	R...110	57.11.4333	33 kOhm	5% 0.25W	
C0	R...111		not used		
00	R...112		not used		
00	R...113		not used		
C0	R...114		not used		
00	R...115	1.912.001.35	10 kOhm	pos.log. combined with R116	St
00	R...116		10 kOhm	neg.log. see R115	
C0	R...117	57.11.4682	6.8 kOhm	5% 0.25W	
00	R...118	57.11.4682	6.8 kOhm	5% 0.25W	
C0	R...119	57.11.3132	1.3 kOhm	5% 0.25W	
C0	R...120	57.11.4332	3.3 kOhm	5% 0.25W	
C0	R...121	57.11.3132	1.3 kOhm	5% 0.25W	
C0	R...122	57.11.4332	3.3 kOhm	5% 0.25W	
C0	R...123	57.11.3332	3.3 kOhm	1% 0.25W	
C0	R...124		not used		
00	R...125	57.11.3332	3.3 kOhm	1% 0.25W	
00	R...126		not used		
C0	R...127	57.11.3332	3.3 kOhm	1% 0.25W	
C0	R...128	57.11.3332	3.3 kOhm	1% 0.25W	
C0	R...129	57.11.4332	3.3 kOhm	5% 0.25W	
00	R...130	57.11.4332	3.3 kOhm	5% 0.25W	
C0	R...131		not used		
C0	R...132	57.11.4101	100 Ohm	5% 0.25W	
00	R...133	57.11.4333	33 kOhm	5% 0.25W	
C0	R...134	57.11.4333	33 kOhm	5% 0.25W	
00	R...135	57.11.3332	3.3 kOhm	1% 0.25W	
C0	R...136		not used		
C0	R...137	57.11.3332	3.3 kOhm	1% 0.25W	
C0	R...138		not used		
00	R...139	57.11.3332	3.3 kOhm	1% 0.25W	
C0	R...140	57.11.3332	3.3 kOhm	1% 0.25W	
00	R...141		not used		
C0	R...142		not used		
00	R...143		not used		

Ae.-Index 00 Ae.-Datum 03.05.85  
 Kopieausgabe 16.44 Uhr am 15.04.86

Visum TA

Ind.	Pos.Nr.	Teil Nr.	Wert (Menge)	Bezeichnung	Hersteller
CO	R...144		not used		
CO	R...145	57.11.4101	100 Ohm	5% 0.25W	
CO	R...146		not used		
CO	R...147		not used		
CO	R...148	57.11.4332	3.3 kOhm	2% 0.25W	
CO	R...149	57.11.4332	3.3 kOhm	2% 0.25W	
CO	R...150	57.11.4333	33 kOhm	5% 0.25W	
CO	R...151	57.11.4333	33 kOhm	5% 0.25W	
CO	R...152		not used		
CO	R...153		not used		
CO	R...154	57.11.4331	330 Ohm	5% 0.25W	
CO	R...155		not used		
CO	R...156	1.912.001.44	10 kOhm		
			10% pos.log.	combined with R157	St
CO	R...157		10 kOhm	10% pos.log. see R156	
CO	R...158	1.912.001.42	10 kOhm		
			10% pos.log.	variable resistor	St
CO	R...159	1.912.001.42	10 kOhm		
			10% pos.log.	variable resistor	St
CO	R...160	1.912.001.42	10 kOhm		
			10% pos.log.	variable resistor	St
CO	R...161	57.11.4332	3.3 kOhm	2% 0.25W	
CO	R...162	57.11.4332	3.3 kOhm	2% 0.25W	
CO	R...163	57.11.3242	2.4 kOhm	2% 0.25W	
CO	R...164		not used		
CO	R...165	57.92.1271	6.5 Ohm		
			I = 270mA	PTC Philips Nr.2322 662 12711	
CO	R...166	57.92.1271	6.5 Ohm		
			I = 270mA	PTC Philips Nr.2322 662 12711	
CO	R...167		not used		
CO	R...168		not used		
CO	R...169		not used		
CO	R...170	57.11.3242	2.4 kOhm	2% 0.25W	
CO	R...171	57.11.3242	2.4 kOhm	2% 0.25W	
CO	R...172	57.11.3242	2.4 kOhm	2% 0.25W	
CO	R...173	57.11.3242	2.4 kOhm	2% 0.25W	
CO	R...174	57.11.3242	2.4 kOhm	2% 0.25W	
CO	R...175	57.11.3242	2.4 kOhm	2% 0.25W	
CO	R...176	57.11.3242	2.4 kOhm	2% 0.25W	
CO	R...177	57.11.3242	2.4 kOhm	2% 0.25W	
CO	R...178	57.11.3242	2.4 kOhm	2% 0.25W	
CO	R...179	57.11.3242	2.4 kOhm	2% 0.25W	
CO	R...180	57.11.3242	2.4 kOhm	2% 0.25W	
CO	R...181	57.11.3242	2.4 kOhm	2% 0.25W	
CO	R...182		not used		
CO	R...183		not used		
CO	R...184		not used		
CO	R...185		not used		
CO	S...101	55.15.0003	2*U	3u Au button : red	ITT
CO	S...102	55.15.0003	2*U	3u Au button : red	ITT
CO	S...103	55.15.0003	2*U	3u Au button : red	ITT
CO	S...104	55.15.0003	2*U	3u Au button : red	ITT
CO	S...105	55.15.0003	2*U	3u Au button : red	ITT

Ae.-Index 00 Ae.-Datum 03.05.85  
 Kopieausgabe 16.44 Uhr am 15.04.86

Visum TA

Ind.	Pos.Nr.	Teil Nr.	Wert (Menge)	Bezeichnung	Hersteller
CO	S...106	55.15.0003	2*U	3u Au button : red	ITT
CO	S...107		not used		
CO	S...108	55.15.0003	2*U	3u Au button : red	ITT
00	W...101				
00	W...102				
CO	W...103		not used		
CO	W...104		not used		
00	W...105		not used		
00	W...106				
CO	W...107				
CO	W...108				
CO	W...109		not used		
CO	W...110		not used		
00	W...111		not used		
CO	W...112		not used		
00	W...113				
CO	W...114		not used		
CO	W...115		not used		
CO	W...116				
CO	W...117				
CO	W...118		not used		
QQ	W...119		not used		
00	W...120	1.010.300.64	8-wire	flatcable	40 mm
CO	W...121	1.010.300.64	8-wire	flatcable	40 mm
00	W...122				
00	W...123				
00	W...124		not used		
CO	W...125		not used		
CO	C...201		not used		
CO	C...202		not used		
CO	C...203		not used		
CO	C...204		not used		
00	C...205		not used		
CO	C...206	59.25.3470	47 uF	-20% 16V	EL
CO	C...207	59.34.2330	33 pF		CE
00	C...208	59.25.1221	220 uF	-20% 6.3V	EL
00	C...209	59.25.3470	47 uF	-20% 16V	EL
00	C...210	59.34.2330	33 pF		CE
CO	C...211	59.25.1221	220 uF	-20% 6.3V	EL
CO	C...212	59.34.2330	33 pF		CE
00	C...213	59.25.1221	220 uF	-20% 6.3V	EL
00	C...214	59.34.2330	33 pF		CE
CO	C...215	59.25.1221	220 uF	-20% 6.3V	EL
00	C...216	59.25.3470	47 uF	-20% 16V	EL
00	C...217		not used		
01	C...218	59.32.4102	1 nF		CE
00	C...219		not used		
CO	C...220		not used		
00	C...221		not used		
CO	C...222	59.06.0223	22 nF		PE
CO	C...223		not used		
00	C...224		not used		



Ae.-Index 00 Ae.-Datum 03.05.85  
 Kopieausgabe 16.44 Uhr am 15.04.86

Visum TA

Ind.	Pos.-Nr.	Teil Nr.	Wert(Menge)	Bezeichnung	Hersteller
C0	IC..201		not used		
00	IC..202	50.09.0105	NE5532	dual op. amp.	Sig,Ex,Ra
C0	IC..203	50.05.0243	NE5534N	single op. amp.	Sig,Ra
00	IC..204	50.05.0243	NE5534N	single op. amp.	Sig,Ra
00	IC..205	50.05.0243	NE5534N	single op. amp.	Sig,Ra
C0	IC..206	50.05.0243	NE5534N	single op. amp.	Sig,Ra
00	MP....1	53.03.0166	5 pcs	IC-socket 8 pin	
00	MP....2	50.20.2001	2 pcs	CLIP ; 2 * TO 92	St
00	P...8.2	54.11.2007	2*8 pin	euroconnector	Bu
C0	Q...201	50.03.0516	BC 337	NPN matched with Q 202	Sie
C0	Q...202	50.03.0516	BC 337	NPN	Sie
00	Q...203	50.03.0625	BC 327	PNP matched with Q 204	Sie
C0	Q...204	50.03.0625	BC 327	PNP	Sie
C0	R...201		not used		
C0	R...202		not used		
C0	R...203		not used		
C0	R...204		not used		
C0	R...205		not used		
00	R...206		not used		
C0	R...207		not used		
00	R...208		not used		
00	R...209		not used		
C0	R...210		not used		
C0	R...211	57.11.4101	100 Ohm	5% 0.25W	
00	R...212	57.11.4101	100 Ohm	5% 0.25W	
C0	R...213		not used		
00	R...214		not used		
C0	R...215		not used		
C0	R...216		not used		
C0	R...217		not used		
C0	R...218		not used		
C0	R...219		not used		
C0	R...220		not used		
00	R...221	57.11.4101	100 Ohm	5% 0.25W	
00	R...222	57.11.4101	100 Ohm	5% 0.25W	
C0	R...223		not used		
00	R...224	57.11.4101	100 Ohm	5% 0.25W	
C0	R...225	57.11.4103	10 kOhm	5% 0.25W	
00	R...226	57.11.4103	10 kOhm	5% 0.25W	
00	R...227	57.11.4101	100 Ohm	5% 0.25W	
C0	R...228	57.11.4101	100 Ohm	5% 0.25W	
00	R...229	57.11.4683	68 kOhm	5% 0.25W	
C0	R...230	57.11.4333	33 kOhm	5% 0.25W	
C0	R...231	57.11.4683	68 kOhm	5% 0.25W	
00	R...232	57.11.4333	33 kOhm	5% 0.25W	
00	R...233	57.11.4333	33 kOhm	5% 0.25W	
C0	R...234	57.11.4333	33 kOhm	5% 0.25W	
00	R...235	57.11.3242	2.4 kOhm	2% 0.25W	
00	R...236	57.11.3242	2.4 kOhm	2% 0.25W	

Ae.-Index 00 Ae.-Datum: 03.05.85  
 Kopieausgabe 16.44 Uhr am 15.04.86

Visum TA

Ind.	Pos.Nr.	Teil Nr.	Wert (Menge)	Bezeichnung	Hersteller
00	R...237	57.11.3242	2.4 kOhm	2% 0.25W	
C0	R...238	57.11.3242	2.4 kOhm	2% 0.25W	
C0	R...239	57.11.3242	2.4 kOhm	2% 0.25W	
00	R...240	57.11.3242	2.4 kOhm	2% 0.25W	
C0	R...241	57.11.3242	2.4 kOhm	2% 0.25W	
C0	R...242	57.11.3242	2.4 kOhm	2% 0.25W	
00	R...243	57.11.3242	2.4 kOhm	2% 0.25W	
00	R...244	57.11.3242	2.4 kOhm	2% 0.25W	
00	R...245	57.11.3242	2.4 kOhm	2% 0.25W	
C0	R...246	57.11.3242	2.4 kOhm	2% 0.25W	
C0	R...247		not used		
C0	R...248		not used		
C0	R...249		not used		
00	R...250		not used		
C0	R...251		not used		
C0	R...252	57.11.3242	2.4 kOhm	5% 0.25W	
C0	R...253	57.11.3242	2.4 kOhm	5% 0.25W	
00	S...201	55.15.0003	2*U	3u Au button : red	ITT
00	S...202	55.15.0003	2*U	3u Au button : red	ITT
C0	S...203	55.15.0003	2*U	3u Au button : red	ITT
00	S...204	55.15.0003	2*U	3u Au button : red	ITT
C0	S...205	55.15.0003	2*U	3u Au button : red	ITT
00	S...206	55.15.0003	2*U	3u Au button : red	ITT
C0	h...201				
C0	h...202				

CE=Ceramic, CF=Carbon Film, EL=Electrolytic, MF=Metal Film,  
 PE=Polyester, PP=Polypropylen, PS=Polystyrol

MANUFACTURER: Bu=Burndy, Ex=Exar, Fc=Fairchild, GI=General Instrument  
 HP=Hewlett Packard, ITT=Intermetall, Mot=Motorola, Nat=N  
 [Matsushita], NS=National Semiconductors, Ph=Philips,  
 Ra=Raytheon, Sig=Signetics, Six=Siliconix, St=Studer,  
 TI=Texas Instrument

Ende der Positions Liste.

1.913.176

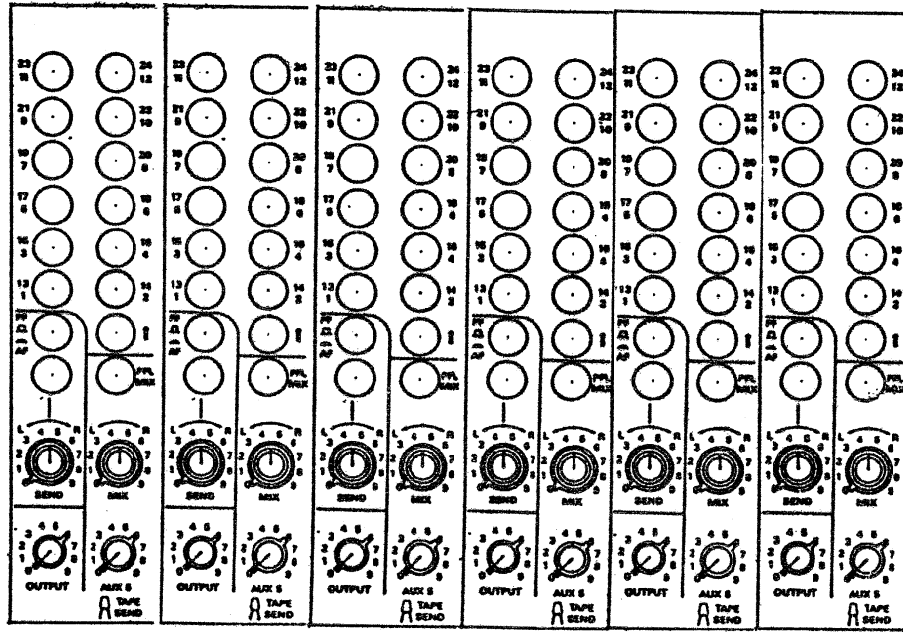

1.913.177

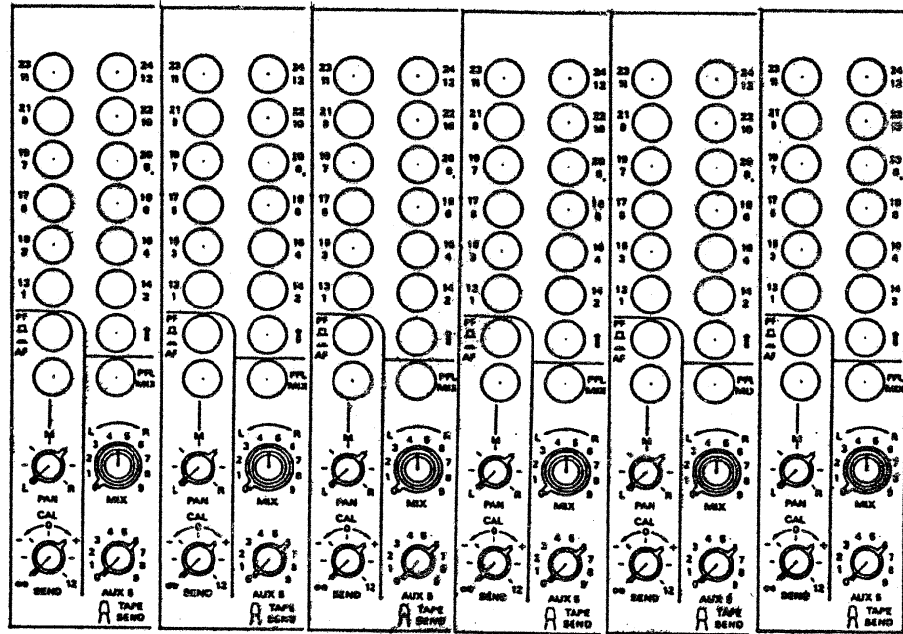
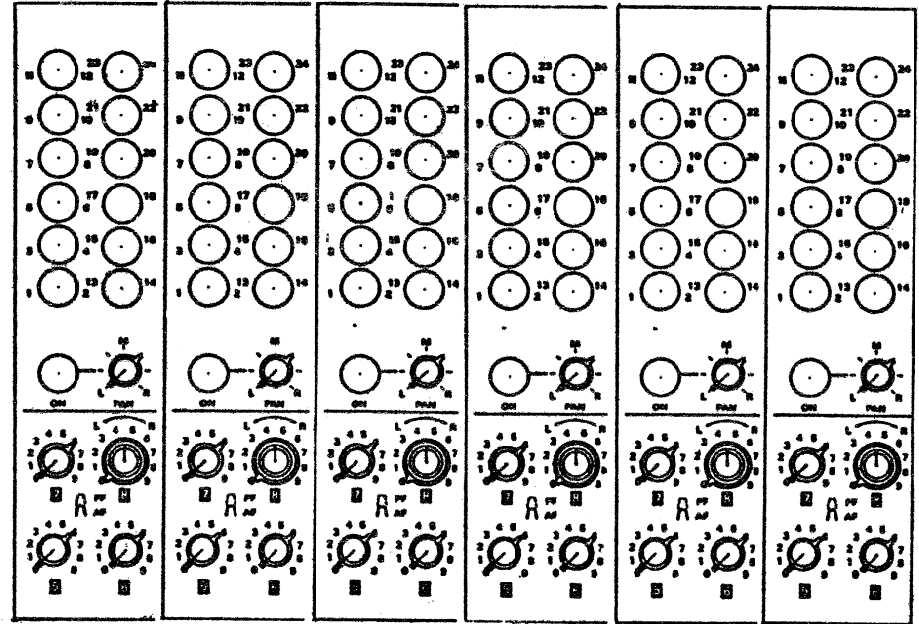

1.913.175

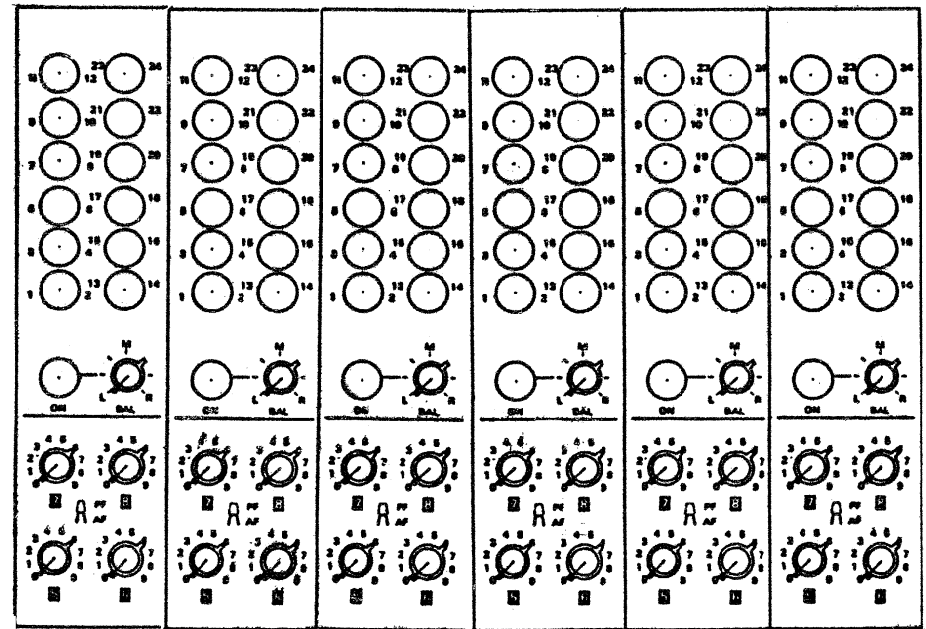

1.913.178