

# Compressor Amplifier

## type 179-120

The Compressor contains a wide range of variable attack and recovery times, including a programme dependent recovery time called AUTO and a switchable recovery delay. In order to operate with long attack times the Compressor is provided with a fast symmetrical Limiter, which because of its logarithmic function adds very little distortion.

A LED on the front panel indicates limiting. The limiter level is switchable normal or high.

The ratio and the amount of compression may be changed independently and still the output remains constant. A 1 mA instrument may be connected to show the actual compression in dB.

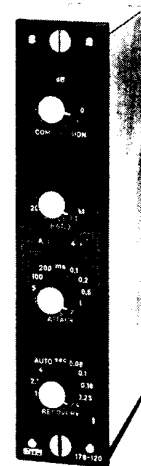

### TECHNICAL SPECIFICATIONS

Supply Voltage	24 V dc $\pm 10\%$ Note 1.
Maximum Ripple Voltage	0.1 V pp, 20 Hz to 20 kHz
Current Consumption	approx. 100 mA
Temperature Range	-20 to +60°C (-4 to +140°F)
Frequency Range (0.5 dB points)	20 Hz to 20 kHz
Input Filter	see fig. 2
Input Impedance within freq. range	see Input Terminations fig. 3
Output Impedance within freq. range	see Output Terminations fig. 4
Minimum Load Impedance	100 ohms, see fig. 4
Basic Amplification	0 to 15 dB see fig. 1
Compression Range	see fig. 1
Compression Ratio	adjustable 1:1 2:1 3:1 5:1 20:1
Attack Time	adjustable 100 microseconds/20 dB to 200 milliseconds/20 dB (11 steps)
Recovery Time	adjustable 60 milliseconds/20 dB to 4 seconds/20 dB and one "Auto" position (11 steps)
"Auto" dual time constants	200 msec. upon 15 seconds.
Recovery Delay	switchable 0 or 50 milliseconds
Distortion under static conditions	less than 0.5% up to 20 dB gain reduction
Signal to noise ratio at compression threshold	80 dB A-curve typical
Output noise at $R_g=200\Omega$	

NOTE 1. Either polarity of the power supply may be grounded. A build-in active voltage splitter provides an internal common reference (+ 12 V dc). This reference is available at terminals 19 and 7 for the input and output respectively.

277.

### NTP ELEKTRONIK A/S

Theklavej 44 Reg. No. 32426  
 DK-2400 Copenhagen NV Telegram-address Electrolab  
 Telephone (45-1) 10 12 22 Telex 16378 ntp dk

# Compressor Amplifier

type 179-120

compression 15 dB Ratio 2:1

Instrument Output

less than -86 dBu A-curve

0 to 1 mA for 0 to 20 dB compression

Linear dB scale

## Limiter Function

Attack Time

1,5 msec. combined with a full-wave logarithmic circuit which limits peaks shorter than 1,5 msec. to a level max. 3 dB above steady state.

Recovery Time

Following the recovery time set for the compressor

Steady State Limitation:

Threshold "Normal"

+6 dBu output with any of the three output-terminations shown in fig. 4

Steady State Limitation:

Threshold "High"

+19 dBu output when using the 0.7 : 1 output transformer fig. 4 C

+16 dBu output when using the direct output or the 1 : 1 output transformer fig. 4 A and B

Limiting Indicator

The GaAs diode lights up during limitation

Standard Colour

Dull black

Connector

Amphenol Tuchel 2700 000

Mechanical Outlines

see drawing

Weight

0,900 kg

## Stereo Operation

The control voltages of two units may be linked so as to obtain equal gain reduction in the two stereo channels. The control voltage is accessible at the connector. Gain reduction versus control voltage 5 dB per volt.

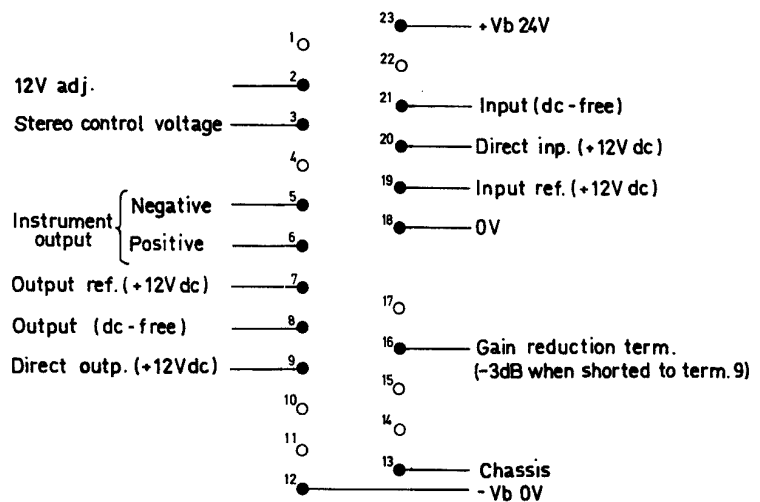
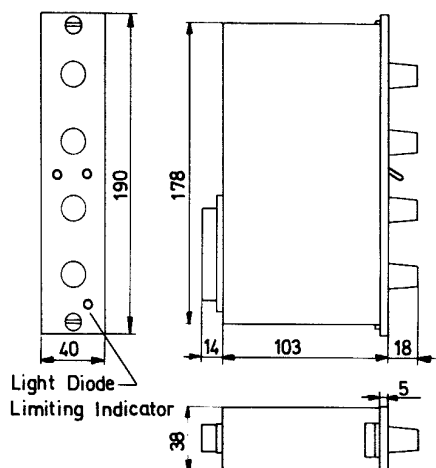

See also fig. 3 and 4

# Compressor Amplifier

type 179-120

Fig. 1 Compression and Limitation Characteristics.

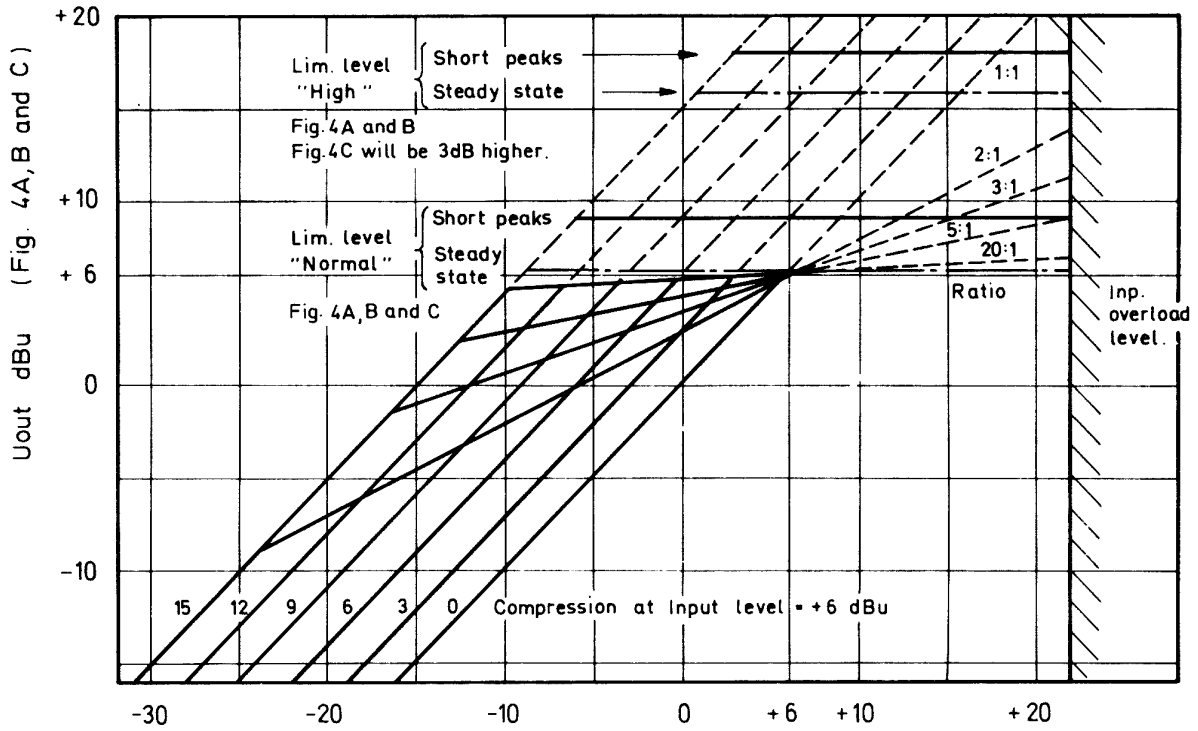

Short peaks < 1,5ms  
Steady state > 3 ms

Uin dBu (Fig. 3A, B and C)

Fig. 2 Input Filter. Frequency Response

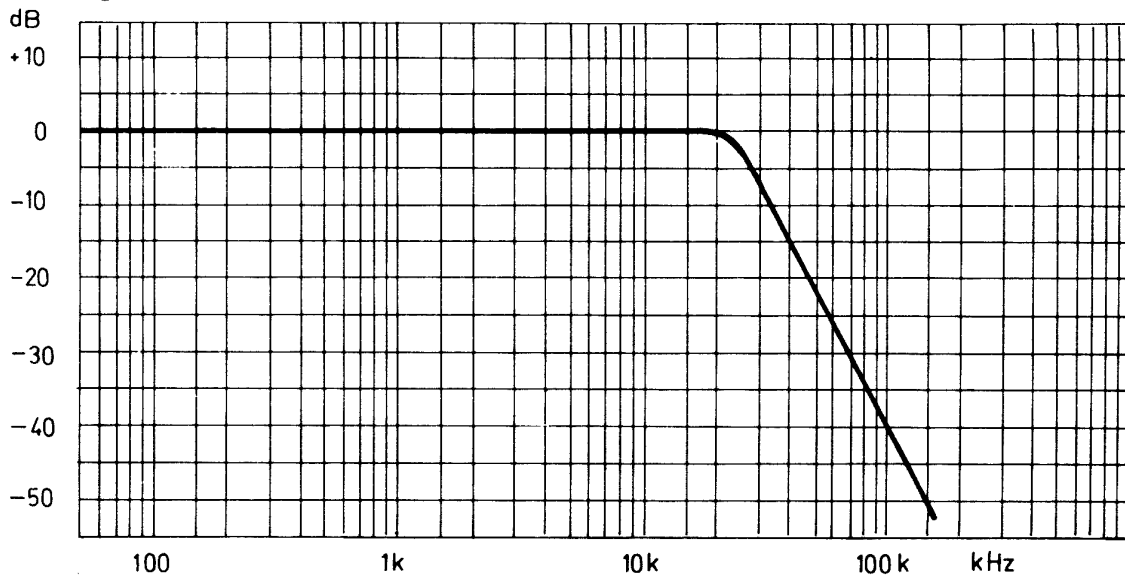

The versatile unit is an integrated combination of compressor, expander, limiter and gate functions. It is divided into two main circuits, one which processes the audio signal and one which, like an "analog-computer", controls the audio processing circuit by means of DC-signals.

This design gives a wide variety of facilities and allows the possibility for remote control of the functions.

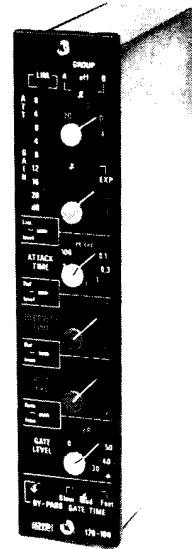

### TECHNICAL SPECIFICATIONS

#### General:

Supply voltage	22 - 32 V DC
Current consumption	approx. 130 mA
Input impedance, balanced, floating	10 Kohm $\pm$ 10%
Input CMRR	> 60 dB
Input overload level	+21 dBu
Output impedance, balanced, floating	< 40 ohm, typ. 30 ohm
Min. load impedance	300 ohm (Uout max. = +19 dBu)
Output overload level at f = 30 Hz	+21 dBu ( $R_L > 1$ Kohm)
Output overload level at f = 15 kHz	+15 dBu
Basic gain, adjustable	0 to +12 dB
Frequency range (- 0.3 dB points)	40 Hz to 15 kHz
Distortion (40 Hz to 15 kHz)	< 0.1% THD (Gain < 15 dB, Uout < +15 dBu)
Output noise (0 dB gain)	- 89 dBu RMS (20 Hz to 22 kHz) See Note 1 - 78 dBu psh. Peak (CCIR 468-1)

# Compressor / Expander type 179-160

## Compressor section:

Ref. level, adjustable	- 8 dBu to + 15 dBu
Max. gain/attenuation below threshold, adjustable	0 to 20 dB
Compression ratio, adjustable	1.3 : 1 to 20 : 1
Expansion ratio, adjustable	1.25 to 1 : 1.9
Attack time, adjustable	0.1 ms to 100 ms
Recovery time, adjustable	0.1 s to 6 s
Auto position, dual time constants	programme dependant
Recovery delay	programme controlled, frequency dependant.
Recovery hold level, adjustable	10 dB to 50 dB below actual operating level.
Control voltage, output/input	1 V per 5 dB, maximum number of compressors connected in a group = 10

## Limiter section:

Lim. threshold level, adjustable	0 dBu to + 15 dBu output level
Peak limitation level	3 dB above threshold level (at 10 dB lim.)
Attack time	1.5 ms combined with clipping circuit
Recovery time	programme dependant dual time constants.

## Gate section:

Threshold level, adjustable	0 dBu to - 50 dBu input level
Gate attenuation, adjustable	0 dB to 20 dB
Expansion ratio	1 : 2
Attack time (for increasing input level)	approx. 1 ms
Recovery time (for decreasing input level)	selectable 20 ms, 100 ms, 500 ms

## Mechanical data:

Connector	Tuchel 2700-000
Mechanical outline	see drawing
Weight	1 kg

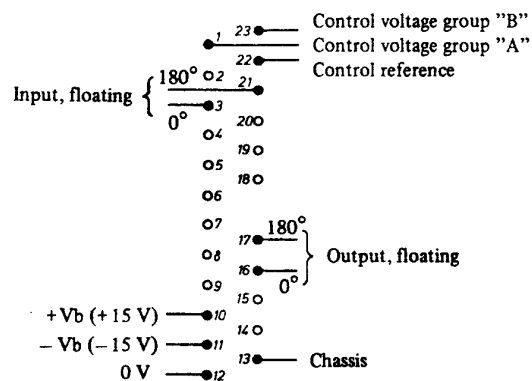
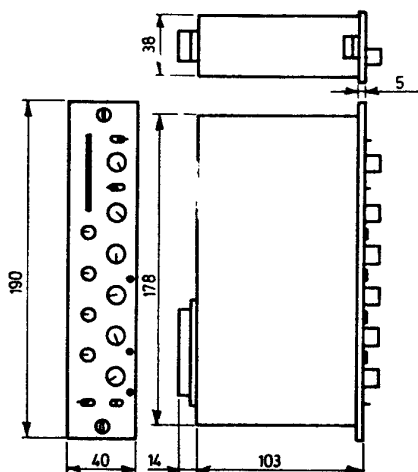

Mating connector: Tuchel 2701-000 seen from soldering side.

# Compressor / Expander type 179-160

Note 1:

Output Noise  
dbu RMS  
(BW 22 kHz)

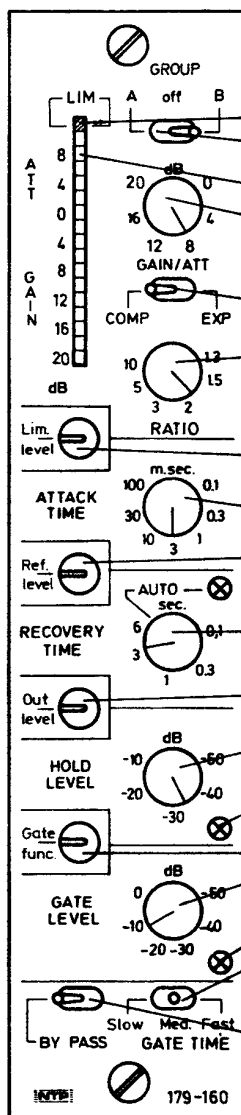
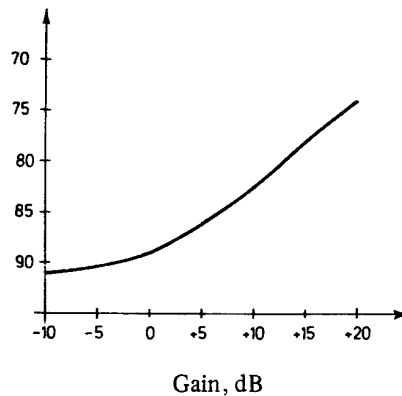

LED for limiting indication.

Switch for linking two or more units together (one controls the others)

Compression/expansion meter with 16 LED's.

Adjustable GAIN (compression or expansion) with constant output regardless of the setting, when input signal at reference level.

Compressor/expander selector switch.

Adjustable RATIO with constant output independent of the setting, when input signal at reference level. This design permits changing the GAIN as well as the RATIO during recording, without having to adjust individual input or output potentiometer etc.

Adjustable limiter level. The limiter is added as a separate safety limiter "on top" of the compressor/expander.

Wide range of selectable attack times.

Adjustable reference level for easy adaption to different console systems (normally +6 dBu).

Wide range of selectable recovery times, including an AUTO position with dual time constants and LED indicator.

Adjustable output level.

Adjustable HOLD level for preventing "pumping effects" etc.

LED which indicates that the HOLD function is active.

Adjustable GATE function selects low level attenuation

Adjustable GATE LEVEL for selecting gate threshold.

LED which indicates that GATE is active.

Selectable gate fade out time: Slow, medium or fast.

BY-PASS switch for disabling all the processing functions. The unit acts like a linear amplifier with the gain selected on the output level potentiometer when in BY-PASS position.

The compressor/expander is also available in a 19" cabinet containing two identical units and mains power supply. (See next page).

The limiter was designed according to an entirely new principle, involving a combination of a relatively long attack time with a symmetric logarithmic clipping circuit. This design eliminates the well known transient noise during striking. The recovery circuit is program dependent based on the dual time constant principle, eliminating pumping and similar effects. The LED on the front panel indicates limiting. Besides, an IMA instrument may be connected to indicate the actual gain reduction.

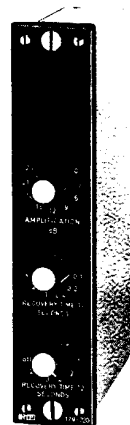

### TECHNICAL SPECIFICATIONS

Supply Voltage	24 V dc $\pm 10\%$
Maximum Ripple Voltage	0.1 V pp
Current Consumption, Steady State	approx. 75 mA
Current Consumption, during Heat-up	200 mA in 45 seconds
Temperature Range	$-20^{\circ}\text{C}$ to $+60^{\circ}\text{C}$ ( $-4^{\circ}\text{F}$ to $+140^{\circ}\text{F}$ )
Frequency Response	$\pm 0.5$ dB 20 Hz to 20 kHz
Input Impedance 20 Hz to 20 kHz	$\geq 10$ kohms balanced floating
Input Overload Level	+21 dBu (8.6 V rms)
Output Impedance 20 Hz to 20 kHz	$\leq 40$ ohms floating
Minimum Load	200 Ohms
Basic Amplification	$0 \pm 0.5$ dB
Preamplifier Gain - adjustable	0 to 24 dB in 3 dB steps
Limiting Threshold, re. to Output	+6 dBu (1.55 V rms) $\pm 0.5$ dB
Limiting Range	More than 30 dB
Distortion 20 Hz to 20 kHz	0 to 20 dB limitation 0.3%
Steady Conditions	20 to 30 dB limitation 0.5%
Attack Time	Note 1
Recovery Time T1 adjustable	1.5 msec. combined with fullwave logarithmic clipping circuit
Recovery Time T2 adjustable	0.1-0.2-0.4-1-2-4 sec.
Control Voltage output	1-2-4-10-20 "off" sec.
Instrument Output	5 dB/V ref. to pin 5
Signal to Noise Ratio at lim. Threshold	0 to 1 mA for 0 to 20 dB Limitation. Linear dB scale.
	84 dB A-curve

# Limiter Amplifier

type 179-230

Standard Colour

Dull black

Connector

Amphenol Tuchel 2700 000

Mechanical Outlines

see drawing

Pre-emphasis: 50 $\mu$  sec.

(normally not connected)

Weight

0,900 kg

## NOTE 1.

The limiting threshold stated above applies to steady state conditions. Peaks shorter than 1.5 msec. will be limited at a level max. 3 dB above steady state conditions.

## NOTE 2.

Stereo Operation:

The Control Voltage of two units may be linked together to obtain equal gain reduction in the two stereo channels.

NOTE. Either polarity of the power supply may be grounded. A build-in active voltage splitter provides an internal common reference (+ 12 V dc). This reference is available at terminal 5.

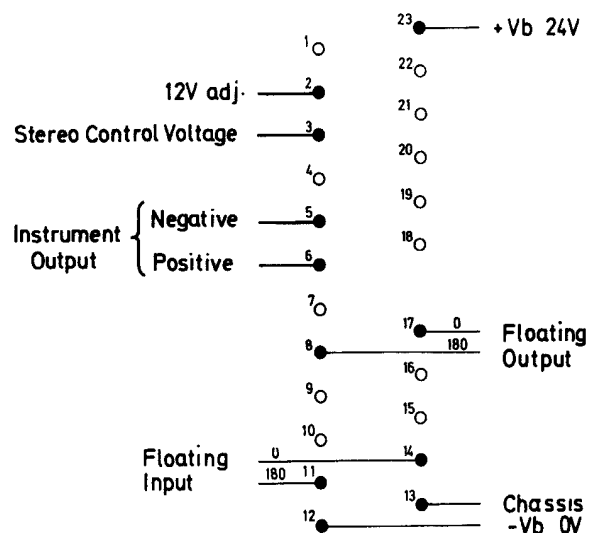
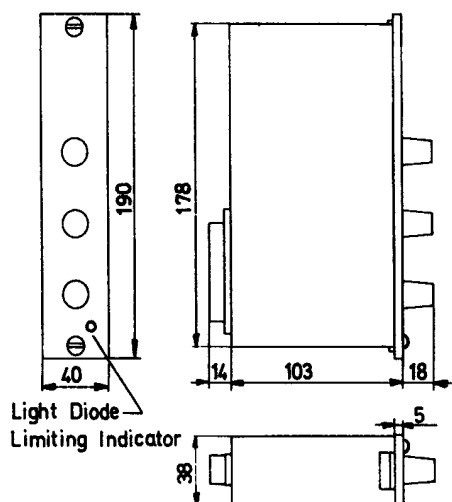



The limiter was designed according to an entirely new principle, involving a combination of a relatively long attack time with a symmetric logarithmic clipping circuit. This design eliminates the well known transient noise during striking. The recovery circuit is program dependent based on the dual time constant principle, eliminating pumping and similar effect. An Ima instrument may be connected to indicate the actual gain reduction. An external control voltage may be supplied.

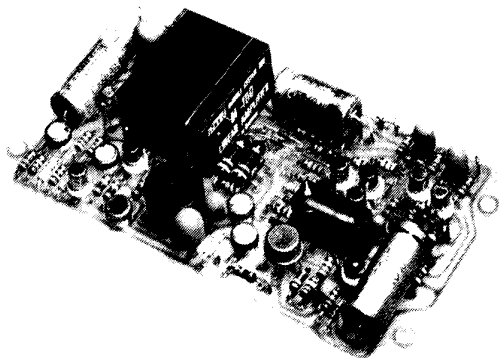

### TECHNICAL SPECIFICATIONS

Supply Voltage Symmetrical	$\pm 15 \text{ V dc} \pm 10\% \text{ OV common}$
Maximum Ripple Voltage	20 mV pp 20 Hz to 1 kHz Derate with 6 dB per octave above 1 kHz
Current Consumption Steady State	60 mA
Current Consumption during Heat-Up	approx. 225 mA in 45 sec.
Current Consumption without Oven	35 mA
Temperature Range	$-20^{\circ}\text{C}$ to $+60^{\circ}\text{C}$ ( $-4$ to $+140^{\circ}\text{F}$ )
Frequency Range within 0,5 dB	20 Hz to 20 kHz
Input Impedance, high Level Input +6 dBu	22 kohms in series with $100\mu\text{F}$
Input Impedance, low Level Input $-28$ dBu	460 ohms in series with $100\mu\text{F}$
Output Impedance	less than 1 ohm in series with $100\mu\text{F}$
Minimum Load Impedance	100 ohms
Basic Amplification high Level Input	0 dB $\pm 0.5$ dB
Basic Amplification low Level Input	+34 dB $\pm 0.75$ dB

# Limiter Amplifier Card

## type 179-300

Limiting Level ref. to Output	Note 1	+6 dBu
Limiting Range		more than 30 dB
Distortion under Static Conditions up to 20 dB Limiting 40 Hz to 20 kHz		less than 0.2%
Signal to Noise Ratio at Limiting Threshold		82 dB A-Curve
Control Voltage Output (Instrument etc.)	Note 2	1 Volt per 5 dB ref. to 0V
Indicator Output (LED Indicator)		14 mA
Attack Time	Note 1	1.5 millisecond combined with a full-wave logarithmic clipping circuit.
Recovery Time	Note 3	Dual time constants 200 msec. upon 15 seconds.
Weight		0,07 kg.

Note 1: The limiting level stated above applies to steady state conditions. Peaks shorter than 1.5 msec. will be limited at a level max. 3 dB above steady state conditions.

Note 2: Stereo Operation:  
The Control Voltages of two units may be linked together to obtain equal gain reduction in the two stereo channels. By cutting the connection between the two terminals E and F it is possible to apply an external control voltage giving a gain reduction of 5 dB per Volt up to 30 dB reduction.

Note 3: It is not recommended to change recovery and delay times when the card is used as a limiter. For override and other special functions, various time constants may be obtained by changing R 32 and R 44, and by changing R 52. For further information please contact the factory.

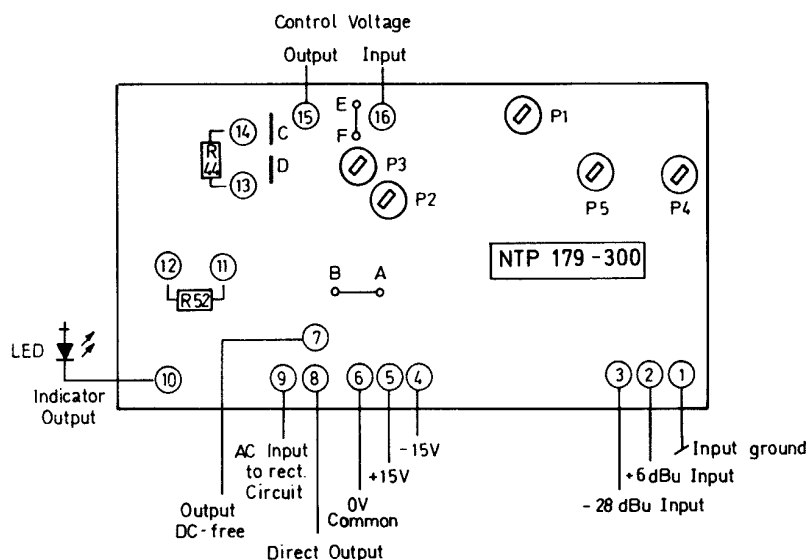

Card size: 115 x 60 mm  
Height: 20 mm

- High quality VCA
- Low distortion
- Balanced, floating input/output
- Adjustable gain
- Adjustable threshold level
- Adjustable recovery time
- Switchable pre-emphasis
- Wide supply range
- Compact design, EURO-card

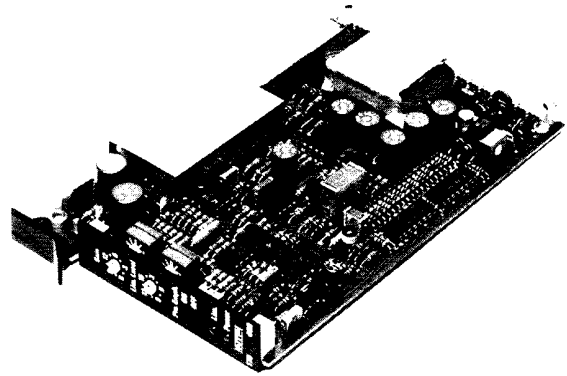

### TECHNICAL SPECIFICATIONS

Supply voltage	22 – 32 V DC	
Max. ripple on supply voltage	300 mV pp	
Current consumption	55 – 80 mA	
Input impedance, balanced, floating	20 Kohm $\pm$ 10%	
Input CMRR (15 KHz)	>60 dB	
Input overload level	+21 dBu	
Output impedance, balanced, floating	<40 ohm	
Min. load resistance	300 ohm	
Input gain, adjustable in 1.5 dB steps	0 to 13.5 dB $\pm$ 0.3 dB	
Frequency range, – 0.5 dB points	20 Hz to 20 KHz	
Distortion, 40 Hz to 20 KHz	<0.1% THD	
Output noise	at 0 db gain	at 12 dB gain
unweighted, 23 KHz bandwidth	– 87 dBu RMS	– 80 dBu RMS
weighted (CCIR 468-1, 1976)	– 76 dBu Peak	– 69 dBu Peak
Output threshold level adjustable in 1.5 dB steps	3 to 16.5 dBu $\pm$ 0.3 dB	
Limiting range	>30 dB	
Attack time	1.5 ms (note 1)	
Recovery time (dual)	0.1 s upon 20 s	
or with:		
External switch $T_1$ (Note 2, fig. 2-5)	0.1-0.2-0.4-1-2-4 s	
$T_2$	Off-1-2-4-10-20 s	
Recovery delay	50 ms	

# Limiter Amplifier Card type 179-400

Pre-emphasis on threshold level (switchable)	50 us or off
Control voltage slope (stereo linking voltage)	1 V/5 dB (note 3)
Meter output	1 mA/20 dB
Meter impedance	<5 Kohm
Lim. LED current	approx. 10 mA
Mechanical outline	EURO-card 100 x 160 mm
Connector	32 pole DIN pin connector

**Note 1:**

The attack time is the periode of time it takes the control voltage to reach 90% of its steady-state value, measured with 5 KHz tone-bursts. Peaks shorter than 1.5 ms will be limited by a full-wave smooth clipping circuit to a value approximately 1.5 dB higher than output threshold level with steady sinusoidal input signal. Fig. 1.

Fig. 1: Output level and control voltage with 5 KHz tone burst and input amplitude 10 dB above threshold level.

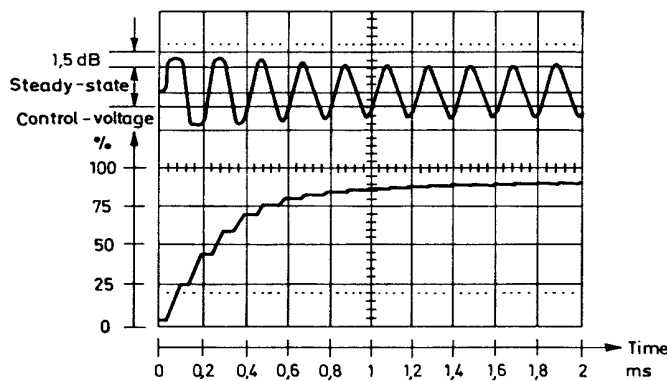

**Note 2:**

The recovery times are external switchable and follow the codes below:

Recovery time 1		C	B	A
Position				
0	fixed	1	1	1
1	fixed	1	1	0
2	100 ms	1	0	1
3	200 ms	1	0	0
4	400 ms	0	1	1
5	1 s	0	1	0
6	2 s	0	0	1
7	4 s	0	0	0

Recovery time 2		C	B	A
Position				
0	fixed	1	1	1
1	fixed	1	1	0
2	off	1	0	1
3	1 s	1	0	0
4	2 s	0	1	1
5	4 s	0	1	0
6	10 s	0	0	1
7	20 s	0	0	0

Logic levels:            1 = open or 15-32 V  
                               0 = Vcc (max. -Vcc + 3 V)

**Note 3:**

The control voltage of two units may be linked together to obtain equal gain-reduction.

# Limiter Amplifier Card type 179-400

Fig. 2 Recovery vs time and settings of  $T_1$ .  
 $T_2 = \text{off}$  tone-burst = 10 s

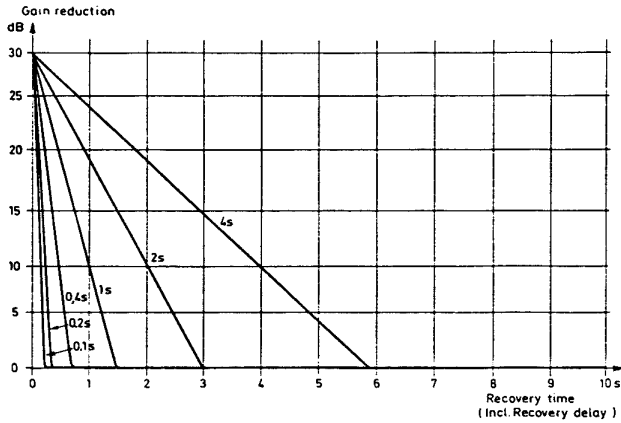

Fig. 3 Recovery vs time and settings of  $T_2$ .  
 $T_1 = 0.1 \text{ s}$  tone-burst = 10 s

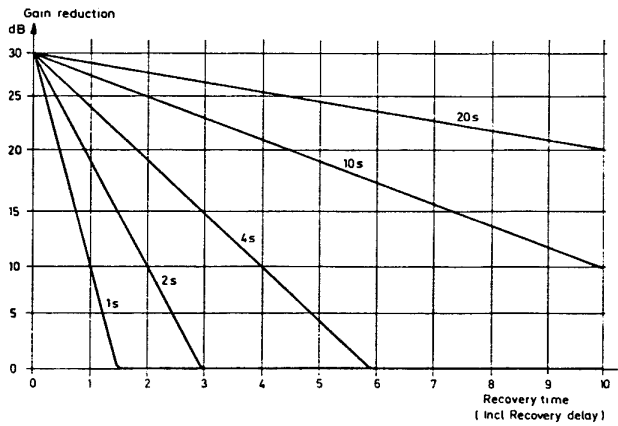

Fig. 4 Recovery vs time and tone-burst length  
 $T_1 = 1 \text{ s}$   $T_2 = 10 \text{ s}$

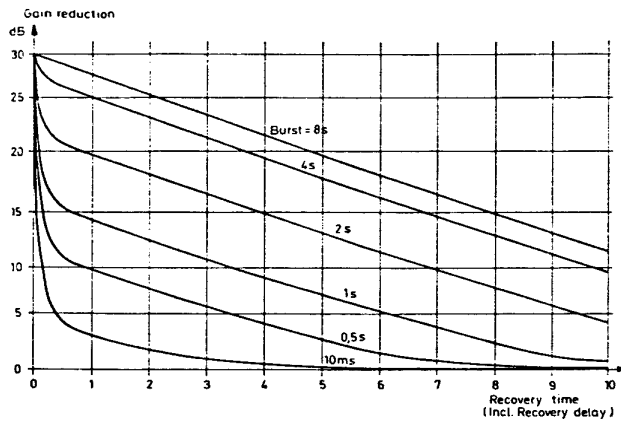
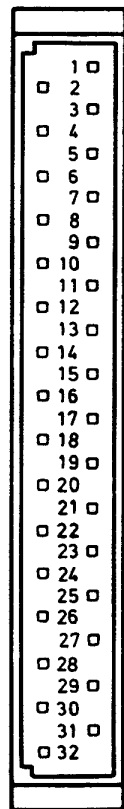
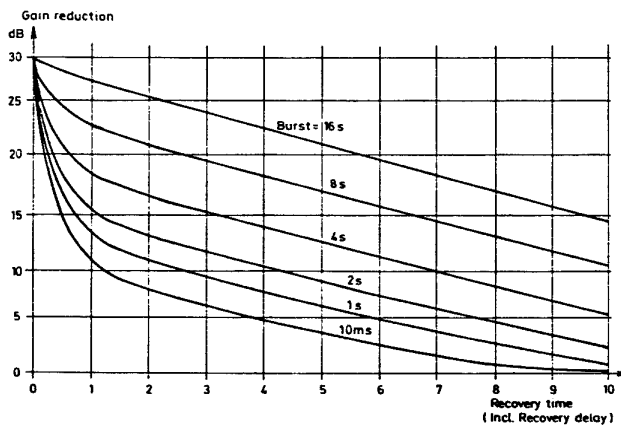

Fig. 5 Recovery vs time and tone-burst length  
 $T_1 = 4 \text{ s}$   $T_2 = 10 \text{ s}$



- |      |   |
|------|---|
| Pin  |   |
| 1    | 0° } Input                              |
| 2    |   |
| 3    | } Input screen (-VCC)                   |
| 4    |   |
| 5    |   |
| 6 C  | } Recovery time 2                       |
| 7 B  |   |
| 8 A  |   |
| 9    | } Recovery time 1                       |
| 10 C |   |
| 11 B |   |
| 12 A | } Lim. LED                              |
| 13   |   |
| 14   | Cathode                                 |
| 15   | Anode                                   |
| 16   |   |
| 17   |   |
| 18   |   |
| 19   | 0° } Output                             |
| 20   |   |
| 21   |   |
| 22   |   |
| 23   |   |
| 24   |   |
| 25   | Int. ref. (-VCC + 9V)                   |
| 26 - | } Compressor meter                      |
| 27 + |   |
| 28   | Stereo control voltage (Ref. to pin 25) |
| 29   | +VCC                                    |
| 30   |   |
| 31   | -VCC                                    |
| 32   | Screen                                  |

**TECHNICAL SPECIFICATIONS**

Supply Voltage	24 V dc $\pm$ 10% – common
Maximum Ripple Voltage	0.1 V pp 20 Hz to 20 kHz
Current Consumption (no signal)	55 mA
Current Consumption ( $U_{out} = +21$ dBu RL = 200 $\Omega$ )	145 mA
Temperature Range	-20 to +60°C (-4 to +140°F)
Input Overload Level	+21 dBu (Note 1)
Input Impedance (20 Hz – 20 kHz)	$\geq$ 10 kohms balanced floating
Output Overload Level	(Note 1) +21 dBu (RL = 600 ohms)
Output Impedance	$\leq$ 40 ohms balanced floating
Minimum Load Impedance	200 ohms
Gain (flat response)	0 dB $\pm$ 0.5 dB
Distortion 40 Hz to 200 Hz	less than 0.5%
Distortion 200 Hz to 20 kHz	less than 0.2%
Output Noise (flat response $R_g = 200\Omega$ )	-102 dBu A-curve
Presence/Absence Frequencies	0,7–1,0–1,4–2,8–4,0–5,6 kHz
Boost/Cut	$\pm$ 10 dB in 2 dB steps
High Frequency Filter	$\pm$ 12 dB in 3 dB steps at 10 kHz
Low Frequency Filter	$\pm$ 12 dB in 3 dB steps at 60 Hz
Standard Colour	Dull black
Connector	Amphenol Tuchel 2700 000
Mechanical Outlines	see drawing
Weight	0,900 kg

NOTE 1. The overload indicator lights up 2 dB before any of the amplifiers in the unit are overloaded.

6.78.

**NTP ELEKTRONIK A/S**

Theklavej 44 Reg. No. 32426  
DK-2400 Copenhagen NV Telegram-address Electrolab  
Telephone (45-1) 10 12 22 Telex 16378 ntp dk

# Filter Unit

type 182-100

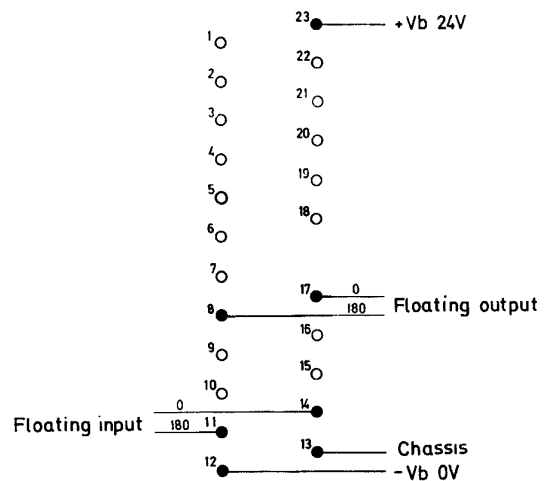
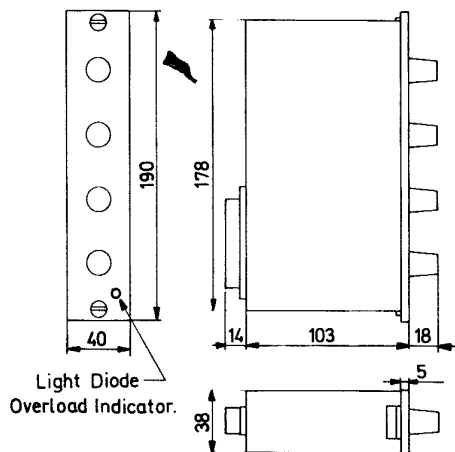
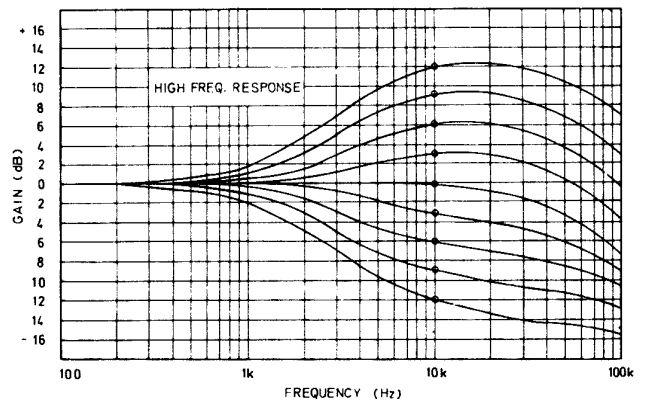
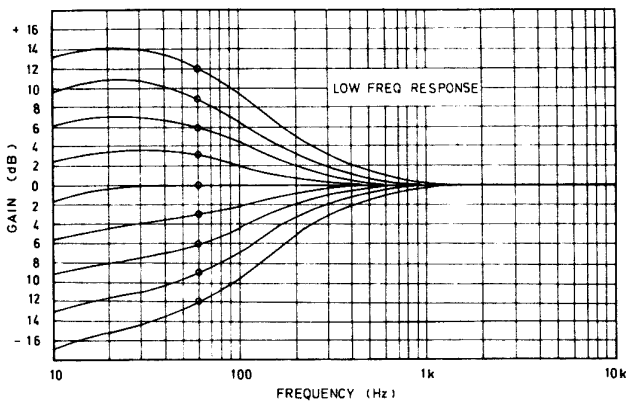
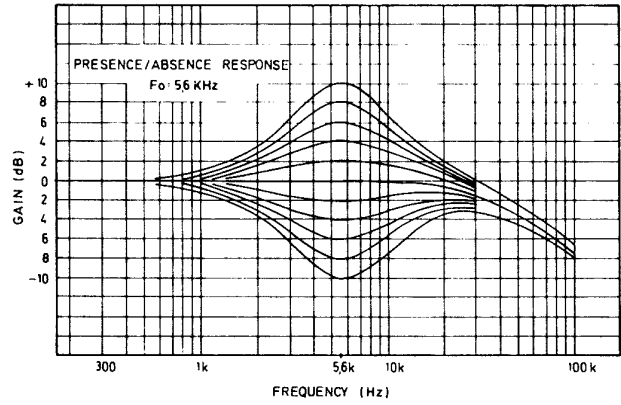
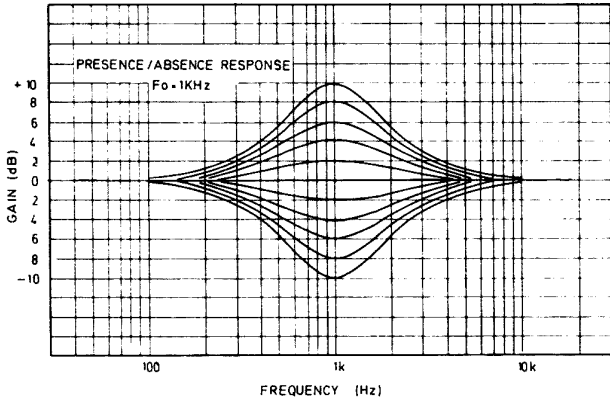

<b>Supply Voltage</b>	: 24 V dc $\pm$ 10% - common
<b>Maximum Ripple Voltage</b>	: 0.1 V pp
<b>Current Consumption (no signal)</b>	: 60 mA
<b>Current Consumption (max. load)</b>	: 120 mA
<b>Temperature Range</b>	: -20 to +60°C (-4 to +140°F)
<b>High Frequency Cut (-2,5dB)</b>	: 1-1.4-2-2.8-4-5.6-8-11.2-16 kHz
<b>Slope</b>	: 18dB/octave see curve
<b>Low Frequency cut (-2,5dB)</b>	: 40-60-80-113-160-226-320-452-640 Hz
<b>Slope</b>	: 18dB/octave see curve
<b>Input Overload Level</b>	: +21dBu (note 1)
<b>Input Impedance (20 Hz - 20 kHz)</b>	: 22 Kohms $\pm$ 15% Balanced Floating
<b>Output Overload Level</b>	: +21 dBu (RL=600ohms)(note 1)
<b>Output Impedance</b>	: 40 ohms Balanced Floating
<b>Minimum Load Impedance</b>	: 200 ohms
<b>Gain</b>	: 0 dB $\pm$ 0.5 dB
<b>Distortion 40 Hz to 200 Hz</b>	: less than 0.5%
<b>Distortion 200 Hz to 20 kHz</b>	: less than 0.2%
<b>Noise referred to Input</b>	: -103 dBu A-curve
<b>Connector</b>	: Tuchel T 2700
<b>Standard Colour</b>	: Dull Black
<b>Mechanical Outline</b>	: Front 40 x 190 mm Depth 103 mm (1.58x7.5") (4.05")

**Note 1:** The overload indicator is activated at input levels above approx. +20dBu.

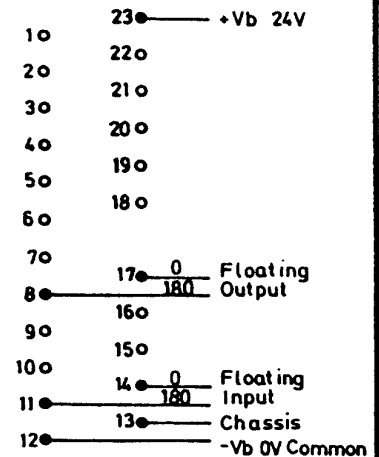
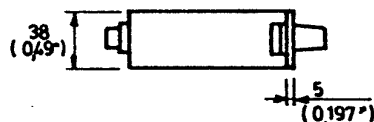
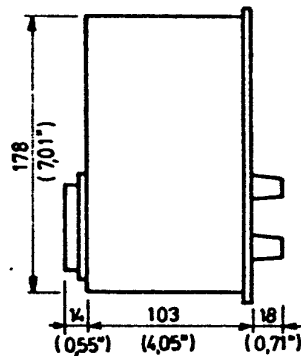
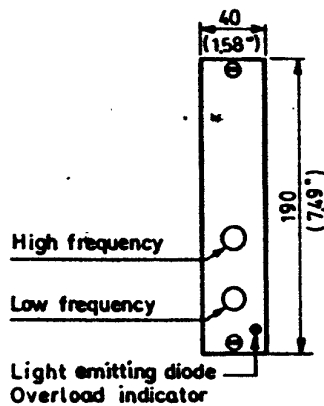



# Price List

valid from 1-1-77

## NTP Type

### Limiter and Compressor Amplifiers

179-120	Compressor/Limiter, 24V	4,830.-
179-140	Compressor/Limiter, $\pm 15V$	4,830.-
179-230	Limiter, var. time constants, 24V	3,410.-
179-240	Limiter, fixed time constants, 24V	3,100.-
179-250	Limiter	3,465.-
179-280	Limiter	2,860.-
179-300	Limiter card	995.-
179-340	Limiter, fixed time constants, $\pm 15V$	3,100.-
179-800	Instrument for Compressor/Limiter	465.-
179-900	Instrument for Compressor/Limiter	680.-
D 48 PL	Instrument for Compressor/Limiter	335.-

### Other Standard Units

177-520	Stereo Monitor Osc.	3,930.-
182-100	Filter, Presence/Absence	3,795.-
182-200	Filter, 18dB/oct.	3,465.-
184-140	Voltage Controlled Att.	3,660.-
184-150-B	Voice Over Unit	5,430.-
373-100	Mic. Amplifier	2,510.-
367-100	Distribution Amplifier	2,240.-
330-510	Microphone Amplifier and Limiter	2,290.-
330-650	Loudspeaker Unit incl. Amplifier	1,870.-

Discount: 15-49 units: less 5 per cent  
50 units and up: less 10 per cent

## M-100

### Linear Amplifier

Quantity:	1-9	10-24	25-49	50-99	100
Price:	144	130	118	105	88

No discount

### Transformers and Spare Parts

13592/2	Input Transformer, Line Level	290.-
13590	Output Transformer, Line Level	132.-
	Standard Scale for Light Spot Meters	151.-
	Standard Scale for LED and Bar Graph Meters	70.-
	Initial Costs for Scale Designed to Customer's Specification	950.-
L 63	Lamp for 177-210/300/310 6.3 - 3.3W	18.-
2700 000	Tuchel Connector	38.-
2701 000	Tuchel Mating Connector, Chassis Part	41.-
	N - Cassette, Al	190.-

No discount on Spare Parts

Prices in Danish Kroner f.o.b. Copenhagen

# Price List

valid from 1-1-87.

<u>NTP Type</u>	<u>Other Standard Units</u>	<u>DKK</u>
177-520C	Stereo Monitor Oscilloscope	8.390
177-590	Compatibility Meter	2.960
277-500A	Stereo Display Instrument, DC supply	11.180
277-500B	Stereo Display Instrument, mains supply	13.065
277-500C	Stereo Display Instrument, DC supply	12.685
184-140B	Voltage Controlled Att.	7.500
184-200	Remote Controlled Att.	6.600
184-300	Remote Controlled Att.	5.165
184-410	Voltage Controlled Att., Stereo	5.730
185-350	Override Control Unit	5.125
298-100	DC-controlled Mic. Amplifier	7.105
299-	Pre-mixer System, 16 Mic. Inputs	115.910
330-510	Mic. Amplifier incl. Limiter	4.960
367-300	Dual Line Amplifier	3.940
367-400	Line Amplifier	4.600
507-100	Burst Generator	17.585
507-110/120	Adapter Cable, Tuchel con./Print con.	640
535-200	2-Wire Telephone Hybrid	6.445
535-300	Dual 2-Wire Telephone Hybrid in 19" frame	17.455
535-310	Dual 2-Wire Telephone Hybrid in 19" frame	19.980
535-400	2-Wire Telephone Hybrid, Table Top Version	11.010
585-	Programmable Equalizer, 4-channel	108.390

M 100

Linear Amplifier

Quantity:	1-9	10-24	25-49	50-99	100-up
Price:	240	220	200	178	155

Spare Parts

	Standard Scale for Light Spot Meters	435
	Standard Scale, LED/Bar Graph Meters	150
	Initial costs for scale designed to Customer's specification	1.755
L 63	Lamp for 177-210/300/310, 6.3V - 3.3W	38
2700 000	Tuchel Connector	105
2701 000	Tuchel Connector, Chassis Part	115
	Nordic Module, A1	790

Discount:

Standard Units except 377-200 and M 100

10-19 units:	5%	20-29 units:	6.25%
30-39 units:	7.5%	40-49 units:	8.75%
50-up units:	10 %		
377-200:	3 - 9 units: 5%		
	10 - up units: 10%		
Spare Parts: No discount.			

Shipment: If airfreight is requested, a handling charge of DKK 285,- will be added for orders below DKK 38.000.

Prices are subject to change without notice.

This pricelist cancels all pricelists previously issued.



# Price List

valid from 1-1-87.

Prices in Danish Kroner f.o.b. Copenhagen.

<u>NTP type</u>	<u>Peak Programme Meters</u>	<u>DKK</u>
177-210	Light Spot, Stereo	18.550
177-300	Light Spot, Stereo	18.550
177-310	Light Spot, Mono	11.685
177-400	Bar Graph, Stereo	7.785
177-410	Bar Graph, Stereo (EBU-Meter)	7.785
177-700B	Light Diode, Mono	8.595
177-710	Light Diode, Mono	9.385
177-750	Light Diode, Mono	2.600
177-780	Light Diode, Stereo	5.505
177-800	Bar Graph, Stereo	4.880
177-900	VU-Meter, Stereo	4.880
177-950	VU/PPM	4.880
M 900	Moving Coil, Mono	1.810
M 920	Moving Coil, Mono	3.885
177-600	Moving Coil, Mono	4.525
277-100	Bar Graph, 8-channel	14.550
277-200	Bar Graph, Stereo	7.615
277-300	Bar Graph, Stereo	9.180
277-400	Bar Graph, Stereo (incl. Phasemeter)	9.180
277-450	Bar Graph, Stereo	7.785
277-590	Instrument Cabinet incl. Power Supply	2.790
277-900	VU-Meter, 8-Channel	14.550
277-950	VU-Meter, Stereo	7.615
377-500	Video, Mono	7.670
377-700	Video, Stereo	12.970
377-200	Multichannel PPM, electronic unit equipped with:	
	8 channels	26.390
	16 channels	35.100
	24 channels	43.810
	32 channels	52.520
	40 channels	61.230
377-210/220	Input and Log.amp. Card (8 channels)	8.710
377-2040	Extention Card	1.095
	<u>Limiter and Compressor Amplifiers</u>	
179-160	Compressor Expander	9.690
179-170	Dual Compressor/Expander for 220V AC for 19" mounting	21.600
179-230	Limiter, var.time constants, 24V	6.070
179-300	Limiter Card	1.905
179-310B	Limiter	5.940
179-400	Limiter	5.315
179-470	Dual Limiter for 220V AC for 19" mounting	13.175

12.86.

## **NTP ELEKTRONIK A/S**

Theklavej 44                      Reg. No. 32426  
DK-2400 Copenhagen NV        Telegram-address Electrolab  
Telephone (45-1) 10 12 22        Telex 16378 ntp dk