

# PARAMETRIC EQUALIZER

MODEL  
545



## FEATURES

- Four sections of Parametric Equalization; each continuously variable in Bandwidth, Frequency, and Boost and Cut.
- Two end cut filters tunable over a wide range for bandwidth restriction.
- Large, easy-to-adjust controls.
- Multi-point overload detection circuit.
- Balanced or unbalanced bridging input.
- Transformer isolated output.
- Self contained with regulated power supply.
- UREI quality, of course.

The Model 545 is a true parametric Equalizer, in which all important filter parameters are continuously variable. It is an ideal tool for creative and corrective equalization in professional sound recording, broadcast production, sound reinforcement systems, motion picture and TV recording, and live performances.

There are four parametric filter sections in the Model 545. Three filters cover overlapping ranges from 24 Hz to 12.5 kHz. The fourth filter, with a multiplier range switch, is tunable over the entire audio range from 15 Hz to 20 kHz. The characteristic of the filters is perfectly reciprocal in boost and cut, and they are continuously adjustable in boost and cut between plus and minus 15 dB, and in bandwidth between 1/4 and 2 octaves.

In addition a High Cut and a Low Cut filter section may be tuned to adjust the bandwidth of the equalizer. They are of the Butterworth type with an attenuation of 12 dB/octave beyond the -3 dB points.

While all filter sections are independently adjustable, they combine smoothly when tuned to nearly the same or the same frequency. This is especially useful when extreme filter characteristics and settings are desired.

Concentric controls, easy to read dials and markings, and accurate calibration aid in selecting and resetting any filter combination. Due to the uncluttered and logical arrangement of the Model 545 front panel its operation is simple.

An overload detection circuit monitors the signal throughout the unit. If the signal level in any part of the circuit approaches overload, a front panel LED flashes to warn the user. A bypass switch permits switching the equalizer section out of the system, restoring flat frequency response. All components are conservatively rated and of high quality. The built-in regulated power supply assures dependable operation from either 100 - 125 or 200 - 250 VAC, 50 or 60 Hz. The unit may be mounted in a standard 19" rack.

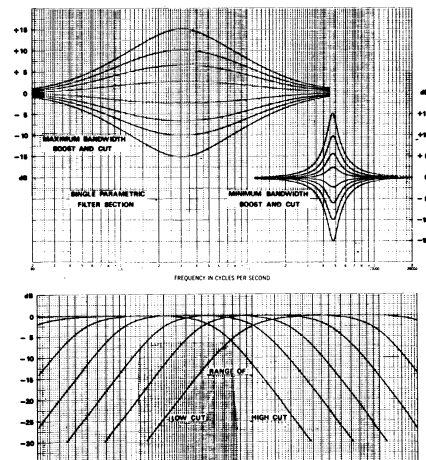

**UNITED RECORDING ELECTRONICS INDUSTRIES**

8460 SAN FERNANDO RD., SUN VALLEY, CALIFORNIA 91352  
TELEX 65-1389 UREI SNVY

(213) 767-1000

UREI company

MODEL  
545

# TECHNICAL SPECIFICATIONS

## Electrical:

<b>Input</b>	:	Balanced bridging differential amplifier.
<b>Input Impedance</b>	:	40 kohms, used as balanced input. 20 kohms, used as unbalanced (single-ended) input.
<b>Maximum Input Level</b>	:	+20 dBm (7.75 V RMS)
<b>Equivalent Input Noise</b>	:	Less than -85 dBm (15.7 kHz bandwidth) with all parametric controls at half rotation, and end cut filters set to maximum bandwidth.
<b>Gain</b>	:	Unity, $\pm 1$ dB, with E.Q. out or boost - cut controls set to zero.
<b>Frequency Response</b>	:	$\pm 0.5$ dB, 20 - 20,000 Hz (E.Q. out).
<b>Output</b>	:	Floating, transformer isolated.
<b>Output Load</b>	:	150 ohms to infinity.
<b>Power Output</b>	:	+24 dBm into 600 ohm load. +20 dBm into 150 ohm load.
<b>Distortion</b>	:	Less than 0.5% THD, 30 Hz to 15 kHz at maximum rated output.
<b>Parametric Equalizers</b>	:	Bandwidth continuously variable 1/4 to 2 octaves, Boost - Cut continuously variable +15 to -15 dB, Frequency ranges: Low Band        24 Hz - 310 Hz Mid Band        190 Hz - 2.24 kHz High Band       960 Hz - 12.5 kHz  Multi Band     15 Hz - 200 Hz 150 Hz - 2 kHz 1.5 kHz - 20 kHz
<b>Cutoff Filters</b>	:	Low cut: 16 Hz to 800 Hz, continuously tunable. High cut: 500 Hz to 25 kHz, continuously tunable.
<b>Cutoff Filter Type</b>	:	Butterworth; attenuation 12 dB/octave beyond -3 dB points.
<b>Power Requirements</b>	:	100 - 125 VAC, or 200 - 250 VAC 50/60 Hz, switch selectable, less than 10 W.
<b>Environment</b>	:	Operating 0°C to +50°C, storage -20°C to +60°C.

## Physical:

<b>Dimensions</b>	:	483 x 89 mm rack panel, Depth behind panel 203mm. (19" x 3 1/2" x 8")
<b>Finish</b>	:	Panel is 3.18 mm (1/8") brushed black anodized aluminum. Chassis is cadmium plated steel.
<b>Weight</b>	:	4.09kg (9 pounds).
<b>Shipping Weight</b>	:	5.91kg (13 pounds).
<b>Accessories</b>	:	Model 301 XLR/QG Adaptor for input and output.

BEFORE PROCEEDING WITH COMPLETE UNPACKING AND SETUP,  
CONSULT UNPACKING AND INSPECTION INSTRUCTIONS ON PAGE 5.

**MODEL 545**  
**PARAMETRIC EQUALIZER**



**United Recording Electronics Industries**

8460 SAN FERNANDO ROAD, SUN VALLEY, CALIFORNIA 91352

(213) 767-1000

## TABLE OF CONTENTS

	PAGE
<u>SECTION I. INTRODUCTION</u>	
1.1 DESCRIPTION	1
1.2 SPECIFICATIONS	2
1.3 CONTROLS	4
1.4 CONNECTIONS	4
 <u>SECTION II. INSPECTION AND INSTALLATION</u>	
2.1 UNPACKING AND INSPECTION	5
2.2 ENVIRONMENTAL CONSIDERATIONS	5
2.3 POWERING	5
2.4 LINE VOLTAGE SWITCH	6
2.5 EXTERNAL CONNECTIONS	6
2.6 IMPEDANCE AND TERMINATION	8
2.7 SIGNAL LEVEL AND OVERLOAD DETECTOR	9
 <u>SECTION III. OPERATING INSTRUCTIONS</u>	
3.1 GENERAL	10
3.2 SYSTEM CHECK	10
3.3 EXPERIMENTATION	10
3.4 DOCUMENTATION	10
3.5 APPLICATION	11
 <u>SECTION IV. THEORY OF OPERATION</u>	
4.1 INPUT AMPLIFIER	15
4.2 LOW CUT FILTER	15
4.3 PARAMETRIC FILTER	15
4.4 HIGH CUT FILTER	16
4.5 OUTPUT AMPLIFIER	16
4.6 OVERLOAD DETECTOR	16
4.7 POWER SUPPLY	17
 <u>SECTION V. MAINTENANCE</u>	
5.1 GENERAL	18
5.2 REPAIRS AND WARRANTY	18
5.3 ADJUSTMENTS	18
 <u>SECTION VI. ILLUSTRATIONS</u>	
FIGURE 4. SINGLE E.Q. SECTION FREQUENCY RESPONSE CURVES	20
FIGURE 5. COMPLEX FREQUENCY RESPONSE CURVES	22
FIGURE 6. FREQUENCY RANGE OF VARIOUS SOUND SOURCES	24
FIGURE 7. SCHEMATIC DIAGRAM OF UREI MODEL 545	28

SECTION I  
INTRODUCTION

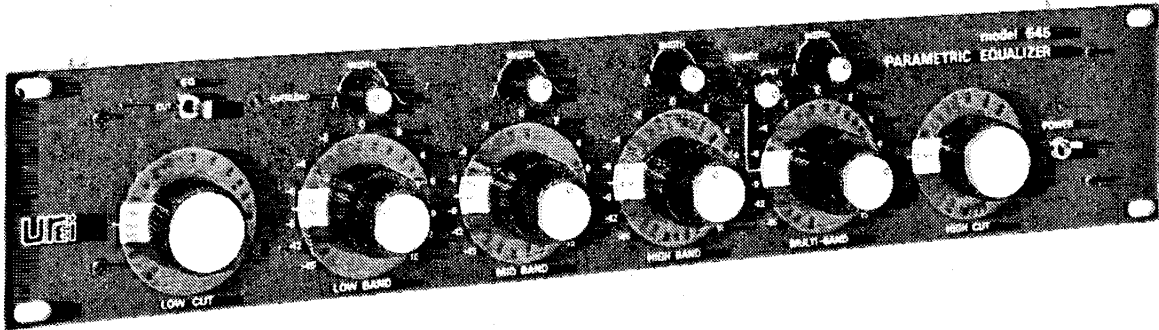

FIGURE 1. MODEL 545 FRONT PANEL.

1.1 DESCRIPTION.

The Model 545 is a true Parametric Equalizer in which all important filter parameters--slope, bandwidth and frequency--are continuously variable. It is an ideal tool for creative and corrective equalization in professional sound recording, broadcast production, sound reinforcement systems, motion picture and TV recording, and live performances.

There are four parametric filter sections in the Model 545. Three filters cover overlapping ranges from 24 Hz to 12.5 kHz. The fourth filter, with a multiplier range switch, is tunable over the entire audio range from 15 Hz to 20 kHz. All filters have perfectly reciprocal characteristics in boost and cut, and are continuously adjustable between plus and minus 15 dB. The bandwidth is variable from 1/4 to 2 octaves.

In addition, High Cut and Low Cut filter sections are included to adjust the overall bandwidth of the model 545. The cutoff filters are of the Butterworth type with an attenuation of 12 dB/octave beyond their -3 dB points. (See Figure 4-1 through 4-4, Section VI.)

While all filter sections are independently adjustable, they combine smoothly when tuned to the same or nearly the same frequency. This is especially useful when extreme characteristics and settings are desired.

An overload detection circuit monitors the signal throughout the unit. If the signal level in any monitored circuit point approaches overload, a front panel LED flashes to warn the user. A bypass switch permits switching the equalizer out of the system, thus restoring flat frequency response.

Concentric controls, easy to read dials and markings, and accurate calibration aid in selecting and resetting any filter combination. Due to the front panel's uncluttered and logical arrangement, operation is simple and self-explanatory. However, a thorough understanding of the Model 545 Parametric Equalizer can only benefit the user, so we recommend carefully reading this manual.

## 1.2 SPECIFICATIONS

### ELECTRICAL:

INPUT: Balanced bridging, differential amplifier

INPUT IMPEDANCE: 40 kohms, used as balanced input.  
20 kohms, used as unbalanced  
(single-ended) input.

MAXIMUM INPUT LEVEL: +20 dBm (7.75 V RMS)

EQUIVALENT INPUT NOISE: Less than -85 dBm (15.7 kHz bandwidth)  
with all parametric controls at half  
rotation, and end cut filters set to  
maximum bandwidth.

GAIN: Unity,  $\pm 1$  dB, with E.Q. out or boost - cut  
controls set to zero.

FREQUENCY RESPONSE:  $\pm 0.5$  dB, 20-20,000 Hz (E.Q. out).

OUTPUT: Floating, transformer isolated.

OUTPUT LOAD: 150 ohms to infinity.

POWER OUTPUT: +24 dBm into 600 ohm load.  
+20 dBm into 150 ohm load.

DISTORTION: Less than 0.5% THD, 30 Hz to 15 kHz at  
maximum rated output.

PARAMETRIC EQUALIZERS: Bandwidth continuously variable 1/4 to 2 octaves.

Boost - Cut continuously variable +15 to -15 dB.

Frequency ranges:

Low Band	24 Hz - 310 Hz
Mid Band	190 Hz - 2.24 kHz
High Band	960 Hz - 12.5 kHz
Multi Band	15 Hz - 200 Hz
	150 Hz - 2 kHz
	1.5 kHz - 20 kHz

CUTOFF FILTERS: Low cut: 16 Hz to 800 kHz, continuously tunable.  
High cut: 500 Hz to 25 kHz, continuously tunable.

CUTOFF FILTER TYPE: Butterworth; attenuation 12 dB/octave beyond -3 dB points.

POWER REQUIREMENTS: 100-125 VAC or 200-250 VAC, 50/60 Hz, switch selectable, less than 10 W.

ENVIRONMENT: Operating 0°C to +50°C (+32°F to +122°F); storage -20°C to +60°C (-4°F to +140°F).

PHYSICAL:

DIMENSIONS: 483 x 89 mm rack panel; Depth behind panel 203 mm. (19" x 3-1/2" x 8")

FINISH: Panel is 3.18 mm (1/8") brushed black anodized aluminum.  
Chassis is cadmium plated steel.

WEIGHT: 4.09 kg (9 pounds).

SHIPPING WEIGHT: 5.91 kg (13 pounds).

### 1.3 CONTROLS

- Frequency : Six large knobs with transparent skirts show the selected frequency against a white background segment.
- Boost - Cut : Four controls, concentric with frequency knobs, set the desired amount of boost or cut for each individual parametric filter section.
- Width : Four continuously adjustable controls, one above each parametric filter section, set the bandwidth of each parametric section.
- Range Switch : 3-position rotary switch selects the multiplier for the multi band parametric filter section.
- EQ Switch : 2-position toggle switch bypasses all filter sections.
- Overload : LED indicates when an overload condition occurs in any circuit section.
- Power : Toggle switch with LED to indicate when the Model 545 is powered.

### 1.4 CONNECTIONS

All connections for input and output are made through a barrier strip at the rear of the chassis. (See Installation Instructions, Section 2.5., Figures 2 and 3.)



SECTION II  
INSPECTION AND INSTALLATION

2.1 UNPACKING AND INSPECTION

Your Model 545 was carefully packed at the factory, and the container was designed to protect the unit from rough handling. Nevertheless, we recommend careful examination of the shipping carton and its contents for any sign of physical damage which could have occurred in transit.

If damage is evident, do not destroy any of the packing material or the carton, and immediately notify the carrier of a possible claim for damage. Shipping claims must be made by the consignee.

The shipment should include:

Model 545 Parametric Equalizer

UREI Instruction Manual (this book)

Two-part Warranty Card bearing the same serial number as the Model 545.

2.2 ENVIRONMENTAL CONSIDERATIONS

The system will operate satisfactorily over a range of ambient temperatures from 0°C to +50°C (+32°F to 122°F), and up to 80% relative humidity.

If the system is installed in an equipment rack together with high heat producing equipment (such as power amplifiers), adequate ventilation should be provided to prolong the life of components. Also, while circuitry susceptible to hum pick-up is sufficiently shielded from moderate electromagnetic fields, installation should be planned to avoid mounting the system immediately adjacent to large power transformers, motors, etc.

2.3 POWERING

The 545 may be operated from either 100-125 VAC or 200-250 VAC mains (50 or 60 Hz, single phase.) As indicated in section 2.4, the nominal line voltage may be selected with a rear panel switch. BE SURE TO VERIFY BOTH THE ACTUAL LINE VOLTAGE, AND THE SETTING OF THE VOLTAGE SELECTOR SWITCH BEFORE CONNECTING THE 545 TO THE MAINS.

To comply with most Electrical Codes, the 545 is supplied with a three-wire AC cord, the grounding pin of which is connected to the chassis. In some installations this may create ground-loop

problems. Ground loops can become very evident (as hum and buzz) if a significant potential difference exists between the AC conduit ground and the grounded metal enclosure in which the chassis is installed. If hum is experienced, check for the possibility of ground loops by using a 3-prong to 2-prong AC adapter, ungrounding the AC plug temporarily. This ungrounds the Model 545, and will probably cure the hum or buzz, but is not a substitute for proper system grounding. Be aware that unless the Model 545 Parametric equalizer is AC grounded, a safety hazard can exist. UREI accepts no responsibility for legal actions or for direct, incidental or consequential damages that may result from violation of any electrical codes.

#### 2.4 LINE VOLTAGE SWITCH

Unless a tag on the line cord specifies otherwise, the Model 545 was shipped ready for operation with nominal 115 VAC power mains. In order to change this for nominal 230 V (50 or 60 Hz), slide the VOLTAGE SELECTOR switch on the rear panel to the 230 position. The voltage is visible in a window next to the switch slot. Be sure to change the fuse to the correct value: 1/8-amp slo-blo when changing to 230 V operation or 1/4-amp slo-blo for 115 V operation. A small screwdriver should be used to move the recessed switch.

#### 2.5 EXTERNAL CONNECTIONS

Permanent input and output signal wires should be shielded cable, and connected in accordance with standard wiring practice, as indicated on the rear panel barrier strip.

If the Model 545 output is connected to a high impedance circuit, we recommend shunting the "+" and "COM" output terminals with a 620 ohm, 1/2 watt resistor. This assures optimum loading for the 545. (See section 2.6 regarding input termination).

(See Figures 2 & 3, next page)

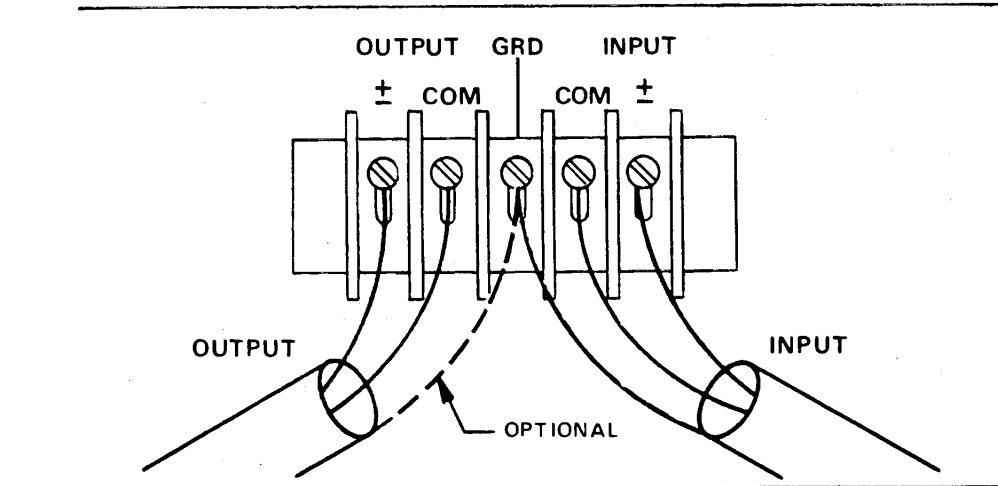

FIGURE 2. CONNECTING THE MODEL 545 WITH BALANCED INPUT AND BALANCED OUTPUT CIRCUITS.\*

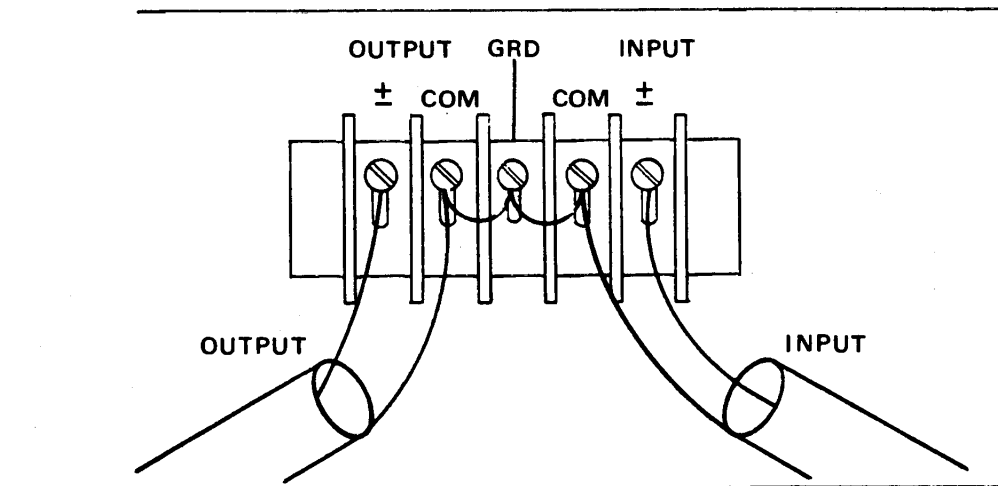

FIGURE 3. CONNECTING THE MODEL 545 WITH UNBALANCED INPUT AND UNBALANCED OUTPUT CIRCUITS.\*

\*With a balanced input and unbalanced output, or vice-versa, use the appropriate connections suggested by each of the above diagrams. No special switching or transformers are needed.

## 2.6 IMPEDANCE AND TERMINATION

Audio engineering had its roots in the telephone industry, and "600 ohm circuits" (together with their predecessors, "500 ohm circuits") are carry-overs from telephone transmission practices. Long audio transmission lines, like their video counterparts, must be properly sourced from and terminated in equipment which matches their characteristic impedance, if optimum frequency response and noise rejection are to be achieved.

However, transmission line theory and techniques are not only unnecessary but impractical within modern recording studios, broadcast studios and other local audio systems where transmission circuits are seldom more than several hundred feet in length. The advent of negative feedback circuitry and solid-state electronics has spawned modern audio amplifiers and other signal processing devices having source impedances of only a few ohms. They are essentially indifferent to load impedances and by varying their output current inversely to changes in load impedance, maintain the same output voltage into any load impedance above a rated minimum, with no change in frequency response.

Modern audio systems, therefore, utilize amplifiers and other active devices which have very low output impedances and high (10K to 50K) input impedances. These products may thus be cascaded (operated in series), or many inputs may be connected to a single output of a preceding device, without regard to impedance "matching". Switching, patching, etc. is simplified because "double loads" and "unterminated" bugaboos are essentially eliminated. "Floating" (ungrounded) transformer outputs minimize ground loop problems, and differential transformerless input circuitry (or input transformers) minimize common mode noise or interference which may be induced into the interconnecting wires or cables.

Where audio must be transmitted through cables or wire pairs of more than several hundred feet in length, however, transmission line termination practices should still be observed.

The Model 545 has input impedances of 40 kohms (40,000 ohms) when used in a balanced, differential input configuration, and 20 kohms (20,000 ohms) when used unbalanced (one side grounded). This makes the equalizer suitable for use with any nominal source impedance, low or high. Only when it is used from a source which requires a low impedance termination (such as a 600-ohm transmission line or older vacuum-tube equipment) will a source termination resistor be required at the 545 input.

## 2.7 SIGNAL LEVEL AND OVERLOAD DETECTOR

The Model 545's differential input amplifiers are capable of being driven by signals up to a level of +20 dBm, above which clipping and distortion occurs. The overload LED turns on when peak signals exceed the clipping level, and it will remain on long enough to be seen even if the excess signal is only a brief transient. To avoid audible distortion, when the LED indicator flashes more than occasionally, either lower the output level of the source feeding the equalizer, or use an external attenuation pad.

Overload conditions are monitored at each individual parametric filter section output since it is possible, through boost-cut combinations, to overload these circuits even though the input signal level is below +20 dBm.

The output amplifier is capable of delivering +24 dBm into a 600 ohm load (12.3 volts) or +20 dBm into a 150 ohm load.

## SECTION III

### OPERATING INSTRUCTIONS

#### 3.1 GENERAL

After the Parametric Equalizer has been installed and is connected to both the signal source and the succeeding equipment according to SECTION II, power may be switched ON. Set all controls to minimum, i.e.:

BOOST-CUT to midpoint ("0")  
LOW CUT fully counterclockwise  
HIGH CUT fully clockwise  
EQ IN/OUT to OUT

#### 3.2 SYSTEM CHECK

Apply program material, and monitor the output signal while the EQ switch is in the OUT position. The signal should be passed through the Model 545 without loss or gain in amplitude, or frequency alteration.

Since all controls are adjusted for minimum effect, no change should be noticeable when the EQ switch is set to the IN position.

#### 3.3 EXPERIMENTATION

To become familiar with the range and effects of the various filters, it is helpful to "play" with the controls and listen to a combination of settings.

It will be helpful to study the graphs included in this manual (Fig. 4 and 5, Section VI) although they show only a small selection of the possible representations.

The EQ switch is very useful to make an instant A-B comparison while altering adjustments.

#### 3.4 DOCUMENTATION

The very nature of a parametric equalizer permits an almost infinite number of control settings. For later duplication of a certain sound or a corrective filter shape it is necessary to document the position of the controls (Frequency, Bandwidth or "Q"), and the amount of Boost and/or Cut. This is made convenient by the Model 545's large dials and calibrated markings.

In addition, a frequency curve may be drawn with a suitable sweep generator and X-Y Recorder system, such as the UREI Model 200/2000.

### 3.5.0 APPLICATION

#### 3.5.1 GENERAL CLASSIFICATION

A parametric equalizer is used differently, depending on the job it has to do. Two main application categories are now popular:

1. The creative modification of program material during a live performance, a recording session, a mix-down, or similar occasions.
2. The corrective modification of frequency response of equipment in studio monitoring, commercial sound, and entertainment sound reinforcement systems.

#### 3.5.2 CREATIVE EQ-TECHNIQUES

It is acceptable to use extreme filter settings for creative work, especially to produce special effects. A single instrument, voice, or even a chord may be emphasized or de-emphasized by careful EQ adjustment. A feeling of motion or a "phasing" sound can be achieved by rotating the dials through their range as the signal passes through the filter. However, equalization is least obtrusive when a smooth filter characteristic is selected.

It should be remembered that excessive boost reduces the system headroom, makes additional power demands on amplifiers and speakers, and can cause clipping.

If "ringing" is experienced, it is usually due to high-Q (narrow bandwidth) settings. Although this may be an interesting effect for some work, ringing is not desirable in corrective equalization.

#### 3.5.3. USE OF "FREQUENCY RANGE OF VARIOUS SOUND SOURCES"

Figures 6-1, 6-2, 6-3 in Section VI have been compiled from various publications (Ref.1, 2). These charts may be helpful for finding the frequency setting on the Model 545 which affects a particular instrument. If a wide notch or peak is selected, it could eliminate or accentuate part of an entire musical passage.

The fundamental frequencies are shown in heavy lines; the upper harmonics are indicated by thin lines. Mechanical noise that extends beyond the upper harmonics is indicated with dots.

It should be recognized that the upper harmonics of most instruments extend to almost the top end of the audio spectrum. This implies that any EQ in the mid and upper frequency bands will affect the tonal character of other instruments, even though these instruments may not be played in the range the filter is tuned to.

Ref. 1 Olson, H.F., "Elements of Acoustical Engineering,"  
Van Nostrand, New York, 1947.

Ref. 2 Snow, W.B., Journal of the Acoustic Society of America,  
1931, Vol. 2, p. 33.

#### 3.5.4 LOW CUT & HIGH CUT FILTERS FOR CREATIVE EQ

The cutoff filters are used to restrict bandwidth. The LOW cut eliminates problems such as hum and rumble from turntables, stage noises transmitted through mic stands, and low frequency vibration of electric instruments having pickups. The High cut reduces H.F. noise and scratches, and it aids in getting excessive treble out of the audio signal. If the signal loses "presence" due to high frequency attenuation, it may be partially restored by tuning a parametric filter section close to the roll-off point of the High cut and adding some boost, as shown in Fig. 5-1, Section VI. The same technique may be used at the low frequency end to improve the apparent "bass response" after bandwidth restriction is adjusted.

#### 3.5.5 CORRECTIVE EQ-TECHNIQUES

This and the following sections are directed to the application of the parametric equalizer in acoustic sound systems. Proper equalization improves the reproduction of audio signals in several ways.

Since peaks in frequency response cause coloration of audio signals and also mask adjacent frequencies, the reduction of such peaks can positively affect the tonal balance of the program material and improve speech intelligibility.

The maximum available acoustic level is limited by those frequencies whose amplitude exceed the average level of the rest of the spectrum. These frequencies will cause ringing and feedback when their gains approach or exceed unity. Therefore, the aim of equalization in a room is to adjust the frequency response of the sound system for the smoothest overall electronic-acoustic curve. In practice, however, it is not always desirable to attempt to equalize to the last dB; minor anomalies in the response are not as objectionable as the artificial or "processed" sound that sometimes results from extensive equalization. More extreme filter settings



will inherently introduce more phase shift, which may cause more problems than the EQ solves.

### 3.5.6 FREQUENCY RESPONSE MEASUREMENTS

Before any equalization of a sound system in its environment is attempted, there are a few prerequisites:

- A) The entire system should be free of hum, noise, oscillation and RF interference. These are problems that benefit from source treatment more than from equalization.
- B) The frequency response characteristic of the system must first be measured; once the existing performance is known, effective equalization is then possible.

Several methods are available and, if applied judiciously, yield congruent results. One of the simplest, and yet most accurate and effective instruments is the UREI SONIPULSE™ 100-A Acoustical Audio System Analyzer. It uses a periodic test signal which contains all the harmonics of interest in the audio range. The advantages over systems using random (pink) noise are: shorter integration periods (especially at low frequencies), better accuracy because of the absence of fluctuations, and excellent reproducibility of results due to the nature of the test signal.

The system's frequency response may also be measured using a warbled sine wave. This method is part of the previously mentioned (Section 3.4) UREI 200/2000 Automatic Frequency Response Plotting System. The advantages are: simultaneous hard copy plot and an analysis bandwidth continuously variable by adjusting the amount of warble from less than 1/10 octave to 1/2 octave.

### 3.5.7 EQUALIZATION TECHNIQUE

Examination of the measured curve will show the deficiencies of the sound system in its environment. (Fig 5-2, Section VI) Using a low level point in the response curve as a reference, the simplest way to set the equalizer is to adjust its controls to an inverse of that curve. Remember that it is better to use mainly cut and to avoid adjustments which would require boost. (Fig. 5-3)

### 3.5.8 FEEDBACK SUPPRESSION

At least one filter section of the Model 545 must be uncommitted (preferably the multi band section). The bandwidth control should be set to narrow, i.e. 1/4 octave. This assures maximum

suppression of the feedback frequency, and only negligible loss of adjacent program material. The boost-cut control is set to midpoint, i.e. "0" position.

SLOWLY increase the gain until the feedback frequency becomes detectable, and stabilize the feedback to a constant, comfortable level. (Caution: feedback is not only annoying to the ear but it is also dangerous to unprotected amplifiers and loudspeakers!) Now turn the cut control CCW to the -15 dB position. Tune the frequency control until the feedback disappears. Reduce the attenuation of the cut control for a more accurate tuning, or for only enough cut to prevent feedback.

The result will be a higher amplifier gain setting than was possible before inserting the filter. Remember: an improvement of 3 dB is equal to twice the previously available power. To avoid ringing, it is best to adjust the gain at least 3 dB below the threshold of feedback.

#### 3.5.8 LOW CUT & HIGH CUT FILTERS AFTER CORRECTIVE EQUALIZATION

Examination of the filter's frequency response characteristic after equalization adjustments have been made may show that the band ends (low frequency and high frequency extremes) could overdrive the amplifier or speakers if program material contains energy at these frequencies, i.e. microphone pops, etc. Adjust the tunable Low cut and High cut filters until the resulting system response curve loses its "bathtub" shape and the house curve rolls off smoothly at each end, Fig. 5-4, Section VI.

## SECTION IV

### THEORY OF OPERATION

#### 4.1 INPUT AMPLIFIER

The signal is applied to a differential input amplifier (IC 1, sections A and B). The input accepts either balanced or unbalanced sources (see also Installation 2.6). Common mode rejection is factory adjusted with R2 and is typically better than 40 dB.

The factory set offset adjustment of R63 assures that no DC voltage is at the output of this amplifier stage, thus preventing audible clicks when operating the EQ switch.

The gain of the input amplifier is -6 dB. This provides additional headroom in the following parametric filter sections when they are used with boost equalization.

#### 4.2 LOW CUT FILTER

From the input amplifier stage the signal is coupled into the LOW-CUT FILTER. The filter circuit, a voltage controlled voltage source (VCVS), has a Butterworth response and the -3 dB point can be adjusted continuously from 16 Hz to 800 Hz. Below the -3 dB point the slope is 12 dB/octave.

#### 4.3 PARAMETRIC FILTER

The Model 545 contains 4 parametric equalizer sections. The only difference between the various sections is their respective tuning ranges; their function is otherwise identical. Therefore, this section describes only the operation of the first (Low Band) filter.

All four sections of the Quad OP-Amp IC2 are used in this state variable filter circuit. The main signal path is through the inverting amplifier section C. Potentiometer R9-C is connected between the input and output of amplifier IC2-C. Depending on the position of the wiper, any portion of the audio signal may be selected between the in-phase input and the inverted (180° out-of-phase) output. This signal feeds into the actual filter circuit, which is tuned with the dual-potentiometer R9 (A and B). The bandpass output from IC2-B is then coupled back through capacitor C9 to be differentially summed with the original input signal in IC2-C. The effect is that the bandpass output is added or subtracted (BOOST or CUT) from the composite audio signal.

The bandwidth of the filter is adjusted with potentiometer R7, which changes the feedback parameters of IC2-D. The values are selected for a range from 1/4 octave (CCW) to 2 octaves (CW).

The multi band filter is designed to cover the entire audio range. This is achieved with a multiplier switch which selects 3 different sets of tuning capacitors.

All parametric filter sections are cascaded and each output is separately monitored for a possible overload condition.

#### 4.4 HIGH CUT FILTER

The high frequency CUT filter, IC6-D, is a two pole VCVS filter circuit with Butterworth response. Beyond the -3 dB point the slope is 12 dB/octave. The -3 dB frequency is continuously tunable from 500 Hz to 25 kHz.

#### 4.5 OUTPUT AMPLIFIER

This amplifier consists of a high performance op-amp IC7, which drives the complimentary pair of power output transistors. The gain of the output stage is set by the ratio of resistors R55 and R54 to restore the 6 dB loss taken in the input stage, and to compensate for insertion loss in the output transformer (when terminated with 600 ohms).

Depending on the position of the EQ-switch, the signal is either coupled through C42 and R52 from the series of filter sections, or directly from the very low impedance output of the input stage IC1-B (effectively overriding the signal from the filters).

#### 4.6 OVERLOAD DETECTOR

The overload detector will react to signal levels approaching the maximum signal amplitude at any of 5 different points throughout the Model 545.

Under normal conditions the output of IC6-B is positive due to a negative bias voltage at its inverting input, and the LED is turned OFF. If a signal level, conducted through any of the 5 input diodes, is high enough to exceed the threshold set by R42 and R44, the amplifier output changes state. The output goes negative and the LED turns ON. To insure that the LED lights up long enough to be observed even though the overload may be caused by very short duration signals, a pulse-stretching network is included in the positive feedback loop of the amplifier IC6-B.

#### 4.7 POWER SUPPLY

The power supply is bipolar employing two integrated circuit voltage regulators VR1 and VR2 to provide low-ripple, ±18 volt DC. Additional filter capacitors assure power supply stability and low noise.

The pilot LED is connected to the positive side of the power supply to indicate power ON condition.

## SECTION V

### MAINTENANCE

#### 5.1 GENERAL

The Model 545 is an all solid-state unit, ruggedly constructed with only the highest quality components. As such, it should provide years of trouble free use with normal care. All parts used are conservatively rated for their application, and workmanship meets the rigid standards you have learned to expect in UREI products.

NO SPECIAL PREVENTIVE MAINTENANCE IS REQUIRED.

#### 5.2 REPAIRS AND WARRANTY

The Model 545 is factory warranted to the original purchaser against defects in material and workmanship for one year after initial purchase. This limited warranty must be activated at the time of purchase by returning the registry portion of the Warranty Card to the factory. Should a malfunction ever occur, the dealer from whom the unit was purchased will be glad to handle return for factory repair; alternately, for prompt service, ship the unit prepaid directly to the factory. Be sure it is well packed in a sturdy carton, with shock-absorbing material such as foam rubber, styrofoam pellets or "bubble-pack" completely filling the remaining space. Particular attention should be paid to protecting the controls and switches. Include a note describing the malfunction, and instructions for return. We will pay one-way return shipping costs on any in-warranty repair.

Because of specially selected components in this product, field repairs are not authorized during the warranty period, and attempts to perform repairs may invalidate the warranty.

#### 5.3.0 SERVICE ADJUSTMENTS

These controls have been carefully set at the factory and should not require adjustments except after service work.

#### 5.3.1 COMMON MODE BALANCE

The internal trimpot R2 affects the COMMON MODE BALANCE. If a check or an adjustment is necessary the following procedure should be followed:

Connect the  $\pm$  and COM input terminals together and apply an input signal between this connection and the GND terminal (100 Hz, 3 V RMS).

Switch the EQ OUT and measure the signal with an AC VTVM or DVM across the output terminals of the Model 545. Adjust the trimpot R2 for a minimum reading, switching the voltmeter gradually to more sensitive ranges.

### 5.3.2 OFFSET ADJUSTMENT

The internal trimpot R63 affects this adjustment. It should only be necessary to change the factory setting if IC1 and/or IC7 are replaced. The adjustment is correct when the DC output of IC1-B is 0 VDC. Since there is no offset voltage at the input of IC7, no "click" will be generated when the EQ switch is operated.

#### PREFERRED METHOD

Adjust R63 for 0 VDC at the output of IC1-B (blue wire at the EQ switch).

#### ALTERNATE METHOD

Connect the output terminals of the Model 545 to a high gain amplifier and loudspeaker. With no input signal applied switch the EQ IN and OUT.

Listen to the loudspeakers and adjust R63 for minimum audible "click" while operating the EQ switch.

SECTION VI

FIGURE 4. SINGLE E.Q. SECTION FREQUENCY RESPONSE CURVES.

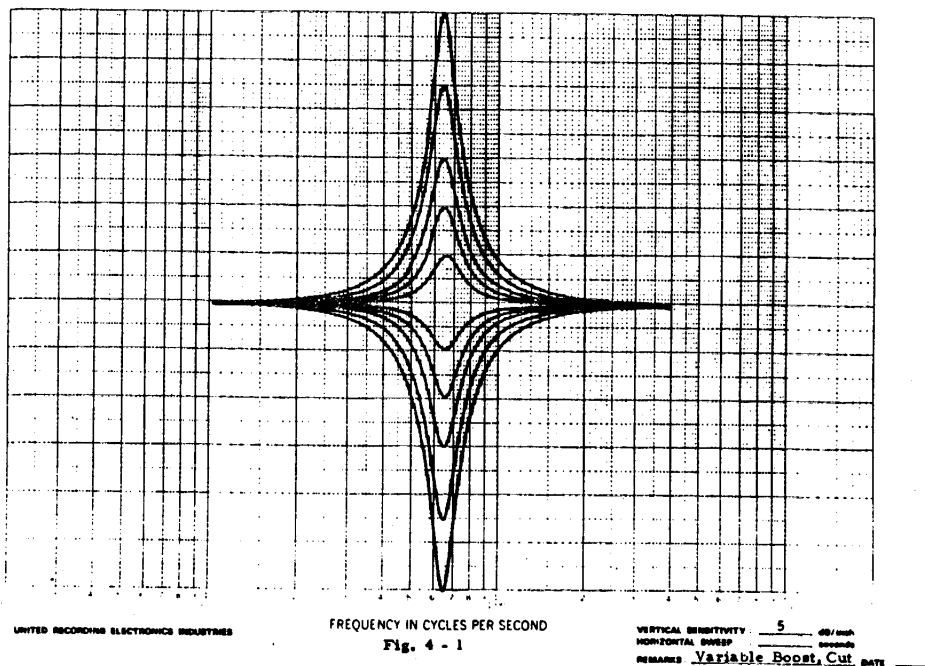

FIGURE 4-1. SINGLE PARAMETRIC FILTER SECTION ADJUSTED TO VARIOUS AMOUNTS OF BOOST OR CUT, WHILE THE BANDWIDTH (Q) REMAINS AT A CONSTANT NARROW (1/4-OCTAVE) SETTING. VERTICAL SENSITIVITY = 5 dB/in.

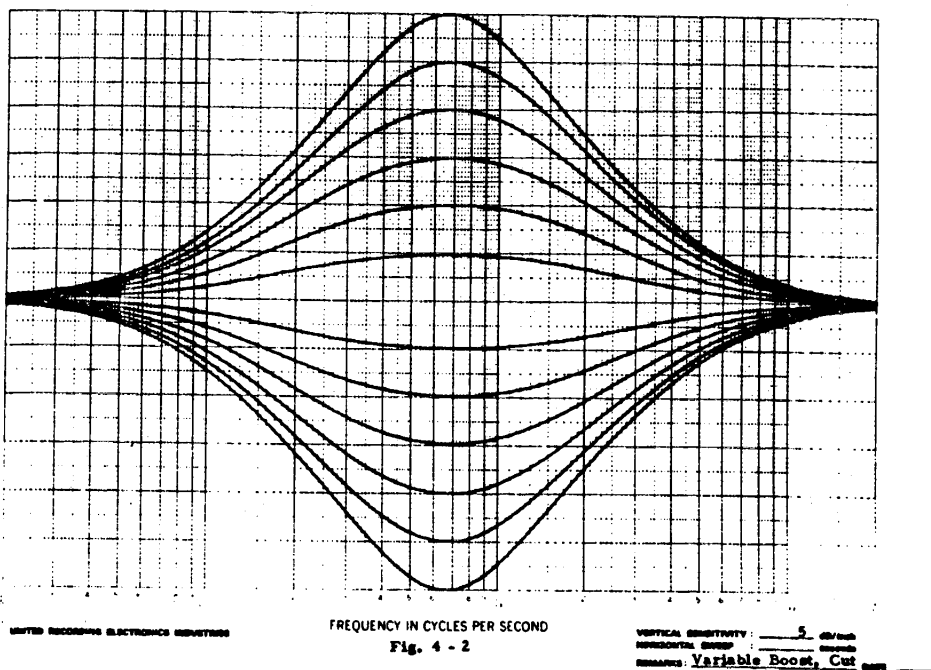

FIGURE 4-2. SINGLE PARAMETRIC FILTER SECTION ADJUSTED TO VARIOUS AMOUNTS OF BOOST OR CUT, WHILE THE BANDWIDTH (Q) REMAINS AT A CONSTANT WIDE (2 OCTAVE) SETTING. VERTICAL SENSITIVITY = 5 dB/in.



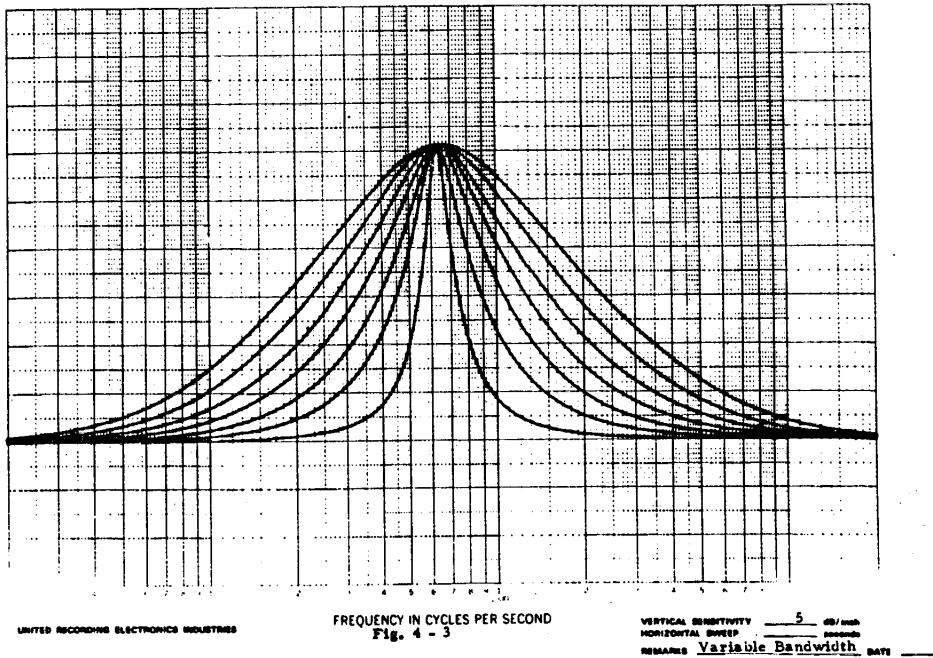

FIGURE 4-3. SINGLE PARAMETRIC FILTER SECTION ADJUSTED TO VARIOUS BANDWIDTHS (1/4 OCTAVE TO 2 OCTAVES). BOOST REMAINS CONSTANT AT +15 dB. VERTICAL SENSITIVITY = 5 dB/in.

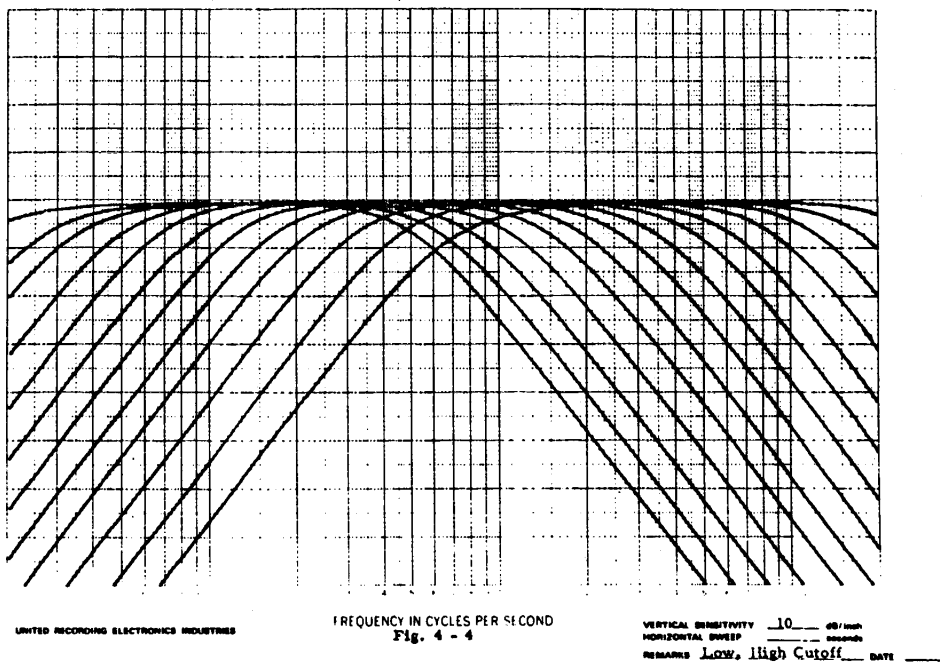

FIGURE 4-4. RANGE OF END CUT FILTERS. VERTICAL SENSITIVITY = 10 dB/in.

FIGURE 5. COMPLEX FREQUENCY RESPONSE CURVES.

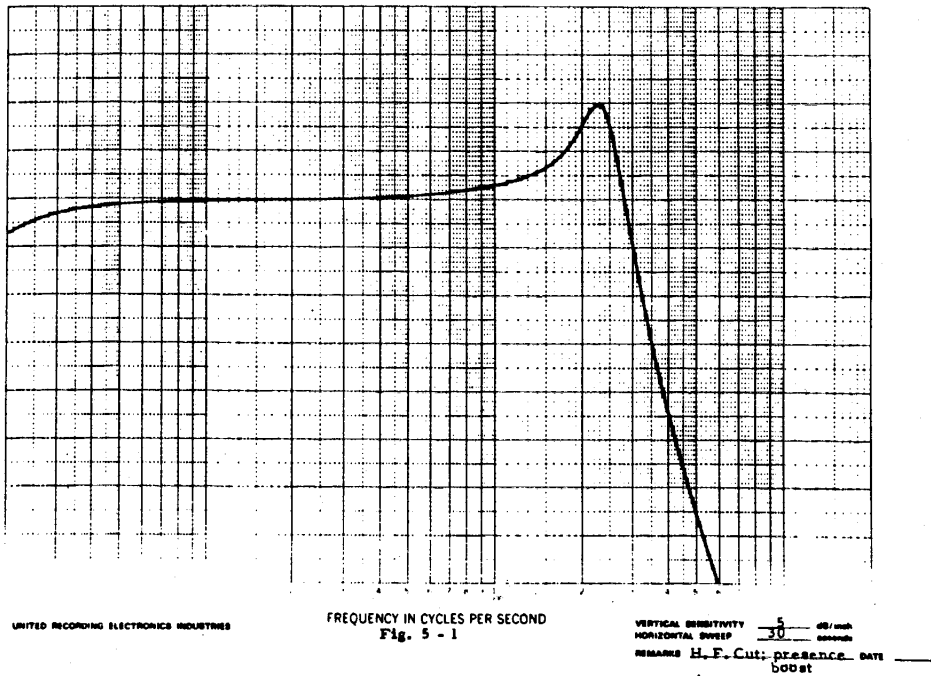

FIGURE 5-1. HIGH CUT FILTER ADJUSTED TO ROLL OFF HIGH FREQUENCY NOISE. SINGLE PARAMETRIC FILTER SECTION ADJUSTED +5 dB BOOST TO ACCENTUATE PRESENCE OF AUDIO SIGNAL (PARAGRAPH 3.5.2). VERTICAL SENSITIVITY = 5 dB/in.

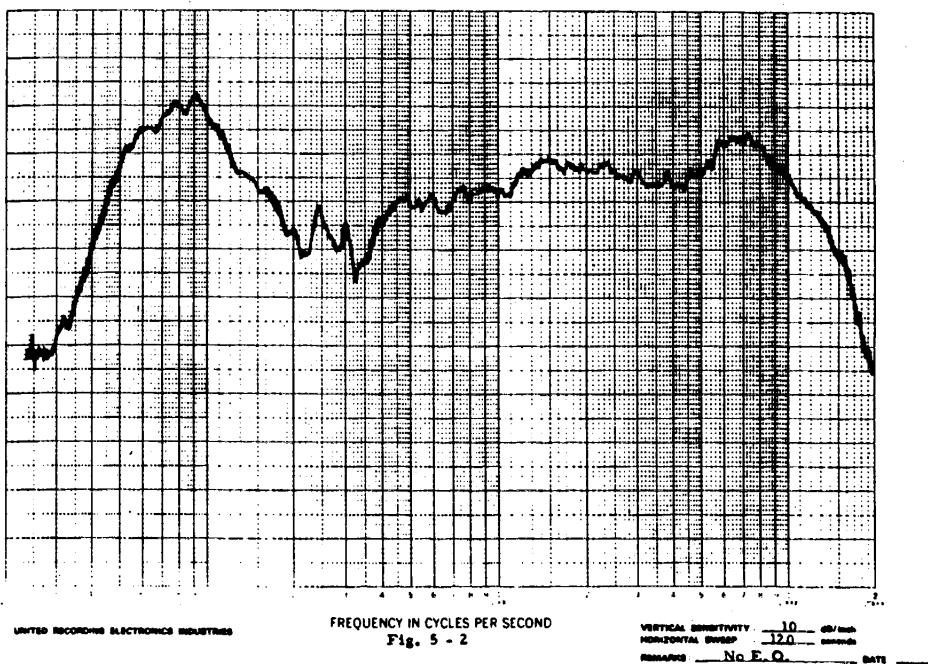

FIGURE 5-2. ACOUSTIC ANALYSIS OF A STUDIO MONITOR SPEAKER, MEASURED WITH A SWEEPED SINE WAVE WHICH WAS WARBLED WITH 1/3-OCTAVE BANDWIDTH. VERTICAL SENSITIVITY = 10 dB/in.

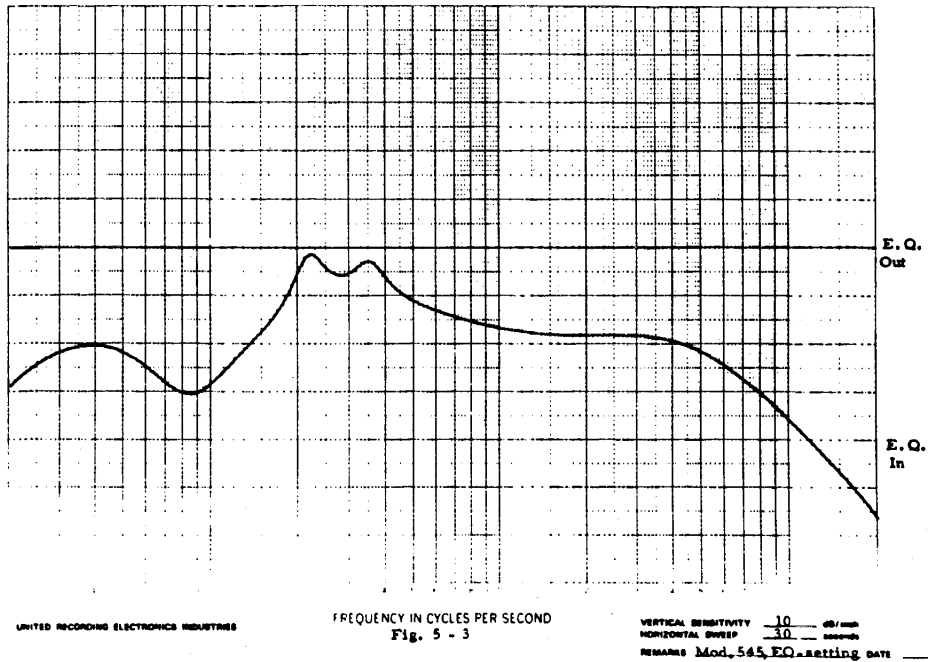

FIGURE 5-3. FILTER CHARACTERISTICS OF THE PARAMETRIC EQUALIZER AFTER THE NECESSARY ADJUSTMENTS WERE MADE TO COMPENSATE FOR THE RESPONSE INDICATED IN FIGURE 5-2. VERTICAL SENSITIVITY = 10 dB/in.

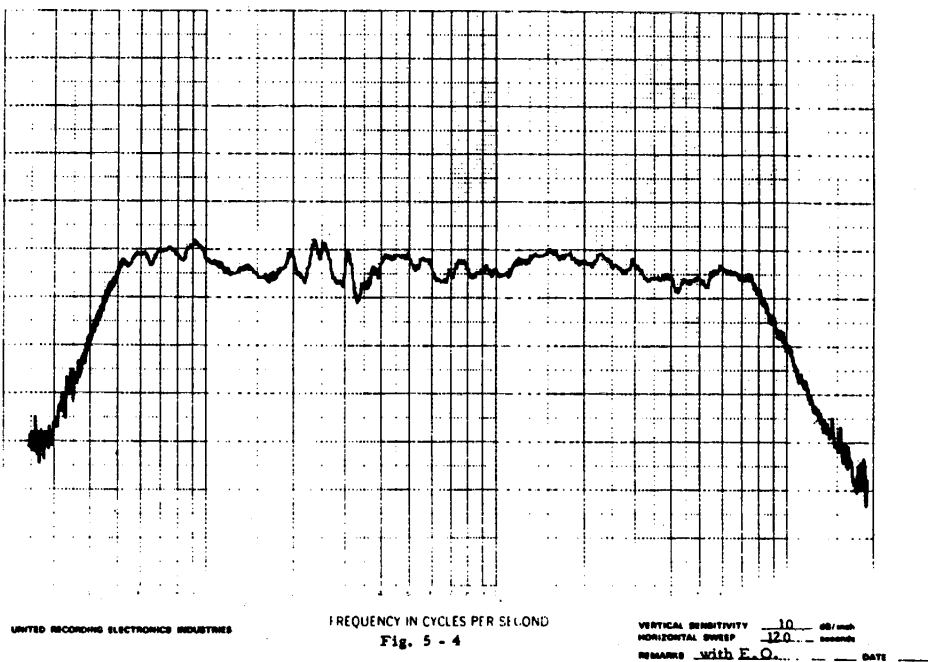

FIGURE 5-4. RESULTING "NEW" HOUSE CURVE OF THE MONITOR SYSTEM IN ITS ENVIRONMENT AFTER THE EQUALIZATION SHOWN IN FIGURE 5-3 WAS INSERTED IN THE SYSTEM. VERTICAL SENSITIVITY = 10 dB/in.

NOTE: All the frequency response graphs shown in this manual were made with the UREI Automatic Response Plotting System, Model 200/2000. The original size, before photographic reduction, displays 6 inches of vertical range.

FIGURE 6. FREQUENCY RANGE OF VARIOUS SOUND SOURCES.

Figure 6-1 through 6-3, appearing on the three following pages, represent good approximations of the frequency response of various sound sources. Fundamental frequencies are indicated by heavy lines, harmonics by lighter lines, and any mechanical noise which extends beyond the upper harmonics is shown by dotted lines. The information used to create these illustrations was obtained from several widely published charts, as cited in Paragraph 3.5.3 of this manual.

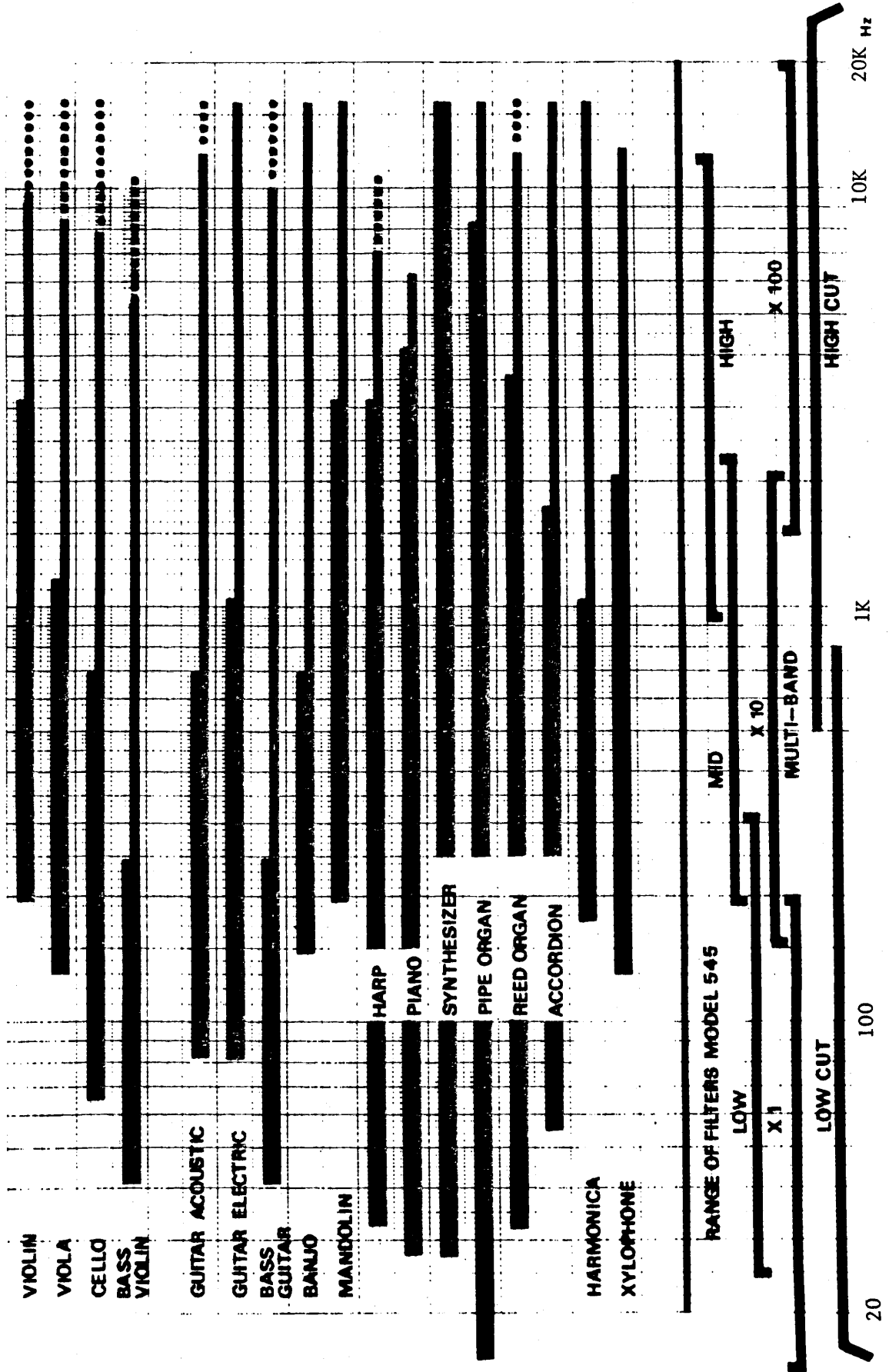

FIG. 6-1 FREQUENCY RANGE OF VARIOUS SOUND SOURCES

STRING INSTRUMENTS  
KEYBOARD INSTRUMENTS

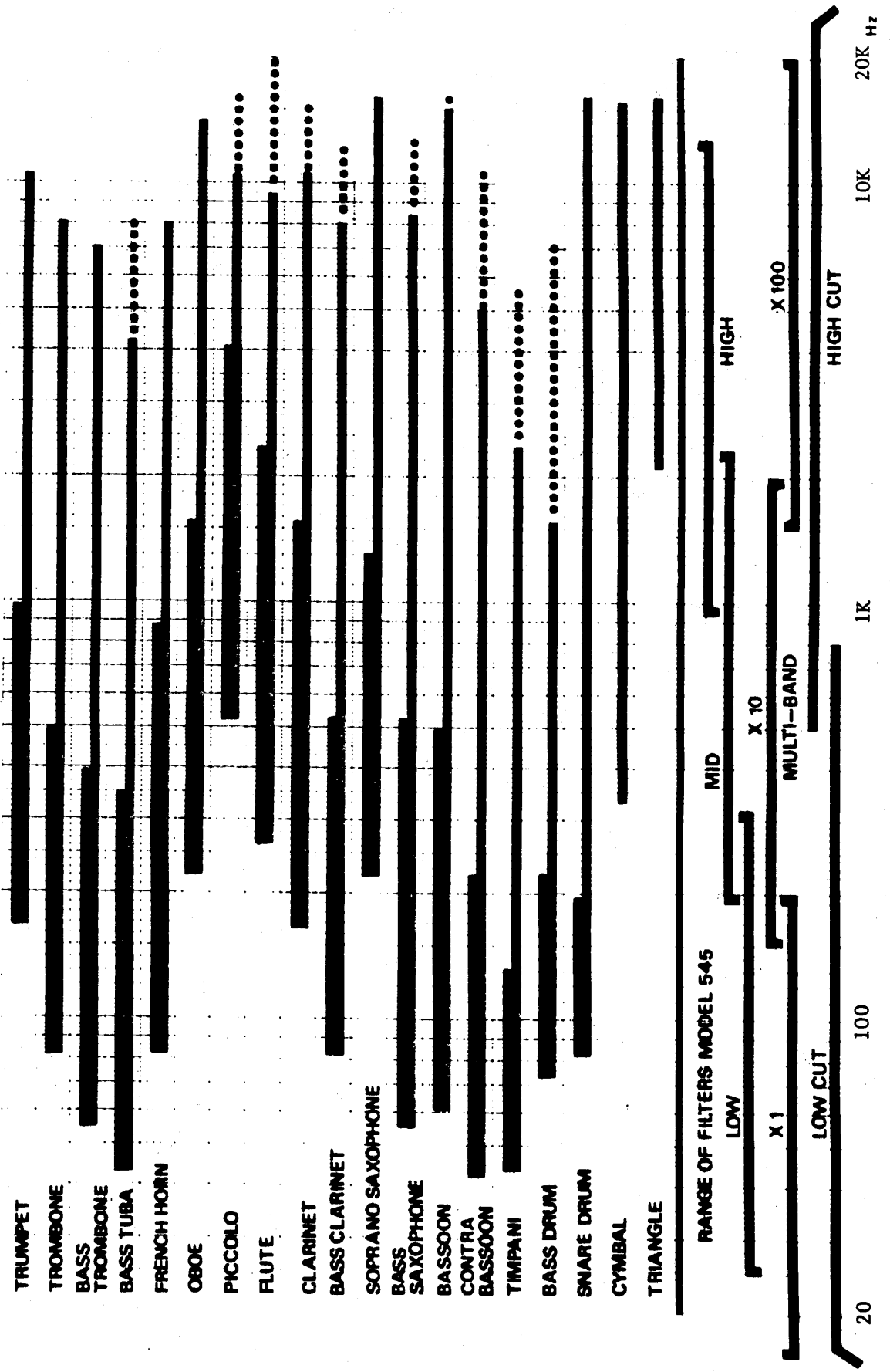
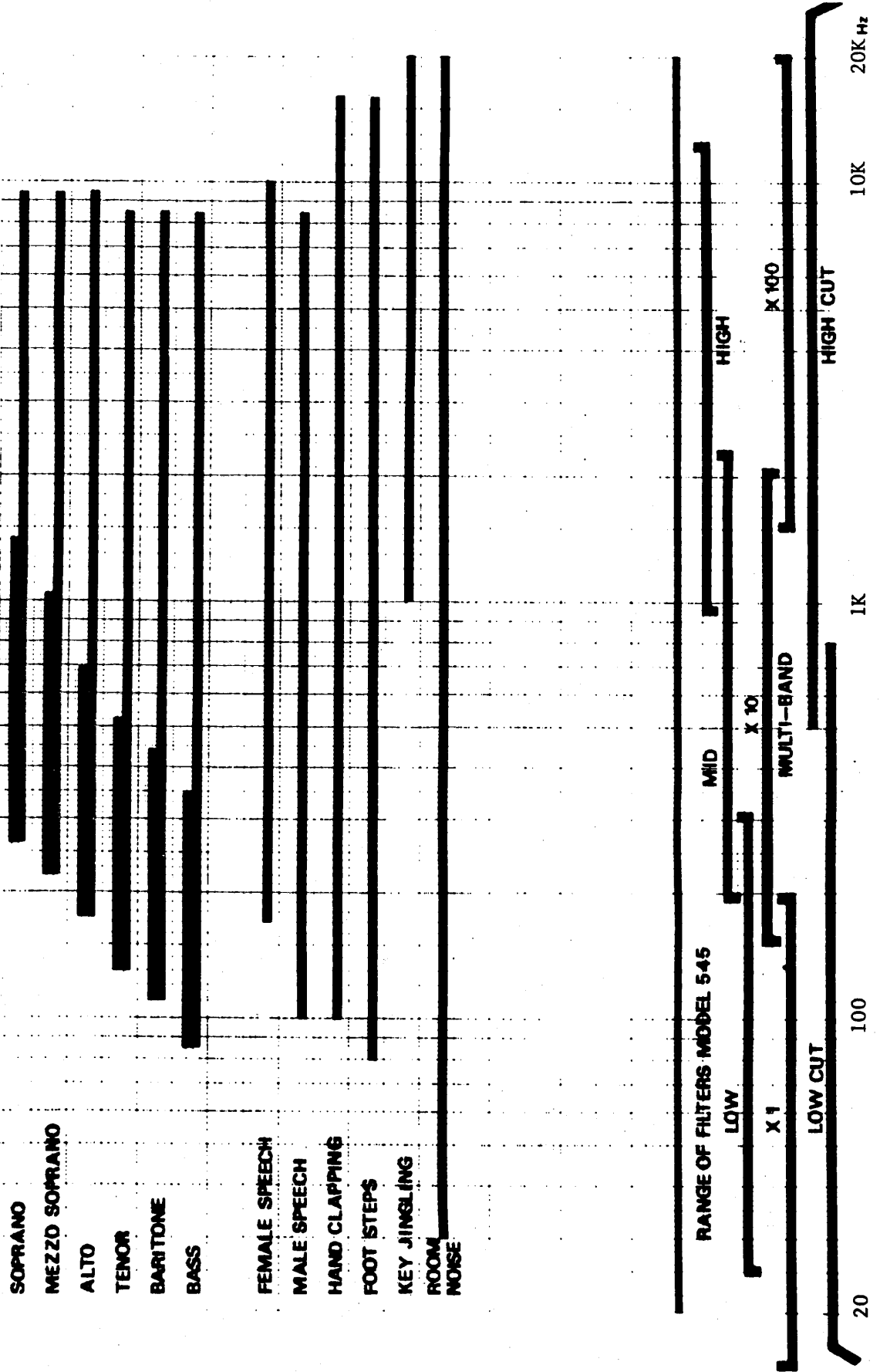

FIG. 6-2 FREQUENCY RANGE OF VARIOUS SOUND SOURCES  
BRASS, WOODWIND INSTRUMENTS  
PERCUSSION INSTRUMENTS



**HUMAN VOICE AND  
TYPICAL NOISE SOURCES**

**FREQUENCY RANGE OF  
VARIOUS SOUND SOURCES**

**FIG 6-3**

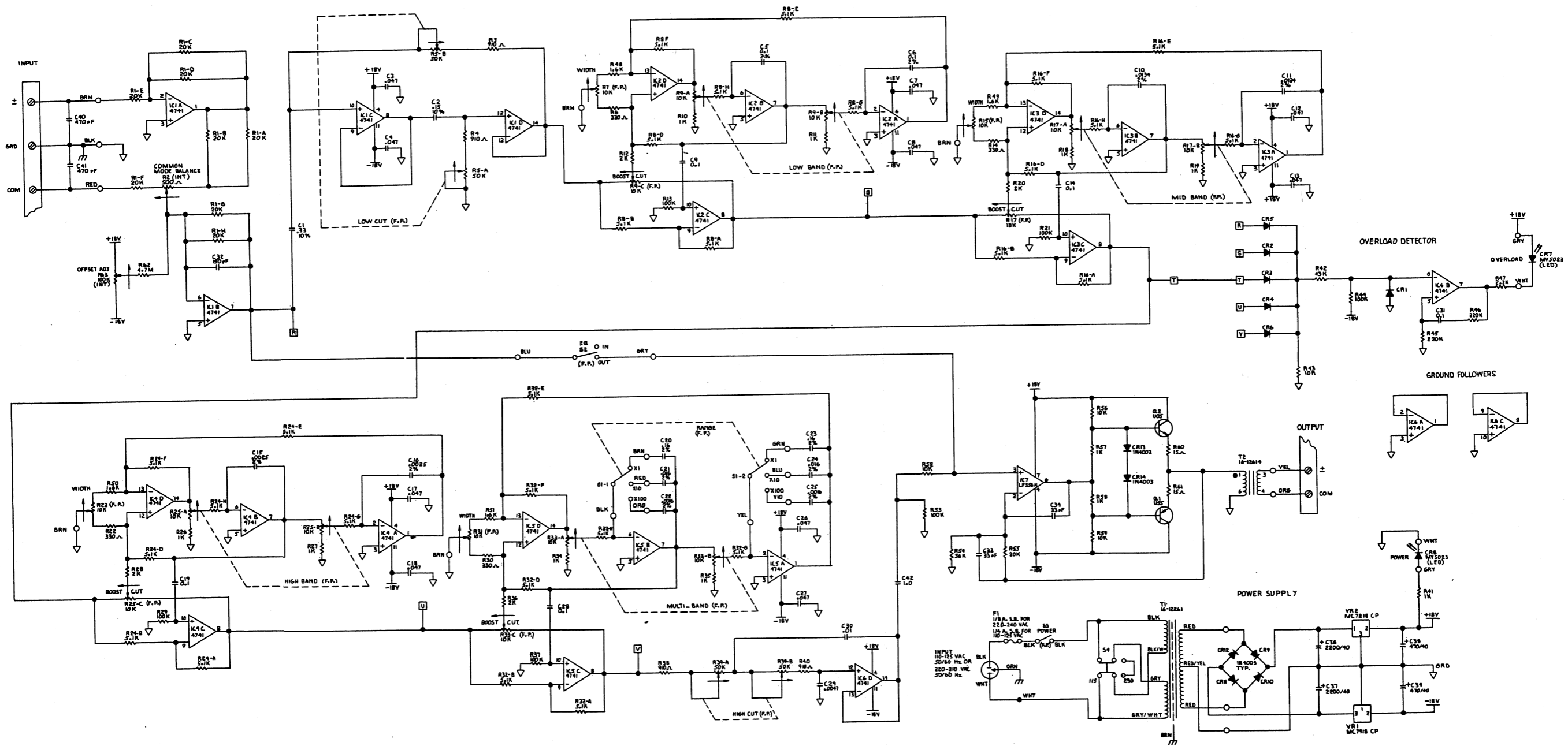

- 6. RESISTOR NETWORK VALUES ARE IN OHMS  $\pm 2\%$ , 1/8W
  - 5. O INDICATES WIRE TERMINATION ON PC BOARD.
  - 4. ALL DIODES ARE VIOLET 5037 (URE1)
  - 3. (F.P.) INDICATES FRONT PANEL CONTROL
  - 2. CAPACITOR VALUES ARE IN MICROFARADS
  - 1. RESISTOR VALUES ARE IN OHMS  $\pm 2\%$ , 1/2W
- NOTES: UNLESS OTHERWISE SPECIFIED

SCHEMATIC PARAMETRIC EQUALIZER		
SIZE R	MODEL NO. 545	DRAWING NO. 12759
DATE: 7/21/77   DR: BY: R.P.M.   SHEET 08		