

---

---

# 6150, 6250, 6300, 6500

---

---

# POWER AMPLIFIERS

---

---

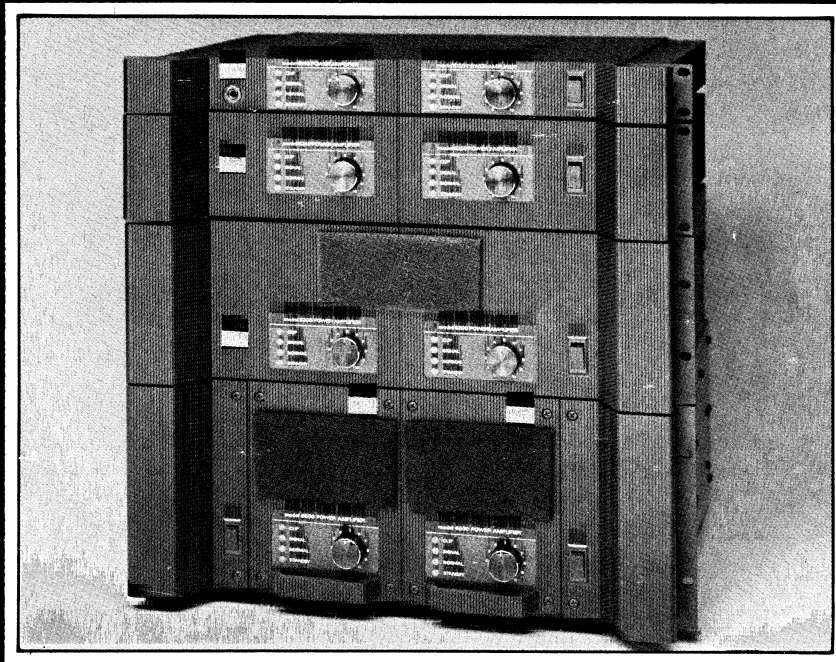

## FEATURES:

---

Active, balanced input circuitry.

Fully complementary output sections.

Standby mode/speaker disconnect protection.

Inputs are balanced bridging XL-type and 6.3 mm (1/4 in) phone jacks (may be operated balanced and unbalanced).

Outputs are heavy duty five-way binding posts. A separate back panel bridge switch is provided for convenient high power mono operation.

Designed for the needs of today's demanding world of professional sound, the UREI power amplifiers are rugged, reliable and conservatively rated. From 80 watts/channel to 275 watts/channel (into 8 ohms), the UREI amplifiers will deliver superb sound in the auditorium, arena and control room.

Each of the UREI amplifiers is designed with the same philosophy. Instead of the common "fix it with feedback" amplifier design approach, UREI engineers have developed an amplifier topology with relatively low loop gain which is highly linear without feedback. Only a small amount of overall negative feedback is used to set the gain and establish the operating point. Frequency compensation in the feedback path and input filtering are calculated to provide an open-loop bandwidth only five



UREI  
ELECTRONIC  
PRODUCTS

times the closed-loop bandwidth. Intra-loop signal overshoots are suppressed, so that problems of transient intermodulation and slew-rate distortion are eliminated.

Most two-channel amplifiers use a common power supply for both channels. The UREI 6250 and 6300 power amplifiers have split power supplies with separate energy storage capacitors to provide better low frequency transient handling and less crosstalk than conventional single-supply designs.

The UREI 6500 has two totally independent power supplies, each with its own massive transformer and energy storage.

Each UREI power amplifier uses multiple 200 watt output transistors in a full complementary configuration for low distortion and high reliability. The rated power of each amplifier at 8 ohms is typically less than 25% of the output devices' dissipation capacity, thus insuring consistently reliable performance under extreme conditions.

All UREI amplifiers are fully protected against short circuits and open circuits, and can handle highly reactive loads with no difficulty. Relay protection guards the loudspeakers from abnormal low frequency transients, power surges or DC offset. A *Standby* indicator LED on the front panel lights when this protection is activated as well as during power-up and power-down muting. Additional front panel LED indicators denote *Normal* operating conditions, *Signal* presence, and *Clip* levels.

Each UREI power amplifier may be easily operated in bridged monaural mode for even higher power in a small space: Bridging is activated by a switch on the rear panel to avoid accidental operation and no internal modifications are required.

All UREI amplifiers have active differential input circuits which offer the noise rejection of input transformers without attendant transformer problems. Each input has two separate connectors: a three conductor 6.3 mm (¼ in) jack which automatically grounds one side of the differential input if a two conductor plug is used, and a three pin XL-type jack.

Speaker outputs are heavy-duty five-way binding posts, spaced 19 mm (¾ in) apart, so that bridged as well as standard connections may be made with standard twin banana plugs, bare wire or terminal lugs.

The Model 6500 features UREI's patented Conductor Compensation, which effectively eliminates the problems originating in loudspeaker wiring by including the speaker leads in the main feedback loop of the amplifier. The result is extremely high damping factor and outstanding transient response at the loudspeaker terminals, not just at the amplifier output.

Conductor Compensation is licensed exclusively to UREI by W. Turner, U.S. Patent #4,236,118.

UREI amplifiers are built for the rigors of touring sound systems. Their solid heat sinks, rigid chassis construction and massive mounting extrusions will keep them operating under the extreme conditions inevitably found in portable reinforcement.

The Model 6500 has two separate amplifier modules, each of which plugs in from the front of the amplifier chassis. In case of field problems, an amplifier module may be exchanged in less than one minute, using only a Phillips-type screwdriver, without removing the amplifier from the rack or even turning off the other channel.

Models 6500 and 6300 are fan cooled, and foam filters are provided on the front panels to keep dust and dirt from interfering with amplifier cooling. Model 6500 has two separate continuously variable speed fans, one for each channel.

# SPECIFICATIONS COMMON TO ALL MODELS

Input:	Balanced bridging differential amplifier.
Input Impedance:	40k ohms, used as balanced input. 20k ohms, used as unbalanced (single ended) input.
Input Sensitivity:	1.1 V for maximum output into 8 ohm load.
Maximum Input Level:	+20 dB (7.75 V rms).
Voltage Gain:	Variable: max. 32 dB (40 times).
Hum and Noise Level:	-100 dB below rated output (15.7 kHz noise bandwidth).
Frequency Response:	+0, -1 dB; 20 Hz to 20 kHz, at any power level up to rated output.
Rise Time:	Less than 7 $\mu$ s.
Slew Rate:	50 V/ $\mu$ s (into 8 ohm load).
Intermodulation Distortion:	Less than 0.05% total, 250 milliwatts + rated output (60 Hz and 7 kHz, 4:1 ratio).
Channel Separation:	>60 dB (input shorted).
Damping Factor:	With 8 ohm load, greater than 200 at any frequency from 20 Hz to 1 kHz, greater than 70 @ 20 kHz.
Power Requirements:	100/120/200/220/240 VAC (strappable), 50/60 Hz.

MODEL	6150	6250	6300	6500
<b>OUTPUT POWER, 20 Hz-20 kHz, PER CHANNEL*:</b>				
8 ohm stereo	80 W	150 W	225 W	275 W (<0.1% THD)
4 ohm stereo	80 W	200 W	380 W	450 W (<0.2% THD)
2 ohm stereo	NA	NA	NA	600 W (<0.5% THD)
8 ohm bridged	150 W	400 W	750 W	900 W (<0.2% THD)
4 ohm bridged	NA	NA	NA	1200 W (<0.5% THD)
<b>OUTPUT POWER AT CLIPPING**</b>				
8 ohm stereo	100 W	175 W	310 W	360 W
4 ohm stereo	110 W	270 W	500 W	580 W
2 ohm stereo	NA	NA	NA	800 W
8 ohm bridged	220 W	540 W	1000 W	1160 W
4 ohm bridged	NA	NA	NA	1600 W
<b>DIMENSIONS</b>	44 x 483 mm (1 3/4 x 19 in)	89 x 483 mm (3 1/2 x 19 in)	133 x 483 mm (5 1/4 x 19 in)	178 x 483 mm (7 x 19 in)
<b>DEPTH behind front panel</b>	356 mm (14 in)	356 mm (14 in)	356 mm (14 in)	406 mm (16 in)
<b>NET WEIGHT</b>	10 kg (22 lb)	16.3 kg (36 lb)	23.6 kg (52 lb)	38.1 kg (84 lb)
<b>SHIPPING WEIGHT</b>	11.8 kg (26 lb)	17.7 kg (39 lb)	27.2 kg (60 lb)	43.1 kg (95 lb)
<b>Connections:</b>	Input through XLR/QG and 1/4" phone jack. Output through 5-way binding posts. Conductor Compensation feedback through BNC connector. Power through 3-wire AC power cord.			
<b>Controls:</b>	Front panel level controls Front panel mains switches Rear-panel MONO/STEREO switch			
<b>Indicators:</b>	"NORMAL" (green LED) = normal, linear operation. "SIGNAL" (green LED) = indicating that signal is present at output terminals. "CLIP" (red LED) = clipping or nonlinear operation. "STANDBY" (red LED) = speakers automatically disconnected or thermal protection activated.			
<b>Finish:</b>	Panel is 4.76 mm (3/16 in) black anodized aluminum. Chassis is matte black painted steel.			

\* Minimum continuous sine wave average power output per channel over a power bandwidth from 20 Hz to 20 kHz. Maximum total harmonic distortion measured at any power level from 250 milliwatts to rated power.

\*\* Output power measured at typical clipping point (1% THD); both channels driven with 1kHz continuous sine wave.

All referenced trademarks are the property of, or licensed by UREI Inc.

BEFORE PROCEEDING WITH COMPLETE UNPACKING AND SETUP,  
CONSULT UNPACKING AND INSPECTION INSTRUCTIONS ON PAGE 5

**model 6150**

**POWER AMPLIFIER**

**SERIAL SUFFIX "A"**



**United Recording Electronics Industries**

8460 SAN FERNANDO ROAD, SUN VALLEY, CALIFORNIA 91352

**(818) 767-1000**

Printed in U.S.A.

© Copyright 1983, UREI

## TABLE OF CONTENTS

	PAGE
<u>SECTION I. INTRODUCTION</u>	
1.1 DESCRIPTION	1
1.2 OUTPUT POWER AND DISTORTION SPECIFICATIONS	2
1.3 ELECTRICAL SPECIFICATIONS	2
1.4 PHYSICAL SPECIFICATIONS	3
1.5 CONTROLS	3
1.6 CONNECTIONS	4
<u>SECTION II. INSPECTION AND INSTALLATION</u>	
2.1 UNPACKING AND INSPECTION	5
2.2 ENVIRONMENTAL CONSIDERATIONS	5
2.3 POWERING	6
2.4 LINE VOLTAGE STRAPPING	6
2.5 EXTERNAL CONNECTIONS	7
2.5.1 INPUT CONNECTIONS, GENERAL	7
2.5.2 INPUT CONNECTIONS, MONO MODE	8
2.5.3 FIVE-WAY BINDING POST OUTPUTS	9
2.5.4 ABOUT OUTPUT POLARITY & BRIDGED MONO CONNECTIONS	9
2.6 IMPEDANCE AND TERMINATION	11
2.7 APPROPRIATELY RATED LOADS	11
2.7.1 IT IS THE USER'S RESPONSIBILITY TO AVOID OVERPOWERING	11
2.7.2 MORE ABOUT LOUDSPEAKER POWER RATINGS	12
2.7.3 SOMETIMES A LARGER AMPLIFIER CAN BE SAFER	13
2.7.4 REMEMBER THE DIVIDING NETWORK	13
2.8 SPEAKER CABLES	14
2.8.1 TYPE OF WIRE	14
2.8.2 DAMPING FACTOR	14
2.8.3 CALCULATING LOSSES IN SPEAKER CABLE	15
<u>SECTION III. OPERATING INSTRUCTIONS</u>	
3.1 GENERAL	16
3.2 TURN ON AND SYSTEM CHECK	16
3.2.1 A NOTE ON AMPLIFIER COOLING	16
3.3 CLIP AND SIGNAL PRESENT INDICATORS	16
3.3.1 CLIPPING INDICATORS	16
3.3.2 ABOUT SENSITIVITY RATINGS	17
3.3.3 SIGNAL PRESENT INDICATORS	17
3.4 MONO OPERATION	18
3.5 LOCKING BUSHINGS	18
<u>SECTION IV. THEORY OF OPERATION</u>	
4.1 INPUT AMPLIFIER	19
4.2 SIGNAL INDICATOR	19
4.3 MONO AMPLIFIER	19
4.4 SUMMING AMPLIFIER	19

TABLE OF CONTENTS  
(Continued)

	PAGE
4.5 VOLTAGE AMPLIFIER	19
4.6 CURRENT AMPLIFIER	20
4.7 OUTPUT PROTECTION	20
4.8 CLIP INDICATOR	20
4.9 RELAY CIRCUIT	20
4.10 POWER SUPPLY	20
<u>SECTION V. MAINTENANCE</u>	
5.1 GENERAL	21
5.2 REPAIRS AND WARRANTY	21
5.3. BIAS ADJUSTMENT	21
<u>SECTION VI. SCHEMATIC DIAGRAM</u>	23

SECTION I  
INTRODUCTION

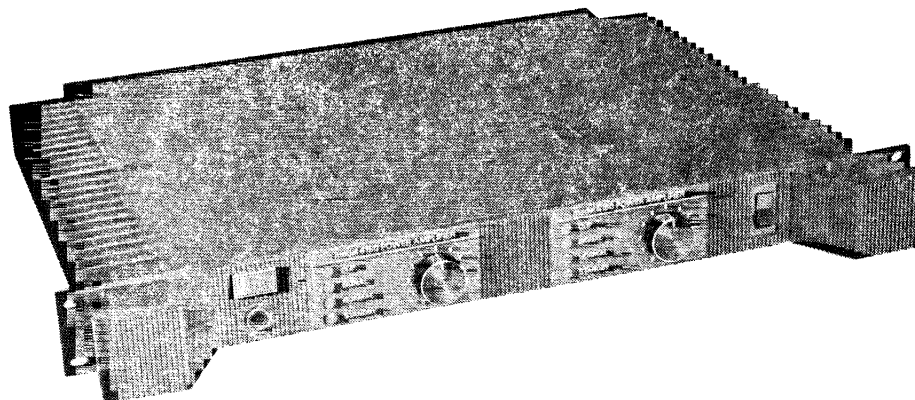

FIGURE 1-1. MODEL 6150 FRONT PANEL.

1.1 DESCRIPTION

The Model 6150 is a two channel professional power amplifier offering significant electronic and mechanical improvements over conventional solid state audio power amplifiers.

In contrast to common "fix it with feedback" amplifier designs, the Model 6150 utilizes only a small amount of negative feedback to set the gain and establish the operating point. Stimulated by W. Marshall Leach's insights (Journal of the AES, issues 7 & 8, 1977) UREI engineers have held open-loop bandwidth to about five times closed-loop bandwidth using frequency compensation in the feedback path combined with input filtering. Without high open loop gain and the requisite large amounts of negative feedback to control it, the Model 6150 avoids heavy lag compensation. In turn, this suppresses intraloop signal overshoots, eliminating transient intermodulation and slew rate distortion. The result, in subjective terms, is that the Model 6150 sounds completely open and natural, regardless of input signal characteristics or output power level.

To avoid interaction between channels, the power supply has an extra-large transformer, designed to handle three times the normal expected load.

Cooling is achieved through efficient convection air flow. The fins of the heat sink assembly are located on both sides of the chassis. The large surface area assures safe operating temperature of the power transistors at full output.

Power output is conservatively rated at 80 watts per channel into 4 ohms. With the flip of a switch, the Model 6150 may be operated as a higher power single-channel amplifier rated at 150 watts into 8 ohms (bridged output). The output transistors are used in a full complementary configuration, each rated at 200 watts. Thus reliability is ensured without resorting to the

kind of overly sophisticated protection circuitry that can adversely affect sound quality. Since the amp is ac coupled, dc appearing at the input cannot damage loudspeakers.

Each channel is provided with a gain control and four LED's, two of which indicate amplifier status and two of which indicate signal level. Inputs are connected to either XLR/QG connectors or three-conductor 6.3 mm (1/4 in) phone jacks. The input circuit is a balanced, bridging differential amplifier, and may be operated with an unbalanced line. Outputs are made via convenient, reliable high-current five-way binding posts. While operation is very straightforward, a thorough understanding of the Model 6150 Power Amplifier can only benefit the user, so careful reading of this manual is recommended.

## 1.2 OUTPUT POWER AND DISTORTION SPECIFICATIONS

STEREO MODE: 80 watts minimum continuous sine wave  
(8 ohm load, average power output with both channels  
each channel) driving 8 ohms over a power bandwidth from  
20 Hz to 20 kHz. The maximum total  
harmonic distortion at any power level  
from 250 milliwatts to 80 watts is  
less than 0.1%.

STEREO MODE: 80 watts minimum continuous sine wave  
(4 ohm load, average power output over a power bandwidth  
each channel) from 20 Hz to 20 kHz. The maximum total  
harmonic distortion at any power level  
from 250 milliwatts to 80 watts is  
less than 0.2%.

MONO MODE: 150 watts minimum continuous sine wave  
(8 ohm load) average power output over a power bandwidth  
from 20 Hz to 20 kHz (MONO switch engaged,  
channel "A" driven, outputs bridged and  
driving an 8 ohm load). The maximum total  
harmonic distortion at any power level  
from 250 milliwatts to 150 watts is less  
than 0.2%.

INTERMODULATION DISTORTION: Less than 0.05% total, 250 milliwatts to  
rated output (60 Hz & 7 kHz, 4:1 ratio).

## 1.3 ELECTRICAL SPECIFICATIONS

INPUT: Balanced, bridging differential amplifier.

INPUT IMPEDANCE: 40 kohms, used as balanced input.  
20 kohms, used as unbalanced  
(single-ended) input.



MAXIMUM INPUT LEVEL: +20 dB (7.75 V; Ref. 0.775.V rms).\*

INPUT SENSITIVITY: 1.1 V for maximum output into 8 ohm load.

VOLTAGE GAIN: Variable; maximum 32 dB (40 times).

FREQUENCY RESPONSE: +0, -1 dB, 20 Hz - 20 kHz.

RISE TIME: Less than 7  $\mu$ s.

SLEW RATE: 50 V/ $\mu$ s (into 8 ohm load).

OUTPUT IMPEDANCE: Designed for any load impedance of 4 ohms or greater.

CHANNEL SEPARATION: 100 dB at 1 kHz, 80 dB at 20 kHz (input shorted).

DAMPING FACTOR: Greater than 500 at any frequency from 20 Hz to 1 kHz; greater than 70 at 20 kHz; with 8 ohm load.

AC POWER REQUIREMENTS: 100, 120, 200, 220, or 240 VAC (strappable), 50 or 60 Hz.

#### 1.4 PHYSICAL SPECIFICATIONS

DIMENSIONS: 483 mm wide x 44.5 mm high rack panel; depth behind panel 381 mm. (19 in x 1-3/4 in x 15 in).

FINISH: Panel is 4.76 mm (3/16 in) black anodized aluminum extrusion. Chassis is matte black painted steel.

WEIGHT: 10 kg (22 lb).

SHIPPING WEIGHT: 11.3 kg (25 lb).

#### 1.5 CONTROLS

INPUT LEVEL: (Each channel) Attenuates the input to the main power stage after the input differential amplifier. From no attenuation to full kill.

---

\*In these specifications, where "dB" refers to a specific level, the 0 dB reference is 0.775 volts rms unless otherwise noted.

---

- POWER: Rocker switch on front panel applies AC voltage to the Model 6150 power supply. Closure of the output relays is automatically delayed for a few seconds. Therefore, any possible turn-on transients cannot reach the speaker terminals.
- MONO MODE: Rear panel slide switch defeats "B" channel input and gain control; an input at the "A" channel XLR/QG or phone jack then drives channel "A" in polarity and channel "B" in reverse polarity (output is bridged across the "hot" terminals of each channel).
- STANDBY LED: (Red) (Each channel) Indicates power is On, but the output is disconnected by the internal relay. This condition exists for a few seconds after normal turn-on, and in the event of thermal overload or dc voltage at the output.
- NORMAL LED: (Green) (Each channel) Indicates power is On, the output relay is actuated (speaker output on) and the amplifier is operating normally.
- SIGNAL LED: (Green) (Each channel) Indicates a signal is applied to the amplifier input. This LED will be illuminated whenever a -5 dB or higher level input signal is present. It is not affected by the Level control.
- CLIP LED: (Red) (Each channel) This LED indicates that the amplifier is being driven into clipping at any stage past the input stage.

## 1.6 CONNECTIONS

All connections for input and output are made on the rear panel. Input to each channel is via a three pin XLR/QG connector and a three-conductor 6.3 mm (1/4 in) phone jack, both of which are wired in parallel. Channel outputs are connected to two pairs of five-way binding posts. The posts are spaced so that a dual banana plug can be inserted in each channel's output, or one dual banana plug can be bridged across the "hot" (red) posts of both channels for mono operation. Power is applied through a three-wire (grounded) cord. (See the Installation Instructions in Section 2.5., and Figures 2-2 through 2-6.)

SECTION II  
INSPECTION AND INSTALLATION

2.1 UNPACKING AND INSPECTION

Your Model 6150 was carefully packed at the factory, and the container was designed to protect the unit from rough handling. Nevertheless, we recommend careful examination of the shipping carton and its contents for any sign of physical damage which could have occurred in transit.

Save the carton and packing in the unlikely event the unit must be returned for service; if you do not have a carton, call the factory for one before shipping the unit. If damage is evident, do not destroy any of the packing material or the carton, and immediately notify the carrier of a possible claim for damage. Shipping claims must be made by the consignee.

The shipment should include:

Model 6150 Two Channel Power Amplifier

UREI Instruction Manual (this book)

Two-part Warranty Card bearing the  
same serial number as the Model 6150.

Rack mounting hardware.

2.2 ENVIRONMENTAL CONSIDERATIONS

The amplifier will operate satisfactorily over a range of ambient temperatures from 0°C to +50°C (+32°F to 122°F), and up to 80% non-condensing relative humidity.

If the amplifier is installed in an equipment rack, adequate ventilation must be provided in order to assure longest component life. The cooling fins of the heat sink assembly protrude to the sides of the amplifier. It is important not to block the convective air flow through the fins, and hot air from the interior of the rack should be vented. Additional heat-producing devices should not be placed directly below the amplifier.

It is normal for the front panel and the handles to become warm during operation since these are part of the heat sinking system of the amplifier.

Furthermore, remember that the Model 6150 is heavy. The rack, especially its mounting rails, should be capable of supporting the amplifier. When a rack is to be transported with a portable sound system, the Model 6150 also should be supported from below; a few pieces of angle iron secured to the sides of the rack will suffice. It is further recommended that the amplifier be placed low in the rack to keep the center of gravity low and thus avoid any tendency for the rack to tip over.

### 2.3 AC POWER

The Model 6150 may be operated from 100, 120, 200, 220, or 240 VAC mains (50 Hz or 60 Hz, single phase). As indicated in Section 2.4, the nominal line voltage may be selected by opening the amplifier and restrapping the power transformer.

#### WARNING

BE SURE TO VERIFY BOTH THE ACTUAL LINE VOLTAGE AND THE STRAPPING OF THE TRANSFORMER BEFORE CONNECTING THE 6150 TO THE MAINS (if necessary, re-strap the transformer). APPLICATION OF EXCESSIVE VOLTAGE TO THE POWER SUPPLY MAY RESULT IN EXTENSIVE DAMAGE WHICH IS NOT COVERED BY THE WARRANTY.

To comply with most electrical codes, the 6150 is supplied with a three-conductor AC power cable, the grounding pin of which is connected to the chassis. In some installations, this may create ground loop problems. Ground loops can result in hum and buzz if a significant potential difference exists between the AC conduit ground and the grounded metal enclosure in which the chassis is installed. If hum is experienced, one may check for the possibility of ground loops by using a three-prong to two-prong AC adapter between the power cord and the mains supply, ungrounding the AC plug temporarily. This ungrounds the Model 6150, and may cure the hum or buzz, but is not a substitute for proper system grounding. Be aware that unless the Model 6150 Two Channel Power Amplifier is AC grounded, a safety hazard can exist. UREI accepts no responsibility for legal actions or for direct, incidental or consequential damages that may result from violation of any electrical codes.

### 2.4 LINE VOLTAGE STRAPPING

Unless a tag on the line cord specifies otherwise, the Model 6150 was shipped ready for operation with nominal 120 VAC power mains. In order to verify or change this for nominal 100, 200, 220, or 240 V (50 Hz or 60 Hz), it will be necessary to remove the cover of the amplifier. The power transformer is then accessible for examination, and, if necessary, restrapping of the leads attached to the primary winding. Use the following procedure:

1. Unplug the power cord. Remove the top cover by removing 11 Phillips head screws and two 1/4-20 hex nuts from the top cover.
2. Re-strap for different line voltages by moving terminals on the terminal board directly to the rear of the power transformer. See Fig. 2-1.
3. Re-install the top cover and change the fuse if necessary. For 100 or 120 VAC use 8 amp, 3AG slo-blo. For 200, 220, 240 VAC use 4 amp, 3AG slo-blo.

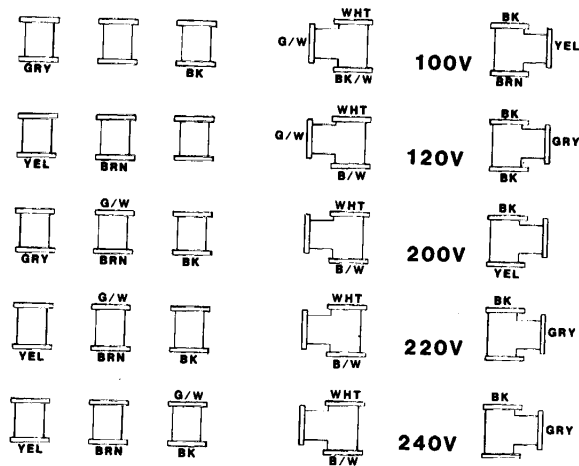

FIGURE 2-1. POWER SUPPLY STRAPPING FOR VARIOUS MAINS VOLTAGES.

## 2.5 EXTERNAL CONNECTIONS

### 2.5.1 INPUT CONNECTIONS, GENERAL

Input signal wires should be shielded cable, and connected in accordance with standard wiring practice to either the three-conductor 6.3mm (1/4 in) phone jacks or the XLR/QG connectors on the back of the chassis.

NOTE: The Model 6150 input connectors are wired as follows:

PHONE JACK	XLR/QG CONNECTOR	MODEL 6150 CONNECTION
Tip	Pin #3	"+" or HIGH
Ring	Pin #2	"Common" or LOW
Sleeve	Pin #1	to audio GROUND

For a given channel, either the XLR/QG connector or the phone jack may be used. Since both of a channel's inputs are wired in parallel, however, only one should be used at a given time (unless it is specifically desired to loop a signal through the amplifier input).

The 6150 will not unbalance floating or balanced input sources since the input circuits consist of balanced differential amplifiers. To use an unbalanced source, wire the signal carrying conductor of the cable from that source to XLR pin three (phone plug tip), and wire the shield to XLR pin one (phone plug sleeve). The unused connector terminal, pin two (ring), should also be connected to shield ground. Unbalanced connections are therefore simplified by using two-conductor standard phone plugs because they automatically short the ring and sleeve together when inserted in the input jacks.

### 2.5.2 INPUT CONNECTIONS, MONO MODE

When operating the Model 6150 as a higher powered single-channel amplifier, only the channel "A" input is used. That signal is applied "in phase" to channel "A", and, with inverted polarity, to channel "B" after that channel's Level control. No signal should be applied to the channel "B" input, and the channel "B" Level control should be turned all the way down (fully counter-clockwise).

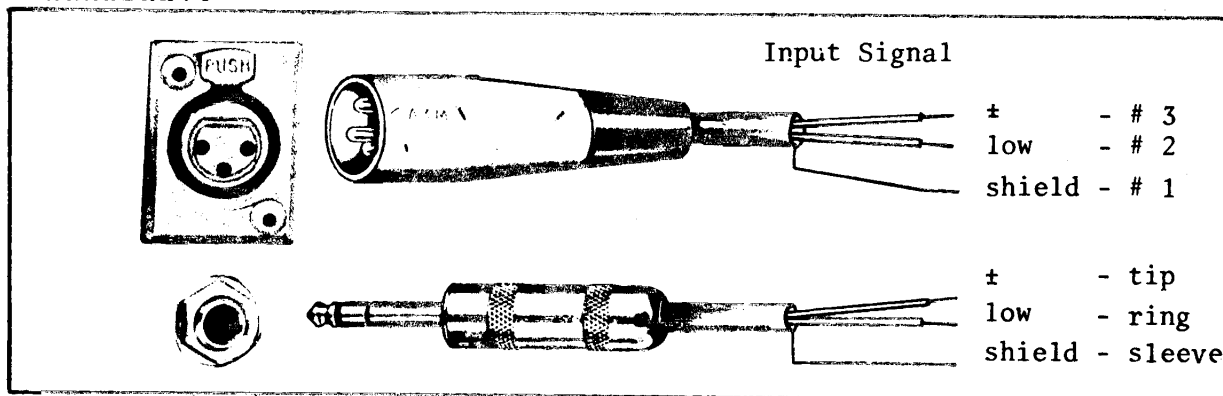

FIGURE 2-2. BALANCED INPUT CONNECTIONS\*

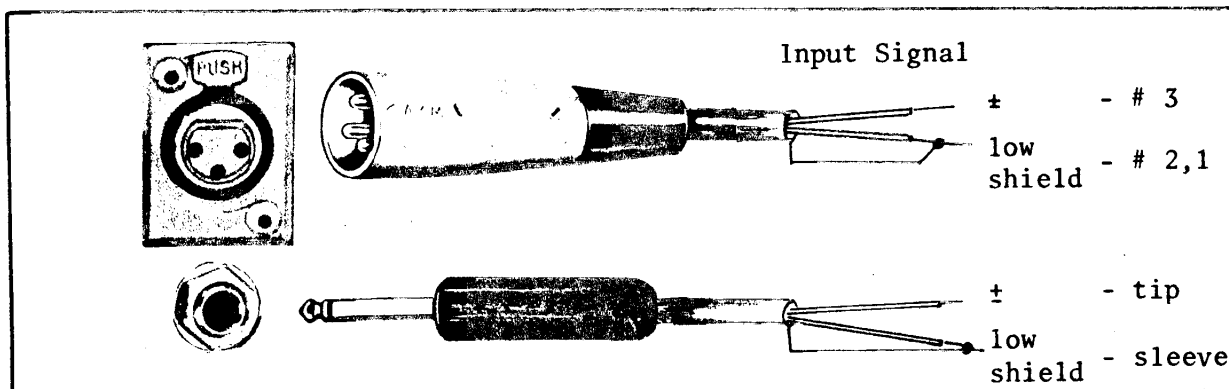

FIGURE 2-3. UNBALANCED INPUT CONNECTIONS\*

\* For a given channel, use either XLR/QG or phone jack, not both. For mono operation, use only channel "A".

### 2.5.3 FIVE-WAY BINDING POST OUTPUTS

Five-way binding post outputs have been chosen because they allow connections to be made quickly, they facilitate polarity reversals for speaker "phasing," and they can handle high current with a greater margin of safety than phone jacks.

The preferred connection method is to use a dual banana plug for each speaker cable. Simply insert each plug into the corresponding channel's red and black binding posts.

In the absence of a dual banana plug (or two single banana plugs), there are other alternatives. To connect stranded speaker cable, loosen the plastic terminal nut, wrap the stripped and twisted wire end clockwise around the terminal, and secure it by tightening the nut.

NOTE: It is preferable to tin the wire ends with solder to prevent unraveling; avoid excess solder as it can promote cable breakage. Smaller speaker cable could be pushed through the hole in the binding post shaft, but we recommend using heavier gauge cables that ought to be wrapped around the shaft.

If a lug is installed on the cable, loosen the terminal nut, push one "leg" of the lug through the hole in the shaft, and tighten the nut.



FIGURE 2-4. USE OF FIVE-WAY BINDING POSTS.

### 2.5.4 ABOUT OUTPUT POLARITY AND BRIDGED MONO CONNECTION

In normal stereo operation (Fig. 2-5), a positive-going signal applied to an input's pin #3 or the phone jack tip will cause a positive-going signal to appear at the corresponding channel's red banana jack output terminal.

In mono operation (Fig. 2-6), the two amplifier channels are driven with the same signal, but with channel "B" reversed in polarity. The speaker cable is then connected to the two channels' red binding posts (the black posts are not used in mono mode). In this case, a positive-going signal applied to the channel "A" input appears as a positive-going signal at the channel "A" red binding post.

NOTE: The two channels' binding posts are clustered to facilitate mono connection across the red posts with a standard dual banana plug. DO NOT CONNECT THE TWO RED BINDING POSTS TO EACH OTHER, and DO NOT GROUND EITHER SIDE OF THE OUTPUT IN BRIDGED MONO MODE.

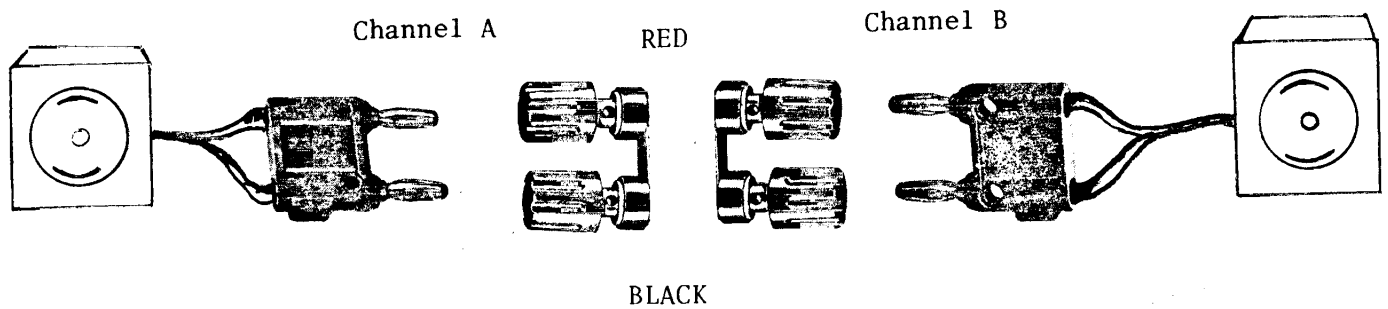

FIGURE 2-5. OUTPUT CONNECTIONS TO 2-CHANNEL SPEAKER SYSTEM.

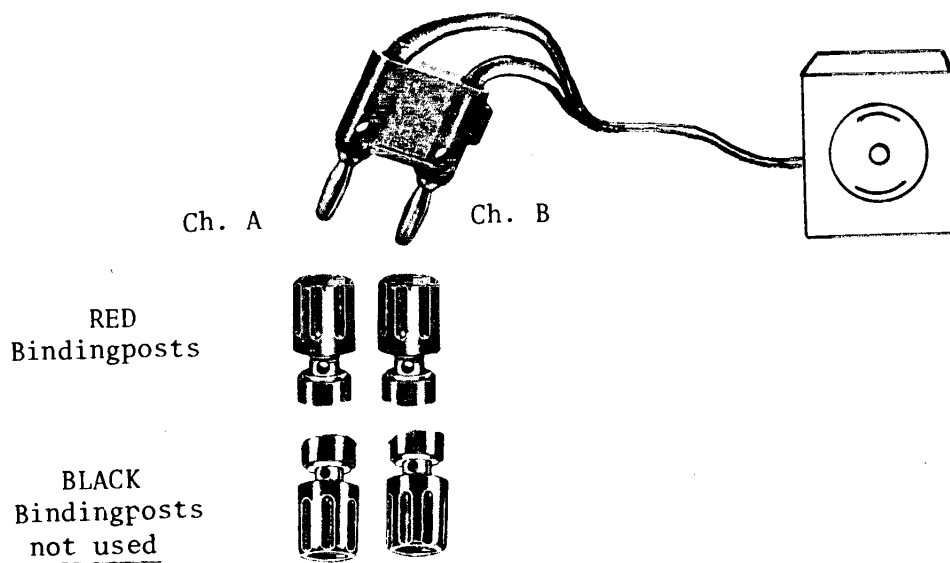

FIGURE 2-6. BRIDGED OUTPUT CONNECTIONS TO MONAURAL SPEAKER SYSTEM.



## 2.6 INPUT IMPEDANCE AND TERMINATION

Audio engineering had its roots in the telephone industry, and "600 ohm circuits" (together with their predecessors, "500 ohm circuits") are carry-overs from telephone transmission practices. Long audio transmission lines, like their video counterparts, must be properly sourced from and terminated in equipment which matches their characteristic impedance if optimum frequency response and noise rejection are to be achieved.

However, transmission line theory and techniques are not only unnecessary but impractical within modern recording studios, broadcast studios and other local audio systems where transmission circuits are seldom more than several hundred feet in length. The advent of negative feedback circuitry and solid-state electronics has spawned modern audio amplifiers and other signal processing devices having source impedances of only a few ohms. They are essentially indifferent to load impedances and, by varying their output current inversely to changes in load impedance, maintain the same output voltage into any load impedance above a rated minimum, with no change in frequency response.

Modern audio systems, therefore, utilize amplifiers and other active devices which have very low output impedances and high (10K to 50K) input impedances. These products may thus be cascaded (operated in series), or many inputs may be connected to a single output of a preceding device, without regard to impedance matching. Switching and patching is simplified because double loads and unterminated bugaboos are essentially eliminated. Floating (ungrounded) transformer outputs minimize ground loop problems, and differential transformerless input circuitry (or input transformers) minimize common mode noise or interference which may be induced into the interconnecting wires or cables.

Where audio must be transmitted through cables or wire pairs of more than several hundred feet in length, however, transmission line termination practices should still be observed.

The Model 6150 has input impedances of 40,000 ohms when used in a balanced, differential input configuration, and 20,000 ohms when used unbalanced (one side grounded). This makes the amplifier suitable for use with any normally encountered source impedance, low or high. Only when the 6150 is used with a source which requires a low impedance termination (such as a 600-ohm transmission line, certain passive equalizers, or older vacuum tube equipment) is a 600 ohm termination resistor required at the 6150 input.

## 2.7 APPROPRIATELY RATED LOADS

### 2.7.1 IT IS THE USER'S RESPONSIBILITY TO AVOID OVERPOWERING

It is essential that the Model 6150 be used with loudspeakers

of suitable impedance that can handle the amplifier's power output. We realize this is not always easy to determine, especially since speaker power ratings have not been standardized. Nonetheless, UREI IS NOT RESPONSIBLE FOR DAMAGE TO LOUDSPEAKERS RESULTING FROM OVERPOWERING. We do recommend protection by inserting appropriate value fuses in the speaker lines. Bear in mind that, in some circumstances, fuses may cause signal distortion, particularly at low frequencies. (Also see Section 2.8 regarding speaker cables.)

### 2.7.2 MORE ABOUT LOUDSPEAKER POWER RATINGS

While there is no cut-and-dried method to establish an appropriate amplifier power for a given speaker system, certain guidelines do exist. If a loudspeaker manufacturer specifies "to be used with amplifiers rated at no more than 'x' watts," then neither speaker nor amplifier warranty is likely to cover damage if a larger amplifier is used. If the amplifier power is only recommended, or if a power rating is given without mentioning the amplifier, then the question as to whether the amplifier is "safe" becomes more difficult to answer.

Loudspeakers usually fail due to one of two factors: thermal or mechanical overload. Thermal overload means overheating, and is almost always caused by applying too high a level of sustained, average power; the voice coil insulation may burn and short circuit, the coil may deform due to the heating and scrape in the gap, and, in some cases, speaker cones have been known to burst into flame. Mechanical overload is another way of describing excessive diaphragm/voice coil travel. A single very high power transient, especially at lower frequencies, can literally tear a loudspeaker apart. Sometimes mechanical overload is more gradual, with the voice coil "bottoming" against the magnetic assembly until it is deformed; a compression driver diaphragm can strike the phase plug and shatter, or the suspension can be over extended and simply tear apart.

The frequency and waveform of a signal have a lot to do with the destructive potential of a given power output. Band limited pink noise is somewhat akin to "average program" power, although the meaning of such a rating depends heavily on crest factor (peak to average noise voltage) and specific frequency limits. Unfiltered or unweighted white noise stresses the tweeters more than the woofers. Swept sine waves may cause less thermal heating, but can cause larger excursions at low frequencies. With compression drivers, the mechanical power handling capability is approximately quadrupled simply by raising the minimum crossover frequency by an octave. If any conclusion can be drawn, it is this:

NO SINGLE POWER RATING REALLY DESCRIBES THE POWER HANDLING CAPABILITY OF ANY LOUDSPEAKER OR LOUDSPEAKER SYSTEM. ALSO, WHEN A LOUDSPEAKER SYSTEM IS MULTI-AMPLIFIED, i.e. A HIGH FREQUENCY DRIVER IS CONNECTED DIRECTLY TO THE POWER AMPLIFIER OUTPUT, A SERIES PROTECTION CAPACITOR IS STRONGLY RECOMMENDED TO REDUCE THE POSSIBILITY OF ACCIDENTAL DAMAGE TO THE DRIVER DIAPHRAGM. CONSULT THE MANUFACTURER OF THE DRIVER AND HORN FOR RECOMMENDATIONS ON PROTECTION CAPACITOR TYPES AND VALUES.

### 2.7.3 SOMETIMES A LARGER AMPLIFIER CAN BE SAFER

If the desired sound level is high enough that it requires a low powered amplifier to be operated at a fairly high distortion level (e.g., well into clipping), it may be safer to use a larger amplifier that will be free of distortion. It is true that in a small amp which is clipping, peak power is restricted by the size of the amplifier's power. However, the average power output rises due to the increased signal density caused by distortion components. Not only does this increase the thermal stress, it also increases mechanical stress because the squared waveforms place greater "G" loads on the moving parts, and abnormally high proportions of high frequency harmonics are generated which can fry the tweeter voice coils.

A more powerful amplifier which is able to generate the desired peak sound level without clipping avoids the large increase in average power (thermal) and the high acceleration (mechanical) stresses caused by the overdriven small amplifier. The major drawback of the larger amplifier is that it can produce higher peak outputs that may instantly destroy a loudspeaker. Therefore, great care must be exercised to ensure that the amplifier will not be driven at too high a level, certainly never at a clip. This can be accomplished either by knowing the program material (if recorded) and setting levels accordingly, or by using peak limiters (with live or unknown program material).

### 2.7.4 REMEMBER THE DIVIDING NETWORK (CROSSOVER)

If the amplifier is connected to a multi-way loudspeaker system that includes a passive, high-level dividing network (crossover), be sure to consider its presence. The network should be rated to handle the amplifier's power. Pre-packaged speaker system power ratings already take the crossover into account.

If you obtain separate components and assemble a system, the chances are that the higher frequency drivers will be rated at less power than the woofer(s). This works out overall because the higher frequency drivers tend to be more efficient (more sound per watt). In fact, higher sensitivity in the high frequency components usually requires some attenuation to be applied in the dividing network (remember, a 3 dB more sensitive driver must be driven with half the power to generate the same sound level).

For example, consider a typical two-way system with a 100 watt woofer and 25 watt high frequency compression driver. The woofer, 1 meter from its enclosure, generates 100 dB SPL with 1 watt at its input, and the compression driver, 1 meter from its horn, generates 106 dB SPL at 1 watt input. If both components are driven by a 100 watt program signal, the compression driver will be 6 dB too loud (four times the level of the woofer). Therefore, the crossover network must provide 6 dB of attenuation for the compression driver, lowering its input power to 25 watts. The

100 watt amplifier turns out to be perfectly suited to driving this system, even though one driver is rated at just 25 watts.

## 2.8 SPEAKER CABLES

### 2.8.1 TYPE OF WIRE

Recently a number of companies have offered various special "speaker cables" which are claimed to vastly improve the signal delivered from amplifier to loudspeaker system. Without going into great details, suffice it to say that some special cables have merit, others may actually be detrimental, and overall the value will have to be determined by the user. In our opinion, just four factors need be considered: DC resistance, wire surface area, capacitive and inductive reactance, and durability. The first three factors combine to produce an impedance at audio frequencies, and the latter factor is important primarily in portable installations.

Generally, the larger the wire gauge, the better. DC resistance is lower with larger wire, and hence more of the amplifier power gets to the loudspeaker (and damping factor is not degraded; see Section 2.8.2). More strands of wire in a given wire gauge are beneficial because they provide a larger surface area. Since AC (audio) travels primarily along the surface (skin effect), this means the effective resistance is lower; more strands also let the cable handle more flexing without fatigue.

Excessive capacitance between the two conductors will cause high frequency rolloff, and excessive inductance will cause low frequency losses; these effects are lessened with heavier insulation or the use of entirely separate wires in a long run (e.g., conduit) rather than a co-insulated pair (e.g., "zip cord"). When selecting a cable, consider the capacitance likely to be present in a two-conductor flat braided configuration or the inductance created by a twisted pair.

### 2.8.2 DAMPING FACTOR

The higher the damping factor of an amplifier, the greater its ability to control unwanted speaker cone movements -- especially at low frequencies. Damping factor is easy to calculate; divide the speaker's rated load impedance by the amplifier's output source impedance. For example, an amplifier with 0.02 ohms output impedance at 1 kHz presents a damping factor of 400 to an 8 ohm speaker ( $8 / 0.02 = 400$ ). To understand how a high damping factor improves sound quality, one must first understand the underlying principles.

When an amplifier drives a woofer, current flowing through the voice coil creates a magnetic field which interacts with the permanent magnetic field in the gap and forces the diaphragm/voice coil assembly to move. Consider what happens when the resting cone is accelerated to a maximum velocity by a signal pulse; the maximum signal builds up, and the voice coil/diaphragm assembly tracks the

current, moving outward proportionately. When the current returns to zero, the suspension and the air mass loading the diaphragm pull it back toward its original resting position, and momentum tends to cause overshoot past that point.

In the absence of an applied signal, the voice coil is moving through a magnetic field, and according to basic physical laws it generates a current opposite to that of the original driving signal. This current induces a voltage or "back EMF" at the amplifier's output terminals.

The back EMF travels through the amplifier's output source impedance to ground. The lower that impedance, the better the "braking" action on the voice coil; a direct short across the coil (zero ohms) would allow minimal overshoot. Low impedance equals high damping factor, so the benefits of high damping factor become obvious -- tighter control of the loudspeaker.

The theoretical damping factor of an amplifier may not be realized at the speaker because speaker cables always have a finite resistance or impedance; the back EMF must also travel through the cable, so the damping becomes less. Hence, larger gauge cables not only reduce signal losses, they improve performance by affecting damping factor less than smaller gauge cables.

### 2.8.3 CALCULATING LOSSES IN SPEAKER CABLE

The chart in Figure 2-7 may be consulted to establish the approximate power loss (and damping factor degradation) for various wire gauges. The chart assumes stranded cable, but since skin effect and reactive effects will vary, these numbers can only be considered as rough guides.

WIRE DIAM. (mm)	A.W.G. WIRE GAUGE	DC RESISTANCE PER 30 m (100 ft) OF TWO-CONDUCTOR CABLE (OHMS)	CABLE LENGTH WHICH WILL PRODUCE A ONE dB POWER LOSS (21% LESS POWER TO SPEAKER)			
			@ FOUR ohms		@ EIGHT ohms	
			meters	feet	meters	feet
4.115	6	0.08	366	1200	740	2425
3.264	8	0.13	244	800	488	1600
2.588	10	0.20	145	475	290	950
2.05	12	0.32	91	300	183	600
1.63	14	0.52	58	190	114	375
1.29	16	0.82	37	120	73	240
1.02	18	1.32	23	75	46	150
0.813	20	2.08	15	50	30	100
0.643	22	3.30	9	30	18	60

FIGURE 2-7. POWER LOSSES IN SPEAKER CABLES

SECTION III  
OPERATING INSTRUCTIONS

3.1 GENERAL

The 6150 power amplifier should be installed and connected to both the signal source and the loudspeaker system according to Section II. Set the Level controls to minimum. Then, after the preceding equipment is turned on to provide a stable input signal, the power amplifier may be turned on.

NOTE: IT IS CONSIDERED A SAFE OPERATING PRACTICE ALWAYS TO TURN THE POWER AMPLIFIER ON LAST, AND TURN IT OFF FIRST. THIS PREVENTS ANY POSSIBLE TURN-ON/TURN-OFF TRANSIENTS OR EXCESS LEVELS THAT MIGHT BE GENERATED IN THE LINE LEVEL SIGNAL PROCESSING EQUIPMENT FROM REACHING THE LOUDSPEAKERS.

3.2 TURN ON AND SYSTEM CHECK

Apply program material, and be ready to monitor the speaker output. Turn on the POWER switch, and observe the indicator LEDs. Initially, the STANDBY LEDs may turn on for a few seconds. While the SIGNAL LEDs should be illuminated, no sound will be audible (regardless of Level control setting) because the protection relays have not yet connected the output stage to the five-way binding posts.

After a few seconds, the relays will actuate as the STANDBY LEDs turn off and the NORMAL LEDs turn on. At this point, bring up the Level controls until a suitable listening level is reached.

3.2.1 A NOTE ON AMPLIFIER COOLING

Although the need for adequate cooling of the amplifier was briefly discussed under Section II, 2.2, it is necessary to describe the cooling system in more detail.

The amplifier will get hot when operated over a period of time at high output levels. Under normal conditions, the amplifier does not overheat. However, if a fault exists or if the ventilation is not sufficient, the temperature may rise to a point which could cause damage to individual components. The protection circuit then opens the output relays until safe operating temperature is reestablished. If thermal cycling should occur, check whether cooling air flow over the amplifier heat sinks is insufficient or the heated air cannot be vented away from the amplifier.

3.3 CLIP AND SIGNAL PRESENT INDICATORS

3.3.1 CLIPPING INDICATORS

The Model 6150 differential input amplifiers are of sufficient sensitivity to be driven to full output by any medium or high line level source; an input of +3 dB (1.1 Vrms) will produce

maximum rated output into 8 ohms. Due to an attenuator (the Level control) which comes after the input stage, signal levels up to a maximum of +20 dB (7.75 V rms) can be accommodated without overload.

The channel's front panel CLIP LED will turn on whenever signals exceed the clipping level at the output stage, enabling the operator to take appropriate action. This LED will remain on long enough to be seen even if the excess signal is only a brief transient. To avoid audible distortion, when the LED indicator flashes more than occasionally, either lower the level of the source feeding the amplifier or turn down the amplifier's Level control.

Overload conditions are monitored separately for each channel. However, they are not monitored in the input differential amplifiers. Since a +3 dB signal is adequate to drive the amplifier to full output and the input stages will handle up to +20 dB without clipping, there is little likelihood of clipping in this stage; it is only possible when the amplifier's Level control is set at #2 or lower. The symptom of such input overdrive is audible distortion without any indication from the CLIP LED. In such cases, simply lower the signal level at the source and use a higher number on the amplifier's Level control.

### 3.3.2 ABOUT SENSITIVITY RATINGS

With regard to sensitivity ratings, power amplifiers are unique. Other audio signal processing and mixing equipment sensitivity describes the average input/output level, whereas a power amplifier's sensitivity describes the input signal required to obtain maximum power output. Therefore, if a mixer, equalizer, or other device is rated at +4 dB nominal output, that average level could continuously overdrive the power amplifier. This is why a level control is provided on the amplifier. By turning down the level at the amplifier, input sensitivity is effectively reduced to match the source so that only peaks drive the amplifier to full output. With a mixer, equalizer, etc. rated at -10 dB to -15 dB nominal output, little or no attenuation is required in the power amplifier.

### 3.3.3 SIGNAL PRESENT INDICATORS

Sensors in each input stage turn on the SIGNAL LED when an input signal is present at or above -5 dB in level.

NOTE: If no output at all is audible when the amplifier level is turned up, the SIGNAL LED is on, and the NORMAL LED is on, look for a broken or disconnected cable or a failed loudspeaker. A short circuit, too low an impedance due to paralleled speakers, or an overheated amplifier will cause the STANDBY LED to turn on; if NORMAL and SIGNAL LEDS are on and the cable/speaker system checks out, the amplifier may have failed.

### 3.4 MONO OPERATION

When operating the Model 6150 as a monaural power amplifier (bridged output), the rear panel Stereo-Mono switch must be in Mono position, and the speaker system must be wired as shown in Figure 2-6. Use only the channel "A" input and input Level control; the channel "B" level control has no effect. If the amplifier is operating normally, the channel "A" and "B" indicator LEDs should function identically except for the channel "B" SIGNAL LED, which will not turn on.

### 3.5 LOCKING BUSHINGS

The Model 6150 is equipped with locking bushings on the channel Level controls. This allows the amplifier levels to be set at the time of installation, and discourages unauthorized persons from tampering with the settings. To lock a particular gain structure:

- 1) Remove the front panel knobs, first loosening the set screws on the side of the knob.
- 2) Set the levels as desired.
- 3) Tighten the hex bushing on the Level control shafts using a 3/8 in. nut driver.
- 4) The knobs may now be re-installed at your option. However, when the locking bushings are tightened, the knobs' SET SCREWS SHOULD JUST BARELY BE TIGHTENED. Any attempt to turn a well secured knob on a locked bushing will change the level setting and/or score the shaft (which ruins it).



## SECTION IV THEORY OF OPERATION

NOTE: In the following descriptions, the component designation for Channel A is used. Additional information regarding Channel B is contained in the schematic diagram in Section VI.

### 4.1 INPUT AMPLIFIER

A low noise IC, IC1-A and IC1-B, is configured as a differential input amplifier of unity gain (max input +20 dB). It thereby accepts a balanced or unbalanced input source.

An attenuator type level control follows the input amp, providing unity gain to full attenuation. The mid point of control rotation corresponds to 6 dB of attenuation.

### 4.2 SIGNAL INDICATOR

IC4-B is an integrating rectifier with a gain of 20. Whenever a signal over -5 dB is present at the input to the level control, the rectifier turns on LED DS4, the SIGNAL indicator.

### 4.3 MONO AMPLIFIER

IC4-A is a unity gain inverting amplifier used only in Mono mode. It also differentially references the grounds for the two channels. The input to IC4-A is derived after the CH A input level control. When the Mono switch is engaged, the inverter's output drives CH B after its level control, so the speaker outputs are identical but reversed in polarity.

### 4.4 SUMMING AMPLIFIER

The summing amplifier, IC2-B, has a gain of 10. It combines a filtered signal from the input level control with frequency compensated negative feedback from the power amplifier output. IC2-B's output drives the forward gain section of the amplifier. The nominal amount of the feedback is 1/40 (-32 dB).

### 4.5 VOLTAGE AMPLIFIER

The voltage amp consists of Q3 through Q7, and is driven by the summing amplifier output. The stage has a gain of 50, set by local negative feedback, keeping THD low and optimizing linearity.

Q7 is controlled by R36, a trimmer control on the circuit board, and sets the bias of the output stage for Class AB operation.

#### 4.6 CURRENT AMPLIFIER

Comprised of Q11, Q12, and Q15 through Q18, this section has an overall voltage gain of 1. Q11 and Q12 provide the initial current gain necessary to drive the main output transistors from the voltage amplifier's output. Output transistors Q15 through Q18 then provide the high current gain necessary to drive rated loads.

#### 4.7 OUTPUT PROTECTION

Transistors Q13 and Q14 sense output current in the load, examining two time duration ranges matched to the safe operating area (SOA) of the output devices. If the SOA is exceeded, signal to the pre-drivers (Q11 and Q12) is reduced.

Transistors Q27 and Q28 sense overcurrent in the voltage amplifier stage; if overload occurs they protect the voltage amplifier.

#### 4.8 CLIP INDICATOR

Comprised of IC2-C and CLIP indicator DS1, this stage senses the summing amplifier output. LED DS1 is turned On when the feedback loop goes non-linear, which occurs at about 3 dB below hard clipping. The LED current is subject to a time constant so that short duration non-linearities will be visible to the operator.

#### 4.9 RELAY CIRCUIT

Normally the relay K1 is closed and completes the signal path from the output of the power amplifier to the output binding posts. If IC2-D senses a dc voltage at the amplifier output or the thermistor R52 measures a temperature in excess of +85°C on the heat sink, the base drive to Q8 is turned off and the relay opens. The relay amplifier also supplies the current to turn on the green NORMAL LED, DS3, or the red STANDBY LED, DS2.

#### 4.10 POWER SUPPLY

There are two independent secondaries on the power transformer, providing the high voltage for each channel. The secondaries are magnetically coupled to a shared primary so current demand on one channel does not "steal" current available to the other channel. There is a single low voltage winding for the ±15 VDC regulators which provides power for the low level circuitry on both channels. The transformer primary is fused, and is strappable for various AC line voltages (refer to Section 2.4).

SECTION V  
MAINTENANCE

5.1 GENERAL

The Model 6150 is an all solid-state unit, ruggedly constructed with only the highest quality components. As such, it should provide years of trouble free use with normal care. All parts used are conservatively rated for their application, and workmanship meets the rigid standards you have learned to expect in UREI products.

NO SPECIAL PREVENTIVE MAINTENANCE IS REQUIRED.

5.2 REPAIRS AND WARRANTY

This product is factory warranted to the original purchaser against defects in material and workmanship for one year after initial purchase. This limited warranty must be activated at the time of purchase by returning the registry portion of the Warranty Card to the factory. Should a malfunction ever occur, the dealer from whom the unit was purchased will be glad to handle return for factory repair. Please call or write to the factory for a Return Authorization Number which must accompany all repairs. For prompt service, ship the unit prepaid directly to the factory with the RA Number visible on the shipping label. Use the original factory carton; if necessary, call the factory to secure a new carton at a nominal charge. The amplifier is heavy, and shipping to the factory is at the customer's risk; do not take a chance with inadequate packing materials. Tape a note to the top of the unit describing the malfunction, and instructions for return. We will pay one-way return shipping costs on any in-warranty repair.

Because of specially selected components in this product, field repairs are not authorized during the warranty period, and attempts to perform repairs may invalidate the warranty.

Even if your unit is out of warranty, we recommend that you return it to the factory for repairs. Our experienced personnel, supported by special test equipment, will be able to find and eliminate any problem in the most efficient way.

WARNING: The full AC line voltage is present at several points inside the chassis. Be careful to avoid personal shock if you remove the covers.

5.3. BIAS ADJUSTMENT

These trimmers have been carefully set at the factory and should not require adjustments except after service work.

CAUTION: Only qualified service technicians should attempt this adjustment.

- 1) Before turning the amplifier on, set the bias control potentiometer (R36) on the channel which has been repaired to full counterclockwise (CCW) position (when viewed from the plastic knob side of the trimmer).
- 2) Connect the amplifier to an 8-ohm load and apply a 2 kHz sine wave to the input at a level just below clipping. Continue this condition for about ten minutes.
- 3) Disconnect the input to the amplifier (no signal).
- 4) Connect a digital voltmeter across R69 or R78, and adjust the bias pot (R36) for exactly 7 mV (0.007 V DC) across this resistor.
- 5) Repeat this procedure for the other channel if it has been serviced.

SECTION VI  
SCHEMATIC DIAGRAM

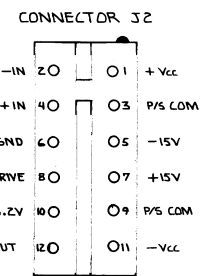
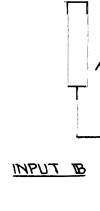
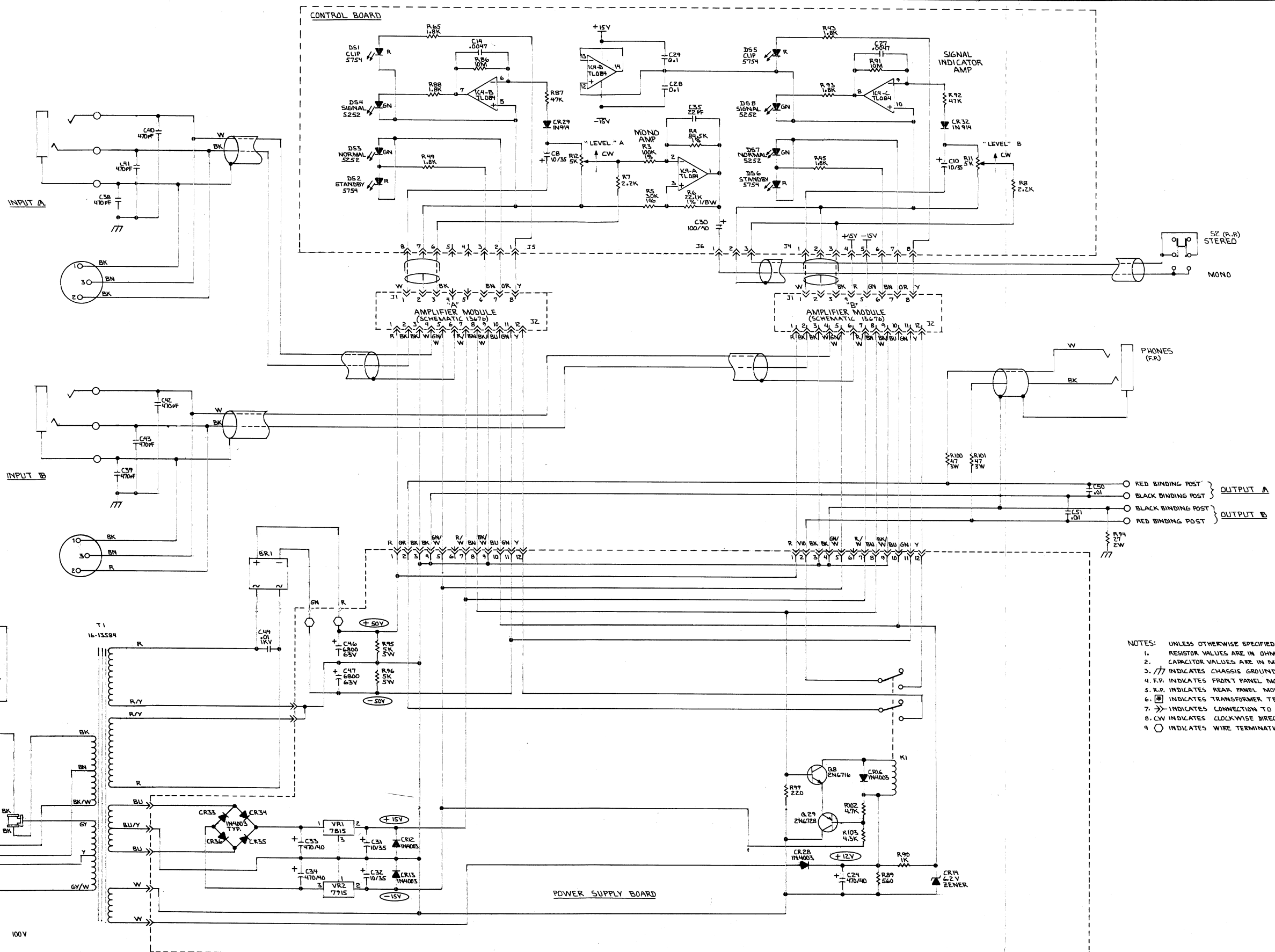

POWER TRANSFORMER SHOWN CONNECTED FOR NOMINAL 120V AC LINE. ALTERNATE CONNECTIONS SHOWN FOR 100, 200, 220, AND 240V AC MAINS. INSTRUCTIONS IN MANUAL DETAIL PROCEDURE FOR CHANGING STRAPPING.  
 FUSE IS 4A 5.0, 3AG FOR 100, 120V CONNECTIONS. CHANGE TO 2A 5.0, 3AG FOR 200, 220, 240V CONNECTIONS.

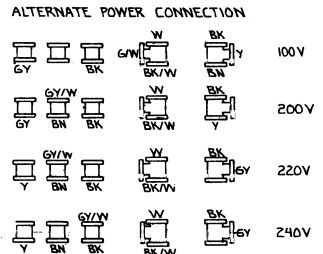

- NOTES: UNLESS OTHERWISE SPECIFIED.
1. RESISTOR VALUES ARE IN OHMS ± 5% 1/2W.
  2. CAPACITOR VALUES ARE IN MICROFARADS.
  3. // INDICATES CHASSIS GROUND.
  4. F.P. INDICATES FRONT PANEL MOUNT.
  5. R.P. INDICATES REAR PANEL MOUNT.
  6. [Symbol] INDICATES TRANSFORMER TERMINALS.
  7. → INDICATES CONNECTION TO CIRCUIT BOARD.
  8. CW INDICATES CLOCKWISE DIRECTION.
  9. ○ INDICATES WIRE TERMINATION ON P.C. BOARD.

EFFECTIVE SERIAL NUMBER SUFFIX A

SCHEMATIC (MAINFRAME)		
SIZE	MODEL	DRAWING NO.
R	6150	13684B
DATE	9-24-81	DR. BY: R. T. MARRIN

REV. B PER ELD-6150-023 R.P.M. 7-20-82  
 REV. A PER ELD-6150-020 R.P.M. 6-3-82

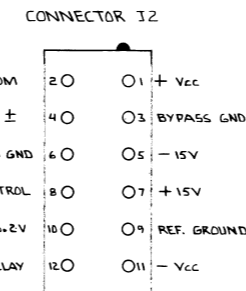
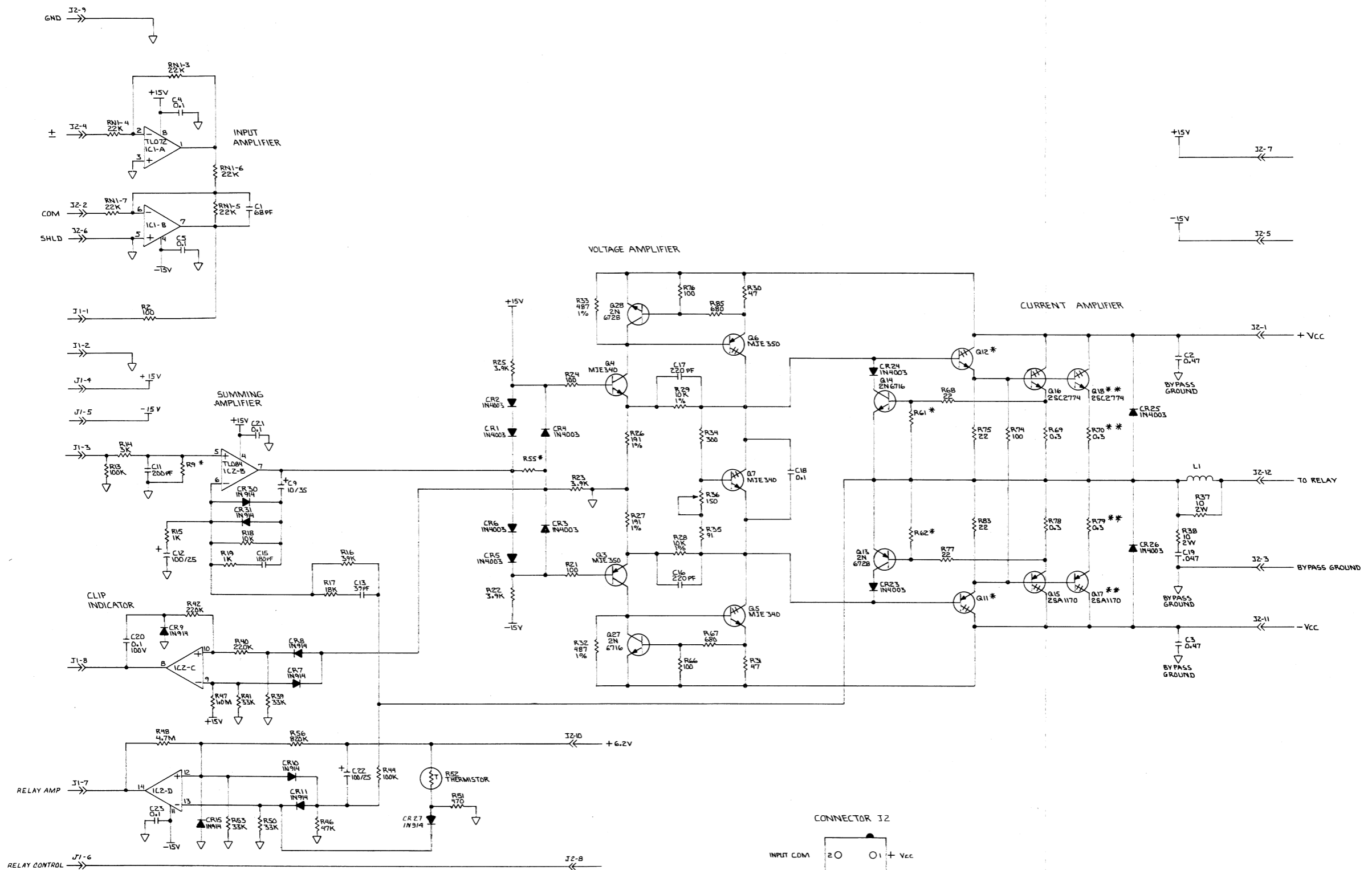

**COMPONENT VALUES TABLE**

* R	MODEL 6150	MODEL 6250
R9	9.1K	36K
R55	10K	18K
R61	9.1Ω	10Ω
R62	9.1Ω	10Ω
Q11	TIP 42 C	MJE15031
Q12	TIP 41 C	MJE15030

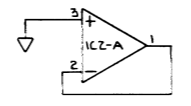

6. \* \* COMPONENTS ARE OMITTED ON 6150 AMPLIFIER BOARD  
 5. \* COMPONENT VALUES ACCORDING TO TABLE →  
 4. ↓ INDICATES CIRCUIT GROUND,  
 3. → INDICATES P.C. BOARD CONNECTOR,  
 2. CAPACITOR VALUES ARE IN MICROFARADS.  
 1. RESISTOR VALUES ARE IN OHMS ± 5% 1/2W.
- NOTES: UNLESS OTHERWISE SPECIFIED.

**SCHEMATIC AMPLIFIER BOARD**

SIZE	MODEL	DRAWING NO.
R	6150	13679 B
	6250	

REV. B PER ECO 6250-026 MRM 4-5-84  
 REV. A PER ECO 6150-023 & 6250-021 7-30-82 DATE 10-4-83 DR. BY M.R. MARTIN