

# TIME ALIGNED™ STUDIO MONITOR SYSTEM

™ Licensed by E. M. Long Associates

MODEL  
813

## FEATURES:

- First TIME ALIGNED™ monitor system designed for the professional studio.
- Features UREI 800 series TATM network (patent pending).
- 6048G duplex with UREI custom H.F. horn for extended and more uniform H.F. response.
- Second L.F. 15" direct radiating driver fed from 3-way TA network for extended L.F. response and higher power handling capability at low frequencies.
- >11.5 cu. ft. enclosure with pressure control aperture for excellent L.F. damping, good efficiency and low distortion.
- Unique enclosure damping method provides high efficiency conversion of low frequency sound pressure to adiabatic energy.

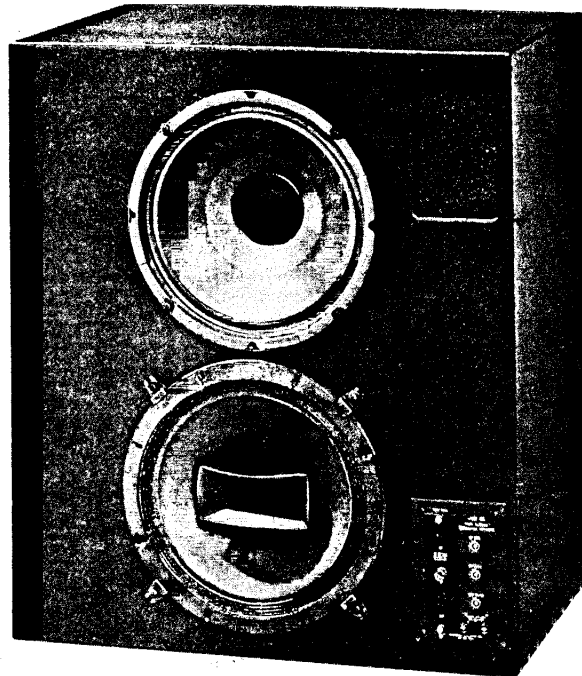

The 813 Studio Monitor System is the first generation product of a joint R & D effort of UREI and E.M. Long Associates. The TIME-ALIGN™ TECHNIQUE is a real-time design method, utilizing proprietary instrumentation developed by Long which allows the driver placements and network parameters to be adjusted simultaneously, achieving near perfect alignment of the frequency components of a complex transient waveform as heard by a listener.

The importance of time (phase) parameters of loudspeaker systems, in addition to smooth frequency response, has been postulated for many years. These group time delay anomalies may be severe in some multi transducer systems, although they may exhibit satisfactory or even excellent frequency response.

Within the last decade, many advocates have presented outstanding scientific papers on this subject. Richard C. Heyser, among others, has contributed magnificent re-

search dealing with the importance of time (phase) correlation.

Quoting from Heyser in Audio, June 1976: "We realize that the concept of time response of a speaker is a whole new ballgame to many people and is probably a bit confusing if all you ever considered before was steady state frequency measurements."

Edward M. Long presented a paper before the Audio Engineering Society in May of 1976, entitled "A Time Align Technique for Loudspeaker System Design." UREI is a licensee of E. M. Long Associates, for the instrumentation methods and the use of the Trademark ™.

For stereo applications the model 813 Studio Monitor System is built in "mirror-image" (813 L, 813 R) to produce identical dispersion towards the listening position between two systems. The series 800 TA networks\* with the 800H custom H. F. horn, are also available separately in two way and three way configuration for both the 6048G and the 604E. (\*Patent Pending).



**UNITED RECORDING ELECTRONICS INDUSTRIES**

8460 SAN FERNANDO RD., SUN VALLEY, CALIFORNIA 91352  
TELEX 65-1389 UREI SNVY

(213) 767-1000



MODEL  
813

The excellent transient behavior of the 813 system compared to two other popular networks and systems designed for the 604 series duplex speakers is graphically demonstrated below. (Crossover controls adjusted per manufacturers' instructions for best frequency response.)

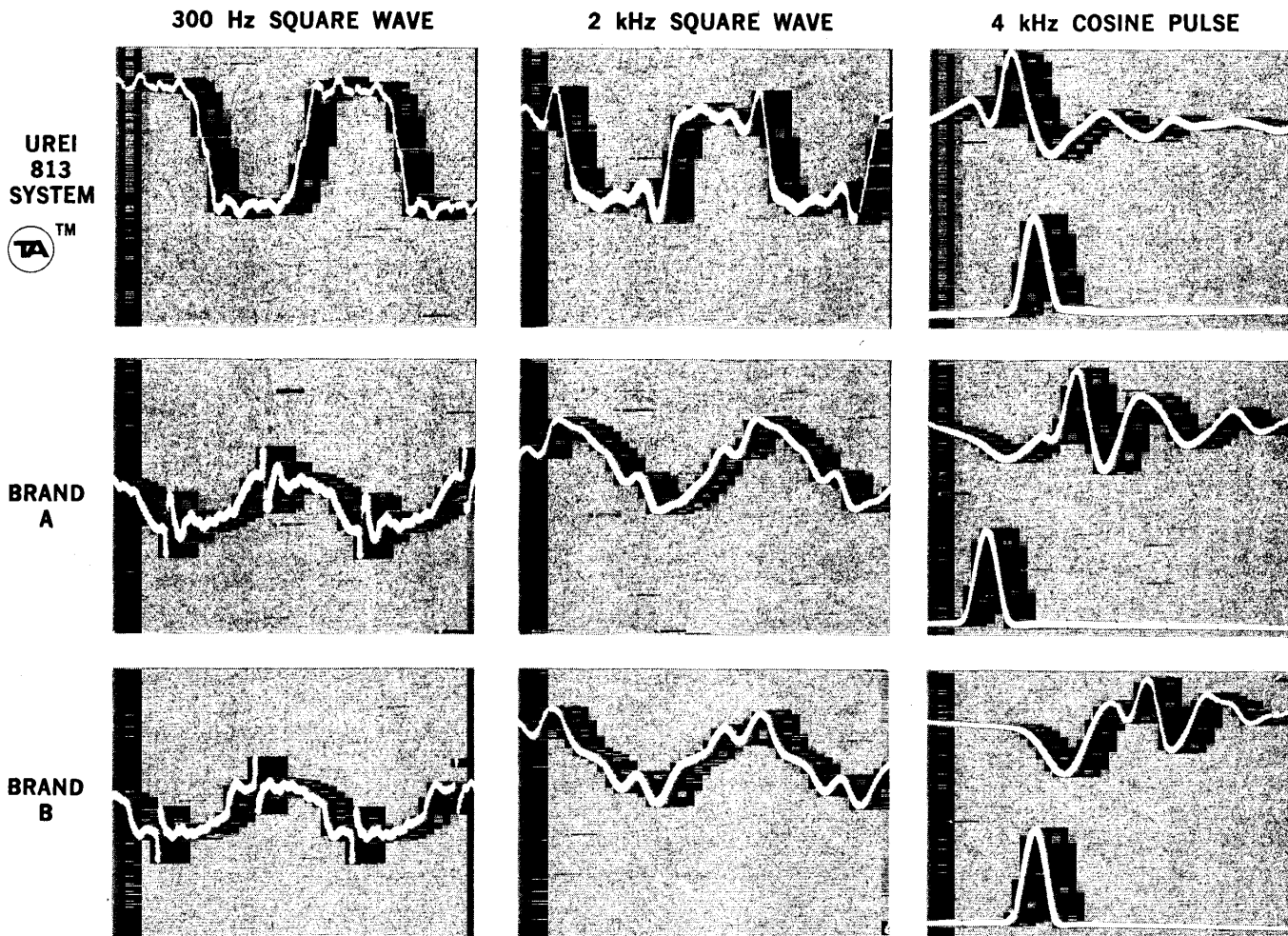

## SPECIFICATIONS:

**Type:** Dual woofer coaxial with Model 838 three way TA network

**Power Rating:** 75 watts 40 Hz to 20 kHz, with pink noise

**Frequency response:**  $\pm 3$ dB, 40 Hz to 15 kHz measured "freespace"  
 $4 \pi$  steradians (H=5 m D=1 m)

**Sensitivity:** 89 dB SPL/volt/meter

**Impedance:** 8 ohms, nominal (minimum impedance > 4 ohms)

**Network:** UREI 838, 3-way

**Cabinet:** Utility flat black painted

**Weight:** 79.2 kg (176 pounds)

**Dimensions:** H = 0.914 m (36")

W = 0.787 m (31")

D = 0.584 m (23") without grille  
 0.622 m (24.5") with grille

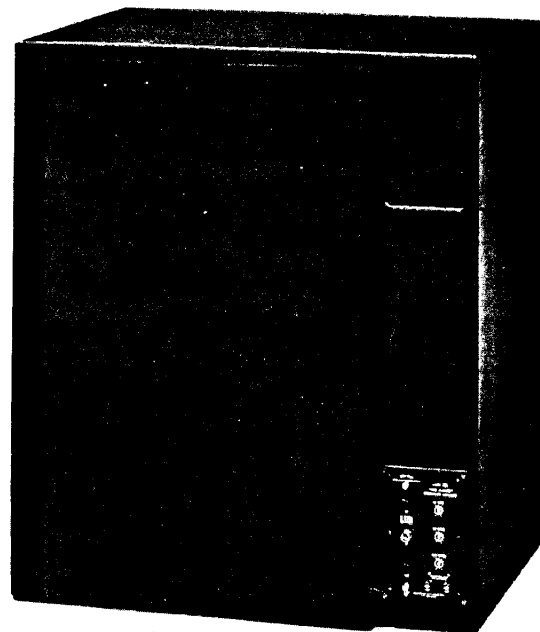

**UREI 813 SYSTEM  
 WITH ACCESSORY GRILLE**

BEFORE PROCEEDING WITH COMPLETE UNPACKING AND SETUP,  
CONSULT UNPACKING AND INSPECTION INSTRUCTIONS ON PAGE

INSTALLATION AND OPERATING INSTRUCTIONS

MODEL 838

TIME ALIGNED <sup>TM</sup> 3-WAY CROSSOVER NETWORK FOR 604-8G



**United Recording Electronics Industries**

8460 SAN FERNANDO ROAD, SUN VALLEY, CALIFORNIA 91352

(213) 767-1000

Printed in U.S.A.

## INTRODUCTION

The Model 838 Crossover Network is designed for use in professional sound monitoring installations. In order to maintain time-alignment when incorporated in a studio monitor system, it is essential that this network be used only with an Altec Model 604-8G Duplex Loudspeaker and a UREI Model 800W auxiliary L.F. driver. The high-frequency section of the network is designed for use with modified 604-8G loudspeakers which incorporate the UREI model 800H custom H.F. Horn. For optimum high-frequency response, the stock Altec horn must be replaced with a UREI 800H.

The 800 series components are designed to be used in a "quasi-closed box" enclosure such as that incorporated in the UREI Model 813 Time-Aligned <sup>TM</sup> Studio Monitor System. In such an enclosure, typical 4 pi steradian "free space" frequency response (measured at a distance of 1 meter at a height of 5 meters above the ground) is shown in Figure 1, curve A. The increase in response below 150 Hz to be expected when such a system is coupled into a control room is shown in curve B, which is the unequalized response measured with a UREI Sonipulse in a commercial recording studio control room, (with the system mounted in a quarter-space configuration). References which may be helpful to the user in determining the optimum installation configuration are listed at the end of this instruction data.

## AMPLIFIER INTERFACE

The Model 838 Crossover, when properly connected to the loudspeaker components listed in the INTRODUCTION paragraphs, presents its minimum load impedance (4 ohms) at 125 Hz. Some amplifiers with transformer outputs offer a selection of output impedances. We recommend to connect the 838 System to the "4 ohm" output. It has been found that certain of the new solid state amplifiers employing power field-effect transistors (FET's) are quite critical of load impedance at high power-output levels. To protect these expensive power transistors from damage, fairly sophisticated protective systems are usually included in the amplifier, sometimes resulting in a highly objectionable "cycling" or oscillating of the protective cut-out circuitry when overload occurs. This phenomenon was not encountered with a UREI Model 813 Monitor System except when operating at extremely high monitoring levels.

## MODEL 838 CONTROL PANEL

Model 838 contains mid-range, high frequency drive, and high frequency trim controls. The operating range of these controls is shown in Figure 2, curves C,D, and E, when used with the specified loudspeaker components in an enclosure such as that used in the UREI model 813 Studio Monitor System. The 838 control panel contains current limiting incandescent lamps and the low and high frequency drivers are fused separately:

	<u>LAMP TYPE</u>	<u>FUSE TYPE</u>
800 W L.L.F. Woofer	#1723 or #1133	7 amp 3AG
604-8G L.F. Woofer	#1133	
604-8G H.F. Driver	#81	1 amp 3AG

The current limiting lamps are selected to indicate excessive current peaks which occur near the system overload conditions. The passive Time-Align™ delay and crossover network is connected by a multi-conductor cable to a terminal strip at the rear of the control box. Correct connection of the cable to the control box is assured by aligning the red dot on the cable-connector fanning strip alongside the dot on the back of the control box. The light panel cover may be conveniently removed for the replacement of the incandescent lamps.

NOTE: When operating the 838 Crossover network it must always be loaded properly. If the system is driven with high signal levels while a speaker is disconnected, (or a voice coil is open), voltages may be developed which exceed the ratings of the capacitors in the network. The warranty is void if the network is operated unloaded.

The following is a schedule of the color code for the connecting wires to the individual speakers:

<u>WIRE COLOR FROM CONTROL PANEL</u>	<u>TERMINALS AT SPEAKER</u>
Black	604-8G H.F. Black
Red	604-8G H.F. Red
White	604-8G L.F. Black
Green	604-8G L.F. Red
Brown	800 W No mark
Yellow	800 W Purple dot

References:

1. "Determination of Loudspeaker Signal Arrival Times" by Richard C. Heyser, Parts I and II, October and November 1971 Journal of the Audio Engineering Society.
2. "Geometry of Sound Perception" by Richard C. Heyser, Technical Paper at May 1975 AES Convention.
3. "A Time-Align Technique for Loudspeaker System Design" by Edward M. Long, Technical Paper at May 1976 AES Convention.
4. Elements of Acoustical Engineering by Harry F. Olson, Chapter I "Standing Waves' in Rooms" by Michael Rettinger, Recording Engineer Producer, December 1976



UNIFORM SYSTEM ANALYSIS  
 MODEL 813 TIME ALIGNED™ MONITOR SYSTEM  
 MODEL 838 TIME ALIGNED™ 3-WAY CROSSOVER NETWORK

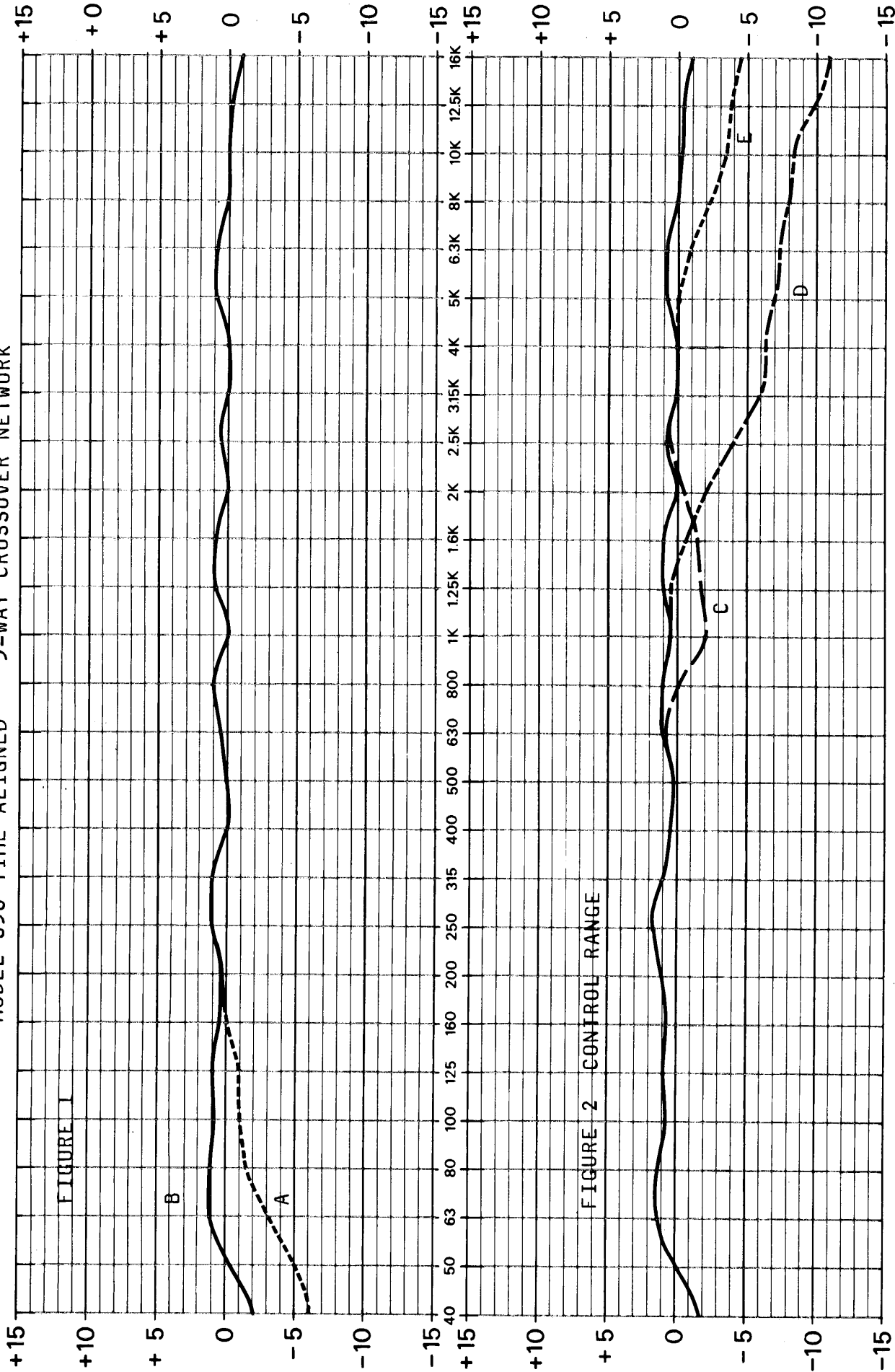

FREQUENCY IN CYCLES PER SECOND

United Recording Electronics Industries  
 8460 SAN FERNANDO RD., SUN VALLEY,  
 CALIFORNIA 91352 (213) 767-0000

REMARKS  
 Figure 1: A = 4 pi steradian (free space) response,

B = typical response in a control room (unequalized).

Figure 2: Control range of; C = Mid range, D = High frequ. drive, E = High frequ. trim.

REVISIONS			
ZONE	LETTER	DESCRIPTION	DATE
	A	CHANGE PER ELD 0538-005	12-15-77
	B	CHANGE PER ELD 838-005	7-18-77
	C	CHANGE PER ELD 0538-006	1-19-77

NETWORK BOX ASSY 12822

CONTROL BOX ASSY 12821

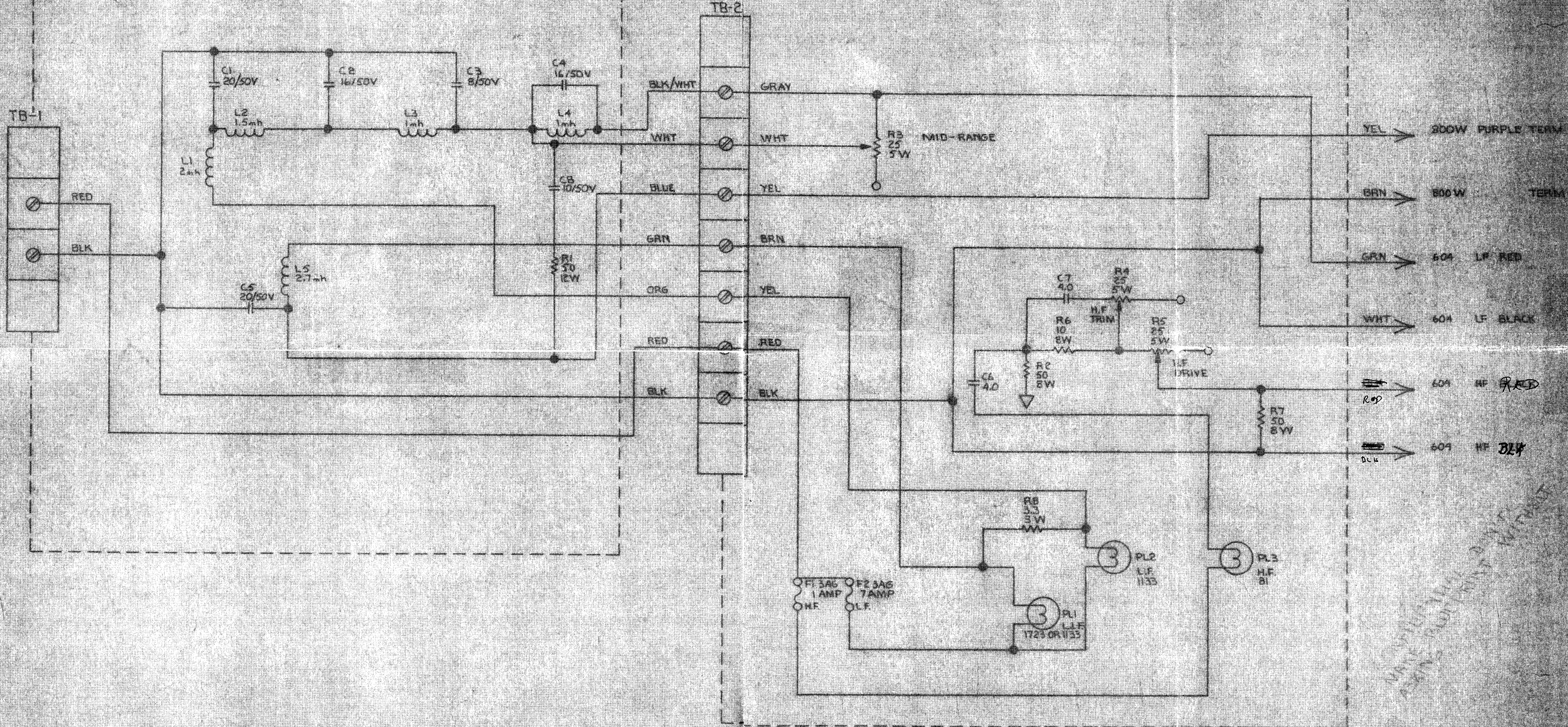

- 3. ARROW ON POTENTIOMETER INDICATES CLOCKWISE DIRECTION
  - 2. CAPACITOR VALUES ARE IN MICROFARADS
  - 1. RESISTOR VALUES ARE IN OHMS ± 5%
- NOTES: UNLESS OTHERWISE SPECIFIED

UNLESS OTHERWISE SPECIFIED DIMENSIONS ARE IN INCHES TOLERANCES ARE: FRACTIONS DECIMALS ANGLES XX .XX .XX		CONTRACT NO.	DATE
APPROVALS		DATE	
DRAWN R.P.M.		11-1-77	
CHECKED			
MATERIAL			
FINISH			
PART ASSY			
PART NO.			

**SCHEMATIC**

REV	DESCRIPTION	DRAWING NO.
D	838	12819C

ALL DIMENSIONS UNLESS OTHERWISE SPECIFIED  
 ARE IN INCHES