

TASCAM

D01236020C

US-2x2

US-4x4

USB Audio/MIDI Interface



REFERENCE MANUAL

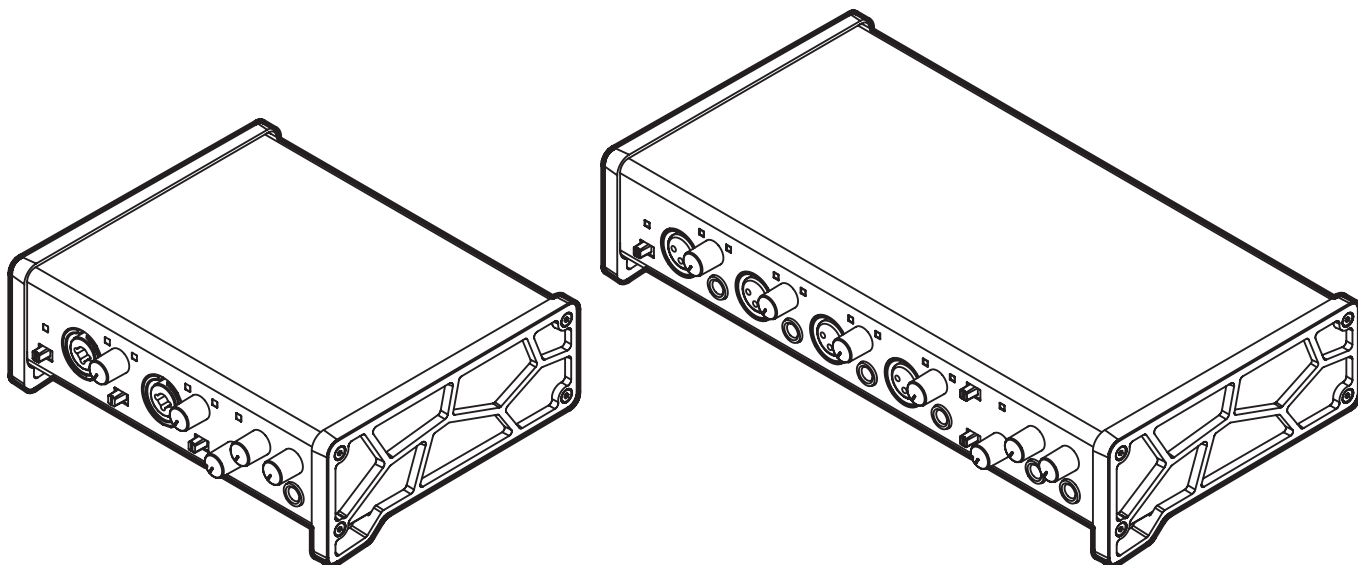

Before connecting this unit to a computer, you must download and install dedicated software on the computer.

Contents

1 – Introduction	3	SONAR LE and Ableton Live Lite	16
Features	3	Other DAW software.....	16
Conventions used in this manual	3	Windows Media Player	16
Using the TEAC Global Site	3	Mac OS X and iTunes.....	17
2 – Names and functions of parts	4	9 – MIDI Implementation Chart	18
Front panel	4	10 – Troubleshooting	19
Rear panel.....	5	11 – Specifications	21
3 – Installation	6	Audio resolution.....	21
System requirements.....	6	Analog inputs.....	21
Windows	6	Analog outputs.....	21
Mac OS X	6	Control input/output ratings.....	21
Apple iOS devices	6	Audio performance.....	21
Supported audio drivers	6	Computer system requirements.....	22
Installing the dedicated software	6	Windows	22
Installing the dedicated driver for Windows	6	Mac OS X	22
Installing the Mac OS X Settings Panel	7	iOS devices	22
Working with Gatekeeper.....	8	Supported audio drivers	22
Uninstalling the dedicated software.....	9	General.....	22
Uninstalling the dedicated driver for Windows ..	9	Dimensional drawings.....	22
Installing the Mac OS X Settings Panel	9		
4 – Preparation.....	10		
Connecting the power	10		
Changing the outlet plug (US-4x4 only)	10		
5 – Connections.....	11		
Connecting other equipment	11		
Computer connections	11		
Audio connections.....	11		
Microphones	11		
Guitar.....	11		
Electronic instruments and other audio equipment.....	11		
Analog record players	11		
Monitor speakers	12		
Headphones	12		
MIDI connections	12		
Connecting with iOS devices.....	12		
6 – Using the Settings Panel	13		
Opening the Settings Panel	13		
Settings Panel screen.....	13		
7 – Standalone Mode.....	15		
Overview	15		
Settings in standalone mode.....	15		
Settings Panel settings	15		
8 – Application Guide	16		
DAW software.....	16		

Features

- 24-bit/96kHz audio interface
- Multiple¹ analog signals (L/R) can be input simultaneously and output to a computer by USB at the same time
- Multiple XLR mic inputs (balanced²) and standard phone jack inputs (balanced³/unbalanced⁴)
- Electric guitars and basses, for example, can be connected to the standard phone jack inputs when the **MIC/LINE INST** switch is set to **INST** (instrument input)⁵
- Balanced stereo line⁶ and headphone⁷ outputs
- MIDI IN and OUT connectors
- Direct monitoring function allows input monitoring with low latency
- USB port (USB-B type, USB 2.0 standard)
Use the included USB cable to connect the unit to a computer. To connect to an iOS device, use a Lightning to USB Camera Adapter made by Apple Inc.

CAUTION

When using a US-2x2 that is connected to a computer, it will operate using USB bus power.

However, the power supply will be insufficient when using the unit connected to an iOS device by USB, so you will need to purchase a separate AC adapter designed for use with this unit (TASCAM PS-P520, DC5V). (When using a US-4x4, always connect the included AC adapter.)

- A driver is included for use with Windows computers, and a Settings panel application is included for use with Macs
- DAW software included (SONAR LE, Ableton Live Lite)
SONAR LE only supports Windows computers.
Ableton Live Lite supports both Windows and Mac computers

¹US-2x2: 2 inputs, US-4x4: 4 inputs

²XLR-3-31 equivalent

US-2x2: 2 inputs, US-4x4: 4 inputs
The US-2x2 has XLR/TRS combo jacks

³Standard 6.3mm (1/4") TRS stereo jack
(MIC/LINE INST switch set to MIC/LINE)

US-2x2: 2 inputs, US-4x4: 4 inputs

⁴Standard 6.3mm (1/4") TRS stereo jack
(**MIC/LINE INST** switch set to **INST**)

US-2x2/US-4x4: both 2 inputs

⁵Only **IN1-IN2** on the US-4x4

⁶Standard 6.3mm (1/4") TRS stereo jack
US-2x2: 2 outputs, US-4x4: 4 outputs

⁷Standard 6.3mm (1/4") stereo jack
US-2x2: 1 output, US-4x4: 2 outputs

■ Note about computer operation

If you are unsure about anything related to the basic operation of a computer when it is mentioned in an explanation in this manual, please refer to the computer operation manual.

To use this unit with a computer, dedicated software must be installed on the computer.

For details about software installation, see "Installing the dedicated software" on page 6.

Conventions used in this manual

The following conventions are used in this manual.

- Buttons, connectors and other physical parts of this unit are written using a bold font like this: **PHONES** knob.
- Information shown on the computer display is written like this "OK".
- Additional information is provided as necessary as tips, notes and cautions.

TIP

These are tips about how to use the unit.

NOTE

These provide additional explanations and describe special cases.

CAUTION

Failure to follow these instructions could result in injury, damage to equipment or lost recording data, for example.

Using the TEAC Global Site

You can download this Reference Manual and the Owner's Manual necessary for this unit from the TEAC Global Site (<http://teac-global.com/>).

1. Open the TEAC Global Site (<http://teac-global.com/>).
2. In the TASCAM Downloads section, click the desired language to open the Downloads website page for that language.

NOTE

If the desired language does not appear, click Other Languages.

3. Click the product name in the "Search by Model Name" section to open the Downloads page for that product.
4. Select and download the Owner's Manual that are needed.

2 – Names and functions of parts

Front panel

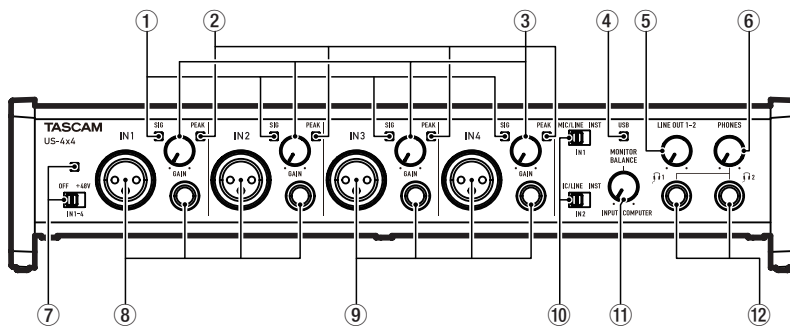

US-4x4 front panel

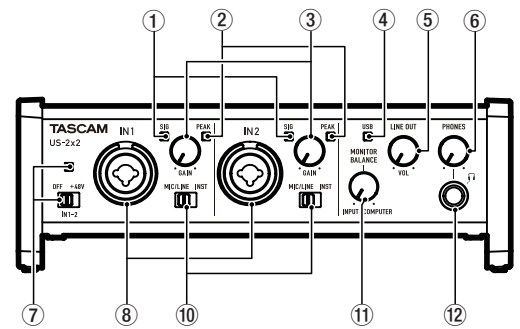

US-2x2 front panel

① SIG indicators

The **SIG** indicators light green when signals (of at least -32 dBFS) are input through the **IN1/IN2** jacks (and US-4x4 **IN3/IN4** jacks).

② PEAK indicators

The **PEAK** indicators light red when signals that are about to distort (-1 dBFS or higher) are input through the **IN1/IN2** jacks (and US-4x4 **IN3/IN4** jacks).

③ GAIN knobs

Use to adjust the input levels of the **IN1/IN2** jacks (and US-4x4 **IN3/IN4** jacks).
Adjust these so that the **PEAK** indicators do not light red.

④ USB indicator

This lights when the USB connection is working.

⑤ LINE OUT knob

Use to adjust the output level of the **LINE OUT 1-2** jacks.

⑥ PHONES knob

Use to adjust the output level of the **PHONES** jack (**FT1** and **FT2** jacks on US-4x4).

CAUTION

*Before connecting headphones, minimize the volume with the **PHONES** knob. Failure to do so might cause sudden loud noises, which could harm your hearing or result in other trouble.*

⑦ Phantom power switch/indicator

Use this switch to provide $+48V$ phantom power to the **IN1/IN2** jacks (and US-4x4 **IN3/IN4** jacks).
The indicator lights when the phantom power switch is set to $+48V$.

CAUTION

- Set the **LINE OUT** and **PHONES** knobs to their minimum values before changing the phantom power setting. Depending on the connected mics, sudden loud noises from monitoring equipment could occur, and this could damage the equipment or harm hearing.
- The phantom power switch changes the setting for both US-2x2 input channels (all four US-4x4 input channels) simultaneously.
- Do not connect or disconnect mics when the phantom power switch is set to $+48V$.
- Set the phantom power switch to $+48V$ only when using a condenser microphone that requires phantom power. Turning phantom power $+48V$ when a dynamic mic or other mic that does not require it is connected could damage this unit and connected equipment.

- Do not supply phantom power to an unbalanced dynamic mic.
- Supplying phantom power to some ribbon mics will break them. If you are unsure, do not supply phantom power to a ribbon mic.
- If you connect this unit to a laptop computer that is running on battery power and set the phantom power switch to $+48V$, the computer battery charge will be consumed more quickly.

⑧ IN1/IN2 (BALANCED/UNBALANCED) jacks

These input jacks are XLR/TRS combo jacks on the US-2x2 and separate XLR and standard TRS jacks on the US-4x4.
Use the **MIC/LINE INST** switches on the front of the unit to enable balanced line (**MIC/LINE**) input or unbalanced (**INST**) input for the standard TRS jacks.
When directly connecting a guitar, bass or other instrument, set the **MIC/LINE INST** switch to **INST**.

⑨ IN3/IN4 (BALANCED) jacks

These XLR analog mic input and standard line level TRS jacks are balanced input jacks.

NOTE

*On the US-4x4, the **IN1-IN4** (⑧, ⑨) inputs each have two jacks (XLR and TRS). Do not input signals through both jacks of the same input at the same time. If signals are input through both at the same time, neither signal will be received properly.*

⑩ MIC/LINE INST switches

Set according to the **IN1/IN2** jack input sources.
Set to **MIC/LINE** when connecting electronic instruments, audio devices, mics and similar equipment.
Set to **INST** when connecting an electric guitar, electric bass or other equipment with high output impedance.

⑪ MONITOR BALANCE knob

When recording input signals, use this to adjust the monitoring balance between the signals from this unit's input jacks and from the computer.
The volume of signals input through this unit's input jacks increase the more the **MONITOR BALANCE** knob is set to the left (**INPUT**) and signals output from the computer increase the more this is set to the right (**COMPUTER**).
This knob does not affect the recording level of input signals.

2 – Names and functions of parts

⑫ PHONES jack

Use this standard stereo phone jack to connect stereo headphones (⑪1 and ⑪2 jacks on US-4x4). Each of these jacks outputs the same signal as the **LINE OUT 1–2** jacks. Use an adapter to connect headphones with a mini plug.

NOTE

The same signals are output from both the ⑪1 and ⑪2 jacks of the US-4x4.

Rear panel

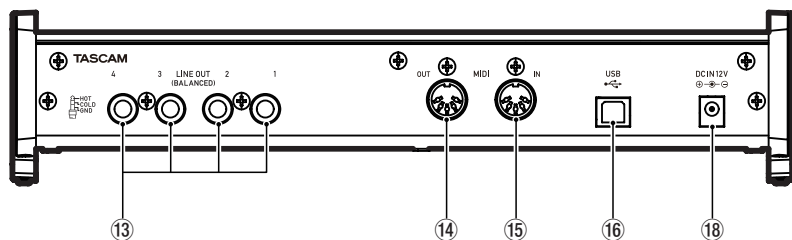

US-4x4 rear panel

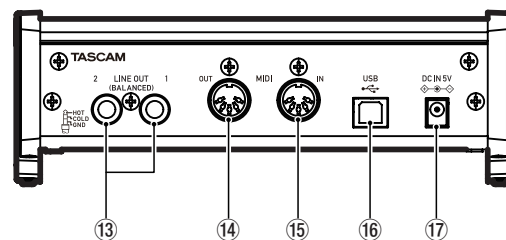

US-2x2 rear panel

⑬ LINE OUT (BALANCED) jacks

These standard TRS jacks are analog line outputs. The signals output from the **LINE OUT 1–2** jacks (1–4 jacks on US-4x4) can be set in the Settings Panel. For details, see “⑤ Line Outputs items” on page 14.

⑭ MIDI OUT connector

This 5-pin DIN is a standard MIDI output connector. This outputs MIDI signals.

⑮ MIDI IN connector

This 5-pin DIN is a standard MIDI input connector. Use this to input MIDI signals.

⑯ USB port

Use the included USB cable to connect the unit to a computer. (Supports USB 2.0.)

⑰ DC IN 5V connector (US-2x2 only)

To use this unit when connected to an iOS device, connect a DC5V TASCAM PS-P520 adapter here (sold separately).

NOTE

When using a US-2x2 that is connected to a computer, it will receive power from the computer's USB port, so a dedicated AC adapter (sold separately) should not be necessary.

Depending on the computer, however, the USB port might not be able to supply enough power to operate the unit.

In this case, use a dedicated AC adapter (sold separately).

⑱ DC IN 12V connector (US-4x4 only)

Connect the included DC12V AC adapter (GPE248-120200-Z) here.

CAUTION

- *When using a US-2x2 that is connected to a computer, it will receive power from the computer's USB port. Depending on the computer, the USB port might not be able to supply enough power to operate the unit.*
- *When connected to a USB 3.0 port, it will function in High Speed mode equivalent to USB 2.0 (480 Mbps maximum).*
- *After waking a computer from suspend (sleep) mode, if the unit does not operate properly, turn it off and turn it on again or disconnect and reconnect the USB cable.*

3 – Installation

System requirements

For the latest information about supported operating systems, visit the TEAC Global Site (<http://teac-global.com/>).

Windows

■ Supported operating systems

Windows 8 (including 8.1) 32-bit
Windows 8 (including 8.1) 64-bit
Windows 7 32-bit SP1 or later
Windows 7 64-bit SP1 or later
(Windows Vista and Windows XP are not supported)

■ Computer hardware requirements

Windows computer with a USB 2.0 port

■ CPU/processor speed

2 GHz or faster dual core processor (x86)

■ Memory

2 GB or more

CAUTION

Operation of this unit was confirmed using standard computers that meet the above requirements. This does not guarantee operation with all computers that meet the above requirements. Even computers that meet the same system requirements might have processing capabilities that differ according to their settings and other operating conditions

Mac OS X

■ Supported operating systems

OS X Yosemite (10.10 or later)
OS X Mavericks (10.9.1 or later)
OS X Mountain Lion (10.8.4 or later)

■ Computer hardware requirements

Apple Macintosh computer with a USB 2.0 port

■ CPU/processor speed

2 GHz or faster dual core processor

■ Memory

2 GB or more

Apple iOS devices

■ Supported operating systems

iOS 7 or later

Supported audio drivers

Windows: ASIO2.0, WDM, MIDI

Mac: Core Audio, Core MIDI

Installing the dedicated software

To use this unit with a computer, dedicated software must be installed on the computer.

The dedicated software might be updated at any time.

Download the latest software for the operating system you are using from the TEAC Global Site (<http://teac-global.com/>).

- To use this unit with a Windows computer, install the included driver. When you install the driver, a Settings Panel application will be installed at the same time.
- To use this unit with a Mac, install the Settings Panel application. The standard OS driver will be used.
- When using this unit with an iOS device, the standard OS driver will be used, so there is no need to install dedicated software.

CAUTION

Before starting to install software, quit other applications.

Installing the dedicated driver for Windows

NOTE

- Complete installation of the driver on the computer before connecting the unit to it with the USB cable.
- If you already connected the unit to the computer using the USB cable, and the Found New Hardware Wizard launched, close the Wizard and disconnect the USB cable.
- When you install the Windows driver, the Settings Panel is also installed at the same time.

■ Driver installation procedures

1. Download the latest driver for the operating system you are using from the TEAC Global Site (<http://teac-global.com/>) and save it on the computer to be used with the unit.
2. Uncompress the saved driver (zip file) on the computer desktop or another location.
3. When uncompressed, separate folders are created for 32-bit and 64-bit versions. To launch the installer software, double-click the "US-2x2_US-4x4_InstallerXX.exe" exe file ("XX" is the number of bits) that is suitable for the OS being used.

CAUTION

If you open a zip file without decompressing it and double-click the "US-2x2_US-4x4_Installer.exe" file in the folder that opens, installation will not start. Right-click the zip file and select "Extract All", for example, to decompress it and then try again.

4. When a "Security Warning" or "User Account Control" screens appear, click the "Run" or "Yes" button.
5. Next, select the desired language and click the "OK" button.

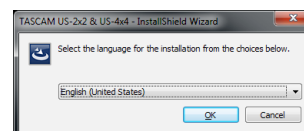

- Click the “Next” button when the screen below appears.

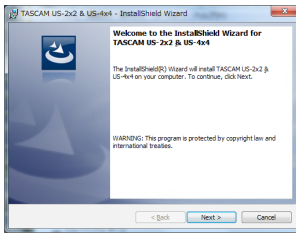

- Read the contents of the License Agreement, and select “I accept the terms in the license agreement” if you agree to the terms. Then, click the “Next” button.

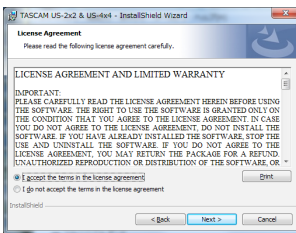

- Next, click the “Install” button to start installation.

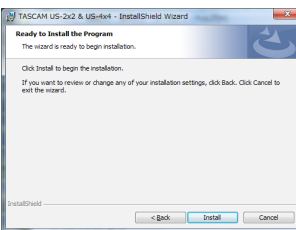

- The following screen appears when installation has completed. Click the “Finish” button.

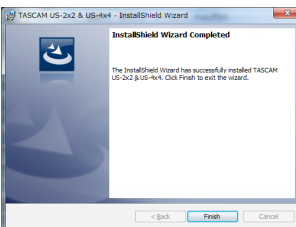

CAUTION

After installing the driver software, device driver installation will be completed the first time the unit is connected to the computer by USB. At this time, Windows will automatically search Windows Update, so it might take some time before the computer recognizes that the unit is connected. If the computer still does not recognize the unit after some time, open the software installer screen from the notification area at the bottom right of the computer display. Click “Skip obtaining driver software from Windows Update.” to stop the search.

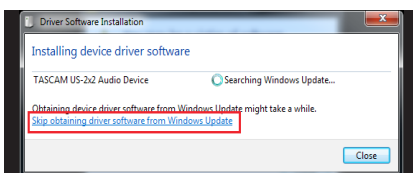

Installing the Mac OS X Settings Panel

NOTE

- Before starting to install the Settings Panel, quit other applications.
- During driver installation a warning message like this might appear: “US-2x2_US-4x4 Installer.dmg” can't be opened because it was not downloaded from the Mac App Store. If a message like this appears, follow the instructions in “Working with Gatekeeper” on page 8 and then proceed with the installation.

■ Settings Panel installation procedures

- Download the latest software for the operating system you are using from the TEAC Global Site (<http://teac-global.com/>) and save it on the computer to be used with the unit.
- Double-click “US-2x2_US-4x4 Installer.dmg”, which is the saved disk image file for the Settings Panel, and double-click “US-2x2_US-4x4 Installer.pkg” inside the folder that opens.



US-2x2_US-4x4
Installer.pkg

NOTE

Depending on the computer's settings, the downloaded zip file might not have opened automatically. In this case, open the zip file first and then double-click the disk image file.

- When the installer starts, click the “Continue” button.

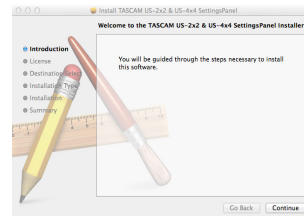

- Next, select the desired language and click the “Continue” button.

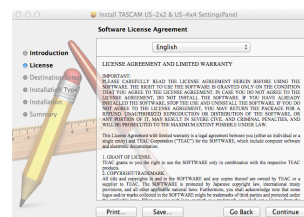

3 – Installation

- Click the “Read License” button and check the contents of the Software License Agreement. If you agree to the contents of the license, click “Agree”. Then, click the “Next” button.

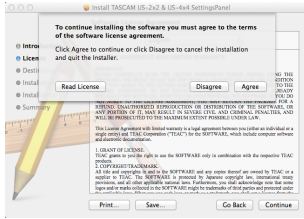

- Next, click the “Install” button to start installation.

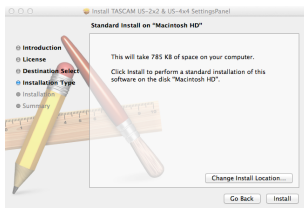

- The following screen appears when installation has completed. Click the “Close” button.

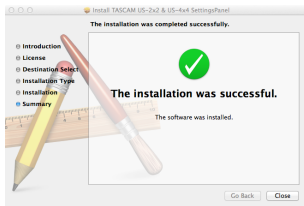

Working with Gatekeeper

When using Mac OS X, depending on the Gatekeeper security function setting, a warning message might appear during installation.

The solution depends on the warning message shown.

See the following explanations for details.

- When the Gatekeeper setting is “Allow applications downloaded from: the Mac App Store”

The following security warning might be shown: “US-2x2_US-4x4 Installer.dmg” can’t be opened because it was not downloaded from the Mac App Store.”



In this case, click the OK button to close the message. Then, control-click (or right-click) the file and click “Open”.

Click the “Open” button if the following security warning message appears: “US-2x2_US-4x4 Installer.dmg” can’t be opened because it was not downloaded from the Mac App Store. Are you sure you want to open it?”

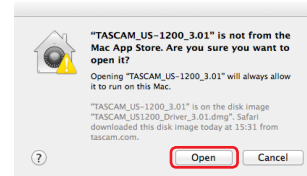

This warning message might also appear when the Gatekeeper setting is something other than “Allow applications downloaded from: the Mac App Store”.

The security warning message “US-2x2_US-4x4 Installer.dmg” can’t be opened because it was not downloaded from the Mac App Store.” could appear again, and you might not be able to open the file.

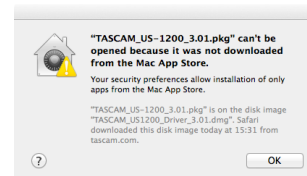

In this case, copy the file from the folder where it is to the desktop or another folder, and then open it. Alternatively, change the Gatekeeper settings to “Allow applications downloaded from: the Mac App Store and identified developers” and try opening it again.

- When the Gatekeeper setting is not “Allow applications downloaded from: the Mac App Store”

“US-2x2_US-4x4 Installer.dmg” is an application downloaded from the Internet. Are you sure you want to open it?” might appear as a security warning message. In this case, click the “Open” button.

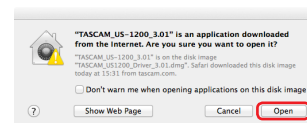

• Changing the Gatekeeper setting

The Gatekeeper setting can be changed using the “Allow applications downloaded from:” item on the “General” page of the “Security & Privacy” pane of the System Preferences. To change this, you must click the lock icon (🔒) at the bottom left and enter a password to unlock the settings.

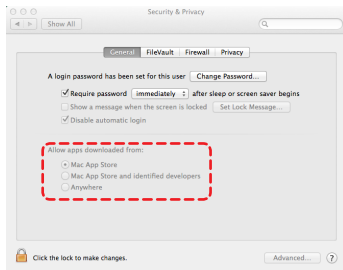

This setting will lock again when you click the “Show All” button at the top left of the window to close the open pane or when you quit the System Preferences by, for example, clicking the round button at the top left corner of the window (⏏) or typing command-Q.

CAUTION

Changing the Gatekeeper settings could result in security risks. If you changed the Gatekeeper setting to decrease security (use one of the lower settings), set it back to the original setting after updating the software and/or firmware. (When installing a firmware update immediately after software, do this after installing the firmware update.)

- When the “Remove that Program” screen opens, click the “Remove” button.

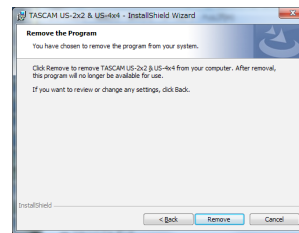

- The following screen appears when uninstallation has completed. Click the “Finish” button.

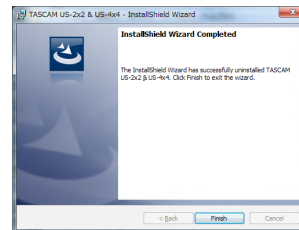

Installing the Mac OS X Settings Panel

Delete “US-2x2_US-4x4_Settings Panel” from the Applications folder to complete uninstallation.

Uninstalling the dedicated software

NOTE

Normally, there is no need to uninstall the dedicated software. Follow these procedures if a problem occurs or you no longer intend to use the unit with the computer.

Uninstalling the dedicated driver for Windows

- Double-click the “US-2x2_US-4x4_Installer.exe” file used for installation. When a “Security Warning” or “User Account Control” screen appears, click the “Run” or “Yes” button.
- Next, the Installshield Wizard will launch. Click the “Next” button.

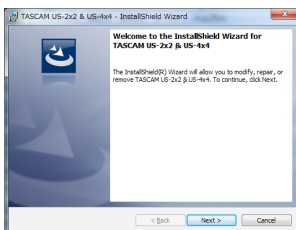

- When the “Program Maintenance” screen opens, select “Remove” and click the “Next” button.

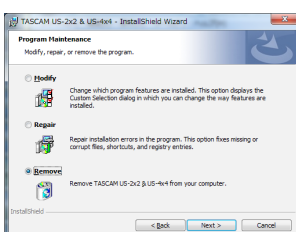

4 – Preparation

Connecting the power

■ US-4x4

Connect the power to the US-4x4 as shown below.

* The AC adapter for the US-4x4 includes two types of outlet plugs. Attach the type of plug that matches the power outlet that you are using.

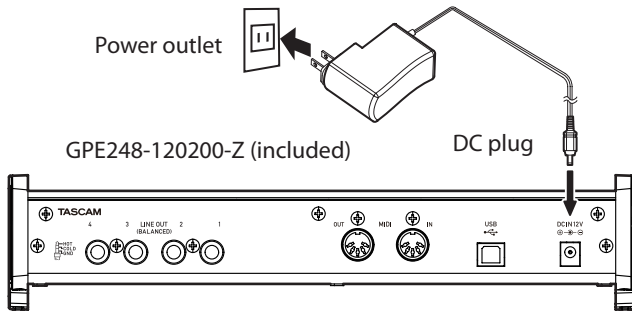

■ US-2x2

Normally, when a US-2x2 is connected to a computer, it will operate using USB bus power, so a separate power supply is not necessary. However, when using the unit connected to an iOS device or when not using USB bus power, a separate AC adapter designed for use with this unit (TASCAM PS-P520, DC5V) is necessary. In this case, connect the power source to the unit as shown below.

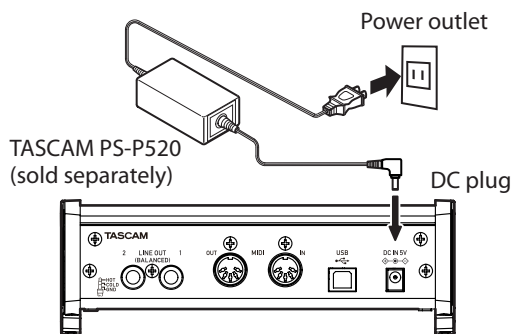

CAUTION

Always use the AC adapter designed for use with the unit: GPE248-120200-Z for the US-4x4 or TASCAM PS-P520 for the US-2x2.

Using a different AC adapter could cause malfunction, overheating, fire or other problems.

Changing the outlet plug (US-4x4 only)

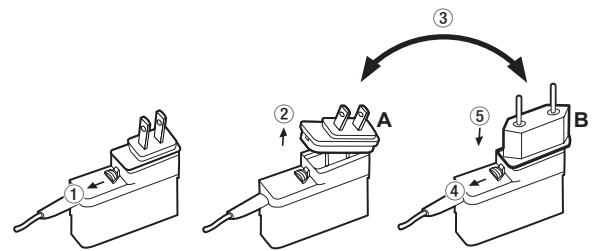

- ① Move the latch on the AC adapter in the direction of the arrow.
- ② Pull off the outlet plug.
- ③ Replace it with the other outlet plug (A or B).
- ④ Move the latch on the AC adapter in the direction of the arrow again.
- ⑤ Attach the outlet plug to the AC adapter.

This completes changing the outlet plug.

After changing the outlet plug, confirm that it is not loose or crooked and that everything is normal before plugging it into an outlet.

CAUTION

Do not use the adapter if there is anything abnormal about the plug after changing it. Use when the plug is abnormal could cause fire or electric shock. Contact the retailer where you purchased the unit or a TEAC service center (on the back cover) to request repair.

5 – Connections

Connecting other equipment

This is an example of US-4x4 connections.

■ Precautions before making connections

- Carefully read the operation manuals of the devices to be connected and then connect them correctly.
- Before making connections, turn this unit and all equipment to be connected off (standby).
- If possible, install all connected devices so that they are powered from the same AC power supply line. When using a power strip or similar device, be sure to use one that has high current capacity in order to minimize voltage fluctuations in the AC power supply.

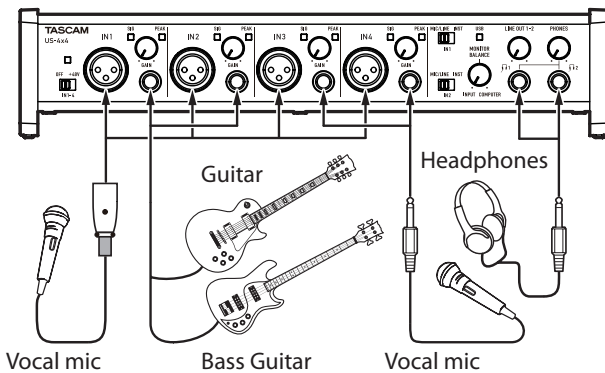

Examples of connections to a US-4x4 (front)

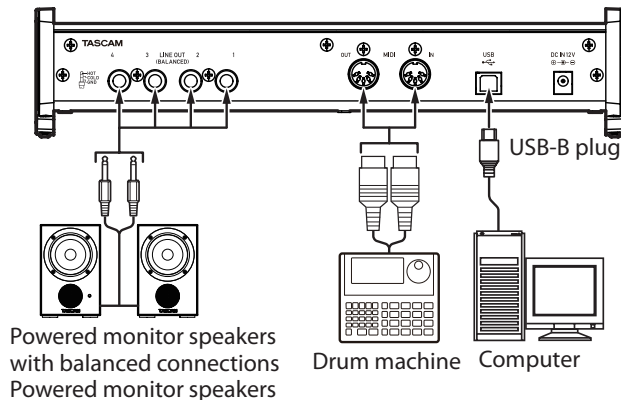

Examples of connections to a US-4x4 (back)

Computer connections

Use the included USB cable to connect the unit to a computer USB 2.0/3.0 port. When the USB connection is working, the USB indicator on the front of the unit lights.

CAUTION

If you connect this unit to a computer via a USB hub, for example, audio signal dropouts, clicking noises and other interference could occur due to the influence of other USB devices connected to that hub. For this reason, we strongly recommend connecting this unit to a separate USB port. Connecting USB keyboards and mice, however, to the same bus should not be a problem.

Audio connections

Analog audio signals input into this device from mics, guitars, keyboards and other audio equipment can be converted into digital signals and transmitted to the computer via USB. In addition, by connecting speakers (through an amplifier if not powered) or headphones to this unit, you can monitor audio signals that are input to this unit and output from the computer.

CAUTION

*Before connecting audio equipment, set the **GAIN**, **LINE OUT** and **PHONES** knobs to their lowest values. Failure to do so could cause sudden loud noises from monitoring equipment, and this could damage the equipment or harm hearing.*

Microphones

- **Dynamic mics**
Connect these to the **IN1/IN2** jacks (and US-4x4 **IN3/IN4** jacks) on the front of the unit
- **Condenser mics**
When using condenser mics that require phantom power, connect them to the **IN1/IN2** jacks (and US-4x4 **IN3/IN4** jacks) on the front of the unit, and set the phantom power switch to **+48V**.

When the phantom power switch is set to **+48V**, the phantom power indicator on the front of the unit lights.

CAUTION

- *The phantom power switch changes the setting for both US-2x2 input channels (all four US-4x4 input channels) simultaneously. Do not turn phantom power +48V when connecting a mic that does not require phantom power.*
- *Do not connect or disconnect mics while phantom power is +48V. Doing so could cause a loud noise and might damage this unit and connected equipment.*
- *Set the **LINE OUT** and **PHONES** knobs to their minimum values before turning phantom power +48V/OFF. Depending on the connected mics, sudden loud noises from monitoring equipment could occur, and this could damage the equipment or harm hearing.*
- *Turning phantom power +48V when a dynamic mic or other mic that does not require it is connected could damage this unit and connected equipment.*
- *Supplying phantom power to some ribbon mics will break them. If you are unsure, do not supply phantom power to a ribbon mic.*

Guitar

When connecting a guitar or bass guitar directly to this unit, use the **IN1** or **IN2** jack on the front of the unit and set the **MIC/LINE INST** switch for that jack to **INST**.

Electronic instruments and other audio equipment

When connecting an electronic instrument or other audio equipment directly to this unit, use the **IN1** and **IN2** jacks on the front of the unit and set their **MIC/LINE INST** switches to **MIC/LINE**.

Analog record players

The output of an analog record player cannot be connected directly to this unit. To connect an analog record player to this unit, a phono amp and equalizer (or an audio amplifier that has phono input jacks) must be connected between them.

5 – Connections

Monitor speakers

Connect monitor speakers (powered speakers or an amplifier and speaker system) to the **LINE OUT 1-2** jacks on the back of the unit.

Use the **LINE OUT** knob on the front of the unit to adjust the speaker volume.

Headphones

Connect headphones to the **PHONES** jack (standard stereo) on the front of the unit.

NOTE

The same signals are output from both the \square 1 and \square 2 jacks of the US-4x4.

CAUTION

*Before connecting headphones, minimize the volume with the **PHONES** knob. Failure to do so might cause sudden loud noises, which could harm your hearing or result in other trouble.*

MIDI connections

Connect sound modules, keyboards, synthesizers, drum machines and other MIDI devices to the unit in the following manner.

- If you want to monitor sound from a MIDI device, connect its outputs to this unit's **LINE IN** or use in external mixer.
- You can also use the **MIDI IN** and **MIDI OUT** connectors on the back of the unit to send and receive MIDI timecode (MTC). By doing this, you can use an application that supports MTC to synchronize a multitrack recorder (MTR) and MIDI devices.

CAUTION

- *The **MIDI IN** and **USB** indicators might stay lit even after the connected computer is shut down. This is because some computers continue to provide power through USB cables even after being shut down.*
- *The **MIDI IN** indicator lights when the unit is receiving MIDI data through the **MIDI IN** connector. If you connect a device that sends MIDI active sensing messages, this indicator will blink constantly. In order to avoid this, disable MIDI active sensing on the connected device.*
- *When using Windows Media Player, if the "Sound and Audio Devices Properties" **Control Panel** "MIDI music playback (default device)" is set to "Microsoft GS Wavetable SW Synth", you will not be able to hear MIDI performances through this unit's **LINE OUT [BALANCED]** or **PHONES** jacks.*

Connecting with iOS devices

■ US-2x2

You will need a Lightning to USB Camera Adapter¹ and an AC adapter² (sold separately).

■ US-4x4

You will need a Lightning to USB Camera Adapter¹.

¹You will need to prepare an Apple genuine Lightning to USB Camera Adapter (sold separately).

²DC5V TASCAM PS-P520 AC adapter (sold separately)

6 – Using the Settings Panel

Opening the Settings Panel

You can use the Settings Panel to make settings for the various functions of the unit.

Open the Settings Panel in the following manner.

Windows OS

- Select the Settings Panel from “All Programs” or “All apps”

Windows 7

Start button All Programs → select “TASCAM US-2x2 & US-4x4 Settings Panel” under TASCAM and opened the Settings Panel.

Windows 8

In Windows 8, right-click the Start screen and click the “All apps” button (in Windows 8.1, the  button that appears at the bottom left of the Start screen) to open the Apps screen. On this screen, click the “TASCAM US-2x2 & US-4x4 Settings Panel” item under “TASCAM” to open the Settings Panel.

- In Windows 8, select “TASCAM US-2x2 & US-4x4 Settings Panel” on the Start screen to open the Settings Panel.

NOTE

In Windows 8.1, the application is not automatically added to the Start screen.

- Open the Settings Panel from the Control Panel.

Windows 7

- Click the Start button and select “Control Panel” to open the Control Panel.
- If the Control Panel is showing categories, set the “View by:” item to “Large icons” or “Small icons”.
- Select “TASCAM US-2x2 & US-4x4 Settings Panel” to open the Settings Panel.

Windows 8

- In Windows 8, right-click the Start screen and click the “All apps” button (or  button in Windows 8.1) that appears at the bottom right of the screen, and click “Control Panel” to open it.
- If the Control Panel is showing categories, set the “View by:” item to “Large icons” or “Small icons”.
- Select “TASCAM US-2x2 & US-4x4 Settings Panel” to open the Settings Panel.

NOTE

In Windows 8, you can also open the Control Panel by clicking the Control Panel item in the menu that appears if you right-click the bottom left corner of the desktop.

Mac OS X

- Using the Finder, open the Applications folder and click “TASCAM US-2x2 & US-4x4 Settings Panel” to open the Settings Panel.
- In the Audio Devices window of the Audio MIDI Setup application, right-click (control-click) “US-2x2” or “US-4x4” (or click the settings icon when the unit name is selected) and click “Configure device...” to open the Settings Panel.

Settings Panel screen

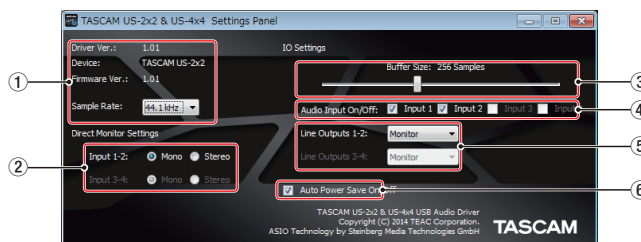

Windows Settings Panel screen

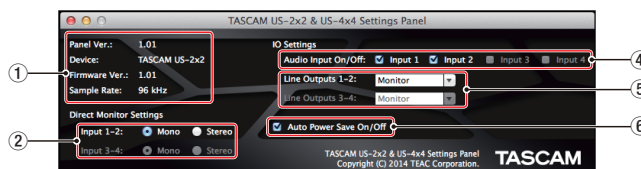

Mac Settings Panel screen

① Status display area





This shows the current status of the software.

Item displayed	Meaning
Driver Ver (Windows) Panel Ver (Mac)	This is the software version.
Device	This is the name of the connected unit. (“No Device” is shown when no device is connected.)
Firmware Version (Nothing is shown when no device is connected.)	This is the firmware version used by the connected unit.
Sample Rate (Nothing is shown when no device is connected.)	This shows the sampling frequency. <ul style="list-style-type: none"> The sampling frequency can only be set in the Windows version. Use the displayed value pull-down menu to select the frequency (44.1, 48, 88.2 or 96 kHz).

② Direct Monitor Settings

Input 1-2 and Input 3-4 (US-4x4 only)

Set the monitoring signal for the **IN1-IN2/IN3-IN4** jacks to “Mono” or “Stereo”.

- When set to “Mono”
 - Stereo signals sent to the computer remain unchanged, but are output as mono signals from the **LINE OUT (BALANCED)** and **PHONES** (1 and 2 jacks on US-4x4) jacks.
- When set to “Stereo”
 - Stereo signals sent to the computer remain unchanged, and are output as stereo signals from the **LINE OUT (BALANCED)** and **PHONES** (1 and 2 jacks on US-4x4) jacks.

6 – Using the Settings Panel

③ Buffer Size item (Windows Only)

The driver for the unit stores the audio input and output signals transferred to and from the computer temporarily in a buffer.

This buffer size can be adjusted.

Smaller buffer sizes result in less audio signal delay (latency), but require high-speed processing by the computer.

If the processing cannot keep up, for example, due to other system operations, clicking and popping noises might occur and the audio signal might even drop out.

Increasing the buffer size will stabilize operation and suppress negative effects on audio signals, but the delay in audio signals sent to the computer will increase.

You can use the slider on the panel to adjust the buffer size, according to the use conditions.

Use the slider to select fixed values that increase from left to right (64, 128, 256, 512, 1024 and 2048 samples).

④ Audio Input items

Turn input on/off for each channel separately.

- Turn an input on by putting a check in its checkbox . When an input is on, signals on that channel will be input.
- Turn an input off by removing the check from its checkbox . When an input is off, signals on that channel will not be input.

⑤ Line Outputs items

Line Output 1-2

- Select the signals output from the unit's **LINE OUT 1-2** and PHONES (1 and 2 jacks on US-4x4) jacks.

Line Output 3-4 (US-4x4 only)

- Select the signals output from the unit's **LINE OUT 3-4** jacks.

Options

"MONITOR"

The signals from the channels selected using the **Audio Input On/Off** items and the signals sent from the computer by USB are mixed using the **MONITOR BALANCE** knob. This mix is output from the **LINE OUT 1-2** and **PHONES** jacks.

NOTE

*Set the **MONITOR BALANCE** knob all the way to the left (**INPUT**) to monitor only the input channel signals and set it all the way to the right (**COMPUTER**) to monitor only signals output from the computer. At other positions, both signals will be mixed.*

"Computer 1-2"

Only the "Computer 1-2" signals sent from the computer by USB are output from the **LINE OUT [BALANCED]** and **PHONES** jacks.

"Computer 3-4 (US-4x4 only)"

Only the "Computer 3-4" signals sent from the computer by USB are output from the **LINE OUT [BALANCED]** and **PHONES** jacks.

⑥ Auto Power Save On/Off

When this setting is on, if operating in standalone mode and no input signal (above -60 dBFS) has been detected for 30 minutes, the unit will turn itself off (start standby) automatically.

Options

"ON" (default) : The automatic power saving function is on.

"OFF" : The automatic power saving function is off.

Overview

This unit will operate in standalone mode if it is turned on when it is not connected to a computer by USB.

You can use this unit as a mic preamp and to monitor input signals.

This function is convenient when you want to practice an instrument without recording, for example.

However, when using US-2x2 in standalone mode, a TASCAM PS-P520 DC5V AC adapter (sold separately), which is designed for use with this unit, is necessary.

Settings in standalone mode

When operating in standalone mode, input signals pass-through the built-in digital mixer and output selector, which are set at fixed values, and are output from the output jacks. In addition, when operating in standalone mode, the USB indicator will blink.

Settings Panel settings

The Settings Panel will be set as follows.

- Direct Monitor Settings Input 1-2 : Mono
- Direct Monitor Settings Input 3-4 : Mono
(US-4x4 only)
- Audio Input On/Off : All on
- Line Outputs 1-2 : MONITOR
- Line Outputs 3-4 : MONITOR
(US-4x4 only)
- ERP2 Setting On/Off : Current setting retained

8 – Application Guide

In this chapter, we explain how to set some audio applications for use with this unit.

DAW software

SONAR LE and Ableton Live Lite

Download quickstart guides for the included DAW software from the TEAC Global Site (<http://teac-global.com/>), and refer to them for instructions about downloading, installing and making settings in these applications.

Other DAW software

When using any other DAW software, consult its operation manual.

Windows Media Player

Windows 8

1. Quit all applications and right-click the Start screen and then click the “All apps” button that is at the bottom right of the screen to open the Apps screen.

NOTE

In Windows 8.1, click the  button that appears at the bottom right of the Start screen.

2. Click “Control Panel”.
3. Click “Hardware and Sound”, and then open the “Sound” window.
4. On the “Playback” page, right-click “Speakers TASCAM US-2x2” (or “Speakers TASCAM US-4x4”), and click “Set as Default Device” in the pop-up menu that appears. When you do this, the green check mark (“✓”) appears next to “Speakers TASCAM US-2x2” (or “Speakers TASCAM US-4x4”).

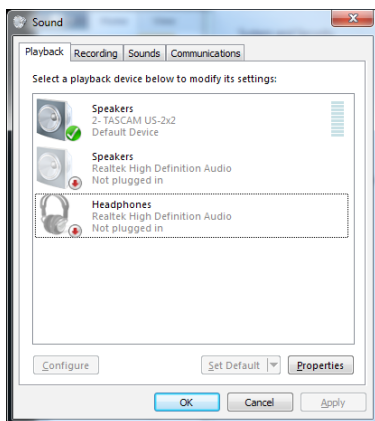

NOTE

To use this unit as the recording device, open the “Recording” page and use Set as Default Device for “Line In TASCAM US-2x2” (or Line In TASCAM US-4x4).

5. After completing the setting, click the “OK” button.
6. Launch Windows Media Player, select an audio file and start playback.

NOTE

- If you change the setting while Windows Media Player is running, the software will not recognize that the device has been changed. In this case, restart Windows Media Player.

- If you still cannot hear sound after making the settings and completing the procedures above, restart the computer.
- If you make this setting, sound will be output through this unit, but no sound will be output from the computer’s speakers or headphone jack.

Windows 7

7. Quit all applications and open the “Control Panel” from the Start button menu.
8. Open “Sound”.

NOTE

If you do not see this item, click “Hardware and Sound”.

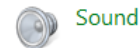

9. On the “Playback” page, right-click “Speakers TASCAM US-2x2” (or “Speakers TASCAM US-4x4”), and click “Set as Default Device” in the pop-up menu that appears. When you do this, the green check mark (“✓”) appears next to “Speakers TASCAM US-2x2” (or “Speakers TASCAM US-4x4”).

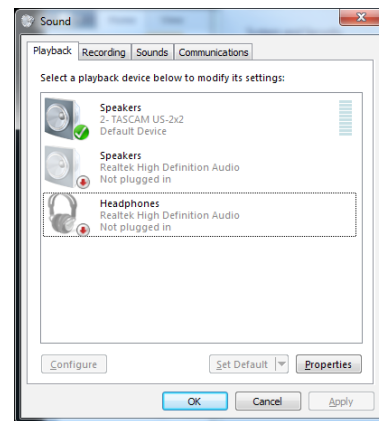

NOTE

To use this unit as the recording device, open the “Recording” page and use Set as Default Device for “Line In TASCAM US-2x2” (or TASCAM US-4x4).

10. After completing the setting, click the “OK” button.
11. Start Windows Media Player, select an audio file and begin playback.

NOTE

- If you change the setting while Windows Media Player is running, the software will not recognize that the device has been changed. In this case, restart Windows Media Player.
- If you still cannot hear sound after making the settings and completing the procedures above, restart the computer.
- If you make this setting, sound will be output through this unit, but no sound will be output by the computer’s speakers or headphone jack.

Mac OS X and iTunes

1. Open the Utilities folder within the “Applications folder”, and double-click “Audio MIDI Setup”. Then open the “Audio Devices” window.
2. Click “TASCAM US-2x2 Audio Device” (or “TASCAM US-4x4 Audio Device”) to select it and right-click or control-click it. Then, click “Use this device for sound output” in the pop-up menu.

The speaker mark appears next to “TASCAM US-2x2 Audio Device” (or “TASCAM US-4x4 Audio Device”).

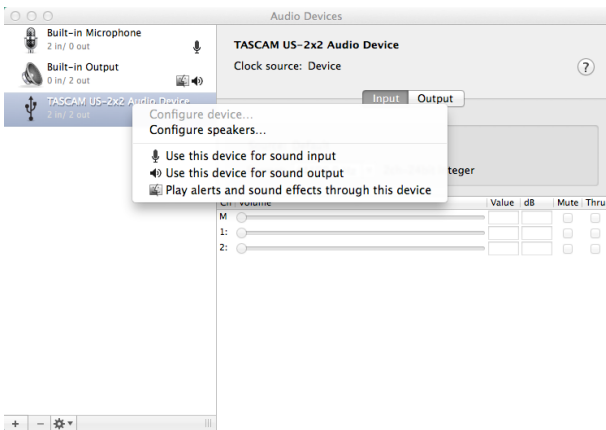

NOTE

To use this device as the recording device, select “Use this device for sound input” for the “TASCAM US-2x2 Audio Device” (or “TASCAM US-4x4 Audio Device”).

3. Launch iTunes, select an audio file and start playback.

9 – MIDI Implementation Chart

■ MIDI Implementation Chart

Function		Transmit	Recognize	Remarks
Basic channels	When power on	×	×	Thru
	Settable	×	×	
Mode	When power on	×	×	Thru
	Messages	×	×	
	Altered		
Note number	Range	×	×	Thru
Velocity	Note on	×	×	Thru
	Note off	×	×	
Aftertouch	Polyphonic	×	×	Thru
	Channel	×	×	
Pitch bend		×	×	Thru
Control change		×	×	Thru
Program change		×	×	Thru
	Setting range		
System exclusive		×	×	Thru
System common	Position	×	×	Thru
	Song select	×	×	
	Tune	×	×	
System real-time	Clock	×	×	Thru
	Command	×	×	
Other	Local on/off	×	×	Thru
	All notes off	×	×	
	Active sense	×	×	
	Reset	×	×	
Notes				

Mode 1: OMNI ON, POLY Mode 2: OMNI ON, MONO ○ : YES
 Mode 3: OMNI OFF, POLY Mode 4: OMNI OFF, MONO × : NO

10 – Troubleshooting

Please read this chapter if you are unable to use the unit properly even after setting it following the procedures in this manual.

If you are still unable to resolve a problem, please contact TASCAM customer support with the following information about the operating environment and details about the trouble.

■ Operating environment

- Computer manufacturer :
- Model :
- CPU :
- Memory (RAM) :
- Operating system :
- Applications used :
- Antivirus software :
- Wireless LAN use:

See the end of this document for contact information.

■ I cannot install the dedicated software.

1. Check the operating system
The operating system being used might not be compatible with the software that you are trying to install. Check the compatible operating system of the software you are trying to install again.
2. Stop software running in the background
Antivirus software and other software that runs in the background can prevent installation. Quit software that runs in the background and try installation again.

■ The unit is connected, but the computer does not recognize it.

1. Install the dedicated software
Install the dedicated software. See "Installing the dedicated software" on page 76.
2. Change the USB port
 - This unit cannot be used with USB 1.1. Use a USB 2.0 or USB 3.0 port.
 - Do not use a USB hub with this unit. Always connect the unit directly to a USB port on the computer.
 - If the above methods do not resolve the problem, connect the unit to a different USB port on the computer.

■ I cannot hear any sound even when audio is played back on the computer.

Confirm that the **MONITOR BALANCE** knob on the unit is not turned all the way to the left (toward **INPUT**). If that is the case, turn the **MONITOR BALANCE** knob to the right of center.

In addition, check the status of the unit's connection with the computer.

Moreover, if you make the following settings, sound will be output through this unit, but no sound will be output by the computer's speakers or headphone jack.

Windows 7/8

See the "8 – Application Guide" on page 16 "– Windows 8" or "Windows 7" instructions in the "Windows Media Player" section in this manual, and make settings as necessary for the OS.

Conduct "procedures 1–4 for Windows 8" or "procedures 1–3 for Windows 7" to set the default device for playback.

Mac OS X

1. Quit all applications and open "System Preferences..." from the Apple menu.
2. Open "Sound".
3. On the "Output" tab, select "US-2x2" or "US-4x4".

After completing the setting, restart the computer and check the sound of playback. Depending on the application that you are using, you might need to make additional device settings. In particular, DAW software operate using audio engines with settings that are different from the OS settings, so confirm the DAW driver settings first after installing the dedicated software for this unit.

Please see the manuals for the applications that you are using for detailed setting procedures.

■ Sound breaks up or there is noise.

The processing load on the computer causes sound to break up and noise to occur.

Here are some methods to reduce the load on the computer.

1. A wireless LAN and software running in the background, including antivirus software, regularly put processing loads on the computer, which can cause sound to break up and other noise.
Stop wireless LAN transmission, antivirus software and other software running in the background when using this unit.
2. Set the buffer size (latency) in the audio application that you are using or in this unit's Settings Panel to a larger value.

NOTE

Consult the maker of the audio application that you are using for methods to reduce its load on your computer.

3. Change the settings of your computer so that they are optimal for audio processing.

Windows 8

- ① In Windows 8, right-click the ordinary Start screen (Metro user interface screen) and then click "All apps".
- ② Right-click "Computer" and select "Properties".
- ③ Click "Advanced system settings".
- ④ Click "Settings" in the "Performance" section of the "Advanced" tab of the "System Properties" window.
- ⑤ In the "Visual Effects" tab of the "Performance Options" window, select "Adjust for best performance".

10 – Troubleshooting

Windows 7

a) Turn “Aero” off.

- ① Right-click the desktop and select “Personalize”.
- ② Select a “Basic” or “High Contrast” theme.

b) Performance settings

- ① Right-click “Computer” and select “Properties”.
- ② Click “Advanced system settings”.
- ③ Click “Settings” in the “Performance” section of the “Advanced” tab of the “System Properties” window.
- ④ In the “Visual Effects” tab of the “Performance Options” window, select “Adjust for best performance”.

Mac OS X

- ① Open “System Preferences...” from the Apple menu, and select “Energy Saver”.
- ② Set “Computer sleep” to “Never”.
- ③ Set “Display sleep” to “Never”.

NOTE

Depending on the Mac OS X version and Macintosh computer model, this setting might not be available.

■ SONAR LE support

Our company does not provide support for SONAR LE. Please refer to the SONAR LE help menu for instructions about using the application.

■ Ableton Live Lite support

Our company does not provide support for Ableton Live Lite. Please refer to the Ableton Live Lite help menu for instructions about using the application.

11 – Specifications

Audio resolution

■ Sampling frequencies

44.1, 48, 88.2, 96 kHz

■ Quantization bit depth

16/24-bit

Analog inputs

Mic inputs (balanced)

US-2x2	: IN 1-2
US-4x4	: IN 1-4
Connectors	: XLR-3-31 equivalent (1: GND, 2: HOT, 3: COLD)
Input impedance	: 2.2 k Ω
Rated input level	: -65 dBu (0.0004 Vrms) (gain knob at MAX)
Rated input level	: -8 dBu (0.3090 Vrms) (gain knob at MIN)
Maximum input level	: +8 dBu (1.9467 Vrms)
Gain range	: 57 dB

Instrument inputs (unbalanced)

IN 1-2

(MIC/LINE INST switch set to INST)

Connectors	: 6.3mm (1/4") standard TS stereo jacks (Tip: HOT, Sleeve: GND)
Input impedance	: 1 M Ω or more
Rated input level	: -63 dBV (0.0007 Vrms) (gain knob at MAX)
Rated input level	: -6 dBV (0.5015 Vrms) (gain knob at MIN)
Maximum input level	: +10 dBV (3.162 Vrms)
Gain range	: 57 dB

Line inputs (balanced)

US-2x2	: IN 1-2
US-4x4	: IN 1-4
(MIC/LINE INST switch set to MIC/LINE)	
Connector	: 6.3mm (1/4") standard TRS stereo jack (Tip: HOT, Ring: COLD, Sleeve: GND)
Input impedance	: 10 k Ω
Rated input level	: -53 dBu (0.0017 Vrms) (gain knob at MAX)
Rated input level	: +4 dBu (1.228 Vrms) (gain knob at MIN)
Maximum input level	: +20 dBu (7.75 Vrms)
Gain range	: 57 dB

Analog outputs

Outputs (LINE OUT (BALANCED))

US-2x2	: LINE OUT 1-2
US-4x4	: LINE OUT 1-4
Connectors	: 6.3mm (1/4") standard TRS stereo jacks (Tip: HOT, Ring: COLD, Sleeve: GND)
Output impedance	: 110 Ω
Rated output level	: +4 dBu (1.273 Vrms)
Maximum output level	: +20 dBu (7.75 Vrms)

Headphone output (PHONES)

Connector	: 6.3mm (1/4") standard stereo jack
Maximum output	
US-2x2	: 18 mW + 18 mW or higher (THD+N 1% or less, into 32 Ω load)
US-4x4	: 45 mW + 45 mW or higher (THD+N 1% or less, into 32 Ω load) (1 and 2 total)

Control input/output ratings

MIDI IN connector

Connector	: 5-pin DIN
Format	: standard MIDI

MIDI OUT connector

Connector	: 5-pin DIN
Format	: standard MIDI

USB

Connector	: 4-pin USB B-type
Transfer rate	: USB 2.0 High Speed (480 Mbps)

Audio performance

Mic amp EIN (equivalent input noise)

-127 dBu or less (150 Ω termination, gain knob at MAX)

Frequency response

IN1-IN4 → LINE OUT (BALANCED), Headphone (HP) output

At 44.1kHz and 48kHz	
20Hz	: +0dB/-0.3dB (JEITA)
20kHz	: +0dB/-0.1dB (JEITA)
20kHz	: +0dB/-0.5dB (HP output, JEITA)
At 88.2kHz and 96kHz	
20Hz	: +0dB/-0.3dB (JEITA)
40kHz	: +0dB/-0.3dB (JEITA)
40kHz	: +0dB/-2.0dB (HP output, JEITA)

S/N ratio

101 dB or higher (MIC/LINE input to LINE OUT, gain knob at MIN, JEITA)

Distortion

0.003% or less (MIC/LINE input to LINE OUT, 1kHz sine wave, at nominal input level and maximum output level, JEITA)

Crosstalk

95 dB or more (MIC/LINE input to LINE OUT, 1 kHz, JEITA)

11 – Specifications

Computer system requirements

Check the TEAC Global Site (<http://teac-global.com/>) for the latest information about supported operating systems.

Windows

Supported operating systems

Windows 8 (including 8.1) 32-bit
Windows 8 (including 8.1) 64-bit
Windows 7 32-bit SP1 or later
Windows 7 64-bit SP1 or later
(Windows Vista and Windows XP are not supported)

Computer hardware requirements

Windows computer with a USB 2.0 port

CPU/processor speed

2 GHz or faster dual core processor (x86)

Memory

2 GB or more

CAUTION

Operation of this unit was confirmed using standard computers that meet the above requirements. This does not guarantee operation with all computers that meet the above requirements. Even computers that meet the same system requirements might have processing capabilities that differ according to their settings and other operating conditions

Mac OS X

Supported operating systems

OS X Yosemite (10.10 or later)
OS X Mavericks (10.9.1 or later)
OS X Mountain Lion (10.8.4 or later)

Computer hardware requirements

Apple Macintosh computer with a USB 2.0 port

CPU/processor speed

2 GHz or faster dual core processor

Memory

2 GB or more

iOS devices

Apple devices running iOS 7 or later

Supported audio drivers

Windows: ASIO2.0, WDM, MIDI
Mac: Core Audio, Core MIDI

General

Power

US-2x2 : Supplied by computer over USB*
US-4x4 : Dedicated AC adapter
(GPE248-120200-Z), DC12V

* When using with an iOS device, a separate AC adapter designed for use with this unit (TASCAM PS-P520, DC5V) is necessary.

Power consumption

US-2x2 : 2.5 W
US-4x4 : 5 W

External dimensions

US-2x2 : 186 × 65 × 160 mm (width × height × depth)
US-4x4 : 296 × 65 × 160 mm (width × height × depth)

Weight

US-2x2: 1.1 kg
US-4x4: 1.6 kg

Operating temperature range

5–35 °C

Bundled DAW software

SONAR LE (for Windows)
Ableton Live Lite

Dimensional drawings

■ US-4x4

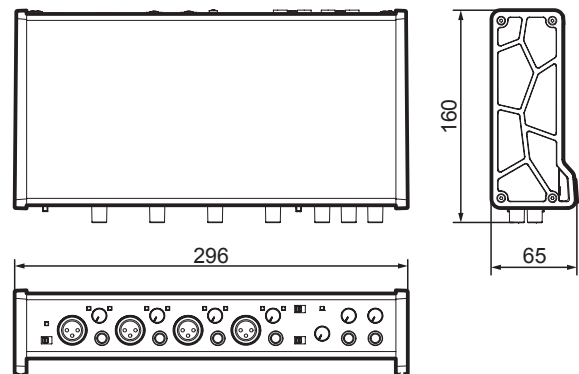

■ US-2x2

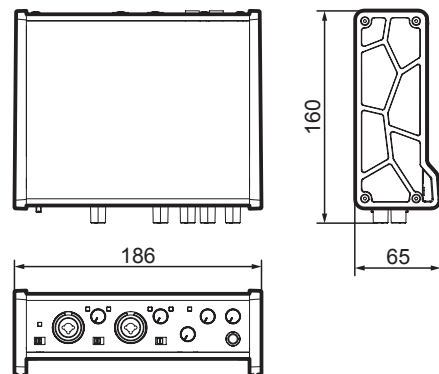

- Illustrations in this reference manual might differ in part from the actual product.
- Specifications and external appearance might be changed without notification to improve the product.

TASCAM

TEAC CORPORATION

Phone: +81-42-356-9143
1-47 Ochiai, Tama-shi, Tokyo 206-8530 Japan

<http://tascam.jp/>

TEAC AMERICA, INC.

Phone: +1-323-726-0303
1834 Gage Road, Montebello, California 90640 USA

<http://tascam.com/>

TEAC MEXICO, S.A. de C.V.

Phone: +52-55-5010-6000
Río Churubusco 364, Colonia Del Carmen, Delegación Coyoacán, CP 04100, México DF, México

<http://teacmexico.net/>

TEAC UK LIMITED

Phone: +44-8451-302511
Meridien House, Ground Floor, 69 - 71, Clarendon Road, Watford, Hertfordshire, WD17 1DS, UK

<http://tascam.eu/>

TEAC EUROPE GmbH

Phone: +49-611-71580
Bahnstrasse 12, 65205 Wiesbaden-Erbenheim, Germany

<http://tascam.eu/>

TEAC SALES & TRADING(SHENZHEN) CO., LTD

Phone: +86-755-88311561~2
Room 817, Block A, Hailrun Complex, 6021 Shennan Blvd., Futian District, Shenzhen 518040, China

<http://tascam.cn/>
