

POWER SUPPLY UNIT

REPAIR MANUAL

02R96

■ CONTENTS

ANALYSIS-REPAIR FLOW CHART	2
2H032W AC-DC POWER SUPPLY	10
ABOUT ANALYSIS AND REPAIR OPERATIONS	14
CIRCUIT DIAGRAM.....	15
PARTS LIST	16

ANALYSIS-REPAIR FLOW CHART

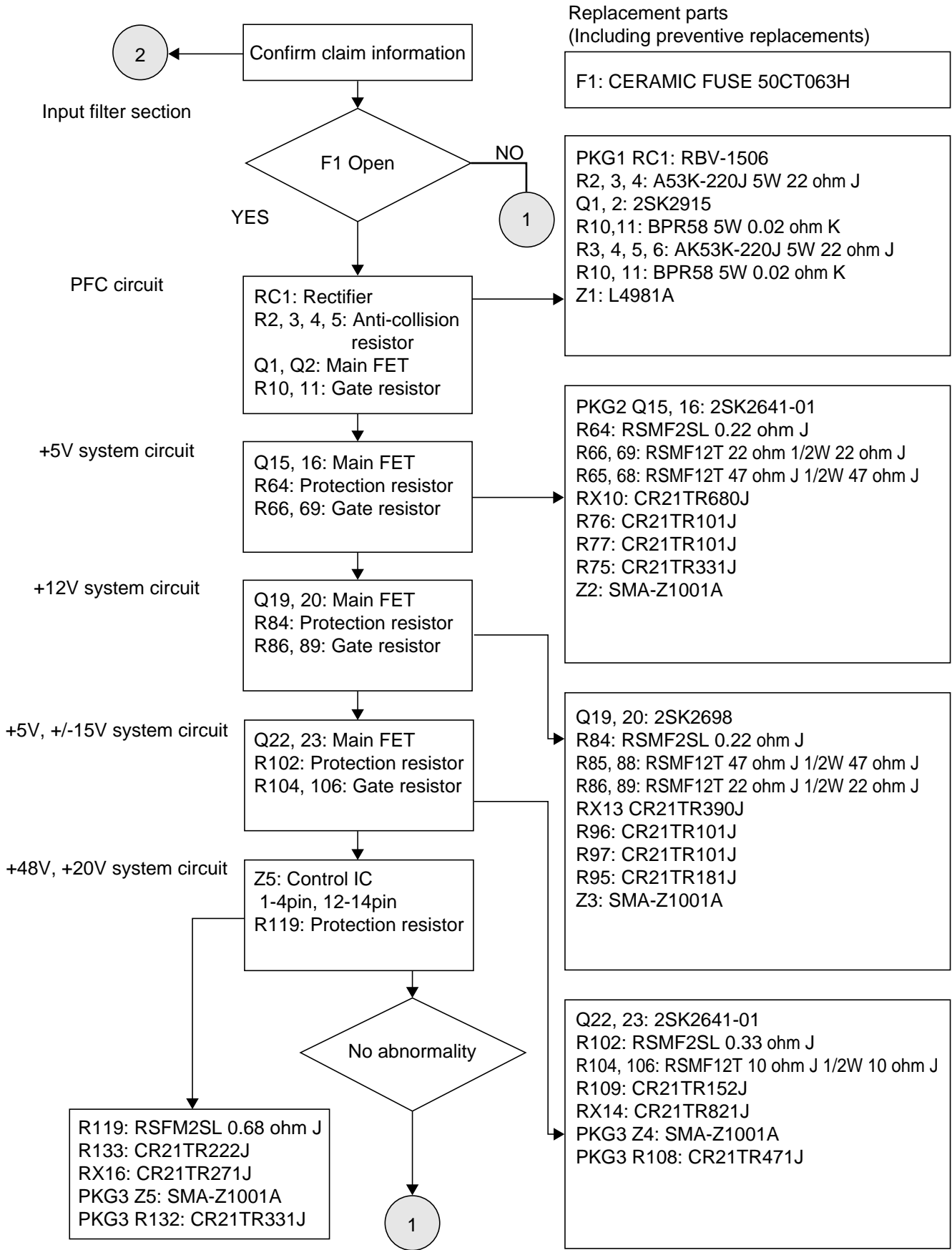

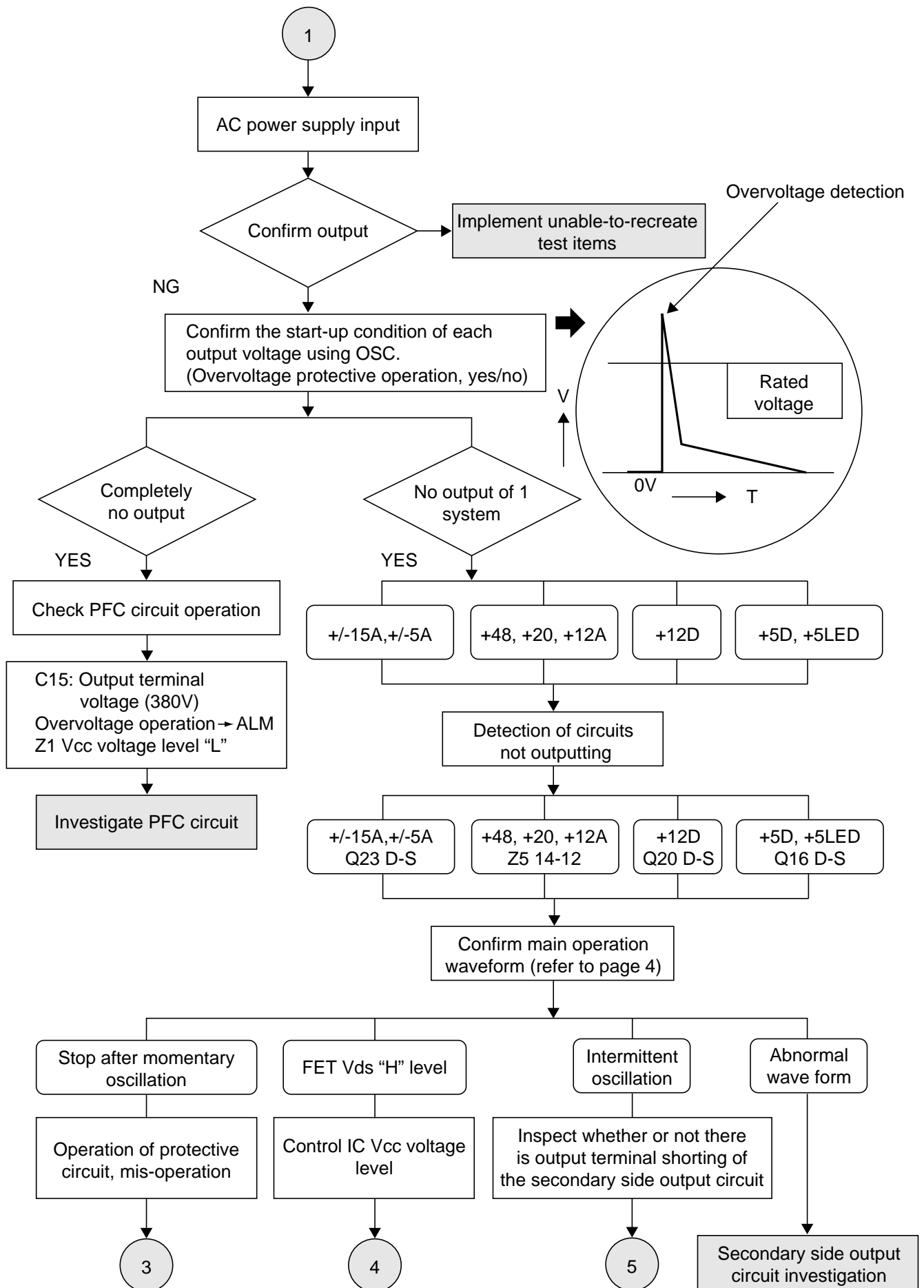

• **Main transistor operating waveform**

Test Conditions

Input voltage: 276 V Load: Rated

**1) +/-15A, +/-5A series
main operating waveform**

PKG 2 Q23 (Between D-S) 2SK2641

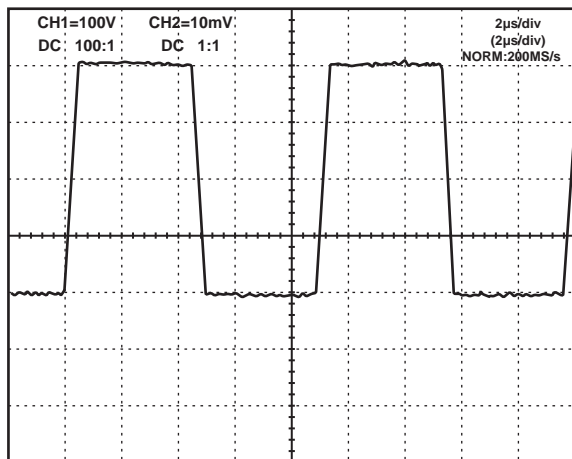

V:100V/Div H:2µs/Div

**2) +48A, +20A, +12A series
main operating waveform**

PKG 3 Z5 (Between 14-12) STR-Z1508

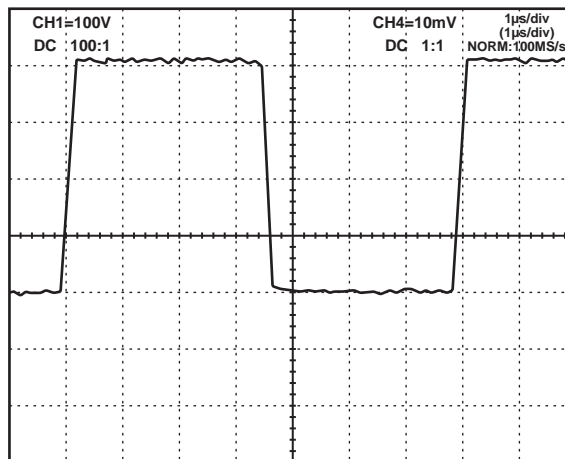

V:100V/Div H:1µs/Div

**3) +12D series
main operating waveform**

PKG 2 Q20 (Between D-S) 2SK2698

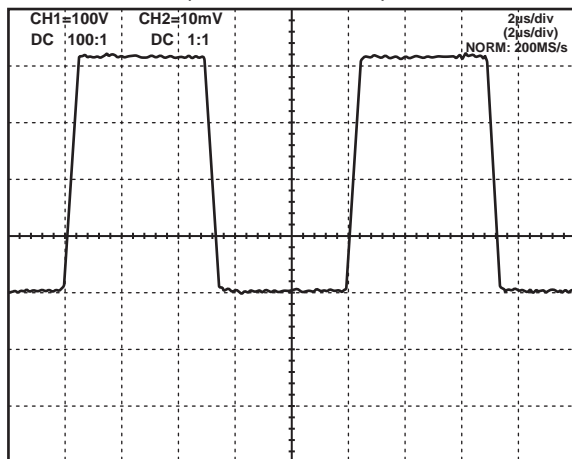

V:100V/Div H:2µs/Div

**4) +5D, +5LED series
main operating waveform**

PKG 2 Q16 (Between D-S) 2SK2641

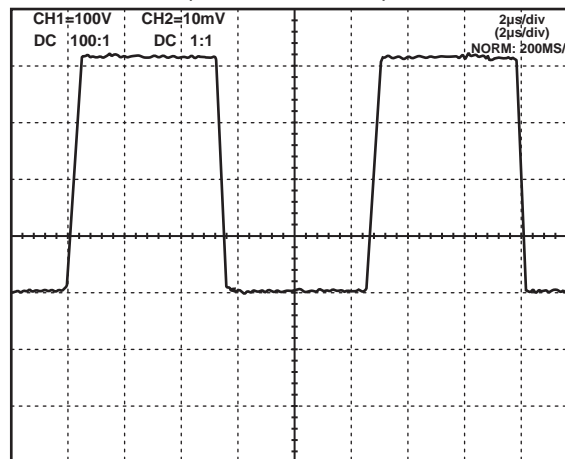

V:100V/Div H:2µs/Div

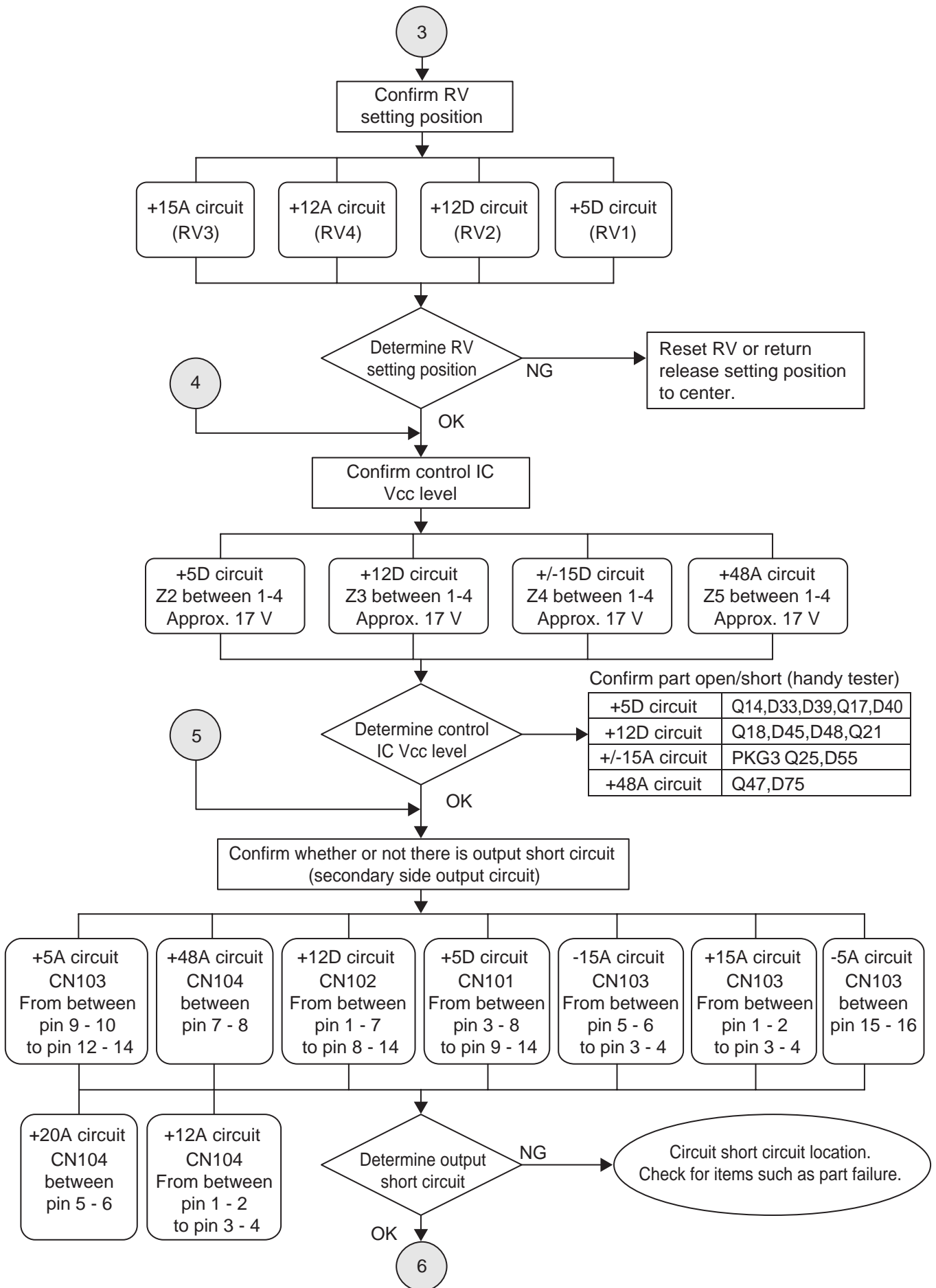

6

Check CD terminal

Confirm control IC CD terminal (2 pin) level
ALM → "H"

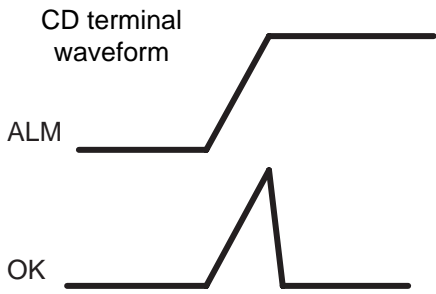

Circuit diagram	Measuring point	CD terminal voltage
+/-15A circuit	Z4 between 2-4	ALM operating Approx. 6V
+48A circuit	Z5 between 7-3	
+12V circuit	Z3 between 2-4	
+5V circuit	Z2 between 2-4	

Investigate secondary side output circuit

If CD terminal level "H", confirm circuits including control circuit as operation of the overvoltage protection circuit is most likely.

Since the failed parts are often semi-conductor parts, it is possible that the failure mode is open or shorted.

Confirm part open/short (handy tester)

Circuit diagram	Over voltage detection circuit	Voltage control circuit
+5D circuit	PKG2 PC3, D79	PC4, Z6
+12D circuit	PKG2 PC5, D82	PC6, D65, Q28
+/-15A circuit	PKG2 PC7, D88	D91, Q29
+20A circuit	PKG2 D101	- - - - -
+12A circuit	PKG2 PC9, D103	D109, Q38

Photocoupler confirmation Primary side

Feedback circuit (PC) operation level confirmation. Is secondary feedback operating normally?

Check photocoupler Secondary side

Confirm part open/short (handy tester)

Circuit diagram	Control photocoupler
+5D circuit	PKG2 PC3
+12D circuit	PKG2 PC6
+/-15A circuit	PKG2 PC8
+12A circuit	PKG2 PC10

Check auxiliary power supply level

Are the output voltage waveform for auxiliary voltage winding and power supply voltage normal?

Investigate primary side circuit

Control IC voltage waveform reference (refer to page 7)
Very few part failures are due to the windings on transformers and other parts.
(Semiconductor parts are the main cause.)

• **Control IC voltage waveform**

Test Conditions

Input voltage: 276 V Load: Rated

PKG1 Z1 between 19-10
(PFC circuit control IC)

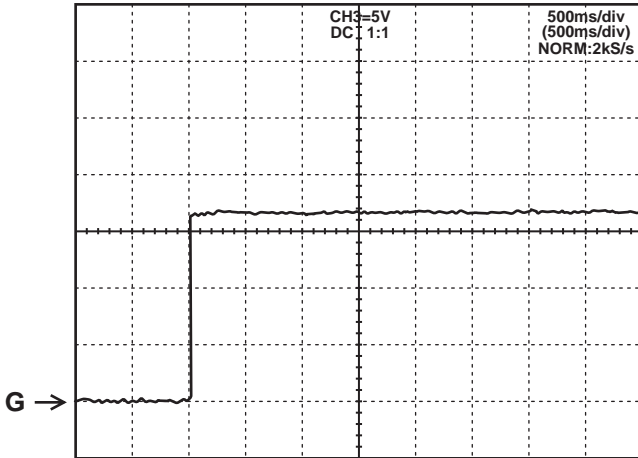

V: 5V/div H: 0.5S/div

PKG2 Z2 between 1-4
(+5D, +5LED circuit control IC)

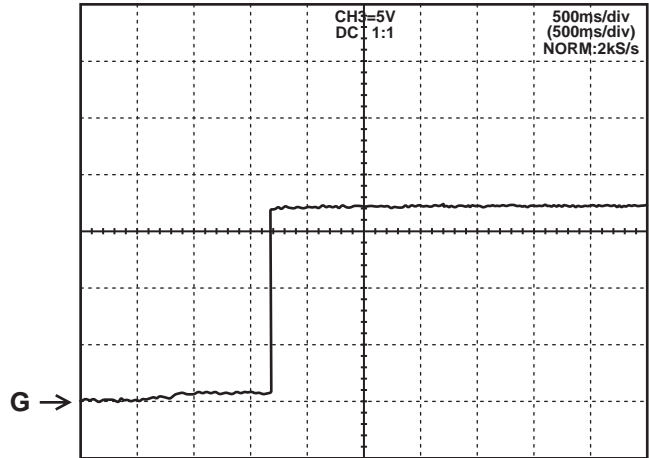

V: 5V/div H: 0.5S/div

PKG2 Z3 between 1-4
(+12D circuit control IC)

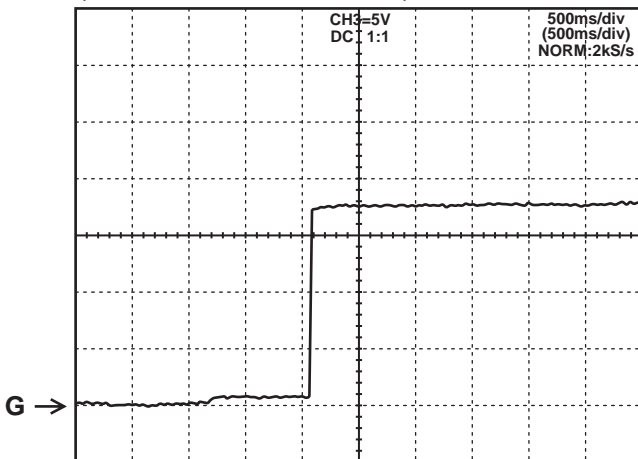

PKG3 Z4 between 1-4
(+/-15A, +/-5A circuit control IC)

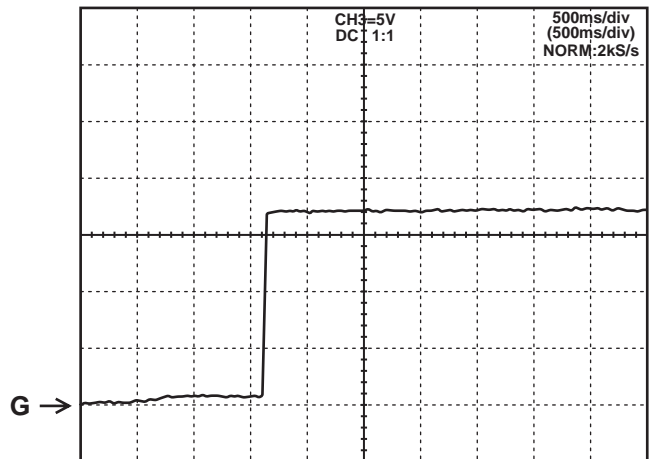

Investigate secondary side circuit

Abnormal voltage at output connector

1. Output voltage is low → Confirm VR position for output voltage setting → Is secondary side standard voltage abnormal?
2. Confirm pin output of output connector Connector contact or pin damage.
3. Confirm conductivity between secondary output to output connector.
4. Output ripple is big → Ripple hunching
5. Confirm secondary side output line of soldering graph, etc.

Investigate primary side circuit

Failure of primary side part

1. Confirm impedance among control IC terminals (Compare with normally operating parts, etc.)
2. Confirm semiconductor impedance (check for shorts, open circuits)
3. Confirm open for resistor parts?

Unable-to-recreate test items

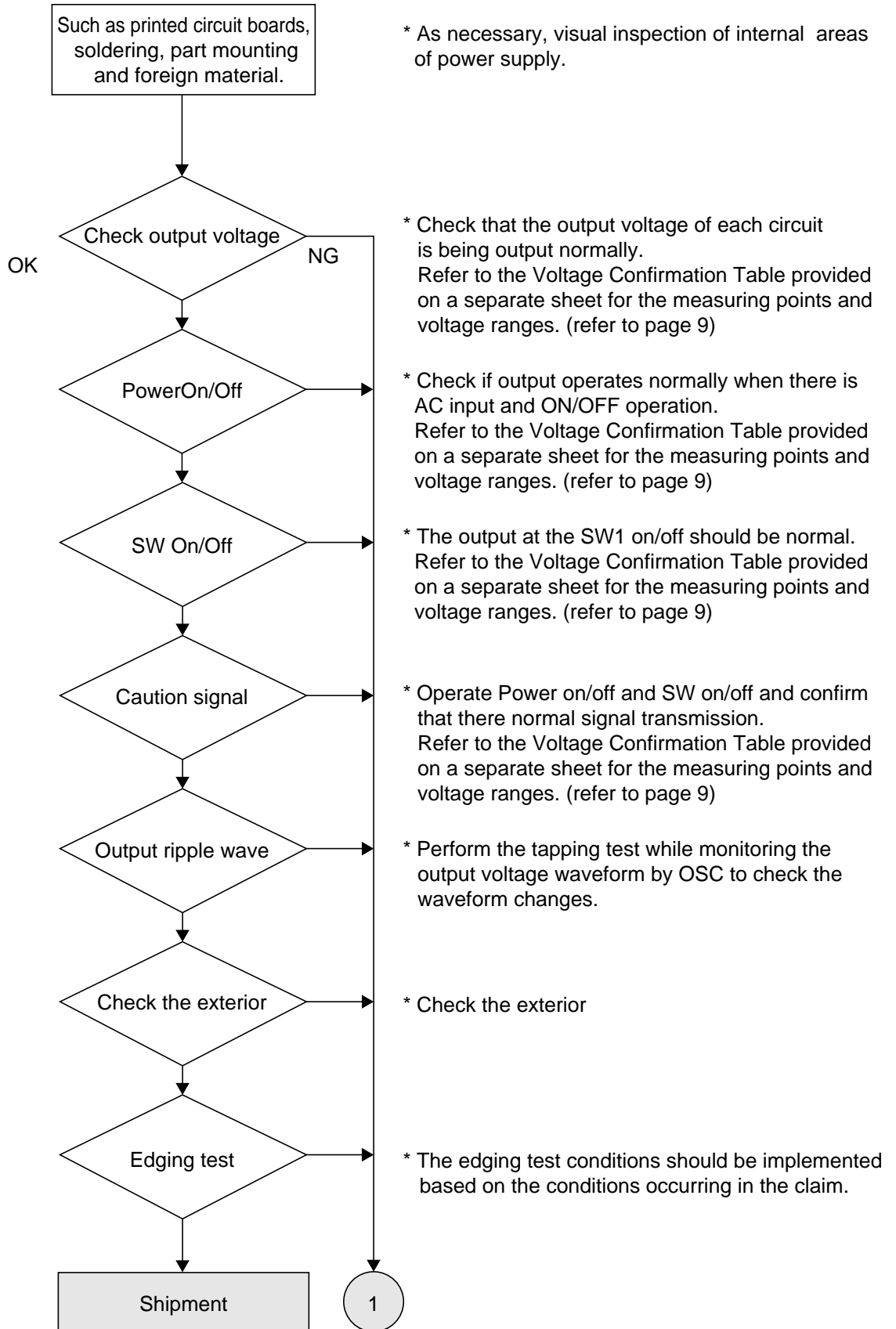

• **Voltage Confirmation Table**

Circuit name	Rated voltage	Output voltage range	Measuring point
+5D	5.0V	4.85V - 5.25V	CN101 From between pin 3-8 to 9-14
+12D	12.0V	10.8V - 13.2V	CN102 From between pin 1-7 to 8-14
+5A	5.0V	4.5V - 5.5V	CN103 From between pin 9-10 to 12-14
-5A	-5.0V	4.5V - 5.5V	CN103 Between pin 15-16
+15A	15.0V	13.5V - 16.5V	CN103 From between pin 1-2 to 3-4
-15A	-15.0V	13.5V - 16.5V	CN103 From between pin 5-6 to 3-4
+12A	12.0V	10.8V - 13.2V	CN104 From between pin 1-2 to 3-4
+20A	20.0V	18.0V - 22.0V	CN104 Between pin 5-6
+48A	48.0V	46.08V - 49.92V	CN104 Between pin 7-8

• **Confirm signal sending (AC OFF signal)**

Measuring point From CN104 pin 9 to between pin 3,4

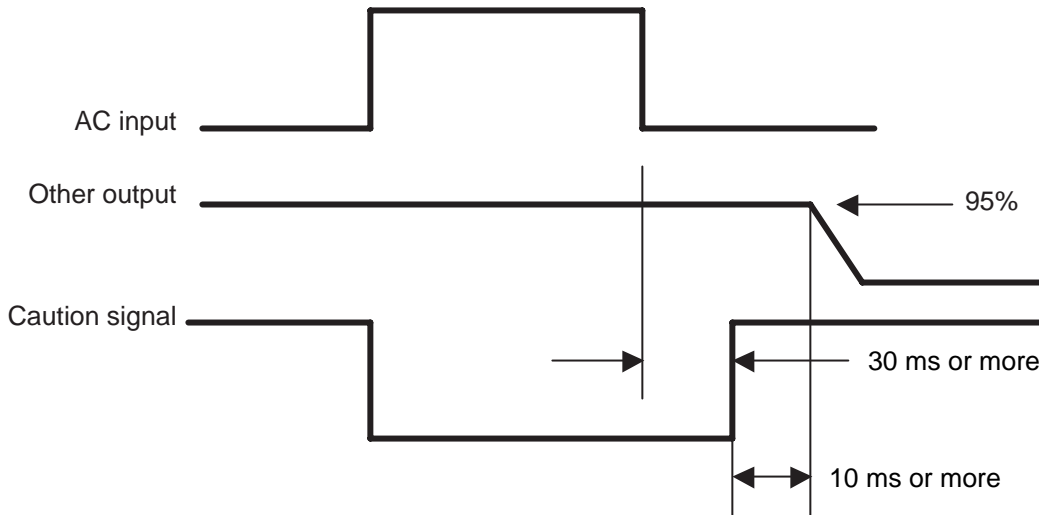

2H032W AC-DC POWER SUPPLY

Input filter section

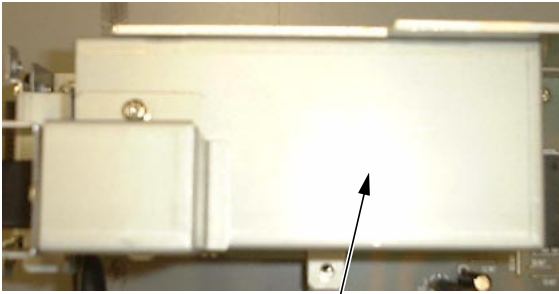

PFC block

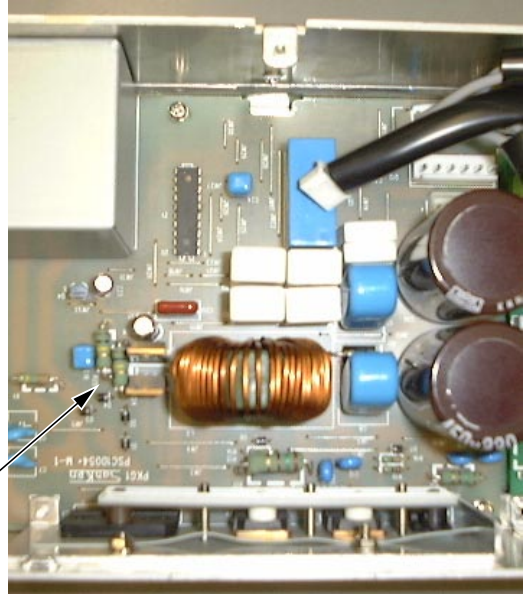

2H032W
AC-DC power supply



Primary side inverter block

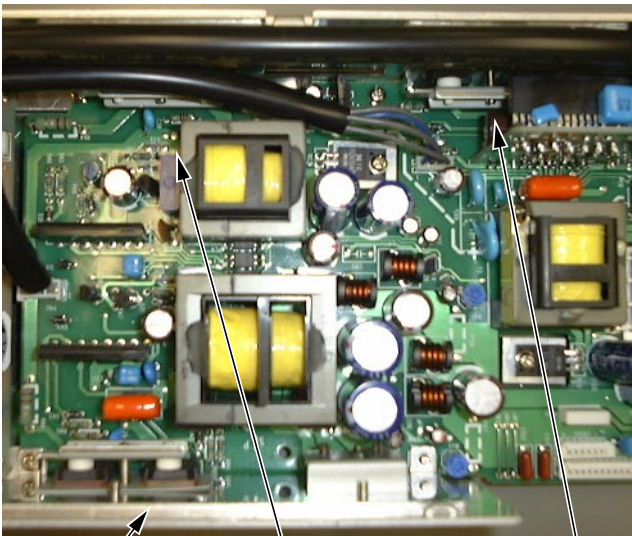

+12V
system circuit

+5V
system circuit

+5V, +/-15V
system circuit

Secondary side control circuit

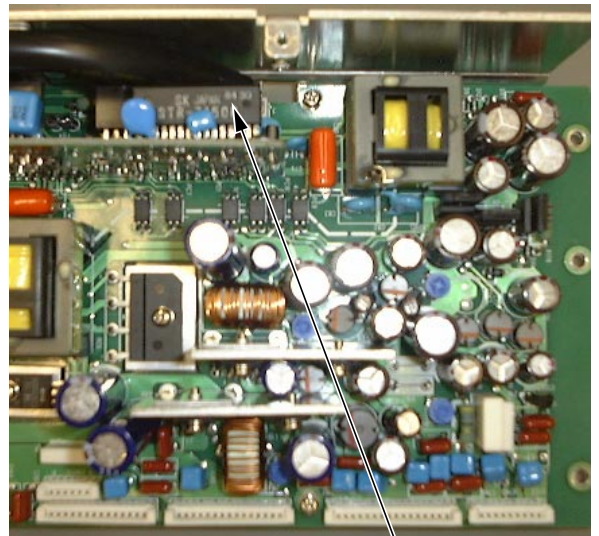

+48V, +20V
system circuit

Input filter section

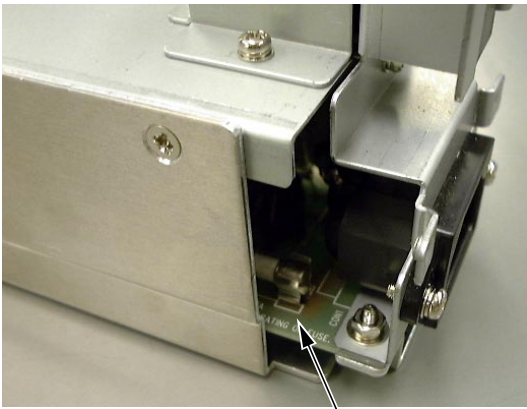

F1

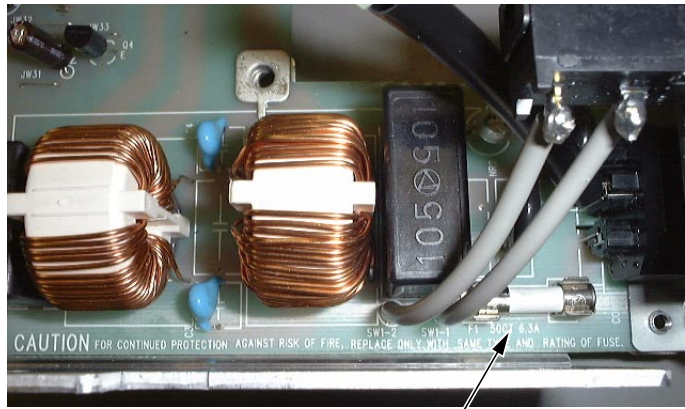

Input fuse (F1 Ceramic fuse 50CT063H)

PFC circuit block

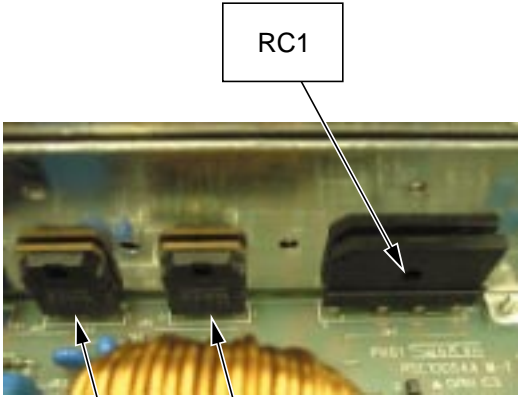

RC1

Q2

Q1

R2, 3

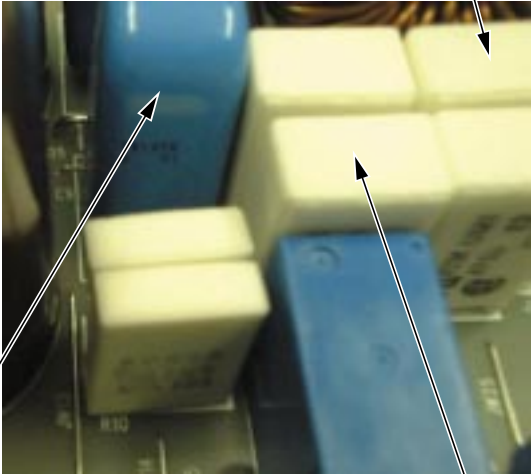

R10, 11

R4, 5

+5V system circuit block

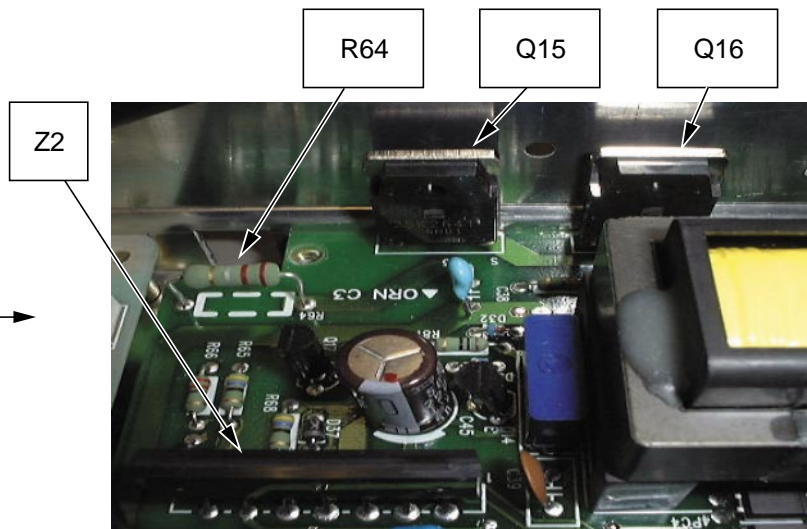

+12V system circuit block

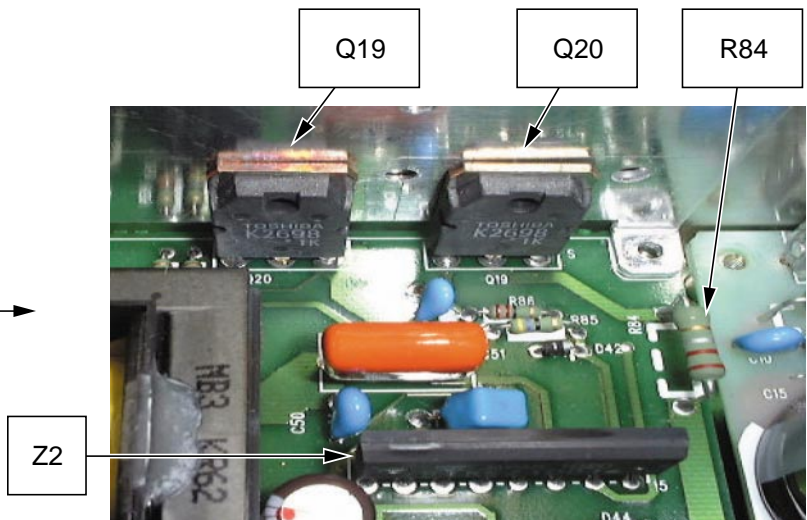

+5V, +/-15 system circuit block

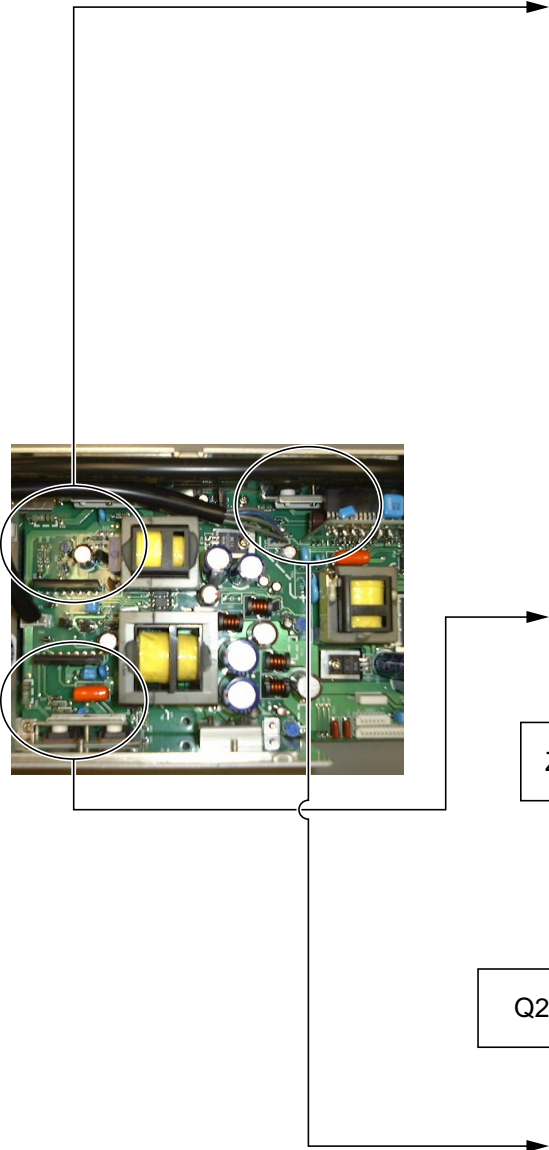
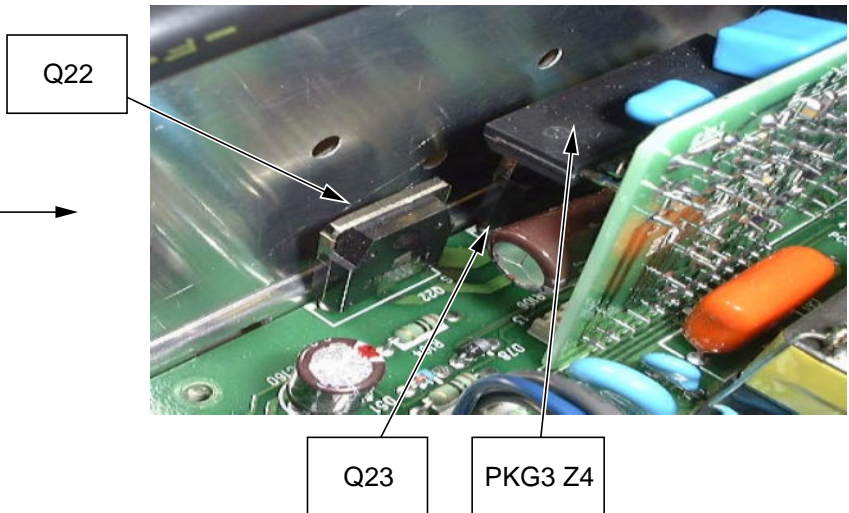

+48V, +20V system circuit block

PKG3 Z5

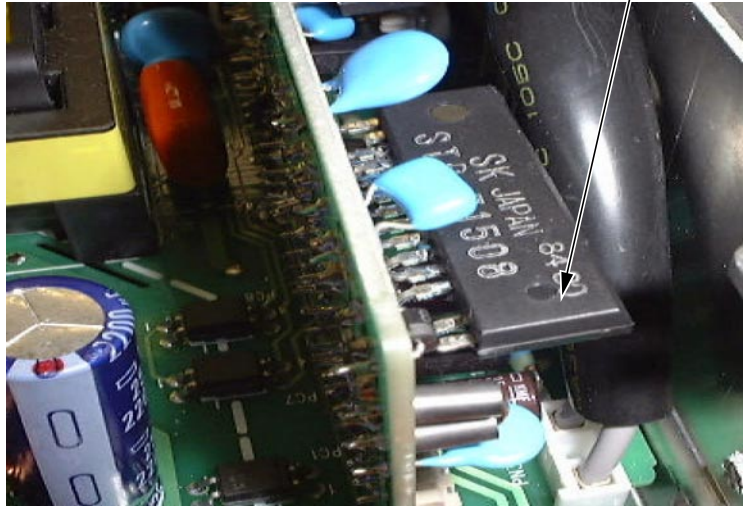

Each setting VR

RV6: -5A ADJ

RV4: +12A ADJ

RV5: +5A ADJ

RV3: +15A ADJ



RV1: +5V ADJ

RV2: +12D ADJ

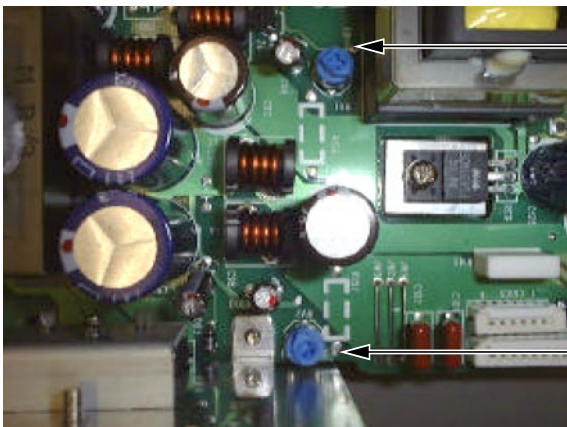

■ ABOUT ANALYSIS AND REPAIR OPERATIONS

1. Test Equipment

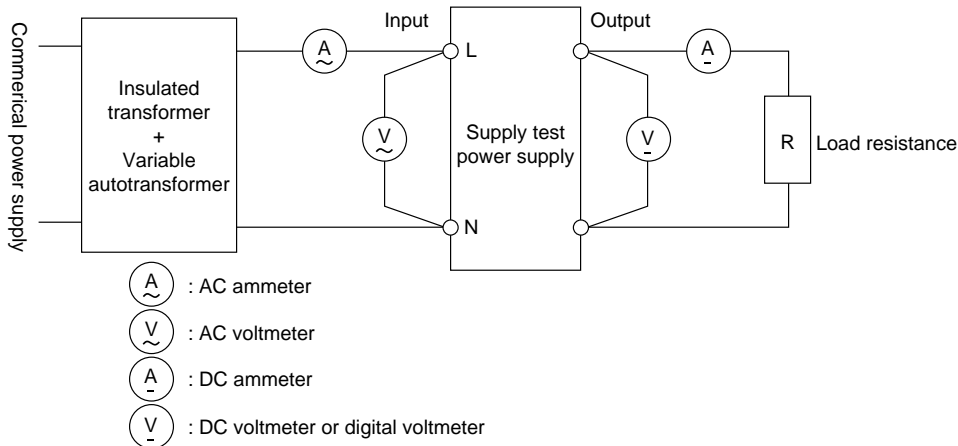

1-1. Equipment used for analysis and inspection

• Measuring equipment and equipment required during analysis

- 1) **Input equipment:**
 - Input insulation transformer → Ensuring safety during investigation
 - Input autotransformer → Ensuring safety during investigation (Implementing analysis while raising the input from 0V to the rated capacity.)
- 2) **Load equipment:** Simple inspection equipment → For checking output and performance operation confirmation
- 3) **Measuring equipment:** Synchroscope, DMM, Tester, etc. → For confirming waveform
Since the synchroscope input performs the primary circuit measuring, the insulation of the input line requires a 1:1 insulation transformer. In addition, it is recommended that an autotransformer be used for secondary damage prevention during analysis.

1-2. Part replacement and assembly jig preparation

Since this power supply uses a through-hole type printed circuit board, conventional soldering is difficult and an electric suction type tool is required. Moreover, a torque driver or similar equipment that can control tightening torque is required to control the torque during the mounting of the semiconductor and the assembly operations.

1-3. Confirming function and operation after repair

After repair and analysis, it is necessary to electrically confirm the repaired parts and the faulty locations that have been repaired as well as check that the operating functions have been completely repaired. Well it is possible to make the confirmation using the inspection jig for the analysis, simple testing equipment is probably required. While the items to be confirmed will vary according to the areas that failed and the conditions of repair, it is necessary to confirm the general characteristics and function operations by introducing a simple checker.

1-4. Confirmation items for soldering operations accompanying the replacement of parts

The skill required for the soldering should not be a problem for an experienced soldering technician. However, temperature will have to be controlled during the soldering process (to prevent thermal stress to the parts) and steps must be taken to prevent the effects of static electricity on the IC, FET and other such parts (including the storage conditions as well).

1-5. Confirming the function of the insulation after assembly

Insulation and withstand voltage testing is required prior to re-shipping the product to ensure that secondary defects (such as foreign objects or the wire damage) from the re-assembly after repair do not cause insulation impediments, insulation and withstand voltage testing is required prior to re-shipping the product. Insulation and withstand voltage testing equipment, testing jigs and preparation of the environment for the operation are indispensable requirements for the implementation of these tests.

At the very minimum, checking the insulation resistance is required to prevent the secondary defects shown above. This test requires a device for measuring the resistance of the insulation and cable for connecting to the product for easy inspection.

1-6. Pre-shipment inspection

Use an inspection jig to inspect and check the general characteristics and operating functions. Sanken Electric Company can prepare the documentation for the inspection procedures, etc.

1-7. Steps for products where symptoms could not be recreated

We are investigating the establishment of rules and inspection guidelines for products for which the symptoms could not be recreated on the results of the primary diagnoses based on the complaint information of the final user.

1-8. Managing historical data about repair parts

It is necessary to record and manage historical data about the conditions surrounding the failure, symptom treatment, lot number of the failed parts and replacement part numbers.

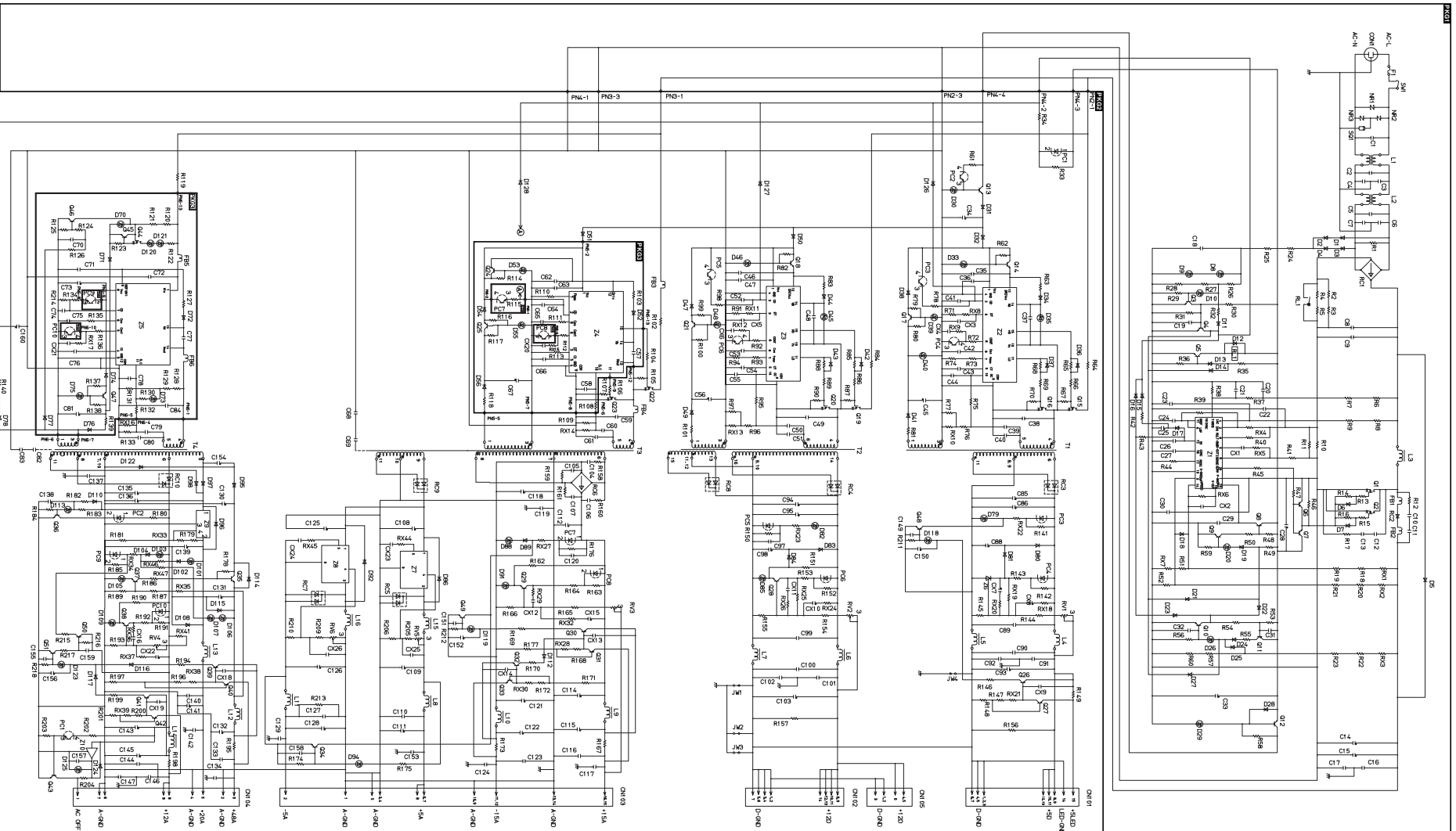

■ PARTS LIST

REF NO.	PART NO.	DESCRIPTION		REMARKS	QTY	RANK
	AAX40870	PS UNIT PARTS KIT	02R96			
F1		Circuit Board	PKG1			
Q1		Ceramic Fuse	AC250V 6.3A		1	
Q2		FET	2SK2915		1	
Q15		FET	2SK2915		1	
Q16		FET	2SK2641-01		1	
Q19		FET	2SK2641-01		1	
Q20		FET	2SK2698		1	
Q22		FET	2SK2698		1	
Q23		FET	2SK2641-01		1	
R2		Cement Resistor	5W 22 ohm		1	
R3		Cement Resistor	5W 22 ohm		1	
R4		Cement Resistor	5W 22 ohm		1	
R10		Cement Resistor	5W 0.02 ohm		1	
R11		Cement Resistor	5W 0.02 ohm		1	
R64		Metal Oxide Film Resistor	2W 0.22 ohm		1	
RC1		Rectifier	RBV-1506		1	
Z1		IC	L4981A		1	
Z2		IC	SMA-Z1001		1	
Z3		IC	SMA-Z1001		1	
		Circuit Board	PKG2			
R65		Metal Oxide Film Resistor	1/2W 47 ohm		1	
R66		Metal Oxide Film Resistor	1/2W 22 ohm		1	
R68		Metal Oxide Film Resistor	1/2W 47 ohm		1	
R69		Metal Oxide Film Resistor	1/2W 22 ohm		1	
R75		Carbon Resistor (chip)	1/10W 330 ohm		1	
R76		Carbon Resistor (chip)	1/10W 100 ohm		1	
R77		Carbon Resistor (chip)	1/10W 68 ohm		1	
R84		Metal Oxide Film Resistor	2W 0.22 ohm		1	
R85		Metal Oxide Film Resistor	1/2W 47 ohm		1	
R86		Metal Oxide Film Resistor	1/2W 22 ohm		1	
R88		Metal Oxide Film Resistor	1/2W 47 ohm		1	
R89		Metal Oxide Film Resistor	1/2W 22 ohm		1	
R95		Carbon Resistor (chip)	1/10W 180 ohm		1	
R96		Carbon Resistor (chip)	1/10W 47 ohm		1	
R97		Carbon Resistor (chip)	1/10W 68 ohm		1	
R102		Metal Oxide Film Resistor	2W 0.33 ohm		1	
R104		Metal Oxide Film Resistor	1/2W 10 ohm		1	
R106		Metal Oxide Film Resistor	1/2W 10 ohm		1	
R108		Carbon Resistor (chip)	1/10W 470 ohm		1	
R109		Carbon Resistor (chip)	1/10W 820 ohm		1	
R119		Metal Oxide Film Resistor	2W 0.68 ohm		1	
R132		Carbon Resistor (chip)	1/10W 330 ohm		1	
R133		Carbon Resistor (chip)	1/10W 470 ohm		1	
RX10		Carbon Resistor (chip)	1/10W 2.2 ohm - 1k ohm		1	
RX13		Carbon Resistor (chip)	1/10W 2.2 ohm - 1k ohm		1	
RX14		Carbon Resistor (chip)	1/10W 10 ohm -10k ohm		1	
RX16		Carbon Resistor (chip)	1/10W 10 ohm -10k ohm		1	
Z4		IC	SMA-Z1001		1	
Z5		IC	STR-Z1508		1	

*: New Parts

RANK: Japan only