

E1010

SERVICE MANUAL

FRONT PANEL

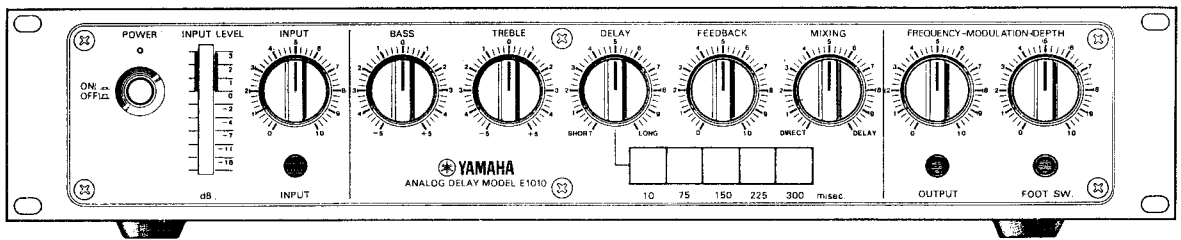

REAR PANEL

U.S.A Model

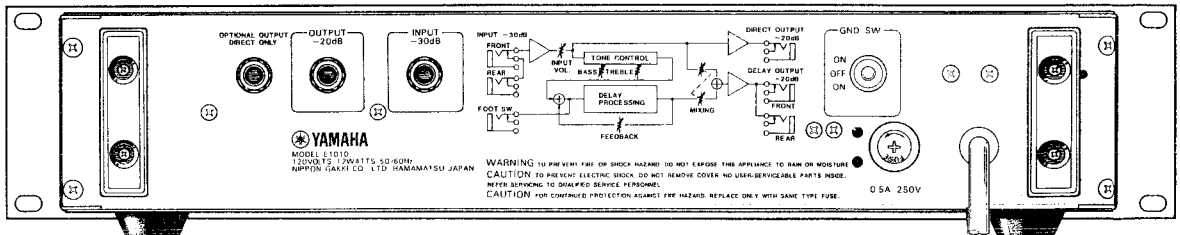

CANADIAN Model

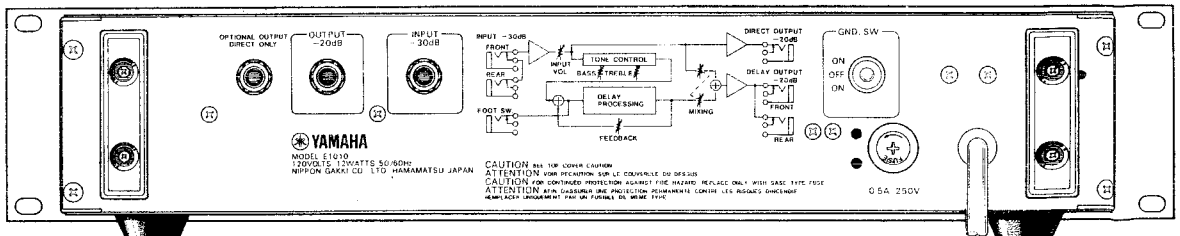

GENERAL Model

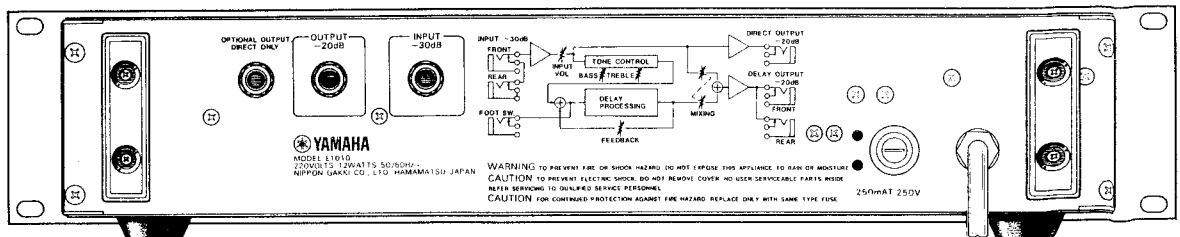

■ CONTENTS

DISASSEMBLY PROCEDURES	2
ELECTRICAL PERFORMANCE	3
ADJUSTMENT	4
ADJUSTING POINTS	5
BLOCK DIAGRAM/ SPECIFICATIONS	6
WIRING	7
SCHEMATIC DIAGRAM	8
CIRCUIT BOARDS	9
PARTS LIST	10
EXPLODED VIEW	11

■ DISASSEMBLY PROCEDURES

● REMOVAL OF TOP COVER

Unscrew the 7 screws (See Photo 1.)

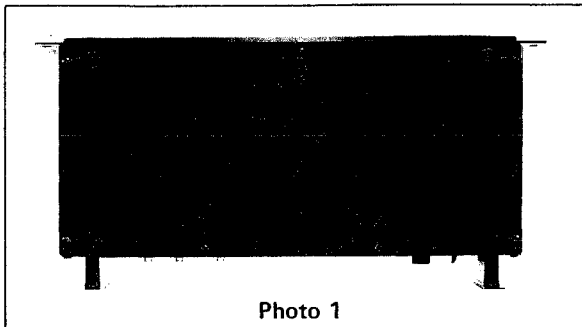

● REMOVAL OF BOTTOM COVER

Remove the 9 screws. (See Photo 2.)

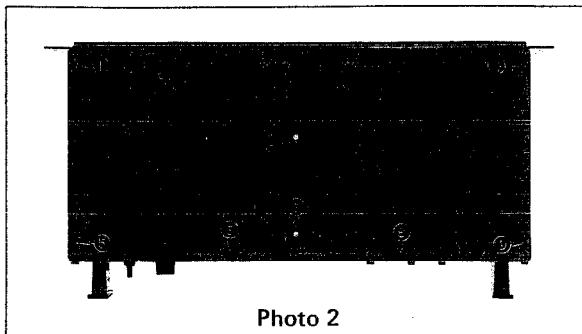

● REMOVAL OF BD CIRCUIT BOARDS

1. Pull out the INPUT, BASS, TREBLE, DELAY, FEEDBACK, MIXING, FREQUENCY and DEPTH controls toward this side.
2. Remove the 6 screws and dismount the escutcheon. (See Photo 3.)
3. After unscrewing the 6 screws with which the BD circuit board is fixed, disconnect the wiring (2 connectors) to the FP circuit boards and that to the power supply transformer.

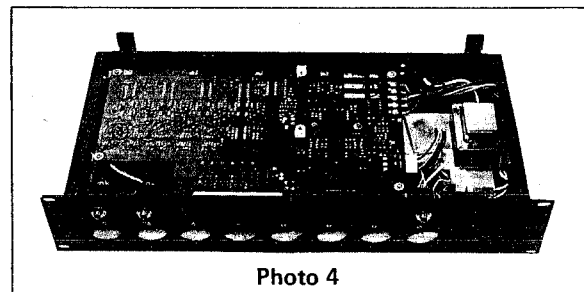
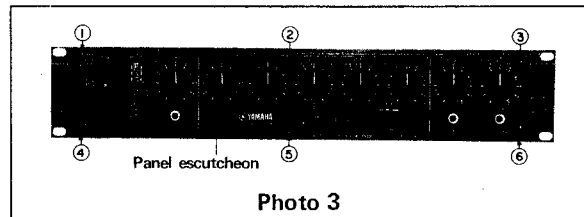

● REMOVAL OF FP CIRCUIT BOARD

1. Disconnect the 4 connectors wired to the circuit board and then take off the 7 screws. (Photo 5)
2. While gently pushing the upper side of the FP circuit board (2), lift up the FP circuit boards (1) and (2) and dismount them.

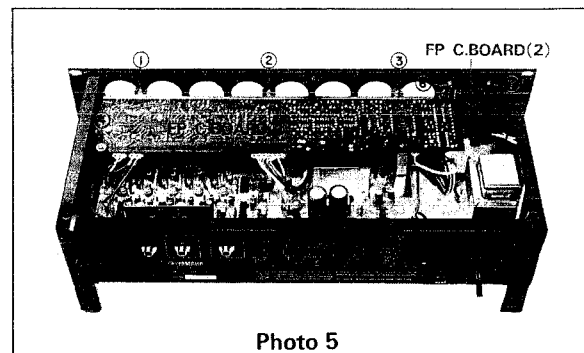

■ ELECTRICAL PERFORMANCE

When checking the electrical performances, the respective controls should be positioned as shown below, unless otherwise specified.

- INPUT & DELAY MAXIMUM
- BASS & TREBLE CENTER "0"
- FEEDBACK, FREQUENCY & DEPTH MINIMUM
- MIXING "DIRECT"
- LOAD RESISTANCE (OUTPUT & DIRECT OUT) Both 10kΩ

● GAIN

When a 700Hz/−30dBm sine wave is fed in from INPUT, output levels of −20±3dBm should be gained at DIRECT OUTPUT and OUTPUT. Next, turn the MIXING volume control to maximum (DELAY) from the state just mentioned and switch over the DELAY TIME selector switch in the order of 10, 75, 150, 225 and 300ms. Output levels of −20±3dBm should be obtained at the respective OUTPUTS.

● FREQUENCY CHARACTERISTICS

1. DIRECT OUTPUT

When a −30dBm sine wave is fed in from INPUT, the frequency characteristics of the output appearing at DIRECT OUTPUT should be as shown below at the 70Hz and 7kHz points, taking 700Hz as the standard level (0dB).

- 70Hz −0.3±1dB
- 7kHz 0±1dB

2. OUTPUT

Feed in a sine wave in the manner described in "1". The frequency characteristics of the output (direct signal) appearing at OUTPUT should be as shown below at the 70Hz and 7kHz points, taking 700Hz as the reference level.

- 70Hz −0.3±1dB
- 7kHz 0±1dB

Next, turn the MIXING volume control to maximum (DELAY) and switch over the DELAY TIME selector switch to the respective positions in the range between 10 and 300ms. The frequency characteristics of the output appearing at OUTPUT should be within the range shown in the following table at the 50Hz and 3kHz points, taking 700Hz as the reference level.

Delay time selector SW.	10ms	75ms	150ms	225ms	300ms
50Hz	−0.8±2	−0.8±2	−0.8±2	−0.8±2	−0.8±2
3kHz	+0.3±2	−0.3±2	−2.5±2	−3.1±2	−4.0±2

(Unit=dB)

Table-1

● TONE CONTROL

With the MIXING volume control set to maximum

(DELAY) and the DELAY TIME selector switch set to 10ms, apply a −30dBm sine wave from INPUT.

Next, turn down the BASS and TREBLE controls, respectively, from maximum to minimum. The output levels should be as shown in the table given below, taking 700Hz as the reference level (700Hz =0dB at the center of both BASS and TREBLE).

BASS, TREBLE	70Hz	700Hz	7kHz
Centre	−0.8±2	0	−1.5±2
Min.	−12.8±2	−1.0±1.5	−14.0±2
Max.	+11.8±2	+1.0±1.5	+12.0±2

(Unit=dB)

Table-2

● MAXIMUM OUTPUT

When a 700Hz/−13dBm sine wave is applied to INPUT, the input wave forms of OUTPUT and DIRECT OUTPUT should not be clipped.

Next, turn the MIXING volume control to maximum (DELAY). The output wave forms should neither be clipped at the respective positions selected by the DELAY TIME selector switch, nor should they show any abnormality such as loss, or oscillation. (THD: 5%, or less)

● DELAY TIME

Delay time should be within the ranges shown in the following table, when the MIXING volume control is turned to maximum (DELAY) and the DELAY TIME selector switch is switched over to the respective positions.

Delay time selector SW.	10ms	75ms	150ms	225ms	300ms
	9.3ms ^{+10%} _{−0%}	75ms ^{+10%} _{−0%}	150ms ^{+10%} _{−0%}	225ms ^{+10%} _{−0%}	300ms ^{+10%} _{−0%}

Table-3

When the DELAY volume control is turned to minimum (SHORT) with the selector switch set to 300ms, the delay time should not be more than 130ms.

● NOISE LEVEL

When the INPUTS (both of FRONT and REAR) are open, the noise levels for both DIRECT OUTPUT and OUTPUT should not be more than −78 dBm.

Next, turn the MIXING volume control to maximum (DELAY). The noise levels should not be more than the values listed in the following table when the DELAY TIME selector switch is changed over to the respective positions.

Delay time selector SW.	10ms	75ms	150ms	225ms	300ms
Noise level	−78	−78	−77	−76	−76

(Unit=dBm)

Table-4

■ ADJUSTMENT

BD CIRCUIT BOARD

● POWER SUPPLY VOLTAGE ADJUSTMENT

1. Adjust VR1 so that the voltage between the -15 terminal and E terminal will be $-15 \pm 0.1V$.
2. Adjust VR2 so that the voltage between the $+15$ terminal and E terminal will be $+15 \pm 0.1V$.

● ADJUSTMENT OF CLOCK FREQUENCY

1. Set DELAY and DEPTH controls to minimum.
2. Adjust VR3 in a manner to make the oscillation frequency appearing at the CP terminal 27.3 ± 0.5 kHz.

● ADJUSTMENT OF BIAS VOLTAGE

1. Apply a 700Hz sine wave from the IN terminal.
2. After connecting an oscilloscope to the OUT terminal, change over the DELAY TIME selector switch to 75ms.
3. Turn up the input level from 0 to about 10dBm while observing the wave form, and adjust VR4 so that the upper and lower sides of the output wave form will be clipped simultaneously.
4. Adjust similarly, using VR5 for 150ms, VR6 for 225ms and VR7 for 300ms.

● ADJUSTMENT OF GAIN

1. Feed in a 700Hz/ -20 dBm sine wave from the IN terminal.
2. Change over the DELAY TIME selector switch to 10ms. Adjust VR8 so that -17.5 ± 0.5 dBm will be fed out from the OUT terminal.
3. Adjust similarly, using VR9 for 75ms, VR10 for 150ms, VR11 for 225ms and VR12 for 300ms.

FP CIRCUIT BOARD

BEFORE STARTING ADJUSTMENT OF FP CIRCUIT BOARD

- Set the FEEDBACK volume control to minimum and the other controls to maximum.
- Insert a $10k\Omega$ load resistor to DIRECT OUTPUT and OUTPUT.
- With the DELAY TIME selector switch kept in an un-depressed state, short-circuit the COMP terminal and EXP terminal. Then, insert a $100k\Omega$ resistor between the short-circuited terminal and the E terminal.

● SETTING OF LED LEVEL

1. Apply a 700Hz/ -30 dBm sine wave from INPUT.
2. Adjust VR1 so that the INPUT LEVEL indicators (6 pieces) will illuminate up to 0dB.
3. Next, confirm that all the LEDs will glow when -25 dBm is applied, and all of them will go out when the input volume control is turned down to minimum.

● ADJUSTMENT OF COMPANDOR DISTORTION

1. Feed in a 700Hz/ -10 dBm sine wave from INPUT.
2. Adjust VR2 so as to make the distortion factor at the COMP terminal 0.9%, or less. (Adjustment of compressor distortion)
3. Similarly, apply a 700Hz/ -10 dBm sine wave and adjust VR3 so that the distortion factor at OUTPUT will be 0.3%, or less. (Adjustment of expander distortion)

● ADJUSTMENT OF LFO

After connecting a frequency counter to the LFO terminal, adjust VR4 so that the LFO frequency will be 15 ± 1 Hz.

● CONFIRMATION AND CHANGEOVER OF AC POWER SUPPLY VOLTAGE (for General Models only)

Check whether the working AC power supply voltage is 220V, or 240V. In the case the working AC power supply voltage does not agree with the position of the VOLTAGE selector switch, the switch should be changed over in the manner described below. (Refer to Fig. 1.)

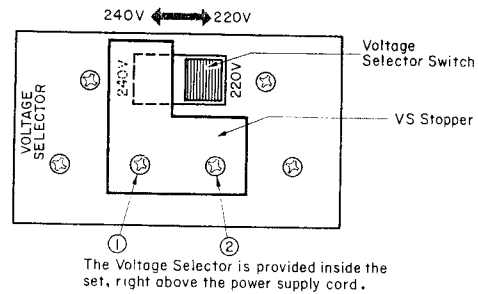

Fig. 1

- (1) Unscrew the 2 screws (① and ②) shown in Fig. 1, and dismount the VS stopper.
- (2) Switch over the VOLTAGE selector switch to the position that corresponds to the working power supply voltage.
- (3) Turn over the VS stopper and fix it back into position using the 2 screws (① and ②). (Refer to Fig. 2.)

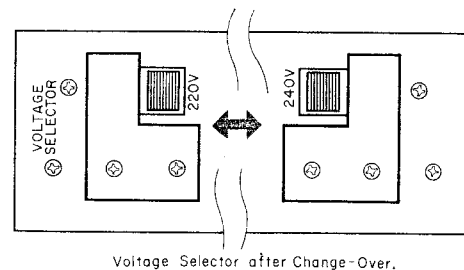
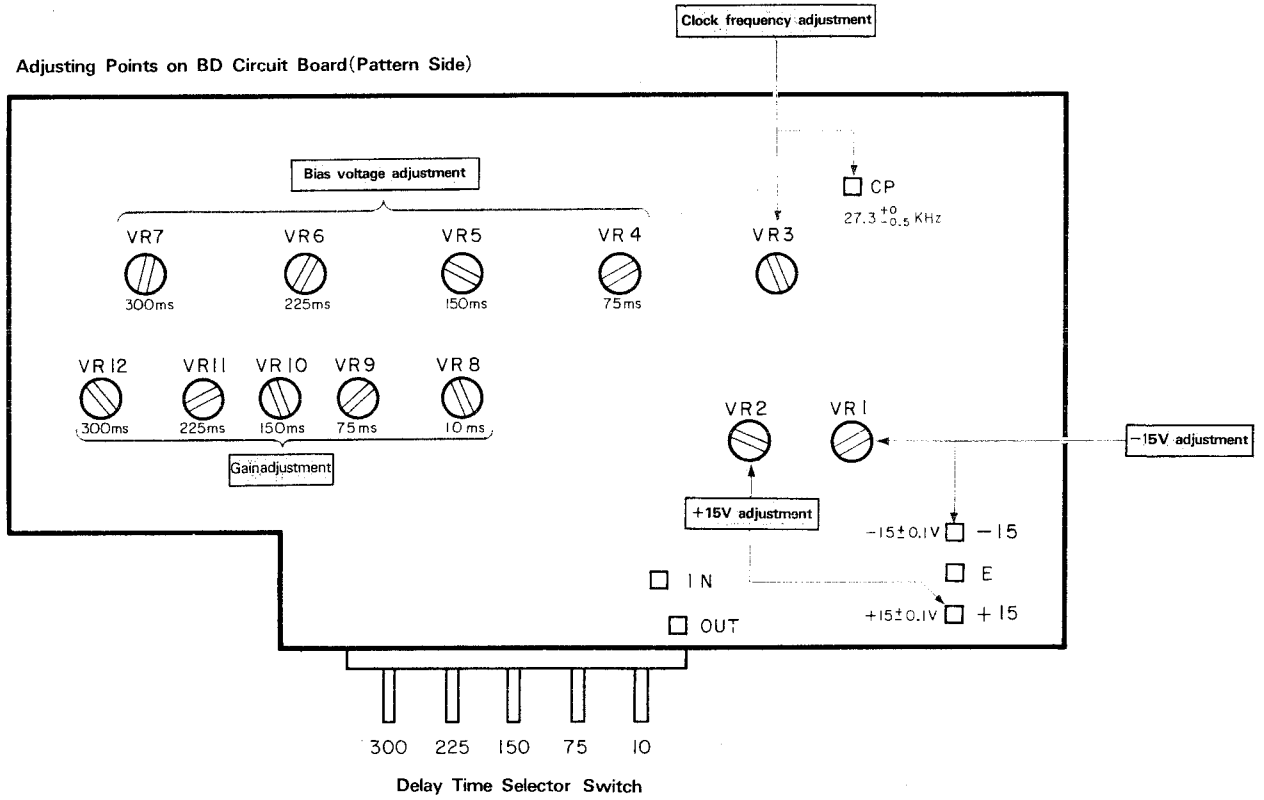

Fig. 2

ADJUSTING POINTS

Adjusting Points on BD Circuit Board (Pattern Side)



Adjusting Points on FP Circuit Board (Pattern Side)

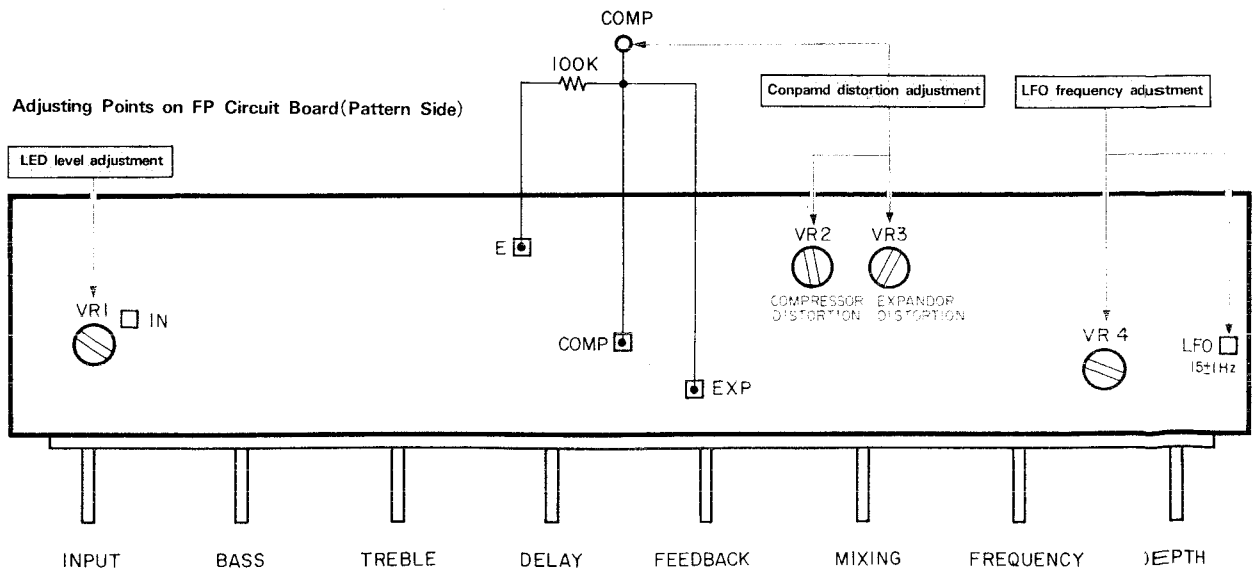

BLOCK DIAGRAM

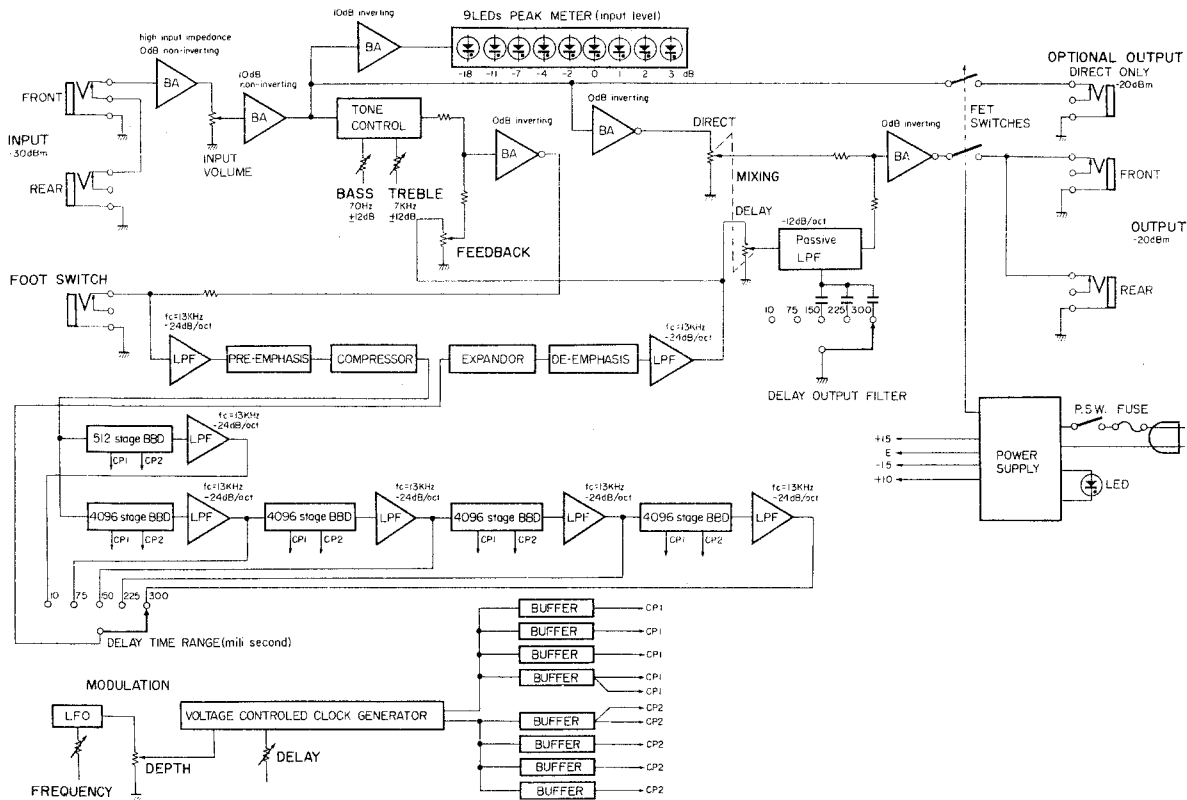

SPECIFICATIONS

DIRECT ONLY OUTPUT

TOTAL HARMONIC DISTORTION
 INTERMODULATION DISTORTION
 FREQUENCY RESPONSE
 HUM and NOISE (20 Hz to 20 KHz)
 SIGNAL-to-NOISE RATIO

Less than 0.1% -10 dBm/10 kΩ (20 Hz to 20 kHz)
 Less than 0.5% (70 Hz, 7 kHz) -10 dBm/10 kΩ
 ±1/3 dB (20 Hz to 20 kHz)
 -100 dBm (equivalent input noise)
 70 dB input vol. max.

OUTPUT

TOTAL HARMONIC DISTORTION
 INTERMODULATION DISTORTION
 FREQUENCY RESPONSE
 HUM and NOISE (20 Hz to 20 KHz)*

Less than 2% -10 dBm/10 kΩ (1 kHz)
 Less than 3% (70 Hz, 7 kHz) -20 dBm/10 kΩ, Delay time 10m sec.
 ±3 dB (30 Hz to 8 kHz) Delay time 10m sec.
 ±3 dB (30 Hz to 2 kHz) Delay time 300m sec.
 -87 dB INPUT vol. max., MIXING vol. max., Delay time 10m sec.
 -87 dB INPUT vol. max., MIXING vol. max., Delay time 300m sec.

INPUT CONTROLS

DELAY CONTROLS

INPUT volume

MIXING volume (DIRECT, DELAY)

tone CONTROLS

BASS 70 Hz (±12 dB)

TREBLE 7 kHz (±12 dB)

DELAY time

10m sec. range (3 ~ 10m sec.)

75m sec. range (25 ~ 75m sec.)

150m sec. range (50 ~ 150m sec.)

225m sec. range (75 ~ 225m sec.)

300m sec. range (100 ~ 300m sec.)

FEEDBACK volume

MODULATION

FREQUENCY (0.5 Hz ~ 10 Hz)

DEPTH (0 ~ 10% Delay time 10m sec.)

(0 ~ 30% Delay time 300m sec.)

FOOT SWITCH (Phone Jack)

INPUT -30 dBm/800 kΩ (Phone Jack, unbalanced)

OUTPUT -20 dBm/250 Ω (Phone Jack, unbalanced)

OPTIONAL OUTPUT, DIRECT ONLY

-20 dBm/250 Ω (Phone Jack, unbalanced)

POWER SUPPLY

U.S.A. and CANADIAN MODELS

Rated voltage 120V 50/60 Hz

Rated power consumption 12W

Primary fuse 0.5A 250V

GENERAL MODEL

Rated voltage 220V/240V 50/60 Hz

Rated power consumption 12W

Primary fuse 250 mA 250V

DIMENSION (W x H x D)

480 x 93 x 243 mm (19 x 3-2/3 x 9-1/2 in.)

WEIGHT

4.5 kg (10 lb.)

* Measured with -6 dB/oct filter a 12.47 KHz equivalent to a 20 KHz filter with infinite dB/oct attenuation.

WIRING

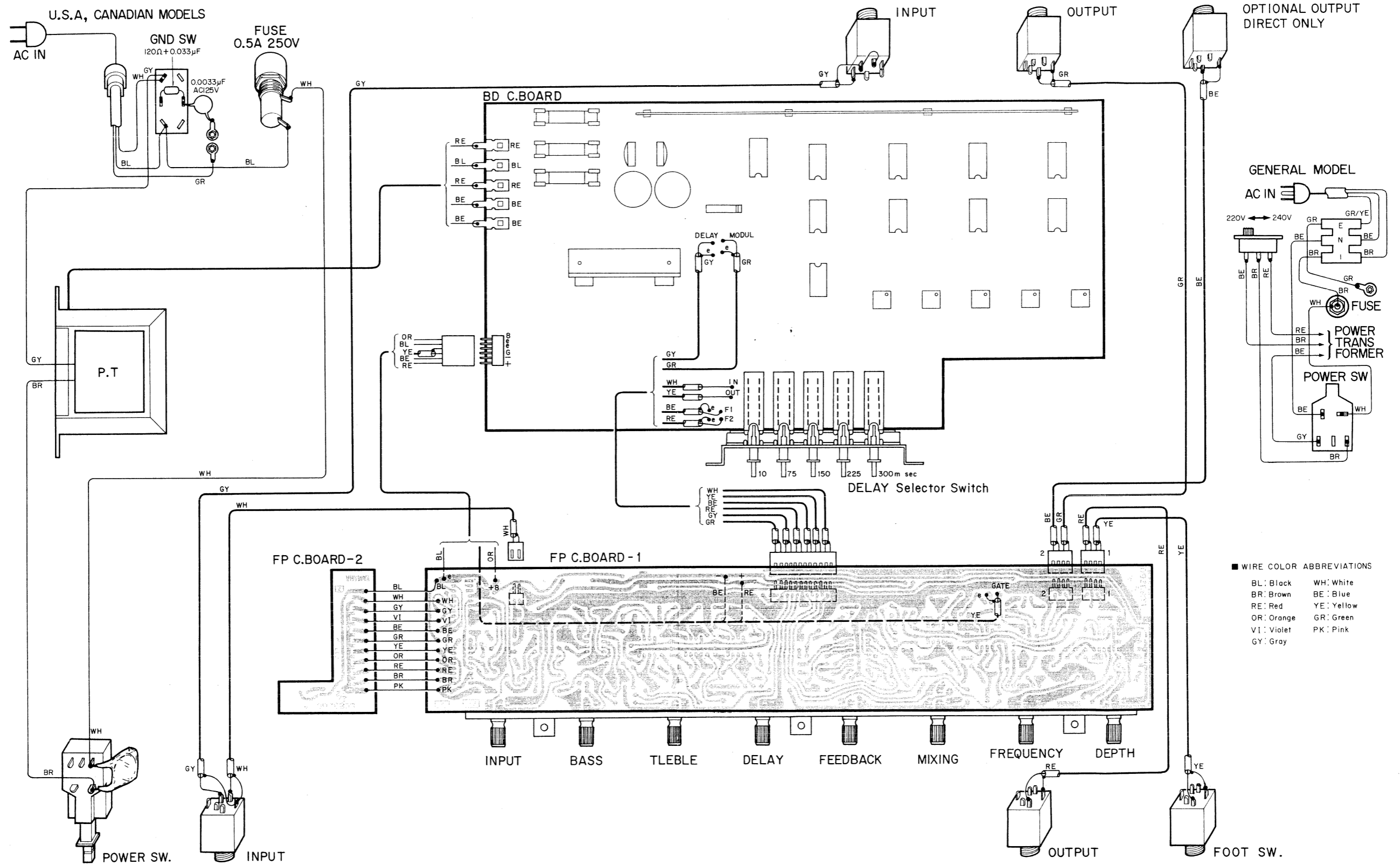

SCHEMATIC DIAGRAM

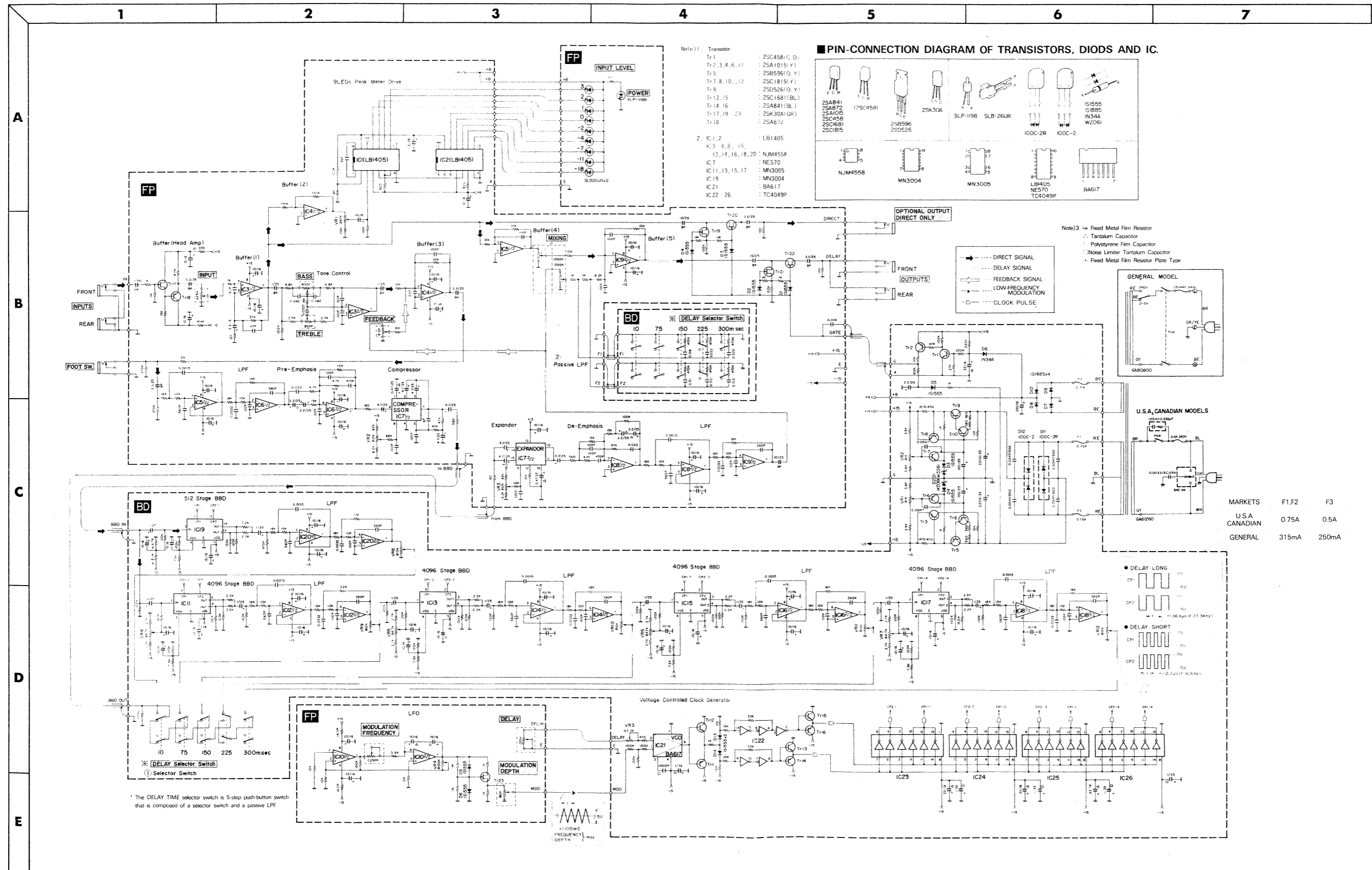

PARTS LIST

※：新部品/New Parts

Ref. No.	Part No.	Description	(部 品 名)	Remarks	Markets
※ 1	30 54 00 AA 80 83 00	Stay	ステー		
※ 2	30 54 00 AA 80 83 10	Holder, Board	シートホルダー		
※ 3	30 54 00 AA 80 83 30	Holder, P.SW	P.SW.金具		
※ 4	30 54 00 AA 80 83 50	Rear Panel	リアパネル		J
※	30 54 00 AA 80 83 60	-do.-	"		U
※	30 54 00 AA 80 83 70	-do.-	"		C
※	30 54 00 AA 80 84 00	-do.-	"		G
※ 5	30 54 00 AA 80 84 30	Side Cover -Left-	側板(左)		
※ 6	30 54 00 AA 80 84 40	Side Cover -Right-	側板(右)		
※ 7	30 54 00 AA 80 84 50	Top Cover	天板		J,U,G
※	30 54 00 AA 80 88 70	-do.-	"		C.
※ 8	30 54 00 AA 80 84 60	Bottom Cover	底板		
※ 9	30 54 00 AA 80 85 00	Holder, Top Cover	天板受金具		
※ 10	30 54 00 AA 80 85 10	Holder Metal, FP Board	FPシート受金具		
※ 11	30 54 00 AA 80 85 20	Holder, BD Board	BDシートホルダー		
※ 12	30 54 00 AA 80 85 30	Holder, FP Board	FPシートホルダー		
※ 13	30 54 00 AA 80 91 50	Shield Board	シールド板		
※ 14	30 54 00 BA 80 33 70	Panel	パネル		
15	40 10 00 CB 06 86 30	Cord Stopper	コードストッパー		J
	40 10 00 CB 07 06 90	-do.-	"		G
	40 10 00 CB 81 12 30	-do.-	"		U.C.
16	30 54 00 CB 80 12 70	Leg	ゴム脚		
17	30 54 00 CB 81 18 20	Cord Reel	コードリール		
※ 18	30 54 00 CB 81 23 70	Knob	ツマミ		
※ 19	30 54 00 CB 81 23 80	Push Button	プッシュボタン		
※ 20	30 54 00 CB 81 23 90	Panel Escutcheon	パネルエスカッション		
※ 21	30 54 00 CB 81 24 10	Plate, LED	LEDプレート		
※ 22	30 54 00 CB 81 24 30	Spacer(A), LED	LEDスペーサー (A)		
※ 23	30 54 00 CB 81 24 70	Spacer(B), LED	" (B)		
24	30 54 00 CB 06 65 10	Push Button, Power SW.	プッシュボタン (パワーSW)		
25	40 10 00 EA 03 01 60	Pan Head Screw 3×16 ZMC2-Y	ナベ小ネジ		
26	40 10 00 ED 03 00 60	Bind Screw 3×6 ZMC2-Y	バインド小ネジ		
27	40 10 00 ED 03 01 20	-do.- 3×12 -do.-	"		
28	40 10 00 ED 03 01 60	-do.- 3×16 -do.-	"		
29	40 10 00 ED 04 00 60	-do.- 4×6 -do.-	"		
30	40 10 00 ED 33 00 60	-do.- 3×6 ZMC2-BL	"		
31	40 10 00 ED 33 00 80	-do.- 3×8 -do.-	"		
32	40 10 00 ED 34 00 80	-do.- 4×8 -do.-	"		
33	40 10 00 EF 34 01 20	Oval Head Screw 4×12 -do.-	丸皿小ネジ		
34	40 10 00 Ei 34 01 00	Bind Tapping Screw 4×10 ZMC2-BL	バインドタッピングネジ		
35	40 10 00 EV 10 00 30	Hexagonal Nut 3φ ZMC2-Y	六角ナット		
36	40 10 00 EV 10 00 40	-do.- 4φ -do.-	"		
37	40 10 00 EV 20 30 40	Flat Washer 4φ ZMC2-BL	平座金		
38	40 10 00 EV 30 00 40	Spring Lock Washer 4φ ZMC2-Y	バネ座金		
39	40 10 00 EV 41 00 30	Toothed Lock Washer 3φ -do.-	歯付座金		

J: Japanese, G: General, U: U.S.A., C: Canadian

※：新部品/New Parts

Ref. No.	Part No.	Description	(部 品 名)	Remarks	Markets
40	40 10 00 EV 41 00 40	Toothed Lock Washer 4φ ZMC2-BL	歯付座金		
41	40 10 00 EV 43 00 30	-do- 3φ -do-	"		
42	40 10 00 EV 43 00 40	-do- 4φ ZMC2-Y	"		
43	40 10 00 EV 43 00 90	-do- 9φ -do-	"		
44	40 10 00 Fi 18 33 30	Ceramic Capacitor 0.0033μF125V	セラコン		U.C
45	40 10 00 FZ 00 01 10	Spark Killer 500V 0.33	スパークキラーコンデンサ		J.U
	40 10 00 FZ 00 09 50	-do- 2CA-120033	"		C
※	40 10 00 GA 80 78 00	Power Transformer	トランス		J
※	40 10 00 GA 80 80 00	-do-	"		G
※	40 10 00 GA 81 26 00	-do-	"		U.C
47	40 10 00 HL 32 71 00	Metal Oxide Film Resistor 10KΩ2P	酸金抵抗		U.C
48	40 10 00 KA 30 03 50	Toggle Switch	トグルSW		U.
	40 10 00 KA 30 04 40	-do-	"		C.
49	40 10 00 KA 80 02 20	Push Switch SDG-5P 125V10A	プッシュSW		J.
	40 10 00 KA 80 02 00	-do- SDG-5P TV-5	"		U.C
	40 10 00 KA 80 06 90	-do- SDG-5P-E	"		G
50	40 10 00 KB 00 03 10	Fuse 0.5A250V	ヒューズ		J
	40 10 00 KB 00 06 40	-do- 250mAT 250V	"		G
	40 10 00 KB 00 10 10	-do- UL SS-2 0.5A 250V	"		U.C
51	40 10 00 LA 00 02 90	Lug Terminal	アースラグ		U.C
52	40 10 00 LA 00 07 60	-do-	カラー端子板		J
53	40 10 00 LB 20 04 90	Fuse Holder	ヒューズホルダー		J.U.C
	40 10 00 LB 20 05 90	-do-	"		G
54	40 10 00 LX 20 00 10	Flat Washer 9φ FNM3	特殊平座金		
55	40 10 00 LX 20 00 20	Hexagonal Nut 9φ FNM3	特殊六角ナット		
56	40 10 00 MG 00 06 00	AC Cord	電源コード		J
	40 10 00 MG 00 02 70	-do-	"		U.C
	40 10 00 MG 00 04 50	-do-	"		G
※	30 54 00 NA 80 42 70	BD Board #83252	BDシート		J.C
※	30 54 00 NA 80 42 80	-do-	"		U
※	30 54 00 NA 80 42 90	-do-	"		G
※	30 54 00 NA 80 43 00	FP Board	FPシート		
59	40 10 00 AA 03 15 80	Washer-Fuse Holder	ヒューズホルダーワッシャー		G
60	30 54 00 AA 80 78 30	Holder-Insulator	インシュレーター取付金具		G
61	30 54 00 AA 80 82 40	Holder Terminal	ボイポ端子取付金具		G
62	40 10 00 CB 80 66 30	VS Stopper	VSストッパー		G
63	40 10 00 CB 80 68 40	VS Insulator	VSインシュレーター		G
64	40 10 00 KA 40 04 10	Slide Switch ESD-39	スライドSW		G
65	40 10 00 LA 00 10 40	Terminal	ボイポ端子		G
66	40 10 00 LA 00 21 90	Wire Holder	ワイヤーホルダー		G
※	40 10 00 LB 20 15 40	Phone Jack	ホーンジャック		

※：新部品/New Parts

Ref. No.	Part No.	Description	(部 品 名)	Remarks	Markets
※	30 54 00 NA 80 42 70	BD Board #83252	BDシート		J.C
※	30 54 00 NA 80 42 80	-do.-	"		U
※	30 54 00 NA 80 42 90	-do.-	"		G
※	30 54 00 AA 80 91 40	Holder, BD Board	BDシートホルダー		
※	30 54 00 BA 80 33 80	Heat Sink	放熱板		
※	40 10 00 FP 13 72 20	Tantalum Capacitor 22 μ F 16V	タンタルコン		
※	40 10 00 FP 35 61 00	-do.- 1 μ F 35V	"		
※	40 10 00 HL 31 54 70	Metal Oxide Film Resistor 0.47 1P	酸化抵抗		
※	40 10 00 HT 41 00 20	Variable Resistor B1K Ω	ソリッドVR		
※	40 10 00 HT 41 00 40	-do.- B4.7K Ω	"		
※	40 10 00 HT 41 00 70	-do.- B10K Ω	"		
※	40 10 00 HT 41 01 20	-do.- B470 Ω	"		
※	40 10 00 HU 57 64 70	Metal Film Resistor 4.7K Ω \pm 1%	金皮抵抗		
※	40 10 00 HU 57 65 10	-do.- 5.1K Ω \pm 1%	"		
※	40 10 00 i A 08 41 10	Transistor 2SA841	トランジスター		
※	40 10 00 i A 10 15 20	-do.- 2SA1015	"		
※	40 10 00 i B 05 96 20	-do.- 2SA596	"		
※	40 10 00 i C 04 59 00	-do.- 2SC459	"		
※	40 10 00 i C 16 81 20	-do.- 2SC1681	"		
※	40 10 00 i C 18 15 20	-do.- 2SC1815	"		
※	40 10 00 i D 05 26 10	-do.- 2SD526	"		
※	40 10 00 i F 00 00 10	Diode 1N34A	ダイオード		
※	40 10 00 i F 00 00 40	-do.- 1S1555	"		
※	40 10 00 i F 00 03 20	-do.- WZ061	"		
※	40 10 00 i G 00 12 60	I.C. TC4049P	I.C.		
※	40 10 00 i G 00 13 90	-do.- NJM4558	"		
※	40 10 00 i G 00 14 10	-do.- BA617	"		
※	40 10 00 i G 02 54 00	-do.- MN3004	"		
※	40 10 00 i G 03 12 00	-do.- MN3005	"		
※	40 10 00 i H 00 00 50	Diode 10DC-2	ダイオード		
※	40 10 00 i H 00 01 30	-do.- 10DC-2R	"		
※	40 10 00 i H 00 02 40	-do.- 1S1885	"		
※	40 10 00 KA 80 09 30	Push Switch	プッシュSW 5連		
※	40 10 00 KB 00 03 10	Fuse 0.5A 250V	ヒューズ		J
※	40 10 00 KB 00 03 20	-do.- 0.75A 250V	"		J
※	40 10 00 KB 00 06 40	-do.- 250mAT 250V	"		G
※	40 10 00 KB 00 06 50	-do.- 0.5AT 250V	"		G
※	40 10 00 KB 00 10 10	-do.- ULSS-2 0.5A 250V	"		U.t.
※	40 10 00 KB 00 12 20	-do.- ST-4 0.75A 250V	"		U.t.
※	40 10 00 LB 20 13 90	2.5Pitch Base Pin	2Pトップ型ベース付ポスト		
※	40 10 00 LB 60 28 20	6P Side Base Pin	6Pサイド型ベース付ポスト		

※：新部品/New Parts

Ref. No.	Part No.	Description	(部 品 名)	Remarks	Markets
※	30:54:00:NA:80:43:00	FP Board #83262	FPシート		
※	30:54:00:AA:80:83:40	Sub-Panel	サブパネル		
※	30:54:00:CB:81:24:20	Holder,LED	LEDホルダー		
	40:10:00:FM:11:61:00	Bipolar Electrolytic Cap. 1 μ F/50V	B.P.ケミコン		
	40:10:00:FM:22:61:00	-do.- 1 μ F/25V	"		
	40:10:00:FM:22:63:30	-do.- 3.3 μ F/25V	"		
	40:10:00:FM:22:71:00	-do.- 10 μ F/25V	"		
	40:10:00:FP:14:62:20	Tantalum Capacitor 2.2 μ F/25V	タンタルコン		
	40:10:00:FP:15:54:70	Tantalum Capacitor 0.47 μ F/35V	タンタルコン		
	40:10:00:FP:33:71:50	-do.- 15 μ F/16V	"		
	40:10:00:FP:84:61:50	-do.- 1.5 μ F/25V	"		
	40:10:00:HL:31:61:00	Metal Oxide Film Resistor 1K Ω 1P	酸化抵抗		
※	40:10:00:HS:31:04:90	Variable Resistor 16 ϕ A25K Ω	ボリューム		
※	40:10:00:HS:31:05:00	-do.- 16 ϕ B10K Ω	"		
※	40:10:00:HS:31:05:10	-do.- 16 ϕ B50K Ω	"		
※	40:10:00:HS:31:05:20	-do.- 16 ϕ C250K Ω	"		
※	40:10:00:HS:31:05:30	-do.- 16 ϕ ZD5K Ω	"		
※	40:10:00:HS:31:05:40	-do.- 16 ϕ D50K Ω ZD50K Ω	"		
	40:10:00:HT:41:00:70	-do.- B10K Ω	ソリッドボリューム		
	40:10:00:HT:41:00:90	-do.- B100K Ω	"		
	40:10:00:HT:41:01:40	-do.- B47K Ω	"		
	40:10:00:HW:79:52:20	Fuse Resistor 220 Ω 33mA	プレート抵抗		
	40:10:00:iA:08:72:00	Transistor 2SA872	トランジスター		
	40:10:00:iE:00:00:10	FET 2SK30A	FET		
	40:10:00:iF:00:00:40	Diode 1S1555	ダイオード		
	40:10:00:iF:00:04:90	LED SLP-1198	LED		
※	40:10:00:iF:00:12:80	-do.- SLB26UR	"		
	40:10:00:iG:00:13:90	IC NJM4558	IC		
※	40:10:00:iG:03:13:00	-do.- NE570	"		
※	40:10:00:iG:03:14:00	-do.- LB1405	"		
	40:10:00:LB:20:14:10	2P Side Base Pin	2Pサイド型ベース付ポスト		
	40:10:00:LB:40:05:90	4P -do.-	4P "		
	40:10:00:LB:60:29:10	6P -do.-	12P "		
	40:10:00:BB:00:44:30	2.5Pitch Contact Pin	2.5ピッチコンタクトピン		
	40:10:00:LB:20:13:80	Housing 2P	ハウジング2P		
	40:10:00:LB:40:05:60	Housing 4P	ハウジング4P		
	40:10:00:LB:60:28:10	Housing 6P	ハウジング6P		
	40:10:00:LB:60:29:20	Housing 12P	ハウジング12P		