

EM-300

SERVICE MANUAL

FRONT PANEL

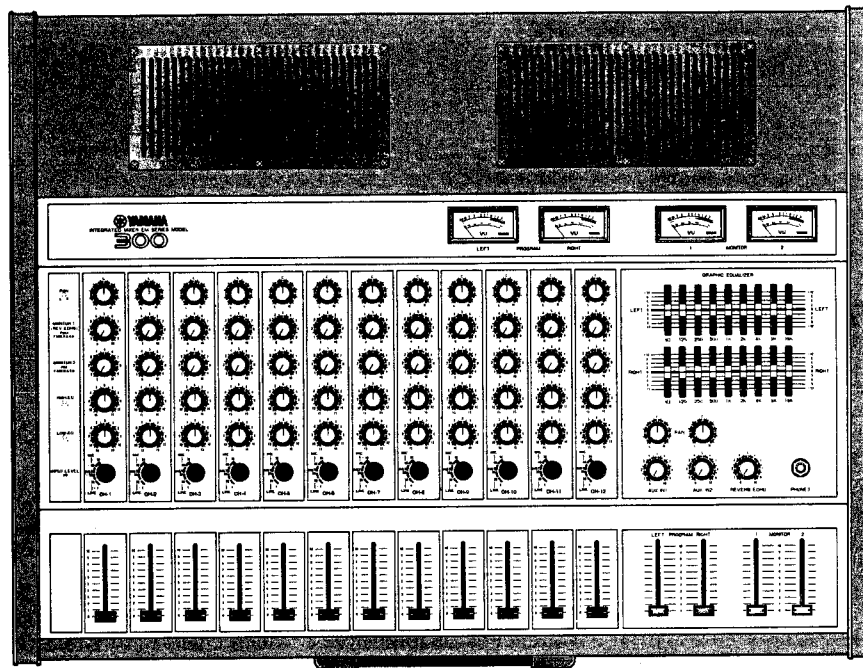

REAR PANEL

USA & CANADIAN MODELS

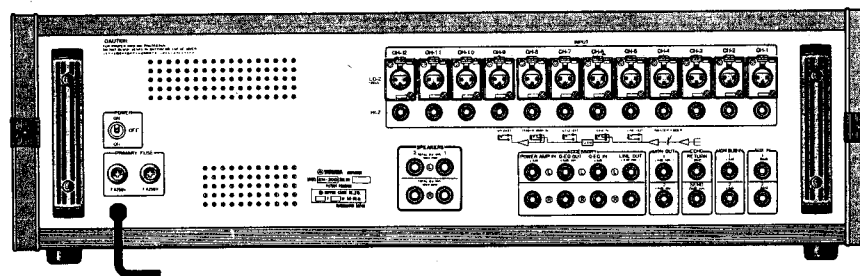

CONTENTS

OVERALL SPECIFICATIONS	2	PRINTED CIRCUIT BOARD	6
INPUT/OUTPUT SPECIFICATION	2	BLOCK DIAGRAM	12
GENERAL ADJUSTMENT AND CHECK SPECIFICATIONS	3	SCHEMATIC DIAGRAM	13
		PARTS LIST	14

OVERALL SPECIFICATION

Channel controls (CH1 ~ CH12)	PAN MONITOR 1 (REV/ECHO) MONITOR 2 HIGH-EQ LOW-EQ INPUT LEVEL switch (-50/-40/-30/-20/+4) Channel faders
Master controls	AUX IN controls, AUX PAN (1, 2) REVERB/ECHO controls MONITOR master faders (1, 2) PROGRAM master faders (L, R) GRAPHIC EQUALIZER (L, R)
Others	VU meters x 4 (PROGRAM x 2, MONITOR x 2)
Power output	200W per channel (4 Ω, 1kHz, 0.5%) 140W per channel (8 Ω, 1kHz, 0.5%)
Frequency response	20Hz to 15kHz 0 ± 1dB (60W, 8 Ω) 20Hz to 30kHz 0 +1dB -3dB (60W, 8 Ω)
Total harmonic distortion	Less than 0.2% (1kHz, 120W, 8 Ω) Less than 0.5% (20Hz ~ 20kHz, 120W, 8Ω)
Intermodulation distortion	Less than 0.5% (70Hz : 7KHz = 4 : 1 at 60W, 8 Ω)
Hum and noise level (20Hz to 20kHz)	-118dB (Equivalent Input Noise)

Maximum gain	SPEAKERS (L, R) 81dB (CH IN + SPEAKER OUT) MON OUT (1, 2) 54dB (CH IN + MON OUT) ECHO SEND 30dB (CH IN + ECHO SEND) LINE OUT (L, R) 54dB (CH IN + LINE OUT) G-EQ OUT 54dB (CH IN + G-EQ OUT) AUX IN (1, 2) 51dB (AUX IN + SPEAKER OUT)
Equalizer	LOW-EQ ±15dB (100Hz) HIGH-EQ ±15dB (10kHz) GRAPHIC-EQ ±12dB (63Hz/125Hz/250Hz/500Hz/1kHz/2kHz/4kHz/8kHz/16kHz)
Power supply	U.S.A. & CANADIAN MODELS: AC120V, 4A, 50/60Hz GENERAL MODELS: AC220/240V, 900W, 50/60Hz
Dimensions (W x D x H)	787 x 631 x 229 mm (31 x 24-3/4 x 9")
Weight	35 kg (77 lbs)

* Specifications subject to change without notice.

INPUT/OUTPUT SPECIFICATION

• Input jacks

Connection	Actual Load Impedance	For Use w/Nominal	Sensitivity (at max. gain)	Input level		Connector
				Nominal	Max. before Clip	
INPUTS (1 ~12 CH) -50 -40 -30 -20 + 4	Hi-Z 10KΩ Lo-Z 600Ω	Hi-Z 3KΩ Lo-Z 150Ω	-50dB (2.5mV) -40dB (7.8mV) -30dB (25mV) -20dB (78mV) + 4dB (1.23V)	-50dB (2.5mV) -40dB (7.8mV) -30dB (25mV) -20dB (78mV) + 4dB (1.23V)	-22dB (6.2mV) -12dB (193mV) - 2dB (616mV) + 8dB (1.93V) +32dB (31V)	XLR-3-31 and Phone Jack
AUX IN (1, 2)	30KΩ	5KΩ	-20dB (78mV)	-20dB (78mV)		Phone Jack
ECHO RETURN	30KΩ	5KΩ	-30dB (25mV)	-30dB (25mV)		Phone Jack
GEQ IN (L, R)	100KΩ	5KΩ	+ 4dB (1.23V)	+ 4dB (1.23V)	+18dB (6.2V)	Phone Jack
POWER AMP IN (L, R)	30KΩ	5KΩ	+ 4dB (1.23V)			Phone Jack
MON SUB IN (1, 2)	30KΩ	5KΩ	+ 4dB (1.23V)	+ 4dB (1.23V)	+24dB (12.3V)	Phone Jack

• Output jacks

Connection	Actual Source Impedance	For Use w/Nominal	Output level		Connector
			Nominal	Max. before Clip	
SPEAKER OUT (L, R)	0.065Ω	4Ω 8Ω	200W 140W		Phone Jack
LINE OUT (L, R)	1KΩ	10KΩ 600Ω	+ 4dB (1.23V) 0dB (0.775V)	+18dB (6.2V) +14dB (3.9V)	Phone Jack
GEQ OUT (L, R)	1KΩ	10KΩ 600Ω	+ 4dB (1.23V) 0dB (0.775V)	+18dB (6.2V) +14dB (3.9V)	Phone Jack
MON OUT (1, 2)	390Ω	10KΩ 600Ω	+ 4dB (1.23V) 0dB (0.775V)	+18dB (6.2V) +14dB (3.9V)	Phone Jack
ECHO SEND	100Ω	10KΩ	-20dB (78mV)	- 6dB (0.39V)	Phone Jack
PHONES	150Ω	8Ω		+ 2dB (0.96V)	Stereo Phone Jack

Note: All the inputs and outputs are unbalanced.

GENERAL ADJUSTMENT AND CHECK SPECIFICATIONS

- Use an oscilloscope and a level meter with an input impedance of over 500 kΩ for the measurements.
- Use a filter with a bandwidth of 20 Hz to 20 kHz in the level meter for noise level measurements. (12.47 kHz filter or IHF-C)

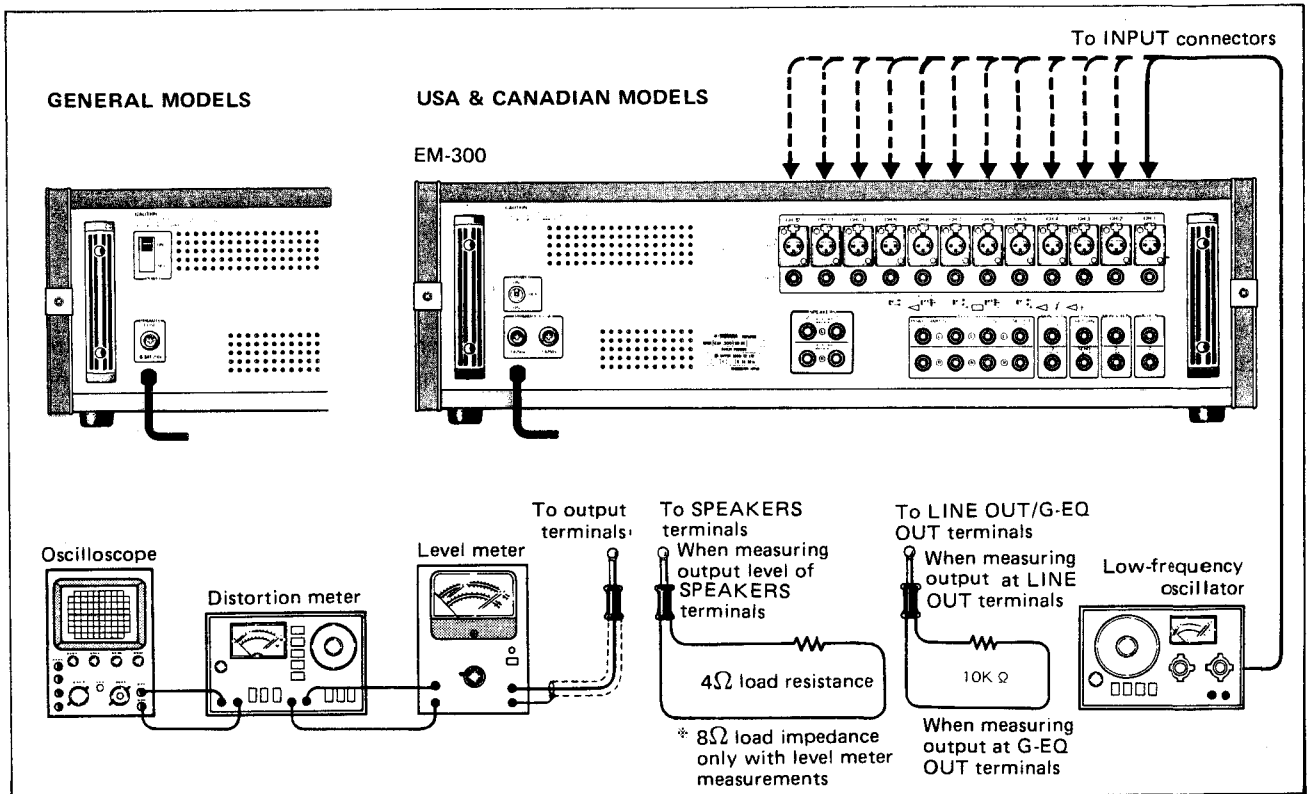

Fig. 1

Measurement conditions

Switch, control	Set position
Channel faders	Max for measurement channel only, all others to minimum position
LOW-EQ	Center
HIGH-EQ	Center
MONITOR 2	Max for measurement channel only, all others to minimum position
MONITOR 1	Max for measurement channel only, all others to minimum position
INPUT LEVEL switch	-50 (no conditions)
PAN	Center
AUX IN (1, 2)	Max for measurement only, otherwise minimum
AUX PAN (1, 2)	Center
REVERB/ECHO	Max for measurement only, otherwise minimum
GRAPHIC EQUALIZER (L, R)	Center (Max or min for measurement only)
PROGRAM master faders (L, R)	Max
Monitor master faders (1, 2)	Max

Table 1

1. GAIN

Check that the outputs listed in Table 2 are available at the respective terminals when the controls and switches are set to the positions given in Table 1, and a -55 dBm 1 kHz sine wave signal is applied to the INPUT connectors (phone jacks).

* Connect a 4Ω load resistance to the SPEAKERS terminals and a 10kΩ load resistance to the LINE OUT and G-EQ OUT terminals during measurement.

* Check that the difference in level between the channels for all the outputs is less than 2 dB.

Channel INPUT level switch	Output level of LINE OUT terminals	Output level of G-EQ OUT terminals	Output level of SPEAKERS terminals
-50	-1 ± 2 dBm	-1 ± 2 dBm	-26 ± 2 dBm
-40	-11 ± 2 dBm	-11 ± 2 dBm	-16 ± 2 dBm
-30	-21 ± 2 dBm	-21 ± 2 dBm	+6 ± 2 dBm
-20	-31 ± 2 dBm	-31 ± 2 dBm	-4 ± 2 dBm
+4	-53 ± 3 dBm	-53 ± 3 dBm	-28 ± 3 dBm

Table 2

2. DISTORTION

Check that the harmonic distortion is less than 1% when the controls and switches are set to the positions in Table 1 and when a -55 dBm, 1 kHz sine wave signal is applied to the INPUT connectors and the output level at the SPEAKERS terminals is $+26$ dBm (60 W).

3. FREQUENCY RESPONSE

Check that the frequency response is within ± 3 dB of the basic curve given in Fig. 2 at the LINE OUT terminals when the controls and switches are set to the positions given in Table 1 and a -55 dBm sine wave signal is applied to the INPUT connectors of each channel.

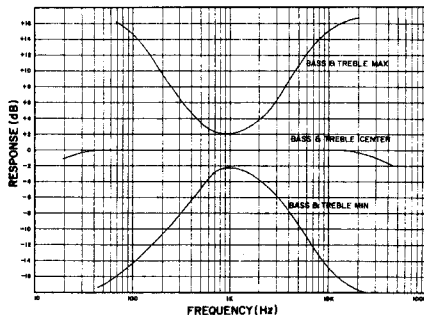

Fig. 2

4. EQUALIZER VARIATION RESPONSE

• HIGH-EQ

Make sure that a variation of $+14 \pm 2$ dB is produced at the LINE OUT terminals when the HIGH-EQ controls are set to their maximum positions and that a variation of -14 ± 2 dB is produced when the same controls are set to their minimum positions, when the controls and switches are set to the positions given in Table 1 and when a -70 dBm, 10 kHz sine wave signal is applied to the INPUT connectors.

• LOW-EQ

Make sure that a variation of $+14 \pm 2$ dB is produced at the LINE OUT terminals when the LOW-EQ controls are set to their maximum positions and that a variation of -14 ± 2 dB is produced when the same controls are set to their minimum positions, when the controls and switches are set to the positions given in Table 1 and when a -70 dBm, 100 Hz sine wave signal is applied to the INPUT connectors.

5. MAXIMUM OUTPUT POWER

The distortion must be within 3% when the controls and switches are set to the positions given in Table 1, a 1 kHz sine wave signal is applied to the INPUT connectors, and the output level of the SPEAKERS terminals is $+31.2$ dBm (200 W).

* Make either the L or R PAN the measurement channel.

6. SEPARATION

Set the controls and switches to the positions given in Table 1, apply a -55 dBm, 1 kHz sine wave signal to the INPUT connectors, rotate the measurement channel PANPOT control to the R channel side, and check that the leakage level at the L channel side of the SPEAKERS terminals is less than -29 dBm (55 dB separation).

In the same way, rotate the PANPOT control to the L channel side, and check the level of the leakage into the R channel.

7. AUX IN 1, 2

Check that a $+21 \pm 2$ dBm output is obtained at the SPEAKERS terminals when the controls and switches are set to the positions given in Table 1, and when a -30 dBm, 1 kHz sine wave signal is applied to the AUX IN 1 or 2 terminals.

8. MONITOR 1, 2

Check that a -1 ± 2 dBm output is obtained at the MONITOR 1 or 2 terminals when the controls and switches are set to the positions given in Table 1, when a -55 dBm, 1 kHz sine wave signal is applied to the INPUT connectors, and when the channel MONITOR 1 or 2 control is set to its maximum position.

* The load resistance is 10 k Ω .

9. MONITOR SUB IN

Check that a -6 ± 2 dBm output is obtained at the MON OUT 1 or 2 terminals when the controls and switches are set to the positions given in Table 1, when a -6 dBm, 1 kHz sine wave signal is applied to the MON. SUB IN 1 or 2 terminals.

10. REV/ECHO

Set the controls and switches as indicated in Table 1, set the REV/ECHO control to its maximum position, and check that a $+21 \pm 2$ dBm output is obtained at the SPEAKERS terminals when a -40 dBm, 1 kHz sine wave signal is applied to the ECHO RETURN terminals.

Furthermore, set the CH-1 MONITOR 1 and MONITOR master fader 1 to their maximum positions, apply a -55 dBm, 1 kHz sine wave signal to the INPUT connectors, and check that a -25 ± 3 dBm output is obtained at the ECHO SEND terminals with a 10 k Ω load when a -1 ± 2 dBm output is obtained at the MONITOR 1 terminals.

11. GRAPHIC EQUALIZER

Set the controls and switches as indicated in Table 1, apply a -70 dBm sine wave signal to the INPUT connectors, and then check that at the specified frequency a variation of $+12 \pm 1.5$ dB and -12 ± 1.5 dB is displayed when each of the band controls are set to the maximum and minimum positions. (Fig. 3)

- * Specified frequencies: 60Hz, 125Hz, 250Hz, 500Hz, 1kHz, 2kHz, 4kHz, 8kHz and 16kHz (frequencies may vary within a $\pm 15\%$ range)

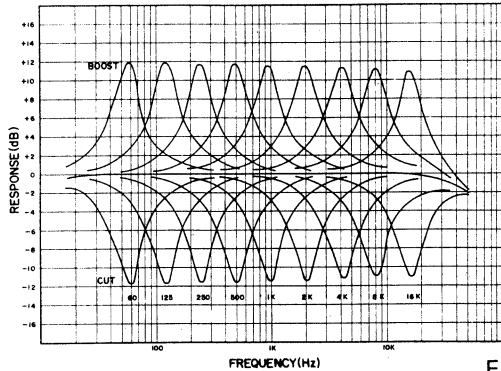

Fig. 3

12. NOISE LEVEL

Check that the noise level at the SPEAKERS terminals is less than -33 dBm when the INPUT connectors are shorted with a 150Ω resistance and that the noise level at the MONITOR 1 or 2 terminals is less than -55 dBm.

13. PHONES

Set the controls and switches as indicated in Table 1, apply a -55 dBm, 1 kHz sine wave signal to the INPUT connectors, connect an $8\Omega/8\Omega$ load resistance to the PHONES terminal and check that an output of -5 ± 3 dBm is obtained across both ends.

14. REVERB (REFERENCE)

Set the controls and switches as indicated in Table 1, set the channel MONITOR 1 (REV/ECHO) controls to their maximum position, and apply the output signal (-50 dBm) of the reverberation adjustment oscillator (Electone, flute 8' C₃-B₃ 7 sound mixing signal) to the CH-1 INPUT terminals. Now adjust semi-fixed resistor B47 k Ω so that a -30 ± 2 dBm output is obtained at the RO and E terminals on the DC circuit board. (Fig. 4)

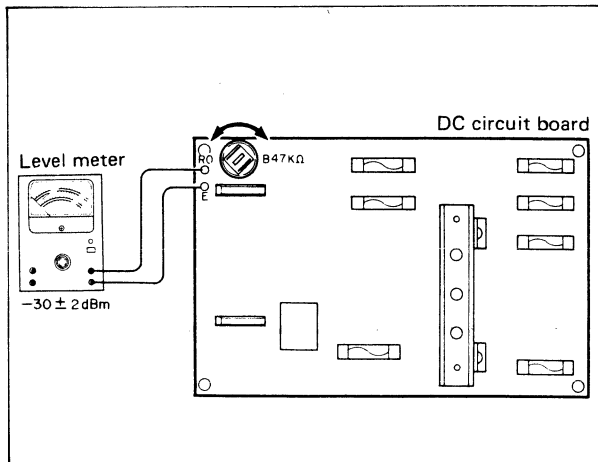

Fig. 4

15. LEVEL METER

Set the controls and switches as indicated in Table 1, apply a -55 dBm, 1 kHz sine wave signal to the INPUT connectors and connect an 8Ω load resistance to the SPEAKERS terminals. Now check that the level meter pointer indicates 0 ± 1 VU when a $+29.7$ dBm (70 W) output is obtained across the resistance.

16. MA CIRCUIT BOARD ADJUSTMENTS

16-1. Idling current adjustment

Adjust the $B470\Omega$ semi-fixed resistor so that the voltage across test points RE (-) and CT (+) is set to DC 23 ± 23 mV under no-signal conditions. (Fig. 5)

- * Perform the adjustment within 30 seconds after the POWER switch has been set to ON.

A variation in the idling current after adjustment of 23 ± 10 mV is acceptable across a 15°C to 40°C temperature range of the radiator.

16-2. Midpoint potential adjustment

Check that the DC voltage across the output terminals (O) and E under no-signal conditions is within 0 ± 100 mV. (Fig. 5)

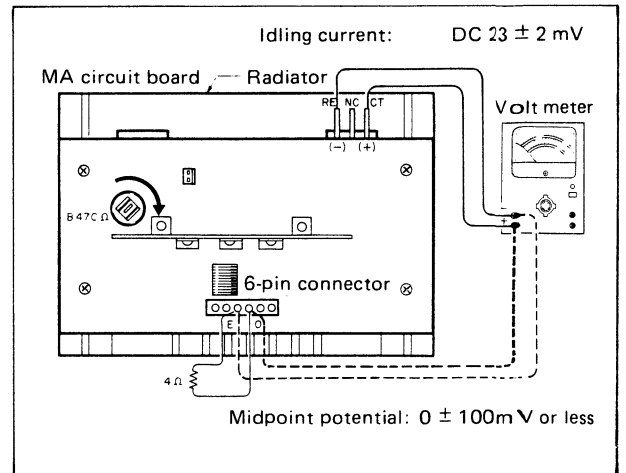

Fig. 5

17. STABILITY

17-1. Power line voltage fluctuations

Operation shall not be affected by fluctuations in the regulated $\pm 10\%$ of the power line voltage.

17-2. Oscillation

- Set either the LOW-EQ, HIGH-EQ or graphic equalizer to FLAT and the other controls to maximum. The check that there is no abnormal oscillation when all the controls are set to their maximum positions.
 - * Short the INPUT connectors of each channel with a 150Ω resistance.
- Check that there is no abnormal oscillation even when 10pF to $0.1\mu\text{F}$ capacitors are connected in parallel to the 4Ω load resistance at the SPEAKERS terminals.

PRINTED CIRCUIT BOARD

● PA CURCUIT BOARD

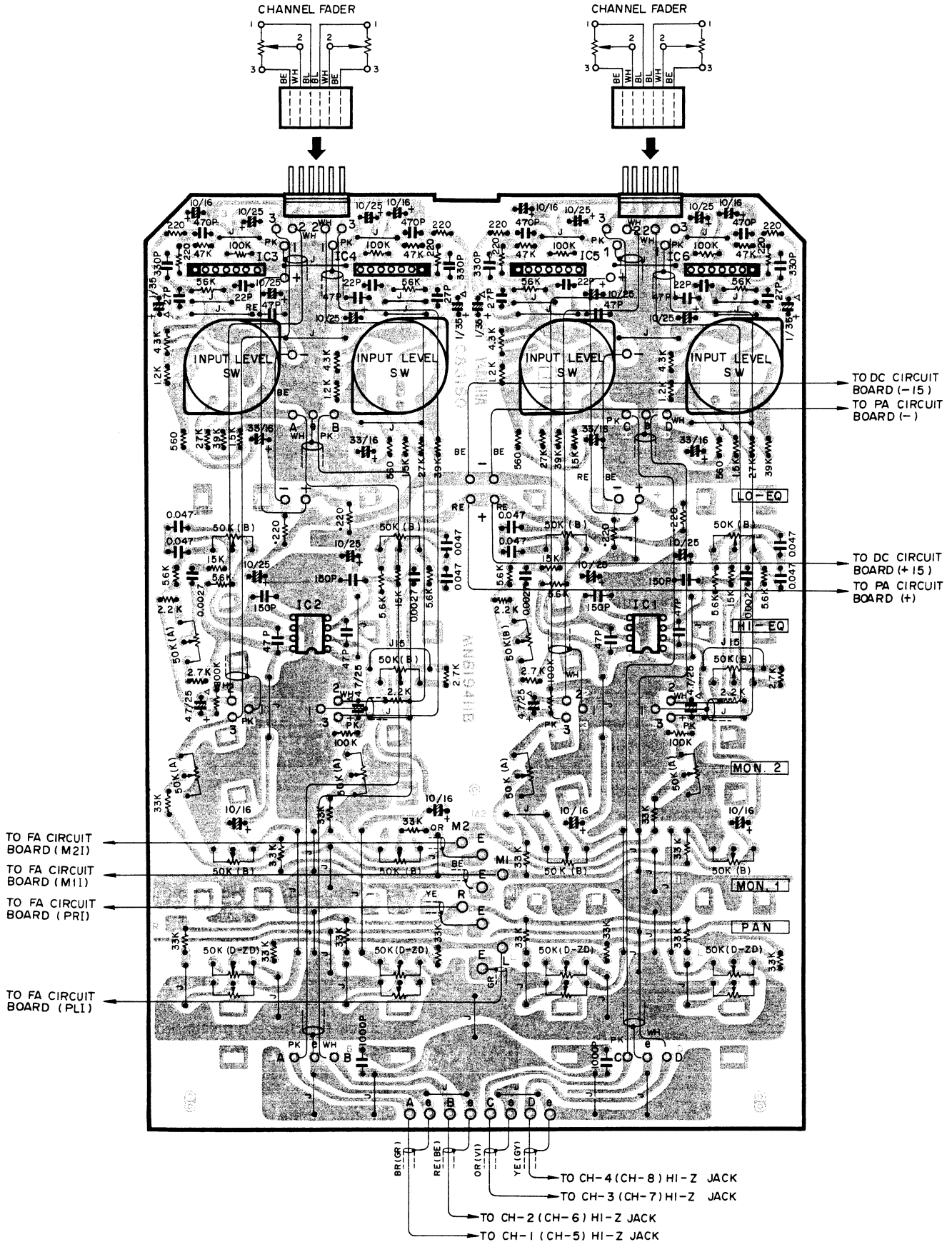

● FA CIRCUIT BOARD

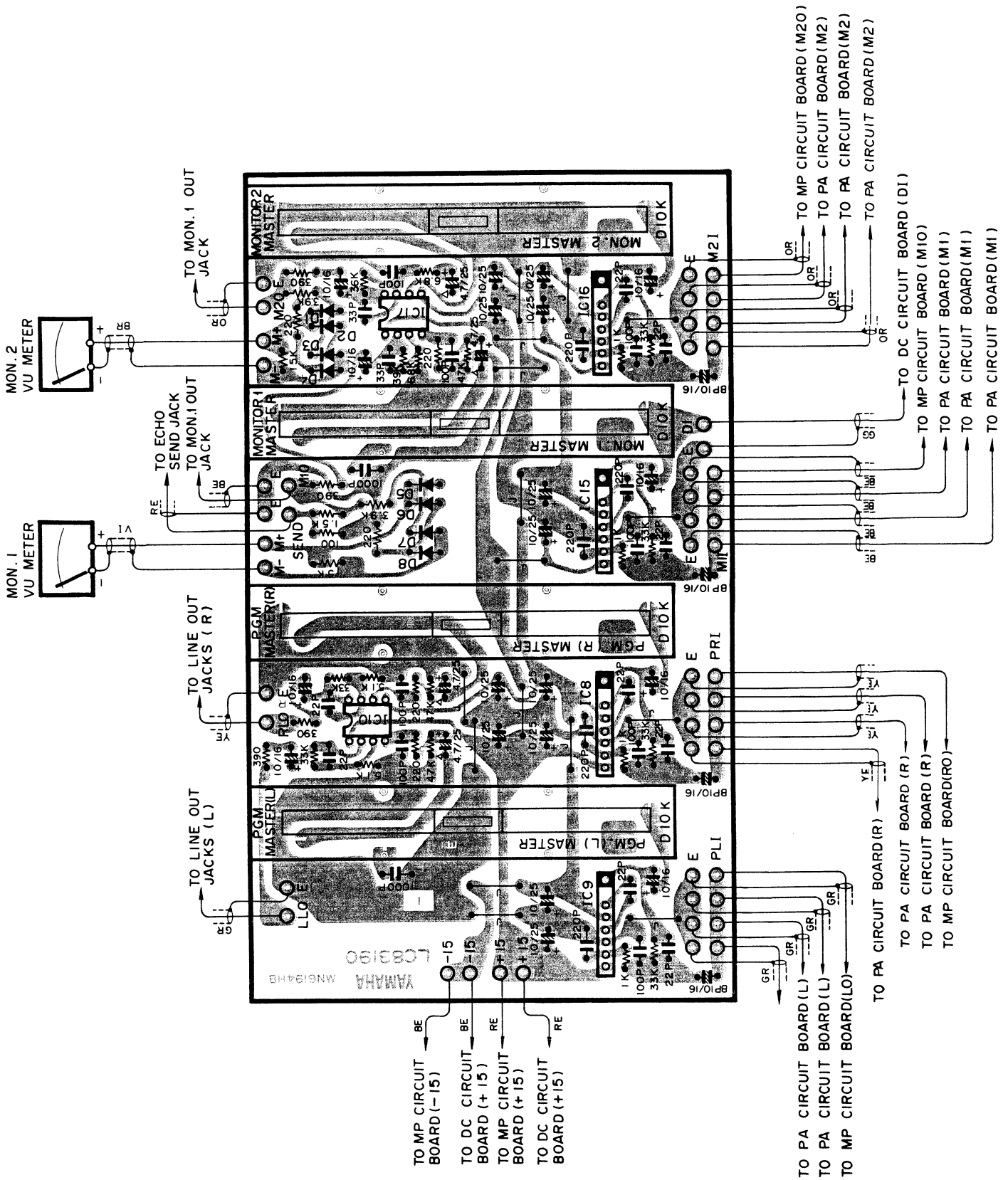

■ BLOCK DIAGRAM

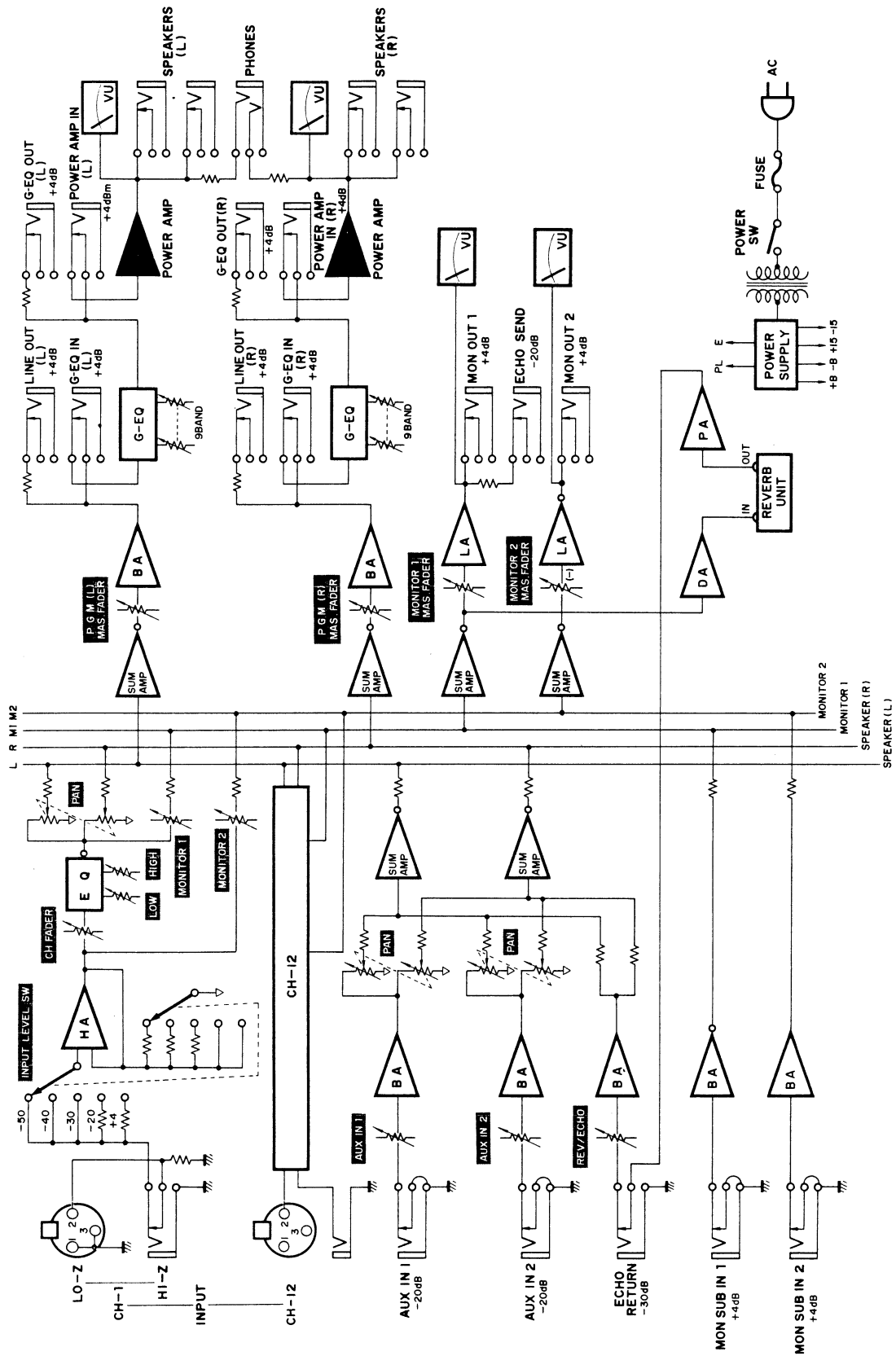

SCHEMATIC DIAGRAM

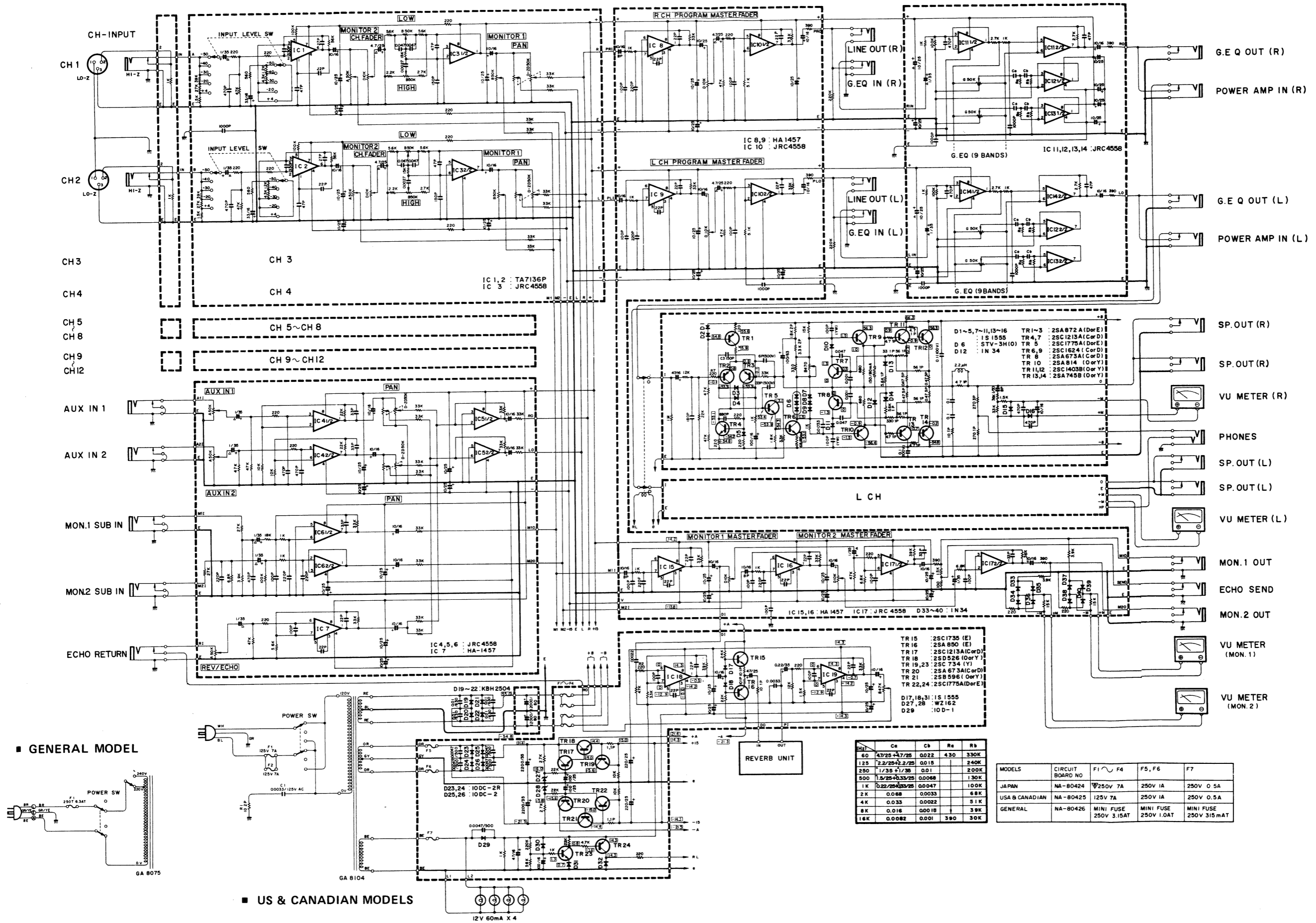

■ PARTS LIST

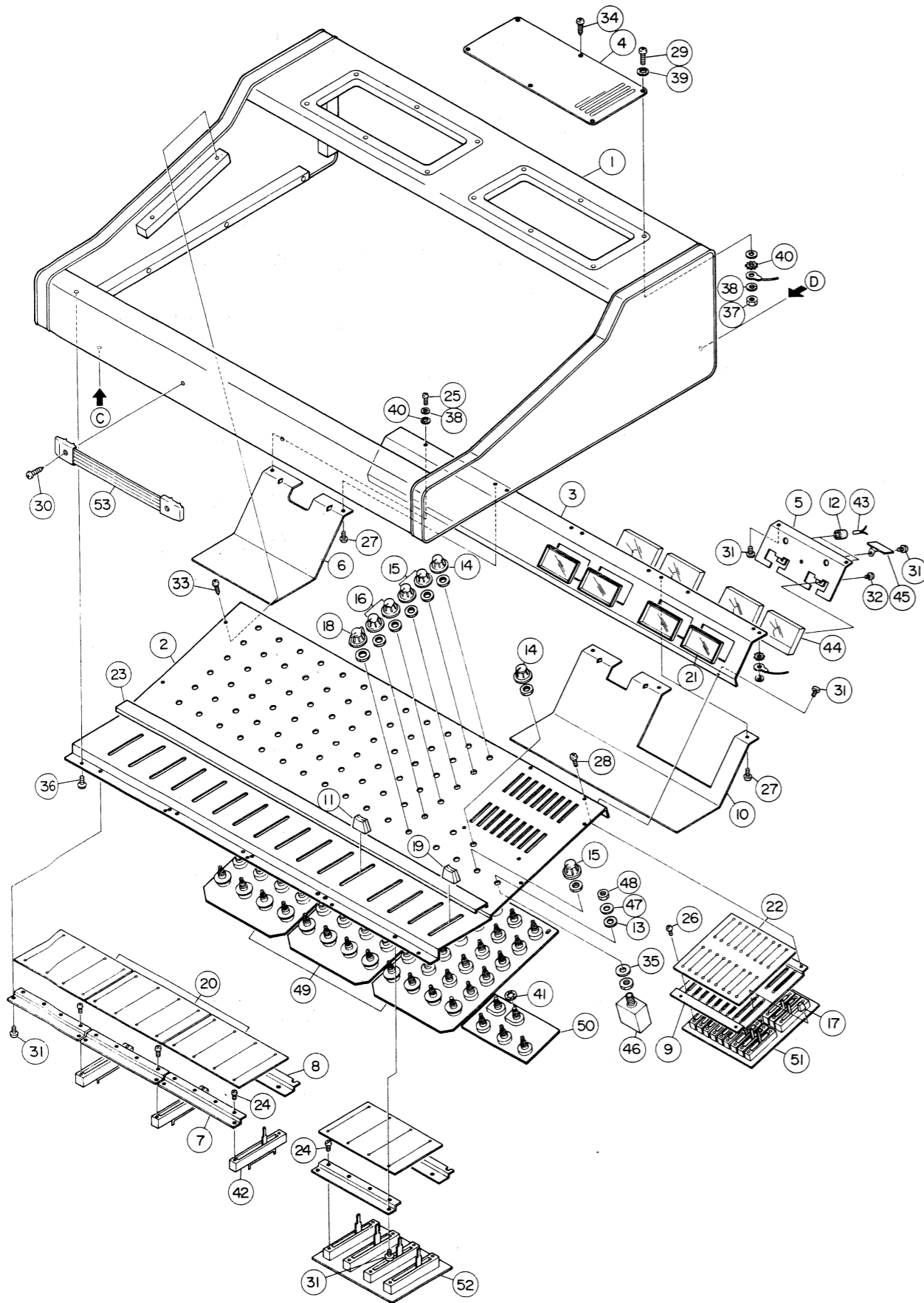

* New Parts

Ref. No.	Part No.	Description (部品名)	Remarks	Common Model
1	30:56:15:00:00:00:10	Case Ass'y	外装組上り	
2	30:56:00:AA:80:78:50	Panel (A)	パネル (A)	
3	30:56:00:AA:80:78:70	Panel (B)	パネル (B)	
4	30:56:00:AA:80:80:00	Radiator Grille (L)	放熱グリル (大)	EM200
5	30:56:00:AA:80:80:20	Meter Sub-Panel	メーターサブパネル	- do. -
6	30:56:00:AA:80:81:40	Shield Plate	シールド板	- do. -
7	30:56:00:AA:80:81:50	Sub-Panel (A)	サブパネル (A)	- do. -
8	30:56:00:AA:80:81:60	Sub-Panel (B)	サブパネル (B)	- do. -
9	30:56:00:AA:80:82:00	EQ Sub-Panel	E Q サブパネル	- do. -
10	30:56:00:AA:80:90:70	PS Shield Plate	P S シールド板	
11	30:54:00:CB:02:38:30	Knob	-Black- ツマミ (クロ)	PM1000
12	30:54:00:CB:06:86:20	Lamp Holder	ランプホルダー	PM400
13	30:56:00:CB:81:00:90	Insulation Nut	絶縁ナット	EM120
14	30:56:00:CB:81:21:30	Knob	-Yellow- ツマミ (イエロー)	EM200
15	30:56:00:CB:81:21:40	- do. -	-Ivory- " (アイボリー)	- do. -
16	30:56:00:CB:81:21:50	- do. -	-Gray- " (グレー)	- do. -
17	30:56:00:CB:81:21:60	- do. -	-Ivory- EQ ツマミ (アイボリー)	- do. -
18	30:56:00:CB:81:21:80	- do. -	-Black- ツマミ (クロ)	- do. -
19	30:56:00:CB:81:22:60	- do. -	-Red- " (アカ)	- do. -
20	40:10:00:CB:81:22:70	Dust Proof Cover	防塵カバー	- do. -
21	30:56:00:CB:81:22:80	Meter Escutcheon	メーターエスカッション	- do. -
22	40:10:00:CB:81:23:00	Dust Proof Cover	防塵カバー	- do. -
23	30:56:00:CB:81:23:60	Indication Chip	表示チップ	
24	40:10:00:EA:03:00:50	Pan Head Screw	M3 x 5 ZMC2-Y ナベ小ネジ	
25	40:10:00:EA:04:00:80	- do. -	M4 x 8 - do. - "	
26	40:10:00:EA:32:00:40	- do. -	M2 x 4 ZMC2-BL "	
27	40:10:00:ED:04:00:60	Bind Screw	M4 x 6 ZMC2-Y バインド小ネジ	
28	40:10:00:ED:33:00:50	- do. -	M3 x 5 ZMC2-BL "	
29	40:10:00:ED:34:02:50	- do. -	M4 x 25 - do. - "	
30	40:10:00:EF:25:03:00	Oval Head Screw	M5 x 30 FCrM3-3g 丸皿小ネジ	
31	40:10:00:EI:03:00:50	Bind Tapping Screw	3 x 5 ZMC2-Y バインドタッピングスクリュー	
32	40:10:00:EI:03:00:80	- do. -	3 x 8 - do. - "	
33	40:10:00:EI:33:01:20	- do. -	3 x 12 ZMC2-BL "	
34	40:10:00:EI:34:01:20	- do. -	4 x 12 - do. - "	
35	40:10:00:EK:00:23:70	Washer	ファイバーワッシャー	
36	40:10:00:EQ:03:11:30	Round Head Wood Screw	3.1 x 13 ZMC2-Y 丸木ネジ	
37	40:10:00:EV:10:00:40	Hexagonal Nut	4φ ZMC2-Y 六角ナット	
38	40:10:00:EV:30:00:40	Spring Lock Washer	4φ - do. - バネ座金	
39	40:10:00:EV:41:00:40	Toothed Lock Washer	4φ ZMC2-BL 歯付座金	
40	40:10:00:EV:43:00:40	- do. -	4φ ZMC2-Y "	
41	40:10:00:EV:43:00:70	- do. -	7φ - do. - "	
42	40:10:00:EQ:20:02:10	Slide Variable Resistor	スライドボリューム	EM200
43	40:10:00:JB:00:02:30	Lamp (With Lead)	リード付ランプ	- do. -
44	40:10:00:JI:00:05:30	VU Meter	V U メーター	- do. -
45	40:10:00:LA:00:01:90	Lug	ラグ端子	
46	40:10:00:LB:20:11:20	Jack	ジャック	
47	40:10:00:LX:20:00:10	Flat Washer	特殊平座金	
48	40:10:00:LX:20:00:60	Hexagonal Nut	特殊六角ナット	
49	30:56:00:NA:80:40:70	PA Board	P A シート	EM200
50	30:56:00:NA:80:40:90	MP Board	M P シート	- do. -
51	30:56:00:NA:80:41:00	EQ Board	E Q シート	- do. -
52	30:56:00:NA:80:42:10	FA Board	F A シート	
53	30:10:00:NB:80:59:50	Handle Ass'y	取手 Ass'y	EM200

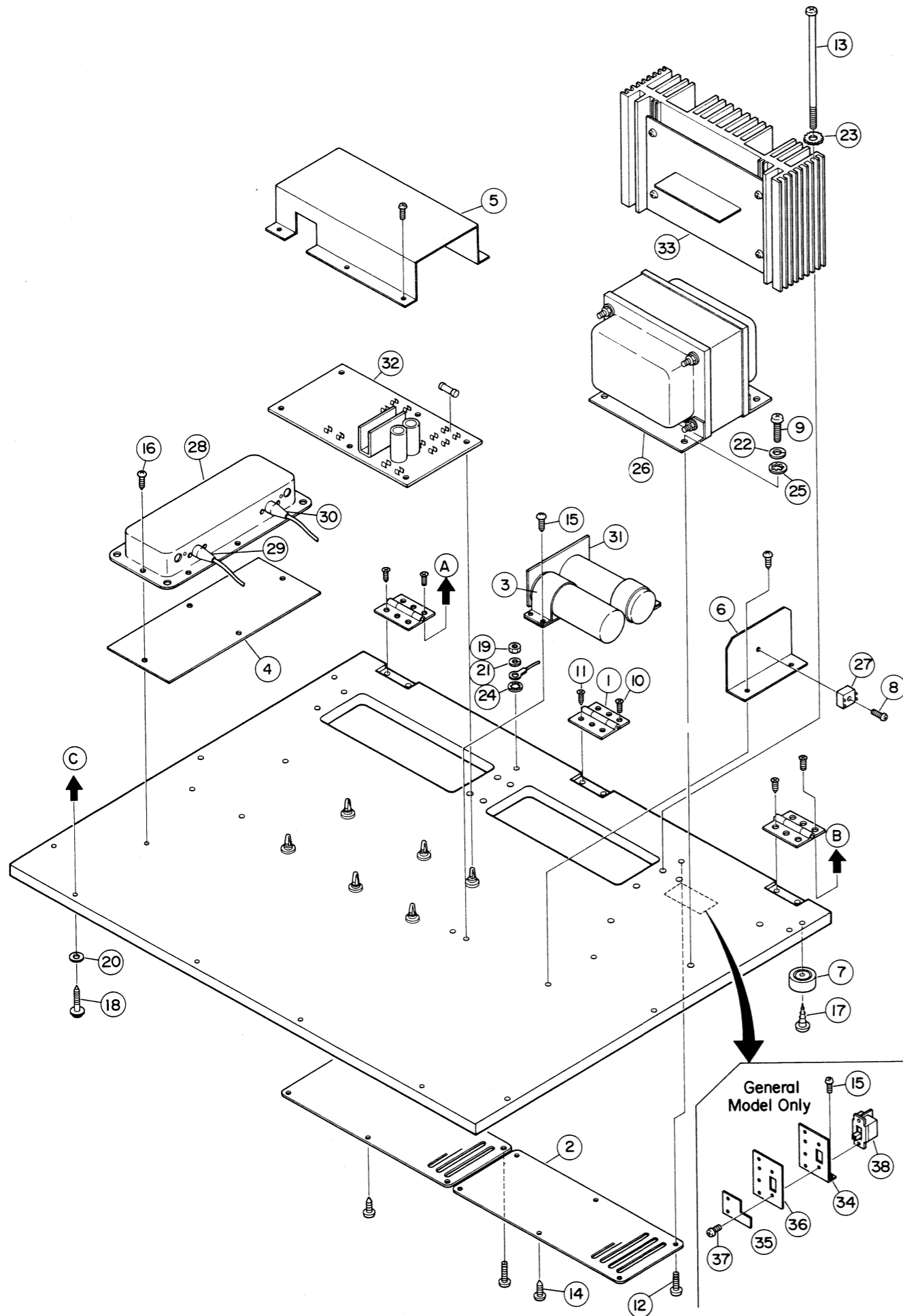

* New Parts

J: Japanese U: USA C: Canadian G: General

Ref. No.	Part No.	Description (部品名)	Remarks	Common Model
1	30:56:00:AA 80:11:20	Hinge	蝶番	EM200
2	30:56:00:AA 80:80:00	Radiator Grill (L)	放熱グリル (大)	- do. -
3	30:56:00:AA 80:81:70	Holder, Electrolytic Cap.	コンデンサ取付バンド	- do. -
4	30:56:00:AA 80:82:10	Shield Board	シールド板	- do. -
5	30:56:00:AA 80:95:10	DC Shield Board	D C シールド板	
6	30:56:00:BA 80:33:30	Diode Radiator	整流ブリッジ放熱板	EM200
7	30:54:00:CB 80:65:90	Leg	アンブレッグ	- do. -
8	40:10:00:EA 04:01:50	Pan Head Screw M4 x15 ZMC2-Y	ナベ小ネジ	
9	40:10:00:EA 36:02:00	- do. - M6 x 20 ZMC2-BL	"	
10	40:10:00:EB 03:00:50	Flat Head Screw M3 x 5 ZMC2-Y	サラ小ネジ	
11	40:10:00:EB 33:01:20	- do. - M3 x 12 ZMC2-BL	"	
12	40:10:00:ED 34:02:50	Bind Screw M4 x 25 - do. -	バインド小ネジ	
13	40:10:00:EG 35:16:40	Pan Head Screw M5 x 164 - do. -	尖先ナベ小ネジ	
14	40:10:00:EI 34:01:20	Bind Tapping Screw 4 x 12 - do. -	バインドタッピングネジ	
15	40:10:00:EQ 03:11:30	Round Head Wood Screw 3.1 x 13 ZMC2-Y	丸木ネジ	
16	40:10:00:EQ 03:51:30	- do. - 3.5 x 13 - do. -	"	
17	40:10:00:EQ 34:12:00	- do. - 4.1 x 20 ZMC2-BL	"	
18	40:10:00:EQ 34:13:20	- do. - 4.1 x 32 - do. -	"	
19	40:10:00:EV 10:00:40	Hexagonal Nut 4φ ZMC2-Y	六角ナット	
20	40:10:00:EV 20:30:40	Flat Washer 4φ ZMC2-BL	平座金	
21	40:10:00:EV 30:00:40	Spring Lock Washer 4φ ZMC2-Y	バネ座金	
22	40:10:00:EV 30:00:60	- do. - 6φ - do. -	"	
23	40:10:00:EV 41:00:50	Toothed Lock Washer 5φ ZMC2-BL	歯付座金	
24	40:10:00:EV 43:00:40	- do. - 4φ ZMC2-Y	"	
25	40:10:00:EV 43:00:60	- do. - 6φ ZMC2-Y	"	
26	40:10:00:GA 80:74:00	Power Transformer 100V	電源トランス J	
	80:75:00	- do. - 200V	" G	
	81:04:00	- do. - 120V	" U,C	
27	40:10:00:EH 00:03:90	Bridge Rectifier KBH-2504	整流ブリッジ	
28	40:10:00:JH 00:00:70	Reverb Unit	リバーブユニット	
29	40:10:00:LB 10:00:40	Pin Plug (Black)	ピンプラグ (クロ)	
30	40:10:00:LB 10:00:60	- do. - (Red)	" (アカ)	
31	40:10:00:LC 83:23:30	CO P.C. Board	COシートプリント基板	EM200
32	30:56:00:NA 80:42:40	DC Board	D C シート J	
	30:56:00:NA 80:42:50	- do. -	" U,C	
	30:56:00:NA 80:42:60	- do. -	" G	
33	30:56:00:NA 80:42:20	MA Board	M A シート J,G,C	
	30:56:00:NA 80:42:30	- do. -	" U	
34	30:56:00:AA 80:81:90	Ungle, Voltage Selector	V S アングル G	
35	40:10:00:CB 80:66:30	Stopper, - do. -	V S ストッパー G	
36	40:10:00:CB 80:68:40	Insulator, - do. -	V S インシュレーター G	
37	40:10:00:EA 03:00:50	Pan Head Screw M3 x 5 ZMC2-Y	ナベ小ネジ G	
38	40:10:00:KA 40:04:10	Slide Switch	スライドスイッチ G	

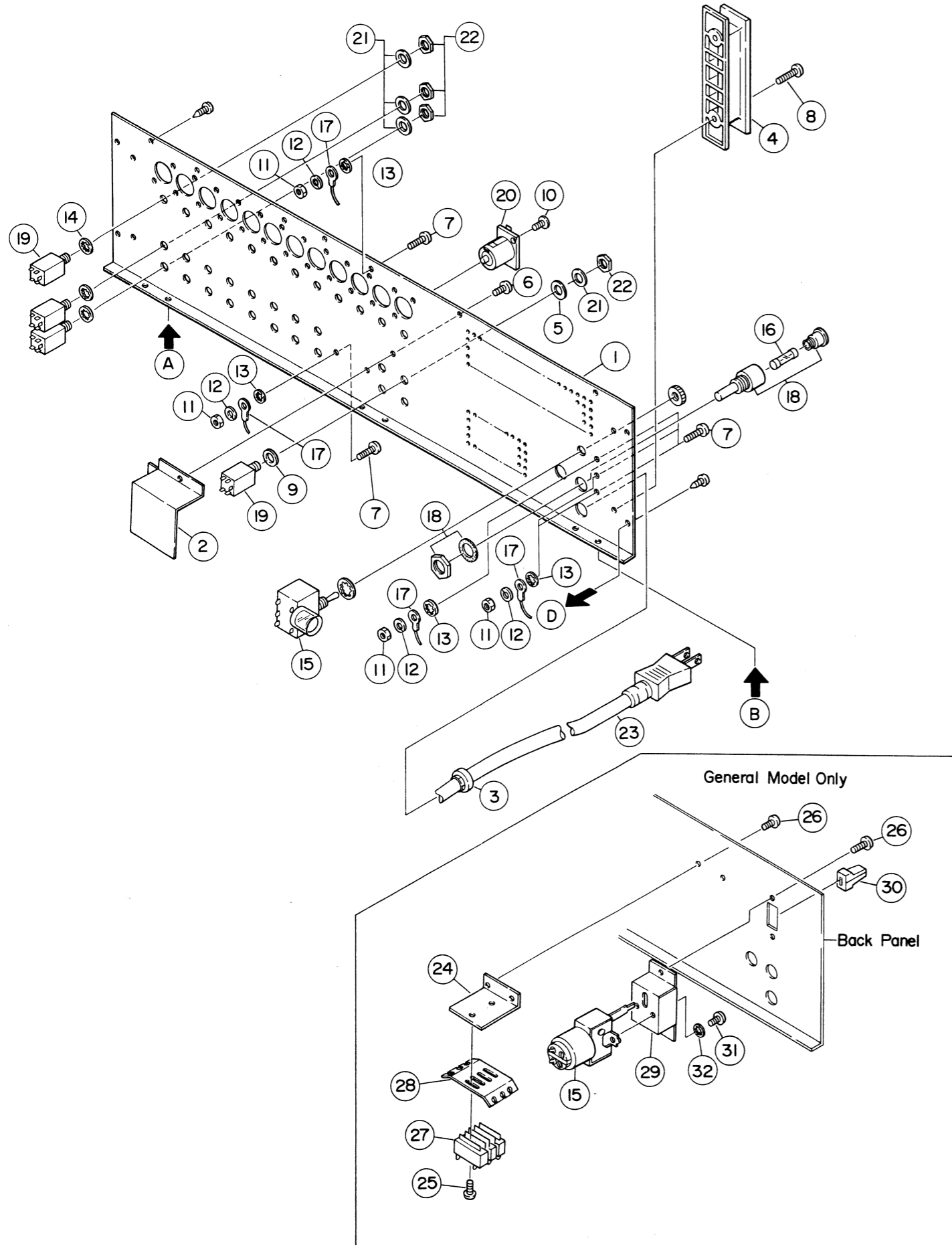

* New Parts

Ref. No.	Part No.	Description (部品名)	Remarks	Common Model
1	30:56:00:AA:80:80:30	Back Panel	バックパネル	J
	30:56:00:AA:80:80:40	- do. -	"	U,C
	30:56:00:AA:80:80:50	- do. -	"	G
2	30:56:00:AA:80:81:80	SP Shield Plate	S P シールド板	
3	40:10:00:CB:07:06:90	Cord Stopper	コードストッパー	G
	40:10:00:CB:80:68:50	- do. -	"	J,U,C
4	30:54:00:CB:80:66:40	Cord Reel	コードリール	
5	30:56:00:CB:81:00:90	Insulation Nut	絶縁ナット	
6	40:10:00:ED:33:00:50	Bind Screw M3 x 5 ZMC2-BL	バインド小ネジ	
7	40:10:00:ED:34:01:20	- do. - M4 x 12 - do. -	"	
8	40:10:00:EI:34:01:20	Bind Tapping Screw 4 x 12 - do. -	バインドタッピングネジ	
9	40:10:00:EK:00:23:70	Fiber Washer	ファイバーワッシャー	
10	40:10:00:EM:23:00:60	Oval Head Tapping Screw 3 x 6 FNM3-3g	丸皿タッピングネジ	
11	40:10:00:EV:10:00:40	Hexagonal Nut 4φ ZMC2-Y	六角ナット	
12	40:10:00:EV:30:00:40	Spring Lock Washer 4φ - do. -	バネ座金	
13	40:10:00:EV:43:00:40	Toothed Lock Washer 4φ - do. -	歯付座金	
14	40:10:00:EV:43:00:90	- do. - 9φ - do. -	"	
15	40:10:00:KA:20:09:20	Power Switch	パワースイッチ	G
	40:10:00:KA:30:02:10	- do. -	"	J,C
	40:10:00:KA:30:03:50	- do. -	"	U
16	40:10:00:KB:00:07:70	Fuse Mini 250V 6.3AT	ヒューズ	G
	40:10:00:KB:00:13:00	- do. - 250V 7A	"	J
	40:10:00:KB:00:15:20	- do. - UL 125V 7A	"	U,C
17	40:10:00:LA:00:07:60	Lug	カラー端子板	J,U,C
18	40:10:00:LB:20:04:90	Fuse Holder	ヒューズホルダー	U,C,J
	40:10:00:LB:20:05:90	- do. -	"	G
19	40:10:00:LB:20:11:20	Jack	ジャック	
20	40:10:00:LB:30:01:50	Cannon Socket XLR3-31	キャノンソケット	
21	40:10:00:LX:20:00:10	Flat Washer 9φ	特殊平座金	
22	40:10:00:LX:20:00:60	Hexagonal Nut 9φ	特殊六角ナット	
23	40:10:00:MG:00:02:70	Power Cord	電源コード	U,C
	40:10:00:MG:00:04:50	- do. -	"	G
	40:10:00:MG:00:06:10	- do. -	"	J
24	30:54:00:AA:80:29:50	Holder, Terminal	ボイボ端子取付金具	G
25	40:10:00:EA:03:01:60	Pan Head Screw M3 x 16 ZMC2-Y	ナベ小ネジ	G
26	40:10:00:ED:33:00:50	Bind Screw M3 x 5 ZMC2-BL	バインド小ネジ	G
27	40:10:00:LA:00:10:40	Terminal	ボイボ端子	G
28	40:10:00:LA:00:21:90	Wire Holder	ワイヤーホルダー	G
	40:10:00:AA:03:15:80	Washer, Fuse Holder	ヒューズホルダーワッシャー	G
29	30:56:00:AA:80:91:60	Sub Chassis, Switch	スイッチサブシャーシ	G
30	30:10:00:CB:81:12:90	Knob	ツマミ	G
31	40:10:00:EA:33:00:50	Pan Head Screw M3 x 5 ZMC2-BL	ナベ小ネジ	G
32	40:10:00:EV:43:00:30	Toothed Lock Washer 3φ - do. -	歯付座金	G
	40:10:00:FQ:08:34:70	Oil Capacitor 0.0047μF 2000V	オイルコン	J
	40:10:00:HL:42:71:00	Metal Oxide Film Resistor 10kΩ 2P	酸化金抵抗	J,U,C

* New Parts

Ref. No.	Part No.	Description (部品名)	Remarks	Common Model
	40:10:00:LC:83:23:30	CO P.C Board	COシートプリント基板	
	40:10:00:FZ:00:14:20	Electrolytic Cap. 12000 μ F/80V	ケミコン	
	30:56:00:NA:80:40:70	PA Board	PAシート	EM200
	40:10:00:FP:15:61:00	Tantalum Capacitor 1 μ F/35V	タンタルコン	
	40:10:00:FP:34:64:70	- do. - 4.7 μ F/25V	"	
	40:10:00:HS:31:04:30	Variable Resistor A50k Ω	ボリューム	
	40:10:00:HS:31:04:40	- do. - B50k Ω	"	
	40:10:00:HS:31:04:50	- do. - D-ZD50k Ω	"	
	40:10:00:HW:79:52:20	Fuse Resistor 220 Ω 1/4P	プレート抵抗	
	40:10:00:IG:00:12:20	IC TA7136P	I C	
	40:10:00:IG:00:13:90	- do. - JRC4558	"	
	40:10:00:KA:50:10:90	Rotary Switch 2-5s	ロータリーSW	
	40:10:00:LB:60:28:20	2.5 Pich Base Pin Side 6P	2.5ピッチベースピン サイド6ピン	
	30:56:00:NA:80:40:90	MP Board	MPシート	EM200
	40:10:00:FP:15:61:00	Tantalum Capacitor 1 μ F/35V	タンタルコン	
	40:10:00:HS:31:04:30	Variable Resistor A50k Ω	ボリューム	
	40:10:00:HS:31:04:50	- do. - D-ZD50k Ω	"	
	40:10:00:IG:00:13:90	IC JRC4558	I C	
	40:10:00:IG:02:62:00	- do. - HA1457	"	
	30:56:00:NA:80:41:00	EQ Board	EQシート	EM200
	40:10:00:FP:15:53:30	Tantalum Capacitor 0.33 μ F/35V	タンタルコン	
	40:10:00:FP:15:61:00	- do. - 1 μ F/35V	"	
	40:10:00:FP:34:61:50	- do. - 1.5 μ F/25V	"	
	40:10:00:FP:34:62:20	- do. - 2.2 μ F/25V	"	
	40:10:00:FP:34:64:70	- do. - 4.7 μ F/25V	"	
	40:10:00:FP:35:52:20	- do. - 0.22 μ F/35V	"	
	40:10:00:HQ:30:03:50	Slide Variable Resistor	スライドボリューム	
	40:10:00:IG:00:13:90	IC JRC4558	I C	
	30:56:00:NA:80:42:10	FA Board	FAシート	
	40:10:00:FM:09:71:00	BP Capacitor 10 μ F/16V	BPケミコン	
	40:10:00:FP:34:64:70	Tantalum Capacitor 4.7 μ F/25V	タンタルコン	
	40:10:00:HQ:20:02:10	Slide Variable Resistor D10k Ω	スライドボリューム	
	40:10:00:IG:00:13:90	IC JRC4558	I C	
	40:10:00:IG:02:62:00	IC HA1457	"	
	40:10:00:IF:00:00:10	Diode IN-34	ダイオード	

* New Parts

Ref. No.	Part No.	Description (部品名)	Remarks	Common Model
*	30:56:00:NA:80:42:20	MA Board	M A シ ー ト	J, G, C
*	30:56:00:NA:80:42:30	- do. -	"	U
*	30:54:00:BA:80:16:40	Heat Sink	放 熱 器	
*	30:56:00:BA:80:34:10	- do. -	"	
	40:10:00:FM:11:61:00	BP Capacitor 1 μ F/50V	B P ケ ミ コ ン	
	40:10:00:GD:90:02:10	Coil 2.2 μ H	コ イ ル	
	40:10:00:HL:31:34:70	Metal Oxide Film Resistor 4.7 Ω 1P	酸 金 抵 抗	
	40:10:00:HL:31:41:00	- do. - 10 Ω 1P	"	
	40:10:00:HL:31:45:60	- do. - 56 Ω 1P	"	
	40:10:00:HL:31:52:70	- do. - 270 Ω 1P	"	
	40:10:00:HL:31:53:30	- do. - 330 Ω 1P	"	
	40:10:00:HL:31:65:60	- do. - 5.6k Ω 1P	"	
	40:10:00:HL:32:63:30	- do. - 3.3k Ω 2P	"	
	40:10:00:HL:33:52:70	- do. - 270 Ω 3P	"	
	40:10:00:HL:41:71:50	- do. - 15k Ω 1P	"	
	40:10:00:HL:42:61:80	- do. - 1.8k Ω 2P	"	
	40:10:00:HM:05:24:70	Cement Molded Resistor 0.47 Ω 5P	セ メ ン ト 抵 抗	
	40:10:00:HT:41:01:20	Variable Resistor B470 Ω	ソ リ ッ ド ボ リ ュ ー ム	
	40:10:00:HW:10:46:80	Fuse Resistor 85mA 68 Ω	ヒ ュ ー ズ 抵 抗	Except U
	40:10:00:HW:11:51:50	- do. - 80mA, 50 Ω	"	Except U
	40:10:00:HW:20:46:80	- do. - 85mA 68 Ω	"	U
	40:10:00:HW:21:51:50	- do. - 80mA 150 Ω	"	U
	40:10:00:HW:79:52:20	- do. - 33mA 220 Ω	"	
	40:10:00:HZ:00:07:10	- do. - 4.7 Ω 1P	不 燃 抵 抗	
	40:10:00:IA:06:73:10	Transistor 2SA673	ト ラ ン ジ ス タ	
	40:10:00:IA:07:47:50	- do. - 2SA747	"	
	40:10:00:IA:08:14:20	- do. - 2SA814	"	
	40:10:00:IA:08:72:10	- do. - 2SA872	"	
	40:10:00:IC:11:16:50	- do. - 2SC1116	"	
	40:10:00:IC:12:13:10	- do. - 2SC1213	"	
	40:10:00:IC:16:24:20	- do. - 2SC1624	"	
	40:10:00:IC:17:75:10	- do. - 2SC1775	"	
	40:10:00:IF:00:00:40	Diode IS1555	ダ イ オ ー ド	
	40:10:00:IF:00:04:50	Varistor STV-3H	"	
	40:10:00:IH:00:02:40	Diode IS1885	"	
	40:10:00:LB:30:01:10	Socket	ト ラ ン ジ ス タ ソ ケ ッ ト	
	40:10:00:LB:30:03:00	Transistor Base	コ ネ ク ト コ ン ウ ェ ハ ー	
	40:10:00:LB:30:07:30	2.5 Pich Base Pin	2.5 ピ ッ チ ベ ー ス ピ ン	
	40:10:00:LB:60:13:80	6P Connector Plug	6 P コ ネ ク タ ー	

* New Parts

Ref. No.	Part No.	Description (部品名)	Remarks	Common Model
	30:56:00:NA 80:42:40	DC Board	D C シ ー ト	J
	30:56:00:NA 80:42:50	- do. -	"	U, C
	30:56:00:NA 80:42:60	- do. -	"	G
	30:54:00:BA 80:08:10	Heat Sink	放 熱 器	
	40:10:00:FP 15:52:20	Tantalum Capacitor 0.22 μ F/35V	タ ン タ ル コ ン	
	40:10:00:HL 31:31:00	Metal Oxide Film Resistor 1 Ω 1P	酸 金 抵 抗	
	40:10:00:HL 31:41:00	- do. - 10 Ω 1P	"	
	40:10:00:HT 41:01:40	Variable Resistor B47k Ω	半 固 定 ボ リ ュ ー ム	
	40:10:00:IA 05:61:20	Transistor 2SA561	ト ラ ン ジ ス タ	
	40:10:00:IA 06:73:10	- do. - 2SA673	"	
	40:10:00:IA 08:50:00	- do. - 2SA850	"	
	40:10:00:IB 05:96:20	- do. - 2SB596	"	
	40:10:00:IC 07:34:10	- do. - 2SC734	"	
	40:10:00:IC 12:13:10	- do. - 2SC1213	"	
	40:10:00:IC 17:35:00	- do. - 2SC1735	"	
	40:10:00:ID 05:26:10	- do. - 2SD526	"	
	40:10:00:IF 00:00:10	Diode IN34A	ダ イ オ ー ド	
	40:10:00:IF 00:00:40	- do. - 1S1555	"	
	40:10:00:IF 00:06:50	Zener Diode WZ-162	ツ ェ ナ ー ダ イ オ ー ド	
	40:10:00:IG 02:62:00	IC HA1457	l C	
	40:10:00:IH 00:00:30	Diode 10D1	ダ イ オ ー ド	
	40:10:00:IH 00:00:50	- do. - 10DC-2	"	
	40:10:00:IH 00:01:30	- do. - 10DC-2R	"	
	40:10:00:KB 00:03:10	Fuse 250V 0.5A	ヒ ュ ー ズ	J
	40:10:00:KB 00:03:30	- do. - 1A	"	J
	40:10:00:KB 00:13:00	- do. - 7A	"	J
	40:10:00:KB 00:10:20	- do. - UL 1A	"	U, C
	40:10:00:KB 00:15:20	- do. - do. - 125V 7A	"	U, C
	40:10:00:KB 00:10:10	- do. - do. - 250V 0.5A	"	U, C
	40:10:00:KB 00:07:60	- do. - Mini 3.15AT	"	G
	40:10:00:KB 00:06:50	- do. - do. - 315mAT	"	G
	40:10:00:KB 00:07:30	- do. - do. - 1.0AT	"	G
	40:10:00:KC 00:03:00	Lead Relay	リ ー ド リ レ ー	
	40:10:00:LB 20:05:70	Fuse Holder Pin	ヒ ュ ー ズ 受 金 具	
	40:10:00:LB 10:01:10	Connector Pin	ダ イ ヤ モ ン ド コ ネ ク タ ー ピ ン	
	40:10:00:BB 00:44:30	Connector Pin	コ ネ ク タ ー ピ ン	
	40:10:00:LB 30:07:20	Housing 3P	3 P コ ネ ク タ ー ハ ウ ジ ン グ	
	40:10:00:LB 60:13:90	Connector Terminal	コ ネ ク タ ー タ ー ミ ナ ル	
	40:10:00:LB 60:14:00	Housing 6P	6 P コ ネ ク タ ー ハ ウ ジ ン グ	