

MIXING CONSOLES

MR842

MR1242

MR1642

SERVICE MANUAL

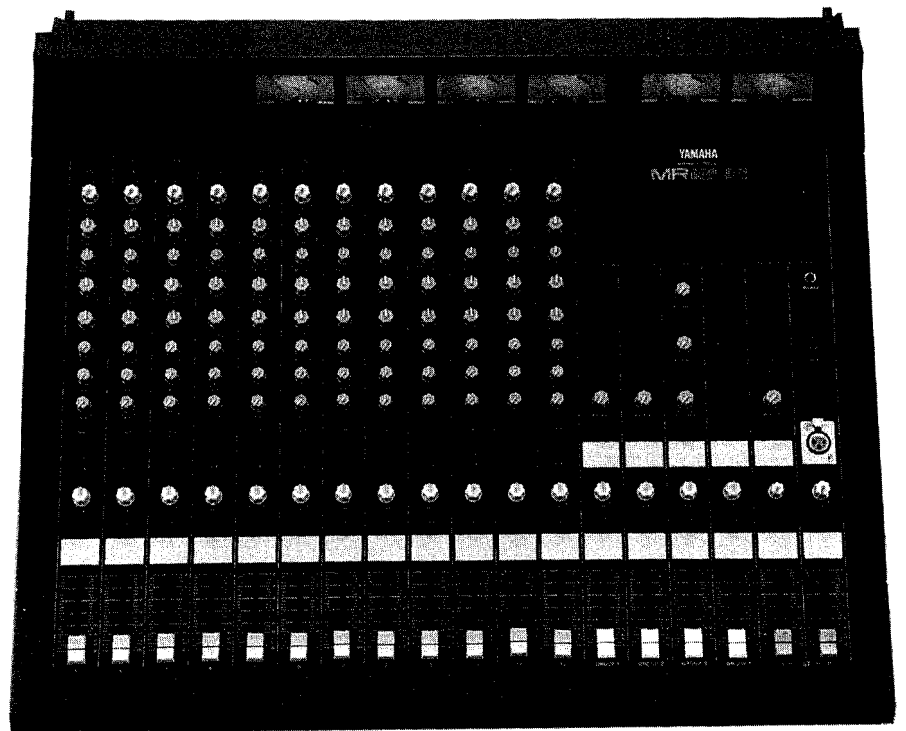

■ CONTENTS (目次)

SPECIFICATIONS (総合仕様)	2
PANEL LAYOUT (パネルレイアウト)	6
BLOCK & LEVEL DIAGRAM (ブロック & レベルダイアグラム)	8
CIRCUIT BOARD LAYOUT (ユニットレイアウト)	10
DIMENSIONS (寸法図)	11
IC BLOCK DIAGRAM (IC ブロック図)	11
CIRCUIT BOARDS (シート基板図)	12
DISASSEMBLY PROCEDURE (分解手順)	24
PARTS LIST	

LM 006910

YAMAHA CORP.

HAMAMATSU, JAPAN

3.1K-613 Ⓢ Printed in Japan '89.8

IMPORTANT NOTICE

This manual has been provided for the use of authorized Yamaha Retailers and their service personnel. It has been assumed that basic service procedures inherent to the industry, and more specifically Yamaha Products, are already known and understood by the users, and have therefore not been restated.

WARNING: Failure to follow appropriate service and safety procedures when servicing this product may result in personal injury, destruction of expensive components and failure of the product to perform as specified. For these reasons, we advise all Yamaha product owners that all service required should be performed by an authorized Yamaha Retailer or the appointed service representative.

IMPORTANT: The presentation or sale of this manual to any individual or firm does not constitute authorization, certification, recognition of any applicable technical capabilities, or establish a principle-agent relationship of any form.

The data provided is believed to be accurate and applicable to the unit(s) indicated on the cover. The research, engineering, and service departments of Yamaha are continually striving to improve Yamaha products. Modifications are, therefore, inevitable and changes in specification are subject to change without notice or obligation to retrofit. Should any discrepancy appear to exist, please contact the distributor's Service Division.

WARNING: Static discharges can destroy expensive components. Discharge any static electricity your body may have accumulated by grounding yourself to the ground buss in the unit (heavy gauge black wires connect to this buss).

IMPORTANT: Turn the unit OFF during disassembly and parts replacement. Recheck all work before you apply power to the unit.

■ SPECIFICATIONS

Total Harmonic Distortion

Less than 0.1%, 20 Hz — 20 kHz, @+14 dB output into 600 ohms.

Frequency Response

+1, -3 dB, 20 Hz — 20 kHz, @+4 dB output into 600 ohms.

Hum & Noise (20 Hz — 20 kHz, $R_s=150\ \Omega$, input pad @ 0 dB, input sensitivity @ -60 dB)

-128 dB equivalent input noise.
 -90 dB residual output noise.
 -73 dB (77 dB S/N) at GROUP OUT, Master fader nominal, all channel faders minimum.
 -64 dB (68 dB S/N) at GROUP OUT, Master and one channel fader nominal.
 -70 dB (74 dB S/N) at AUX SEND, Master fader nominal, all channel AUX controls minimum.
 -64 dB (68 dB S/N) at AUX SEND, Master fader and one AUX send control nominal.

Maximum Voltage Gain

84 dB CH IN to GROUP OUT
 94 dB CH IN to STEREO OUT
 94 dB CH IN to AUX SEND 1
 84 dB CH IN to AUX SEND 2—3
 20 dB AUX RETURN 1—2 to GROUP OUT & STEREO OUT
 10 dB SUB IN to GROUP OUT, AUX SEND 1—3

Crosstalk

-60 dB at 1 kHz, adjacent channel inputs.
 -60 dB at 1 kHz, input to output.

Input Channel Gain Control

40 dB range (-60 — -20 dB), stop to stop.

Input Channel Pad Switch

0/20 dB attenuation.

Input Channel Equalization (15 dB maximum boost or cut)

HIGH: 10 kHz (shelving).
 MIDDLE: 350 Hz — 5 kHz (peaking).
 LOW: 100 Hz (shelving).

VU Meters (All meters calibrated for 0 VU = +4 dB output)

6 illuminated meters: GROUP 1/AUX 1, GROUP 2/AUX 2, GROUP 3/AUX 3, GROUP 4/CUE, STEREO L/R

Clip Indicators

LEDs for each input module: CLIP (red) lights when post-EQ signal is 3dB below clipping.

Peak Indicators

LED built into each VU meter. It turns on when output signal reaches +14dB.

Phantom Power

+48 V DC applied to electronically balanced inputs (via 6.8 k Ω current limiting/isolation resistors).

Power Requirements

Power requirements match local AC mains voltage and frequency in area where sold.

Power Consumption

MR842 : 70 W
 MR1242: 70 W
 MR1642: 70 W

Console Dimensions (W x H x D)

MR842 : 555 x 182 x 600 mm
 (21-7/8" x 7-3/16" x 23-5/8")
 MR1242: 695 x 182 x 600 mm
 (27-3/8" x 7-3/16" x 23-5/8")
 MR1642: 835 x 182 x 600 mm
 (32-7/8" x 7-3/16" x 23-5/8")

Net Weight

MR842 : 15 Kg (33 lbs 1 oz)
 MR1242: 18 Kg (39 lbs 11 oz)
 MR1642: 21 Kg (46 lbs 5 oz)

* 0dB = 0.775 Vrms.

Specifications and appearance subject to change without notice.

INPUT CHARACTERISTICS

INPUT TERMINALS				INPUT IMPEDANCE	SOURCE IMPEDANCE	SENSITIVITY*	INPUT LEVELS		CONNECTOR TYPE	
		PAD	GAIN				RATED LEVEL	MAXIMUM NON CLIPPING LEVEL		
CH INPUT (MR842 :1~8 MR1242 :1~12 MR1642 :1~16)	LO-Z	OFF (0dB)	-60dB	LO-Z = 3k Ω	50~600 Ω Microphones & 600 Ω Lines	-80dB (0.08mV)	-60dB (0.8mV)	-34dB (15.5mV)	XLR-3-31 type (Balanced) & Phone Jack (TRS) (Balanced)	
		HI-Z	-20dB	HI-Z = 10k Ω		-40dB (7.75mV)	-20dB (77.5mV)	+6dB (1.55V)		
	TAPE IN		ON (20dB)		10 k Ω	600 Ω Lines	-20dB (77.5mV)	0dB (775mV)	+20dB (7.75V)	RCA Pin Jack (Unbalanced)
					10 k Ω	600 Ω Lines	-30dB (24.5mV)	-10dB (245mV)	+20dB (7.75V)	Phone Jack (TRS) (Unbalanced)
AUX RETURN		(1, 2) stereo		10 k Ω	600 Ω Lines	-16dB (123mV)	+4dB (1.23V)	—	Phone Jack (TRS) (Unbalanced)	
INSERT IN	CH	(MR842 :1~8 MR1242 :1~12 MR1642 :1~16)		10 k Ω	600 Ω Lines	-26dB (38.8mV)	-6dB (388mV)	+20dB (7.75V)	Phone Jack (TRS) (Unbalanced)	
		GROUP (1~4)				-16dB (123mV)	-6dB (388mV)	+20dB (7.75V)	Phone Jack (TRS) (Unbalanced)	
SUB IN	GROUP (1~4) STEREO (L,R)			10 k Ω	600 Ω Lines	-6dB (388mV)	+4dB (1.23V)	+20dB (7.75V)	Phone Jack (Unbalanced)	
TALKBACK IN				4 k Ω	50~600 Ω Microphones	-70dB (0.25mV)	-50dB (2.45mV)	-24dB (48.9mV)	XLR-3-31 type (Balanced)	

OUTPUT CHARACTERISTICS

OUTPUT TERMINALS	OUTPUT IMPEDANCE	LOAD IMPEDANCE	OUTPUT LEVELS		CONNECTOR TYPE
			RATED LEVEL	MAXIMUM NON CLIPPING LEVEL	
GROUP OUT (1~4)	150 Ω	600 Ω Lines	+4dB (1.23V)	+24dB (12.3V)	XLR-3-32 type (Balanced)
	600 Ω	10 k Ω Lines	-10dB (245mV)	+10dB (2.45V)	RCA Pin Jack x2 (Unbalanced)
STEREO OUT (L, R)	150 Ω	600 Ω Lines	+4dB (1.23V)	+24dB (12.3V)	XLR-3-32 type (Balanced)
	600 Ω	10 k Ω Lines	-10dB (245mV)	+10dB (2.45V)	RCA Pin Jack (Unbalanced)
AUX SEND (1~3)	150 Ω	600 Ω Lines	+4dB (1.23V)	+20dB (7.75V)	Phone Jack (Unbalanced)
INSERT OUT	600 Ω	10 k Ω Lines	(MR842 :1~8 MR1242 :1~12 MR1642 :1~16)		Phone Jack (TRS) (Unbalanced)
CH			-6dB (388mV)	+20dB (7.75V)	
MONITOR OUT (L, R)	600 Ω	10 k Ω Lines	+4dB (1.23V)	+20dB (7.75V)	Phone Jack (Unbalanced)
PHONES OUT	100 Ω	8 Ω Phones	1mW	20mW	STEREO Phone Jack (Unbalanced)
		40 Ω Phones	3mW	130mW	

*Input level required to produce rated +4dB output level.
0dB = 0.775 Vrms.

■総合仕様

周波数特性	20Hz~20kHz ± 1 dB (@600 Ω , +4dB)	
全高調波歪率	0.1%以下 (20Hz~20kHz) (@600 Ω , +4dB)	
ノイズレベル		
入力換算ノイズ	-128dB (Rs=150 Ω)	
残留ノイズ	-90dB	
GROUP OUT	-73dB (77dB S/N)	GROUP OUT Master fader →nominal All CH fader→minimum
GROUP OUT	-64dB (68dB S/N)	GROUP OUT Master fader →nominal One input fader→nominal
AUX SEND	-68dB (72dB S/N)	AUX SEND Master level control →nominal All CH mix level controls →minimum
AUX SEND	-64dB (68dB S/N)	AUX SEND Master level control →nominal One CH mix level control →nominal

最大電圧利得

CH INPUT→GROUP OUT	84dB
CH INPUT→STEREO OUT	84dB
CH INPUT→AUX SEND1,2	94dB
CH INPUT→AUX SEND3	84dB
AUX RETURN1,2→GROUP OUT	20dB
SUB INPUT→GROUP OUT, AUX SEND1-3	10dB

クロストーク (1kHz)

Adjacent input CH	60dB
Input to Output	60dB

入力ゲインコントロール 40dB (-60~-20dB)

入力パッドスイッチ 0/20dBアッテネーション

イコライザー特性

HIGH	± 15 dB(10kHzシェルビング)	
MIDDLE	± 15 dB(350Hz~5kHzピーキング)	
LOW	± 15 dB(100Hzシェルビング)	

VUメータ (0VU=+4dB)

STEREO L,R
GROUP1~4/AUX1~3, CUE

ピークインジケータ

INPUT (赤)	クリッピングの手前3dBで点灯
VU (赤)	0VUより10dB上で点灯

ファンタム電源

DC+48Vは、6.8k Ω のアイソレーション抵抗を経て、給電されます。

定格電源電圧・周波数 AC100V, 50/60Hz

消費電力

MR842	55W
MR1242	57W
MR1642	60W

寸法 (W×H×D)

MR842	555×182×600mm
MR1242	695×182×600mm
MR1642	835×182×600mm

重量

MR842	15kg
MR1242	18kg
MR1642	21kg

■入力仕様

Input Terminal	PAD	Gain Trim	Actual Load Impedance	For Use With Nominal	Input Level			Connector In Mixer
					Sensitivity	Nominal	Max. before clip	
CH Input * HI-Z	0	-60	Lo Z=3k Ω	50 ~ 600 Ω Mics	-80dB (0.08mV)	-60dB (0.8mV)	-34dB (15.5mV)	XLR-3-31 type
	0	-20	Hi Z=10k Ω	&	-40dB (7.75mV)	-20dB (77.5mV)	+6dB (1.55V)	&
	20			600 Ω Lines	-20dB (77.5mV)	0dB (775mV)	+20dB (7.75V)	Phone Jack (TRS)
TAPE IN			10k Ω	600 Ω Lines	-30dB (24.5mV)	-10dB (245mV)	+20dB (7.75V)	RCA Pin Jack
AUX RETURN (1,2) stereo			10k Ω	600 Ω Lines	-16dB (123mV)	+4dB (1.23V)		Phone Jack
INSERT IN CH(1*)			10k Ω	600 Ω Lines	-26dB (38.8mV)	-6dB (388mV)	+20dB(7.75V)	Phone Jack (TRS)
			10k Ω	600 Ω Lines	-16dB (123mV)	-6dB (388mV)	+20dB(7.75V)	Phone Jack (TRS)
SUB IN GROUP(1,4) STEREO(L,R)			10k Ω	600 Ω Lines	-6dB (388mV)	+4dB (1.23V)	+20dB(7.75V)	Phone Jack
TALK BACK IN			4k Ω	50 ~ 600 Ω Mics	-70dB (0.25mV)	-50dB (2.45mV)	-24dB (48.9mV)	XLR-3-31 type

• CH XLRタイプコネクタ及びPhone Jackはバランス型です(T=+, R=, S=GND)。
他のPhone Jack 及びRCA Pin Jack, INSERT Phone Jackはアンバランス型です(T=OUT, R=IN, S=GND)。
TALK BACK IN XLRタイプコネクタはアンバランス型です。

• 0 dB=0.775V RMS

• ※CH INPUTナンバーは、MR842=8CH、MR1242=12CH、MR1642=16CHです。

■出力仕様

Output Terminals	Actual Source Impedance	For Use With Nominal	Output Level		Connector In Mixer
			Nominal	Max. before clip	
GROUP OUT (1 4)	150 Ω	600 Ω Lines	+4dB(1.23V)	+24dB(12.3V)	XLR-3-32 type
	600 Ω	10k Ω Lines	-10dB(388mV)	+10dB(3.88V)	RCA Pin Jack x 2
STEREO OUT(L,R)	150 Ω	600 Ω Lines	+4dB(1.23mV)	+24dB(12.3V)	XLR-3-32 type
	600 Ω	10k Ω Lines	-10dB(388mV)	+10dB(3.88V)	RCA Pin Jack
AUX SEND (1 3)	150 Ω	600 Ω Lines	+4dB(1.23V)	+20dB(7.75V)	Phone Jack
INSERT OUT CH(1*) GROUP(1 4)	600 Ω	10k Ω Lines	-6dB(388mV)	+20dB(7.75V)	Phone Jack (TRS)
MONITOR OUT (L, R)	600 Ω	10k Ω Lines	+4dB(1.23V)	+20dB(12.3V)	Phone Jack
PHONE OUT	100 Ω	8 Ω phones	1mW	20mW	STEREO Phone Jack
		40 Ω phones	3mW	130mW	

• XLRタイプコネクタはバランス型、Phone Jack、RCA Pin Jackはアンバランス型です。INSERT Phone Jack(T=OUT, R=IN, S=GND)

• 0 dB=0.775V RMS

• ※C H ナンバーは、MR842=8チャンネル、MR1242=12チャンネル、MR1642=16チャンネルです。

■ PANEL LAYOUT (パネルレイアウト)

● Front Panel (フロントパネル)

● Input Channels

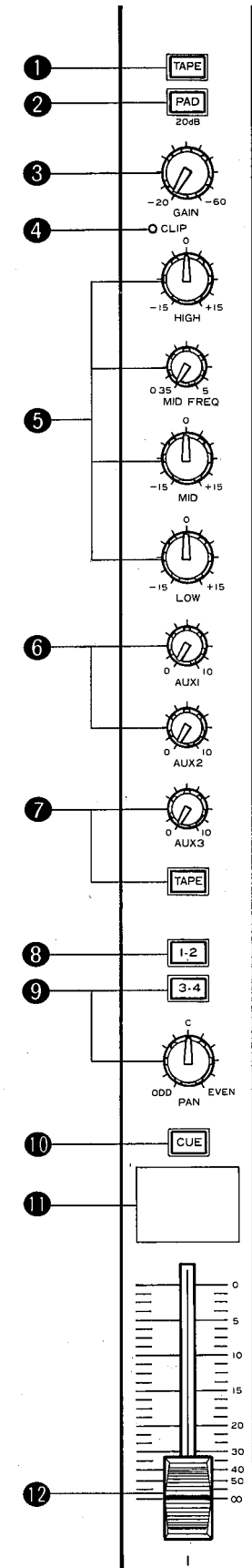

● Master Control Section

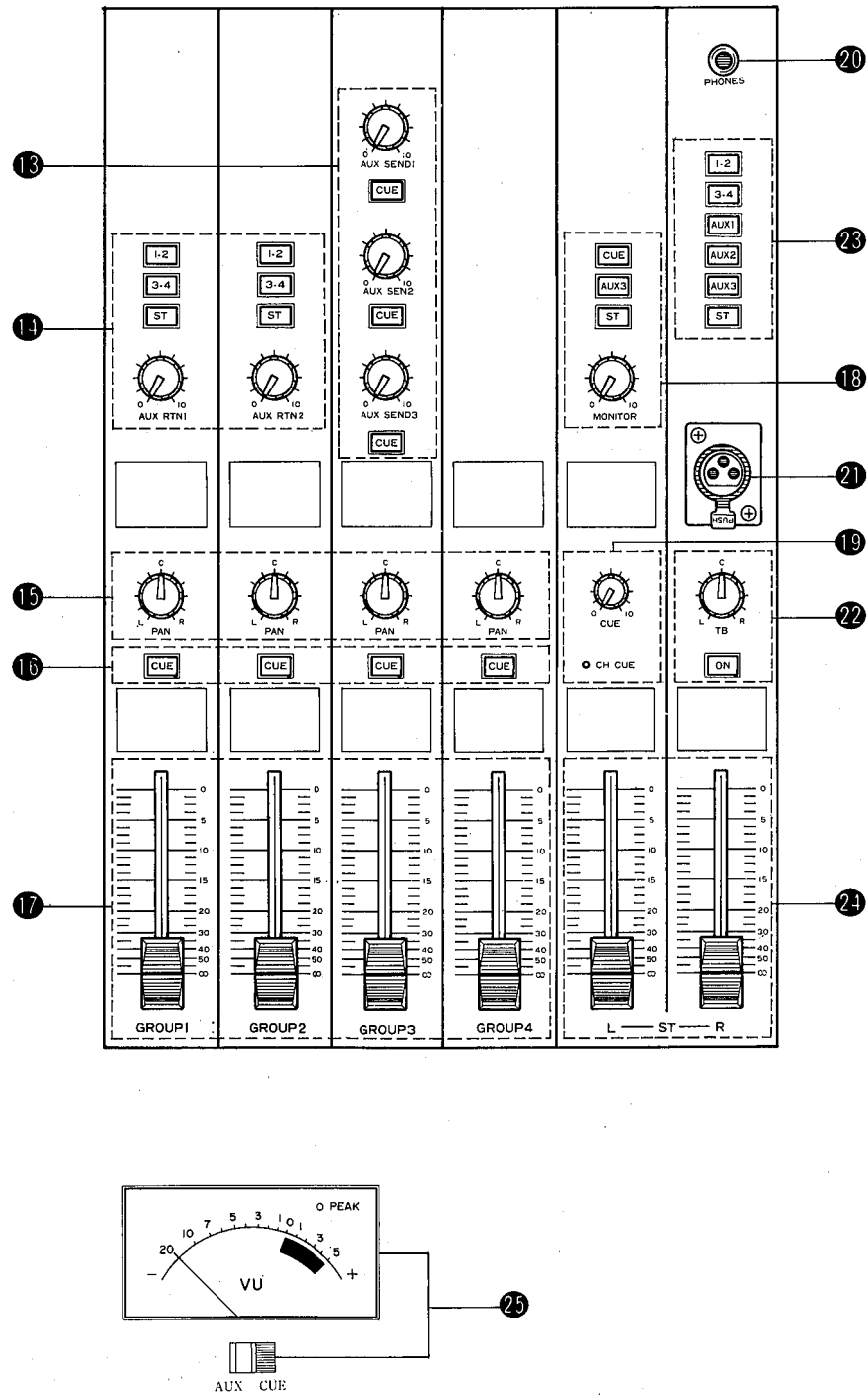

- ① TAPE Switch
- ② PAD Switch
- ③ GAIN Control
- ④ CLIP LED Indicator
- ⑤ 3-band Equalizer
- ⑥ AUX 1 & 2 Controls
- ⑦ AUX 3 Control & TAPE Switch
- ⑧ Group Assign Switches
- ⑨ PAN Control
- ⑩ CUE Switch
- ⑪ Label Space
- ⑫ Channel Fader
- ⑬ AUX SEND 1, 2 & 3 Controls/CUE Switches
- ⑭ AUX RTN 1 & 2 Controls & Assignment Switches
- ⑮ Group PAN Controls
- ⑯ Group CUE Switches
- ⑰ GROUP Faders
- ⑱ MONITOR Control & Source Select Switches
- ⑲ CUE Level Control & CH CUE Indicator
- ⑳ PHONES Jack
- ㉑ Talkback Microphone Connector
- ㉒ TB Level Control & ON Switch
- ㉓ Talkback Assignment Switches
- ㉔ ST L & R Faders
- ㉕ VU Meters and Select Switches

- ① テープスイッチ
- ② アッテネータスイッチ
- ③ ゲインコントロール
- ④ クリップインジケータ
- ⑤ 3バンドイコライザ
- ⑥ AUX 1, 2 コントロール
- ⑦ AUX 3 コントロール, テープスイッチ
- ⑧ アサインスイッチ
- ⑨ パンコントロール
- ⑩ キュースイッチ
- ⑪ ラベル
- ⑫ チャンネルフェーダー
- ⑬ AUX SEND 1~3, キュースイッチ
- ⑭ AUXリターン 1, 2, アサインスイッチ
- ⑮ パンコントロール
- ⑯ キュースイッチ
- ⑰ グループフェーダー
- ⑱ モニターセレクトスイッチ, モニターレベルコントロール
- ⑲ キューレベルコントロール, チャンネルキューインジケータ
- ⑳ ヘッドホンジャック
- ㉑ トークバックインプット
- ㉒ トークバックレベルコントロール, オンスイッチ
- ㉓ トークバックアサインスイッチ
- ㉔ ステレオL, Rフェーダー
- ㉕ VUメーターセレクトスイッチ

● Rear Panel (リアパネル)

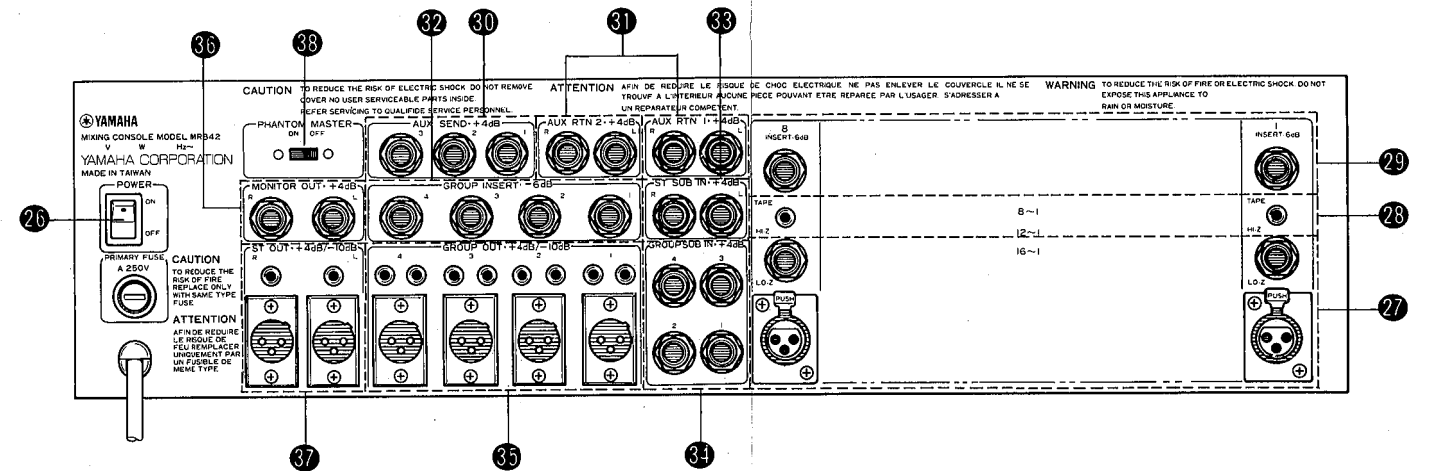

- ㉖ POWER Switch
- ㉗ HI-Z and LO-Z Input Connectors
- ㉘ TAPE Input Jack
- ㉙ INSERT -6dB Jack
- ㉚ AUX SEND +4dB 1, 2 & 3 Jacks
- ㉛ AUX RTN +4dB 1 (L & R) & 2 (L & R) Jacks
- ㉜ GROUP INSERT 1, 2, 3 & 4 Jacks
- ㉝ STEREO L SUB IN & STEREO R SUB IN Jacks
- ㉞ GOURP SUB IN +4dB 1, 2, 3 & 4 Jacks
- ㉟ GOURP OUT +4dB/-10dB 1, 2, 3 & 4 Connectors
- ㊱ MONITOR OUT +4dB L & R Jacks
- ㊲ ST OUT +4dB/-10dB L & R Jacks
- ㊳ PHANTOM MASTER Switch

- ㉖ パワースイッチ
- ㉗ チャンネルインプット
- ㉘ テープ入力ジャック
- ㉙ INSERT -6dBジャック
- ㉚ AUX SEND 1~3 +4dB
- ㉛ AUX RETURN L・R/+4dB
- ㉜ GROUP INSERT IN/OUT -6dB
- ㉝ STEREO L・R SUB IN
- ㉞ GROUP SUB IN +4dB 1~4
- ㉟ GROUP OUT +4dB/-10dB
- ㊱ MONITOR OUT L/R +4dB
- ㊲ STEREO OUT L/R +4dB
- ㊳ ファンタムスイッチ

■BLOCK&LEVEL DIAGRAM(ブロック&レベルダイアグラム)

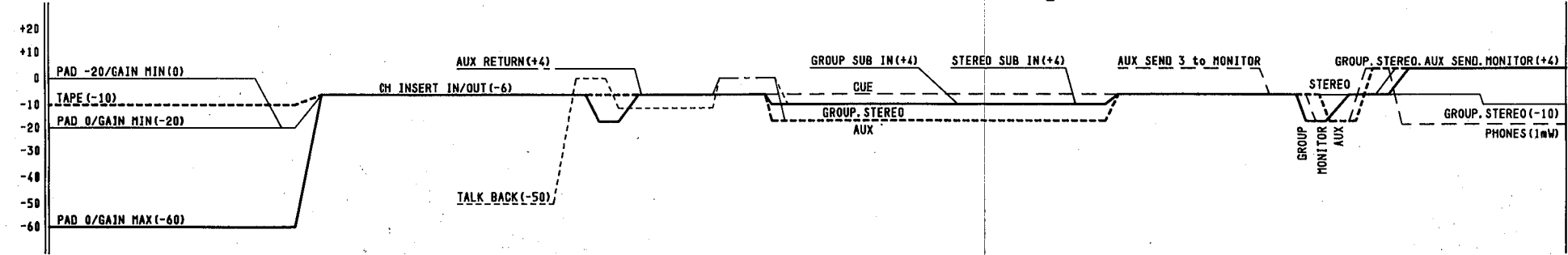
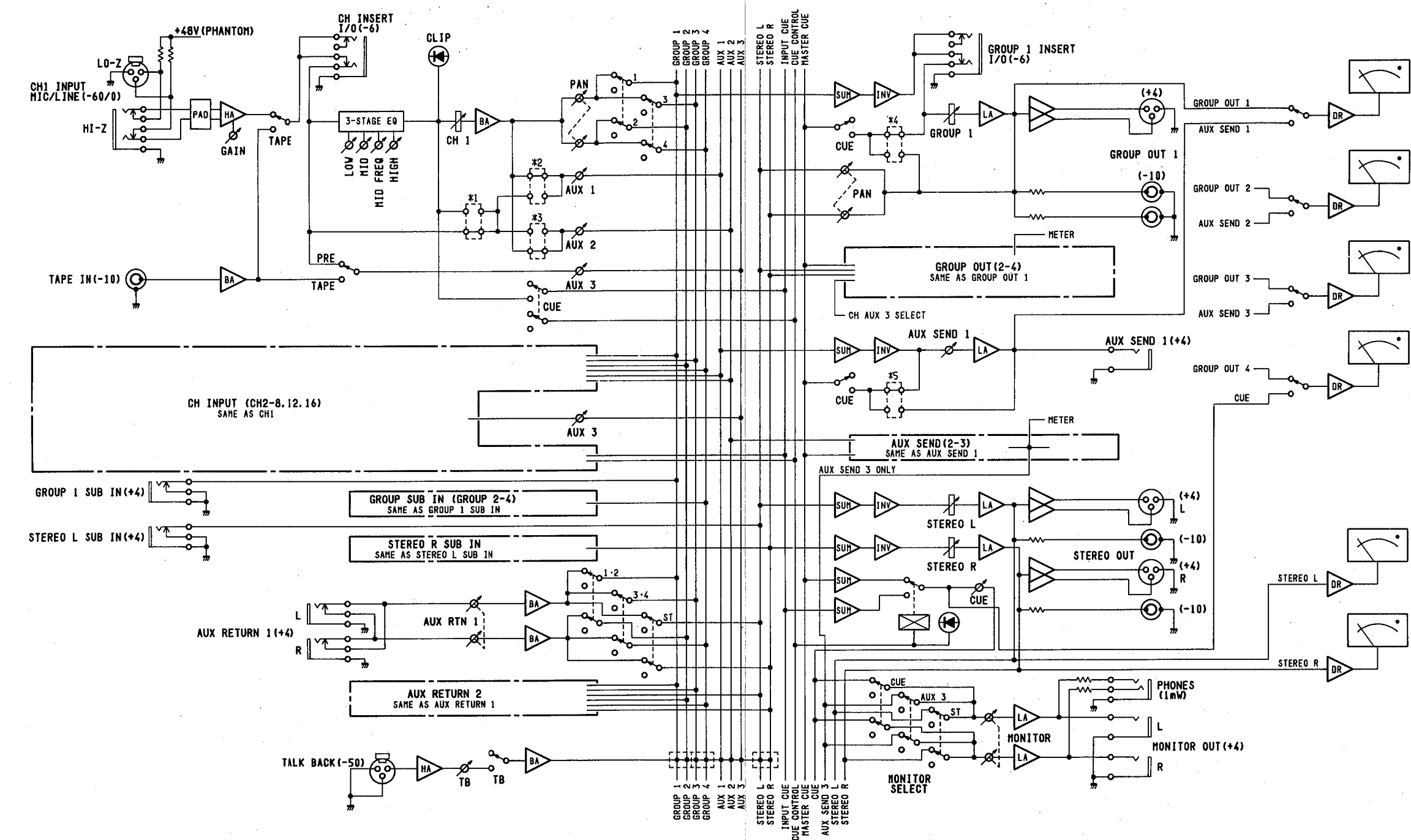

- *1 AUX 1.2 PRE EQ/POST EQ JUMPER
- *2 AUX 1 POST FADER/PRE FADER JUMPER
- *3 AUX 2 PRE FADER/POST FADER JUMPER
- *4 GROUP CUE PFL/AFL JUMPER
- *5 AUX SEND CUE PFL/AFL JUMPER
- * 0dB=0.775V
- ** CLIP LED TURN ON LEVEL=-3dB BEFORE CLIP(+17dB)
- *** LED PEAK METER 0VU=+4dB
- **** ANALOG METER 0VU=+4dB
- ***** PEAK LED TURN ON LEVEL=-10dB BEFORE CLIP(+14dB)
- ***** CUE VOLUME NOMINAL POSITION=MAXIMUM
- ***** OTHER FADER & VOLUME NOMINAL POSITION=-10dB POINT

■CIRCUIT BOARD LAYOUT (ユニットレイアウト) MR842

● Front Panel (フロントパネル)

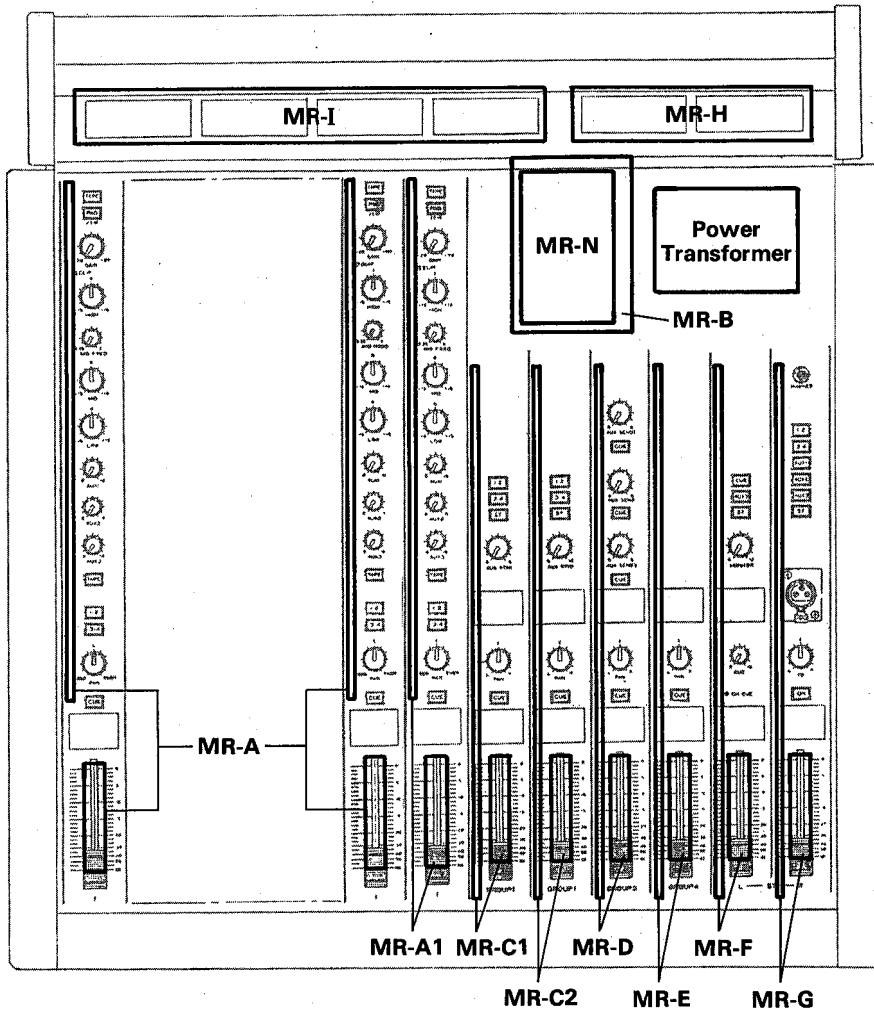

● Rear Panel (リアパネル)

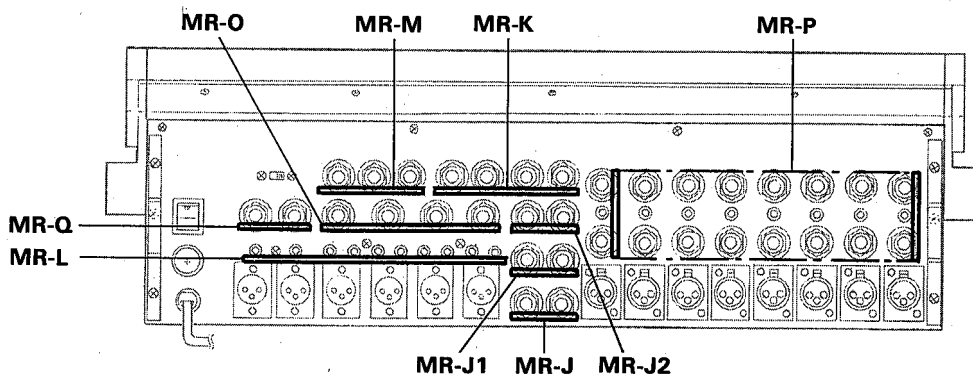

* The circuit boards listed below are essentially the same each other except the connector assemblies located on it. (下に掲げる各シートは、基本的に共通シートですが、シート上に接続されている束線類が異なります。)

- ① A circuit board — A1 circuit board
- ② C1 circuit board — C2 circuit board
- ③ P circuit board — P1 circuit board
- ④ J circuit board — J1 circuit board — J2 circuit board

	P circuit board	P1 circuit board
MR842	Ch. 1—Ch. 8	X
MR1242	Ch. 1—Ch. 12	X
MR1642	Ch. 1—Ch. 12	Ch.13-Ch.16

DIMENSIONS (寸法図)

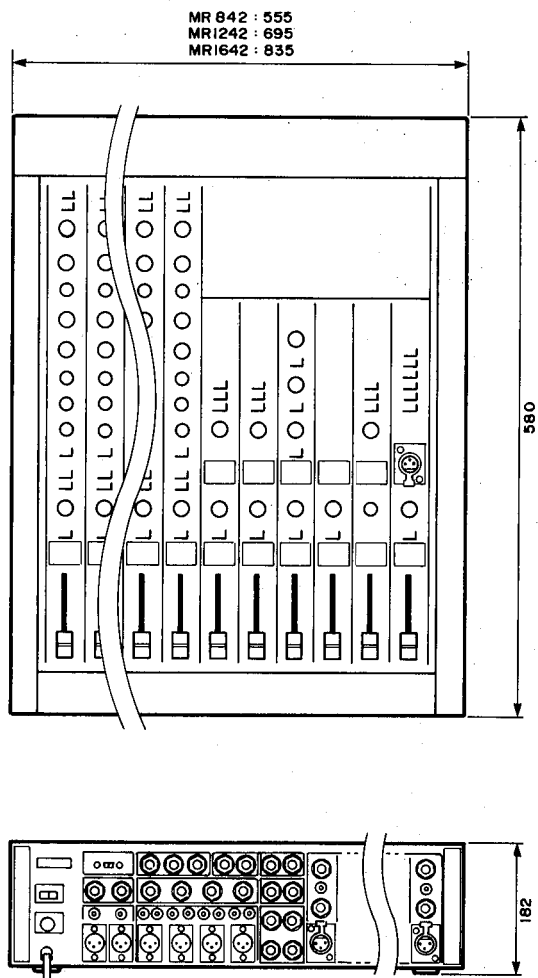

Unit = mm
(単位)

IC BLOCK DIAGRAM (IC ブロック図)

- NJM4558DV (IG001390)
 - NJM4556 (IG042500)
 - NJM2068D (IX801490)
- Dual Operational Amplifier

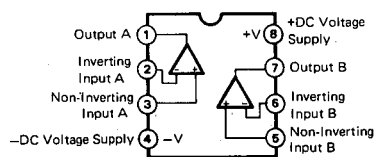

■CIRCUIT BOARDS (シート基板図)

●MR-A & MR-A1 Circuit Boards

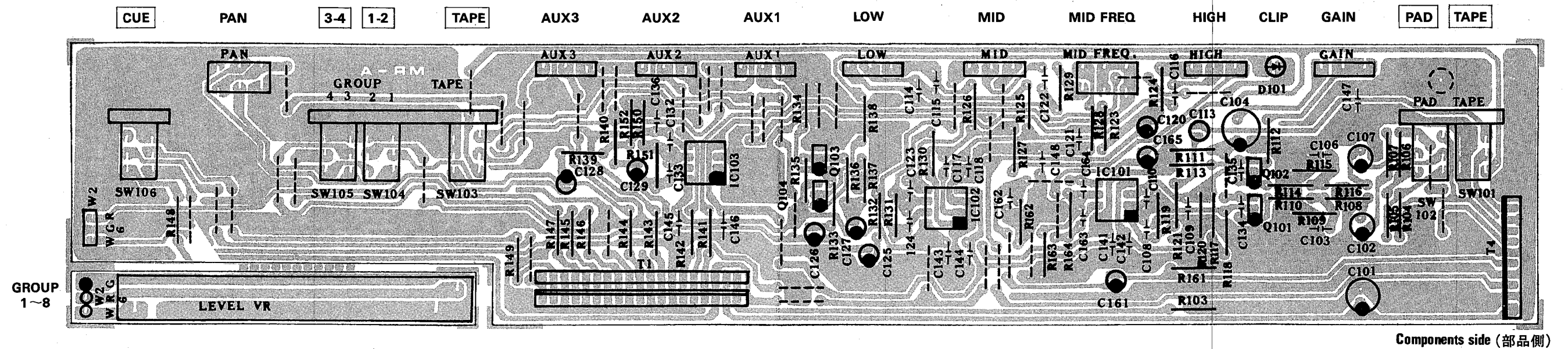

●MR-B Circuit Board

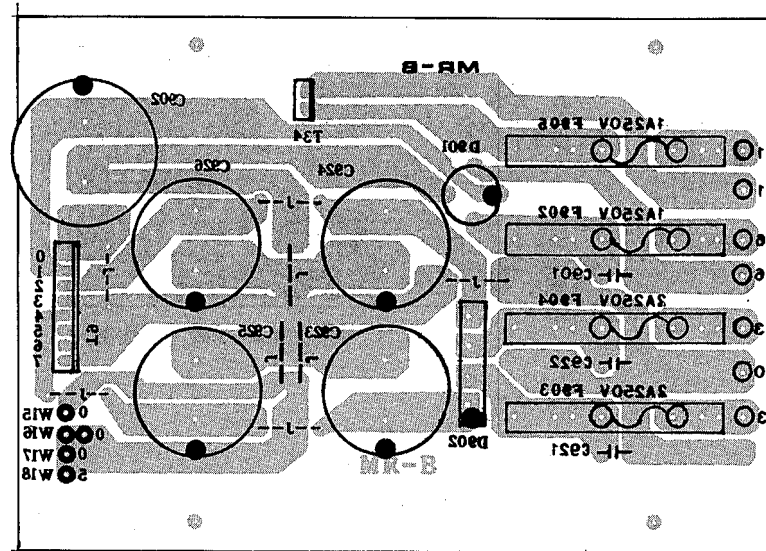

Pattern side (パターン側)

Notes)

- * Circuit Board: MR-A (NX806650)
- * Circuit Board: MR-A1 (NX807630)

- IC
IC 101-103: NJM4558DV (IG001390) OP AMP.
- Transistor
Q 101-102: 2SA970 BL (IA097010)
Q 103: 2SC1313 (IX802930)
Q 104: 2SA726 (IX802920)
- LED
D 101: 103HD φ 2 RED (IX802980) CLIP
- Rotary VR
VR 101: -05C10K (HX801960) V16L4 N15KC GAIN
VR 102, 104, 105: -B50kc.c. (HX801970) V16L4 N15KC HI, MID, LO
VR 103: -15C100Kx2 (HX802010) V16L4 N15KCG3-1 MID FREQ
VR 106-108: -15A25K (HX801980) V16L4 N15KC AUX1, 2, 3
VR 109: -15A25Kx2 (HX802000) V16L4 N15KCG3-1 PAN
- Slide VR
VR 110: RS60Y11G4023- (HX802030) 10KA-PJ Fader
- Push Switch
SW 101: SPUE20AE08-PJ (KX801930) TAPE, PAD
SW 103: SPUE30AE24-PJ (KX801920) TAPE, 1-2, 3-4
SW 106: KPB122-SNAL (KX800750) CUE

Notes)

- * Circuit Board: MR-B (NX806660)

- Diode Bridge
PBL405 (IX802950)
2W06 (IX802960)
- Ceramic Cap.
C 901: 4700pF DC500V (HX802090)
C 921, 922: 4700pF DC250V (HX802080)
- Electrolytic Cap.
C 902: 1000 μF 100V (FL299100)
C 923-926: 3300 μF 35V (FL259330)

	A circuit board	A1 circuit board
MR842	Ch. 1-Ch. 7	Ch. 8
MR1242	Ch. 1-Ch. 11	Ch.12
MR1642	Ch. 1-Ch. 15	Ch.16

* The A1 circuit board is essentially the same as a A circuit board. The difference of A1 circuit board from A are Connector assembly T1 and T2.

(A1シートは、基本的にはAシートと同一のシートです。両者の相違点は、コネクタ Ass'y T1とT2のみです。)

●MR-C1 & MR-C2 Circuit Boards

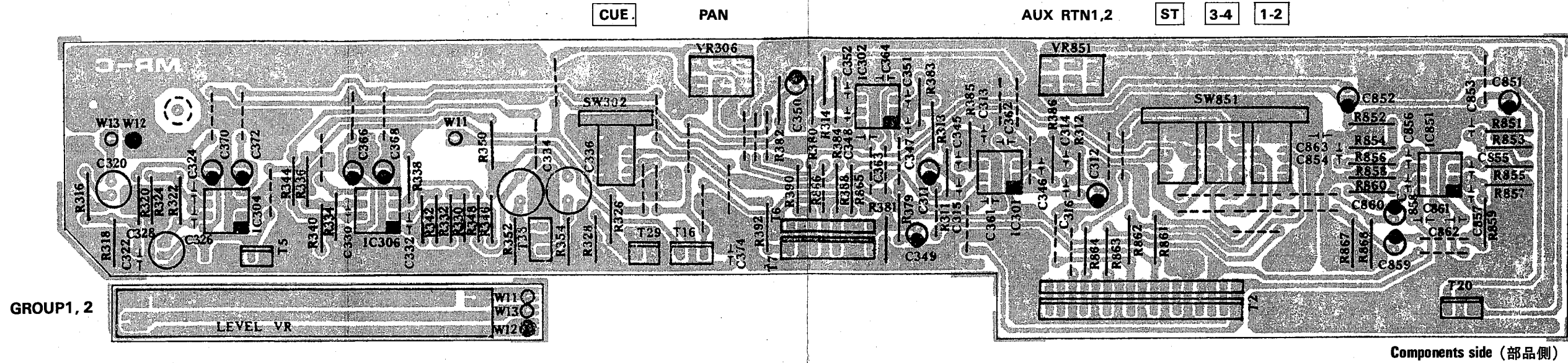

●MR-D Circuit Board

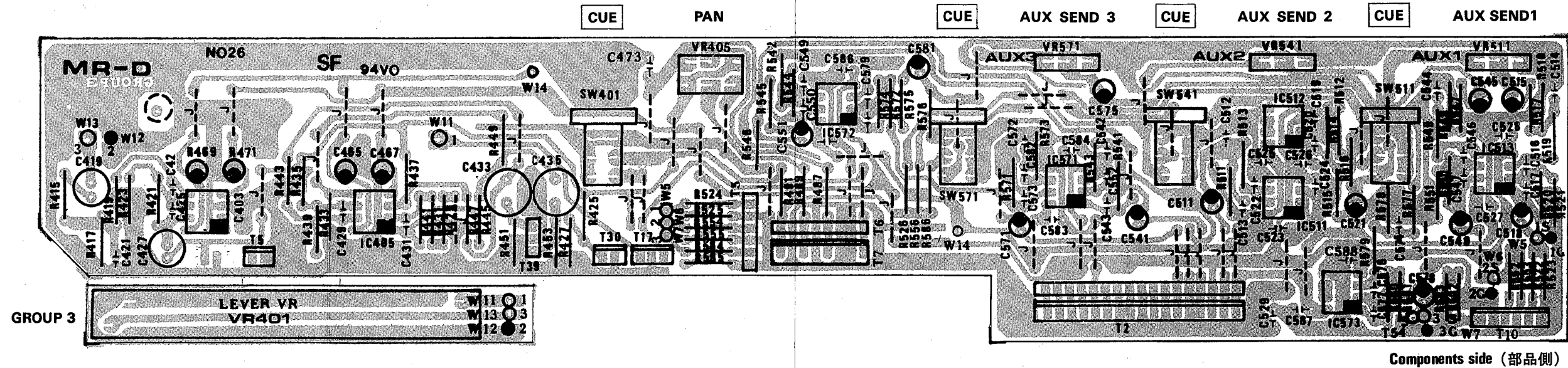

Notes)

- * Circuit Board: MR-C1 (NX806670) GROUP 1
- * Circuit Board: MR-C2 (NX807640) GROUP 2

- IC
IC 301: NJM2068D (IX801490) OP AMP.
IC 302-306: NJM4556 (IG042500) OP AMP.
IC 801 (851): NJM4558DV (IG001390) OP AMP.
- Rotary VR
VR 301 (306): -15A25Kx2 (HX802000) V16L4 N15KCG3-1 PAN
VR 801 (851): N15KC-25KAx2-C (HX805010) V16L4 G3-1 AUX RTN1, 2
- Slide VR
VR 302: RS60Y11G4023- (HX802030) 10KA-PJ GROUP Fader 1, 2
- Push Switch
SW 302: KPB122-SNAL (KX800750) CUE
SW 851: SPUE30AE25-PJ (KX801820) 1-2, 3-4, ST

* The C2 circuit board is essentially the same as a C circuit board. The difference of C2 circuit board from C1 is the length of wires of connector.

(C1シートとC2シートは、基本的に同一のシートですが、コネクタからの束線の長さが違います。)

Notes)

- * Circuit Board: MR-D (NX806680) GROUP 3

- IC
IC 403, 405, 513, 573: NJM4556 (IG042500) OP AMP.
IC 511, 571: NJM2068D (IX801490) OP AMP.
IC 512, 572: NJM4558DV (IG001390) OP AMP.
- Rotary VR
VR 405: N15KC-25KA-C (HX805010) V16L4 G3-1 PAN
VR 511, 541, 571: -15A10K (HX805020) V16L4N15KC AUX SEND1, 2, 3
- Slide VR
VR 402: RS60Y11G4023- (HX802030) 10KA-PJ GROUP 3 Fader
- Push Switch
SW 401, 511, 541, 571: KPB122-SNAL (KX800750) CUE

●MR-E Circuit Board

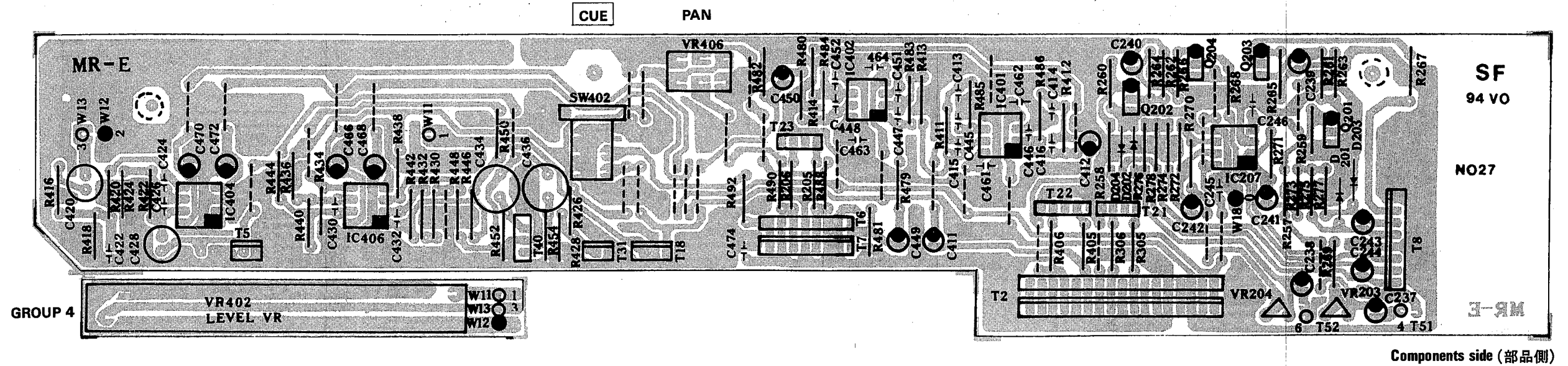

●MR-F Circuit Board

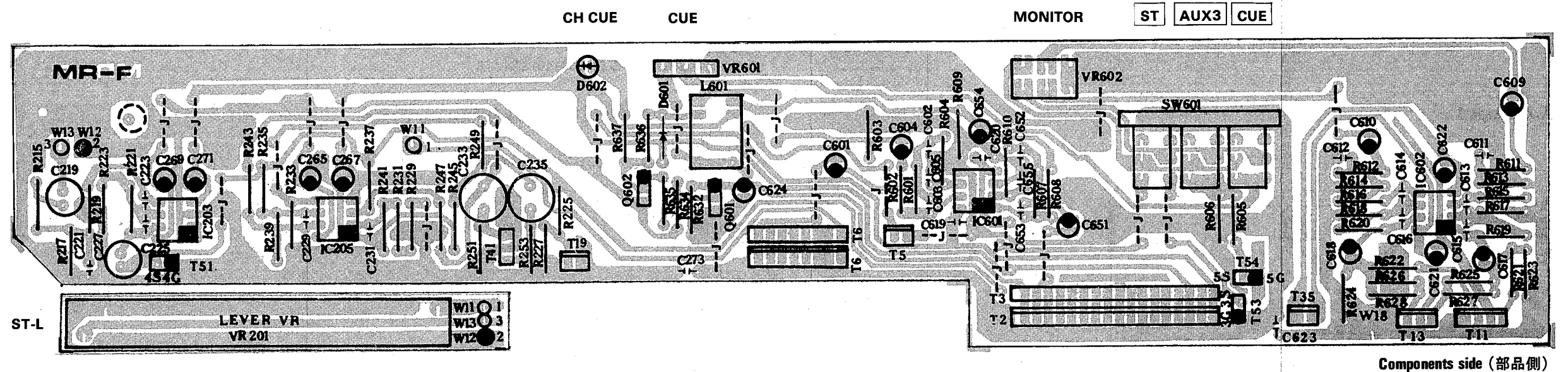

Notes)

* Circuit Board: MR-E (NX806690) GROUP 4

- | | |
|-------------------|--|
| 1. IC | |
| IC 401: | NJM2068D (XA987001) OP AMP. |
| IC 402, 404, 406: | NJM4556 (IG042500) OP AMP. |
| 2. Transistor | |
| Q 201, 202: | 2SC1313 (IX802930) |
| Q 203, 204: | 2SA726 (IX802920) |
| 3. Diode | |
| D 201-204: | 1N60P (IF000620) |
| 4. Rotary VR | |
| VR 406: | -15A25Kx2 (HX802000) V1614 N15KCG3-1 PAN |
| 5. Slide VR | |
| VR 402: | RS60Y11G4023- (HX802030) 10KA-PJ GROUP 4 Fader |
| 6. Potentiometer | |
| VR 203, 204: | 50KB 3P (HX802040) PEAK LED adj. |
| 7. Push Switch | |
| SW 402: | KPB122-SNAL (KX800750) CUE |

Notes)

* Circuit Board: MR-F (NX806700) ST-L, MONITOR

- | | |
|-------------------|--|
| 1. IC | |
| IC 203, 205, 602: | NJM4556 (IG042500) OP AMP. |
| IC 601: | NJM4558DV (IG001390) OP AMP. |
| 2. Transistor | |
| Q 601: | 2SC1313 (IX802930) |
| Q 602: | 2SA726 (IX802920) |
| 3. Diode | |
| D 801: | 1N4001 (IX803100) |
| 4. LED | |
| D 602: | 103HD φ2 RED (IX802980) CH CUE |
| 5. Rotary VR | |
| VR 601: | -15A10K (HX805020) V16L4N15KC CUE |
| VR 602: | -15K10Kx2 (HX805000) V16L G3-1CN15KC MONITOR |
| 6. Slide VR | |
| VR 201: | RS60Y11G4023- (HX802030) 10KA-PJ ST-L |
| 7. Push Switch | |
| SW 601: | SPUE30AE23-PJ (KX801900) CUE, AUX 3, ST |

●MR-G Circuit Board

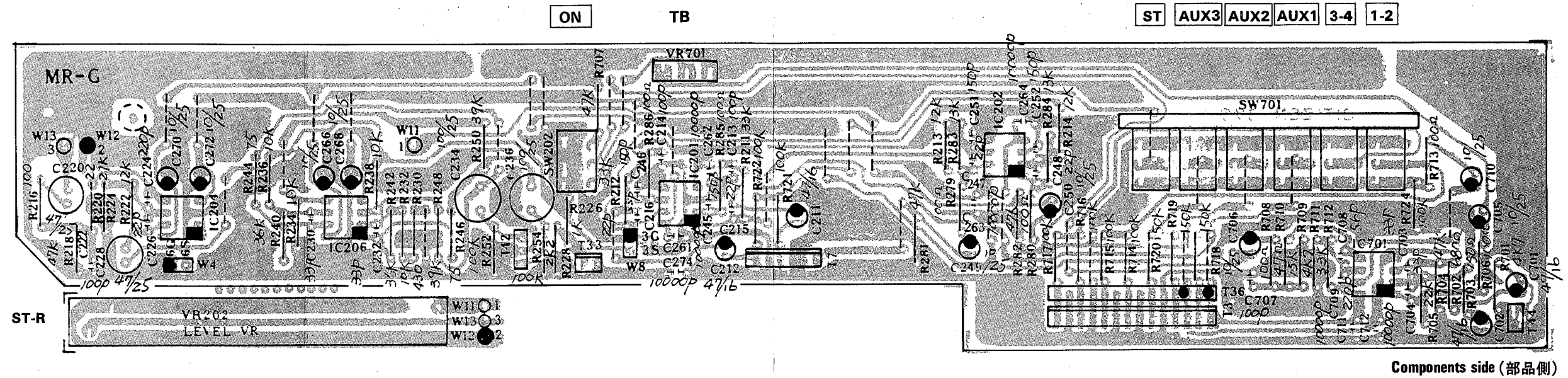

Components side (部品側)

Notes)

* Circuit Board: MR-G (NX806710) ST-R, TB

1. IC
IC 201, 202, 204, 206, NJM4556 (IG042500) OP AMP.
701:
2. Rotary VR
VR 701: -15A25K (HX801980) V16L4 N15KC TB
3. Slide VR
VR 202: RS60Y11G4023- (HX802030) 10KA-PJ ST-R
4. Push Switch
SW 202: KPB122-SNAL (KX800750) CUE ON
SW 701: SPUE60AE14-PJ (KX801810) 1-2, 3-4, AUX, ST

●MR-H Circuit Board

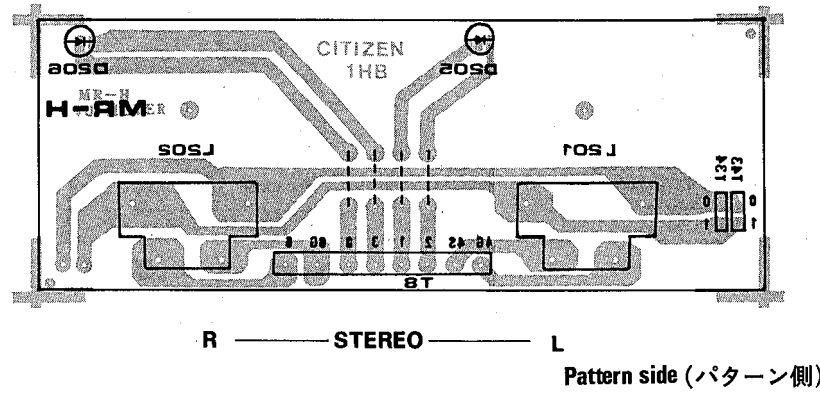

Pattern side (パターン側)

Notes)

* Circuit Board: MR-H (NX806720) VU meters (ST-L, R)

1. LED
D 205, 206: 103HD ϕ 2 RED (IX802980)
2. Analog Meter
L 201, 202: TN-72-8656 (CX804430) ST L, R

●MR-I Circuit Board

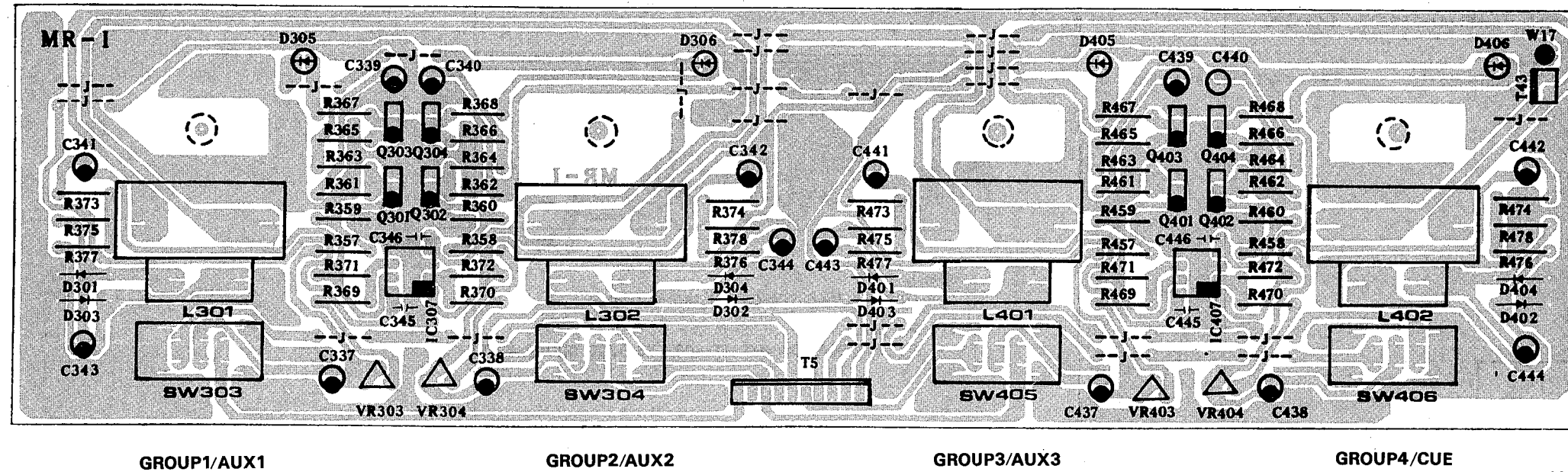

Notes)

* Circuit Board: MR-I (NX806730) VU meters (AUX/CUE)

1. IC
IC 307, 407: NJM4558DV (IG001390) OP AMP.
2. Transistor
Q 301, 302, 401, 402: 2SC1313 (IX802930)
Q 303, 304, 403, 404: 2SA726 (IX802920)
3. Diode
D 301-304, 401, 404: 1N60P (IF000620)
4. LED
D 305, 306, 405: 103HD φ2 RED (IX802980) PEAK
5. Potentiometer
VR 303, 304, 403, 404: 50KB 3P (HX802040) PEAK adj.
6. Slide Switch
SW 303, 304, 405, 406: SSSB222NF1-PJ (KX801910) GROUP 1-4
7. Analog Meter
L 301, 302, 401, 402: TN-72-8656 (CX804430)

●MR-J, MR-J1 & MR-J2 Circuit Boards

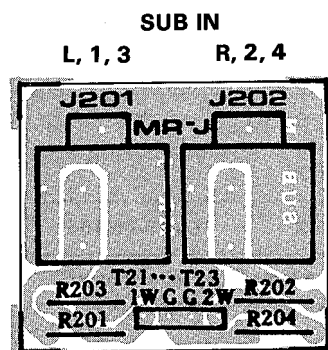

Components side (部品側)

- Notes)
- * Circuit Board: MR-J (NX806740) GROUP SUB IN 1, 2
 - * Circuit Board: MR-J1 (NX807650) GROUP SUB IN 3, 4
 - * Circuit Board: MR-J2 (NX807660) ST SUB IN

1. MIC Jack
J 201, 202: RDJ-245 (LX801230) SUB IN

The J1 (J2) circuit board is essentially the same as a J circuit board. The difference of J1 (J2) circuit board from J is only the length of wires of connector assembly.

(J, J1, J2の各シートは、基本的に同一のシートで、コネクタからの束線の長さのみが違ってきます。)

●MR-K Circuit Board

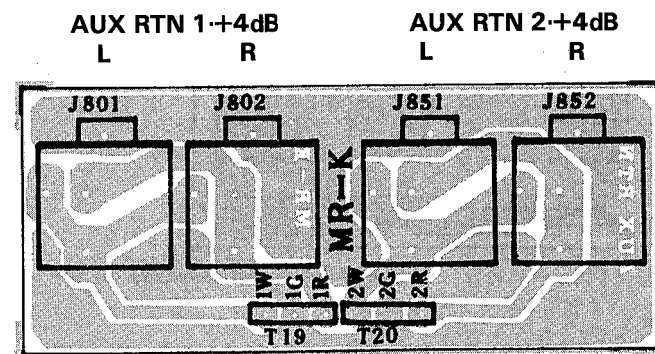

Components side (部品側)

- Notes)
- * Circuit Board: MR-K (NX806750) AUX RTN

1. MIC Jack
J 801, 802, 851, 852: RDJ-245 (LX801230) AUX RTN

●MR-L Circuit Board

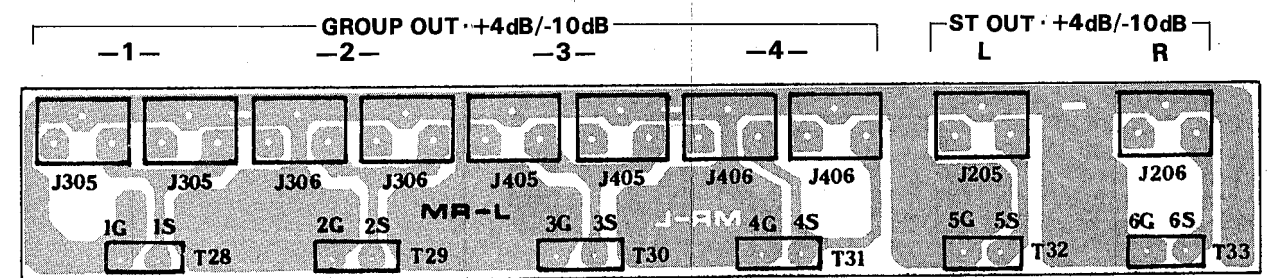

Components side (部品側)

- Notes)
- * Circuit Board: MR-L (NX806760) ST OUT, GROUP OUT

1. Pin Jack
J 205, 206, 305, 306, 405, 406: 211-00010-000 (LX802000) GROUP, ST OUT

●MR-M Circuit Board

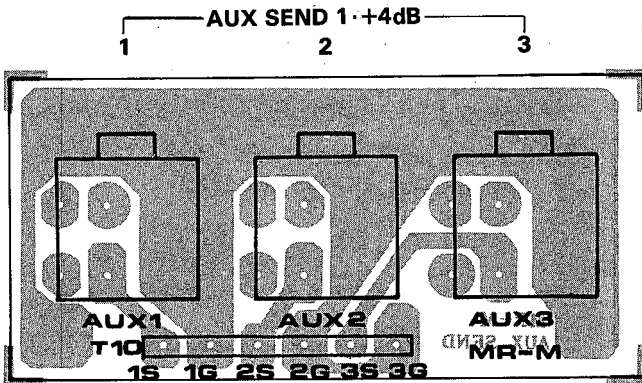

Components side (部品側)

Notes)

* Circuit Board: MR-M (NX806770) AUX SEND

- 1. MIC Jack
J 511, 541, 571: RDJ-245 (LX801230) AUX SEND

●MR-N Circuit Board

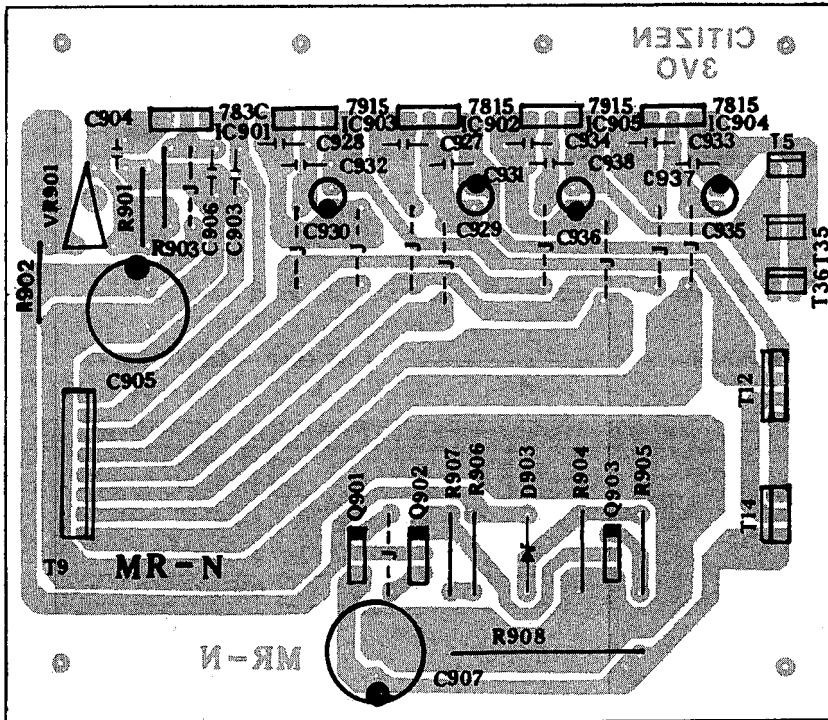

Components side (部品側)

Notes)

* Circuit Board: MR-N (NX806780)

- 1. IC
IC 901: TL783C (IX802890)
IC 902, 903: NJM7815 (IG147400) 15V Regulator
IC 904, 905: NJM7915 (IG147500) -15V Regulator
- 2. Transistor
Q 901: 2SC2167 (IX802940)
Q 902, 903: 2SC2240 BL (IC224010)
- 3. Zener Diode
D 901: 56V 1W (IX802970)
- 4. Potentiometer
VR 901: 10KB 3P (HX802050)
- 5. Mylar Cap.
C 904: 0.0047 μ F 100V (HX802060)
- 6. Ceramic Cap.
C 903, 906: 0.1 μ F 100 V (HX802070)
- 7. Electrolytic Cap.
C 905, 907: 100 μ F 100V (FJ298100)

●MR-O Circuit Board

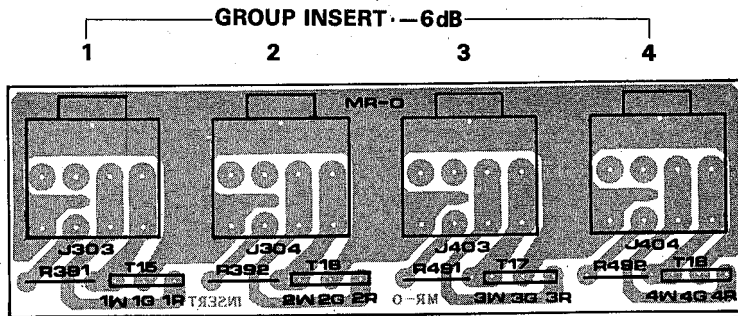

Components side (部品側)

Notes)

* Circuit Board: MR-O (NX806790) GROUP INSERT

- 1. MIC Jack
J 303, 304, 403, 404: RDJ-06 (LX801220) GROUP INSERT

●MR-P & MR-P1 Circuit Boards

INSERT: -6dB TAPE HI-Z/LO-Z

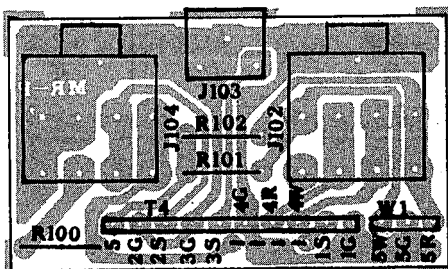

Components side (部品側)

Notes)

- * Circuit Board: MR-P (NX806800)
- * Circuit Board: MR-P1 (NX807670)

- 1. MIC Jack
J 102, 104: RDJ-06 (LX801220) INSERT, HI/LO
J 103: 211-00010-000 (LX802000) TAPE

	P circuit board	P1 circuit board
MR842	Ch, 1 - Ch. 8	X
MR1242	Ch, 1 - Ch. 12	X
MR1642	Ch, 1 - Ch. 12	Ch.13-Ch.16

- * The P1 circuit board is essentially the same as a P circuit board. The difference of P1 circuit board from P is only the Connector assembly.

(PシートとP1シートは基本的に同一のシートで、コネクタ Ass'yのみが異なります。)

●MR-Q Circuit Board

MONITOR OUT +4dB

L R

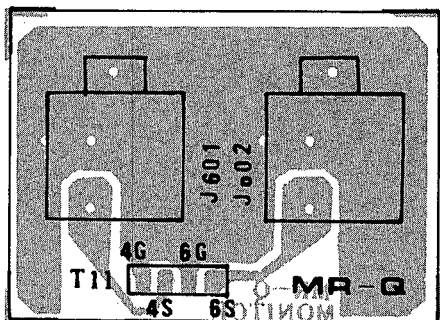

Components side (部品側)

Notes)

* Circuit Board: MR-Q (NX806810) MONITOR OUT

- 1. MIC Jack
J 601, 602: RDJ-245 (LX801230) MONITOR OUT

DISASSEMBLY PROCEDURE (分解手順)

1. Removal of Bottom Board

- Remove the 14 bind tapping screws ① (3x8), and bind head screws ② (4x8), the Bottom board can be removed (Fig.1).

1. 底板の外し方

- ・バインドタッピングネジ① (3×8) 14本とバインド小ネジ② (4×8) 1本を外し、外します。(Fig.1)

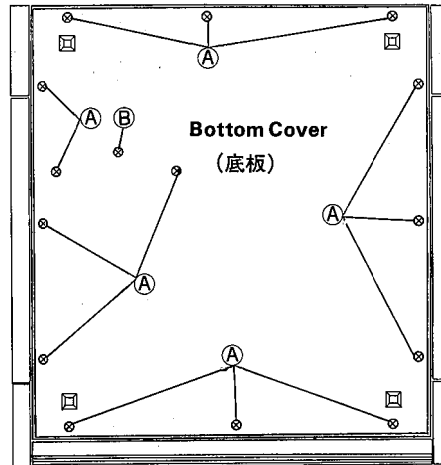

Fig. 1

2. Removal of MR-A (MR-A1) Circuit Board

- Pull out the 9 volume knobs ③ and slide knob. (Fig.2).
- Remove the hexagonal nuts. (Fig.2)
- Remove the Bottom board. (see procedure 1)
- Remove the bind tapping screw ④ (3x8), the MR-A (MR-A1) circuit board can be removed. (Fig.3)

2. MR-A (MR-A1) シートの外し方

- ・ポリウムツマミ③9個とスライドツマミを引き抜き、六角ナットを外します。(Fig.2)
- ・底板を外します。(1項参照)
- ・バインドタッピングネジ④ (3×8) を外し、MR-A (MR-A1) シートを外します。(Fig.3)

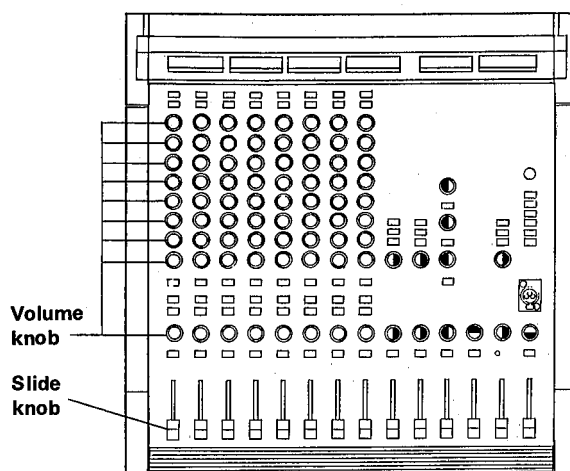

- ③ — Knob, Volume (ポリウムツマミ)
- ④ — Hexagonal Nut (六角ナット)

Fig. 2

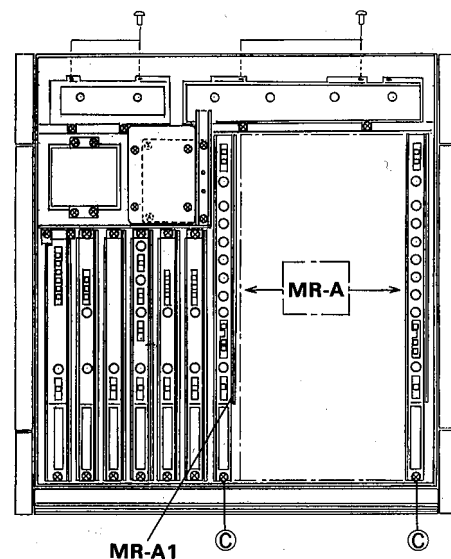

Fig. 3

3. Removal of MR-C1, MR-C2 & MR-F Circuit Boards

- Pull out the 2 volume knobs (C) and slide knob. (Fig.2)
- Remove the hexagonal nuts. (Fig.2)
- Remove the Bottom board. (see procedure 1)
- To remove the MR-C1(C2, F) circuit board, remove the 2 bind tapping screws (D) (3x8).

4. Removal of MR-D Circuit Board

- Pull out the 4 volume knobs (C) and slide knob. (Fig.2)
- Remove the hexagonal nuts. (Fig.2)
- Remove the Bottom board. (see procedure 1)
- After the 2 bind tapping screws (E) (3x8) have been removed, the MR-D circuit board can be removed. (Fig.4)

5. Removal of MR-E Circuit Board

- Pull out the volume knobs (C) and slide knob. (Fig.2)
- Remove the hexagonal nuts. (Fig.2)
- Remove the Bottom board. (see procedure 1)
- The MR-E circuit board can be removed by removing the 2 bind tapping screws (F) (3x8).

6. Removal of MR-G Circuit Board

- Pull out the volume knobs (C) and slide knob. (Fig.2)
- Remove the hexagonal nuts. (Fig.2)
- Remove the Bottom board. (see procedure 1)
- Remove the 3 bind tapping screws (G) (3x8), the MR-G circuit board can be removed. (Fig.4)

3. MR-C1, C2, Fシートの外し方

- ポリウムツマミ(C)2個とスライドツマミを引き抜き、六角ナットを外します。(Fig.2)
- 底板を外します。(1項参照)
- バインドタッピングネジ(D) (3×8) 2本を外し、MR-C1 (C2, F) シートを外します。(Fig.4)

4. MR-Dシートの外し方

- ポリウムツマミ(C)4個とスライドツマミを引き抜き、六角ナットを外します。(Fig.2)
- 底板を外します。(1項参照)
- バインドタッピングネジ(E) (3×8) 2本を外し、MR-Dシートを外します。(Fig.4)

5. MR-Eシートの外し方

- ポリウムツマミ(C)とスライドツマミを引き抜き、六角ナットを外します。(Fig.2)
- 底板を外します。(1項参照)
- バインドタッピングネジ(F) (3×8) 2本を外し、MR-Eシートを外します。(Fig.4)

6. MR-Gシートの外し方

- ポリウムツマミ(C)とスライドツマミを引き抜き、六角ナットを外します。(Fig.2)
- 底板を外します。(1項参照)
- バインドタッピングネジ(G) (3×8) 3本を外し、MR-Gシートを外します。(Fig.4)

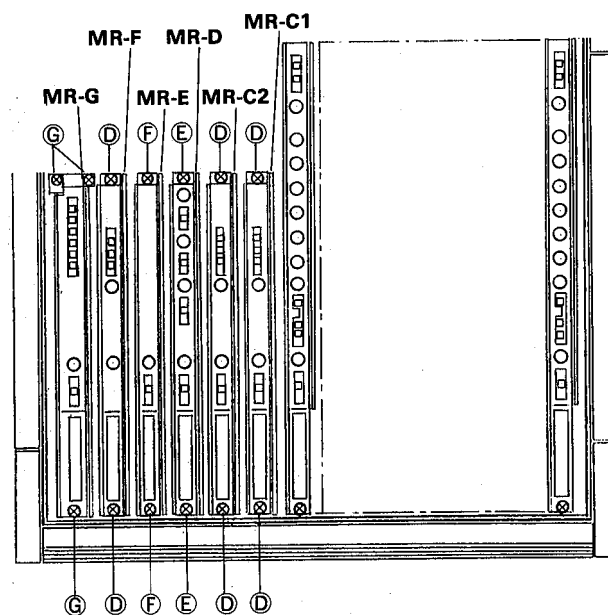

Fig. 4

7. Removal of MR-B Circuit Board

- Remove the Bottom board. (see procedure 1)
- Remove the 4 bind tapping screws ⑧(3x8), the MR-B circuit board can be removed. (Fig.5)

8. Removal of MR-N Circuit Board

- Remove the Bottom board. (see procedure 1)
- Remove the MR-B circuit board. (see procedure 7)
- Remove the 4 bind tapping screws ①(3x8). (Fig.6)
- Take the MR-N circuit board out of the unit with the heat sink. (Fig.5)

9. Removal of MR-H and MR-I Circuit Boards

- Remove the Bottom board. (see procedure 1)
- Remove the 2 bind head screws ①(3x12) and 2 bind tapping screws ⑥(3x8), and then remove the Rear pads. (Fig.6)
- Remove the 6 bind tapping screws ④(3x8), and lift the Rear panel as shown below. (Fig.5, 7)
- Remove the 4 bind tapping screws ③(3x8), the MR-H (MR-I) circuit board can be removed. (Fig.5).

10. Removal of Power Transformer

- Remove the Bottom board. (see procedure 1)
- Remove the 4 bind head screws ②(4x8), the Power transformer can be removed. (Fig.5)

7. MR-Bシートの外し方

- ・底板を外します。(1項参照)
- ・バインドタッピングネジ⑧(3×8) 4本を外し、MR-Bシートを外します。(Fig.5)

8. MR-Nシートの外し方

- ・底板を外します。(1項参照)
- ・MR-Bシートを外します。(7項参照)
- ・バインドタッピングネジ①(3×8) 4本を外し、MR-Nシートを放熱板と共に外します。(Fig.5)

9. MR-H, Iシートの外し方

- ・底板を外します。(1項参照)
- ・バインド小ネジ①(3×12) 2本とバインドタッピングネジ⑥(3×8) 2本を外し、リアパッドを外します。(Fig.6)
- ・バインドタッピングネジ④(3×8) 6本を外し、リアパネルを図の様に持ち上げます。(Fig.5, 7)
- ・バインドタッピングネジ③(3×8) 4本を外し、MR-H (MR-I) シートを外します。(Fig.5)

10. 電源トランスの外し方

- ・底板を外します。(1項参照)
- ・バインド小ネジ②(4×8) 4本を外し、外します。(Fig.5)

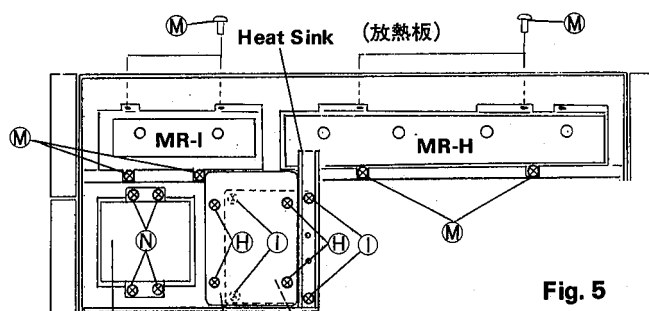

Power Transformer MR-B, MR-N
(電源トランス)

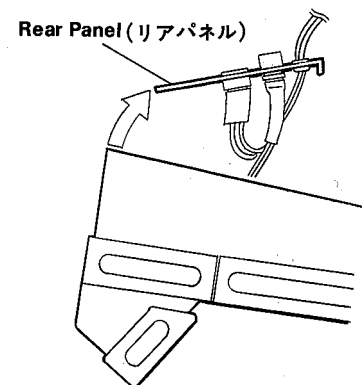

Fig. 7

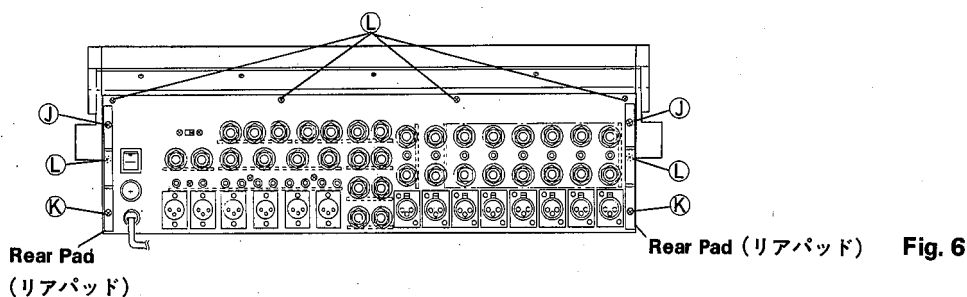

Fig. 6

11. Removal of MR-J, J1, J2, K, M, O, P, P1 and Q Circuit Boards

- Remove the Bottom board. (see procedure 1)
- Remove the hexagonal nuts retaining jacks, the circuit boards can be removed. (Fig.8)

12. Removal of MR-L Circuit Boards

- Remove the bottom board. (see procedure 1)
- After the 3 bind head screws \odot (3x8) have been removed, the MR-L circuit board can be removed. (Fig.8)

11. MR-J,J1,J2,K,M,O,P,P1,Qシートの外し方

- 底板を外します。(1項参照)
- 各シート共、リアパネル側の六角ナットを外し、シートを外します。(Fig.8)

12. MR-Lシートの外し方

- 底板を外します。(1項参照)
- バインド小ネジ \odot (3x8) 3本を外し、MR-Lシートを外します。(Fig.8)

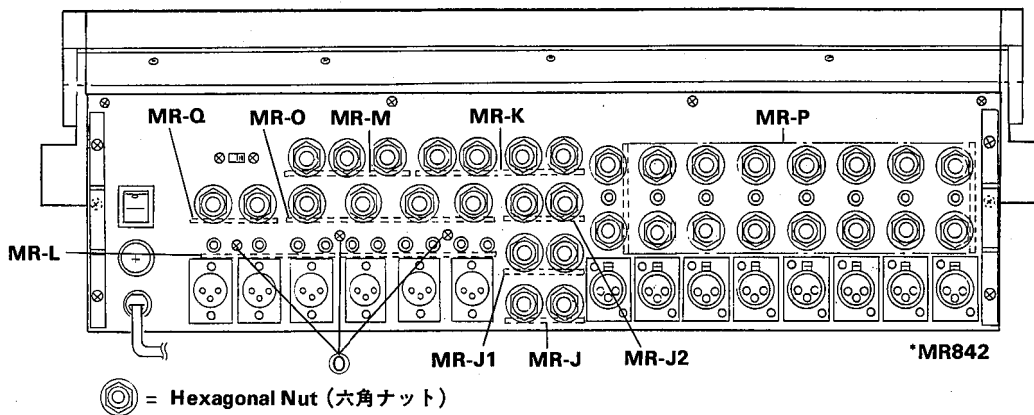
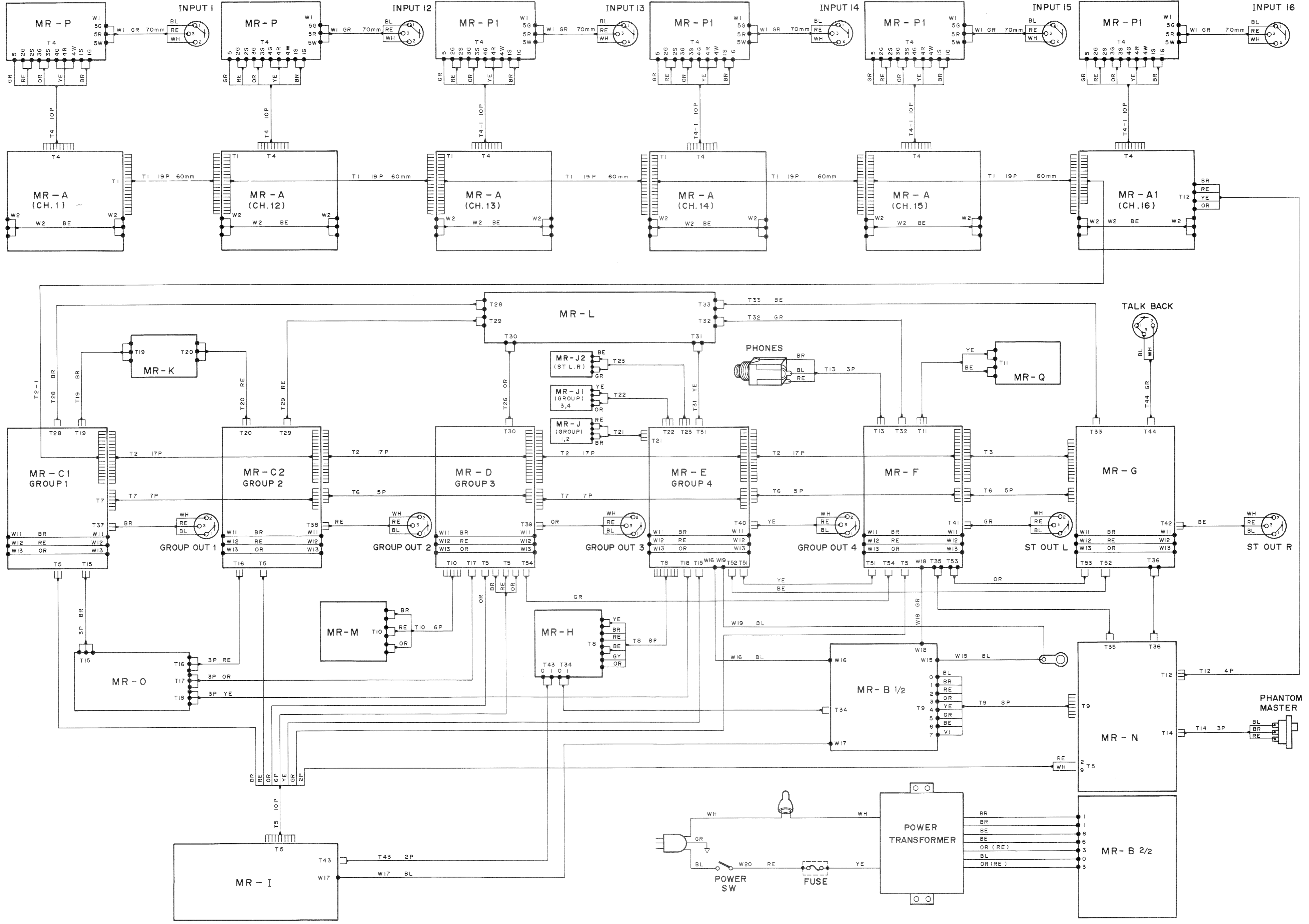
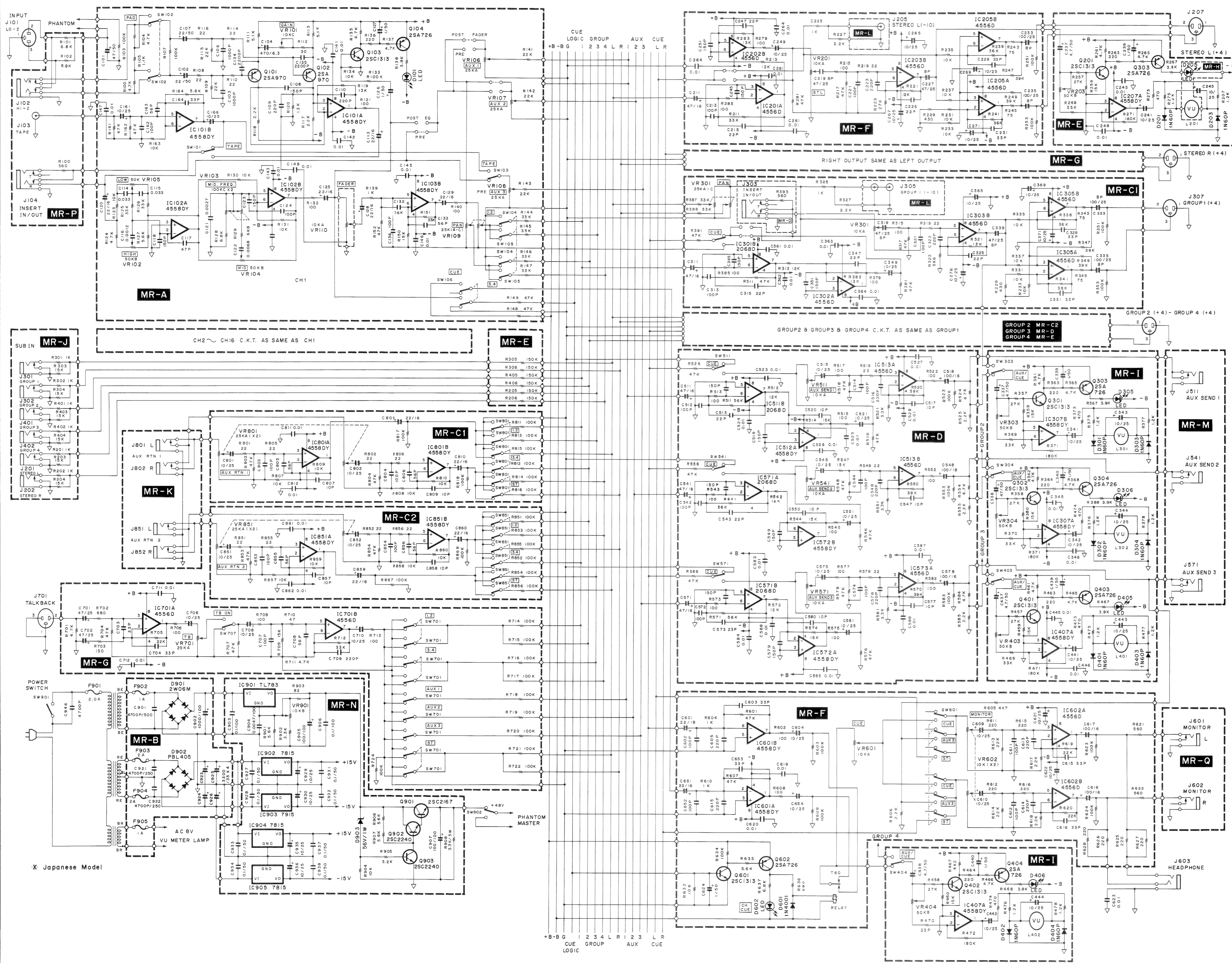

Fig. 8

Note)

	P circuit board	P1 circuit board
MR842	Ch. 1 - Ch. 8	X
MR1242	Ch. 1 - Ch. 12	X
MR1642	Ch. 1 - Ch. 12	Ch.13-Ch.16





Notes

- MR-A & MR-A1
 - IC 101, 102: NJM4558D (G001390) OP AMP.
 - Transistor Q 101-102: 2SA726 B (K8097010)
 - Q 103: 2SC1313 (K802930)
 - Q 104: 2SA726 B (K802920)
 - LED 101: 103HD 42 RED (K802980) CLIP
 - Rotary VR VR 101: -25C10K (K8001950) V16L4N15KC GAN
 - VR 102, 104, 105: -850K-C (K801970) V16L4N15KC H, M, L, O
 - VR 103: -15C10K2 (K802010) V16L4N15KC G3-1 MID FREQ
 - VR 106: -15A25K (K801980) V16L4N15KC AUX 1, 2, 3
 - VR 109: -15A25K2 (K802000) V16L4N15KC G3-1 PAN
 - Slide VR VR 110: RS80Y11G4023- (K802030) 10KA-PJ Fader
 - Push Switch SW 101: SPUE30A25B-PJ (K801930) TAPE, PAD
 - SW 102: SPUE30A24-PJ (K801920) TAPE, 1-2, 3-4
 - SW 106: KP8122-SNAL (K800750) CUE
- MR-B
 - Diode Bridge PBL405 (K802950)
 - 2W05 (K802960)
 - Ceramic Cap C 921, 922: NJM2068D (K801480) OP AMP.
 - Electrolytic Cap C 923, 926: 1000 μF 100V (J29190)
 - 3300 μF 35V (J29930)
- MR-C1 & MR-C2
 - IC 301: NJM2068D (K801480) OP AMP.
 - Q 302, 306: NJM4558D (G001390) OP AMP.
 - Q 801 (B51): NJM4558D (G001390) OP AMP.
 - Rotary VR VR 101 (906): -15A25K2 (K802000) V16L4N15KC G3-1 PAN
 - VR 801 (B51): N15KC-25KA-C (K800510) V16L4 G3-1 AUX RTN 1, 2
 - Slide VR VR 302: RS80Y11G4023- (K802030) 10KA-PJ GROUP Fader 1, 2
 - Push Switch SW 302: SPUE30A25B-PJ (K801930) TAPE, PAD
 - SW 801: SPUE30A25-PJ (K801920) 1-2, 3-4, ST
- MR-D
 - IC 403, 405, 513, 573: NJM4558D (G001390) OP AMP.
 - IC 511, 571: NJM2068D (K801480) OP AMP.
 - IC 512, 572: NJM4558D (G001390) OP AMP.
 - Rotary VR VR 403: N15KC-25KA-C (K800510) V16L4 G3-1 PAN
 - VR 402: -15A10K (K800500) V16L4N15KC AUX SEND 1, 2, 3
 - Slide VR VR 402: RS80Y11G4023- (K802030) 10KA-PJ GROUP 3 Fader
 - Push Switch SW 401, 511, 541, 571: KP8122-SNAL (K800750) CUE
- MR-E
 - IC 401: NJM2068D (K801480) OP AMP.
 - IC 402, 404, 406: NJM4558D (G001390) OP AMP.
 - Transistor Q 201, 202: 2SC1313 (K802930)
 - Q 203, 204: 2SA726 B (K802920)
 - Diode D 201, 204: 1N60P (F000620)
 - VR 406: -15A25K2 (K802000) V16L4N15KC G3-1 PAN
 - Slide VR VR 402: RS80Y11G4023- (K802030) 10KA-PJ GROUP 4 Fader
 - Potentiometer VR 200, 204: 50K 3P (K802040) PEAK LED x5
 - SW 402: SPUE30A25-PJ (K801920) 1-2, 3-4, ST
- MR-F
 - IC 203, 205, 602: NJM4558D (G001390) OP AMP.
 - Transistor Q 601: 2SC1313 (K802930)
 - Q 602: 2SA726 B (K802920)
 - Diode D 601: 1N4001 (K803100)
 - LED 602: 103HD 42 RED (K802980) CH CUE
 - Rotary VR VR 601: -15A10K (K800500) V16L4N15KC CUE
 - VR 602: -15C10K2 (K802010) V16L4N15KC MONITOR
 - Slide VR VR 201: RS80Y11G4023- (K802030) 10KA-PJ ST-L
 - Push Switch SW 601: SPUE30A25-PJ (K801920) CUE, AUX 3, ST
- MR-G
 - IC 101, 102: NJM4558D (G001390) OP AMP.
 - Q 101, 102: 2SA726 B (K802920)
 - Q 103: 2SC1313 (K802930)
 - Q 104: 2SA726 B (K802920)
 - LED 101: 103HD 42 RED (K802980) CH CUE
 - Rotary VR VR 101: -25C10K (K8001950) V16L4N15KC GAN
 - VR 102, 104, 105: -850K-C (K801970) V16L4N15KC H, M, L, O
 - VR 103: -15C10K2 (K802010) V16L4N15KC G3-1 MID FREQ
 - VR 106: -15A25K (K801980) V16L4N15KC AUX 1, 2, 3
 - VR 109: -15A25K2 (K802000) V16L4N15KC G3-1 PAN
 - Slide VR VR 110: RS80Y11G4023- (K802030) 10KA-PJ Fader
 - Push Switch SW 101: SPUE30A25B-PJ (K801930) TAPE, PAD
 - SW 102: SPUE30A24-PJ (K801920) TAPE, 1-2, 3-4
 - SW 106: KP8122-SNAL (K800750) CUE
- MR-H
 - LED 205, 206: 103HD 42 RED (K802980)
 - Analog Meter L 201, 202: TN-72-8656 (K804430) ST L, R
- MR-I
 - IC 307, 407: NJM4558D (G001390) OP AMP.
 - Q 303, 304, 403, 404: 2SC1313 (K802930)
 - Q 305, 304, 403, 404: 2SA726 B (K802920)
 - Diode D 301-304, 401, 404: 1N60P (F000620)
 - LED 301, 306, 405: 103HD 42 RED (K802980) PEAK
 - Potentiometer VR 303, 304, 403, 404: 50K 3P (K802040) PEAK x5
 - Slide Switch SW 302, 304, 403, 405: SSS222NF1-PJ (K801910) GROUP
 - Analog Meter L 301, 302, 401, 402: TN-72-8656 (K804430)
- MR-J, MR-J1 & MR-J2
 - MIC Jack J 201, 202: RDJ-245 (K801230) SUB IN
- MR-K
 - MIC Jack J 801, 802, 851, 852: RDJ-245 (K801230) AUX RTN
- MR-L
 - Pin Jack J 205, 206, 305, 306, 405, 406: 211-00010-000 (K802000) GROUP, ST OUT
- MR-M
 - MIC Jack J 511, 541, 571: RDJ-245 (K801230) AUX SEND
- MR-N
 - IC 901: TL783C (K802890)
 - IC 902, 903: NJM7815 (G147400) 15V Regulator
 - IC 904, 905: NJM7915 (G147400) -15V Regulator
 - Q 901: 2SC2167 (K802940)
 - Q 902, 903: 10K 3P (K802050)
 - Zener Diode VR 901: 0.0047 F 100V (K802070)
 - MIC Cap C 904: 0.1 μF 100V (K802020)
 - Ceramic Cap C 905, 907: 100 μF 100V (J299100)
- MR-O
 - MIC Jack J 303, 304, 403, 404: RDJ-08 (K801220) GROUP INSERT
 - MIC Jack J 102, 104: RDJ-06 (K801220) INSERT, HILO
 - J 103: 211-00010-000 (K802000) TAPE
- MR-P & MR-P1
 - MIC Jack J 101: RDJ-06 (K801220) INSERT, HILO
- MR-Q
 - MIC Jack J 601, 602: RDJ-245 (K801230) MONITOR OUT

