

INSPECTIONS

A PREPARATION

Unless otherwise specified, the controls and switches are to be set as follows:

- Set the word clock at 48 kHz (Internal).
- Turn on only measurement channel.

PAN	Center
GAIN	Minimum
PAD	ON
FADER	NOMINAL (0 dB)

· The analog output loads are as follows:

- | | |
|---------------------|---------------|
| STEREO OUT (XLR): | 600 Ω |
| BUS OUT 1, 2, 3, 4: | 10 k Ω |
| AUX OUT 1, 2, 3, 4: | 10 k Ω |
| REC OUT (PIN): | 10 k Ω |
| MONITOR OUT: | 10 k Ω |
| PHONES: | 8 Ω |
- 0 dBs=0.775 Vrms
 - 0 dBV=1 Vrms=2.2 dBs
 - Oscillator output impedance: 150 Ω
 - Oscilloscope input impedance: more than 100 k Ω
 - Level meter input impedance: more than 100 k Ω
 - For the noise level measurement, use a low pass filter with the cut-off frequency of 12.7 kHz, -6 dB/OCT must be used. (Make measurement in the average effect value, not the actual effect value.)

B INITIALIZATION

After you have performed initialization to reset the console to its factory settings, carry out inspections.

Turn the POWER switch on while pressing the STORE key, then press the RECALL key to initialize.

C TEST PROGRAM

While pressing the UTILITY, HI-MID and FADER keys simultaneously, turn the POWER switch on to enter the test program.

Refer to the TEST PROGRAM section of this service manual for details of the inspections using the test program.

D INSPECTION

1. ST OUT L/R

Condition: Apply a signal to INPUT CH1.

① Frequency response (L/R)

Condition: The allowable range is based on 1 kHz.

Input frequency	Input level	Allowable range
20 Hz	+10 dBs	-1.5 dB~0 dB
20 kHz	+10 dBs	-1.0 dB~0 dB

② Residual Noise (L/R)

Condition: Set the ST OUT switch OFF.

Rated output level
Less than -94 dBs

③ Crosstalk between L and R

Condition: Set the PAN at L.

Input frequency	Output level (L)	Allowable range (R)
1 kHz	+16 dBs	Less than -54 dBs

Note: Confirm that the Rch crosstalk is at the same level as above.

④ Level difference between L/R

Check that the difference in 1 kHz gain measured in status

① is within the following range.

Rated output level
Less than 1 dB

2. REC OUT L/R

Conditions: Apply a signal to INPUT CH1.
Set the SOURCE SELECT to ST OUT.

① Gain (L/R)

Input frequency	Input level	Rated output level	Allowable range
1 kHz	+10 dBs	-10 dBV	-10 dBV \pm 2 dB

② Frequency response (L/R)

Condition: The allowable range is based on 1 kHz.

Input frequency	Input level	Allowable range
20 Hz	+10 dBs	-1.5 dB~0 dB
20 kHz	+10 dBs	-1.0 dB~0 dB

3. AUX OUT 1, 2, 3, 4 BUS OUT 1, 2, 3, 4

Conditions: Apply a signal to INPUT CH1.
Set the ASSIGN switches 1~4 to ON.
Set the AUX CH FADER at NOMINAL (0 dB).
Set the BUS MASTER FADER at NOMINAL (0 dB).

① Frequency response (AUX 1, 2, 3, 4/ BUS 1, 2, 3, 4)

Condition: The allowable range is based on 1 kHz.

Input frequency	Input level	Allowable range
20 Hz	+10 dBs	-1.5 dB~0 dB
20 kHz	+10 dBs	-1.0 dB~0 dB

② Residual Noise (AUX 1, 2, 3, 4/ BUS 1, 2, 3, 4)

Conditions: Set the AUX OUT and BUS OUT switches to OFF.

Allowable range
Less than -87 dBs

③ Crosstalk between odd-numbered channels and even-numbered channels

Conditions: Set the measured AUX CH FADER at NOMINAL (0 dB).
Set the measured BUS ASSIGN switch to ON.

Input frequency	Output level (Odd-numbered channel)	Allowable range (Even-numbered channel)
1 kHz	+16 dBs	Less than -54 dBs

Note: Confirm that the even-numbered channel crosstalk is at the same level as above.

④ Gain difference between channels AUX (1, 2, 3, 4), BUS (1, 2, 3, 4)

Check that the difference in 1 kHz gain measured in status ① is within the following range.

Allowable range
Within 1 dB

4. REC OUT L/R

Conditions: Apply a signal to input CH1.
Set ASSIGN switches 1 and 2 to ON.
Set the BUS MASTER FADERS 1 and 2 at NOMINAL (0 dB).
Set the SOURCE SELECT to BUS OUT.

① Gain

Input frequency	Input level	Rated output level	Allowable range
1 kHz	+10 dBs	-10 dBV	-10 dBV ±2 dB

5. MONITOR OUT L/R

Conditions: Apply a signal to INPUT CH1.
Set the SOLO/2TR IN to SOLO.
Set the MONITOR OUT LEVEL at Maximum.

① Frequency response (L/R)

Condition: The allowable range is based on 1 kHz.

Input frequency	Input level	Allowable range
20 Hz	+10 dBs	-1.5 dB~0 dB
20 kHz	+10 dBs	-1.0 dB~0 dB

② Residual Noise (L/R)

MONITOR OUT LEVEL	Allowable range (MONITOR)
Maximum	Less than -94 dBs
Minimum	Less than -100 dBs

③ Crosstalk between L and R

Condition: Set the PAN at L.

Input frequency	Output level (L)	Allowable range (R)
1 kHz	+16 dBs	Less than -54 dBs

Note: Confirm that the Rch crosstalk is at the same level as above.

④ Level difference between L/R

Check that the difference in 1 kHz gain measured in status ① is within the following range.

Allowable range
Within 1 dB

6. OUTPUT LEVEL DIFFERENCE

Conditions: Check that the difference in gain between each output of ST OUT (L, R), AUX (1, 2, 3, 4), BUS OUT (1, 2, 3, 4) and MONITOR OUT (L, R) are within the range shown below with 1 kHz as a reference.

Allowable range
Within 2 dB

7. PHONES OUT L/R

Conditions: Apply a signal to INPUT CH1.
Set the PHONES LEVEL at Maximum.

① Frequency response(L/R)

Condition: The allowable range is based on 1 kHz.

Input frequency	Input level	Allowable range
20 Hz	+10 dBs	-3 dB~0 dB
20 kHz	+10 dBs	-1 dB~0 dB

② Residual Noise (L/R)

Condition: Set the PHONES LEVEL at Minimum.

Allowable range
Less than -100 dBs

③ Crosstalk between L and R

Condition: Set the PAN at L.

Input frequency	Output level(L)	Allowable range (R)
1 kHz	-10 dBs	Less than -75 dBs

Note: Confirm that the Rch crosstalk is at the same level as above.

④ Level difference between L/R

Check that the difference in 1 kHz gain measured in status ① is within the following range.

Allowable range
Within 1 dB

8. MAXIMUM OUTPUT

Set the internal oscillator frequency and level, output terminal assignment and fader position as follows:

A Oscillator and output assignment

A-1 Select the "00" address using ▲ or ▼ buttons on the SCENE MEMORY section and press the RECALL button. (Fig. 1)

A-2 Press the UTILITY button in the SETUP section. (Fig. 2)

A-2-1 Select the SINE 1 kHz using CURSOR ▼ button on the screen control section and press the ENTER button. (Fig. 2)

A-2-2 Move the cursor to the OSC ON using CURSOR ▼ button on the screen control section and press the ENTER button. to set the internal oscillator to "ON". (Fig. 2)

A-2-3 Move the cursor to the LEVEL using CURSOR ► button and set the oscillator output level to "0 dB" using the PARAMETER dial. (Fig. 2)

A-3 Move the cursor to the ASSIGN using CURSOR ► button and set the output terminal selecting the AUX 1-4, BUS 1-4 AND ST OUT one by one and set "ON". (Fig. 2)

B Fader position setting

B-1 Set the "CH17~24" using the MIXING LAYER button. (Fig. 3)

B-2 Select the "CH17~24" page using the FADER button in the FADER MODE section and set the faders (AUX 1-4, BUS 1-4 AND ST OUT) to NOMINAL position = ±0.0. (Fig. 3)

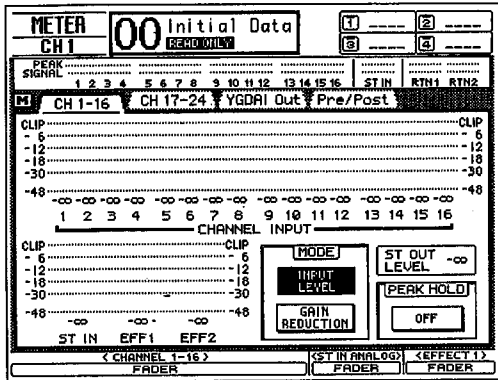

(Fig. 1)

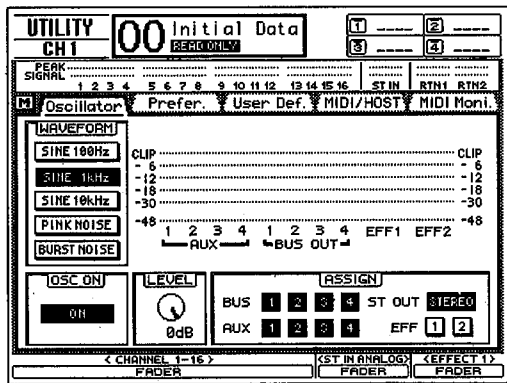

(Fig. 2)

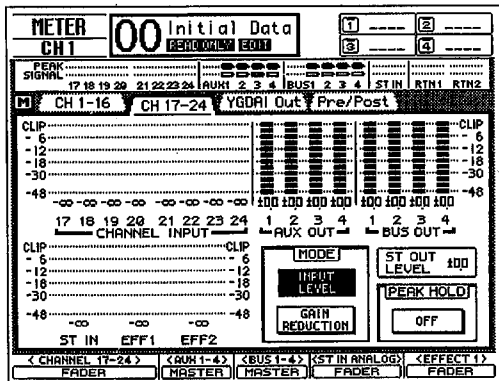

(Fig. 3)

8-1 ST OUT Maximum output (L/R)

Input frequency	Output level	Allowable range (Distortion)
1 kHz	+18 dBs ± 0.5 dB	Less than 0.03%

8-2 (AUX 1, 2, 3, 4/ BUS 1, 2, 3, 4) Maximum output

Input frequency	Output level	Allowable range (Distortion)
1 kHz	+18 dBs ± 0.5 dB	Less than 0.02%

8-3 MONITOR OUT Maximum output (L/R)

Input frequency	Output level	Allowable range (Distortion)
1 kHz	+18 dBs ± 0.5 dB	Less than 0.03 %

8-4 PHONES OUT Maximum output (L/R)

Input frequency	Output level	Allowable range (Distortion)
1 kHz	-4.5 dBs ± 0.5 dB	Less than 0.05 %

9. 2TR IN L/R

Conditions: Measure the output at MONITOR OUT.
Set the MONITOR OUT LEVEL at Maximum.
Set the SOLO/2TR IN to 2TR IN.

① Gain (L/R)

Input frequency	Input level	Rated output level	Allowable range
1 kHz	-10 dBV	+4 dBs	+4 dBs ± 2 dB

② Frequency response(L/R)

Condition: The allowable range is based on 1 kHz.

Input frequency	Input level	Allowable range
20 Hz	-10 dBV	-1.0 dB ~ 0 dB
20 kHz	-10 dBV	-1.0 dB ~ 0 dB

③ Distortion (L/R)

Input frequency	Output level	Allowable range
1 kHz	+16 dBs	Less than 0.003 %

④ Residual Noise (L/R)

Condition: Connect a 150 Ω resistor at the 2TR IN.

Allowable range
Less than -98 dBs

⑤ Level difference between L/R

Check that the difference in gain measured in status ① is within the following range.

Allowable range
Within 1 dB

⑥ Crosstalk between L and R

Conditions: Apply a signal to L channel.
Connect a 150 Ω resistor at R channel.
Set the MONITOR OUT LEVEL at Maximum.

Input frequency	Output level(L)	Allowable range(R)
1 kHz	+16 dBs	Less than -54 dBs

Note: Confirm that the Rch crosstalk is at the same level as above.

10. CH IN 1~CH 8 (XLR, PHONE)

Condition: Measure the output at the ST OUT L channel.

10-A. GAIN Maximum, PAD OFF

① Gain (CH1~CH8)

Input frequency	Input level	Rated output level	Allowable range
1 kHz	-60 dBs	+4 dBs	+4 dBs ±2 dB

② Frequency response (CH1~CH8)

Condition: The allowable range is based on 1 kHz.

Input frequency	Input level	Allowable range
20 Hz	-60 dBs	-2.0 dB~0 dB
20 kHz	-60 dBs	-1.0 dB~0 dB

③ Distortion (CH1~CH8)

Input frequency	Output level	Allowable range
1 kHz	+16 dBs	Less than 0.02 %

④ Noise level EIN (CH1~CH8)

Allowable range
Less than -64 dBs

If the measured noise level is out of the rated value, check that the converted value is within the range shown below.
Measurement value - gain at 1 kHz ≤ -128

⑤ Level difference between (CH1~CH8)

Check that the difference in gain measured in status ① is within the following range.

Allowable range
Within 2 dB

10-B. GAIN Minimum, PAD ON

① Gain (CH1~CH8)

Input frequency	Input level	Rated output level	Allowable range
1 kHz	+10 dBs	+4 dBs	+4 dBs ±2 dB

② Distortion (CH1~CH8)

Input frequency	Output level	Allowable range
1 kHz	+16 dBs	Less than 0.02 %

③ Noise level (CH1~CH8)

Allowable range
Less than -90 dBs

④ Crosstalk between odd-numbered channels and even-numbered channels

Conditions: Apply a signal to an odd-numbered channel.
Connect a 150 Ω resistor to an even-numbered channel.

Input frequency	Output level (Odd-numbered channel)	Allowable range (Even-numbered channel)
1 kHz	+16 dBs	Less than -54 dBs

Note: Confirm that the even-numbered channel crosstalk is at the same level as above.

⑤ INSERT OUT gain (CH1~CH2)

Input frequency	Input level	Rated output level	Allowable range
1 kHz	+10 dBs	+4 dBs	+4 dBs ±1.5 dB

⑥ INSERT OUT noise level (CH1~CH2)

Allowable range
Within -90 dBs

10-C. PHANTOM (CH1~CH8)

Short circuit pin-2 and pin-3 of an appropriate INPUT (XLR) connector, and connect a 10 k Ω load between pin-2 and pin-1. Check that the voltage is within the range shown below when the PHANTOM switch is turned on.

Allowable range
DC 31 V~37 V

Check that the circuit discharges quickly when turning off the PHANTOM switch.

11. CH IN 9~16, ST IN L, R

Condition: Measure the output at the ST OUT L and R.

11-A. GAIN Maximum

① Gain (CH9~CH16, ST IN L, R)

Input frequency	Input level	Rated output level	Allowable range
1 kHz	-20 dBs	+4 dBs	+4 dBs ±2 dB

② Frequency response (CH9~CH16, ST IN L, R)

Condition: The allowable range is based on 1 kHz.

Input frequency	Input level	Allowable range
20 Hz	-20 dBs	-2.0 dB~0 dB
20 kHz	-20 dBs	-1.0 dB~0 dB

③ Distortion (CH9~CH16, ST IN L, R)

Input frequency	Output level	Allowable range
1 kHz	+16 dBs	Less than 0.02 %

④ Noise level EIN (CH9~CH16, ST IN L, R)

Allowable range
Less than -82 dBs

If the measured noise level is out of the rated value, check that the converted value is within the range shown below.
Measurement value - gain at 1 kHz ≤ -104

⑤ Level difference between odd-numbered channels and even-numbered channels

Check that the difference in gain measured in status ① is within the following range.

Allowable range
Within 1 dB

⑥ Level difference between channels (CH9~CH16, ST IN L, R)

Check that the difference in gain measured in status ① is within the following range.

Allowable range
Within 2 dB

11-B. GAIN Minimum

① Gain (CH9~CH16, ST IN L, R)

Input frequency	Input level	Rated output level	Allowable range
1 kHz	+10 dBs	+4 dBs	+4 dBs ±2 dB

② Distortion (CH9~CH16, ST IN L, R)

Input frequency	Output level	Allowable range
1 kHz	+16 dBs	Less than 0.02 %

③ Noise level (CH9~CH16, ST IN L, R)

Allowable range
Less than -90 dBs

④ Crosstalk between odd-numbered channels and even-numbered channels

Conditions: Apply a signal to an odd-numbered channel.
Connect a 150 Ω resistor to an even-numbered channel.

Input frequency	Output level (Odd-numbered channel)	Allowable range (Even-numbered channel)
1 kHz	+16 dBs	Less than -54 dBs

Note: Confirm that the even-numbered channel crosstalk is at the same level as above.

⑤ Crosstalk between ST IN L, R.

Condition: Apply a signal to ST IN L channel.
Connect a 150 Ω resistor at ST IN R channel.

Input frequency	Output level(L)	Allowable range(R)
1 kHz	+16 dBs	Less than -44 dBs

Note: Confirm that the Rch crosstalk is at the same level as above.

12. DIGITAL ST IN DIGITAL

Conditions: Set up an A/D converter AD2X, and set the word clock to INT 48 kHz.

12-A. MONITOR WHEN EMPHASIS OFF.

Conditions: Measure the outputs ST OUT L and R.
Set the ST IN to DIGITAL.
Set the AD2X emphasis OFF.

① Gain (AES/EBU, COAXIAL)

Input frequency	Input level (AD2X)	Rated output level	Allowable range
1 kHz	+4 dBs	+4 dBs	+4 dBs ±2 dB

② Frequency response (AES/EBU)

Condition: The allowable range is based on 1 kHz.

Input frequency	Input level(AD2X)	Allowable range
20 Hz	+4 dBV	-1.0 dB~+0.5 dB
20 kHz	+4 dBV	-1.0 dB~+0.5 dB

③ Distortion (AES/EBU)

Input frequency	Output level(03D)	Allowable range
1 kHz	+16 dBs	Less than 0.02 %

12-B. MONITOR WHEN EMPHASIS ON

Conditions: Measure the outputs ST OUT L and R.
Set the ST IN to DIGITAL.
Set the AD2X emphasis ON.

① Gain (AES/EBU, COAXIAL)

Input frequency	Input level (AD2X)	Rated output level	Allowable range
1 kHz	+4 dBs	+4 dBs	+4 dBs ±2 dB

② Frequency response (AES/EBU)

Condition: The allowable range is based on 1 kHz.

Input frequency	Input level(AD2X)	Allowable range
20 Hz	+4 dBV	-1.0 dB~+0.5 dB
20 kHz	+4 dBV	-1.0 dB~+0.5 dB

13. ST OUT DIGITAL

Conditions: Apply a signal to INPUT CH1.
Set up an A/D converter AD2X.

① Gain (AES/EBU, COAXIAL)

Input frequency	Input level	Rated output level	Allowable range
1 kHz	+10 dBs	+6 dBs	+6 dBs ±2 dB

② Frequency response (AES/EBU)

Condition: The allowable range is based on 1 kHz.

Input frequency	Input level(AD2X)	Allowable range
20 Hz	+10 dBs	-1.0 dB~+0.5 dB
20 kHz	+10 dBs	-1.0 dB~+0.5 dB

③ Distortion (AES/EBU)

Input frequency	Output level	Allowable range
1 kHz	+18 dBs	Less than 0.02 %

14. WORD CLOCK IN, OUT

Conditions: Measure the distortion at the ST OUT L and R.
 Measure the jitters at the WORD CLOCK OUT.
 Apply a signal to the CH1.
 Use the WORD CLOCK OUT of a DMR8.
 Set the WC SELECT switch to WC IN.

14-A. 48 kHz +6 %

Condition: Set the DRU8 word clock to 48 kHz +6 % (PLL).

① Distortion (L/R)

Input frequency	Output level	Allowable range
1 kHz	+16 dBs	Less than 0.03 %

② Jitters

Allowable range
Less than 25 nsec

14-B. 32 kHz -6%

Condition: Set the DRU8 word clock to 32 kHz -6 % (PLL).

① Distortion (L/R)

Input frequency	Output level	Allowable range
1 kHz	+16 dBs	Less than 0.02 %

② Jitters

Allowable range
Less than 25 nsec

14-C. 48 kHz

Condition: Set the DRU8 word clock to 48 kHz (Xtal).

① Jitters

Allowable range
Less than 10 nsec

E. INITIALIZATION

After inspections have been performed, carry out the initialization.

While pressing the STORE key, turn the POWER switch on, then press the RECALL key to initialize.

TEST PROGRAM

A. PREPARATION

Before turning the power switch on, connect the following jigs and set the switches.

1. Connect the SLOT INSPECTION jigs (NX818810) and MOUSE.
2. Connect the COMMUNICATION CHECK board and set the TO HOST ON/OFF switch to ON.
3. Prepare a Dsub 9 pin connector which is shorted pin 3 to pin 7, and pin 2 to pin 8; insert into the TO EDITOR terminal.

Jig: NX818810 SLOT INSPECTION jigs

B. ENTER THE TEST PROGRAM

While pressing the UTILITY, HI-MID, FADER keys simultaneously, turn the power switch on, then the menu screen will indicate the following.

03D DIAGNOSTICS PROGRAM V1.00	
<input checked="" type="checkbox"/> 1. Initial Test	<input type="checkbox"/> 9. WordClock Test
<input type="checkbox"/> 2. DSP&DRAM Test	<input type="checkbox"/> 10. DIO Test
<input type="checkbox"/> 3. LCD Test	<input type="checkbox"/> 11. Slot Test
<input type="checkbox"/> 4. LED Test	<input type="checkbox"/> 12. AD/DA Test(Sheet only)
<input type="checkbox"/> 5. Switch Test	<input type="checkbox"/> 13. --reserved--
<input type="checkbox"/> 6. Enc/Mouse Test	<input type="checkbox"/> 14. Exit
<input type="checkbox"/> 7. Fader Test	<input type="checkbox"/> 15. Fader Asins
<input type="checkbox"/> 8. Comm. Test	<input type="checkbox"/> 16. Factory Preset

Checked boxes indicate that the test checks are completed and OK.

The CHECK items and CHECK results are displayed.

* Confirm that the contrast control operates properly.

* To select a test program, use the cursor or enter the appropriate MIDI code.

* MIDI control function of TEST PROGRAM

The 03D test program can usually be started by inputting the following MIDI system exclusive message on normal mode.

```
F0 43 00 7E 00 18 4C 4D 20 20 38 42 30 33 54 20
30 33 44 20 44 49 41 47 20 53 54 41 52 54 4C F7
```

Each test can start by the MIDI program change data after the test has been started, based on the assignments of the signal.

C0 XX [XX = (Test No. -1)x8]

Example: Initial Test = C0 00, IC Test = C0 08 ..., Exit = C0 68, ...

Press the ENTER key to proceed to the next program and change the screen. The screen can also be changed by entering the number attained when 1 is added to the current program number.

C0 XX [XX = (Test No. -1)x8]

Example: Initial Test=test number 1 C0 00
 DSP&DRAM Test=test number 2 C0 08
 Exit=test number 14 C0 68

When each test is completed, the following code which corresponds to the test result will output from MIDI OUT terminal.

Test result is OK: [4F 4B]

Test result is NG: [4F 47]

1. INITIAL TEST

The following test will be performed:

- A. Battery voltage check.
- B. Communication between MAIN and SUS CPU check.
- C. RAM check.
- D. MAIN CPU, SUB CPU and DIAG version.

```
03D DIAGNOSTICS PROGRAM V1.00
 1.Initial Test
 2.DSP&DRAM Test
 3.LCD Test
 4.LED Test
 5.Switch Test
 6.Enc/Mouse Test
 7.Fader Test
 8.Comm. Test
 9.WordClock Test
 10.DIO Test
 11.Slot Test
 12.AD/DA Test(Sheet only)
 13.--reserved--
 14.Exit
 15.Fader Asins
 16.Factory Preset

1.Initial Test
SUB COMM.
BATTERY
VERSION MAIN V1.00
          SUB V1.00
RAM (IC060,IC061)
OK
OK 3.3V
OK
```

MAIN and SUB communication result.

Version display.

RAM check result.

Battery voltage check result. (OK or NG)
(3.1 V ≤ OK < 3.5 V)

OK will be displayed when all test items test results are OK. (Other test results are also displayed in the same manner.)

2. DSP & DRAM TEST

This test performs DSP and DRAM check.

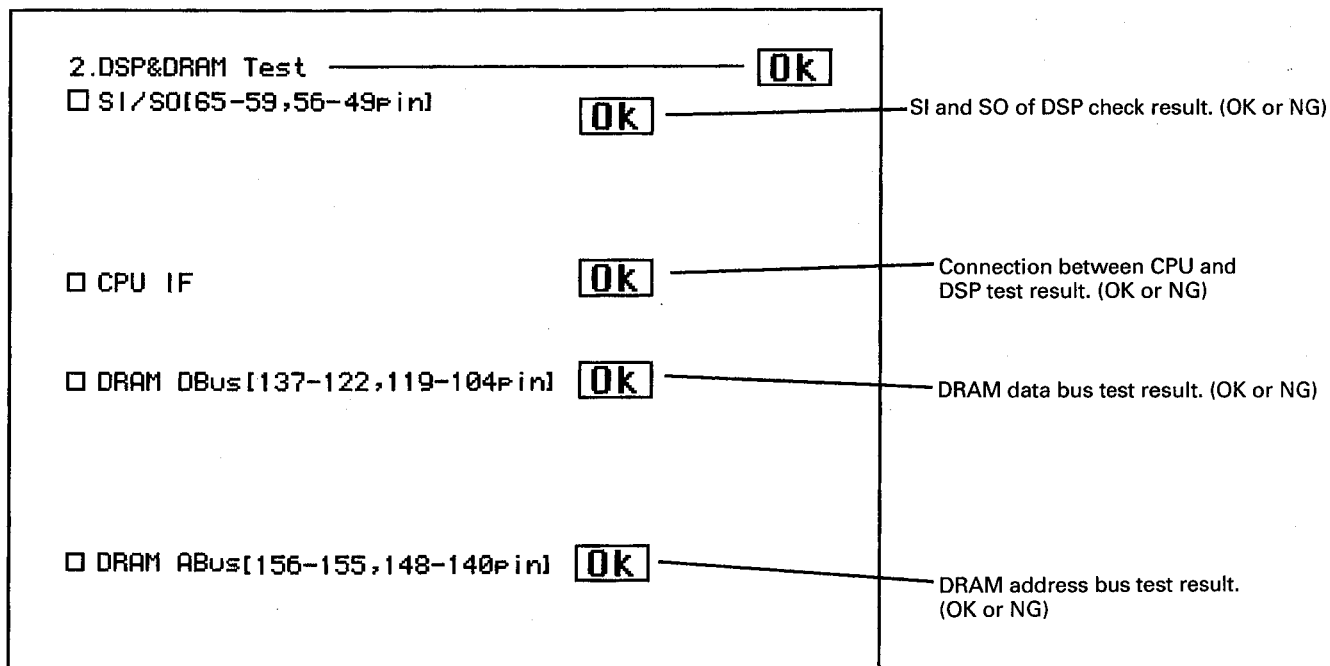

In case of NG

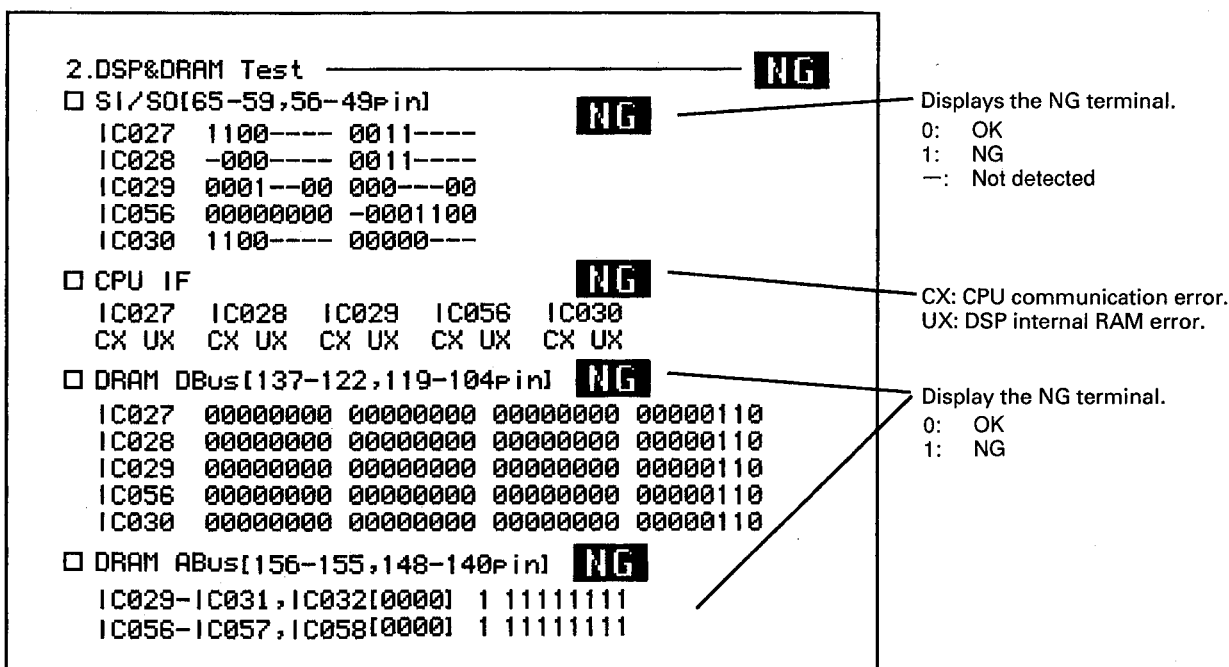

3. LCD TEST

Checks that the LCD screen changes white → black → white → black. Press the ENTER key to return to the menu screen.

4. LED TEST

LEDs on the panel are turned on one after another in the order illustrated on the next page.

```
03D DIAGNOSTICS PROGRAM V1.00
 1.Initial Test       9.WordClock Test
 2.DSP&DRAM Test    10.DIO Test
 3.LCD Test         11.Slot Test
 4.LED Test         12.AD/DA Test(Sheet only)
 5.Switch Test     13.--reserved--
 6.Enc/Mouse Test   14.Exit
 7.Fader Test       15.Fader Asins
 8.Comm. Test      16.Factory Preset

4.LED Test  OK
```

OK when all LEDs are light on.
If the ENTER key is pressed before every LED is light on,
NG is displayed.

LED lighting order

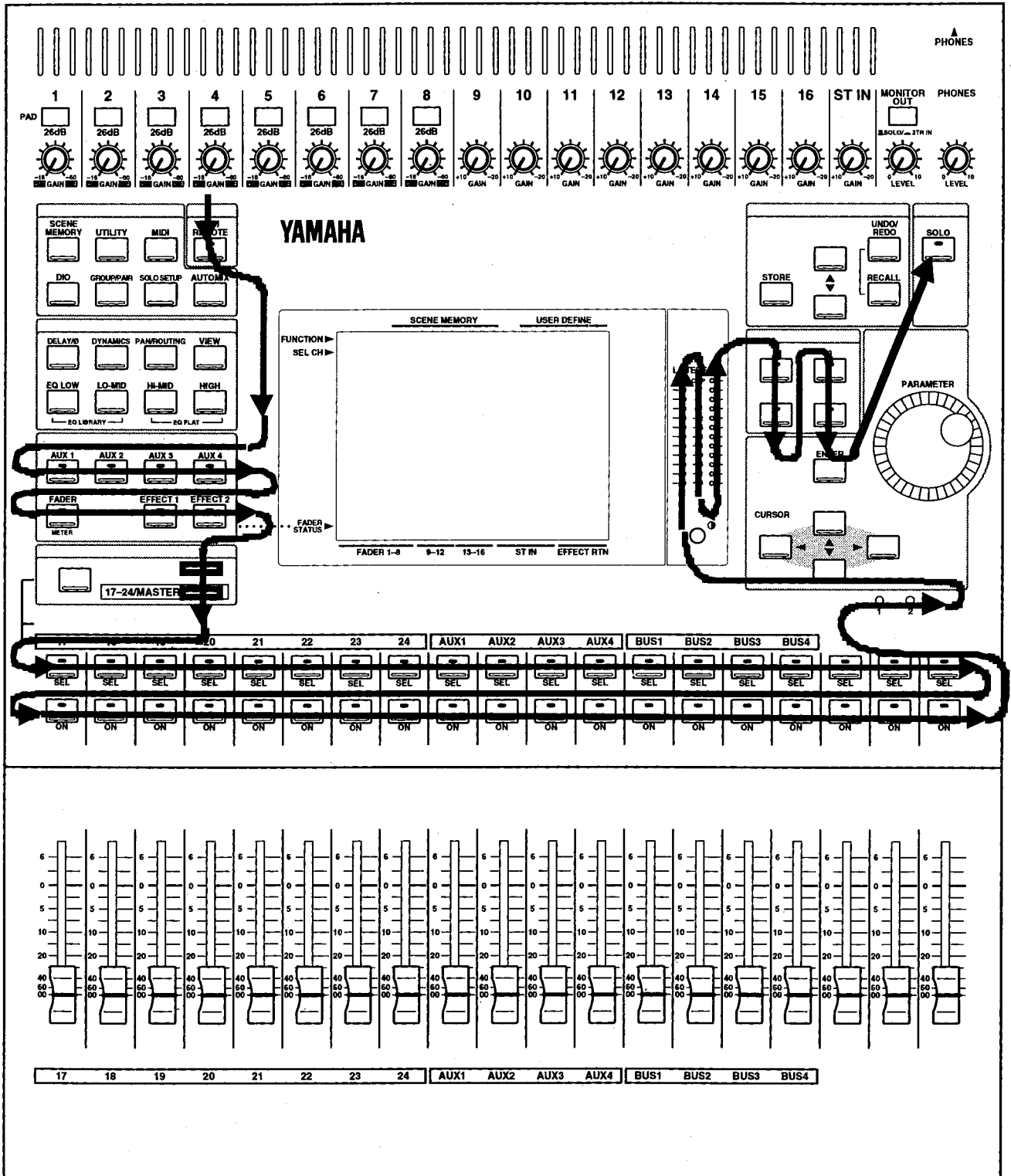

5. SWITCH TEST

Press the switch with in the order shown in the figure on the next page. (The order will also be shown on LCD screen.)
If press the last key (CURSOR ►) is pressed during switch test, NG is displayed and the test will be finished.

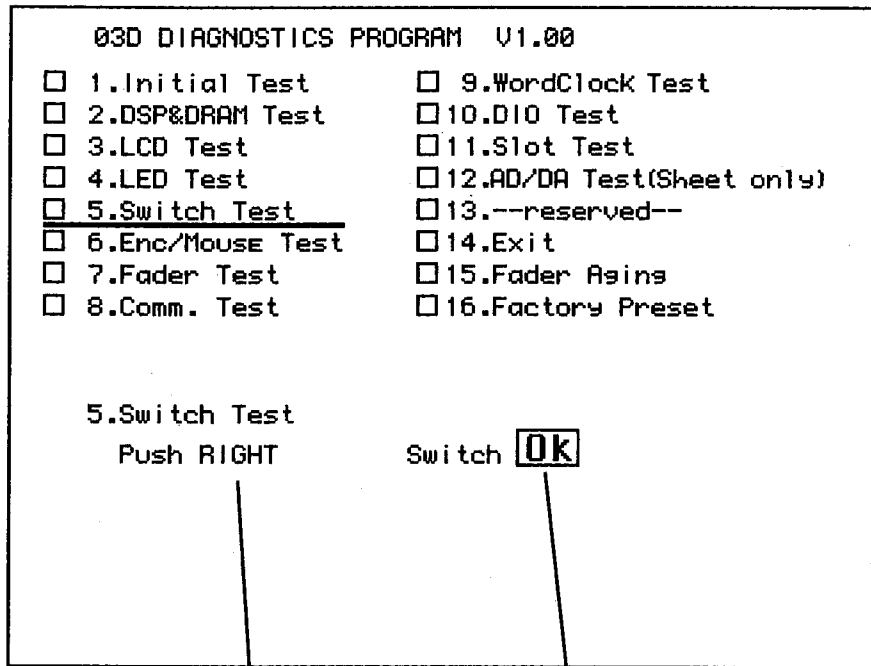

The switch name to be pressed is indicated.

OK is indicated when the test has ended.
If the last key (CURSOR ►) during switch testing,
NG will be displayed.

Switch test order

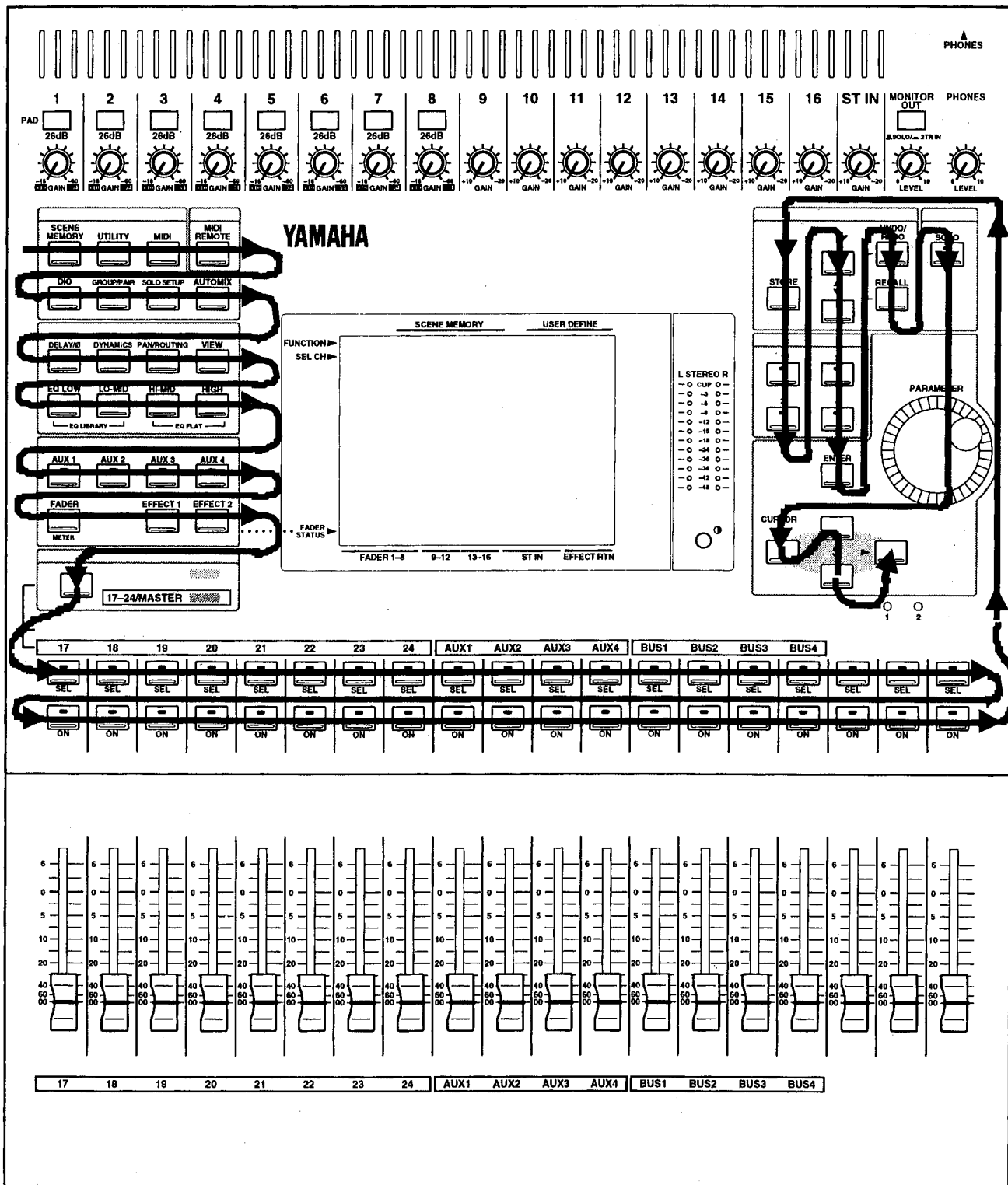

6. ENCODER/MOUSE TEST

Checks encoder and mouse according to instruction on the LCD.

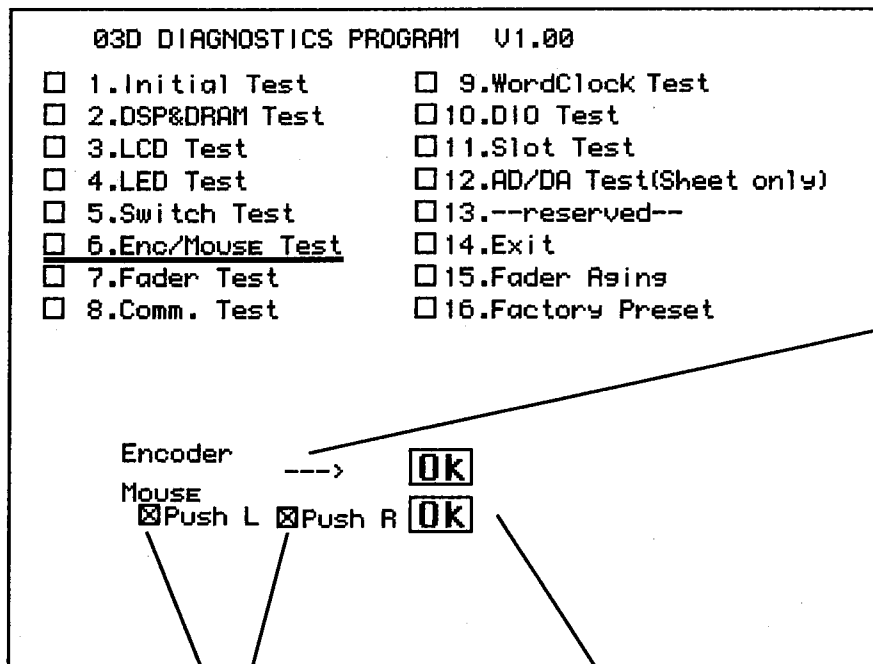

Encoder rotation direction indication.

The mouse button to be pressed is indicated.

OK will be displayed when test result is OK.
If the ENTER key is pressed during the encoder testing, NG will be displayed.

6-1 Encoder test

6-1-1 Turn the encoder to the left (Counter clockwise <---)

6-1-2 Turn the encoder to the right (Clockwise --->)

6-2-3 "OK" will be displayed when test result is OK and proceed to the mouse test. If the ENTER key is pressed during the encoder testing, NG is displayed and the test will be ended.

6-2 MOUSE TEST

6-2-1 Press the left side button.

6-2-2 Press the right side button.

6-2-3 OK will be displayed when test result is OK and the test will be ended.

7. FADER TEST

Measure the going and returning movement time of each fader after fader calibration has been automatically performed. If necessary, exchange slow faders or perform aging (test 15), because OK results do not come out unless all faders are OK.

```

03D DIAGNOSTICS PROGRAM V1.00

 1.Initial Test       9.WordClock Test
 2.DSP&DRAM Test   10.DIO Test
 3.LCD Test          11.Slot Test
 4.LED Test          12.AD/DA Test(Sheet only)
 5.Switch Test       13.--reserved--
 6.Enc/Mouse Test   14.Exit
 7.Fader Test        15.Fader Aging
 8.Comm. Test       16.Factory Preset

7.Fader Test
Fader Calibration : END

```

	[1]	[2]	[3]	[4]	[5]	[6]	[7]	[8]
UP	0.11	0.14	0.12	0.11	0.15	0.11	0.15	0.12
DOWN	0.12	0.11	0.13	0.11	0.12	0.11	0.14	0.12
	[9]	[10]	[11]	[12]	[13]	[14]	[15]	[16]
UP	0.11	0.14	0.12	0.11	0.15	0.11	0.15	0.12
DOWN	0.12	0.11	0.13	0.11	0.12	0.11	0.14	0.12
	[17]	[18]	[19]					
UP	0.15	0.11	0.14					
DOWN	0.12	0.11	0.11					

OK

END is displayed when the calibration is completed.

Displays the movement time

Test result (OK or NG)

```

03D DIAGNOSTICS PROGRAM V1.00

 1.Initial Test       9.WordClock Test
 2.DSP&DRAM Test   10.DIO Test
 3.LCD Test          11.Slot Test
 4.LED Test          12.AD/DA Test(Sheet only)
 5.Switch Test       13.--reserved--
 6.Enc/Mouse Test   14.Exit
 7.Fader Test        15.Fader Aging
 8.Comm. Test       16.Factory Preset

7.Fader Test
Fader Calibration : END

```

	[1]	[2]	[3]	[4]	[5]	[6]	[7]	[8]
UP	0.11	0.14	0.12	0.11	0.15	0.11	0.15	-NG-
DOWN	0.12	0.11	0.13	0.11	0.12	0.11	0.14	-NG-
	[9]	[10]	[11]	[12]	[13]	[14]	[15]	[16]
UP	0.11	0.14	0.12	0.11	0.15	0.11	0.15	0.12
DOWN	0.12	0.11	0.13	0.11	0.12	0.11	0.14	0.12
	[17]	[18]	[19]					
UP	0.15	0.11	0.14					
DOWN	0.12	0.11	0.11					

NG

NG is displayed when movement time exceeds rated time (0.3 sec.).

8. COMMUNICATION TEST

Check the port communication.

03D DIAGNOSTICS PROGRAM V1.00

<input type="checkbox"/> 1.Initial Test	<input type="checkbox"/> 9.WordClock Test
<input type="checkbox"/> 2.DSP&DRAM Test	<input type="checkbox"/> 10.DIO Test
<input type="checkbox"/> 3.LCD Test	<input type="checkbox"/> 11.Slot Test
<input type="checkbox"/> 4.LED Test	<input type="checkbox"/> 12.AD/DA Test(Sheet only)
<input type="checkbox"/> 5.Switch Test	<input type="checkbox"/> 13.--reserved--
<input type="checkbox"/> 6.Enc/Mouse Test	<input type="checkbox"/> 14.Exit
<input type="checkbox"/> 7.Fader Test	<input type="checkbox"/> 15.Fader Asins
<input checked="" type="checkbox"/> 8.Comm. Test	<input type="checkbox"/> 16.Factory Preset

8. Comm. Test

OK

TO HOST REFUSE	OK	Closed circuit check result.
9PIN REMOTE	OK	
PLEASE FUSE TO HOST & REFUSE 9PIN REMOTE	OK	Change the test setting and press the ENTER key.
TO HOST Tx Rx	OK	
9PIN REMOTE REFUSE	OK	Open circuit check result.

8-1 Closed circuit check

Check that the following set ups are completed; start the test. When the test result is OK, proceed to the next check (Open circuit check).

- A. Set the TO HOST ON/OFF switch on the communication check board to OFF.
- B. The short connector is inserted into the TO EDITOR terminal.

8-2 Open circuit check

When the closed circuit check is OK, the screen will display the following message; remove the short connector from the TO EDITOR terminal and turn the TO HOST ON/OFF switch on the communication check board to ON, and start the test by pressing the ENTER key.

PLEASE FUSE TO HOST & REFUSE 9PIN REMOTE

It can be performed using the MAIN circuit board test circuit or the TxRx shorted jack.

8-3 MIDI IN, OUT and THRU check

Applying program change data to MIDI IN; confirm that the same program change data is output to the THRU terminal and the test result data is output to MIDI OUT.

9. WORD CLOCK TEST

Performs word clock in and out check (BNC).

```

03D DIAGNOSTICS PROGRAM  V1.00

 1.Initial Test            9.WordClock Test
 2.DSP&DRAM Test        10.DIO Test
 3.LCD Test                  11.Slot Test
 4.LED Test                  12.AD/DA Test(Sheet only)
 5.Switch Test              13.--reserved--
 6.Enc/Mouse Test           14.Exit
 7.Fader Test                15.Fader Asins
 8.Comm. Test              16.Factory Preset

9.Word Clock Test _____  OK
Make Test Loop and Press ENTER!
 Internal Word Clock In/Out  OK

Change External Switch and Press ENTER!
 Word Clock Min [32KHz-6.5%]  OK
 Word Clock Max [48KHz+6.5%]  OK
    
```

Displays OK when the results of all 3 items are OK, otherwise displays NG.

Connect WORD CLOCK OUT to WORD CLOCK IN on the communication check board; press the ENTER key to start the test.

Test result. (OK or NG)

```

03D DIAGNOSTICS PROGRAM  V1.00

 1.Initial Test            9.WordClock Test
 2.DSP&DRAM Test        10.DIO Test
 3.LCD Test                  11.Slot Test
 4.LED Test                  12.AD/DA Test(Sheet only)
 5.Switch Test              13.--reserved--
 6.Enc/Mouse Test           14.Exit
 7.Fader Test                15.Fader Asins
 8.Comm. Test              16.Factory Preset

9.Word Clock Test _____  OK
Make Test Loop and Press ENTER!
 Internal Word Clock In/Out  OK

Change External Switch and Press ENTER!
 Word Clock Min [32KHz-6.5%]  OK
 Word Clock Max [48KHz+6.5%]  OK
    
```

Connect TO HOST word clock to WORD CLOCK IN on the communication check board; press the ENTER key to start the test.

Test result. (OK or NG)

Note: This test will not be performed when communication circuit is not connected.

10. DIO TEST

This test performs DIGITAL STEREO IN and OUT check (AES/EBU, COAXIAL).

```
03D DIAGNOSTICS PROGRAM V1.00
 1.Initial Test       9.WordClock Test
 2.DSP&DRAM Test   10.DIO Test
 3.LCD Test         11.Slot Test
 4.LED Test         12.AD/DA Test(Sheet only)
 5.Switch Test     13.--reserved--
 6.Enc/Mouse Test  14.Exit
 7.Fader Test      15.Fader Asins
 8.Comm. Test    16.Factory Preset
10.DIO Test  OK
Make Test Loop and Press Enter!
 AES/EBU   Status:  OK   Audio:  OK
 COAXIAL   Status:  OK   Audio:  OK
```

Displays OK when the results of all 4 items are OK, otherwise displays NG.

Connect the STEREO OUT (DIGITAL) and DIGITAL STEREO IN; press the ENTER key to start the test.

Test result. (OK or NG)

Test result. (OK or NG)

11. SLOT TEST

Check that cards jig is being inserted into its slot before executing the test.

Checks SLOT ID port of each slot.
 "O"—OK, "X"—NG
 When NG, the SLOT ID port or data bus 0~2 have some trouble.

Checks IRQSLT port of each slot.
 "O"—OK, "X"—NG
 When NG, the IRQSLT port or data bus 3 have some trouble.

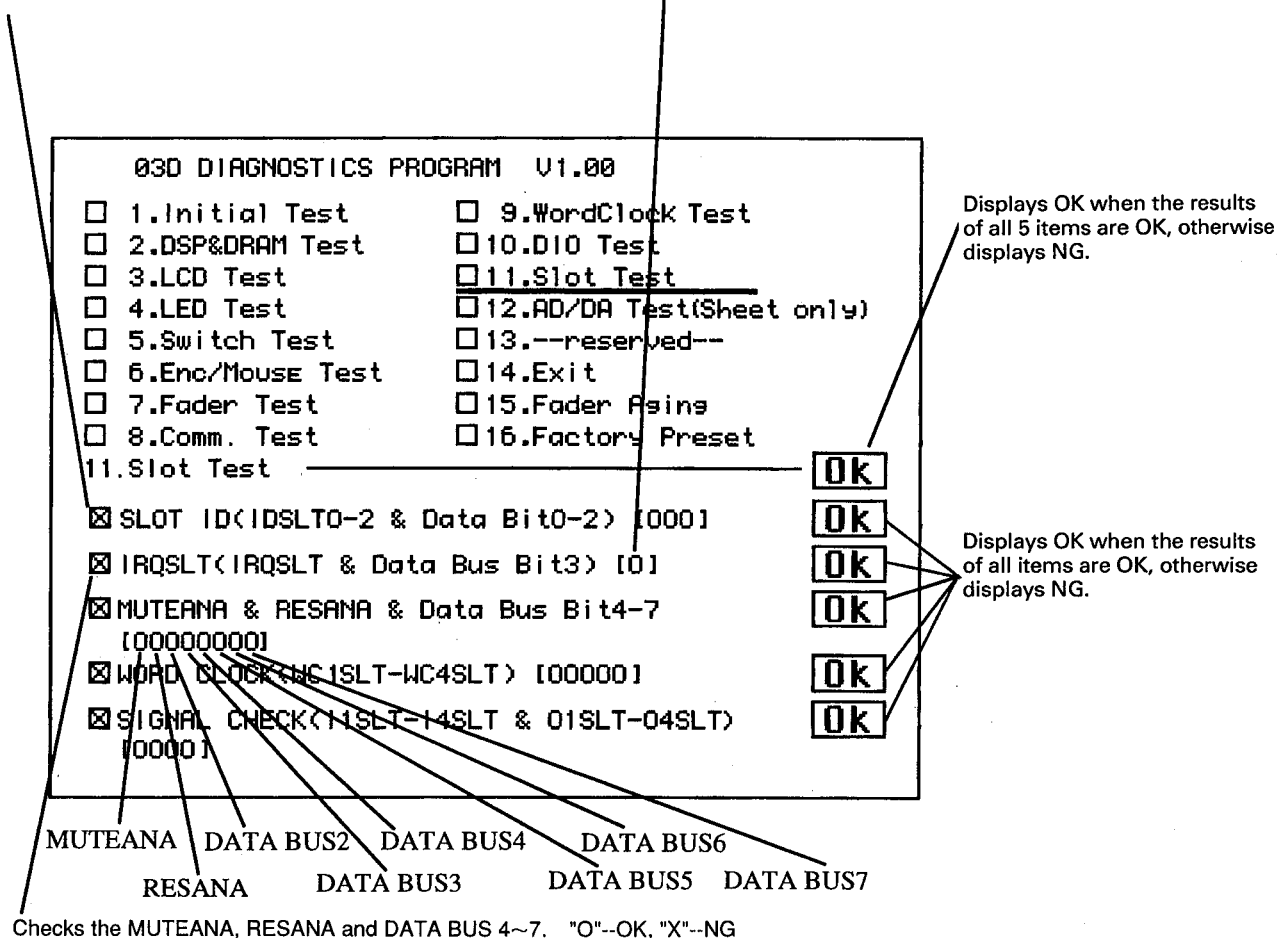

```

03D DIAGNOSTICS PROGRAM V1.00

 1.Initial Test       9.WordClock Test
 2.DSP&DRAM Test   10.DIO Test
 3.LCD Test           11.Slot Test
 4.LED Test           12.AD/DA Test(Sheet only)
 5.Switch Test        13.--reserved--
 6.Enc/Mouse Test     14.Exit
 7.Fader Test         15.Fader Asins
 8.Comm. Test       16.Factory Preset

11.Slot Test _____

 SLOT ID(IDSLT0-2 & Data Bit0-2) [000]
 IRQSLT(IRQSLT & Data Bus Bit3) [0]
 MUTEANA & RESANA & Data Bus Bit4-7
    [00000000]
 WORD CLOCK(WC1SLT-WC4SLT) [00???]
    
```

FSM 64FSM 256FSM
 SYNCM 128FSM ? : Being tested /Waiting

Checks the FSM, SYNCM, 64FSM, 128FSM, 256FSM outputs and the WC1SLT~WC4SLT port.
 "O"—OK, "X"—NG

Input port
 OK
 OK
 OK

```

03D DIAGNOSTICS PROGRAM V1.00

 1.Initial Test       9.WordClock Test
 2.DSP&DRAM Test   10.DIO Test
 3.LCD Test           11.Slot Test
 4.LED Test           12.AD/DA Test(Sheet only)
 5.Switch Test        13.--reserved--
 6.Enc/Mouse Test     14.Exit
 7.Fader Test         15.Fader Asins
 8.Comm. Test       16.Factory Preset

11.Slot Test _____

 SLOT ID(IDSLT0-2 & Data Bit0-2) [000]
 IRQSLT(IRQSLT & Data Bus Bit3) [0]
 MUTEANA & RESANA & Data Bus Bit4-7
    [00000000]
 WORD CLOCK(WC1SLT-WC4SLT) [00000]
 SIGNAL CHECK(I1SLT-I4SLT & O1SLT-O4SLT)
    [0000]
    
```

I1SLT,O1SLT I3SLT,O3SLT
 I2SLT,O2SLT I4SLT,O4SLT

Checks the I1SLT~I4SLT inputs and the O1SLT~O4SLT outputs.

OK
 OK
 OK
 OK
 OK
 OK
 Displays OK when the result of all 5 items are OK, otherwise displays NG.
 Test result. (OK or NG)

12. AD/DA TEST (SEAT ONLY)

This test is for factory use only.

14. EXIT

Exit for DIAG program.

15. FADER AGING

Faders move 100 times for aging. Pressing the ENTER key, returns to a menu screen.

```

03D DIAGNOSTICS PROGRAM V1.00
 1.Initial Test       9.WordClock Test
 2.DSP&DRAM Test    10.DIO Test
 3.LCD Test         11.Slot Test
 4.LED Test         12.AD/DA Test(Sheet only)
 5.Switch Test      13.--reserved--
 6.Enc/Mouse Test   14.Exit
 7.Fader Test        15.Fader Aging
 8.Comm. Test       16.Factory Preset

15.Fader Aging
(100times)
[=END=]

```

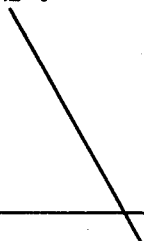

Indicates remaining times of aging movements. END will be displayed when aging is completed.

Note: Carry it out only when there is a bad fader in the movement. This aging is not required every time.

16. FACTORY SET

Initialize the data to the factory preset data and set the ID.

```

03D DIAGNOSTICS PROGRAM V1.00
 1.Initial Test       9.WordClock Test
 2.DSP&DRAM Test   10.DIO Test
 3.LCD Test         11.Slot Test
 4.LED Test         12.AD/DA Test(Sheet only)
 5.Switch Test     13.--reserved--
 6.Enc/Mouse Test   14.Exit
 7.Fader Test      15.Fader Asins
 8.Comm. Test     16.Factory Preset

16.Factory Preset
ID ...790EC209 ALREADY EXIST
CANCEL  INIT  INIT&ID
...DONE
    
```

Displays the ID which is already exist.

Displays the ID which is already inputted or which is inputted through MIDI as described below.

Set the cursor and press the ENTER key, then the unit will be initialized.

Set the cursor and press the ENTER key, then the unit ID will be changed .

Each operation can be done by inputting the following MIDI program change message.

```

CANCEL  C0 78
INIT    C0 78
INIT&ID C0 78
    
```

To set the ID, input the following MIDI System Exclusive message. It can be done only one time.

```

F0 43 00 7E 00 18 4C 4D 20 20 38 42 30 33 54 21
30 33 44 20 yy mo dd hh mn 20 20 20 20 20 00 F7
yy: year
mo: month
dd: date
hh: hour
mn: minute
    
```

SOFTWARE LOADING METHOD

The 03D can be loaded with any existing version of 03D system software, using a MIDI data device (such as the MDF2 MIDI Data Filer) or a personal computer, or a second 03D. This is made possible in the 03D through the use of on-board flash memory.

A. Connection and recommended software

	Sender	Receiver	Connecting 03D terminal	Cables	Recommended software
1	03D	03D	TO HOST	Macintosh serial cable	none required
2	MDF2	03D	MIDI IN	MIDI cable	none required
3	Macintosh	03D	TO HOST	Macintosh serial cable	Terminal-J
4	PC	03D	TO HOST	PC serial cable	HyperTerminal

Macintosh serial cable: Mini-DIN 8P to Mini-DIN 8P cross cable for Macintosh
(eg: CCJ-MAC serial cable for YAMAHA CBX products)

PC cable: Dsub 9P to Mini-DIN 8P
(eg: CCJ-PC2 serial cable for YAMAHA CBX products)

Note: HyperTerminal is a standard application in Windows 95.

B. System Software Loading Procedure

1 Using the Macintosh

- 1-1 Load the Terminal-J program onto the hard drive of the Macintosh.
 - a. Insert the Terminal-J floppy disk into the floppy disk drive.
 - b. Double-click on the floppy disk icon.
 - c. Drag the Terminal-J folder onto the hard drive.
- 1-2 Load the new 03D software onto the hard drive of the Macintosh. *Note: this step is optional, as you may elect to load the software directly from the floppy disk.*
 - a. Insert the 03D software floppy disk into the floppy disk drive.
 - b. Double-click on the floppy disk icon.
 - c. Drag the two 03D files into the Terminal-J folder on the hard drive.
- 1-3 Connect the Macintosh and 03D with a Mini-DIN 8P "crossed" cable.
- 1-4 Turn the Macintosh power switch on.
- 1-5 Turn the 03D power switch on while pressing the UTILITY, DYNAMICS and EFFECT 2 keys.
- 1-6 Set the Macintosh APPLE TALK off.
- 1-7 Open the Macintosh Terminal-J program.
- 1-8 Select CONNECTION in the Option Menu and set the following: (see Fig. 1)
 - Method: Direct Serial
 - Baud Rate: 38.4k
 - Parity bits: None
 - Data bits: 8 bits
 - Stop bits: 1
 - Handshake: None
 Click "OK".
- 1-9 Select TRANSFER in the Option menu and highlight the "Binary" icon: (see Fig. 2)
 - Recognize and use MacBinary format for non-TEXT files: OFF (no "X" in the box)
 Click "OK".
- 1-10 Select X/YMODEM in Option menu: (see Fig. 3)
 - CRC: OFF
 Click "OK".
- 1-11 Select CONNECT in the Session menu of the Terminal-J program.
- 1-12 Set the 03D using the CURSOR and ENTER keys as follows: (see Fig. 4)
 - PORT: TO HOST
 - FLYING: ON
 - UPDATE BLOCK: ALL
- 1-13 Select TRANSMIT XMODEM in the File menu, locate the 03D_Vxxx.T file in the Terminal-J folder (or floppy disk drive) and highlight it (Fig. 5). DO NOT click "Transmit" yet.
- 1-14 Select the 03D START and press the ENTER key. Now click "Transmit" on the Macintosh to begin transmission.
- 1-15 Several messages will appear on 03D LCD screen. Wait till the following message is displayed: (Fig. 6)
 - "Please send 0,1,2,3,4,5,6,7,8,9,A,B,..."
- 1-16 Select TRANSMIT XMODEM in the File menu, locate the 03D_Vxxx.X file in the Terminal-J folder (or floppy disk drive) and highlight it (Fig. 5). DO NOT click "Transmit" yet.
- 1-17 Select the 03D START and press the ENTER key. Now click "Transmit" on the Macintosh to begin transmission. Transmission will take 15-20 minutes to complete.
- 1-18 When all files has been received, the 03D displays "[] EXIT". The 03D will return to normal program mode when EXIT is selected and the ENTER key is pressed.

Note: When the 03D is receiving data, an asterisk () mark slowly flashes on the 03D display.*

2 Using a PC (Windows 95)

- 2-1 Load the 03D software onto the hard drive of the PC. *Note: this step is optional, as you may elect to load the software directly from the floppy disk.*
- Insert the 03D software floppy disk into the floppy disk drive.
 - Copy the two 03D files into the HyperTerminal folder.
- 2-2 Connect the PC (Windows 95) and the 03D with a Dsub 9P-Mini DIN 8P cable. Make note of the COM port used for this connection.
- 2-3 Turn the PC power switch on.
- 2-4 Turn the 03D power switch on while pressing the UTILITY, DYNAMICS and EFFECT 2 keys.
- 2-5 Open the Windows 95 Hyper terminal program.
- 2-6 Select NEW CONNECTION in the File menu and type a name for the connection and click "OK". Ignore the icon selection in this window (Fig 7).
- 2-7 In the Phone Number window that next appears, set the "Connect using" selection to "Direct to Com X" (X= selected port). Click "OK".
- 2-8 In the COM"X" Properties window that next appears, make the following settings:
- | | |
|----------------|-----------------|
| Bits per sec.: | 38400 bits/sec. |
| Data bits.: | 8 |
| Parity: | None |
| Stop bit: | 1 |
| Flow control: | None |
- Click "OK".
- 2-9 Select CONNECT in the Call menu.
- 2-10 Set the 03D using the CURSOR and ENTER keys as follows: (Fig. 4)
- ```
PORT: TO HOST
FLYING: ON
UPDATE BLOCK: ALL
```
- 2-11 Select SEND FILE in the Transfer menu.
- 2-12 In the Send File window that next appears, use Browse to locate the 03D\_Vxxx.T file (on the hard drive or floppy disk). Select XMODEM in the Protocol box, but DO NOT click "Send" yet. (Fig. 8)
- 2-13 Select the 03D START and press the ENTER key. Now click "Send" in the Send File window.
- 2-14 Several messages will appear on 03D LCD screen. Wait till the following message is displayed: (Fig. 6)
- ```
"Please send 0,1,2,3,4,5,6,7,8,9,A,B,..."
```
- 2-15 Select SEND FILE in the Transfer menu again.
- 2-16 In the Send File window that next appears, use Browse to locate the 03D_Vxxx.X file (on the hard drive or floppy disk). DO NOT click "Send" yet. (Fig. 8)
- 2-17 Select the 03D START and press the ENTER key. Now click "Send" in the Send File window. Transmission will take 15-20 minutes to complete.
- 2-18 When all files have been received, the 03D displays "[] EXIT". The 03D will return to normal program mode when the EXIT is selected and the ENTER key is pressed.

Note: When the 03D is receiving data, an asterisk () mark slowly flashes on the 03D display.*

3 Using an MDF2 MIDI DATA FILER

For this procedure three (3) floppy disks are needed:

Floppy Disk 1:	contains two files:	03Dxxx_.T, 03Dxxx_.X
Floppy Disk 2:	contains one file:	03Dxxx_.Y
Floppy Disk 3:	contains one file:	03Dxxx_.Z

- 3-1 Connect the MDF2 MIDI OUT to the 03D MIDI IN with a MIDI cable.
- 3-2 Turn the MDF2 power switch on and load floppy disk 1.
- 3-3 Turn the 03D power switch on while pressing the UTILITY, DYNAMICS and EFFECT 2 keys.
- 3-4 Set the 03D using the CURSOR and ENTER keys as follows: (see Fig. 4)
- ```
PORT: TO HOST
FLYING: ON
UPDATE BLOCK: ALL
```
- 3-5 Set the MDF2 to MDR mode and select the 03Dxxx\_.T file using the FILE DATA key.
- 3-6 Select the 03D START and press the ENTER key.
- 3-7 Start the MDF2.
- 3-8 Several messages will appear on 03D LCD screen. Wait till the following message is displayed: (Fig. 6)
- ```
"Please send 0,1,2,3,4,5,6,7,8,9,A,B,..."
```
- 3-9 Select the 03Dxxx_.X file on floppy disk 1 and start the MDF2.
- 3-10 Confirm that the file transfer has been completed; change floppy disk 1 to floppy disk 2 and select the 03Dxxx_.Y file. Start the MDF2.

3-11 Confirm that the file transfer has been completed; change floppy disk 2 to floppy disk 3 and select the 03Dxxx_Z file. Start the MDF2.

3-12 When all files have been received, the 03D displays "[] EXIT". The 03D will return to normal program mode when EXIT is selected and the ENTER key is pressed.

Note: When the 03D is receiving data, an asterisk () mark slowly flashes on the 03D display.*

4 Using a second 03D as software transmitter

Note: The second ("transmitter") 03D must be loaded with the version of software you wish to load into the first 03D.

4-1 Connect the "transmitter" 03D and the "receiver" 03D with a mini DIN 8P cross cable.

4-2 Turn on the transmitter 03D while pressing the UTILITY, DYNAMICS and EFFECT 2 keys.

Immediately after "BOOT UP PROGRAM....." is displayed on the 03D, press and hold the AUX4 and EFFECT1 keys, until the transmit screen is displayed. (Fig. 9)

Note: If the AUX4 and EFFECT1 keys are not pressed quickly enough, the 03D will enter "receiver" mode. If this happens, simply turn the 03D off and try step 4-2 again.

4-3 Turn on the receiver 03D while pressing the UTILITY, DYNAMICS and EFFECT 2 keys. (Fig. 4)

4-4 Set TRANSMIT: FAST on the transmitter 03D using the CURSOR and ENTER keys.

4-5 On the receiver 03D use the CURSOR and ENTER keys to set the following: (Fig. 4)

PORT: TO HOST
FLYING: ON
UPDATE BLOCK: ALL

4-6 Select the START on the receiver 03D and press the ENTER key.

4-7 Select the START on the transmitter 03D and press the ENTER key.

4-8 Several messages will appear on 03D LCD screen. Wait till the following message is displayed: (Fig. 6)

"Please send 0,1,2,3,4,5,6,7,8,9,A,B,..."

4-9 Again, select the START on the receiver 03D and press the ENTER key.

4-10 Again, select the START on the transmitter 03D and press the ENTER key.

4-11 When all files has been received, the 03D displays "[] EXIT". The 03D will return to normal program mode when the EXIT is selected and the ENTER key is pressed.

Note: When the 03D is receiving data, an asterisk () mark slowly flashes on the 03D display.*

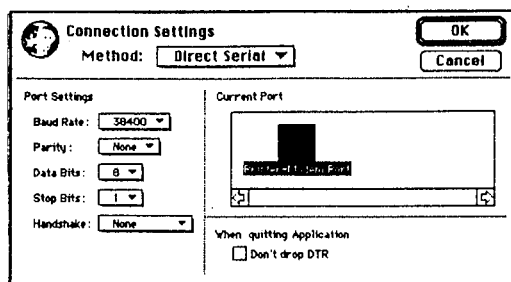

(Fig. 1)

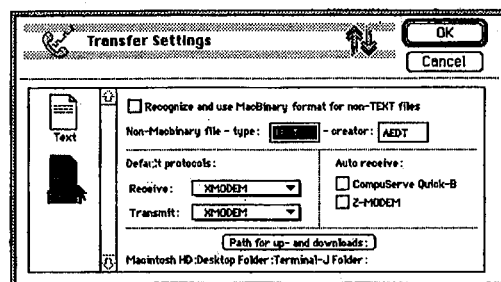

(Fig. 2)

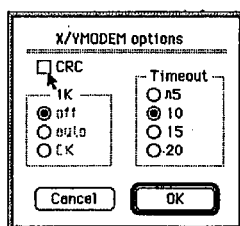

(Fig. 3)

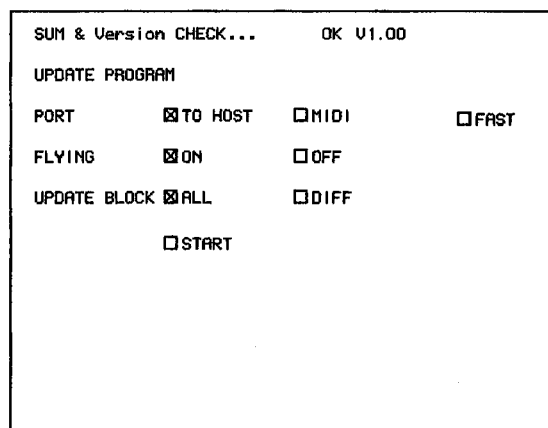

(Fig. 4)

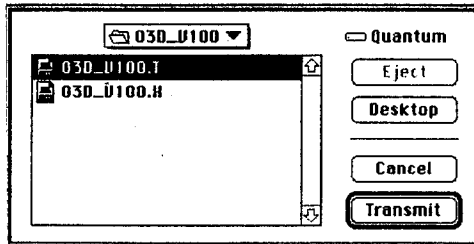

(Fig. 5)

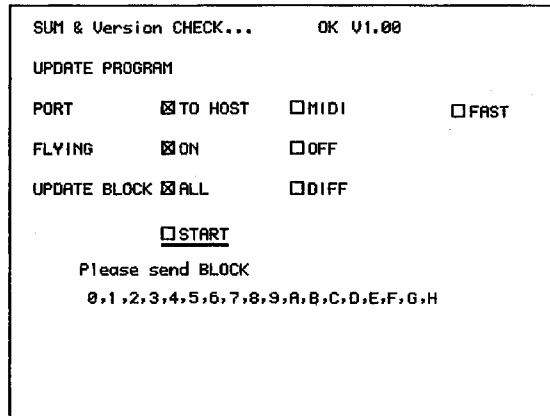

(Fig. 6)

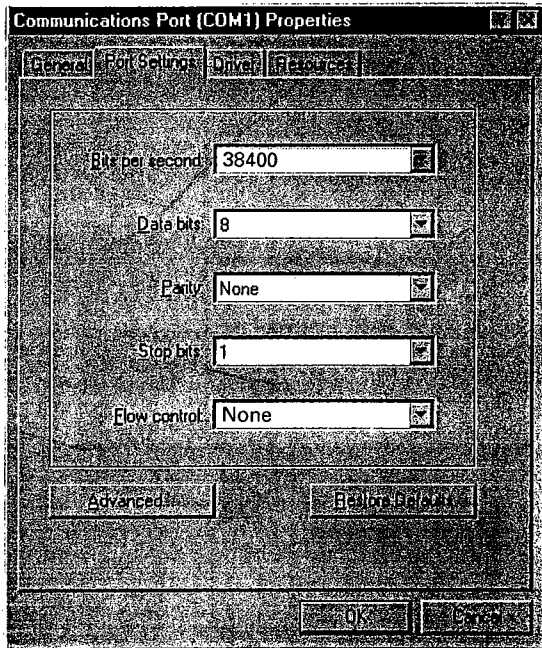

(Fig. 7)

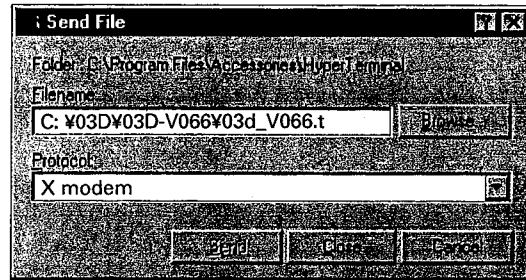

(Fig. 8)

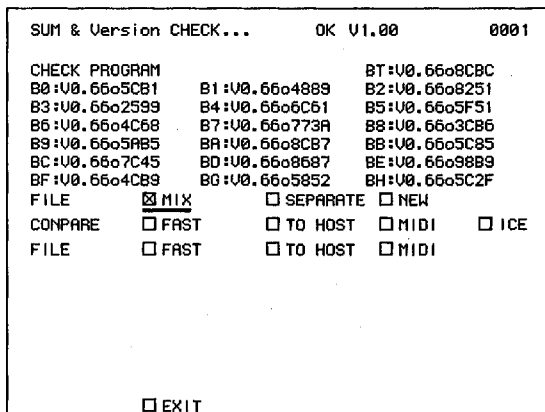

(Fig. 9)

■ DISPLAY MESSAGES

Message	Meaning
AUTOMIX MEMORY FULL!	The automix memory is full. Delete some unnecessary data or back up your data to a MIDI data filer.
AUTOMIX REC ABORTED.	Automix recording was aborted and the data was discarded. If the automix undo buffer is set to ENABLE, you can undo the operation.
AUTOMIX REC STOPPED!	Automix recording was stopped.
AUTOMIX REC TIME EXCEEDED!	The total recording time for automix has been exceeded.
AUTOMIX RUNNING.	Cannot operate while automix is recording or playing.
BULK: AUTOMIX MEMORY FULL!	The received Bulk Dump data cannot be stored because the automix memory is full.
BULK: BYTE COUNT MISMATCH!	The byte count of the received Bulk Dump data is not correct.
BULK: CHECK SUM MISMATCH!	The check sum of the received Bulk Dump data is not correct.
BULK: MEMORY PROTECTED!	The Bulk Dump data cannot be stored because the destination is write-protected.
CANNOT CONNECT!	Connection could not be made with the device selected on the MIDI REMOTE page. Check the port setting and connections.
CANNOT EXECUTE (NO DATA).	Cannot execute as no data has been stored.
CH17-24 ARE DISABLED!	When a CD8-CS cascade card is installed in the YGDAI slot, input channels 17-24 are disabled.
DIGITAL ST IN SYNC ERROR!	The digital audio signal connected via the DIGITAL ST IN connector is not synchronized with the wordclock master. This may cause noise. Make sure that the device feeding the DIGITAL ST IN is synchronized to the master wordclock or make the DIGITAL ST IN the wordclock source. This message can be disabled by setting the DIGITAL ST IN SYNC CAUTION preference to OFF on the Prefer. page of the UTILITY function.
FOR EFFECT1 ONLY.	The selected effect program can be recalled only to Effect 1.
LOW BATTERY!!	The internal battery voltage is getting very low. Back up the setup data (<i>Bulk Dump</i> on page 242), and ask your dealer to replace the battery.
MIDI IN: DATA FRAMING ERROR!	An incorrect signal may have been input to the MIDI IN.
MIDI IN: DATA OVERRUN!	An incorrect signal may have been input to the MIDI IN.
MIDI: Rx BUFFER FULL!	The 03D is probably receiving too much MIDI data.
MIDI: Tx BUFFER FULL!	The 03D is probably transmitting too much MIDI data.
NO DATA TO RECALL.	Cannot recall as no data has been stored.
RECALL SAFE DATA CONFLICT!	Some channels are protected by the scene memory recall safe function. However, the memory you are trying to recall has different bus and aux pair settings and pan mode (stereo/surround) settings, so the scene recall could not be executed.
SOLO READY.	Solo mode is active. Use the [SEL] buttons to solo channels.
SOLO SLAVE.	When the 03D is configured as cascade slave, you cannot change the solo status. Use the [SOLO] button on the cascade master.
TC FRAME JUMP!	The timecode being received is jumping and dropping frames. Check the device outputting the timecode.

Message	Meaning
TC TYPE MISMATCH!	Timecode that is different from the automix Time Base setting has been input. The automix may not play back correctly. Review and correct the setting.
TO HOST: DATA FRAMING ERROR!	An incorrect signal may have been input to the TO HOST connector.
TO HOST: DATA OVERRUN!	An incorrect signal may have been input to the TO HOST connector.
TO HOST: DATA PARITY ERROR!	An incorrect signal may have been input to the TO HOST connector.
TO HOST: RX BUFFER FULL!	The 03D is probably receiving too much MIDI data at the TO HOST connector.
TO HOST: TX BUFFER FULL!	The 03D is probably transmitting too much MIDI data from the TO HOST connector.
WRONG WORD CLOCK!	The received wordclock is not correct and the 03D cannot synchronize correctly. Select an appropriate wordclock by reviewing the system connections, or use the AUTO NAVI-GATE function on the D.in Setup page of the DIO function.
YGDAI INPUT SYNC ERROR!	The digital audio signal connected via the YGDAI card is not synchronized with the wordclock master. This may cause noise. Make sure that the device feeding the YGDAI card inputs is synchronized to the master wordclock. Even if the sync system is correctly configured, the wordclock may become unstable until the digital MTR enters chase mode, and this message may appear. This message can be disabled by setting the YGDAI IN SYNC CAUTION preference to OFF on the Prefer. page of the UTILITY function.