

• CTRL Circuit Board 1/5

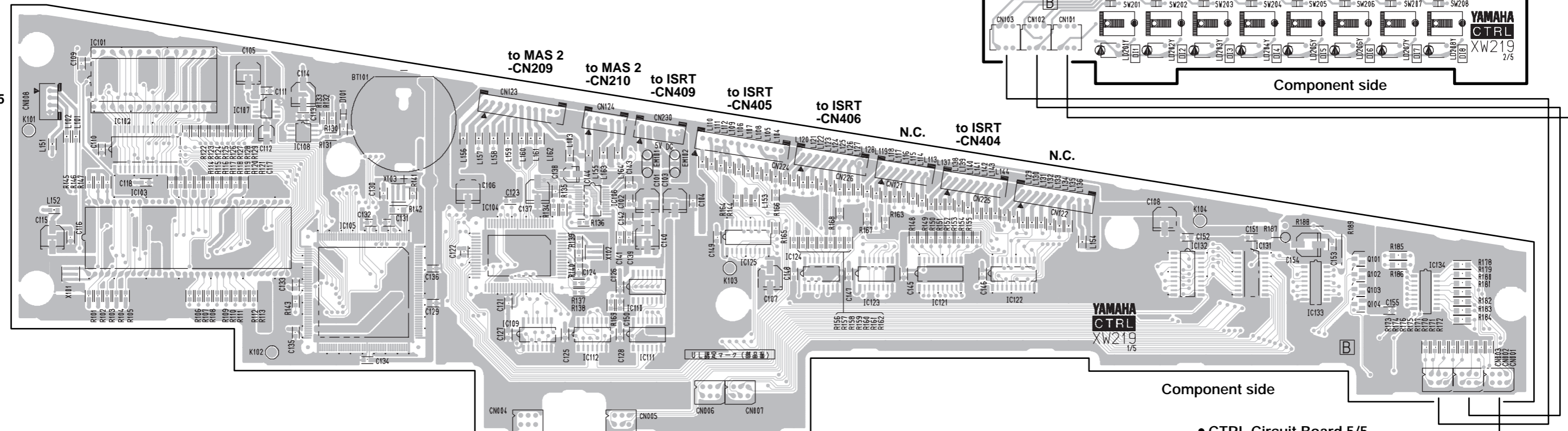

• CTRL Circuit Board 2/5

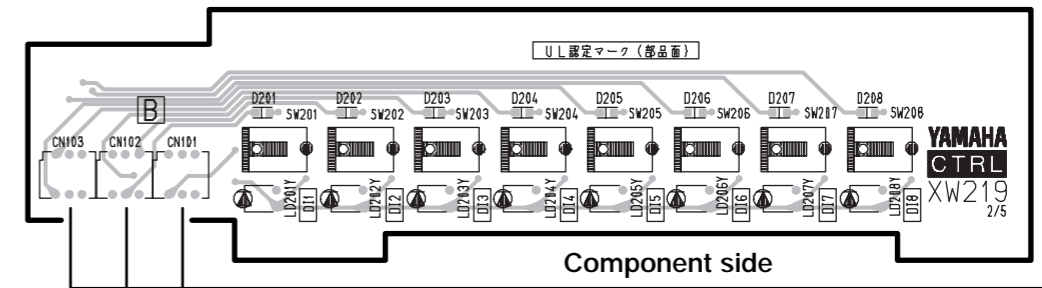

• CTRL Circuit Board 4/5

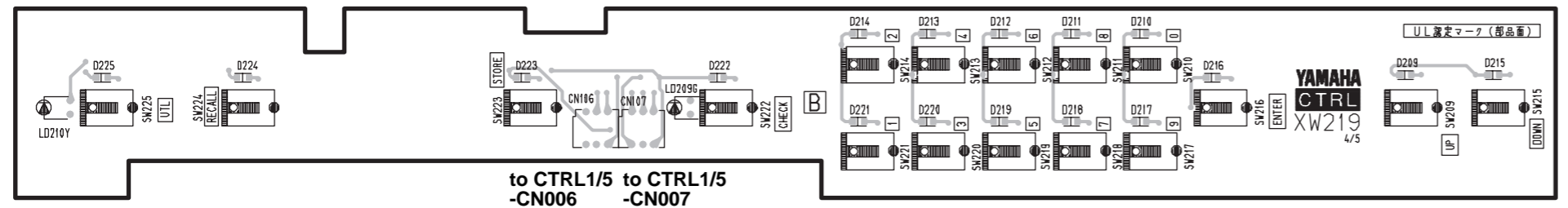

• CTRL Circuit Board 3/5

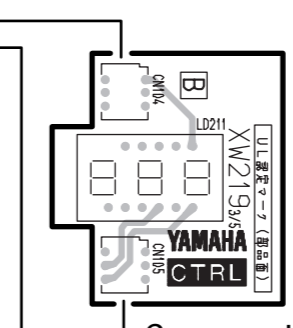

• CTRL Circuit Board 5/5

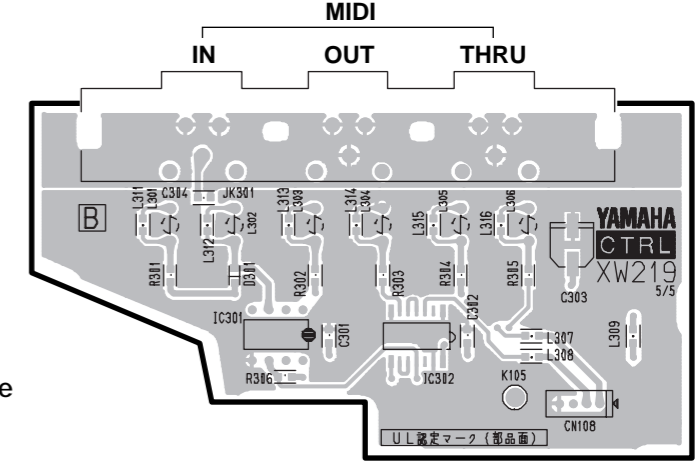

to CTRL1/5 -CN108

Battery VN103500
VN103600(Battery holder for VN103500)

- Notice for back-up battery removal
Push the battery as shows in figure, then the battery will pop up.
- Druk de batterij naar beneden zoals aangeven in de tekening, de batterij springt dan naar voren.

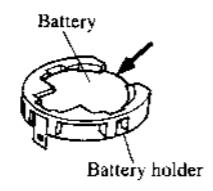

• CTRL Circuit Board 2/5

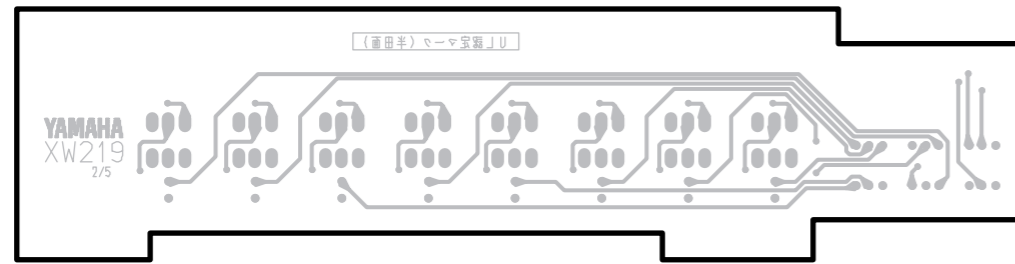

Pattern side

• CTRL Circuit Board 1/5

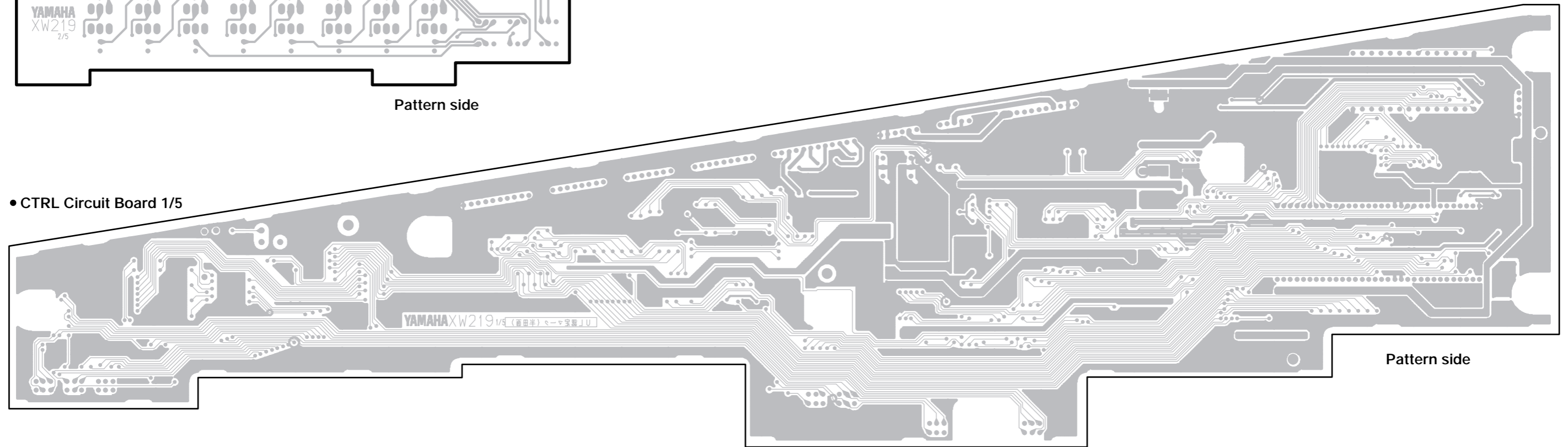

Pattern side

• CTRL Circuit Board 5/5

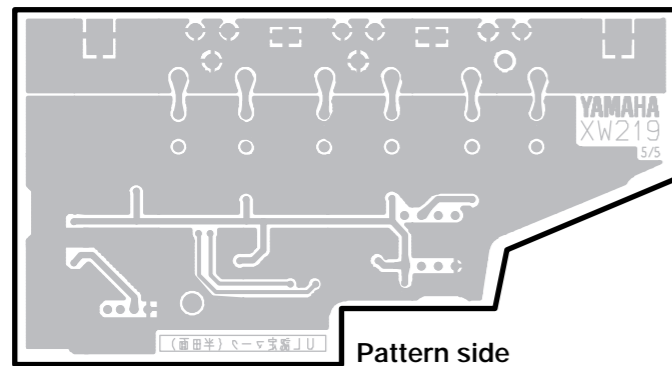

Pattern side

• CTRL Circuit Board 3/5

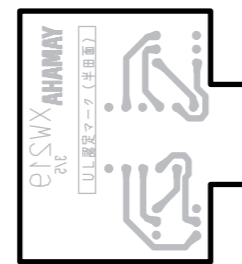

Pattern side

• CTRL Circuit Board 4/5

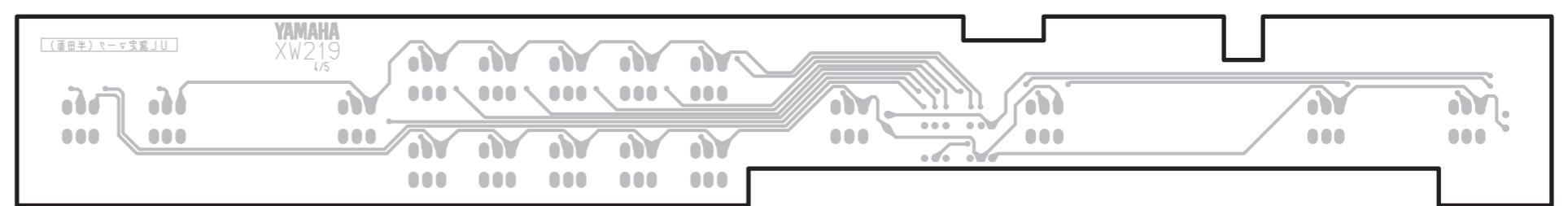

Pattern side

• IN1 Circuit Board

to INJK-CN602

to INJK-CN601

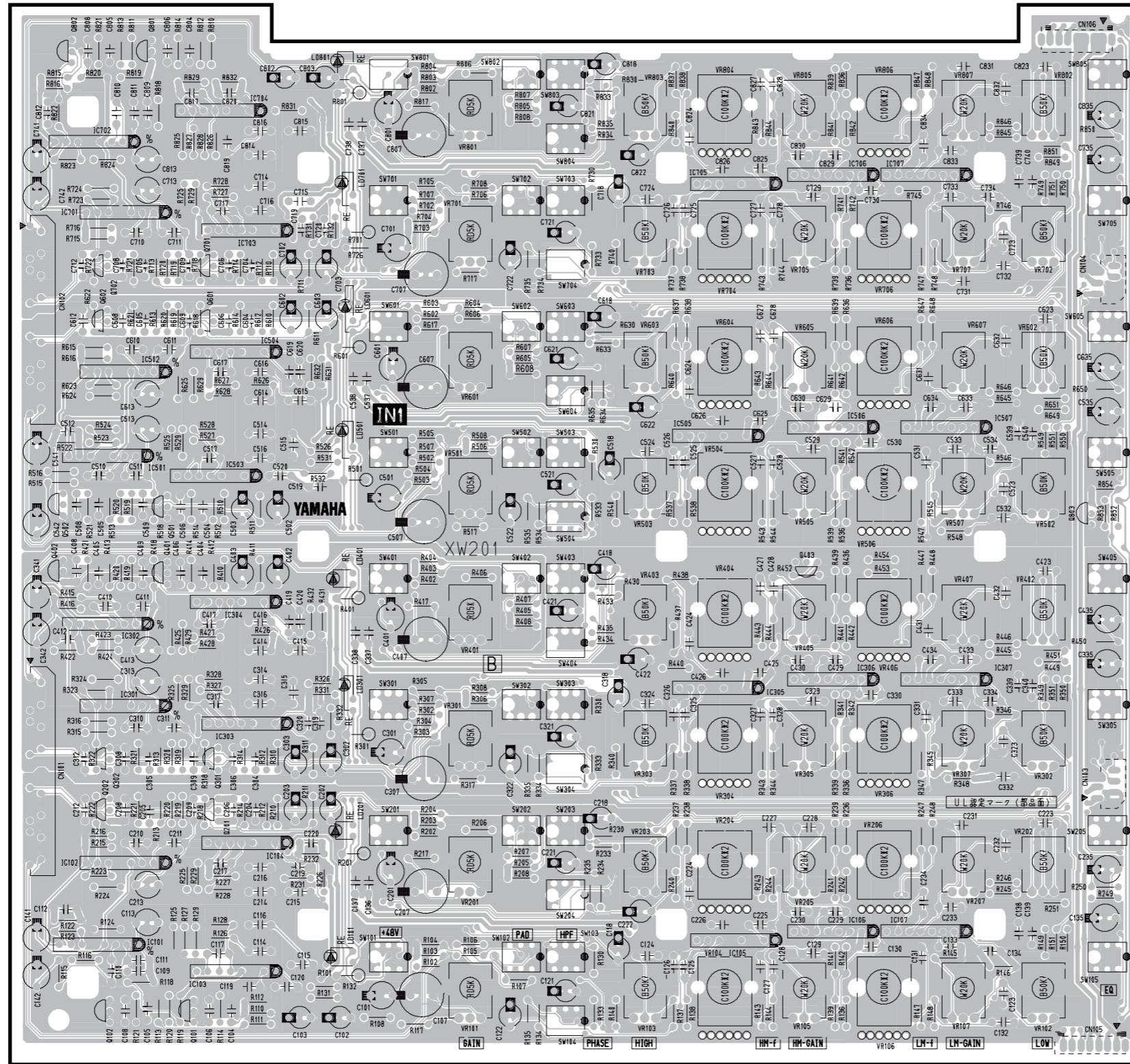

to IN1-CN105
ISRT-CN212
NC

to IN2
-CN202

to IN2
-CN201

to IN2-CN106
ISRT-CN314
NC

Component side

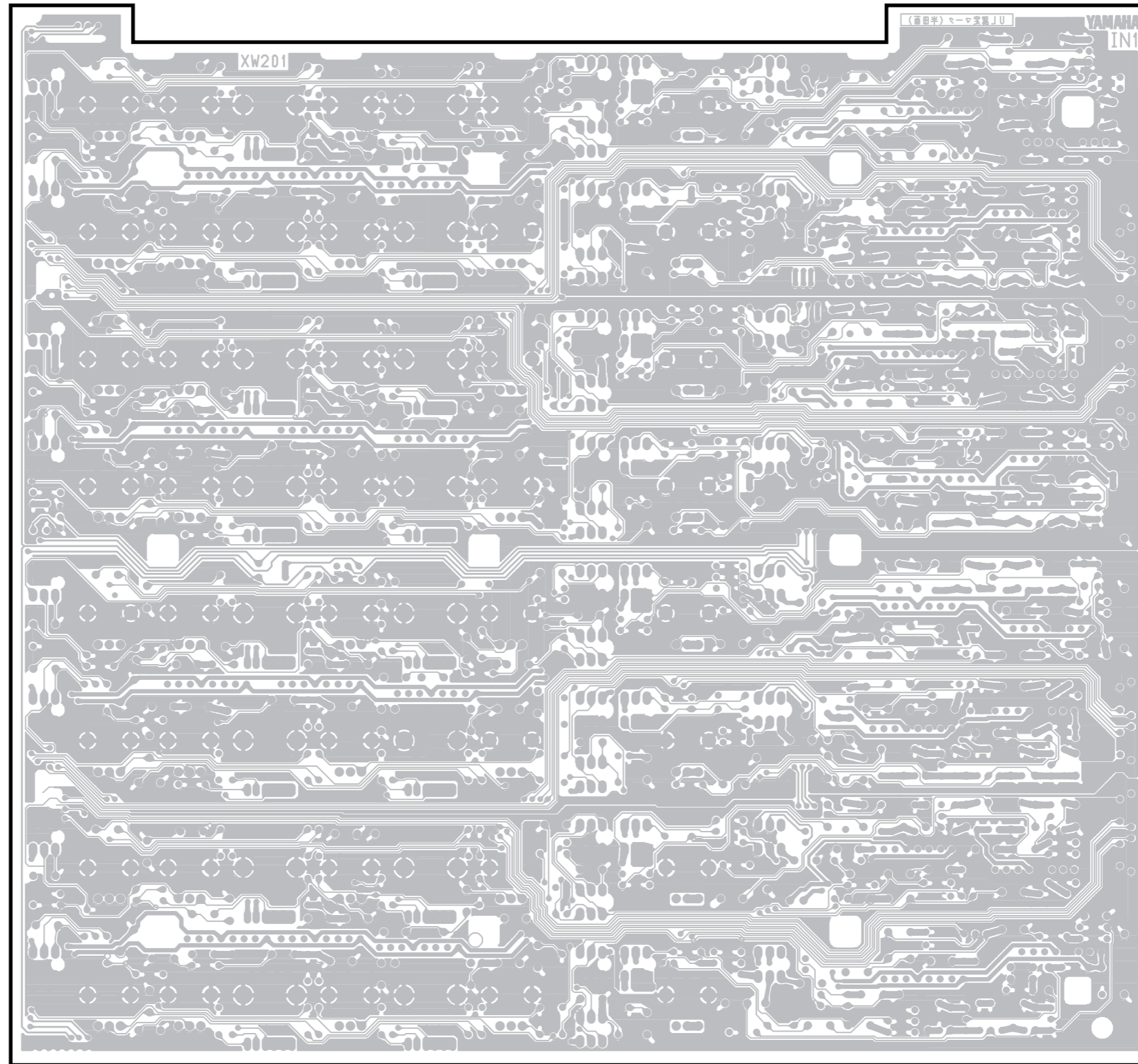

Pattern side