

# MIXING CONSOLE

# PM3500M

## OPERATING MANUAL

### Bescheinigung des Importeurs

Hiermit wird bescheinigt, daß der/die/das

**MIXING CONSOLE Typ : PM3500M**

(Gerät, Typ, Bezeichnung)

in Übereinstimmung mit den Bestimmungen der

**VERFÜGUNG 1046/84**

(Amtsblattverfügung)

funkentstört ist.

Der Deutschen Bundespost wurde das Inverkehrbringen dieses Gerätes angezeigt und die Berechtigung zur Überprüfung der Serie auf Einhaltung der Bestimmungen eingeräumt.

**Yamaha Europa GmbH**

Name des Importeurs



## FCC INFORMATION (U.S.A.)

**1. IMPORTANT NOTICE: DO NOT MODIFY THIS UNIT!**

This product, when installed as indicated in the instructions contained in this manual, meets FCC requirements. Modifications not expressly approved by Yamaha may void your authority, granted by the FCC, to use the product.

**2. IMPORTANT:** When connecting this product to accessories and/or another product use only high quality shielded cables. Cable/s supplied with this product **MUST** be used. Follow all installation instructions. Failure to follow instructions could void your FCC authorization to use this product in the USA.

**3. NOTE:** This product has been tested and found to comply with the requirements listed in FCC Regulations, Part 15 for Class "B" digital devices. Compliance with these requirements provides a reasonable level of assurance that your use of this product in a residential environment will not result in harmful interference with other electronic devices. This equipment generates/uses radio frequencies and, if not installed and used according to the instructions found in the users manual, may cause interference harmful to the operation of other electronic devices. Compliance with FCC regulations does not guarantee that interference will not occur in all installations. If this product is found to be the source of interference, which can be determined by turning the unit "OFF" and "ON", please try to eliminate the problem by using one of the following measures:

Relocate either this product or the device that is being affected by the interference.

Utilize power outlets that are on different branch (circuit breaker or fuse) circuits or install AC line filter/s.

In the case of radio or TV interference, relocate/reorient the antenna. If the antenna lead-in is 300 ohm ribbon lead, change the lead-in to co-axial type cable.

If these corrective measures do not produce satisfactory results, please contact the local retailer authorized to distribute this type of product. If you can not locate the appropriate retailer, please contact Yamaha Corporation of America, Electronic Service Division, 6600 Orangethorpe Ave, Buena Park, CA 90620

The above statements apply **ONLY** to those products distributed by Yamaha Corporation of America or its subsidiaries.

## CANADA

THIS DIGITAL APPARATUS DOES NOT EXCEED THE "CLASS B" LIMITS FOR RADIO NOISE EMISSIONS FROM DIGITAL APPARATUS SET OUT IN THE RADIO INTERFERENCE REGULATION OF THE CANADIAN DEPARTMENT OF COMMUNICATIONS.

LE PRESENT APPAREIL NUMERIQUE N'EMET PAS DE BRUITS RADIOELECTRIQUES DEPASSANT LES LIMITES APPLICABLES AUX APPAREILS NUMERIQUES DE LA "CLASSE B" PRESCRITES DANS LE REGLEMENT SUR LE BROUILLAGE RADIOELECTRIQUE EDICTE PAR LE MINISTERE DES COMMUNICATIONS DU CANADA.

## ADVARSEL!

Lithiumbatteri—Eksplønsionsfare ved fejlagtig håndtering. Udskiftning må kun ske med batteri af samme fabrikat og type. Levér det brugte batteri tilbage til leverandoren.

## VARNING

Explosionsfara vid felaktigt batteribyte. Använd samma batterityp eller en ekvivalent som rekommenderas av apparatillverkaren. Kassera använt batteri enligt fabrikantens instruktion.

## VAROITUS

Paristo voi räjähtää, jos se on virheellisesti asennettu. Vaihda paristo ainoastaan laitevalmistajan suosittelemiin tyyppiin. Hävitä käytetty paristo valmistajan ohjeiden mukaisesti.

## ■ Precaution

Do not place a container with liquid or small metal objects on top of this unit. Liquid or metal objects inside this unit are a fire and electrical shock hazard.

## How to use this manual

1.1 Terminology and typographic conventions .....	7
1.2 Features .....	7

## Features

2.1 Front panel features .....	11
2.1.1 Monaural input module .....	11
[1] +48V (phantom power)	
[2] GAIN	
[3] 30dB (pad switch)	
[4] Ø (Phase)	
<i>Equalizer</i>	
[5] HI (peak/shelf)	
[6] HI-MID	
[7] LO-MID	
[8] LO (peak/shelf)	
[9] EQ	
[10] INSERT	
[11] HPF (switch and control)	
[12] AUX 1-8 (AUX ON/OFF, PRE/POST and ST switches, and level controls)	
[13] GROUP send ON/OFF and PRE switches and level controls	
[14] ST (stereo) controls	
[15] PEAK, NOMINAL and SIGNAL indicators	
[16] ON/EDIT switch and CHECK indicator	
[17] VCA GROUP (1 through 8)	
[18] Fader	
[19] CUE	
<i>Cue groups and cue priority</i>	
2.1.2 Control module .....	18
<i>Solo section</i>	
[20] SOLO switch	
[21] SOLO SEL – MTRX, AUX, GROUP, ST (solo select switches)	
[22] CUE MODE SEL– MASTER CUE PFL, VCA CUE PRE PAN, (cue mode selector switches)	
[23] LAST CUE	
<i>Scene memory controls</i>	
[24] UTILITY key	
[25] RECALL key	
[26] MEMORY display	
[27] STORE key	
[28] CHECK key	
[29] Number keys and ENTER	
[30] UP/DOWN keys	
[31] DIRECT RECALL	
2.1.3 Group master modules .....	21
<i>Matrix section (modules 1 through 4)</i>	
[32] SUB IN L and R	
[33] ST L and R	
[34] 1 through 8 LVL (level) and PAN controls	
[35] MASTER control	
[36] ON/EDIT key and CHECK indicator	
[37] CUE (matrix cue)	
<i>AUX sends</i>	
[38] INSERT (AUX send insert switches)	
[39] AUX send faders	
[40] Σ PEAK indicators	
[41] ON/EDIT keys and CHECK indicators	
[42] CUE (AUX send cue)	

## Table of Contents

<i>VCA group section</i>	
[43] VCA MUTE	
[44] VCA MASTER fader	
[45] NOMINAL Indicator	
[46] VCA CUE switch	
<i>Some additional VCA details</i>	
2.1.4 Group master modules 2 .....	24
[47] Matrix level controls	
[48] Main channel group STEREO panpots	
[49] TO ST (to STereo) switches	
[50] TO MATRIX switches	
[51] INSERT (group insert switches)	
[52] GROUP faders	
[53] $\Sigma$ PEAK indicators	
[54] ON/EDIT keys and CHECK indicators	
[55] CUE (group cue)	
2.1.5 Stereo master module .....	25
<i>Talkback and oscillator section</i>	
[56] GROUP and ST (talkback to group and stereo routing switches)	
[57] AUX (talkback to AUX routing switches)	
[58] OSC OUT (oscillator output)	
[59] TB OUT (talkback output)	
[60] PINK, 10k, 1k, 100, OFF and OSC ON (oscillator switches and indicator)	
[61] SWEEP (oscillator sweep control and switch)	
[62] LEVEL OSC (oscillator level)	
[63] INPUT -50dB (talkback input)	
[64] $\sqrt{80}$ (80Hz bass roll-off talkback filter)	
[65] LEVEL (TB Input)	
[66] ON (Talkback ON switch)	
<i>Stereo section</i>	
[67] ST TO MATRIX (stereo to matrix switch)	
[68] INSERT (stereo insert)	
[69] $\Sigma$ PEAK L and R indicators	
[70] ON/EDIT key and CHECK indicator	
[71] CUE (stereo cue)	
[72] Faders (stereo faders)	
2.1.6 Monitor module .....	28
[73] PFL TRIM	
[74] VCA CUE TRIM	
<i>MONITOR B</i>	
[75] TB, 2TR IN 1, 2 TR IN 2, MONI A (monitor B selector switches)	
[76] LEVEL (MONITOR B level control)	
[77] ON (MONITOR B switch)	
<i>MONITOR A</i>	
[78] 2TR IN 1, 2 TR IN 2, L MONO, R MONO (monitor A selector switches)	
[79] LEVEL (MONITOR A level control)	
[80] ON (MONITOR A switch)	
[81] INPUT, VCA, MASTER (cue source indicators)	
[82] MATRIX, AUX, GROUP (meter selection switches)	
[83] PHONES (headphone level control)	
[84] PHONES connectors	
2.1.7 Meter bridge .....	30
[85] PW CAUTION, +48, +12, +19, -19 (power supply indicators)	
[86] Lamp dimmer	
<b>2.2 PM3500M rear panel features .....</b>	<b>31</b>
<i>Some points to note:</i>	
2.2.1 Monaural input module .....	31
[87] INPUT	
[88] INSERT OUT and INSERT IN	

[89] DIRECT OUT	
2.2.2 SUB IN connectors .....	32
[90] GROUP SUB IN (1 through 8)	
[91] AUX SUB IN (1 through 8)	
[92] ST SUB IN (stereo sub inputs)	
[93] CUE SUB IN (L and R)	
[94] MATRIX SUB IN (L and R)	
[95] 2 TR IN 1 and 2 TR 2 (L and R)	
2.2.3 INSERT points .....	33
[96] ST INSERT L and R (OUT/IN) (stereo insert points)	
[97] GROUP INSERT 1 through 8 (OUT/IN)	
[98] AUX INSERT 1 through 8 (OUT/IN)	
2.2.4 OUTPUTs .....	33
[99] MONITOR A and MONITOR B (L and R)	
[100] ST OUT (L and R)	
[101] MATRIX OUT (5 through 8)	
[102] GROUP OUT (1 through 8)	
[103] ST MATRIX OUT (1 through 4, L and R)	
[104] AUX OUT (1 through 8)	
[105] TALKBACK OUT	
[106] OSC OUT	
2.2.5 Control functions .....	34
[107] VCA CONTROL connector and MASTER/SLAVE switch	
[108] INPUT CUE/SOLO	
[109] CUE CONTROL IN/OUT	
[110] MIDI IN, MIDI OUT, MIDI THRU	
[111] DC POWER input	
[112] PHANTOM MASTER	
[113] FAN LOW/HIGH	
<b>2.3 The PW4000 power supply .....</b>	<b>35</b>
[114] POWER	
[115] Operation monitor	
[116] Grille	
[117] Power cord	
[118] LINE VOLTAGE INDICATOR (Switch)	
[119] FUSES	
[120] DC OUTPUT (umbilical connector)	

## **Specifications**

<b>3.1 PM3500M mixing console general specifications .....</b>	<b>37</b>
<b>3.2 Input characteristics .....</b>	<b>39</b>
<b>3.3 Output characteristics .....</b>	<b>40</b>
<b>3.4 Dimensional drawings .....</b>	<b>41</b>
<b>3.5 Optional equipment and parts for the PM3500M console .....</b>	<b>43</b>
<b>3.6 Block diagrams .....</b>	<b>44</b>
3.6.1 Monaural input module .....	44
3.6.2 SOLO and scene recall module .....	45
3.6.3 Group master module 1 .....	46
3.6.4 Group master module 2 .....	47
3.6.5 Stereo master module .....	48
3.6.6 Monitor module .....	49
3.6.7 Meter bridge .....	50

## Table of Contents

<b>3.7 PW4000 power supply specifications</b> .....	51
---	----

## MIDI scenes

<b>4.1 Normal mode</b> .....	53
4.1.1 Using the DIRECT RECALL keys to recall scenes .....	53
4.1.2 Using the UP and DOWN keys to recall scenes .....	53
4.1.3 Using the number keys to recall scenes .....	53
4.1.4 Using MIDI to recall scenes .....	54
4.1.5 Storing scenes .....	54
4.1.6 Controlling individual channels through MIDI .....	54
<b>4.2 CHECK mode</b> .....	54
4.2.1 Recalling scenes in CHECK mode .....	54
4.2.2 Pre-setting scenes in CHECK mode .....	54
<b>4.3 UTILITY mode</b> .....	55
4.3.1 Program Change messages .....	55
4.3.2 Control Change messages .....	55
4.3.3 System Exclusive messages .....	55
4.3.4 Running status .....	55
4.3.5 Echo back .....	55
4.3.6 UTILITY mode functions .....	56
4.3.7 Control Change messages and bus ON/EDIT switches .....	57
<b>4.4 Error messages on the display</b> .....	58
<b>4.5 MIDI bulk dump formats</b> .....	58
<b>4.6 MIDI implementation chart</b> .....	60
<b>4.7 Midi flowcharts (transmission and reception)</b> .....	61

## Installation notes

<b>5.1 Planning an installation</b> .....	63
<b>5.2 Power mains</b> .....	63
5.2.1 Verify the correct mains voltage .....	63
5.2.2 Ensure there is a good earth ground .....	63
5.2.3 How to obtain a safety ground when using a 2-wire outlet .....	64
5.2.4 Improperly wired AC outlets: lifted grounds .....	64
5.2.5 Improperly wired AC outlets: lifted neutral .....	65
5.2.6 AC safety tips .....	65
5.2.7 Power source integrity .....	66
5.2.8 Turn-on sequencing .....	66
<b>5.3 Theory of grounding</b> .....	66
5.3.1 Why is proper grounding important? .....	67
5.3.2 Ground loops .....	67
5.3.3 Basic grounding techniques .....	68
5.3.4 Balanced lines and ground lift switches .....	69
<b>5.4 Audio connectors and cables</b> .....	69
5.4.1 Types of cable to use .....	70
5.4.2 Cable layout .....	70
5.4.3 Balanced versus unbalanced wiring .....	71
5.4.4 The pros and cons of input transformers .....	71
5.4.5 Noise and losses in low and high impedance lines .....	73
<b>5.5 Configuring equipment racks</b> .....	73

## Gain structure and levels

<b>6.1 Standard operating levels</b> .....	75
6.1.1 Mic level or low level .....	75
6.1.2 Line level or medium level .....	75
6.1.3 Speaker level and high level .....	75
<b>6.2 Dynamic range and headroom</b> .....	76
6.2.1 What is dynamic range? .....	77
6.2.2 The relationship between sound levels and signal levels .....	77
6.2.3 A discussion of headroom .....	77
6.2.4 What happens when the program source has wider dynamics than the sound equipment? ..	77
6.2.5 A general approach to setting levels in a sound system .....	77
6.2.6 How to select a headroom value and adjust levels accordingly .....	78
<b>6.3 Gain overlap and headroom</b> .....	80

## Optional functions

<b>7.1 Removing and installing a module</b> .....	81
<b>7.2 Monaural input modules</b> .....	82
7.2.1 Insert I/O pre- or post-EQ (switch) .....	82
7.2.2 Direct out pre-EQ or post-fader (switch) .....	82
7.2.3 Direct out pre- or post-ON switch (jumper) .....	82
7.2.4 SOLO safe (jumper) .....	83
7.2.5 AUX 1 through 8 pre-EQ or post-EQ (switch) .....	83
7.2.6 Group 1 through 8 pre-EQ or post-EQ (switch) .....	83
<b>7.3 Group master modules 1</b> .....	83
7.3.1 AUX CUE AFL pre- /post-ON jumpers .....	83
7.3.2 Matrix CUE AFL pre- /post-ON jumpers .....	83
<b>7.4 Group master modules 2</b> .....	84
7.4.1 Group sum gain (0, +6dB) switch .....	84
7.4.2 Group-to-stereo jumpers .....	84
7.4.3 Group-to-matrix pre- /post-fader jumpers .....	85
7.4.4 Matrix CUE AFL pre- /post-ON jumpers .....	85
7.4.5 Group CUE AFL pre- /post-ON jumpers .....	85
7.4.6 Group-to-stereo pre- / post ON jumpers .....	85
<b>7.5 Stereo master module</b> .....	85
7.5.1 Stereo-to-matrix pre- /post-fader jumpers .....	85
7.5.2 Stereo-to-matrix pre- / post ON jumpers .....	86
7.5.3 Stereo CUE AFL pre- /post-ON jumpers .....	86
7.5.4 Talkback-to-group gain (0, -6dB) switch .....	86
<b>7.6 Hints on circuitry for remote control of the VCA masters</b> .....	86

## Operating notes and hints

<b>8.1 Console gain structure</b> .....	89
8.1.1 What is the proper gain structure? .....	89
8.1.2 What affects gain structure? .....	89
8.1.3 Establishing the correct input channel settings .....	89
8.1.4 Establishing the correct group master settings .....	90
8.1.5 How VCA control affects gain structure .....	90
8.1.6 Channel muting and gain structure .....	91
<b>8.2 Further hints &amp; conceptual notes</b> .....	91
8.2.1 What is a VCA, and why is it used? .....	91
8.2.2 The distinction between the group busses and the VCA master "groups" .....	92

## **Table of Contents**

8.2.3 Using the channel INSERT IN jack as a line input .....	93
--	----

### **Applications**

<b>9.1 General applications</b> .....	95
<b>9.2 The “Super band” input source list</b> .....	95
9.2.1 Stage monitor mixing .....	96
9.2.2 Wireless stage monitoring .....	98
<b>9.3 Using the PM3500M in a theatrical application</b> .....	100
<b>9.4 TV production (general)</b> .....	102
<b>9.5 TV Sports production (golf)</b> .....	104
<b>9.6 House of Worship application</b> .....	106
<b>9.7 Concert “house” mixing</b> .....	108
<b>9.8 Linking consoles</b> .....	108
<b>9.9 Conclusion</b> .....	109

### **Maintenance**

<b>10.1 Cleaning the console</b> .....	111
10.1.1 The console and power supply exterior .....	111
10.1.2 Power supply air filters .....	111
10.1.3 Pots and faders .....	111
10.1.4 The console interior .....	111
10.1.5 Meter lamp replacement .....	111
<b>10.2 Where to check if there is no output</b> .....	112
<b>10.3 What to do in case of trouble</b> .....	112

### **Block and level diagram**



# 1 How to use this manual

---

If you are an engineer or technician who is familiar with sound system design, much of this manual will serve as a review for you. The basic features are presented in the “FEATURES” section. Check this and the “SPECIFICATIONS” section, and you will see most of what you need to know. The rest of this manual provides background information to help you make the most of this console and auxiliary equipment.

If you want to know more about AC power distribution and safety, grounding, balanced versus unbalanced cables, direct boxes, and so forth, this information is also present in this manual. Check the “TABLE OF CONTENTS”.

There are internal preset switches within the console which can be configured to change the functions and/or signal paths in certain circuits. Refer to the “OPTIONAL FUNCTIONS” section for details.

## 1.1 Terminology and typographic conventions

Generally, where we refer to a particular control or function as it is actually labeled on the console, we will use all uppercase type. That is, if when referring to an input channel’s gain control, we may print “the input GAIN control.” On the other hand, if the feature is not labeled, we may capitalize only the first letter; for example, “observe there is no identification of the input Fader”.

There are 8 groups (or subgroups, depending on your linguistic preference). The group faders are known as “Group Master Faders”. Their function is to control the level on the 8 “Group Mixing Busses”.

Particularly important information is distinguished in this manual by the following notations:

### NOTE

**A NOTE provides key information to make procedures or functions clearer or easier.**

### CAUTION

**A CAUTION indicates special procedures or guidelines that must be observed to avoid damage to the console or related equipment, or to avoid an undesirable result while using the console.**

### WARNING

**A WARNING indicates special procedures or guidelines that must be observed to avoid injury to the operator or others using or exposed to the console or related equipment.**

In the “FEATURES” section of this manual, each feature is provided with a numerical reference. Elsewhere, if we are referring to that feature, we may cite the reference number in square brackets with the page number on which the description is to be found.

This is a real warning that Underwriters Laboratories says we must print:

### WARNING

**To prevent fire or shock hazard, do not expose this appliance to rain or moisture.**

## 1.2 Features

The PM3500M is a professional monitor mixing console with the kind of flexibility, performance and reliability for which Yamaha has earned a worldwide reputation. It picks up where previous monitoring consoles leave off, providing a wide range of functions and extraordinary flexibility.

The PM3500M is available in 44 or 42 input module version, both equipped with center master positions, to facilitate 2-operator working. There are 8 VCA (Voltage Controlled Amplifier) master faders used for control of any combination of input channels (see page 22 for a discussion of VCAs). There are also eight conventional mixing busses, with individual level controls on each input module, and a stereo bus, to which any channel can be assigned. There are eight monaural auxiliary busses on every input module, four of which can be switched in pairs to become stereo auxiliary busses on the stereo input modules. Auxiliary sends are all switched pre- or post-fader. These busses may be used to augment the eight groups and stereo groups, or they can be used for a variety of purposes: foldback send, effects sends and remote mixes.

Input channels can be assigned directly to the stereo bus, or through the eight group masters. The console can therefore be used in a sub-grouped mode with a “grand master” pair of stereo faders, or can be used with independent stereo and multi-channel mixes.

## 1—How to use this manual

The PM3500M is fitted with Yamaha's pioneering Mix Matrix function. On the PM3500M, this is a 12 x 12 configuration. Each matrix channel can accept any or all of the following: the stereo master busses, the eight group busses, two dedicated matrix sub inputs and a (stereo) sub input. These signals can be mixed into any or all of four stereo busses or four additional mono busses. The matrix feature allows you to create stage monitor mixes from subgroups, create different speaker mixes for different parts of the house, feed local and remote programs simultaneously, make mono and stereo mixes from the same subgroups, etc. If the matrix is set to pick up the subgroups ahead of the group master faders, the subgroups can be mixed onto the stereo bus with one mix, and a variety of completely independent mono or stereo mixes can be created from the subgroups using the matrix.

The PM3500M can handle literally any line or mic level source, thanks to differentially balanced inputs, a 30dB attenuation pad, and a continuously variable gain control with a 50dB range. When extra grounding isolation is required, optional input transformers can be fitted on a per-channel basis. Although the PM3500M has ample headroom throughout the chain, level indicators are fitted on input modules to show signal, nominal and peak levels. Summed peak LED warn of potential clip situations on each group and aux bus, as well as on the stereo bus.

In addition to the monitor-oriented audio grouping, the PM3500M incorporates a VCA grouping system. Next to each channel fader, there are eight VCA group switches which control that channel's assignment to be controlled by one or more of the VCA master faders. When more than one channel is assigned to a particular VCA bus, the output levels of these channels can be raised or lowered with one VCA fader. The significant difference between this system and conventional busses is that if signal processing of multiple inputs is required, it is necessary to run the combined signal through a signal bus (which is why the PM3500M incorporates full-length master faders). However, when VCA master faders are used, a channel's level can be altered by more than one group fader. Since the VCA group directly alters the level of a channel, it can alter the post-fader output of that channel to any of the eight conventional group busses, something unattainable with the conventional group master faders. A rear-panel multi-pin connector [107] (page 34) is provided for the purpose of controlling these voltage levels, helping automate the group levels. The VCAs are sonically improved, and all bus, VCA group, etc. assignments are made using latching switches; avoiding CMOS switching and "glue-logic".

Master muting and ON switching for input channels, VCA groups, master groups, matrix channels, and the stereo masters are memorizable and MIDI-controllable, following the lead of Yamaha's successful M2000 series. Scenes can be stored in any of 128 memories. The first eight of these memories can be recalled with a single button-press. The others can be recalled through simple front-panel operations, or from a MIDI master controller or sequencer. This gives enormous flexibility when monitoring live shows, allowing, for instance, groups of backing vocal or backing instrument microphones to be selectively muted at different points in the performance. Check LEDs together with the ON buttons allow visual previewing of scenes prior to recall, eliminating potentially embarrassing errors in scene recall.

Since the modern trend is towards fully-featured auxiliary returns, the PM3500M uses the full capabilities of the input modules for this purpose. In addition, the INSERT IN jacks on the rear panel can be used for aux return purposes, and the insert switch on each module can be used to make the signal at this input into the module's input, rather than the main channel input. This allows great flexibility without repatching.

An outstanding feature of the PM3500M is its extensive cue capability. There is a CUE switch on every input channel, and a CUE switch on every auxiliary send, the group outputs, the matrix outputs and the stereo master output. Cue replaces the signal in the headphones and the stereo cue XLR outputs with only those sources whose CUE switches are engaged.

The CUE system has input priority so that the operator may normally monitor the cue signal from the stereo bus or the group busses, and can instantly check one or more channel or aux return inputs without having to first release the bus CUE switches. This capability is great for troubleshooting, previewing a channel before applying it to the mix, or "touching up" the EQ on a channel during a performance.

The PM3500M has an excellent talkback system plus a useful test oscillator. An XLR input can be set to accept a microphone input, and is activated with the TALKBACK switch. That signal can be slated to any of the group or aux mixing busses, the two stereo mixing busses, and to a rear panel XLR TB output. The test oscillator can be set to 100 Hz, 1 kHz or 10 kHz fixed frequencies or to pink noise, and can be swept from 0.2 to twice the set frequency, and its output level is adjustable. The oscillator can be slated to the same busses as the talkback, and also has its own rear panel output connector so the signal can be routed to other equipment or other console inputs for testing.

Extensive metering is provided with a total of 14 illumi-

nated VU meters, each with a peak LED to warn of potential clipping. 12 of these meters can be switched to monitor alternate busses (group, aux and matrix busses, as well as CUE and TALKBACK busses, so the metering gives you a comprehensive view of signal levels in your system.

PM3500M electronic performance is everything you'd expect from the manufacturers who developed the PM3000 and PM4000 consoles. It is even more advanced, with lower noise levels than ever. Wide headroom throughout, exceptionally low distortion, and quiet controls are the hallmark of this top quality mixing console. The specifications are honest and conservative. The performance is audibly superb.

Physically, the PM3500M chassis design features aircraft-style bracing with the high strength necessary to sustain repeated trips on the road. A gray finish and subtly color coded controls set the backdrop for the PM3500M's hundreds of illuminated switches and indicators. Multiple rear-mounted cooling fans reduce internal temperatures to prolong component life.<sup>1</sup>

A key feature of the PM3500M is its compatibility with the PM3500 front-of-house console. Many parts, including master modules, are common to both consoles, reducing the amount of spares that it is necessary to carry on the road. In addition, the MIDI compatibility between the two consoles allows a high degree of automation in the set, meaning that one operator can mute or unmute whole sections of the program simultaneously for both the front and monitor mixes.

The highly advanced PM3500M, with its many internally switchable functions, is as close to a custom console as you can get, while retaining all the value and reliabil-

ity of an off-the-shelf Yamaha console. Like the PM4000, the PM3500M is a straightforward console to use. Anyone who has used the PM4000M monitoring console should immediately feel comfortable with the PM3500M. Take a while to study the panel, read the descriptions in this manual, and you'll find operating this console is very natural and satisfying because you can make it do the job the way you need it done.

---

1. Heat is generated by electronic components, and is the enemy of them. In some segments of the industry (such as Las Vegas showrooms), it has been customary to leave equipment switched on all the time. This tradition grew out of the days when vacuum tube equipment was prevalent, and vacuum tubes did last longer if they remained on rather than being switched. Solid state devices used in modern mixing consoles are less susceptible to damage from switching, but the heat build up sustained in continuous 24 hour operation will shorten component life. Therefore, it's a good idea to turn off your equipment when it is not in use (unless you are in a very humid environment where the heat of operation wards off corrosion-causing, short-circuit-promoting moisture condensation). While the PM3500M remains cooler than its predecessors, thanks to cooling fans, it remains a prudent practice to shut it off when it is not being used.

## **1-How to use this manual**

## 2 Features

### 2.1 Front panel features

#### 2.1.1 Monaural input module

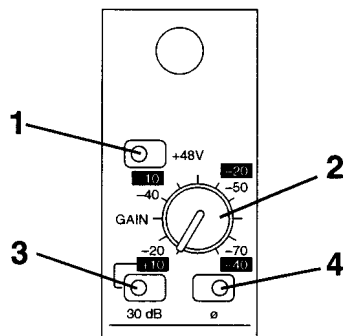

#### 1 +48V (phantom power)

This (integral LED illuminates when engaged) switch turns the phantom power (+48V) on and off at the channel's XLR input connector. The power will only be turned on, however, if the MASTER PHANTOM POWER switch [112] (page 35) is on. When the MASTER PHANTOM POWER switch and this module switch are on, +48V is applied to both pins 2 and 3 of the channel input XLR connector for remote powering of condenser microphones. Although phantom power will not harm most dynamic and other non-phantom powered microphones or line-level devices, connection of an unbalanced source to the channel input could partially short the console's phantom supply, cause undue loading, and induce hum. Therefore, it is a good practice to turn off the channel's phantom power unless it is actually in use.

#### NOTE

**The console's microphone power supply is not intended for A-B powered microphones. External supplies may be used with these devices, in which case the console's phantom power should be turned OFF on the appropriate channels. The optional input transformers, if installed, do not affect phantom power operation.**

#### 2 GAIN

This rotary knob provides 50dB of continuously variable adjustment for the input preamplifier gain. A setting of -70 (full clockwise rotation) provides maximum gain for low-level mic inputs, whereas a setting of -20 provides minimum gain for low-level line inputs or "hot" mics. These settings provide 30dB less overall gain when the 30dB pad [3] (page 11) is engaged.

#### 3 30dB (pad switch)

When this switch is engaged, (integral LED illuminates when engaged), the input signal is attenuated by 30dB. This pad should be used in conjunction with the GAIN control [2] (page 11) to obtain the precise channel sensitivity of a given source. If you are not sure whether an input is high line level or mic level, start with the PAD engaged and the GAIN control at the -20 (+10) position (fully counter-clockwise). Rotate the GAIN control clockwise, slowly. If you still don't get enough level, or the signal is still noisy with a lot of gain, turn the gain down again, disengage the pad, and reset the GAIN control as necessary.

#### NOTE

**By adjusting the GAIN control, you may be able to get the same level, whether on or not the pad is engaged. Listen for noise and distortion—if the signal is noisy, you should not use the pad, and if there is a lot of distortion, the pad should be engaged.**

#### 4 Ø (Phase)

This switch (integral LED illuminates when engaged), reverses the polarity of pins 2 and 3 on the channel's XLR connector. In normal mode (up, not illuminated), pin 2 is the signal high connector, and when engaged (down, illuminated), pin 3 is high.

This switch eliminates the need for you to rewire connectors or use adapters for out-of-phase sources. This switch can be used to reverse polarity intentionally to cancel leakage from adjacent microphones, for example, or to create electro-acoustical effects by mixing together out-of-phase signals from microphones picking up the same source.

## 2-Features

### Equalizer



The input channel equalizer is divided into four bands, each with sweepable filter frequencies. The high and low bands may be switched between peaking and shelving types, and the high-mid and low-mid bands are peaking. All bands have adjustable Q, providing fully parametric type equalization. The level (gain) is adjustable with 15dB of cut or boost in each band.

#### 5 HI (peak/shelf)

This locking switch selects peaking (switch out) or shelving (switch in) type EQ. When the switch is in (shelving mode), the Q control adjacent to this switch is not operational.

#### Q

This rotary control adjusts the Q (bandwidth) of this section of the equalizer from a very narrow (fully counterclockwise) to a very broad (fully clockwise) band, with a center detent at a Q of 1.2.

Front Panel	Q	Bandwidth (octave)
	3.0	0.5
	1.4	1.0
center position	1.2	1.2
	0.7	2.0
	0.5	2.5

#### 1k ~ 20k

The outer concentric knob sweeps the equalization frequency for this band between 1kHz and 20kHz.

#### -15 ~ +15dB

The inner concentric knob adjusts the gain of the set frequency band by  $\pm 15$ dB. The center detent position indicates unary gain.

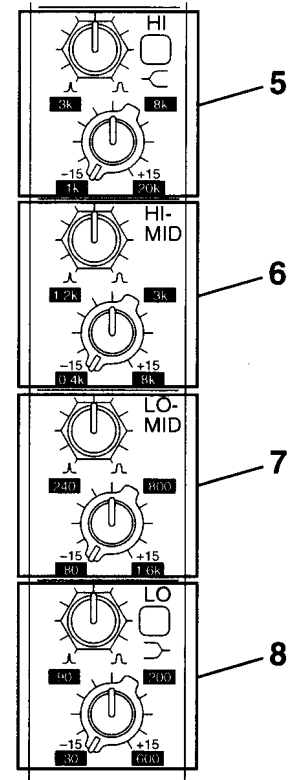

#### 6 HI-MID

#### Q

This rotary control adjusts the Q (bandwidth) of this section of the equalizer from a very narrow (fully counterclockwise) to a very broad (fully clockwise) band, with a center detent at a Q of 1.2.

#### 0.4k ~ 8k

The outer concentric knob sweeps the equalization frequency for this band between 800Hz and 8kHz.

#### -15 ~ +15dB

The inner concentric knob adjusts the gain of the set frequency band by  $\pm 15$ dB. The center detent position indicates unary gain.

#### 7 LO-MID

#### Q

This rotary control adjusts the Q (bandwidth) of this section of the equalizer from a very narrow (fully counterclockwise) to a very broad (fully clockwise) band, with a center detent at a Q of 1.2.



**80~ 1.6k**

The outer concentric knob sweeps the equalization frequency for this band between 80Hz and 1.6kHz.

**-15 ~ +15dB**

The inner concentric knob adjusts the gain of the set frequency band by  $\pm 15$ dB. The center detent position indicates unary gain.

**8 LO (peak/shelf)**

This locking switch selects peaking (switch out) or shelving (switch in) type EQ. When the switch is in (shelving mode), the Q control adjacent to this switch is not operational.

**Q**

This rotary control adjusts the Q (bandwidth) of this section of the equalizer from a very narrow (fully counterclockwise) to a very broad (fully clockwise) band, with a center detent at a Q of 1.2.1k ~ 20k

**30 ~ 600**

The outer concentric knob sweeps the equalization frequency for this band between 30Hz and 600Hz.

**-15 ~ +15dB**

The inner concentric knob adjusts the gain of the set frequency band by  $\pm 15$ dB. The center detent position indicates unary gain.

**NOTE**

There is no EQ clip indicator to show clipping induced by gain levels added in the equalization section. The CLIP indicator [15] (page 15) near the channel fader is used to show post-EQ clipping.

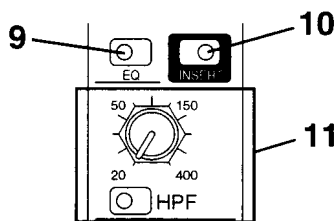
**9 EQ**

This locking switch (integral LED illuminates when engaged) activates (LED on, switch engaged) or bypasses (LED off, switch disengaged) the channel equalization section. This is useful for A-B comparison of the equalized vs. unequal-

ized signal, or, if the EQ is bypassed, maximum signal quality on pre-equalized signals.

**10 INSERT**

When this switch is engaged (integral LED illuminates when engaged), any signal present at the channel's INSERT IN jack [88] (page 31) will replace the channel signal. The INSERT OUT jack is always "live" and is unaffected by this switch. The main use of this switch is to select or deselect any processing equipment connected to the INSERT IN jack. Note that the INSERT loop's pick-off point is post-GAIN, PHASE and HPF, and EQ. The loop's signal is re-inserted post-EQ, and pre-VCA. These points can be changed using internal switches (see the section on "Optional Functions" on page 81 for details).

**11 HPF (switch and control)**

The HPF switch (integral LED illuminates when engaged) engages the channel's high-pass (low cut) filter with a slope of 12dB/octave.

The HPF control sets the cutoff frequency of the filter from 20Hz (fully counter-clockwise) to 400Hz (fully clockwise).

The HPF can be used to cut wind noise, vocal popping, stage rumble and low-frequency leakage and overspill. Use higher-frequency settings on the HPF to reduce leakage into mics which are handling high-frequency sources. The filter can also be used to protect woofers from damage caused by unneeded low-frequency components; for instance, if a microphone is dropped or kicked. Bypass the filter only if you really need the bass frequencies from a particular instrument (bass guitar, organ, bass drum, etc.).

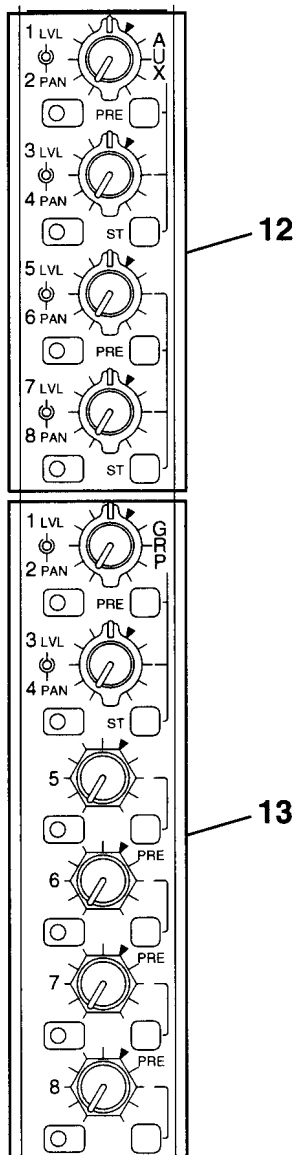

**12 AUX 1-8 (AUX ON/OFF, PRE/POST and ST switches, and level controls)**

Each monaural input channel is fitted with eight auxiliary busses. These can be assigned pre-EQ and fader (switch engaged) or post-EQ and fader (switch disengaged) with the PRE switches.

The signal can be routed to the auxiliary busses when the ON switch is engaged (integral LED il-

luminate when engaged) or can be muted when the switch is disengaged.

The level of the signal sent to the auxiliary busses is adjustable with the level controls (the inner control of each concentric pair controls the level sent to the odd-numbered AUX sends, and the outer control controls the level sent to the even-numbered AUX sends).

However, the eight AUX sends can be ganged together as stereo sends using the ST switches. The upper ST switch on each channel will gang together 2 stereo sends (AUX 1+2 and AUX 3+4) and the lower will gange together AUX 5+6 and AUX 7+8. When a pair of AUX busses has been ganged together in this way, the inner control of each concentric pair controls the level of the channel signal sent to the AUX busses, and the outer control controls the channel's placement in the stereo image of the AUX bus.

When used as level controls, these controls send a nominal signal when at about the 1 o'clock position (marked).

When in the PRE switch is set to the pre-position, the signal will be sent pre-fader and post-EQ. This can be reset to pre-fader and pre-EQ by means of an internal switch. See the section on "Optional Functions" on page 81 for details.

**CAUTION**

Since the PM3500M does not use dedicated auxiliary returns, input modules should be used for this purpose. It is important that any module used for this purpose does not feed the auxiliary bus whose output is feeding this module. If this is done, feedback will occur, which can damage speakers and circuits in your system. If, for instance, a reverb unit is attached to Aux bus 1, and the return is fed back into channel 24, the AUX 1 ON switch of channel 24 should be left off to avoid feeding the reverb output back into the signal processor.

**13 GROUP send ON/OFF and PRE switches and level controls**

In many ways, these controls may be regarded as the heart of the PM3500M. They control the routing and level of the channels to the eight mixing groups.

The first four groups may be grouped into two pairs (1+2 and 3+4) by the use of the ST switch (the same switch controls the grouping of 1+2 and 3+4).



When the ST switch is engaged, the inner control of each concentric pair regulates the level sent to the odd-numbered groups, and the outer control regulates the placement of the channel signal in the stereo image of the group pair.

When the ST switch is not engaged, the inner control of each concentric pair controls the level sent to the odd-numbered groups, and the outer control controls the level sent to the even-numbered groups.

For the remaining four groups, a single control regulates the level sent to each group.

When used as level controls, these controls send a nominal signal when at about the 1 o'clock position (marked).

Each pair of groups (1+2 and 3+4) and each individual group is equipped with an ON switch (illuminates when engaged). This can be used to mute the input from the channel to the group quickly when required.

Each pair of groups (1+2 and 3+4) and each individual group is also equipped with a PRE switch which allows group levels to be adjusted pre-rather than post-fader.

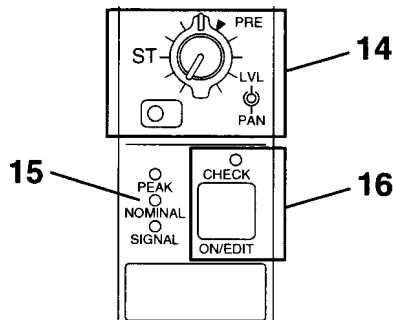

**14 ST (stereo) controls**

The concentric rotary control controls both the level (inner) and the pan position in the stereo image (outer) of the channel signal sent to the stereo bus.

An ON switch (illuminates when engaged) controls whether the channel is routed to the stereo bus or not.

**NOTE**

The stereo bus does not have a pre/post selector switch on each channel. Stereo routing is therefore invariably carried out post-fader.

**15 PEAK, NOMINAL and SIGNAL indicators**

These indicators are used to give an instant reference on the signal levels entering the input channel. The pick-off point is post-phase and pre-HPF. In effect, they can be regarded as a three-element bargraph meter, and they turn on at the following levels:

PEAK	3dB below clip
NOMINAL	nominal level
SIGNAL	20dB below nominal

**16 ON/EDIT switch and CHECK indicator**

The ON/EDIT switch illuminates when active. When on, the channel's input is routed to the appropriate master group busses as determined by the group controls [13] (page 14), the stereo bus [14] (page 15) and any auxiliary busses.

The switch can also be used to edit the configuration of "scenes" prior to storing them into one of the 128 memories available (see "Pre-setting scenes in CHECK mode" on page 54).

The green CHECK LED becomes operational when the PM3500M is in CHECK mode (see "Pre-setting scenes in CHECK mode" on page 54) to verify the status of a channel prior to recalling a scene.

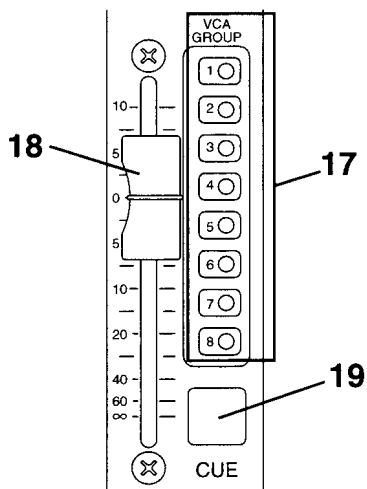

### 17 VCA GROUP (1 through 8)

When any of these switches (integral LEDs illuminate when engaged), the corresponding VCA group master fader(s) will also control the output level of the channel. A channel may be assigned to more than one VCA master group.

#### CAUTION

**If you assign (or deassign) an input channel to a VCA group during a performance, the channel level will jump up or down, unless the VCA fader is set precisely to the nominal level.**

### 18 Fader

The fader sets the level applied from the channel to the eight group mixing busses and the stereo bus. If any auxiliary sends [12] (page 14) are set to post-fader, it will control these levels as well. Unlike most other consoles, the fader does not pass audio signals, but controls a VCA through which the audio is passed. Accordingly, the channel level may be controlled from the eight VCA master faders or the VCA control connector [107] (page 34), if any of the VCA GROUP switches have been engaged.

### 19 CUE

The exact function of this (electronically-latching) switch on each input channel depends on the setting of the Master SOLO MODE switch [20] (page 18).

If the console is set to SOLO mode, pressing this switch mutes all other input channels, and only those channels whose CUE switch is engaged will feed the console outputs ("solo in place").

If the console is set to CUE mode (SOLO off), the console then has a triple-priority cue system, designed to give the engineer maximum control and speed when it is most important. Pressing any channel CUE switch causes the channel signal to replace any master or VCA cue signal in the MONITOR A outputs and MONITOR B (if MONI A is selected) outputs and the phones outputs.

### Cue groups and cue priority

In addition to the channel CUE, the VCA groups can also be cued by pressing their CUE switches. The engineer can also easily select any of the 25 output mixes (Groups 1 through 8, Stereo, Matrix 1 through 8, and AUX sends 1 through 8) by pressing the corresponding CUE switches. These three groups of cue signals form the three *cue groups*: INPUT, VCA and MASTER. These three groups are exclusive, i.e. cue sources from only one group at a time can be selected. The currently-monitored cue group is shown on the CUE GROUP indicators [81] (page 29).

Once a cue source from another cue group has been selected, the current cue group will be changed to the group containing the last-selected cue source. For example, if the engineer is cueing the stereo outputs, the MASTER indicator will be lit. Pressing any input channel's CUE switch will change the indicator to INPUT and will stop the CUE signal from the stereo bus. If other channels' CUE switches are pressed, their signals will be added to the cue bus. If all INPUT CUE switches are released, the cue buss will once again be fed by the stereo (MASTER) bus.

In most cases, once the individual output mixes have been established, the engineer will want to listen to the "most important output mix" during the performance: a stereo bus mix of various subgroups, possibly the main house feed or the vocal subgroups. However, should feedback occur, or should any other condition require attention, the PM3500M enables the engineer to check any input channel(s) or VCA group(s) instantly by pressing the CUE switch(es). The input (or VCA group) whose CUE switch is engaged then automatically replaces the selected output mix in the headphone and cue outputs. The engineer can make the necessary adjustments, and then return to monitoring the original output mix simply by

unlatching the input channel or VCA group CUE switch.

Pressing the channel CUE switch will lock it down (electronically – this is not a mechanically locking switch). The LED in the switch is illuminated when the channel is cued. Although the cue signal is not affected by the fader or ON/OFF switch, it is affected by the Input PAD, GAIN control, Filter, channel EQ, and anything connected between the channel's INSERT IN and OUT jacks (if the INSERT switch is engaged).

**NOTE**

---

**Since the console operator may normally be listening one or more group busses by means of engaging their CUE switches, the PM3550M cue signal(s) will automatically change to the input cue group as soon as the CUE switch of one or more channels is engaged. The cue signals will revert to their previous state (MASTER or VCA) as soon as all channel CUE switches are released.**

---

### 2.1.2 Control module

This module contains the soloing and master cue controls as well as the controls necessary for scene storage and recall. For a full discussion of the use of these controls, consult "MIDI scenes" on page 53.

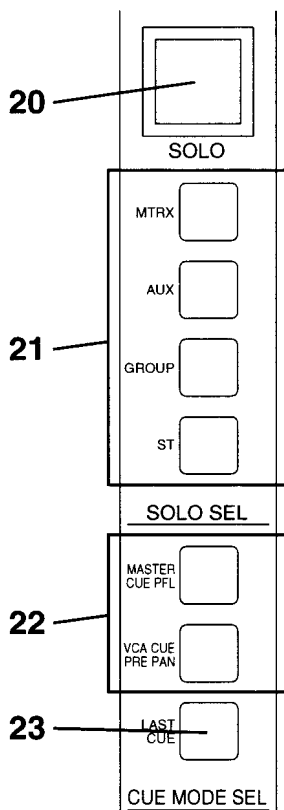

#### Solo section

This section allows the master control of soloing functions.

#### 20 SOLO switch

This switch changes the function of the console's CUE switches between CUE and SOLO. When in CUE mode, CUE switches are added to the signal appearing in the phones jacks. When in SOLO mode, pressing a CUE switch will mute all other channels (similar to the SOLO function on a recording console) and this red switch flashes, to remind you that SOLO rather than CUE mode has been selected. This, while invaluable in a pre-performance setup session, is obviously highly undesirable in a live performance. For this reason, this switch is located under a hinged, lift-up cover to prevent accidental operation during a performance. Software protection is also provided

to prevent accidental activation of this switch (page 56).

#### CAUTION

**Before the beginning of a performance, always make sure that this switch is OFF (CUE mode selected). Otherwise, pressing any CUE switch will mute all other channels.**

#### 21 SOLO SEL – MTRX, AUX, GROUP, ST (solo select switches)

These switches (integral LEDs illuminate when engaged) allow the matrix, AUX sends, master groups or the stereo bus to be soloed. These switches are only effective when the console is in SOLO mode.

If one of these switches is pressed (say the AUX switch) then the signal of any AUX send whose CUE switch is pressed will be soloed (the ON switch will also change together with the CUE switch status). The MTRX, GROUP and ST switches work similarly for matrix, master group and the stereo busses.

#### 22 CUE MODE SEL– MASTER CUE PFL, VCA CUE PRE PAN, (cue mode selector switches)

These switches (illuminated when engaged) allow the selection of different cue modes when the console is in CUE or SOLO mode.

Pressing MASTER CUE PFL means that any master channels (i.e. busses which are not input groups or VCA master groups) which are cued will appear pre-fader. Usually, when this switch is not engaged, these will be cued post-fader.

If VCA CUE PRE PAN is selected, VCA master groups will be cued from a point which is post-VCA fader, but pre-pan (the cueing will not be in place). VCA groups are usually cued post-pan (in place) when this switch is not engaged.

#### 23 LAST CUE

This switch, when engaged, will turn off all CUE switches. If any CUE switches are subsequently engaged, this CUE signal will replace the current CUE signal. Any further CUE switches pressed will replace the current CUE signal with the CUE signal of the last channel or bus whose CUE switch has been pressed.

Turning this LAST CUE switch off will turn off all currently-engaged CUE switches.

## Scene memory controls

A brief guide to the functions of these controls. For full details of how to use the scene memories, consult "MIDI scenes" on page 53.

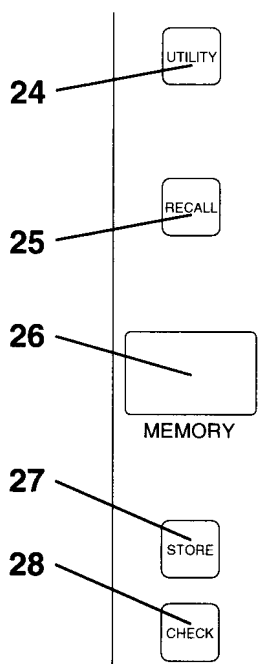

### 24 UTILITY key

This key (illuminates when engaged), allows access to a number of scene and console utilities. Repeated pushes of this switch will cycle through the following utility modes (see "UTILITY mode" on page 55):

Display shows	Meaning
BATT	Battery level check
M-PR	Memory protect on or off
S-PR	Solo protect on or off
STCU	Stereo cueing for AUX and GROUP pairs
INIT	Memory initialization
M-CH	MIDI channel for reception and transmission
PGM	Enable/disable MIDI Program Change transmission and reception
CTRL	Enable/disable MIDI Control Change transmission and reception
OMNI	Disables OMNI mode for MIDI Program Change

Display shows	Meaning
ECHO	Enables/disables MIDI echo back
BULK	Initiates a MIDI Bulk Dump from the PM3500M
RQST	Prepares the PM3500M for a MIDI Bulk Dump from a remote MIDI device
	OFF - the UTILITY switch goes off, and the PM3500M is no longer in UTILITY mode

If the console is in a utility mode, and the UTILITY key is pressed and held down for a second, then released, the console will exit utility mode.

### 25 RECALL key

This key is used to recall and activate the scene memory whose number is currently shown in the display.

### 26 MEMORY display

This 4-digit dot-matrix LED display usually shows the currently-selected scene memory. It is also used to display the current UTILITY [24] (page 19) mode, and if a utility is being accessed, shows the parameters for that utility.

### 27 STORE key

This key is used to store the current channel ON settings into the memory whose number is currently shown on the display.

This key is also used to confirm some settings in UTILITY mode.

### 28 CHECK key

This puts the console into CHECK mode, which allows previewing of scene memories using the CHECK LEDs on each channel prior to recall.

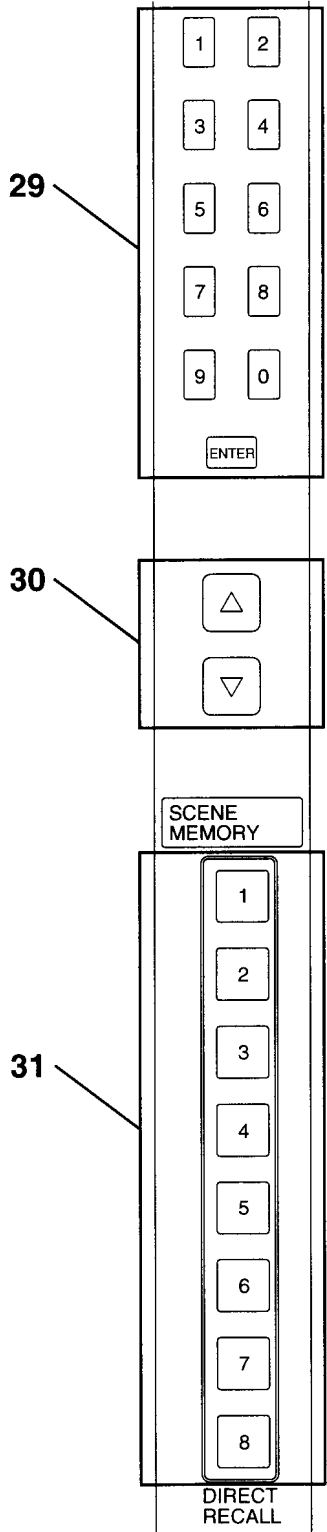

**29 Number keys and ENTER**

These keys are used for direct input of scene memory numbers when this will be faster than using the up and down keys.

**30 UP/DOWN keys**

Used to step values up and down by one when entering data.

**31 DIRECT RECALL**

Scene memories 1 through 8 may be recalled directly without having to enter them through the number keypad or UP/DOWN keys and RECALL key. This allows the most commonly-used scene memories to be accessed with the minimum of trouble.

### 2.1.3 Group master modules

These modules are identical, except that the first four (group master modules 1) have stereo matrix grouping, and the other four (group master modules 2) have monaural matrix grouping. Additionally, the first four incorporate the master AUX send sections, and four include the Master Group sections.

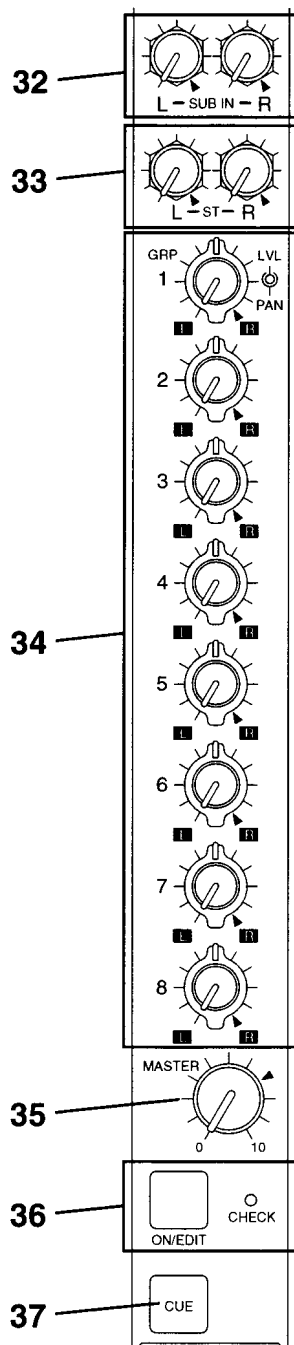

### Matrix section (modules 1 through 4)

#### 32 SUB IN L and R

These adjust the level of the signal from the MATRIX SUB IN connectors fed to the matrix group.

#### 33 ST L and R

These adjust the level of the L and R signals from the STEREO bus fed to the matrix group.

#### 34 1 through 8 LVL (level) and PAN controls

These are concentric controls which adjust the level of the signal from the Master Groups fed to the stereo matrix group, and its placement within the matrix group's stereo image.

The outer center-detented control adjusts the master group's position in the matrix group's stereo image, and the inner adjusts the level. Nominal level is shown by a mark at the fully clockwise position.

As shipped, the group levels are routed post-fader to the matrix, but this can be changed by means of internal switches. Consult the OPTIONAL FUNCTIONS section for details.

#### 35 MASTER control

This control regulates the level of the signal output by the matrix group to the appropriate connector on the rear panel. The control is labeled from 0 to 10, with a mark at approximately the "7" position to indicate the nominal level.

#### 36 ON/EDIT key and CHECK indicator

These work in the same way as the individual input module controls [16] (page 15). For a full explanation of how to use these, see "MIDI scenes" on page 53.

#### 37 CUE (matrix cue)

When this switch is illuminated, the matrix mix signal (post-MASTER [35] (page 21)) from this matrix channel is added to any other master cue group signals, or replaces the existing cue signal if this belongs to a different group (VCA or INPUT). For these stereo matrix mix groups, cueing will be in place (the stereo image of the group will be preserved).



## 2-Features

### AUX sends

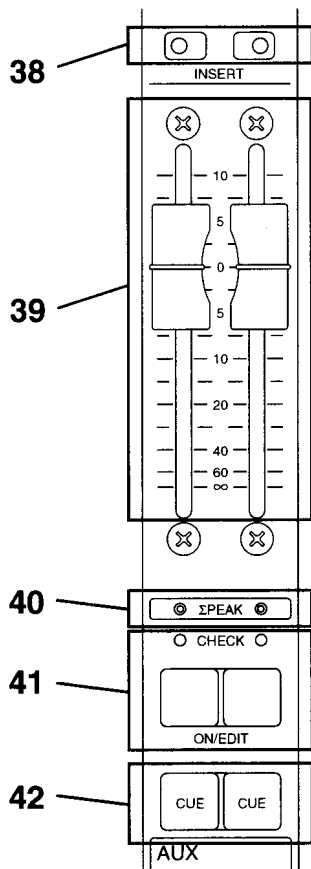

#### 38 INSERT (AUX send insert switches)

These switches (integral LED illuminates when engaged) replace the internal group signal with the signal present at the AUX INSERT IN jack. The AUX INSERT OUT jack is always "live" and is unaffected by this switch. The main use of this switch is to select or deselect any processing equipment connected to the appropriate INSERT IN jack. Note that the insert signal is inserted pre-fader. This point can be changed using internal switches (see "Optional functions" on page 81).

#### 39 AUX send faders

The eight 60mm AUX send faders are grouped in pairs on four modules. This facilitates matching left and right AUX send levels when sending to an external stereo effects processor. Nominal level is at 0.

#### 40 Σ PEAK indicators

These indicators will illuminate if the pre-fader level of an AUX send bus reaches 3dB below the clipping level.

#### 41 ON/EDIT keys and CHECK indicators

These work in the same way as the individual input module controls [16] (page 15). For a full explanation of how to use these, see page 53.

#### 42 CUE (AUX send cue)

When this switch is illuminated, the AUX send signal (post-fader) from this channel is added to any other master cue group signals, or replaces the existing cue signal if this belongs to a different group (VCA or INPUT).

### VCA group section

As mentioned earlier (page 8), the PM3500M incorporate VCA grouping. These groups are in addition to the normal groups provided on most consoles, and give yet another degree of flexibility in the way that you work.

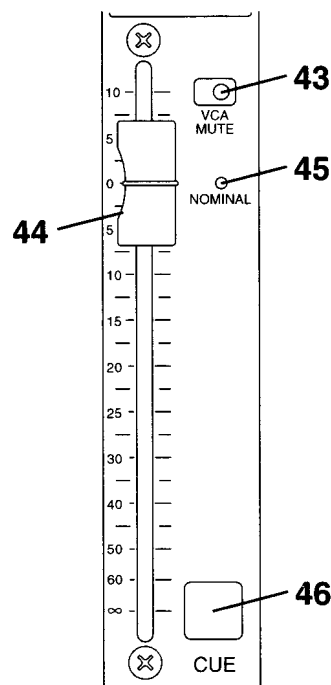

#### 43 VCA MUTE

Engaging this switch is the equivalent of setting the VCA master fader at maximum kill. The switch is illuminated when the master fader is muted. This affects all input channels assigned to



the correspondingly numbered VCA group. The switch enables you to preset a VCA group level, then mute that group until the appropriate cue.

### NOTE

This is not the same as a MASTER MUTE function because mute groups affect all outputs from assigned input channels, whereas this affects only post-fader channel outputs. Since the VCAs have a cumulative effect, a given channel's post-fader output is muted when *any* VCA group to which it is assigned is muted. On the PM3500M, the scene memories can be used to provide a MASTER MUTING function.

#### 44 VCA MASTER fader

This fader applies a DC control voltage to any input channels whose correspondingly numbered VCA group assign switch [17] (page 16) is engaged. Raising or lowering this fader will raise or lower the post-input fader output level from those assigned input modules. The end result can be similar to using a group master fader, except that audio is not going through this fader. Because the VCA master is controlling the level of each assigned input channel, it affects any of the available post-fader Group bus sends and the stereo bus send. See the NOMINAL Indicator [45] (page 23) and the note below it.

#### 45 NOMINAL Indicator

This indicator turns ON when the adjacent VCA master fader is set to a point that will not affect the level of any inputs assigned to it. See note below.

#### 46 VCA CUE switch

When this switch is engaged (illuminated), the VCA group signal from this channel is added to any other VCA cue group signals, or replaces the existing cue signal if this belongs to a different group (MASTER or INPUT).

### NOTE

VCA master faders apply DC voltage to one or more assigned input channels. The voltage applied to the VCA (voltage controlled amplifier) in a given input module will be the sum of the voltages from that module's channel fader, plus any assigned VCA master faders. The higher the voltage, the greater the gain through the channel. VCA gain structure is

calculated so that when a VCA master fader is set so its NOMINAL LED is on, then that fader has no effect on any input channel levels. The VCA master faders should be set to NOMINAL position when not in use so that, if an input is subsequently assigned to a VCA, there will be no sudden change in level due to an added (or subtracted) control voltage.

#### Some additional VCA details

If a channel fader is set at 0dB, and it is assigned to a VCA master that is set at -10dB, then the channel level will be -10dB ( $0 + (-10) = -10$ ).

If the channel fader is set at -10dB, and is assigned to two VCA masters, each set at -10dB, then the channel level will be -30dB ( $-10 + (-10) + (-10) = -30$ ).

If the channel fader is set at +10dB, and is assigned to two VCA masters, one of which is set at +10dB, and the other at -20dB, then the channel level will be 0dB ( $+10 + (+10) + (-20) = 0$ ).

When an input fader or an assigned VCA master fader is pulled all the way down to "infinite" attenuation position, the voltage is sensed in the input module, and the channel on/off relay opens to completely kill the output from the VCA. The channel ON lamp will remain active, however, indicating that any pre-fader channel outputs are still "live."

If the console is set to the "SLAVE" rather than the "MASTER" mode with the rear-panel VCA SLAVE/MASTER switch [107] (page 34), then the console's affected VCA MASTER faders (1 through 4 and/or 5 through  $\pm 8$ ) will have no effect. Instead, any DC control signals applied to the VCA/MUTE CONTROL connector [107] (page 34) will affect correspondingly assigned input channels.

## 2-Features

### 2.1.4 Group master modules 2

These group master modules differ from modules 1 through 4 in that the matrix groups are monaural and that the master groups, rather than the AUX sends, are contained in these groups. Controls for two master groups are provided on each module. The different controls and features are described below:

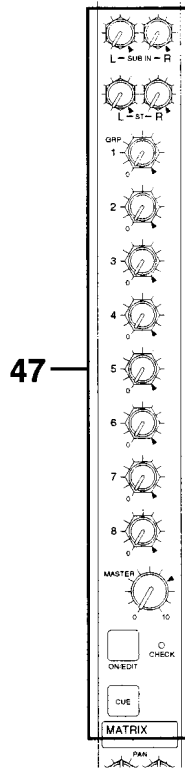

### 47 Matrix level controls

These matrix groups (5 through 8) differ from matrix group level controls 1 through 4 [34] (page 21) in that these are monaural. Accordingly, these are single controls. Nominal level is indicated by a mark at the fully clockwise position.

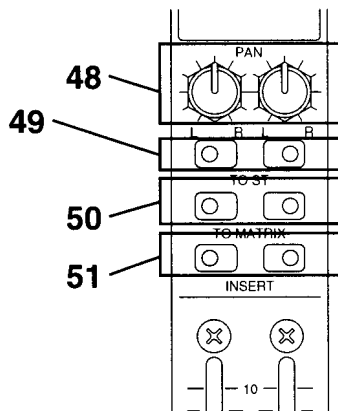

### 48 Main channel group STEREO panpots

When groups are assigned to the stereo bus using the TO ST switches [49] (page 24), these center-detented pots determine the group signal's position in the stereo image.

### 49 TO ST (to STereo) switches

The locking TO ST (integral LED illuminates when engaged) switches route the group signal to the stereo bus when engaged.

### 50 TO MATRIX switches

The locking TO MATRIX (integral LED illuminates when engaged) switches route the group signal to the matrix busses when engaged. When these switches are disengaged, they act as "mute to matrix" switches.

### 51 INSERT (group insert switches)

These switches (integral LED illuminates when engaged) replace the internal group signal with the signal present at the GROUP INSERT IN jacks. The GROUP INSERT OUT jack is always "live" and is unaffected by this switch. The main use of this switch is to select or deselect any processing equipment connected to the appropriate INSERT IN jack. Note that the insert signal is inserted pre-fader. This point can be changed using internal switches (see the section on "Optional Functions" on page 75 for details).

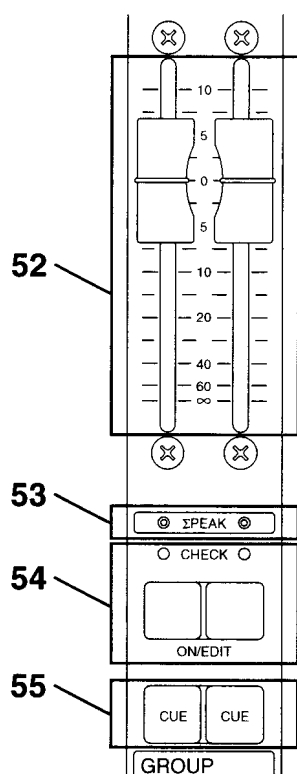

## 52 GROUP faders

The eight 60mm GROUP faders are grouped in pairs on four modules. This facilitates matching left and right group levels when working in stereo pairs. Nominal level is at 0.

## 53 Σ PEAK indicators

These indicators will illuminate if the pre-fader level of a group bus reaches 3dB below the clipping level.

## 54 ON/EDIT keys and CHECK indicators

These work in the same way as the individual input module controls [16] (page 15). For a full explanation of how to use these, see the section on "MIDI scenes" on page 53.

## 55 CUE (group cue)

When this switch is illuminated, the group signal (post-fader) from this group is added to any other master cue group signals, or replaces the existing cue signal if this belongs to a different group (VCA or INPUT).

The VCA controls on these four modules are identical to those described above: [43] (page 22) through [45] (page 23).

## 2.1.5 Stereo master module

This module provides the controls and routing for talkback and the integral line-up oscillator as well as the stereo output controls.

### Talkback and oscillator section

This section includes the oscillator and talkback routing and selection controls, as well as the talkback input connector and switch.

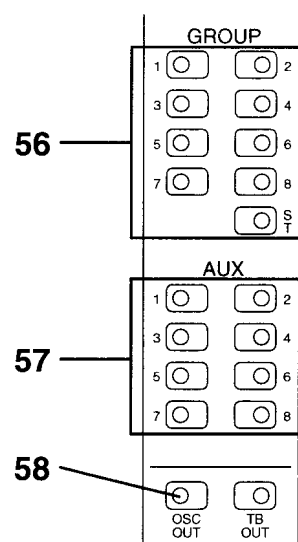

## 56 GROUP and ST (talkback to group and stereo routing switches)

These nine switches (integral LEDs illuminate when engaged) route the talkback signal to the appropriate group bus(es) and/or to the stereo bus.

## 57 AUX (talkback to AUX routing switches)

These eight switches (integral LEDs illuminate when engaged) route the talkback signal to the appropriate AUX sends.

## 58 OSC OUT (oscillator output)

The PM3500M incorporates a dedicated oscillator output [106] (page 34). This switch (integral LED illuminates when engaged) turns the signal from this connector on and off. It does not turn the oscillator on or off.

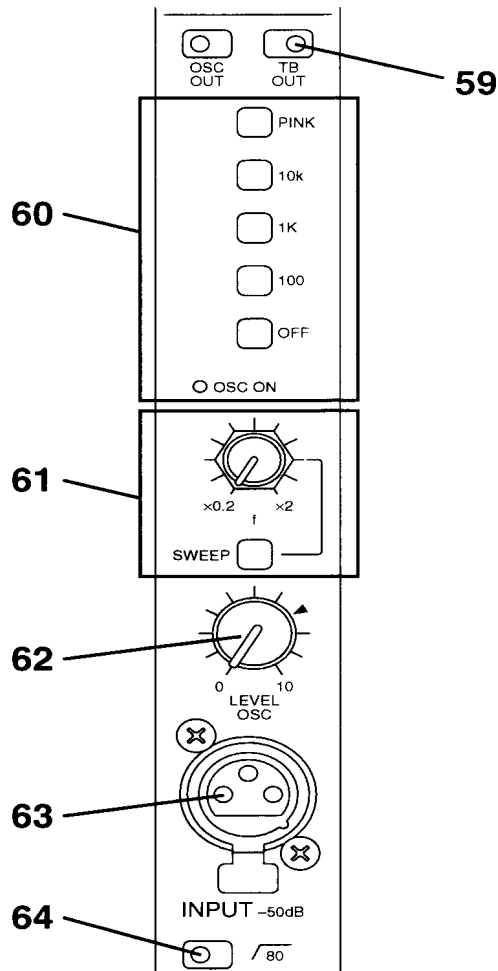

### 59 TB OUT (talkback output)

The PM3500M incorporates a dedicated talkback output [105] (page 34) which is used for direct output of the signal from the TALKBACK input and/or the internal oscillator. This switch (integral LED illuminates when engaged) turns the signal from this connector on and off when the talkback switch [66] (page 27) is engaged. It does not turn the oscillator or talkback signal on or off.

### 60 PINK, 10k, 1k, 100, OFF and OSC ON (oscillator switches and indicator)

These 5 interlocking switches set the sine-wave oscillator to 100Hz, 1kHz or 10kHz operation when the SWEEP switch [61] (page 26) is in fixed frequency position (disengaged). They also per-

mit selection of a pink noise source, or turn off the oscillator/noise source altogether.

The red OSC ON indicator shows the on/off status of the oscillator (illuminated in any switch setting other than OFF).

### NOTE

Even though the oscillator may not be assigned to any busses, it is still possible that it could be inadvertently selected when preparing to use the talkback feature, or that some signal could leak into busses (albeit at low levels). Hence, leave the oscillator OFF when it is not actually being used for testing or calibration.

### 61 SWEEP (oscillator sweep control and switch)

Engaging the SWEEP switch removes the oscillator from its fixed frequency mode (i.e., generating exactly 100Hz, 1kHz or 10kHz). The nearby rotary control then may be used to adjust the oscillator output from approximately 0.2 to 2 times the set "fixed" frequency. For example, when the oscillator is set for 10kHz, and sweep mode is engaged, you can adjust the actual oscillator frequency between 2kHz and 20kHz.

### 62 LEVEL OSC (oscillator level)

This rotary control adjusts the oscillator output level fed to the OSC OUT, TALKBACK OUT connector, and any mixing busses to which the signal may be assigned. This control does not affect the Talkback level. A nominal level is marked at approximately the "7" value (the scale is from "0" to "10").

### 63 INPUT -50dB (talkback input)

This XLR-3 connector accepts a low-Z microphone. A gooseneck or headset microphone can be used here. The signal from this input is assigned to the TB OUT connector and to the various mixing busses by means of the assignment switches in the upper portion of this module [56] (page 25), [57] (page 25) and [59] (page 26).

### 64 /80 (80Hz bass roll-off talkback filter)

This switch (integral LED illuminates when engaged) turns on a 80Hz high-pass filter which affects the signal input at the talkback input [63] (page 26). This can be used to eliminate microphone "pop" etc. when talking back to performers.

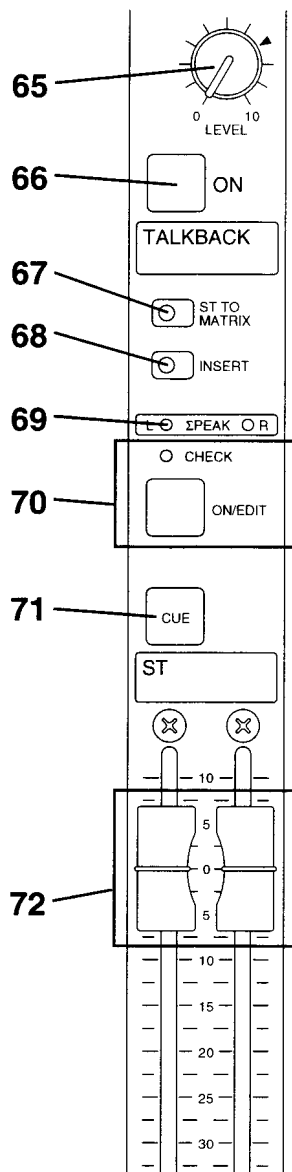

**65 LEVEL (TB Input)**

This rotary control adjusts the signal level after the talkback preamplifier, thereby affecting the sensitivity of the TB input. This control affects the TB level applied to any busses and to the TB OUT connector; it does not affect the oscillator level.

**66 ON (Talkback ON switch)**

This is a latching switch which illuminates when active. When active, signals from the oscillator [60] (page 26) and the talkback input [63] (page

26) are routed through any selected group busses and the TALKBACK OUT output if selected. Also when this signal is active, the signal from the MONITOR B outputs is muted and the signal from the MONITOR A outputs is dimmed by 10dB.

**Stereo section**

This section contains the controls for the assignment and control of the stereo bus.

**67 ST TO MATRIX (stereo to matrix switch)**

This switch (integral LED illuminates when engaged) allows the L and R stereo signals to be routed through to the matrix groups. When disengaged, the ST L and R [33] (page 21) controls in the matrix section have no effect.

**68 INSERT (stereo insert)**

This switch (integral LED illuminates when engaged) replace the stereo signal with the signal present at the STEREO INSERT IN jacks. The STEREO INSERT OUT jack is always "live" and is unaffected by this switch. The main use of this switch is to select or deselect any processing equipment (equalizer, compressor, etc.) connected to the INSERT IN jack. Note that the insert signal is inserted pre-fader. This point can be changed using internal switches (see the section on "Optional Functions" on page 81 for details).

**69 Σ PEAK L and R indicators**

These indicators will illuminate if the pre-fader level of either the left or right stereo bus reaches 3dB below the clipping level.

**70 ON/EDIT key and CHECK indicator**

These work in the same way as the individual input module controls [16] (page 15). For a full explanation of how to use these, see the section on "MIDI scenes" on page 53.

**71 CUE (stereo cue)**

When this switch is illuminated, the stereo signal (post-fader) is added to any other master cue group signals, or replaces the existing cue signal if this belongs to a different group (VCA or INPUT).

**72 Faders (stereo faders)**

These long-throw faders adjust the level of the signal from the stereo buss to the ST OUT jacks.

## 2-Features

### 2.1.6 Monitor module

This module contains the switches and controls necessary for monitoring. There are two separate stereo monitor busses (A and B).

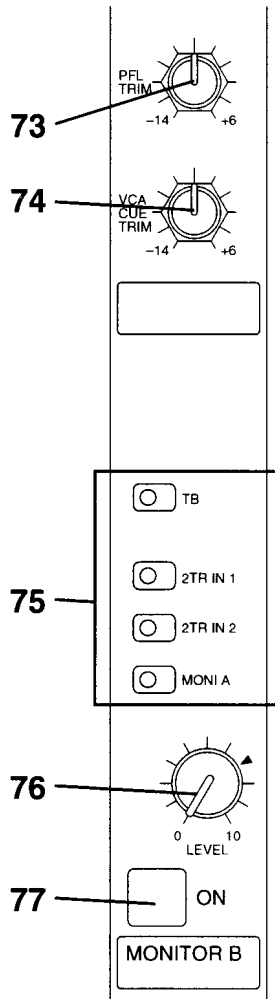

#### 73 PFL TRIM

This control allows the adjustment of the PFL bus signal over a 20dB range (from -14dB to +6dB) prior to being output from the MONITOR A connectors and the phones jacks.

#### 74 VCA CUE TRIM

This control allows the adjustment of the VCA cue bus signal over a 20dB range (from -14dB to +6dB) prior to being output from the MONITOR A connectors and the phones jacks.

### MONITOR B

This section drives a pair of connectors [99] (page 33) for feeding a power amplifier/speaker system, etc. There are four different sources which can be selected for monitoring through these connectors.

#### 75 TB, 2TR IN 1, 2 TR IN 2, MONI A (monitor B selector switches)

These switches (TB is independent of the others, which are interlocked) with integral LED indicators determine the signal which will be output from the MONITOR B connectors: talkback (TB), one of two line level stereo sources attached to the TAPE IN jacks (2 TR IN 1 and 2 TR IN 2) and a copy of whatever is selected for monitoring through the MONITOR A connectors (MONI A).

#### 76 LEVEL (MONITOR B level control)

This rotary control marked from 0 (fully counter-clockwise) to 10 (fully clockwise) controls the level of the signal output from the MONITOR B connectors. A nominal level setting is marked at about the "7" position.

#### 77 ON (MONITOR B switch)

This switch (illuminates when engaged) feeds (engaged) or mutes (disengaged) the signal output from the MONITOR B connectors.



### MONITOR A

This section drives a pair of connectors [99] (page 33) for feeding a power amplifier/speaker system, etc. There are four different sources which can be selected for monitoring through these connectors.

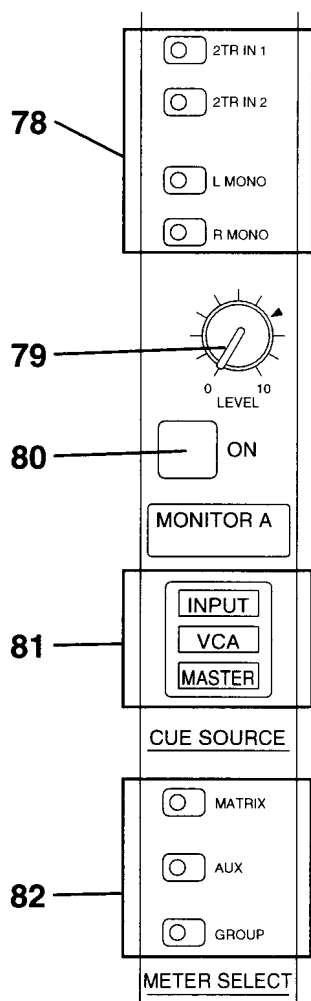

#### 78 2TR IN 1, 2 TR IN 2, L MONO, R MONO (monitor A selector switches)

These switches with integral LED indicators determine the signal which will be output from the MONITOR A connectors: one of two line level stereo sources attached to the TAPE IN jacks (2 TR IN 1 and 2 TR IN 2), the left channel of the stereo bus (L MONO) and the right channel of the stereo bus (R MONO). Only one tape input at a time can be monitored on the monitor A, but ei-

ther tape can be used together with one or both of the MONO busses.

#### 79 LEVEL (MONITOR A level control)

This rotary control marked from 0 (fully counter-clockwise) to 10 (fully clockwise) controls the level of the signal output from the MONITOR A connectors. A nominal level setting is marked at about the "7" position.

#### 80 ON (MONITOR A switch)

This switch (illuminates when engaged) feeds (engaged) or mutes (disengaged) the signal output from the MONITOR A connectors.

#### 81 INPUT, VCA, MASTER (cue source indicators)

These indicators give a useful instant indication of the source currently being monitored through the phones and MONITOR A outputs. If a channel input source is being cued, the red INPUT indicator will light. If a VCA group has been selected for cueing, the yellow VCA indicator will light. If a master source has been selected, the green MASTER indicator will light.

#### 82 MATRIX, AUX, GROUP (meter selection switches)

These three interlocking switches with integral LED indicators select the meter functions on the meter bridge. The two larger meters always show the levels of the stereo L and R busses, regardless of these switches. The assignment of the other meters in the three different modes is as follows:

Meter #	MATRIX	AUX	GROUP
1	MATRIX 1 L	AUX 1	GROUP 1
2	MATRIX 1 R	AUX 2	GROUP 2
3	MATRIX 2 L	AUX 3	GROUP 3
4	MATRIX 2 R	AUX 4	GROUP 4
5	MATRIX 3 L	AUX 5	GROUP 5
6	MATRIX 3 R	AUX 6	GROUP 6
7	MATRIX 4 L	AUX 7	GROUP 7
8	MATRIX 4 R	AUX 8	GROUP 8
9	MATRIX 5	CUE L	CUE L
10	MATRIX 6	CUE R	CUE R
11	MATRIX 7	TB OUT	TB OUT
12	MATRIX 8	OSC OUT	OSC OUT

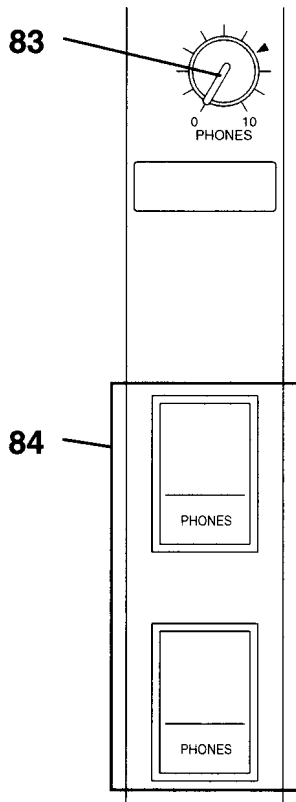

### 83 PHONES (headphone level control)

This rotary control, marked from "0" to "10", adjusts the level of the signal fed to the headphones connectors. Nominal level is indicated at about the "7" position.

### 84 PHONES connectors

Two stereo phones connectors are provided, for use with almost any 8Ω or higher impedance stereo headphones. This enables two operators (or an engineer and producer) to work on the PM3500M simultaneously. The jacks are recessed behind spring-loaded covers to exclude dust, etc. when not in use. Both jacks are angled to minimize strain on cables and connectors.

### 2.1.7 Meter bridge

The PM3500M is equipped with 2 jumbo and 12 large illuminated VU meters, all with true VU ballistics to indicate approximate loudness. In addition, each meter is equipped with a peak LED to warn of impending clipping. These LEDs turn on 3dB below the clip point. Assuming the meter is monitoring a signal with a

+24dBm maximum output capability, the peak LED will turn on when the instantaneous level reaches +21dBm. Since the standard VU scale only goes to +3 VU (corresponding roughly to +7dBm with a steady-state signal), the peak LED will turn on when the level is about 14dB above the maximum meter scale. Bear in mind, however, that the meter needle may not respond to a brief transient which can cause the peak LED to flash. A percussive signal, for instance, can cause the peak level to be 20dB to 30dB above the average level.

Other than the two jumbo meters, which always indicate the stereo left and right channel signals, the meters can be switched to indicate a variety of signals using the METER SELECT switches [82] (page 29). Colored illuminated indicators on the meter bridge show what meter mode is currently selected.

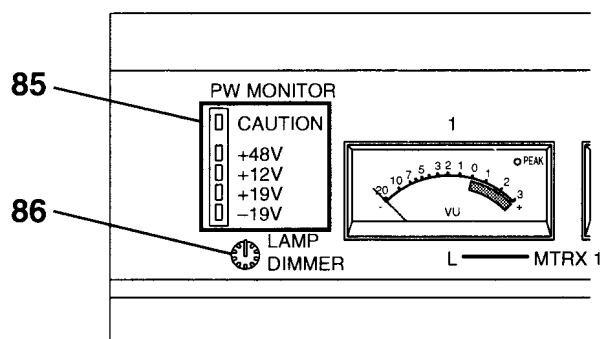

### 85 PW CAUTION, +48, +12, +19, -19 (power supply indicators)

These LEDs show the status of the remote power supply. The +48, +12, +19 and -19 LEDs should normally be on, showing that the corresponding voltages are being delivered to the console. If there is a fault and one of these voltages is low or dead, the PW CAUTION LED will flash to alert you of this situation.

### 86 Lamp dimmer

This rotary dimmer turns any lamps attached to the rear-panel lamp sockets from off (fully counter-clockwise, clicks off), to full intensity (fully clockwise). As supplied, the console Litt-Lites are fitted with standard incandescent bulbs, but the hoods and the power supply can accommodate higher intensity quartz bulbs.



## 2.2 PM3500M rear panel features

### Some points to note:

All XLR and phone jacks on the PM3500M are balanced, unless otherwise explicitly stated.

All outputs and patch points are at the +4dBu level, unless explicitly stated otherwise.

Channel inputs, sub inputs, sub outputs and primary outputs use XLR-3 type connectors, wired as follows:

Pin no.	Connection
1	Ground
2	+ (hot)
3	- (cold)

Note the male and female polarities of these connectors on the PM3500M; male connectors are generally used as outputs, and female as inputs. This can assist you in remembering the direction of signal flow.

INSERT IN/OUT points are 1/4" tip-ring-sleeve connectors, wired as follows:

Pin	Connection
Sleeve	Ground
Ring	- (cold)
Tip	+ (hot)

Input channel XLR-type connectors are electronically balanced, but optional input isolation transformers can be installed on a per-module basis. All output XLRs are also electronically balanced.

If required, optional isolation transformers can be supplied in a 19-inch rack-mount unit, each unit accommodating eight transformers. In this way, inputs and outputs can be provided with extra grounding isolation and common mode rejection where required, without the price in direct costs, weight or signal quality where the transformers are not required.

### 2.2.1 Monaural input module

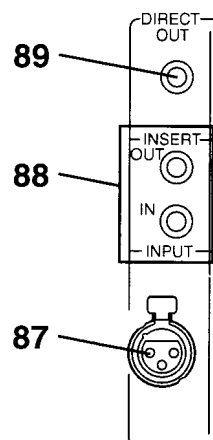

#### Phantom power warning

To prevent hazard or damage, connect only microphones and cables that conform to the IEC268-15A standard.

#### 87 INPUT

This XLR-type connector supplies the signal to the channel module. The nominal input level may vary from -70dBu to +10dBu according to the settings of the channel input gain control and the pad switch [2] (page 11) and [3] (page 11).

#### 88 INSERT OUT and INSERT IN

These phone jacks serve as patch points for the channel. The nominal input and output is +4dBu (1.23V).

The OUT jack may be used as an auxiliary output to another console or as a direct output to a multitrack tape recorder (however, a separate DIRECT OUT [89] (page 31) is provided for this purpose). Most often, it will be used for sending the input channel signal to an off-board signal processor (compressor/limiter, graphic equalizer, noise gate, etc.). The INSERT OUT jack is always live, regardless of the channel's ON status. The IN jack applies a signal to the input channel and is normalled so that inserting a plug interrupts the channel's internal signal flow, bringing in the signal here (usually the return from an off-board processor). This can be bypassed with the channel's INSERT switch [10] (page 13), which overrides this normaling.

#### 89 DIRECT OUT

The DIRECT OUT jack outputs the channel's output from a post-fader position. However, each module can be changed (jumper setting) to

## 2-Features

change this pick-off point to post-pad and gain, but pre-EQ and HPF. See the OPTIONAL FUNCTIONS section for details

### 2.2.2 SUB IN connectors

These connectors allow the PM3500M to accept extra inputs from another console or sub-mixer, allowing the PM3500M to act as the master console for both consoles.

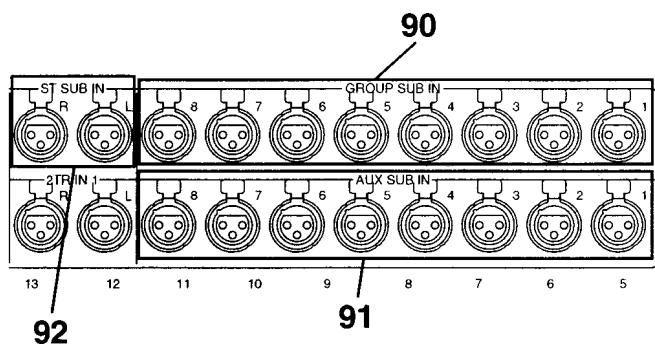

#### 90 GROUP SUB IN (1 through 8)

These connectors apply a signal directly to the group mixing busses (ahead of the group insert and group faders). These signals may be used for adding signals from another console or sub-mixer directly to the mixing groups. Typically, these might be fed from the GROUP OUTs of another console, or might be fed on a paired basis from a keyboard or percussion stereo sub-mixer.

#### 91 AUX SUB IN (1 through 8)

These connectors apply a signal directly to the AUX SEND busses (ahead of the AUX insert and AUX faders). These signals will generally be fed from another console or sub-mixer's AUX OUT connectors, allowing the same effect to be applied on all AUX sends throughout the console chain.

Remember that on the PM3500M, the AUX groups may be paired for stereo operation [12] (page 14). Care should therefore be taken when connecting sub-console AUX OUTs to these SUB IN connectors, so that signals are correctly routed through the effects chain.

#### 92 ST SUB IN (stereo sub inputs)

This pair of connectors feeds signals into the stereo bus, ahead of the stereo insert and stereo faders. Another console or sub-mixer's stereo outputs can therefore be added to the PM3500M stereo bus.

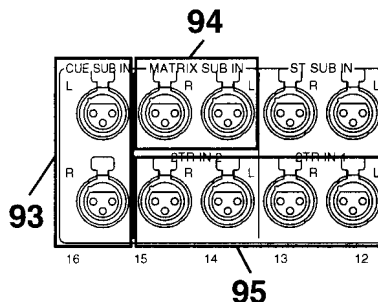

#### 93 CUE SUB IN (L and R)

This pair of connectors feeds signals into the CUE bus. This is useful when another console is being used in conjunction with the PM3500M, and it is necessary to sum the CUE busses from the two consoles.

#### 94 MATRIX SUB IN (L and R)

This pair of connectors feeds signals into the mix matrix. The level of these signals into each matrix group is individually controllable with the SUB IN controls in each matrix group [32] (page 21). These connectors can be used to feed the stereo signal from another source which is to be fed to the matrix, but is not destined for the front-of-house mix. One example of this where matrix busses are used for the performers' foldback mix, and a taped click track for count-in or timekeeping might be required in a piece. Using the MATRIX SUB IN connectors, this click track can be fed to the appropriate matrix groups, and the volume adjusted throughout the piece as required, without it being fed through the front-of-house system.

#### 95 2 TR IN 1 and 2 TR 2 (L and R)

Although strictly speaking, these are not SUB inputs, they may be treated as such in this section. When performing, up to two stereo tape recorders can be used to record the performance. The tapes can be monitored from the A or B monitor outputs [99] (page 33) using the appropriate selector switches [75] (page 28) and [78] (page 29). Connect the TAPE OUT or PLAY outputs of the tape recorder(s) to the appropriate connectors.

#### NOTE

**These inputs are rated at a nominal +4dBu. Many domestic and even semi-professional recorders are -10dBu. Take care when attaching a recorder to these inputs, and make sure that the levels match.**

### 2.2.3 INSERT points

The PM3500M is provided with balanced group insert points, allowing group processing of these signals.

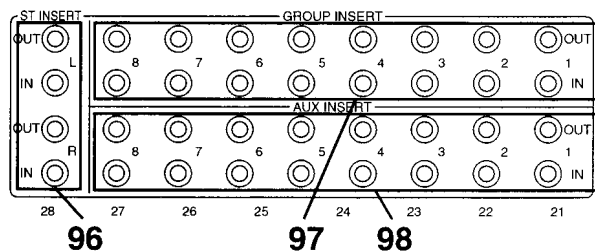

#### 96 ST INSERT L and R (OUT/IN) (stereo insert points)

These phone jacks serve as patch point for the signal from the stereo left and right busses.

The OUT jacks may be used as SUB outputs to another console or to a stereo recorder, though the OUTs may also be used for this purpose. They are primarily intended for adding off-board signal processors, etc. to the stereo signal path. The INSERT OUT jacks are always live, regardless of the stereo bus ON status.

The IN jacks apply signals to the stereo bus and are normalled so that inserting a plug interrupts the bus internal signal flow, bringing in the signal here (usually the return from an off-board processor). This can be bypassed with the stereo INSERT switch [68] (page 27), which overrides this normalling.

#### 97 GROUP INSERT 1 through 8 (OUT/IN)

These phone jacks serve as a patch point for the signal from the correspondingly numbered group mixing bus.

The OUT jacks may be used as auxiliary group outputs to another console or to a multi-track recorder, though the GROUP OUTs may also be used for this purpose. They are primarily intended for adding off-board signal processors, etc. to the group signal path. The INSERT OUT jack is always live, regardless of the group's ON status. The IN jack applies a signal to the group and is normalled so that inserting a plug interrupts the group's internal signal flow, bringing in the signal here (usually the return from an off-board processor). This can be bypassed with the group's INSERT switch [51] (page 24), which overrides this normalling.

#### 98 AUX INSERT 1 through 8 (OUT/IN)

These phone jacks serve as a patch point for the signal from the correspondingly numbered AUX SEND bus.

The OUT jacks may be used as auxiliary AUX SEND outputs to another console or to a multi-track recorder, though the AUX OUTs may also be used for this purpose. They are primarily intended for adding off-board signal processors, etc. to the signal path. The INSERT OUT jack is always live, regardless of the AUX SEND's ON status.

The IN jack applies a signal to the group and is normalled so that inserting a plug interrupts the internal signal flow of the bus, bringing in the signal here (usually the return from an off-board processor). This can be bypassed with the AUX bus INSERT switch [38] (page 22), which overrides this normalling.

### 2.2.4 OUTPUTS

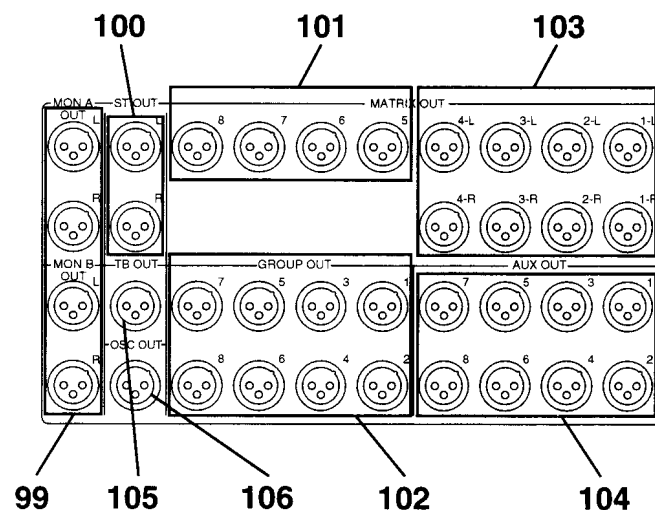

#### 99 MONITOR A and MONITOR B (L and R)

These pairs of connectors provide feeds to a control-room monitoring system, or headphone distribution system. The MONITOR A signal will be muted when the talkback ON switch [66] (page 27) is activated.

#### 100 ST OUT (L and R)

This pair of outputs provides the main stereo output from the stereo bus. These outputs will typically be used to drive the main amplifier/speaker chain comprising the general monitor feeds.

#### 101 MATRIX OUT (5 through 8)

These four outputs provide additional feeds from the four mono matrix groups. These may be used for the same purposes as the stereo matrix

## 2-Features

feeds, bearing in mind, of course, the fact that these are monaural sources.

### 102 GROUP OUT (1 through 8)

These eight outputs provide direct post-fader feeds from the eight mixing groups. They may be used to feed foldback mixes or to drive a multi-track recorder.

### 103 ST MATRIX OUT (1 through 4, L and R)

These eight outputs provide stereo post-master outputs from the first four matrix groups. They may be used for a variety of purposes: alternative mixes for different parts of the venue, dressing-room cueing, lobby feeds, stereo foldback mixes, supplying feeds to stereo recorders or OB units, etc.

### 104 AUX OUT (1 through 8)

These eight outputs provide direct post-fader [39] (page 22) feeds from the eight aux sends. They may be used to feed effect processors whose outputs will be connected to input channels. These outputs may be paired for stereo operation [12] (page 14).

### 105 TALKBACK OUT

This provides a direct output from the talkback bus when the TB OUT switch [59] (page 26) is engaged. It may be used in situations where talkback is not being slated to a group, AUX send or the stereo bus, and may be used to drive a "squawk box" or headphones system for the on-stage monitoring or lighting crew, for example.

### 106 OSC OUT

When the OSC OUT switch [58] (page 25) is engaged, this connector will output the signal from the oscillator. A useful function for this connector would be to connect it to an input on a patchbay, where it can be readily patched through to any input in the system for rapid signal tracing.

## 2.2.5 Control functions

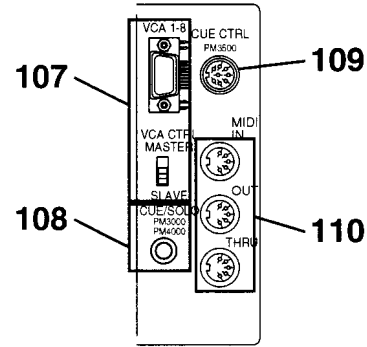

### 107 VCA CONTROL connector and MASTER/SLAVE switch

This allows control of another similarly-equipped console<sup>1</sup>, or the PM3500M to be controlled by a similarly-equipped console, depending on the status of the MASTER/SLAVE switch. When in MASTER mode, the PM3500M can control another console's VCA levels, and when in SLAVE mode, the VCA levels of the PM3500M can be controlled by another unit. The pinouts for the 9-pin D-sub connector are:

Pin #	Assignment
1	VCA control 1
2	VCA control 2
3	VCA control 3
4	VCA control 4
5	VCA control 5
6	VCA control 6
7	VCA control 7
8	VCA control 8
9	Ground

### 108 INPUT CUE/SOLO

This allows the PM3500M to switch between CUE and SOLO modes depending on the signal received at this stereo 1/4" jack from a PM3000 or PM4000 series console. This will override the function of the local SOLO switch [20] (page 18).

1. Such consoles are, in addition to the PM3500 and PM3500M, the PM3000 and PM4000 series.

## 109 CUE CONTROL IN/OUT

This 8-pin DIN connector allows the PM3500M to transmit and receive CUE data from a similarly-equipped console.

## 110 MIDI IN, MIDI OUT, MIDI THRU

These connectors accept, output and pass on MIDI data respectively. The OUT terminal is also configurable as a merged OUT and THRU connector in UTILITY mode (see "MIDI Echoback" on page 56).

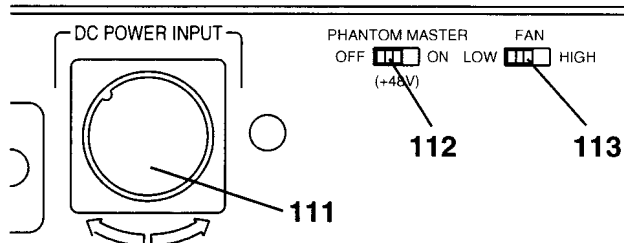

## 111 DC POWER input

This is a locking multi-pin connector which accepts power from the PW4000 power supply through the supplied 3m umbilical cable. When making the power connection to the console, mate the cable and this connector prior to hand-tightening the locking ring.

### CAUTION

**Never attempt to power the console from any power supply other than the PW4000, and do not use any cable other than the supplied cable for making power connections, otherwise damage to the console may result.**

## 112 PHANTOM MASTER

This switch enables or disables the phantom powering switches on all the channel modules [1] (page 11).

## 113 FAN LOW/HIGH

The PM3500M is equipped with cooling fans. In most circumstances, these may be used in the LOW position. However, if the console is being used in a warm ambient environment, or outdoors with direct sunlight falling on the front panel, it may be necessary to set this switch to HIGH. You should set this switch to the HIGH position if you feel the front panel of the console becoming hotter than usual.

### NOTE

As mentioned earlier, we recommend that you turn the console OFF when it will not be in use for a prolonged period. One exception to this general rule is if the console is located in a high-humidity environment or in an environment subject to sudden temperature changes. In this case, leave the console switched on to avoid condensation, which may cause damage to internal circuitry.

## 2.3 The PW4000 power supply

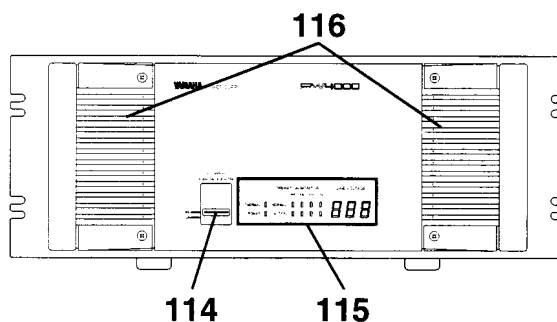

## 114 POWER

This alternate-action switch turns on the AC input to the supply, and provides the necessary output DC voltages to the console via the umbilical power cable. Pressing the switch a second time turns off the power.

## 115 Operation monitor

This panel of LEDs indicates when power is present at the various power supply outputs, as well as other aspects of the power supply's operation. A row of NORMAL LEDs is illuminated when the +48V, +12V, +19V, and -19V outputs are operating. Below that is a corresponding row of LEDs (UNUSUAL), one or more of which illuminates if the output is not within normal tolerance. There is also a green POWER indicator that is illuminated when power is turned on, a red THERMAL indicator that illuminates if the power supply has overheated (and has been automatically shut down), and a digital indicator displaying the AC line voltage input to the power supply.

## 116 Grille

The power supply is cooled by a pair of quiet-running fans that pull air through front-panel grilles and exhaust it through vents at the back.



## 2-Features

A reticulated foam element behind each grille filters the air entering the power supply.

### NOTE

Filter elements are cleanable. Refer to "Power supply air filters" on page 111.

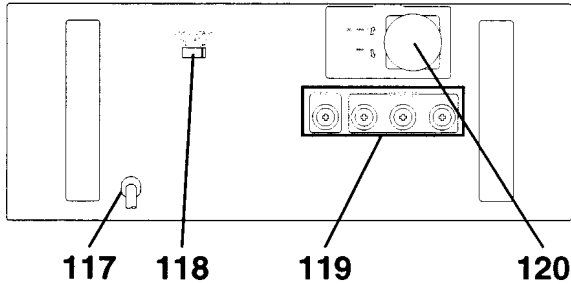

### 117 Power cord

This power cable connects the PW4000 to the AC power mains. A grounded (3-wire) outlet of at least 15 amperes capacity should be used.

### 118 LINE VOLTAGE INDICATOR (Switch)

This slide switch turns the front-panel digital line voltage indicator display on or off, regardless of the position of the POWER switch.

### 119 FUSES

Three main fuses and one sub fuse protect the primary and secondary portions of the PW4000 power supply. They should be replaced only with fuses of the same current rating and type (250 V Slo-Blow): 3 Main Fuses @ 6 A; Sub Fuse @ 3A.

### NOTE

Internal fuses in the PW4000 are also present, but should not normally blow. These are for service by qualified service personnel only.

### 120 DC OUTPUT (umbilical connector)

This locking, multi-pin connector provides the necessary DC voltages from the PW4000 power supply to the PM3500M console. The cable must be connected correctly before attempting to operate the console. See the table below for the pin assignments to this NK-27P connector.

### CAUTION

Always make certain that the PW4000 power is turned OFF prior to connecting or disconnecting the umbilical cable at the console or at the power supply.

Pin #	Function	Pin #	Function
1	-19V	15	±19V GND
2	-19V	16	±19V GND
3	FRAME GND	17	+12V GND
4	-19V	18	+12V GND
5	-19V	19	PM CAUTION (+)
6	FRAME GND	20	+48V
7	FRAME GND	21	+48V GND
8	+19V	22	+12V
9	+19V	23	+12V
10	±19V GND	24	PW CAUTION (-)
11	±19V GND	25	NC
12	+12V GND	26	NC
13	+19V	27	+12V
14	+ 19V		

