

REVISION RECORD	
LTR	DATE

1

2

3

4

5

6

D

C

B

A

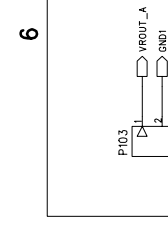

COMPANY: ORIENT POWER MULTIMEDIA LTD.
TITLE: POWER AMPLIFIER (CH. A)
DRAWN: DATED: CHECKED: DATED: QUALITY CONTROL: DATED: RELEASED: DATED: SCALE: 1 OF 3

REVISION RECORD	
LTR	DATE:

1

2

3

4

5

6

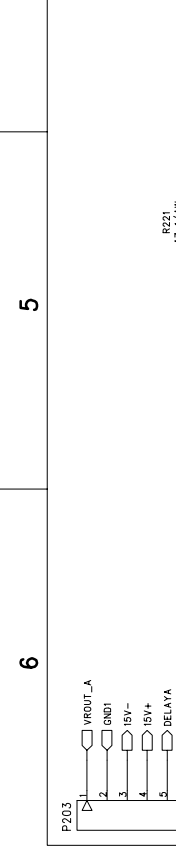

D

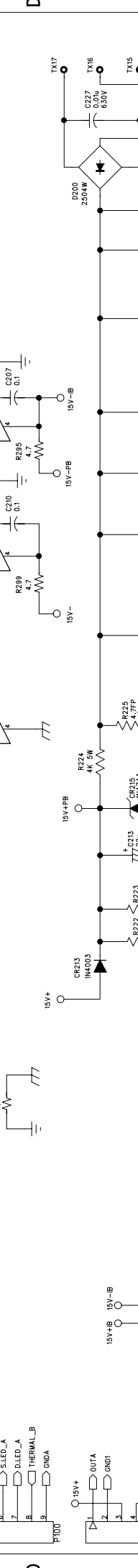

C

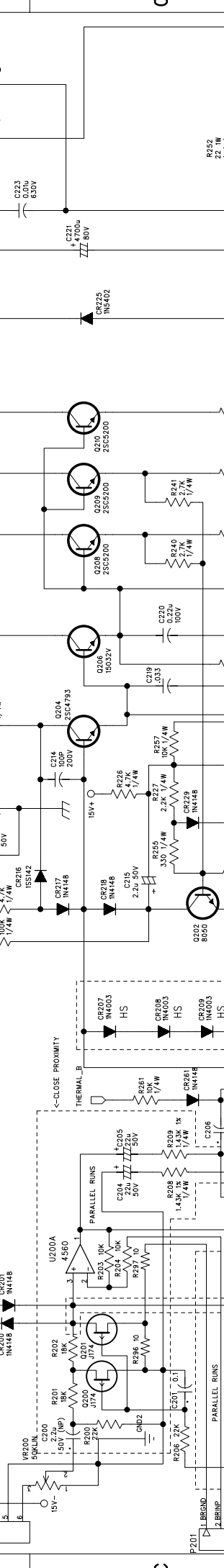

B

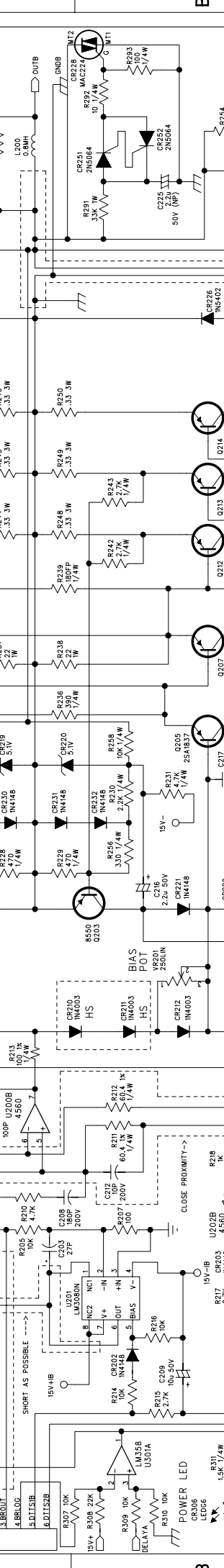

A

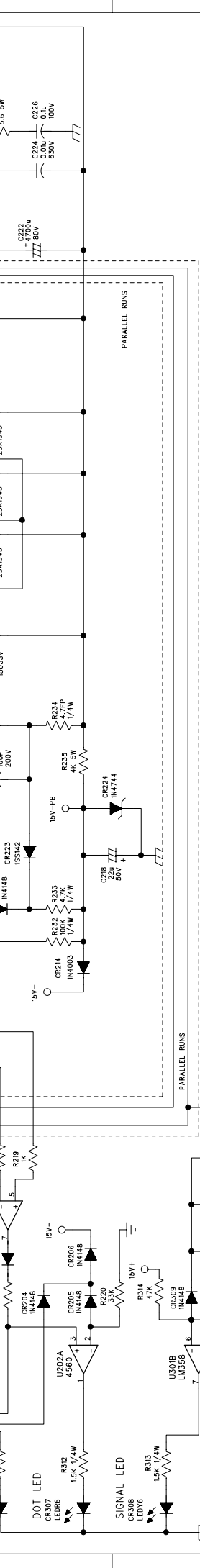

A

COMPANY: ORIENT POWER MULTIMEDIA LTD.	
TITLE: POWER AMPLIFIER (CH. B)	
DRAWN:	DATED:
CHECKED:	DATED:
QUALITY CONTROL:	DATED:
RELEASED:	DATED:
CODE: PV-1500	SIZE:
SCALE: 2 OF 3	REVISION: A



A

REVISION RECORD	
LTR	DATE:

1

2

3

4

5

6

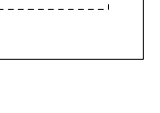
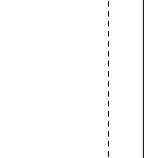
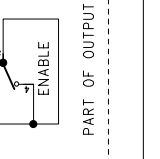
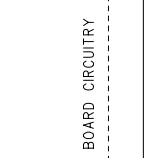
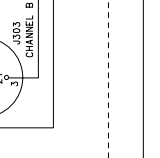
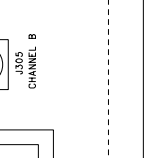
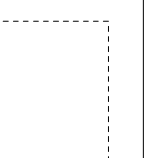
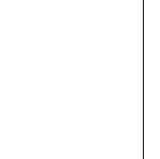
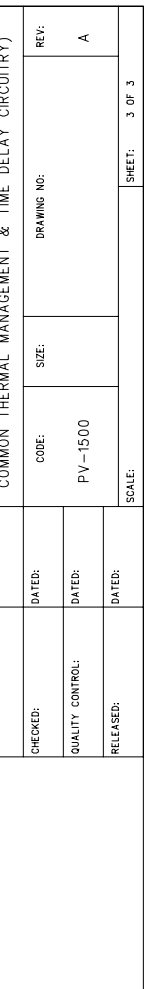
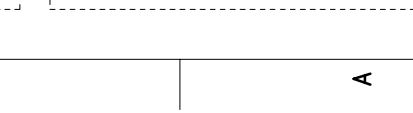
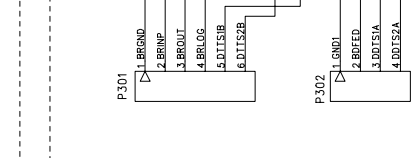
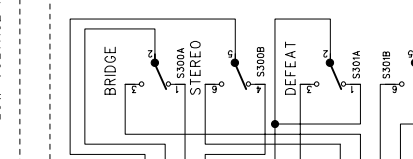
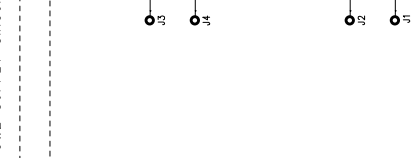
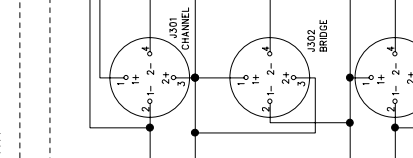
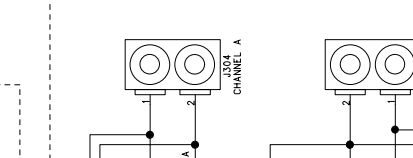
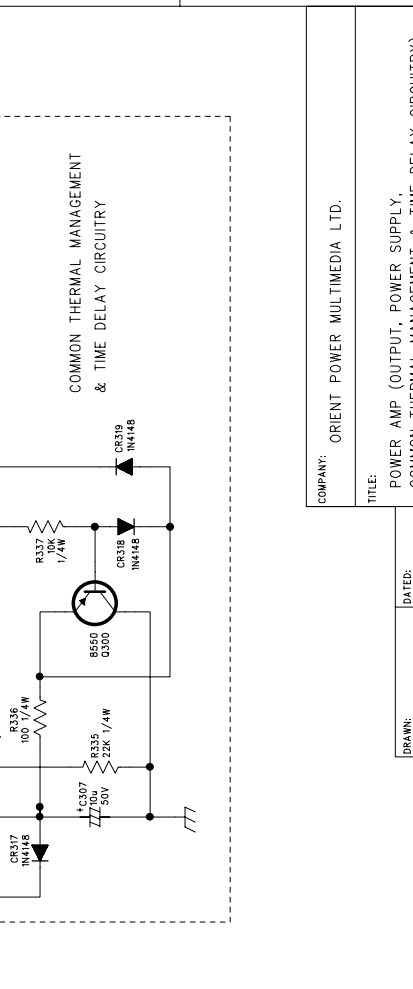
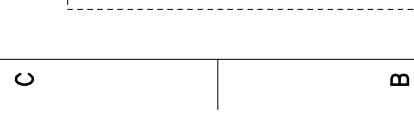
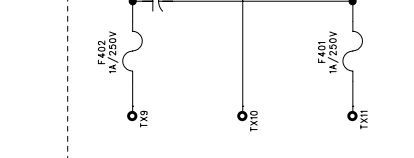
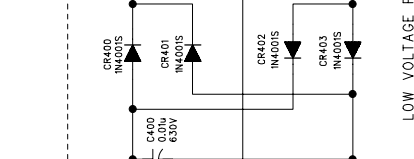
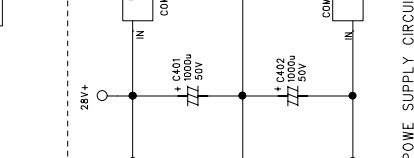
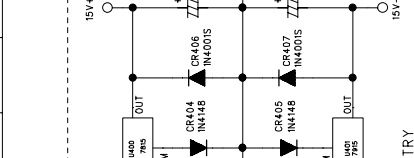
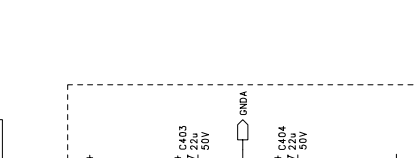
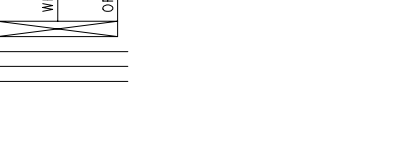
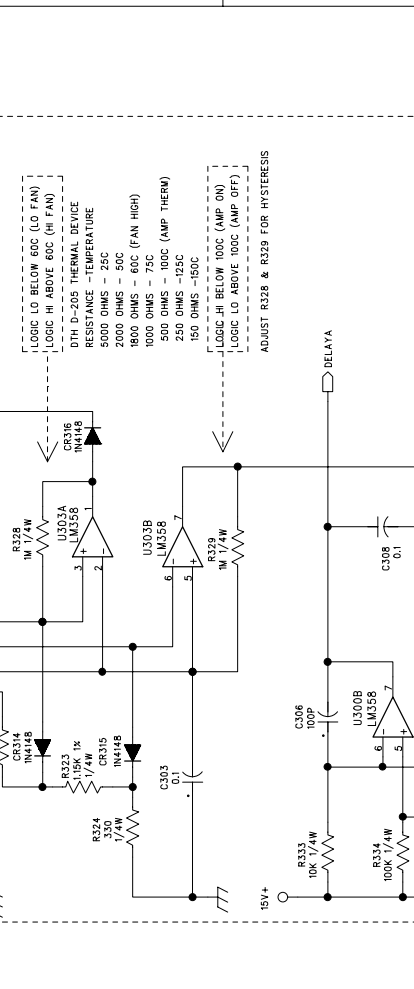
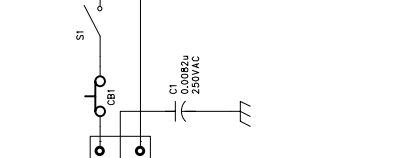
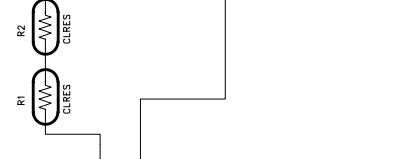
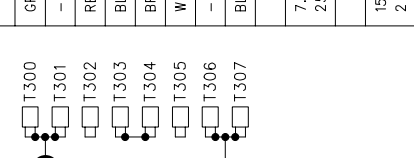
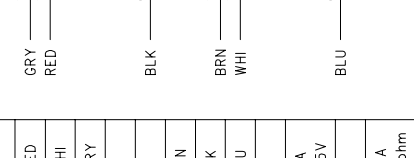
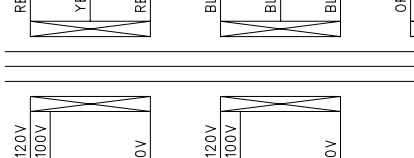
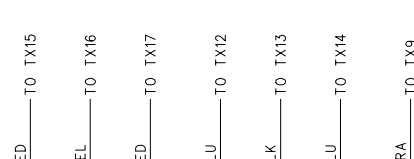
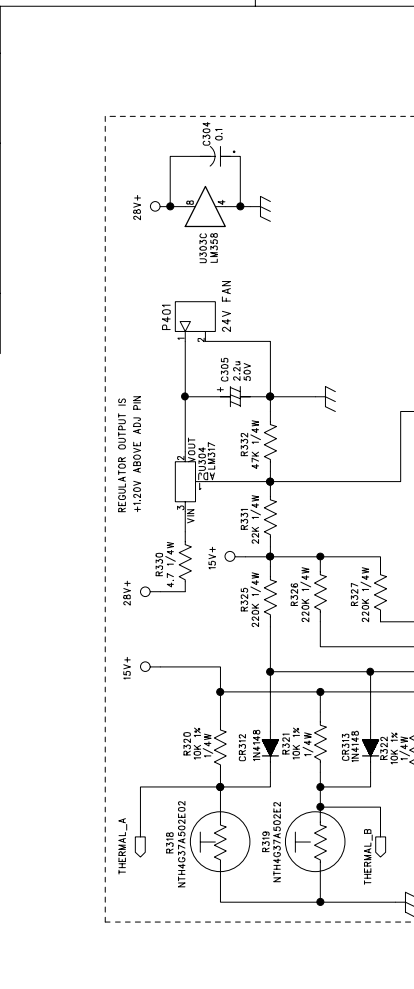

D

C

B

A

COMPANY: ORIENT POWER MULTIMEDIA LTD.
 TITLE: POWER AMP (OUTPUT, POWER SUPPLY, COMMON THERMAL MANAGEMENT & TIME DELAY CIRCUITRY)
 DRAWN: _____ DATED: _____
 CHECKED: _____ DATED: _____
 QUALITY CONTROL: _____ DATED: _____
 RELEASED: _____ DATED: _____
 CODE: PV-1500
 SIZE: _____
 DRAWING NO: _____
 REV: A

SCALE: 3 OF 3

PART OF OUTPUT BOARD CIRCUITRY