

ALL THE PARTS YOU NEED

EDITION 2.1

DISCOVERY

SERIES 2 1998-2004

PARTS & ACCESSORIES CATALOGUE



RIMMER
BROS

SUPPLIERS OF ORIGINAL & AFTERMARKET PARTS

SOURCE CODE D2M7

THE RIMMER BROS SERVICE

**WE HAVE THE
PARTS**

**WE GUARANTEE
THE QUALITY**

**WE'RE KEEN ON
PRICE**

**WE DELIVER
FAST**

**WE KNOW YOUR
CAR**



HELPING YOU CARE FOR YOUR DISCOVERY

Since the early 1980s, Rimmer Bros has specialised in supplying parts for Classic Triumph cars. In addition, we have been supplying stainless steel exhaust systems for Land Rovers and other 4x4 vehicles since 1984.

In 1993, we added to our range of parts catalogues when we began stocking parts for the Rover SD1.

In the summer of 2000, to celebrate 30 years of Range Rover production, we launched our comprehensive parts catalogue for the Classic Range Rover. This was a natural move, as a vast number of Range Rover's are powered by the Rover V8 engine - a subject in which we specialise! This was followed soon after by our Discovery, Freelander and Defender parts and accessories catalogues.

We are now pleased to introduce our latest parts and accessories catalogue, for the Series II Discovery (1998 to 2004) This catalogue lists a comprehensive range of both genuine and aftermarket parts and accessories.

Our customers are owners, garages and other specialists looking for a fast, reliable source of original and high quality aftermarket parts and accessories available by mail order or over the counter. We have the latest technology to ensure orders are processed instantly and despatched promptly to wherever you are - UK or worldwide.

Our aim with this catalogue is to apply our unique parts service to Series II Discovery, helping you to maintain and enhance your vehicle at affordable cost.

THIS CATALOGUE

We have endeavoured to keep the parts listings as comprehensive as possible whilst concentrating on the items most frequently called for. If the parts you require are not shown, please contact our sales office, where our staff will be pleased to check availability and price for you. Prices are listed in our separate Price Guide or can be found on our website.

Our Catalogues and Price Guide are also available on CD - see inside rear cover for details.

APPROVED BY LAND ROVER

Rimmer Bros is an authorised Land Rover Parts Distributor (see page 7). This means we have access to the full range of genuine Land Rover parts - for every model.

This catalogue features genuine parts throughout - at affordable prices - alongside aftermarket parts.

The added advantage of being able to order a part for any Land Rover from the convenience of your home or workplace, means the Rimmer Bros service is hard to beat!

THE CARS WE SPECIALISE IN

As well as supplying parts for Range Rover, Discovery, Freelander, Defender, 90/110 and Land Rover 'Series' vehicles, we also specialise in Triumph - TR2-8, 2000/2500/2.5Pi, Stag, Spitfire, GT6, Dolomite, Herald, Vitesse & Rover SD1. Additionally, we also supply parts for MG Rover cars - Rover 100/200/400/600/800/25/45/75/ZT & MGF.

Please refer to inside rear cover for details on all our catalogues.



**RIMMER
BROS**

UK & WORLDWIDE



SO WHERE DO WE GET OUR PARTS

We offer genuine Land Rover Parts - direct from Land Rover - which offer the best quality and service life. We also offer quality after-market parts as an alternative to original equipment; often, there can be significant cost savings.



PART NUMBERS

In general, we use Land Rover part numbers to identify original equipment (OE) Land Rover parts. When an alternative to the OE is offered (aftermarket), then the part number is identified with a 'P' suffix. There is also equivalence with certain Rover and Triumph numbers where we list the Rover/Triumph number.

LL, RA, RB, RD, RX & LF prefixes denote a Rimmer Bros derived part, where no original part number exists. An 'R' suffix denotes 'reconditioned', usually sold on an exchange basis.

THE STOCK WE NEED TO GIVE THE SERVICE YOU NEED

Our degree of specialisation means two things:

Firstly, our people know the cars we're dealing with inside and out, and can give you any advice you might need regarding part selection.

Secondly, we are able to stock in depth just about any part you might need. Triumph House was acquired in 1991. With over 75,000 square feet of warehousing alone, it is a cavernous building, and it needs to be! It currently contains more than 350,000 recorded part numbers with over 35,000 stock lines, and we hold as many of each as necessary to make it almost impossible to run out of stock.

All other aspects of our operation receive equal emphasis. A truly efficient mail order and stock control system. The latest racking and storage facilities for fast and accurate "order picking", careful packaging and despatch procedures.

THE PEOPLE YOU'RE DEALING WITH

This company really is owned by two brothers named Rimmer. Bill and Graham started their business from humble beginnings in the early 1980s, and it has grown to be one of the leading organisations of its kind in the world, supplying parts Worldwide to an ever growing list of customers.

Both Bill and Graham still work full-time in the business, helped now by over 50 members of staff.

The main qualification of membership of our staff is a recognition that our customers, and our company reputation, depend on our ability to get every aspect of our service right first time.



COMMITMENT TO CUSTOMER SERVICE

Helpful - Accurate - Fast - Efficient

The overall objective at Rimmer Bros is to achieve customer satisfaction at all times.

Our people know your car well, and every member of our staff is dedicated to helping Land Rover owners.

Our computer system gives up-to-the minute information regarding availability and the price of any item. We have an enviable reputation for despatching goods when the customer needs them, quickly and efficiently.

We try to make all our systems and documentation easy to follow and use, and make sure that our catalogues and price guides really do help our customers choose the right parts easily, first time.



"Errors & Omissions Excepted. All parts offered subject to availability.

All part numbers, illustrations and photographs used in this catalogue are intended for reference/identification purposes only, and are not necessarily an exact representation of the goods supplied. Whilst we make every effort to ensure the accuracy of product descriptions in this catalogue, they are based upon information supplied by the manufacturer/distributor at the time of publication. There may be occasions - due to circumstances beyond our control - when specifications are changed, or when goods become temporarily unavailable." Certain part numbers have been superseded to an alternative number when a later version or updated specification is offered.

© Copyright Rimmer Bros. All rights reserved. No part of this publication may be copied, reproduced, stored in any retrieval system, communicated or transmitted in any form or by any means, including Photocopying, Electronic, Mechanical or otherwise, without prior written permission from Rimmer Bros Ltd.

THE LAND ROVER PARTS SPECIALIST

TELEPHONE NUMBER

SALES
01522
568000

*(Overseas +44 1522 568000)***FAX NUMBER**

SALES
01522
567600

*(Overseas +44 1522 567600)***ADDRESS**

**Rimmer Bros, Triumph House,
Sleaford Road, Bracebridge Heath,
Lincoln, LN4 2NA, England.**

THIS CATALOGUE & OUR PRICE GUIDE

There are no prices in this catalogue. Use it to select the parts you need, then check their cost by referring to our web site or the separate Price Guide (or CD rom) which represents the other half of our ordering system. The price guide is updated and reprinted more frequently, but we ask that you confirm all prices when ordering. It may also list additional parts (new lines) that we have introduced since this catalogue was printed, and it has more detailed information about ordering & delivery methods. It also has information on warranties and a 'Trouble Shooter Guide'.

ORDERING BY PHONE

Please quote your home postcode and part numbers where possible. This gives instant access to our computerised records and stock control system. If you have any difficulty in selecting the parts you need, our expert staff can help.

**UK Payment for Phone Orders***(See also "Overseas Orders & Payment.")*

When you have checked on price, availability and delivery costs you can place your order by phone using Visa, MasterCard, Delta/Connect, Maestro, Solo, American Express, Diners Club, or JCB. You will need to tell us the card number, expiry date (or issue number), cardholder's full name and registered card address.

After Hours Ordering Service

We operate a 24-hour answering/ordering service which is available to card holders out of normal hours for both UK and Overseas customers. Just leave all necessary details on our telephone voice mails, ie your vehicle type, year, model, the parts and/or the part numbers you require, plus your name, address (inc. postcode), credit card details and delivery address (if different).

Writing out these details before phoning usually helps a caller to give us clear instructions. If at all possible, please also leave a daytime telephone number.

ORDERING ON LINE & BY E-MAIL

For Internet surfers our web site holds details on all our parts catalogues and has an on line ordering facility. Use our E-Mail address for sending your order or parts enquiry. State if you require us to confirm prices, as they can sometimes alter at short notice.

www.rimmerbros.co.ukE-Mail: **LRsales@rimmerbros.co.uk**

**Order through our website using our
secure on-line ordering system!**

All the latest news, special offers, products and prices just a 'click' away.

ORDERING BY POST

Triumph House, Sleaford Road, Bracebridge Heath, Lincoln, LN4 2NA, England.

We ask you to phone first if at all possible - to check your parts selection, and to advise of delivery charges. Because prices and availability sometimes change, we can also confirm the exact remittance needed, avoiding unnecessary delays. If you have not been able to telephone, please give us all possible information - car type/year, RH or LH, front/rear etc - so we can check your selection (including your name, address and postcode) in all correspondence.

Use our Order Form if you can. It asks specifically for all the details we might need. Please photostat or request additional copies of the order form if required.

UK Payment for Post Orders *(See also "Overseas Orders & Payment.")*

Send your remittance with the order. The 'Pricing' section in the Price Guide tells you how to calculate the amount.

We accept payment by personal cheque even if the cheque guarantee card limit is exceeded. All we require is your full name and address on the back of the cheque along with your cheque card number and for business cheques, a relevant letterhead. Cheques or P.O.s made out "Rimmer Bros Ltd" please.

Note, if you are unsure as to the exact amount to send, you can write across the top of your cheque, "Cheque Value Not To Exceed £...". You can post us your credit card details if you prefer. If you send cash, note that we cannot accept responsibility for any loss, so registered mail is essential. Bank drafts and Building Society cheques are also accepted. For Bank Transfer information see Price Guide.

ORDERING BY FAX

UK CUSTOMERS: 01522 567600 OVERSEAS CUSTOMERS: +44 1522 567600

See also "Overseas Orders & Payment."

Another facility for customers who wish to make enquiries, or order by credit, debit or charge card. Again, we will need your name, address (inc. postcode), credit card details and delivery address (if different). Plus fullest possible car/parts details - as for orders by post.

ORDER

COLLECTING IN PERSON

If you wish to 'call and collect', you will always be made welcome at our shop and sales counter during business hours. Our Visitor Information Centre has lots of interesting details of each production model and the factories where they were produced.

Customers drive here regularly from all over Europe. Lincoln is a historic Cathedral city and is an excellent place to visit. We're about 2 miles south of Lincoln on the A15 Lincoln to Sleaford road (see map on back cover). We advise you to pre-check by phone that we have the part/s you want in stock.

We accept payment by credit card, cash, bank draft, travellers cheque, building society cheque, and personal cheque (when presented with a cheque card) even if the cheque card limit is exceeded, and by business cheque with accompanying letterhead.

PRICING

For full information and details on prices, VAT, & VAT exempt export sales, please refer to our web site or the latest Price Guide. Written quotations are available on request, for parts and/or delivery charges. Please confirm all prices when ordering - prices and availability can sometimes change at short notice. Please note that our latest prices can be found on our web site.

OVERSEAS ORDERS & PAYMENT

We supply parts to car owners Worldwide. We have thousands of customers in Europe and regularly send parts as far afield as Australia, North America, Africa and the Far East. Delivery costs of course, vary greatly (depending on size/weight/ urgency). We can quote accurately for the cost of parts and delivery once your requirements are known.

Our Multi-language European Order Forms explain how to order parts in English, Italian, German, Spanish and French.

Payment By Export Customers:

There is a choice of payment methods for customers overseas;

- A) Credit card, Debit card or Charge card.
- B) Bank cheque - in ££s sterling (Drawn on a London Bank)
- C) Travellers Cheques (signed) - in ££s sterling.
- D) Giro Cheques in ££s sterling.
- E) By Bank Transfer - see Price Guide.

PLEASE NOTE THAT ALL TRANSACTIONS MUST BE IN ££s STERLING.

DELIVERY METHODS

(For Further Information/Cost Details, Please Refer to Price Guide)

UNITED KINGDOM

There are numerous delivery options for the UK mainland ranging from post to overnight carrier services. We can advise of the best method of despatch when you order. The type of service that we recommend depends upon the size, weight and urgency of the parts you require.

Our price guide indicates the approximate costs, and we will confirm the final invoice total before despatching if required.

WORLDWIDE (NON EC COUNTRIES)

We started exporting parts Worldwide in 1982, and since then we have gained an excellent reputation for our speed & efficiency of service.

Delivery costs are based on size, weight, and method of delivery. We have discounted rates with well known carriers, so costs are kept to a minimum. Send us a list of the parts you need (using post, phone, fax or E-Mail), tell us quantities and urgency, and we will work out the best delivery method and quickly advise you of the cost.

Written quotations are available on request.

EC COUNTRIES

The European Community Single Market permits the free movement of goods between all EC countries. This allows us to provide a superb service to all our customers within the EC, with the benefits of improved delivery - via lower charges and easier documentation. Deliveries can be easily arranged using air or surface transport. Our Price Guide indicates approximate costs.

CATALOGUE CONTENTS

VEHICLE IDENTIFICATION	7
SERVICE ITEMS (QUICKFINDER)	9
TD5 ENGINE	11
V8 ENGINE	12
CLUTCH & FLYWHEEL	17
ENGINE & GEARBOX MOUNTINGS	17
COOLING & HEATING SYSTEM	18
FUEL SYSTEM	20
EXHAUST	21
GEARBOX	23
PROPSHAFT	24
AXLES	24
FRONT SUSPENSION	25
REAR SUSPENSION	26
SUSPENSION PACKAGES	28
ROAD WHEELS	29
BRAKES	32
STEERING	34
ELECTRICAL	35
BODYWORK	38
BODY FITTINGS & FINISHERS	40
DECALS & BADGES	43
INTERIOR TRIM	44
ACCESSORIES	47
INDEX	65

NEW & RECONDITIONED PARTS

Almost every part we list is sold brand-new, but in many instances we also offer you the facility to buy "Reconditioned" (usually giving us your old component in part-exchange).

Where there is a reconditioned version of a part, you will find the letter 'R' added at the end of the part number.

EXCHANGE SURCHARGES (REFUNDABLE)

Where parts are sold on an exchange basis, an "Exchange Surcharge" is applied - a deposit in effect, which is refunded to you when your old unit is received by us. This system allows you to make an exchange without having to send the old unit first ... it can often prevent your vehicle being off the road. The amount of the Exchange Surcharge is shown in the Price Guide in italics below the part number.

Before returning your old unit, please telephone our customer service dept on 01522 568000 in order to obtain a return authorisation number. See reverse of invoice for full details of return procedure. Units must be drained of oil, water and be serviceable; we reserve the right to retain all or part of the surcharge if the unit is irreparable, damaged, incomplete or not identical to the type supplied.

INTRODUCTION

Project Tempest

Towards the end of the 1990s, the original - and hugely successful - Land Rover Discovery was redesigned under the name 'Project Tempest'. Both the press and the public waited with anticipation; this was going to have to be something special to take over from the original model.

The New Discovery was previewed first in the USA at a special Land Rover 50th Anniversary celebration held on April 30th 1998, at LRNA's Lanham headquarters. Land Rover then organised a round-the-world publicity trip for the vehicle, to raise awareness and prove that it was as capable as its predecessor. On 1st June 1998, a pair of New Discovery vehicles - one V8i and one Td5 - set out from London. The plan was to visit 25 countries and travel over 30,000 km in just 100 days, for what could be described as 'the longest test-drive in history'. It was to prove, beyond a doubt, the "new" Discovery's credentials - both as a Land Rover and as the Most Advanced 4x4Far.

The vehicles were given to two teams of journalists to drive around the world. Taking the worst that the world could throw at them, and completing the journey in time, and without a hitch. New Discovery TRex was the longest, most arduous and most ambitious test drive in history.

By the end, the vehicles had covered 19,152 miles and 27 countries in just 58 days. In early August, a technical briefing day was held for invited members of the world's media at the Rover Group's Gaydon research and development facility. A ride-and-drive event for the press followed during September near Nairn, in the Scottish Highlands, and the vehicle was finally revealed to the public at the Paris Motor Show on September 29th. Sales began on November 21st in the UK, and in the New Year for the rest of the world.

Evolution or Revolution

The new vehicle was given the name "Discovery Series II", which was carefully chosen to invoke the history of the original Land Rover Series vehicles.

At first glance, the Series II looked very similar in appearance to its predecessors, but under the skin it included a variety of new features - some already fitted to other models in the Land Rover line-up, such as the Freelander's Hill Descent Control (HDC) and the Range Rover's air suspension at the rear - and some completely new options, such as Active Cornering Enhancement (ACE), which reduced cornering roll to insignificant proportions.

The interior and exterior were re-worked to be less utilitarian, but it was still apparently very similar to the Discovery I. However, every body panel was in fact new (and incompatible), with the exception of the rear door outer skin. The rear body was extended to improve load space but at the expense of added rear overhang, which adversely impacted off-road ability (a compromise that most owners would consider more than acceptable).

The diesel-engined models were given a completely new engine, the 2495cc Td5 (in-line direct-injected 5 cylinder), in common with the updated Defender models. This electronically managed engine was smoother and produced more usable torque at lower revs than its 300 Tdi predecessor. The familiar V8 petrol version - now identified as 4.0 litre but actually the same bore and stroke as the old 3.9 - was transplanted straight from the P38A Range Rover, but the 4.6 variant from that car was not available. A new dual-mode, intelligent, electronically controlled, four-speed automatic transmission was available with either engine.

Whilst cynics might have accused Land Rover of simply combining the best features of the existing model range into one gap-bridging model (using engines from Defender and Range Rover P38A, HDC from Freelander, air suspension from Range Rover, all in a modestly redesigned body), in fact the new vehicle had some features of its own to make it something very special.

“The design is the evolution that hides a revolution”

Alan Moberly, Chief Designer, New Discovery

Body Design & Structure

Both on and under the skin, the New Discovery body shell underwent a major engineering and re-tooling programme to achieve the latest world-class standards. The result could be readily seen in the smoothly-formed, close-fitting body panels, with narrow, accurately-aligned door gaps. Body material changes included the extensive use of zinc coated steel, particularly in the lower part of the shell, and a change from aluminium to steel for the door skins. Steel outer panels facilitated the pressing of the new, more sculpted door form as well as allowing tighter tolerance control. The zinc coating provided outstanding corrosion protection and rigorous attention was paid to improved body sealing to prevent water ingress and minimise wind noise.

The structure beneath was also upgraded in the light of new design and manufacturing technologies. Use of 'Design For Assembly' (DFA) techniques led to reduced panel count and simplification compared with the previous design, one example being the new extended rear floor structure which was a single pressing in place of seven. This contributed to a stiffer body shell.

Specifications

The New Discovery was available with a choice of just 2 engines - the all new, high technology 2.5 litre, 5 cylinder, direct injection diesel or the latest generation of the famous V8 petrol engine - and just one, 5 door body style. There were 4 trim levels, all of which had driver's air bag, ABS, Electronic Traction Control (ETC) and Hill Descent Control (HDC) as standard. All models above the base derivative had 7 seats and Self Levelling Suspension (SLS) as standard while the top 2 trim levels had Active Cornering Enhancement (ACE) as standard. Seven seats, SLS and ACE were optional on other derivatives. Base models and the 'S' derivative had a new cloth trim while the XS model had a unique leather and 'Land Rover' fabric combination. The top level ES model had leather trimmed seats. All models featured improved in-car entertainment (ICE) systems with the ES being fitted with a Harmon Kardon developed 12 speaker system with remote CD auto-changer and remote headphone sockets for rear passengers. This system was optional on 'S' and 'XS' derivatives. The range was complemented by a wide selection of accessories, as usual.

New Discovery was developed by a team led by project director Nick Fell who was previously project director on the MGf. The design team of Belinda Mason and Mike Sampson was lead by chief designer Alan Moberly who was previously associated with the major facelift of Discovery in 1994. Beneath the body style, which is a subtle but complete evolution of the iconic Discovery design, was concealed a complex array of high technology Dynamic Control Systems that moved 4x4 vehicle design into a new dimension. New features included:

- Unique Dynamic Control Systems for car-like handling and ride
- Active Cornering Enhancement (ACE) - a new experience in 4x4s
- New traction technology for supreme off road performance
- A brand new, powerful and efficient 5 cylinder diesel engine
- More power and torque for the V8 engine for improved driveability
- Fashionable interior with luxurious new seating and new fabrics
- New folding rear seats to give true seven-seat, all forward-facing capability
- Concert hall quality, 320watt 12 speaker in-car entertainment on top models
- New safety features
- The highest level security system as standard



Advanced Transmission

The new optional automatic transmission available on all New Discovery models - the ZF4HP22EH - featured a sophisticated electronic control system, with a variety of special features to enhance the driving experience on and off road. Electronic control gives more precise and consistent gear change points. The Transmission Control Unit (TCU) also communicated with the power unit ECM using a high speed "CANbus" link to effect a momentary torque reduction at the point of ratio change, resulting in a smoother change. Land Rover engineers invested a great deal of development time in making sure that the power unit and the automatic transmission worked together effectively as one unit. This meant, for example, that when the engine management system adjusted the fuelling to compensate for high altitude conditions, the transmission control likewise adjusted the shift strategy to suit. In addition to a normal gear shift mode, controlled via the conventional P, R, N, D, and 3, 2, 1 selector positions in either high or low range, the driver also had the choice of two alternative mode selections. If the mode selection button was pressed while the road-going high range was in use, a 'Sport' mode was selected, which made more use of available engine power, changing up at higher revs, and changing down more readily. When low range was in use, usually for more difficult off road conditions, the mode selector button brought in 'Manual' mode, which closely emulated a manual transmission, allowing a selected gear (e.g. 3, 2 or 1) to be held without shifting almost regardless of speed, assisting driver control. In this mode the only situation under which a downshift would then occur would be at very low speed, to avoid stalling the engine.

The locking centre differential was still fitted, although the linkage to operate it was not attached, as Land Rover believed that the traction control and newly-developed Hill Descent Control would render it redundant. In 2002, the mechanism was finally removed, but was introduced later in that year due to customer demand (the mechanism and controls were fully reinstated as a cost option only - standard on top of range HSE/ES vehicles - on UK models).

Land Rover had already used two different electronic traction control (ETC) systems in its range, with the rear axle control system fitted to Range Rover and the four-wheel system on ABS-equipped Freelander models. New Discovery introduced a further variation on the theme, which enabled ETC to give outstanding results without the need for a viscous coupling or a lockable central differential between front and rear axles. New Discovery's full-time ETC system used the ABS wheel-speed sensors not only to identify side to side wheel speed discrepancies which occur when one wheel loses traction, but also to compare front and rear axle speed relationships. It therefore had the capability of emulating the front/rear traction control task that was carried out by viscous couplings on Range Rover and Freelander. New Discovery ETC worked under all road or off-road conditions up to a speed of 100 kph (62 mph). It had two control strategies, automatically selected according to the corresponding selection of high or low range on the transfer gearbox. In low range, where an ETC brake intervention was less likely to cause an engine stall, a more forceful approach was taken, with the system being even less 'tolerant' of any wheel slip. Inhibiting wheel spin in this rigorous way not only helped traction, but also reduces damage to the ground surface, as well as avoiding vehicle fouling and damage. In extensive off-road testing carried out in company with competitive vehicles under all kinds of conditions around the world, the ETC system of New Discovery demonstrated an extraordinary superiority of traction. Even in normal road driving, the ETC was deliberately programmed to be pro-active for increased confidence and safety.

Driving the Discovery

Drivers of the Series II Discovery were immediately astonished by its agility when compared with the outgoing model (and, in fact, the existing Range Rover). There was far less of the lateral movement that so many tall vehicles suffer from, due mainly to the combination of Self-Levelling Suspension (SLS) and Active Cornering Enhancement (ACE). However, transformations in the driving characteristics of the new vehicle were also due to other factors shared across the entire range: one of the keys to many of the dynamic behaviour improvements of the New Discovery lay in the steering geometry. By adopting Range Rover-style open yoke universal joints for the new front axle, the king pin inclination was altered to greatly reduce the ground offset. In addition to improving general steering characteristics, this reduced steering kick-back effects from sources such as rough ground or braking forces. Steering and suspension ball joints used a new technology, with pre-loaded rubber bearing elements that were exceptionally wear-resistant, even if the joint seals became damaged. An updated worm and roller power steering box was specified and hydraulic power for the steering box came from a new pump, specified to suit the revised steering system. In the steering column, new rose-type joints were fitted

for smoother action. Furthermore, the new axles were wider than on the previous model, to improve general stability and road holding. Finally, one of the most significant changes was the adoption of a Watts linkage lateral location for the rear axle, in place of the original central A-bracket. This raised the roll centre height and helped to reduce cornering roll in conjunction with a new, lighter and stiffer fabricated panhard rod, used for lateral location of the front axle to optimise the roll steer effect.

The rear air springs fitted to New Discovery were in fact different to Range Rover springs, using a new construction with lighter and more flexible sidewalls for optimum ride characteristics. They are connected to an air distributor which contains the electric compressor, an air drier unit and the left and right hand solenoid-operated spring valves. Left and right hand height sensors connected to the rear axle radius arms provide signals to the electronic control unit. Self levelling is carried out automatically whenever the engine is running, although when the vehicle is stationary all the doors must be closed for safety before the system will raise the suspension. Safety features are built in, to automatically stop the process if abnormal operation caused by an obstruction is detected.

Thanks to the SLS system's rear air springs, the suspension continually self-adjusts to provide a level ride; usefully, it can also be lowered or raised to attach a tow bar or cruise above rocky surfaces.

Inside, the packaging of the two third row seats was the subject of a major engineering project in its own right. The Discovery has always been essentially a vehicle for families but although these seats are mostly commandeered by children, they have been designed and dynamically tested to meet full adult safety standards.

Facia changes included a new passenger airbag module, and a new steering wheel with driver's airbag. Where appropriate the steering wheel has remote switches for the ICE system and cruise control. Improved switchgear was of the same pattern introduced for Freelander and there was a completely new instrument pack. A number of new interior items were based on BMW parts, namely the automatic gear selector, the cant rail mounted grab handles and the electric seat switches.

Styling Updates

In 2003, there was a revised series II model, with L322 Range Rover style headlights, new bumpers and many other enhancements. Encouraged by the rapturous reception given to the 2002 Range Rover flagship model, Land Rover decided to sprinkle a little of the big car's look and feel onto the Discovery range. With revised styling, equipment tweaks and improvements to suspension and brakes, this model brought the Discovery up to date in a market that was starting to spawn some serious rivals.

So, Series II Discovery was anything but a face-lift of the original Discovery, using various parts-bin components from existing vehicles. In fact, it was the opposite: a completely new vehicle into which Land Rover skillfully incorporated the key design elements and legendary on- and off-road abilities so beloved of its customers. From the month it was launched, the Discovery became the second-best selling 4x4 in the UK (the Freelander was and still is the best-selling here). Land Rover sales figures are consistently breaking industry trends and are constantly rising when the rest of the industry is in a depression.

Buyers put their trust in the New Discovery, and it didn't let them down.



VEHICLE PRODUCTION & SPECIFICATION SUMMARY

VEHICLE IDENTIFICATION

To ensure the parts that you order are correct for your Discovery, you will need to know when the vehicle was manufactured. Although the registration document will tell you when it was *registered*, this may have been some time after it was actually built. The most accurate way to determine your Discovery's age (along with information relating to its specification) is by the chassis - or VIN - number.

You can find this number on your registration document, as well as two different places on the vehicle:

1. On a plate riveted to a panel in front of the radiator.
2. Inside the windscreen, on the lower left hand corner.

The VIN number contains details about where your car was built, the year of manufacture and the original specification. For example, a typical VIN would appear as follows: **SALLTGM23YA**, followed by a 6-figure serial number. This information is broken down as follows:

SAL	Manufacturer code for Land Rover
LT	Vehicle code for Discovery
G	Trim level
M	Body style - 5 door
2	Engine code - 4.0 litre V8
3	Transmission & steering - auto, RHD
X	Model year - 1999 (Y = 2000, 1 = 2001 etc.)
A	Assembly location - Solihull



ENGINE & TRANSMISSION

	Td5	V8
Engine capacity	2495cc	3950cc
Cylinders	5	8
Bore	84.5mm	94mm
Stroke	89.00mm	91.1mm
Compression ratio	19.5:1	9.35:1
Max. power (bhp)	122 @ 4200rpm	186 @ 4750rpm
Max. torque (lb/ft)	195 @ 1950rpm	236 @ 3000rpm

PERFORMANCE

	V8 MANUAL	V8 AUTO	Td5 MANUAL	TD5 AUTO
0-60	10.6	11.5	14.2	15.8
Top Speed	106	106	98	98
Ave Cons	17	16	30	27

DIMENSIONS/WEIGHT

CURB WEIGHT	2825kg
LENGTH	4704mm
WIDTH	1890mm
HEIGHT	1941mm
W/BASE	2540mm

YOUR VEHICLE DETAILS

ENTER YOUR VEHICLE DETAILS HERE FOR EASY REFERENCE

Model	
Year of Manufacture	
VIN/Chassis Number	
Engine Type	
Engine Number	
Gearbox Type	
Paint Code	
Trim Code	

www.rimmerbros.co.uk

Order through our website using our **secure** on-line ordering system!



All the latest news, special offers, products and prices just a 'click' away.

UNDER CONSTANT REVIEW - LOOK OUT FOR NEW FEATURES AND CATALOGUES

GENUINE PARTS & ACCESSORIES



Authorised Land Rover Parts Distributor

Rimmer Bros is an authorised Land Rover Parts Distributor. Appointed in early 2005, we offer a full range of genuine Land Rover parts and accessories for all Land Rover vehicles - right up to the latest models!

We also have access to products supplied by Land Rover Classic Parts covering some of the older models.

Please contact us with your requirements.

Counter service or mail order. Discount for trade (and retail!).



QUICK FINDER

This section will help you quickly find the parts which are most frequently called for. Each part is then listed again under its appropriate section later in the catalogue.

OIL FILTER
ERR340



Filters

Oil filter;			
V8	(1)	ERR3340	
Td5	(1)	LPX100590	
Sump plug washer;			
V8	(1)	UAM2857	
Td5	(1)	CDU1001	
Air filter element - V8 & Td5;			
standard	(1)	ESR4238	
K&N	(1)	ESR4238K-N	
Fuel filter - Td5	(1)	ESR4686	
Oil strainer - ZF auto	(1)	RTC4653	
Oil seal - strainer - ZF auto	(1)	RTC4276	

AIR FILTER
ESR4238



FUEL FILTER
ESR4686



HEAD GASKET



Gaskets & Oil Seals

INDIVIDUAL GASKETS - TD5;

Cylinder head;			
1.20mm (2 holes)	(1)	LVB000240	
1.27mm (1 hole)	(1)	LVB000250	
1.35mm (3 holes)	(1)	LVB000260	
Camshaft cover	(1)	ERR7094	
Oil separator	(1)	ERR7155	
Oil cooler adaptor	(1)	ERR7220	
Oil filter housing	(1)	L VH100230	
Coolant elbow;			
up to eng. no. 10P86382A	(1)	ERR7032	
eng. no. 10P86383A on	(1)	LVJ000010	
Inlet manifold	(1)	LKJ000010	
Exhaust manifold;			
cylinder head to manifold	(1)	LKG100470	
manifold to turbo	(1)	ERR6768	
Sump	(1)	LVF500040	

ROCKER GASKETS
LVC100260

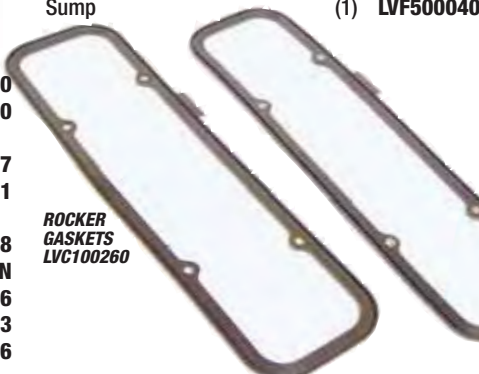

INDIVIDUAL GASKETS - V8;

Head gasket set	(1)	RA1233	
Head gasket only	(2)	LVB500030	
Sump gasket set	(1)	STC1639	
Sump gasket only	(1)	LVF100400	
Main bearing cap (rear)	(2)	611089A	
<i>Cruciform seal.</i>			
Timing cover gasket	(1)	ERR7280	
Water pump gasket	(1)	ERR4077	
Rocker cover gasket	(2)	LVC100260	
Inlet manifold gasket;			
to cylinder heads	(1)	ERR7306	
to inlet runners	(1)	ERR6621	
end seals	(2)	ERR7283	
Exhaust manifold;			
to cylinder heads	(4)	ERR6733	
to downpipes	(2)	ETC4524	

OIL SEALS

Oil seals;			
Td5			
crankshaft oil seal			
front	(1)	ERR5992	
rear	(1)	LUF100420	
camshaft oil seal			
front	(1)	LDI100030	
rear	(1)	ERR5369	
oil filler cap seal	(1)	LUD100040	
V8			
crankshaft oil seal			
front	(1)	ERR6490	
rear	(1)	ERR2640	
oil filter adaptor ('O'-ring)	(1)	ERR7308	
Oil seals/gaskets - transmission;			
sump gasket - automatic	(1)	RTC4268	
gasket kit - automatic	(1)	STC4449	
seal - input & output shaft	(1)	FTC4939	
<i>Transfer box.</i>			



PLUG LEAD SET
RA2001

Gasket Sets

Gasket set - V8;			
head gasket set	(1)	RA1233	
sump gasket set	(1)	STC1639	



COIL PACK ASSEMBLY
ERR6566

Ignition Components

Plug leads;			
vehicle set	(1)	RA2001	
individual leads			
no.1 cylinder	(1)	NGC103740	
no.2 cylinder	(1)	NGC103750	
no.3 cylinder	(1)	NGC103760	
no.4 cylinder	(1)	NGC103770	
no.5 cylinder	(1)	NGC103780	
no.6 cylinder	(1)	NGC103790	
no.7 cylinder	(1)	NGC103800	
no.8 cylinder	(1)	NGC103810	
Spark plug - V8	(8)	NLP100320	
Ignition coil pack - V8;			
coil and bracket assembly	(1)	ERR6566	
ignition coil only	(2)	ERR6045	
Heater (glow) plug - Td5	(5)	ERR6066	



Drivebelts

Drivebelt - ancillary components;		
Td5		
with ACE*		
air con	(1)	PQS101510
non air con	(1)	PQS101520
without ACE*		
air con	(1)	PQS101500
non air con	(1)	PQS101490
V8 (serpentine belt)		
with ACE*		
air con	(1)	ERR6896
non air con	(1)	ERR6897
without ACE*		
air con	(1)	ERR6898
non air con	(1)	ERR6899
Tensioner - drivebelt;		
Td5 (all models)	(1)	ERR6951
V8 (all models)	(1)	ERR6439
(*ACE = Active Cornering Enhancement)		

Cables

Accelerator cable	(1)	SBB500010
Handbrake cable;		
up to VIN XA224663	(1)	SPB101500
VIN XA224664 on	(1)	SPB000150
Bonnet release cable	(1)	FSE100600
Cruise control cable	(1)	SCD100070

MORE STOCK EVERY DAY

If the part you require is not listed here, please phone and enquire. By now we might well have it. For prices, terms & conditions etc, please refer to our latest price guide.

Engine/Transmission Sensors

Sensors - engine;		
Td5		
temperature		
inlet manifold	(1)	MHK100640
fuel connector block	(1)	ERR2081
coolant elbow	(1)	ERR2081
crank sensor	(1)	NSC100790
V8		
airflow sensor	(1)	ERR7171
seal - airflow sensor	(1)	PHN100200
crank sensor		
manual	(1)	ERR7352
automatic	(1)	ERR7354
knock sensor	(2)	NSC100650
temperature sensor	(1)	MEK100160
camshaft sensor	(1)	ERR6169
lambda sensor	(2)	MHK100920
Oil pressure switch;		
Td5	(1)	NUC10003
V8	(1)	STC4104
Transmission sensors/switches;		
reverse light switch		
manual	(1)	AMR3918
reverse	(1)	PRC2911
low ratio detect switch	(1)	IGM100000
Transfer box.		
temperature sensor - V8	(1)	PRC7984

DESCRIPTION QTY REQ. PART No.

In this section, we have listed only the components commonly required for servicing and reconditioning the 2.5TD engine. However, we have a comprehensive range of parts available. If you require a part which is not listed, please contact us for price and availability.

Td5 Diesel Engine

Genuine Land Rover Units.

Short engine <i>Exchange.</i>	(1)	LBB001200R
Stripped engine; <i>Exchange.</i>		
early (to 1A622423)	(1)	LBB001180R
late (2A622424 on)	(1)	LBB001190R

Cylinder Block Components - Td5 Engine

Core plate set - cylinder block	(1)	LL1081
Crankshaft assembly	(1)	ERR5291
Bush - crankshaft	(1)	8566L
Main bearings - engine set;		
standard size	(1)	STC3299
0.010" oversize	(1)	STC3299010
0.020" oversize	(1)	STC3299020
Thrust washer set (pair)	(2)	ERR5345
Piston;		
<i>Supplied individually, complete with rings, gudgeon pin and circlips.</i>		
up to VIN 1A736339	(5)	LFL000460
VIN 2A736340 on	(5)	LFL105300
Piston rings only (per piston);		
up to eng.no.10P13888B	(5)	LFT500040
eng.no.10P13889B up to		
VIN 1A736339	(5)	STC4668
VIN 2A736340 on	(5)	LFT500040
Jet - piston cooling	(5)	LFQ100310
Con rod	(5)	ERR6953
<i>Complete with small end bush and bolts.</i>		
Small end bush - conrod	(5)	ERR6978
Big end bearings - engine set;	(1)	STC3300
standard size	(1)	STC3300
0.010" oversize	(1)	STC3300010
0.020" oversize	(1)	STC3300020



INJECTOR ASSEMBLY
MSC000030

FUEL BLOCK
CONNECTOR ASSY
MSX000010

DESCRIPTION QTY REQ. PART No.



TIMING CHAIN KIT
LHA000030

Cylinder Head - Td5

Cylinder head, complete reconditioned;		
up to VIN 1A736339	(1)	LDF107860R
VIN 2A736340 on	(1)	LDF000890R
Gasket - cylinder head;		
1.20mm (2 holes)	(1)	LVB000240
1.27mm (1 hole)	(1)	LVB000250
1.35mm (3 holes)	(1)	LVB000260
Bolt - cylinder head	(12)	ERR5384
Injector and sensor assembly;		
to VIN 1A736339 (blue)	(5)	MSC000040
VIN 2A736340 on (green)	(5)	MSC000030
'O'-ring - injector (all)	(5)	ERR7004
Washer - injector (all)	(5)	ERR6417
Heater plug - ignition	(5)	ERR6066
Valve;		
inlet	(5)	ERR6611
exhaust	(5)	ERR6612
Valve guide	(10)	ERR7225
Oil seal - valve stem	(10)	LJQ100940
Valve seat;		
inlet	(10)	ERR7049
exhaust	(10)	ERR7050
Valve spring	(10)	LGL500050
Cap - valve spring	(10)	ERR6013
Collet - valve	(20)	ERR3907
Follower assembly - valve	(10)	ERR7234
Adjuster - valve lash	(10)	ERR7233
Rocker and arm assembly	(1)	MUI000040
<i>Without adjusting screws and nuts.</i>		
Adjusting screw - rocker arm;		
up to VIN 1A736339	(5)	ERR7065
VIN 2A736340 on	(5)	LGV000020
Nut - adjusting screw	(5)	ERR5529
Bolt - rocker shaft to cylinder head	(6)	LYG101510
Connector assembly - fuel block;		
up to eng. no. 10P15967B	(1)	MSX000010
eng. no. 10P15968B up to VIN 1A736340	(1)	MSX100080
VIN 2A736340 on	(1)	MSX000010
Gasket - fuel connector block;		
up to eng. no. 10P15967B	(1)	MSX100080
eng. no. 10P15968B on	(1)	MSX000010
Temp' sensor - fuel connector block	(1)	ERR2081
Washer - temperature sensor	(1)	ERR6192

Camshaft - Td5

Camshaft;		
up to VIN 1A622423	(1)	LGC000320L
VIN 2A622424 on	(1)	LGC000310
Follower - camshaft	(10)	ERR7234
Adjuster - lash	(10)	ERR7233
Seal - camshaft;		
front	(1)	LDI100030
rear	(1)	ERR5369

Timing Chain - Td5

Timing chain & sprocket kit <i>Includes crankshaft sprocket.</i>	(1)	LHA000030
Sprocket - crankshaft	Use	LHA000030
Tensioner - timing chain;		
up to VIN 1A736339	(1)	LHP000090
VIN 2A736340 on	(1)	LHP000080
Tensioner arm - timing chain	(1)	LGQ00020
Jet - chain lubrication	(1)	LNL100000
Oil pump chain & sprocket set	(1)	LQX100130

Oil Pump & Filter

Oil pump	(1)	LPF101250
Gasket - oil pump	(1)	LVG100340
Oil filter	(1)	LPX100590

Gaskets - Td5

Gasket;		
cylinder head		
1.20mm (2 holes)	(1)	LVB000240
1.27mm (1 hole)	(1)	LVB000250
1.35mm (3 holes)	(1)	LVB000260
camshaft cover	(1)	ERR7094
oil separator	(1)	ERR7155
oil cooler adaptor	(1)	ERR7220
oil filter housing	(1)	LVH100230
coolant elbow		
up to eng. 10P86382A	(1)	ERR7032
eng. 10P86383A on	(1)	LVJ000010
inlet manifold	(1)	LKJ000010
exhaust manifold		
cylinder head to manifold	(1)	LKG100470
manifold to turbo	(1)	ERR6768
sump	(1)	LVF500040
Washer - sump plug	(1)	CDU1001
'O'-ring - oil pick-up pipe	(1)	ERR6401
Oil seals - engine;		
crankshaft		
front	(1)	ERR5992
rear	(1)	LUF100420
camshaft oil seal		
front	(1)	LDI100030
rear	(1)	ERR5369
oil filler cap seal	(1)	LUD100040L

Miscellaneous Components - Td5

Turbocharger - <i>See page 21.</i>		
Bearing - cooling fan <i>Located in engine front cover.</i>	(1)	ERR5285
Circlip - cooling fan bearing	(1)	CR110625

PART NUMBERS: A 'P' suffix in the Price Guide denotes "Aftermarket".

V8 ENGINE UNITS

V8 ENGINE UNITS



LONG ENGINE

Long engine - Built-up block & cylinder heads assembly, including crank, rods & pistons, valves, guides & springs (less rocker gear), plus camshaft, followers & timing gear.

SHORT ENGINE

Short engine - Built-up block assembly, comprising crank, rods & pistons.

IMPORTANT NOTES - LONG ENGINES

Please note the following important points regarding engine assembly:

LONG ENGINE BUILD-UP

These engines are supplied less rocker gear, pushrods, sumps & timing covers. It is absolutely essential that these items are checked, cleaned and correctly assembled prior to running your engine.
 Check for wear on the underside of rocker shafts, on either side of the pedestals.
 Check for wear on the valve tips of rocker arms.
 Check pushrods for straightness and equal length.
 Clean the sump and oil pick-up pipe.
 Clean the timing cover and check the oil pump housing for wear and damage.
 Replace all seals and gaskets. If in any doubt, always replace with new components.

ANCILLARY COMPONENTS

If you are re-fitting ancillary components - water pump, alternator or fuel injection - check that they are suitable for re-using. We recommend having fuel injectors cleaned/replaced before re-fitting.
 The cooling system - including the radiator and heater - should be flushed through with clean water and the hoses checked before re-using.
 The correct ratio (minimum 33%) of antifreeze must be maintained at all times.
 Oil coolers should be flushed of old engine oil.
 Engine & gearbox mountings should be checked and renewed as necessary.
 The clutch operating system should be checked for wear.
 Rocker covers should be cleaned internally.
 Failure to observe these points may lead to engine damage and may also invalidate the engine's warranty.

V8 Factory - Long Engine

Factory assembled unit comprising, block, crank, rods, pistons, heads & camshaft. Less ancillaries. Please enquire for availability and detailed specification. Exchange.

- Long Engine - 4.0 litre (1) **ERR5012STRG**
- Installation kit (1) **RB8003**
 Inc. oil, filter, gaskets etc.

V8 Factory - Short Engine

Factory assembled unit comprising, block, crank, rods & pistons. Please enquire for availability and detailed specification. Exchange.

- Short Engine - 4.0 litre (1) **STC1891**

ROVER V8 ENGINE NUMBERS		
Engine Number	Application	Approximate Year
FACTORY 4.0 LITRE ENGINES		
42D00001A	S2 R.Rover4.0 efi HC	1994-2002
44D00001A	S2 R.Rover4.0 efi LC	1994-2002
55D00001A	Discovery SII 4.0 LC	1998-2004
56D00001A	Discovery SII 4.0 LC	1998-2004
57D00001A	S2 R.Rover4.0 efi LC	1998-2002
58D00001A	S2 R.Rover4.0 efi HC	1998-2002
69D00001A	Discovery SII 4.0 LC	1998-2004
70D00001A	Discovery SII 4.0 LC	1998-2004
71D00001A	Discovery SII 4.0 LC	1998-2004
72D00001A	Discovery SII 4.0 LC	1998-2004
85D00001A	Discovery SII 4.0 LC	1998-2004
86D00001A	Discovery SII 4.0 LC	1998-2004
87D00001A	Discovery SII 4.0 LC	1998-2004
88D00001A	Discovery SII 4.0 LC	1998-2004
89D00001A	Discovery SII 4.0 LC	1998-2004
90D00001A	Discovery SII 4.0 LC	1998-2004
91D00001A	Discovery SII 4.0 LC	1998-2004
92D00001A	S2 R.Rover Canada 4.0 efi LC	1998-2002
94D00001A	Discovery SII 4.0 LC	1998-2004
95D00001A	S2 R.Rover NAS 4.0 efi HC	1998-2002

IMPORTANT NOTES - SHORT ENGINES

Please note the following important points regarding engine assembly:

SHORT ENGINE BUILD-UP

When building up a short engine to a complete assembly, it is essential to thoroughly examine every part you intend to re-use. We recommend that you pay special attention to the camshaft, followers, pushrods & rocker gear, checking carefully for signs of wear; re-using worn parts is false economy and you risk contaminating your new engine with abrasive particles.
 The following parts **MUST** be meticulously cleaned prior to fitting:-
 sump & oil pick-up pipe
 timing cover & oil pump assembly
 cylinder heads
 rocker covers

Failure to observe these points may lead to engine damage and may invalidate the engine's warranty.

ANCILLARY COMPONENTS

If you are re-fitting ancillary components - water pump, alternator, or fuel injection - check that they are suitable for re-using. We recommend having fuel injectors cleaned/ replaced before re-fitting.
 The cooling system - including the radiator and heater - should be flushed through with clean water and the hoses checked before re-using.
 The correct ratio (minimum 33%) of antifreeze must be maintained at all times. Oil coolers should be flushed of old engine oil.
 Engine & gearbox mountings should be checked and renewed as necessary.
 The clutch operating system should be checked for wear.

ENGINE fitting SERVICE

We are pleased to be able to offer a fitting service for either our full or short engines. Please contact us for a quotation or to discuss your requirements.

OUR CHARGES ARE VERY REASONABLE!



V8 Gaskets & Oil Seals

Head gasket set	(1)	RA1233
Head gasket only	(2)	LVB500030
Sump gasket set	(1)	STC1639
Sump gasket only	(1)	LVF100400
Main bearing cap (rear) <i>Cruciform seal.</i>	(2)	611089A
Timing cover gasket	(1)	ERR7280
Water pump gasket	(1)	ERR4077
Rocker cover gasket	(2)	LVC100260
Inlet manifold gasket;		
to cylinder heads	(1)	ERR7306
to inlet runners	(1)	ERR6621
end seals	(2)	ERR7283
Exhaust manifold;		
to cylinder heads	(4)	ERR6733
to downpipes	(2)	ETC4524
Crank oil seal;		
front	(1)	ERR6490
rear	(1)	ERR2640
Oil filter adaptor 'O' ring	(1)	ERR7308

V8 Cylinder Head Bolts

Bolt - cylinder head (1995 onwards);
Note: These bolts can be identified by their flanged head. They do not need a separate washer and can be used on earlier engines. However, they are not re-useable and must be replaced once removed.

long (96mm)	(6)	ERR2944
medium (66mm)	(14)	ERR2943A

Cylinder head stud kit (1) RB7680
Engine set of ARP cylinder head studs, washers and nuts to replace original bolts. Studs improve cylinder head sealing & prevent damage to block threads.



**STUD KIT
RB7680**



MORE STOCK EVERY DAY

If the part you require is not listed here, please phone and enquire. By now we might well have it. For prices, terms & conditions etc, please refer to our latest price guide.



V8 Valves, Guides & Springs

Note: all parts supplied are suitable for unleaded applications.

Inlet valve;

- standard (8) **ERC9088A**
Head diameter: 40mm.
- 'big valve' (8) **RB7460**
Head diameter: 41.4mm. With waisted stem.
Machining required to valve guide and seat.

Exhaust valve;

- standard (8) **LGH000040**
Head diameter: 34mm.
- 'big valve' (8) **RB7461**
Head diameter: 35.5mm. With waisted stem.
Machining required to valve guide and seat.

Valve seat insert - inlet;

- standard size (8) **ERC224A**
- oversize + 0.010" (8) **ERC225A**

Valve seat insert - exhaust;

- standard (8) **ETC8596A**
- oversize + 0.010" (8) **ERC211A**

Valve guide - standard

- (16) **ERR3648**
For use with standard cam.
Stepped top, for use with neoprene seals (ERR1782) and matching valves.

Valve guide - performance;

- Shortened & bulleted, for use with performance cam.
Suitable for all valves.

- car set (inlet/exhaust) (1) **RB7453**
- individual inlet (8) **RB7463**
- exhaust (8) **RB7464**

Valve stem oil seal

- (16) **ERR1782**
Inlet & exhaust. Neoprene type.

Valve spring - standard

- (16) **UKC8137**

Valve spring - uprated - engine set;

- single (1) **RB7454**
Suitable for all engines with mild road camshaft. Uses standard retaining caps (ERC573).

Note: machining may be required to spring platform when fitting double valve springs to engines previously fitted with singles.

Retaining cap - valve springs;

- single valve springs (16) **ERC573A**
- uprated double valve springs(16) **ERC573S**
- Split cotter - all models (32) **ERC1637A**

V8 ROCKER GEAR

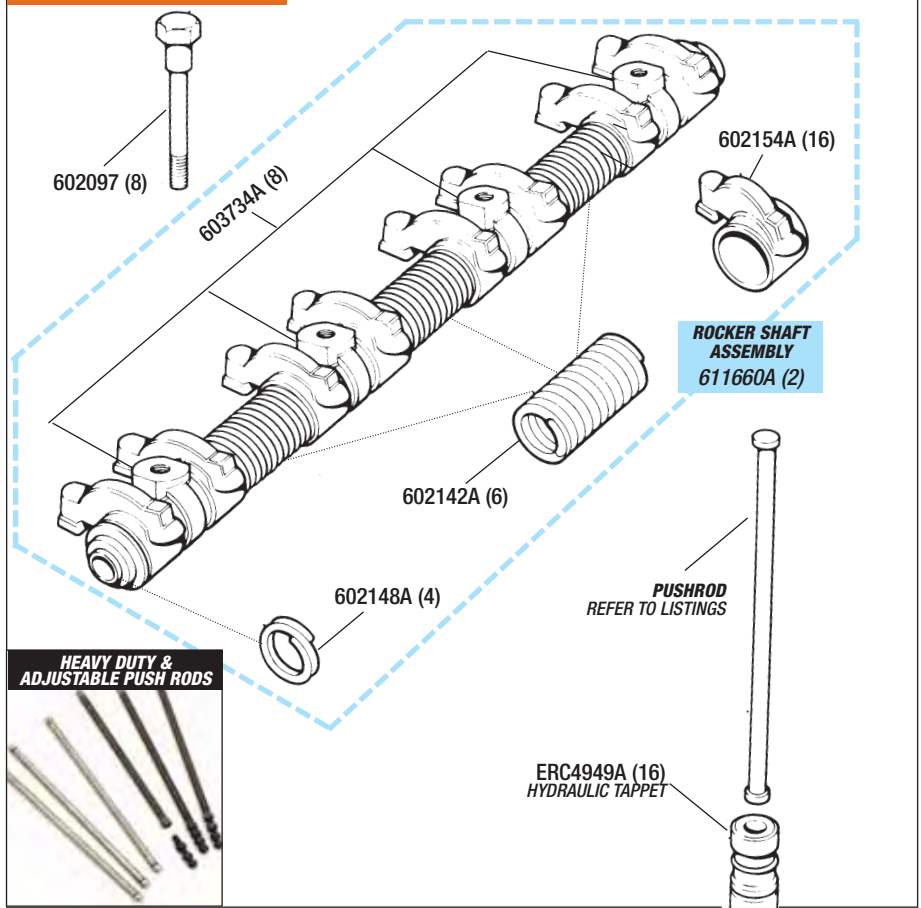

V8 Rocker Gear

- Rocker shaft assembly (2) **611660**
Assembled, ready to fit.
- Rocker build kit (2) **611660K**
Includes parts ready for assembly.
- Rocker shaft only (2) **606661**
- Pedestal - rocker shaft (8) **603734A**
- Pedestal shims (1) **603734SH**
Includes three sets of shims of different thickness. Use to set "lifter preload" when fitting a new cam with higher lift than standard. See also adjustable push rods, below.

Rocker arm;

- original spec (alloy)
- right hand (8) **602153**
- left hand (8) **602154**
- Spacer spring - rocker shaft (6) **602142A**
- End spring - rocker shaft (4) **602148A**
Wavy washer.
- End washer - rocker shaft (4) **602186A**
- Split pin - rocker shaft (4) **PC34**

Push rod;

- standard (16) **603378**
- heavy duty (16) **603378HD**
Larger diameter shaft. Cylinder head guide holes may need enlarging accordingly.
- adjustable (engine set) (1) **603378ADJ**
Set of pushrods, adjustable for length at the rocker end, allowing the lifter preload to be precisely set without shims.



V8 ROCKER GEAR

WHAT IS LIFTER PRELOAD?

"Lifter preload" refers to the position of the pushrod seat in the lifter (cam follower) when the engine has been assembled and the lifter is positioned on the heel of the cam. Lifter preload must be checked whenever a non-standard component which alters the distance between the rocker arm and the lifter - such as a high lift camshaft or performance cylinder head - has been fitted. Incorrect lifter preload will cause poor running, premature wear or, at worst, engine failure.

Check the lifter preload as follows:

With the lifters empty of oil, assemble the rocker shaft & pushrod components, making sure there is no wear in the rocker shafts, rocker arms & pushrods.

Checking each lifter in turn, positioned on the heel of the cam, measure the gap between the pushrod seat and the bottom of the circlip groove. There must be a clearance of .020" minimum and .060" maximum at this position.

If the clearance is greater than .060", use pedestal shims (603734SH) to decrease. Remember to use equal thickness shims under each pedestal of a shaft to avoid distortion or breakage.

**POWDER COATED
ROCKER
COVERS**



V8 Rocker Covers

Rocker covers - single;		
rh	(1)	LDR000210
lh	(1)	LDR000200
Rocker covers - pairs;		
unpainted	(1)	RB7431
powder coated		
black	(1)	RB7431PCB
red	(1)	RB7431PCR
Gasket - rocker cover (rubber)	(2)	LVC100260
Screw - rocker cover retaining;		
long	(4)	ERR2944
short	(4)	ERR2943A
Rocker cover 'T'-Bolts - chrome	(2)	RB7440
<i>American style rocker cover hold down bolts, supplied in sets of 4 (2 sets req'd).</i>		
Breather/flame trap;		
<i>Right hand rocker cover, where fitted.</i>		
standard	(1)	RB7432
powder coated		
black	(1)	RB7432PCB
red	(1)	RB7432PCR
chrome	(1)	RB7432C
Breather grommet (pair)	(1)	RB7432ZG
'O' ring/seal-flame trap	(1)	564258A
Oil filler neck	(1)	ERR7335
Gasket - filler neck	(1)	564258A
Oil filler cap	(1)	ERR5218
'O' ring/seal - filler cap	(1)	ERR5219
Breather filter	(1)	ERC3209A
<i>Rear of LH rocker cover.</i>		
Cap - breather filter	(1)	ERC3208A
Plug lead retainer (where fitted)	(2)	603672A
<i>Holds 4 leads.</i>		

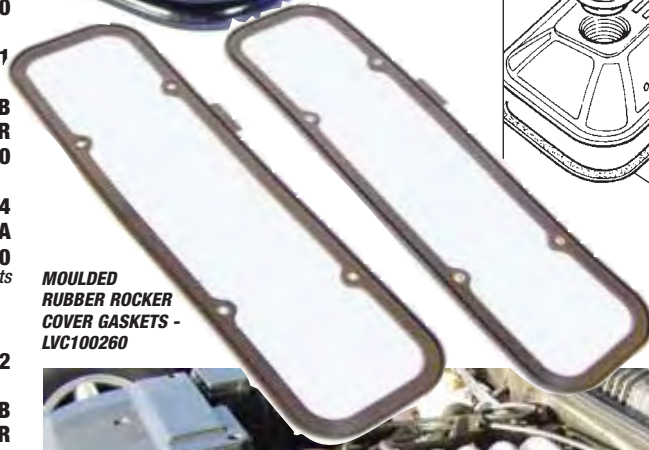

**MOULDED
RUBBER ROCKER
COVER GASKETS -
LVC100260**

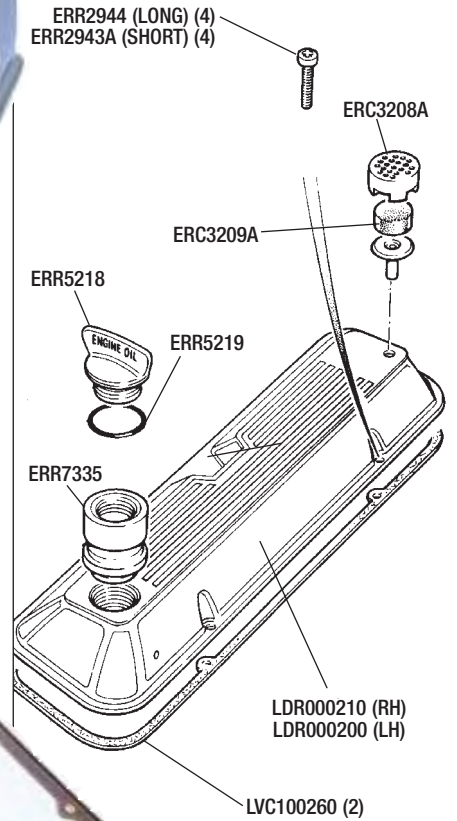

ROCKER COVER



V8 Camshaft Components

Camshaft - standard - 4.0 litre	(1)	ERR3720
Up-rated camshaft kit	(1)	RA2015
<i>Suitable for 4.0 litre engine - no modifications necessary to the fuelling. Driveability is improved, along with a noticeable increase in low-end torque over the standard camshaft. Kit contains up-rated camshaft, new followers, timing chain and sprockets, plus gaskets.</i>		
Collar - camshaft retaining	(1)	ERR2609
Cam follower;		
each	(16)	ERC4949A
set of 16	(1)	ERC4949K
Cam lube	(1)	RX1358
Gasket - inlet manifold;		
to cylinder heads	(1)	ERR7306
to inlet runners	(1)	ERR6621
End seal for gasket	(2)	ERR7283
Clamp for seal	(2)	ERR7282
Screw for clamp	(2)	602236



**STANDARD CAMSHAFT - ERR3720
AND COLLAR - ERR2609**

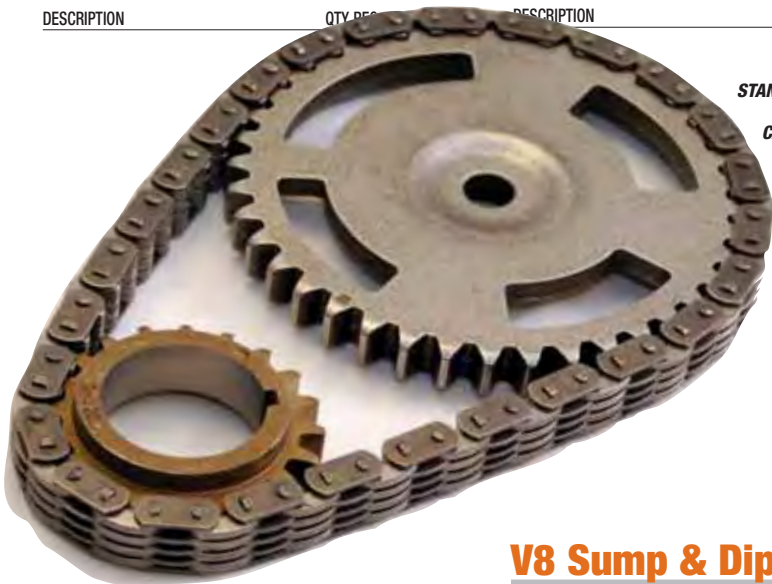

STANDARD TIMING CHAIN - ERC7929A
CAMSHAFT SPROCKET - ERR5086
CRANK SPROCKET - 90602372

V8 Gaskets & Oil Seals

Head gasket set	(1)	RA1233
Head gasket only	(2)	LVB500030
Sump gasket set	(1)	STC1639
Sump gasket only	(1)	LVF100400
Main bearing cap (rear) <i>Cruciform seal.</i>	(2)	611089A
Timing cover gasket	(1)	ERR7280
Water pump gasket	(1)	ERR4077
Rocker cover gasket	(2)	LVC100260
Inlet manifold gasket;		
to cylinder heads	(1)	ERR7306
to inlet runners	(1)	ERR6621
end seals	(2)	ERR7283
Exhaust manifold;		
to cylinder heads	(4)	ERR6733
to downpipes	(2)	ETC4524
Crank oil seal;		
front	(1)	ERR6490
rear	(1)	ERR2640
Oil filter adaptor 'O' ring	(1)	ERR7308

Crank Pulley, Flywheel & Auto Drive Plate

Please enquire for price and availability quoting vin number & engine number.

V8 Timing Chain

Timing chain;		
standard	(1)	ERC7929A
adjustable kit	(1)	RB7449
<i>Includes vernier camshaft sprocket and double roller chain. Also includes timing protractor and Allen key. Fully adjustable cam sprocket allows extremely accurate cam timing whilst eliminating stretch. Instructions included.</i>		
Replacement chain (adjustable kit) -		
double roller	(1)	RB7450
Camshaft sprocket - standard	(1)	ERR7375
Thrust plate - cam	(1)	ERR2609
Cam retaining collar	(1)	ERR5926
Screw - thrust plate	(2)	SH505061
Woodruff key	(1)	ERC2838A

V8 Sump & Dipstick

Sump pan	(1)	LSB102810
Sump gasket set	(1)	STC1639
Sump gasket only	(1)	LVF100400
Drain plug - sump	(1)	LSF100040L
Washer - drain plug	(1)	UAM2857
Oil pick-up strainer/pipe	(1)	ERR4795
Dipstick	(1)	LQM100920
Tube - dipstick	(1)	ERR4550

V8 Crankshaft

Crankshaft (<i>New less bearings</i>);		
4.0 litre	(1)	ERR5090
Main bearings;		
standard size	(1)	STC1425
oversize + 0.10"	(1)	STC1425.010
oversize + 0.20"	(1)	STC1425.020
Main bearing set - standard	(1)	STC4299
Bolt - main bearing cap	(10)	602130A
Spigot bush - crankshaft	(1)	549911
Woodruff key - crankshaft	(1)	ERR2846
Sprocket - crankshaft	(1)	90602372A

V8 Timing Cover & Fittings

Timing cover (<i>fitted with oil pump rotors</i>);		
up to VIN XA231750	(1)	ERR6438
VIN XA231751on	(1)	LJR105040
Oil pump rotors	(1)	RA2016
<i>Replacement rotors (inner and outer) for the crank-driven oil pump inside the timing cover.</i>		
Gasket - timing cover	(1)	ERR7280
Oil seal - front crankshaft	(1)	ERR6490
Oil pressure switch	(1)	STC4104
Adaptor - oil filter	(1)	LPY000010
'O'-ring seal - oil filter adaptor	(1)	ERR7308



V8 PISTON, COMPLETE WITH PIN & RINGS

V8 Cylinder Block & Components

Cylinder block - V8	(1)	LCF104560
<i>4.0 litre engine. Supplied with main bearing caps, cam bearings, core plugs and liners. Less crankshaft, pistons etc.</i>		
Core plug set - block	(1)	RB7105
Cam bearing set	(1)	STC1961
Crankshaft oil seal;		
front	(1)	ERR6490
rear	(1)	ERR2640
Bolt - main bearing cap	(10)	602130A
Cross-bolt - mains cap	(9)	FB110137
Hex bolt - mains cap	(1)	SS110555
Oil seal - mains cap bolt;		
for FB110137	(9)	ERR3330
for SS110555	(1)	ERR3331
Crank sensor housing - block	(1)	ERR3693

V8 Pistons & Con Rods

Piston - single - standard ;		
<i>4.0 litre. Includes rings. For oversize pistons, see Piston Set.</i>		
8.13:1cr	(8)	ERR5555
9.35:1cr	(8)	ERR5553
Piston set - oversize +0.20"	(1)	RA2017
<i>4.0 litre. Set of 8 oversize pistons with rings.</i>		
Piston ring set - standard	(1)	STC1427
Con rod (4.0 litre)	(8)	ERR4837
Bolt - con rod	(16)	ERR1772
Big end bearing set;		
standard	(1)	STC1426
oversize + 0.10"	(1)	STC1426.010
oversize + 0.20"	(1)	STC1426.020



**TD5 WATER PUMP
PEM500040**



Water Pump

Water pump;	
Td5	(1) PEM500040
V8	(1) STC4378
Seal - water pump - Td5;	
'D'-ring seals (Set of 3)	(1) PFQ10001L
water pump to PAS bracket	(1) ERR6711
Gasket - water pump - V8	(1) ERR4077
Cover - water pump - Td5	(1) ERR7047

Drive Belts

Drivebelt - ancillary components;	
Td5	
with ACE*	
air con	(1) PQS101510
non air con	(1) PQS101520
without ACE*	
air con	(1) PQS101500
non air con	(1) PQS101490
V8 (serpentine belt)	
with ACE*	
air con	(1) ERR6896
non air con	(1) ERR6897
without ACE*	
air con	(1) ERR6898
non air con	(1) ERR6899
Tensioner - drivebelt;	
Td5 (all models)	(1) ERR6951
V8 (all models)	(1) ERR6439

(*ACE = Active Cornering Enhancement)



**TD5 EXPANSION
TANK
PCF101420
AND
PRESSURE CAP
PCD000070**

Expansion Tank

Expansion tank - cooling system;	
Td5	(1) PCF101420
V8	(1) ESR2935
Pressure cap - expansion tank	(1) PCD000070
Td5 & V8.	



**TD5 RADIATOR
PCC000640**

Radiator & Oil Cooler

Radiator;	
Td5	
up to VIN 1A736339	(1) PCC000640
VIN 2A736340 on	(1) PKK000080
V8	(1) PCC000650
Mounting rubber - radiator	(2) ESR3586
Td5 & V8.	
Oil cooler;	
Td5 - transmission	
auto	(1) PFZ100020
manual	(1) PFZ100000
V8	
engine	(2) ESR3592
transmission	(1) PFZ100010
Switch - oil temperature	(1) UBI100030
Td5 & V8, oil cooler.	



**UPDATED INTERCOOLER
RA1466**

Intercooler - Diesel

Intercooler - Td5;	
standard	(1) PCM100220
updated	(1) PCM100220UR
<i>Larger capacity performance intercoolers are designed to offer an improvement in power & torque over the standard factory item.</i>	
<i>The larger swept volume of this unit allows a cooler and denser charge of air into the engine, which in turn produces a more efficient combustion, resulting in more torque and power than with the standard factory item.</i>	
<i>NB., when fitting an updated intercooler to Td5 engines, it is essential to fit a modified performance engine management unit, such as the Rimmer Bros Powerbox. See Accessories section.</i>	
Intercooler hoses;	
Td5	
intercooler to inlet manifold	(1) ESR4640
intercooler to rigid pipe	(1) PNH102101
turbo to rigid pipe	(1) PNH102101
Clip for intercooler hoses - Td5;	
intercooler to rigid pipe	(a/r) CN100908
rigid pipe to turbo	(a/r) PYC102340
Intercooler to inlet manifold	
intercooler end	(1) PYC102350
inlet manifold end	(1) PYC102360

Radiator Hoses

Top hose - radiator;	
Td5	(1) PEH101080
V8	
<i>Hose set, includes T-piece and thermostat hoses plus clips.</i>	
up to VIN YA241594	(1) PCH115360
VIN YA241595	(1) PCH000460
Bleed screw - top hose	(1) PYP10008L
Td5 & V8.	
Bottom hose - radiator;	
To thermostat.	
Td5	(1) PEH101120
V8	(1) PCH119020
Other coolant hoses;	
Td5	
thermostat to rigid coolant pipe	
large bore	(1) PEH101110
small bore	(1) PEH101070
coolant pipe to water pump	(1) PEH101660
V8	
thermostat to water pump	(1) PEH000080
thermostat to T-piece	use PCH000460
engine to T-piece	use PCH000460
T-piece - V8	use PCH000460
Coolant pipe - rigid - Td5	(1) PFV100120
Thermostat to water pump.	
Heater hoses - see Heater Components , next page.	

Hose Clips

Spring band clips - coolant hoses;	
Td5	
top hose	
to radiator	(1) PYC102100
to engine	(1) PYC102110
bottom hose	
to radiator	(1) PYC102110
to thermostat	(1) PYC102100
thermostat	
to large rigid pipe	(1) PYC102100
to small rigid pipe	(2) PYC102090
V8	
top hose	
to radiator	(1) PYC102100
to T-piece	(1) PYC102210
bottom hose - both	(2) PYC102100
thermostat	
to large hose	(1) PYC102100
to small hose	(1) PYC102090
hose to water pump	(1) PYC101900
T-piece	(3) PYC102210
small clips	
22mm	(a/r) PYC102190
23mm	(a/r) PYC102010

DESCRIPTION QTY REQ. PART No.



Thermostat

Thermostat - all models (1) **PEM100990**

Cooling Fan

Cooling fan;
Td5 (1) **PGG101050**
V8 (1) **ERR4959**
Viscous coupling - V8 (1) **ERR4995**

Heater Components

Heater assembly
For price & availability of complete heater assemblies, please contact our sales department.

Heater core kit - all vehicles (1) **STC3135**
Blend motor assembly;
RH lower (1) **JW0100000**
RH upper (1) **JW0100020**
LH (1) **JW0100010**

Blower motor - *please contact our sales department.*
Control assembly - heater (1) **AWR7155**
Slider knob - heater control (1) **BTR6494**
Rotary knob - heater (3) **BTR8930**
Switch - push/push (1) **STC1863**
Bulb - switch illumination (a/r) **JWH100070**

Heater hoses;
Td5
inlet (to matrix) (1) **JHB000060**
outlet (from matrix) (1) **JHC100460**
V8 - inlet/outlet combined (1) **PCH500040**

Clips - heater hoses;
TD5
white (2) **JYC100860**
blue (2) **PYC102030**
V8
white (2) **JYC100860**
green (2) **JYC100870**

DESCRIPTION QTY REQ. PART No.

Air Conditioning Components

Listed below are the principle air conditioning components. If the part you require is not listed, please contact our sales department, remembering to have details of your VIN/chassis number to hand.

Compressor - air conditioning (1) **JPB101330**
Td5 & V8 models.
'O'-ring seal - compressor connections;
suction (1) **STC3176**
discharge (1) **STC3177**
Condenser assembly (1) **JRB100840**
Includes condenser, receiver dryer (R134a refrigerant) and fan.
Condenser only (1) **JRB100790**
Receiver drier (1) **JRJ100550**
Fan - air conditioning (1) **JRP100060**
Pressure switch (1) **JRY100000**
Thermistor - evaporator (1) **JOF100020**
Ambient sensor - airbox - Td5 (1) **MHK100600**
Air conditioning.
Ambient sensor - front of car (1) **JTF100160**
Sensor - in-car temperature (1) **JTF100290**
Solar sensor - dashboard (1) **JTF100190**
Control assembly - air conditioning (1) **JTF500040**
Bulb - control illumination (a/r) **JWH100060**
Bulb & holder;
orange (a/r) **STC1877**
green (a/r) **STC1878**

Antifreeze

Antifreeze;
all engines *except* Td5
1 litre (1) **GAC2018**
5 litres (1) **GAC2019**
Td5 only
1 litre (1) **STC50529**
5 litres (1) **STC50530**

Miscellaneous

Gasket - coolant elbow (1) **LVJ000010**
Temperature sensor - elbow (1) **ERR2081**
Washer - temperature sensor (1) **ERR6192**

DESCRIPTION QTY REQ. PART No.



A MUST FOR ALL OWNERS

RADIATOR RELIEF

COOLING SYSTEM ADDITIVE

Radiator relief allows your radiator to transfer heat more efficiently, reducing your engines operating temperature (which is obviously controlled by the thermostat) by up to 30°F. You therefore have 'a little bit in hand' for those hot days stuck in traffic. This proven coolant additive will also cut engine warm-up time in half which will reduce engine wear which is most extreme when the engine is cold. Fully compatible with water and anti-freeze and is safe with cast iron and all alloys.

- 30°F lower operating temperature
- 50% quicker warm up time
- Safe with water/antifreeze mixture
- Safe with cast iron, alloy engines and heads
- Increased engine life!
- 100% biodegradable, non corrosive, non toxic
- For use in all water cooled engines

RADIATOR RELIEF (946ml) (1) **RX1461**
Treats 1 engine.



Sensors - Fuel System - Td5

Temperature sensor - inlet manifold	(1)	MHK100640
Airflow sensor	(1)	MHK100620
Seal - airflow sensor	(1)	PHN100200
Ambient sensor - airbox <i>Air conditioning.</i>	(1)	MHK100600

V8 THROTTLE POTENTIOMETER ERR7322



Sensors - Fuel System - V8

Efi sensors - V8;		
throttle body assembly	(1)	MHB000240
gasket - throttle body	(1)	ERR6623
potentiometer - throttle	(1)	ERR7322
actuator - idle speed control	(1)	ERR6078
airflow sensor	(1)	ERR7171
seal - airflow sensor	(1)	PHN100200
lambda sensor	(2)	MHK100920
camshaft sensor	(1)	ERR6169
crank sensor		
manual	(1)	ERR7352
automatic	(1)	ERR7354
knock sensor	(2)	NSC100650
temperature sensor	(1)	MEK100160
Fuel injector - efi	(8)	ERR6600
'O' ring	(16)	ERR7309

Air Filter

Air filter element - Td5 & V8;		
standard	(1)	ESR4238
K&N	(1)	ESR4238K-N
Seal - airbox to engine <i>Td5 & V8.</i>	(1)	PHN100210

Fuel Filter

Fuel filter element - Td5	(1)	ESR4686
Water sensor - filter element - Td5	(1)	WKW500070

Emissions Systems

Charcoal cannister	(1)	WTB000100
EGR valve - Td5	(1)	WAV100270
Gasket - EGR valve	(1)	ERR6620
Seal - EGR valve to pipe	(1)	WAL100240
Solenoid valve - EGR	(1)	MSG100110
Filter - solenoid valve - EGR	(1)	ESR4323

Fuel Tank

Fuel tank;		
Td5	(1)	ESR4672
V8		
up to VIN 1A736339	(1)	ESR4676
VIN 2A736340	(1)	WHK000090
Cradle - fuel tank support <i>Td5 & V8.</i>	(1)	WFI100090

Td5 FUEL PUMP WFX000280



Fuel Pump

Fuel pump;		
<i>In-tank, includes level sender.</i>		
Td5	(1)	WFX000280
V8	(1)	WFX101060
Gasket - fuel pump <i>(Td5 & V8)</i>	(1)	ESR3806A
Locking ring - fuel pump <i>Td5 & V8</i>	(1)	ESR3808

Fuel Filler Cap

Filler cap;		
up to VIN XA227049	(1)	WLD100600
VIN XA227050 on	(1)	WLD100770
Grommet - fuel filler cap	(1)	NTC591

Td5 Accelerator Pedal

Acc' pedal & potentiometer	(1)	SLC000020PMA
----------------------------	-----	---------------------

Accelerator Cable

Accelerator cable	(1)	SBB103820
-------------------	-----	------------------

Diesel Injectors

Injector and sensor assembly;		
to VIN 1A736339 (blue)	(5)	MSC000040
VIN 2A736340 on (green)	(5)	MSC000030
'O'-ring - injector (all)	(5)	ERR7004
Washer - injector (all)	(5)	ERR6417

Cruise Control

Cable - cruise control	(1)	SCD100070
Vacuum hose - cruise control	(1)	SCH100170
Switch - dashboard <i>Cruise control enable/disable.</i>	(1)	YUH100370
Actuator - cruise control;		
small	(1)	ETC7150
large	(1)	SCC100030L
ECU - cruise control	(1)	AMR5700
Stop lamp switch	(1)	XKB000010

Td5 ACCELERATOR PEDAL



Miscellaneous Components - Fuel

Cooler assembly - fuel (Td5)	(1)	PIB000060
------------------------------	-----	------------------



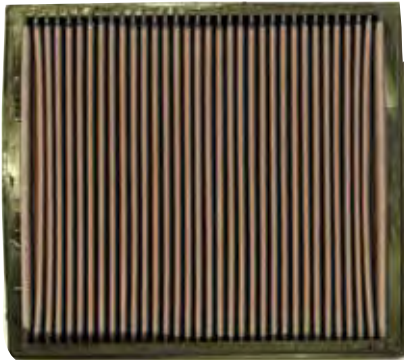

K&N REPLACEMENT FILTER FOR STANDARD ELEMENT

Air Filter - K&N

Air filter - K&N (1) **ESR4238K-N**
Td5 & V8.
K&N offer superior filtration, an improvement in air flow and many times longer life than standard elements. Plus, they can be cleaned and re-used.
Suitable for all models, they require no alterations to the fuel system on a standard engine (with standard exhaust).
K&N filters are proven in both competition and off-road environments.

Cleaning fluid (1 litre)	(1)	RX1346
<i>For cleaning K&N filter elements.</i>		
Element oil:		
<i>For re-oiling K&N elements.</i>		
1fl oz	(1)	RX1347
25ml bottle	(1)	RX1348
400ml bottle	(1)	RX1349

DESCRIPTION QTY REQ. PART No.

Turbocharger - Td5

Turbocharger - Td5	(1)	PMF500040
Gasket - manifold to turbo Stud;	(1)	ERR6768
turbo to downpipe manifold to turbo	(3)	UAM2368
	(3)	ERR551L
Wastegate control unit - turbo	(1)	PMK100130
Hose - wastegate (vacuum)	(1)	PNH101570
Pipe - turbo;		
oil feed to turbo	(1)	PNP101280
oil drain from turbo	(1)	PNH101840
Washer - oil feed pipe to turbo	(2)	ADU6847
Gasket - oil drain pipe to turbo	(1)	PNT100030

DESCRIPTION QTY REQ. PART No. DESCRIPTION QTY REQ. PART No.



STANDARD EXHAUSTS - FULL SYSTEMS

Full System - inc Catalyst Standard - Mild & Stainless Steel

See also: **Part Systems less Catalyst and Individual System Components.**
In the Price Guide, the RD part number for a system will have an MS suffix (for mild steel) or SS (for stainless steel).

Full system - Td5 diesel;		
<i>Includes downpipe/catalyst (if fitted), centre silencer & tailpipe.</i>		
non-cat		
mild or stainless steel	(1)	RD1194
fitting kit	(1)	RD1194FK
with cat		
mild or stainless steel	(1)	RD1195
fitting kit	(1)	RD1194FK

Full system - V8;		
<i>Includes downpipe/catalyst (if fitted), centre silencer & tailpipe.</i>		
non-cat		
mild or stainless steel	(1)	RD1196
fitting kit	(1)	RD1196FK
with cat		
mild or stainless steel	(1)	RD1197
fitting kit	(1)	RD1196FK



TD5 FULL EXHAUST SYSTEM IN MILD STEEL - RD1194MS



V8 FULL EXHAUST SYSTEM IN MILD STEEL - RD1197MS

STANDARD & SPORTS EXHAUSTS - PART SYSTEMS

Part System - exc Catalyst Standard & Sport - Mild & Stainless Steel

See also: **Full Systems including Catalyst and Individual System Components.**
In the Price Guide, the RD part number for a system will have an MS suffix (for mild steel) or SS (for stainless steel).

Part system (downpipe/cat back);
Comprises centre silencer (or link pipe) & tailpipe. Excludes downpipe or catalyst.

Td5 - standard		
stainless steel	(1)	RD1198
fitting kit	(1)	RD1198FK

Td5 - sports		
<i>Centre silencer is replaced by link pipe. Tailpipe has 3" rolled end finish.</i>		
stainless steel	(1)	RD1198SSSPORT
fitting kit	(1)	RD1198FK

V8 - standard		
stainless steel	(1)	RD1199
fitting kit	(1)	RD1199FK

V8 - sports		
<i>Centre silencer is replaced by link pipe, producing noisier exhaust. Tailpipe has 3" rolled end finish.</i>		
stainless steel	(1)	RD1199SSSPORT
fitting kit	(1)	RD1199FK



TD5 (STANDARD) CAT BACK EXHAUST SYSTEM IN STAINLESS STEEL - RD1198SS



TD5 (SPORTS) CAT BACK EXHAUST SYSTEM IN STAINLESS STEEL WITH LINK PIPE TO REPLACE CENTRE SILENCER - RD1198SSSPORT

FITTING KITS
Fitting kits include gaskets, sealing rings, 'U' bolts, mounting rubbers, nuts & bolts (as necessary) to assemble the systems using original hanger points. Mounting brackets and special support components are not included.

ORDER ON: 01522 568000 / www.rimmerbros.co.uk

PART NUMBERS: A 'P' suffix in the Price Guide denotes "Aftermarket".

INDIVIDUAL SYSTEM COMPONENTS

Individual System Components Standard - Mild & Stainless Steel

This section lists individual exhaust components in both mild steel and stainless steel. Use it to select the appropriate parts if you are not replacing the whole system.

See also: **Full Systems** including Catalysts and **Part Systems** excluding Catalysts

System Components - Td5;		
manifold - exhaust	(1)	LKC102020
downpipe		
non-cat	(1)	WCD106210
<i>Up to VIN 1A736339.</i>		
with catalyst	(1)	WCD000500
<i>VIN 2A736340 on.</i>		
centre silencer		
mild steel	(1)	WDE100590
stainless steel	(1)	WDE100590SS
link pipe only		
<i>Replaces centre silencer</i>		
stainless steel	(1)	WDE100590SSP
rear silencer/tailpipe		
mild steel	(1)	WDE100660
stainless steel	(1)	WDE100660SS

System Components - V8;		
manifold - exhaust		
rh	(1)	ERR7394
lh	(1)	ERR7393
downpipe/Y-pipe		
with catalysts	(1)	WCD001220
non-catalyst	(1)	WCD105900
centre silencer		
mild steel	(1)	WCE104642
stainless steel	(1)	WCE104642SS
link pipe only		
<i>Replaces centre silencer</i>		
stainless steel	(1)	WCE104642SSP
rear silencer/tailpipe		
mild steel	(1)	WDE100650
stainless steel	(1)	WDE100650SS



TD5 REAR
SILENCER/TAILOPIPE
WDE100660



TD5 CENTRE
SILENCER
WDE100590

TD5 DOWNPIPE
NON-CAT
WCD106210



TD5 LINK PIPE
WDE100590SSP



V8 CENTRE
SILENCER
WCE104642



V8 REAR SILENCER/TAILOPIPE
WDE100650

Gaskets & Fittings

Gasket - exhaust;		
manifold to head		
Td5	(1)	LKG100470
V8	(4)	ERR6733
manifold to exhaust		
Td5		
to turbo	(1)	ESR6768
turbo to exhaust	(1)	ESR3737
V8	(2)	ETC4524

Fasteners - exhaust manifold to cylinder head;		
Td5		
stud	(10)	TE108051L
nut	(10)	ESR2033
V8		
flanged screw	(16)	ERR6734
spacer	(16)	ERR6318

Nut - manifold to downpipe;		
Td5	(3)	ESR2034
V8	(6)	ETC7184
Lambda sensor - V8		
Gasket - centre to rear sections	(1)	ESR3737
<i>Td5 & V8.</i>		
Nut - centre to rear sections	(3)	NV110041
<i>Td5 & V8.</i>		
Rubber hanger - exhaust	(a/r)	ESR3172
<i>Td5 & V8.</i>		
Exhaust jointing compound	(1)	GCH112



V8 DOWNPIPE/Y-PIPE
WITH CATALYSTS
WCD001220



V8 LAMBDA SENSOR
MHK100920



RUBBER
HANGER
ESR3172

JOINTING
COMPOUND
GCH112

DESCRIPTION QTY REQ. PART No. DESCRIPTION QTY REQ. PART No. DESCRIPTION QTY REQ. PART No.



REVERSE LIGHT SWITCH
AMR3918

AUTO GEAR KNOB
UCK100230PMA



PARKING BRAKE
SHOES
ICW500010

Manual Gearbox

Gearbox assembly;

- Td5 (1) **TRC103350**
- V8 (1) **TRC103270**
- Gaskets & seals - manual gearbox;
 - washer - drain plug (1) **FTC4112**
 - oil seal - front extension (1) **FTC500010**
 - oil seal - primary (input) shaft (1) **FTC5303**
- Bearing - input shaft (1) **TZZ100190**
- Oil pump - transmission (1) **FTC4206**
- 'O'-ring - oil pump seal (1) **BZV1051**
- Oil strainer (1) **FRC7855**
- Reverse light switch (1) **AMR3918**
- Seal - reverse light switch (1) **ALU1403L**
- Gaiter - selector housing (1) **FTC5252**
- Gear knob - black (1) **UKJ500090PMA**

GEAR KNOB
UKJ500090PMA



Automatic Gearbox

Gearbox assembly - automatic;
diesel

- up to VIN 1A736339 (1) **TGD101510**
- VIN 2A736340 on (1) **TGD000220**
- petrol (1) **TGD101360**
- Torque converter;
 - diesel (1) **TQB000040**
 - petrol (1) **TQB500020**
- Gaskets & seals - individual - auto gearbox;
 - gasket - front housing (1) **RTC4320**
 - gasket - gearbox sump (1) **RTC4268**
 - washer - sump drain plug (1) **STC1060**
 - seal - oil pump housing (1) **RTC5102**
 - 'O'-ring - oil pump housing (1) **RTC5103**
 - 'O'-ring - oil strainer (1) **RTC4276**
 - gasket - rear extension (1) **RTC4295**
 - seal - output shaft (1) **RTC4650**
- Gasket kit - gearbox overhaul (1) **STC4449**
- Oil pump - transmission (1) **STC1836**
- Strainer - transmission fluid (1) **RTC4653**
- Switch assembly - auto gearbox (1) **UHB100190**
- Valve block assembly;
 - diesel
 - up to VIN 1A736339 (1) **THD100360**
 - VIN 2A736340 on (1) **THD000010**
 - petrol (1) **THD100390**
- Bearing kit - auto transmission (1) **RTC5101**
- Speed transducer - auto (1) **STC4444**
- Gear knob - auto - black (1) **UCK100230PMA**



Transfer Gearbox

- Gearbox assembly - transfer (1) **IAB100060**
- Differential assembly - transfer box (1) **FTC5013**
- Switch;
 - low ratio detect (1) **IGM100000**
 - temperature sensor (V8) (1) **PRC7984**
 - reverse lamp (1) **PRC2911**
- Washer - temp' sensor switch (1) **ALU1403L**
- Solenoid - gearchange lock (1) **FTC3283**
- Seal kit - output shaft;
 - front (1) **STC4379**
Includes: oil seal, mudshield, output flange, circlip, washer & nut plus 4 x propshaft bolts.
 - rear (1) **STC3433**
Includes: oil seal, mudshield, output flange, washer & nut.
- Seal only - output shaft (2) **FTC4939**
Front & rear.
- Bearing - output shaft (2) **STC1130**
Front and rear.
- Cable - gearchange (1) **FTC4772**
- Gear knob - transfer - black (1) **AWR4900PMA**

Parking Brake

- Drum - parking brake;
 - diesel (silver) (1) **SDC100200**
 - petrol (black) (1) **FRC3502**
- Shoes - parking brake (set) (1) **ICW500010**
- Brake shoe retention kit (1) **ICW100050**
- Brake adjuster kit (1) **ICW500020**
- Cable - handbrake;
 - up to VIN XA224663 (1) **SPB101500**
 - VIN XA224664 on (1) **SPB000150**
- Lever - handbrake;
 - up to VIN XA224663 (1) **SNB100350PMA**
 - VIN XA224664 on (1) **SNB100501PMA**
- Switch - handbrake (1) **CLP8699L**
- Knob - handbrake adjusting (1) **NTC5009**



GEAR
SELECTOR BEZEL
AWR3700PMA

Gear Lever Surround

- Bezel - gear selector - automatic (1) **AWR3700PMA**
- Gaiter - outer - manual;
 - main gear lever
 - for wood trim (1) **FJL101900PMA**
 - for non-wood trim (1) **FJL101680PMA**
- hi/low lever
 - for wood trim (1) **FJL101530PMA**
 - for non-wood trim (1) **FJL000010PMA**
- Gaiter - inner - gear lever (1) **AWR5526**
Manual & auto.
- Seal - gear selector mechanism (1) **AWR5525**
Manual & auto.
- Insulation foam - gearlever;
 - manual (1) **AWR5528**
 - automatic (1) **AWR5527**



GEAR LEVER
GAITER
FJL101900PMA

LUBRICANTS & CAPACITIES		
GEARBOX	LUBRICANT	CAPACITY
Manual	ATF	2.4 litres after draining (2.7 litres from dry)
Automatic	ATF	4.0 V8; 11 litres all others: 9.7 litres
Transfer box	ATF	2.4 litres.

Gear Oil

Gearbox Oil - ATF

- 0.5 litre (A/R) **GUL255R**
- 5 litres (A/R) **GGL505**

ORDER ON: 01522 568000 / www.rimmerbros.co.uk

PART NUMBERS: A 'P' suffix denotes "Aftermarket".

DESCRIPTION QTY REQ. PART No.

Propshaft

For price & availability of complete propshaft assemblies, please contact our sales department.

Universal joint - propshaft <i>Front & rear.</i>	(4)	TVC100010
Rubber propshaft coupling kit	(1)	TVF100010
Grease nipple;		
universal joint	(a/r)	TYL100030
propshaft	(a/r)	TYL100040
Gaiter - proshaft sliding joint	(2)	TVE100000
Bolt - propshaft	(4)	509045P
Nut - propshaft	(8)	TN3209

DESCRIPTION QTY REQ. PART No.

**PROPSHAFT UJ
TVC100010**



DESCRIPTION QTY REQ. PART No.



**RUBBER
COUPLING KIT
TVF100010**

Axle - Front

Axle assembly - front

Please enquire for price & availability of complete axle assemblies.

Filler/level plug	(1)	FTC5403
Drain plug	(1)	FTC5208
Breather pipe - front axle	(1)	TAP100030

Differential - Front

Differential - (24 spline) (1) **FTC5142**

Part number suffixes:

New (N), Factory Recon (E), Aftermarket Recon (R).

Complete and ready to fit to axle.

Housing only - differential	(1)	FRC4112
Bolt - diff' to axle	(10)	TYG100610
Silicone sealant - diff' to axle	(1)	RTC3254
Oil seal - pinion	(1)	FTC5258
Bearing - pinion	(1)	539707
Spacer - pinion bearing	(1)	539745
Shim - pinion bearing;		
1.905mm	(a/r)	TYS101140
1.855mm	(a/r)	TYS101160
1.805mm	(a/r)	TYS101180
1.755mm	(a/r)	TYS101200
1.705mm	(a/r)	TYS101220
1.655mm	(a/r)	TYS101240
1.605mm	(a/r)	TYS101260
1.555mm	(a/r)	TYS101280
1.505mm	(a/r)	TYS101300
Nut - pinion flange	(1)	NY116041L
Split pin - pinion flange	(1)	PS608101L

**STEERING
KNUCKLE - RH
TAX000040**



Steering Knuckle

Steering knuckle;

rh	(1)	TAX000040
lh	(1)	TAX000050
Ball joint - steering knuckle;		
upper	(2)	FTC3570
lower	(2)	FTC3571
Nut - balljoint;		
upper	(2)	NY214043
lower	(2)	NY216043
Collet - steering knuckle tension	(2)	FTC3572

**UPPER AND LOWER
BALL JOINT**



FTC3570

FTC3571

Halfshaft - Front

Halfshaft assembly - complete with C.V. Joint;
C.V. Joint available separately - see below.

long	(1)	TDB500240
short	(1)	TDB500250
Seal - halfshaft	(2)	FTC4822



**CV JOINT
TDR100790**

C.V. Joint

The C.V. joint incorporates the outer driveshaft as one single unit.

C.V. joint	(2)	TDR100790
Gaiter - C.V. Joint	(2)	TDR100780
Nut - outer driveshaft/C.V. Joint	(2)	CDU1534

Hub Assembly - Front

Hub assembly

(2) **TAY100060**

Includes hub, wheel flange and wheelstuds.

Nb. Hubs are only available as complete assemblies and are not serviceable. Hub bearings and wheelstuds are not available separately.



**CV GAITER
TDR100780**

Axle - Rear

Axle assembly - rear

Please enquire for price & availability of complete axle assemblies.

Filler/level plug	(1)	FTC5403
Drain plug	(1)	FTC5208
Breather pipe - front axle	(1)	FTC4936

Differential - Rear

Differential - (24 spline) (1) **FTC5143**

3-bolt flange.

Part number suffixes:

New (N), Factory Recon (E), Aftermarket Recon (R).

Complete and ready to fit to axle.

Housing only - differential	(1)	FRC4112
Bolt - diff' to axle	(10)	TYG100610
Silicone sealant - diff' to axle	(1)	RTC3254
Oil seal - pinion	(1)	FTC5258
Bearing - pinion	(1)	539707
Spacer - pinion bearing		
Shim - pinion bearing;		
1.905mm	(a/r)	TYS101140
1.855mm	(a/r)	TYS101160
1.805mm	(a/r)	TYS101180
1.755mm	(a/r)	TYS101200
1.705mm	(a/r)	TYS101220
1.655mm	(a/r)	TYS101240
1.605mm	(a/r)	TYS101260
1.555mm	(a/r)	TYS101280
1.505mm	(a/r)	TYS101300
Flange - pinion - 3-bolt	(1)	STC3723
Nut - pinion flange	(1)	NY116041L
Split pin - pinion flange	(1)	PS608101L

Halfshaft - Rear

Halfshaft;

rh	(1)	TOD100020
lh	(1)	TOD100030
Seal - 'O'-ring - shaft to hub	(2)	FTC4919
Nut - shaft to hub	(2)	CDU1534

Hub - Rear

Hub assembly

(2) **TAY100050**

Includes hub, wheel flange and wheelstuds.

Nb. Hubs are only available as complete assemblies and are not serviceable. Hub bearings and wheelstuds are not available separately.

Gear Oil

EP90 gear oil - 0.5 litre	(a/r)	GGL190
---------------------------	-------	---------------

DESCRIPTION	QTY REQ.	PART No.	DESCRIPTION	QTY REQ.	PART No.
-------------	----------	----------	-------------	----------	----------



Shock Absorber - Front Standard

For Up-rated Shock Absorbers/Kits, refer to Suspension Packages.

Shock absorber - front;		
coil spring suspension		
with active roll control	(2)	RNB103683
non active roll control	(2)	RNB103533
levelled suspension		
with active roll control	(2)	RNB103694
non active roll control	(2)	RNB103533
Bush - shock absorber;		
upper		
standard rubber	(2)	ROA100050
polyurethane	(2)	ROA100050PY
lower		
standard rubber	(2)	ROA100040
polyurethane	(2)	ROA100040PY
Bush kit - shock absorber - front & rear;		
standard rubber	(1)	RD1180
polyurethane	(1)	RD1180PY

Suspension Turret

Turret - shock absorber	(2)	KVU101051
Retaining ring - turret	(2)	RBC100111
Locknut - retaining ring	(8)	FY108047

Road Spring - Front Standard - Coil

Road spring;		
diesel		
rhd		
rh	(1)	REB101341
lh	(1)	REB101340
lhd	(2)	REB101340
petrol		
rhd		
rh	(1)	REB101340
lh	(1)	REB101330
lhd	(2)	REB101330



RADIUS ARM BUSHES



Radius Arm - Front

Radius arm assembly - front	(2)	RBJ102353
Bush - radius arm;		
available in either standard rubber or polyurethane.		
to axle		
standard	(4)	RBX101680
polyurethane	(4)	RBX101680PY
to chassis		
standard	(2)	RBX101730
polyurethane	(2)	RBX101730PY
Bolt - radius arm;		
to axle	(4)	ANR5804
to chassis	(2)	RD1100031
Nut - radius arm bolt (all types)	(6)	ANR3140

DESCRIPTION	QTY REQ.	PART No.
-------------	----------	----------

Bump Stop Rubber

Bump stop rubber - front	(2)	RNV100060
--------------------------	-----	------------------

All models.



PANHARD ROD BUSH RBX101340

Panhard Rod

Panhard rod;
Includes bushes.

rhd	(1)	RBI100041
lhd	(1)	RBI100050
Bush - panhard rod - all models		
standard	(2)	RBX101340
polyurethane	(2)	ANR101340PY
Bolt - panhard rod;		
to axle	(2)	RD1100020
to chassis	(2)	ANR4386
Nut - panhard rod bolts	(2)	ANR3140

Anti-roll Bar - Front

Anti-roll bar	(1)	RBL101370
Vehicles without ACE (Active Cornering Enhancement). For ACE, see below.		
Bush - anti-roll bar mounting;		
standard	(2)	RBX101690
polyurethane	(2)	RBX101690PY
Link/balljoint assembly	(2)	RBM100223
Nut - link	(4)	RYH100590



LINK ASSEMBLY - ANTI-ROLL BAR RBM00223

LATERAL ACCELEROMETER RQJ100011



Active Cornering Enhancement - ACE

Pump - engine-driven - ACE	(1)	ANR6502
Valve block - ACE	(1)	RVH100012
Transducer - valve block - ACE	(1)	RVG100010
Filter and plug - valve block - ACE	(1)	RVJ100010
Lateral accelerometer - ACE	(2)	RQJ100011
Sensor - height - rear suspension	(2)	RQH100030
Anti-roll bar assembly - ACE;		
Comprises: anti-roll bar, torsion bar, ACE actuator and bushes.		
front	(1)	RBL101121
rear	(1)	RGB101020
Anti-roll bar only - ACE;		
front	(1)	ANR6550
rear	(1)	ANR6956
Bush - anti-roll bar - front & rear;		
actuator rod end	(2)	ANR6554
radius arm end	(2)	ANR6551
Torsion bar only - ACE;		
front	(1)	RBL101400
rear	(1)	RGB101330
Bush - torsion bar - front & rear	(2)	RBX101740
Mounting rubber - torsion bar	(2)	RBX101181
Link - torsion bar - front & rear	(2)	RGD100682
Nut - torsion bar link	(4)	RYH100590
Actuator - ACE - front & rear	(2)	RQK100000
Dust boot - actuator	(2)	RVX100000



REAR SHOCK ABSORBER
RPD102354

Shock Absorber - Rear Standard

For Upgraded Shock Absorbers/Kits, refer to Suspension Packages.

- Shock absorber - rear
 - coil spring suspension
 - with active roll control (2) **RPD102343**
 - non active roll control (2) **RPD102333**
 - levelled suspension
 - with active roll control (2) **RPD102354**
 - non active roll control (2) **RPD102363**
- Bush - shock absorber;
 - upper & lower standard (4) **ROA100050**
 - polyurethane (4) **ROA100050PY**



REAR SELF-LEVELLING AIR SPRING
RKB101200

Road Spring - Rear Standard - Coil or Air

- Road spring - rear;
 - coil spring
 - RHD
 - driver's side (1) **RKB101101**
 - passenger's side (1) **RKB101100**
 - LHD (2) **RKB101100**
 - air spring (2) **RKB101200**
- Self-levelling suspension. Where fitted.
See also: Conversion kit air to coil rear spring in 'Suspension packages'.
- Spring seat - lower - rear (2) **ANR3578**
Coil spring suspension.
- Isolator - upper - rear spring (2) **ANR2938**
Coil spring suspension.

Radius Arm - Rear

- Radius arm assembly (2) **RGG104862**
- Bush - radius arm;
 - For polyurethane kits, refer to Suspension Packages.
 - to chassis
 - standard (2) **RBX101730**
 - polyurethane (2) **RBX101730PY**
 - to axle
 - standard (4) **ANR6947**
 - polyurethane (4) **ANR6947PY**
- Bolt - radius arm;
 - to chassis (2) **ANR6920**
 - to axle (4) **ANR5804**
- Nut - radius arm;
 - to chassis (2) **ANR3140**
 - to axle (4) **ANR3140**

Watts Linkage - Rear

- Watts linkage assembly (1) **RGD100550**
Comprises: arms, centre pivot link and bushes.
- Arm - Watts linkage (2) **RGD100450**
Complete with bush.
- Bush - Watts linkage;
 - outer
 - standard (2) **RGX100970**
 - polyurethane (2) **RGX100970PY**
 - inner
 - standard (2) **RGX100960**
 - polyurethane (2) **RGX100960PY**
 - centre pivot (1) **RGW100020**
- Bolt - Watts linkage;
 - arm - outer & inner (4) **RHD100080**
 - centre pivot (1) **ANR6920**
- Nut - Watts linkage (4) **FX214057**
Outer & inner arm bolts.



REAR ANTI-ROLL BAR LINK
RGD100682

Bump Stop Rubber

- Bump stop rubber - rear (2) **RNV100060**
All models.

Anti-roll Bar - Rear

- Anti-roll bar - rear;
 - coil-spring suspension (1) **RGB101320**
 - air suspension (1) **RGB101310**
- Bush - anti-roll bar mounting;
 - coil-spring suspension
 - standard (2) **RBX101710**
 - polyurethane (2) **RBX101710PY**
 - air suspension
 - standard (2) **RBX101700**
 - polyurethane (2) **RBX101700PY**
- Link/balljoint assembly (2) **RGD100682**
- Bolt - link (4) **RYH100590**



ACE ACTUATOR
RQK100000

Active Cornering Enhancement - ACE

- Pump - engine-driven - ACE (1) **ANR6502**
- Valve block - ACE (1) **RVH100012**
- Transducer - valve block - ACE (1) **RVG100010**
- Filter and plug - valve block - ACE (1) **RVJ100010**
- Lateral accelerometer - ACE (2) **RQJ100011**
- Sensor - height - rear suspension (2) **RQH100030**
- Anti-roll bar assembly - ACE;
 - Comprises: anti-roll bar, torsion bar, ACE actuator and bushes.
 - front (1) **RBL101121**
 - rear (1) **RGB101020**
- Anti-roll bar only - ACE;
 - front (1) **ANR6550**
 - rear (1) **ANR6956**
- Bush - anti-roll bar - front & rear;
 - actuator rod end (2) **ANR6554**
 - radius arm end (2) **ANR6551**
- Torsion bar only - ACE;
 - front (1) **RBL101400**
 - rear (1) **RGB101330**
- Bush - torsion bar - front & rear (2) **RBX101740**
- Mounting rubber - torsion bar (2) **RBX101181**
- Link - torsion bar - front & rear (2) **RGD100682**
- Nut - torsion bar link (4) **RYH100590**
- Actuator - ACE - front & rear (2) **RQK100000**
- Dust boot - actuator (2) **RVX100000**
- Compressor - air suspension (1) **RQG100041**



MORE STOCK EVERY DAY

If the part you require is not listed here, please phone and enquire. By now we might well have it. For prices, terms & conditions etc, please refer to our latest price guide.

Suspension Modifications

Discovery Series II

Due to the sophisticated nature of the suspension system on Series II Discovery the traditionally accepted driving characteristics of large 4X4 vehicles, such as excessive body roll during cornering and steering "kick-back", are greatly reduced. This is largely due to features such as Self-Levelling Suspension (SLS) and Active Cornering Enhancement (ACE), as well as altered steering geometry and a revised steering system. For this reason, the traditionally accepted methods of "uprating" the suspension are largely unnecessary.

However, some owners of Series II Discovery still feel that improvements can be made to the vehicle's damping (shock absorbers) and suspension bushes, to give less of an on road/off road compromise and a more car-like feel, particularly when off-road ability is not a priority.

Therefore, we still offer a range of uprated shock absorbers and polyurethane bushes, plus an uprated steering damper, which contribute to superior on-road driving characteristics without adversely affecting off-road ability.

Shock absorbers are available from Koni (oil-filled, adjustable) and Bilstein (gas, non-adjustable) in car-sets or pairs (front and rear). Polyurethane bush kits are available in vehicle sets (plus supplementary kits) or individually. The uprated steering damper is from Bilstein. Please also refer to our Brakes section for uprated brake discs and pads.



STANDARD SHOCK ABSORBER KITS

Standard shock absorber kit;
Includes 2 front and 2 rear standard shock absorbers.
(ACE = Active Cornering Enhancement).

standard suspension		
with ACE	(1)	RD1181
non-ACE	(1)	RD1182
active ride suspension		
with ACE	(1)	RD1183
non-ACE	(1)	RD1184



UPRATED SHOCK ABSORBER KITS

BILSTEIN



**BILSTEIN - GAS,
HEAVY DUTY,
NON ADJUSTABLE**



**KONI - OIL FILLED,
ADJUSTABLE**

Up-rated shock absorbers - front or rear (pairs);

Up-rated shock absorber kit - vehicle set;
Bilstein are heavy duty, gas, non-adjustable shock absorbers.

Koni are oil-filled, adjustable (off-car) shock absorbers.

Bilstein (set of 4)	(1)	RD1200B
Koni (set of 4)	(1)	RD1200K

Bilstein		
front (pair)	(1)	RNB103683B
rear (pair)	(1)	RNB103683K
Koni		
front (pair)	(1)	RPD102343B
rear (pair)	(1)	RPD102343K

REAR COIL SPRING CONVERSION KIT

Rear coil spring conversion kit (1) **RD1206**
A straightforward DIY conversion kit which replaces the Discovery's rear air suspension (where fitted) with conventional coil springs. A cost-effective solution for vehicles with faulty EAS or for owners who favour coil spring suspension. ECU will need re-programming.

Note: we recommend fitting new shock absorbers at the same time.



STANDARD & UPATED BUSH & BOLT KITS

**BOLT KIT -
RD1185**



Bolt kit - suspension (1) **RD1185**
Contains the bolts and nuts required when renewing the suspension bushes.

**STANDARD
BUSH KIT -
RD1186**



Standard Bush Kit;
Direct replacement of original bushes. Kit contains a comprehensive vehicle set of standard suspension bushes, as follows: front & rear radius arm, panhard rod, Watts linkage, shock absorber and anti-roll bar/ACE assembly bushes, as appropriate.
(ACE = Active Cornering Enhancement).

with ACE	(1)	RD1186
non-ACE		
coil spring suspension	(1)	RD1187
air suspension	(1)	RD1188

**POLY BUSH KIT -
RD1189**



Poly Bush kit (1) **RD1189**
Polybush 'Dynamic' kit for more positive ride and handling. Easy to fit and very long lasting. Kit includes replacements bushes for front & rear radius arm, panhard rod and Watts linkage. Does not include shock absorber, anti-roll bar or ACE bushes. See **Supplementary Kits**, below, for these bushes.

Polyurethane bush kit (alternative)(1) **RD1189AP**
High quality bushes made from black polyurethane. Kit includes replacements bushes for front & rear radius arm, panhard rod and Watts linkage. Does not include shock absorber, anti-roll bar or ACE bushes. See **Supplementary Kits**, below, for these bushes.

Supplementary poly bush kit;
Includes bushes not supplied in polyurethane kits, as follows: shock absorber upper and lower, anti-roll bar (non-ACE vehicles) and steering damper.

non-ACE vehicles		
coil spring suspension	(1)	RD1190POLY
air spring suspension	(1)	RD1191POLY
vehicles with ACE	(1)	RD1192POLY

Shock absorber and steering damper bushes only.

UPRATED STEERING DAMPER

Up-rated steering damper (1) **QHH10001UR**



18" ALLOY WHEEL & WHEEL-TYRE PACKAGES

We offer a superb range of Genuine Land Rover alloy wheels to enhance and upgrade your Discovery II.

Made from M25 alloy, they are X-ray checked to ensure safety and optimum performance.

The alloy wheels shown here are designed specifically for Land Rover vehicles, ensuring peace of mind in all situations.

HURRICANE



'Hurricane'

Land Rover alloy wheel (10-spoke)
Silver sparkle, less centre & nuts (8J x 18).

wheel only (each) **RRC501470MNH**
wheel set (4) **RRC501470MNHK**



'Hurricane'

Land Rover alloy wheel (10-spoke) & tyre
Silver sparkle, less centre & nuts (8J x 18).
Fitted with quality 255/55 R18 tyre and balanced.

wheel & tyre (each) **RRC501470MNHHT**
wheel & tyre set (4) **RRC501470MNHKT**

MONDIAL



'Mondial'

Land Rover alloy wheel (5-spoke)
Silver sparkle, less centre & nuts (8J x 18).

wheel only (each) **RRC115410MNH**
wheel set (4) **RRC115410MNHK**



'Mondial'

Land Rover alloy wheel (5-spoke) & tyre
Silver sparkle, less centre & nuts (8J x 18).
Fitted with quality 255/55 R18 tyre and balanced.

wheel & tyre (each) **RRC115410MNHHT**
wheel & tyre set (4) **RRC115410MNHKT**

TRIPLE SPORT



'Triple Sport'

Land Rover alloy wheel (6-spoke)
Silver, less centre & nuts (8J x 18).

wheel only (each) **STC8516**
wheel set (4) **STC8516K**



'Triple Sport'

Land Rover alloy wheel (6-spoke) & tyre
Silver, less centre & nuts (8J x 18).
Fitted with quality 255/55 R18 tyre and balanced.

wheel & tyre (each) **STC8516T**
wheel & tyre set (4) **STC8516TKT**





COMET

'Comet'

Land Rover alloy wheel (6-spoke)
Silver, less centre & nuts (8J x 18).

wheel only (each)
wheel set (4)

RRC000930MCM
RRC000930MCMK



'Comet'

Land Rover alloy wheel (6-spoke) & tyre
Silver, less centre & nuts (8J x 18).
Fitted with quality 255/55 R18 tyre and balanced.

wheel & tyre (each)
wheel & tyre set (4)

RRC000930MCMT
RRC000930MCMKT

PROSPORT

'Prosport'

Land Rover alloy wheel (5-spoke)
Silver sparkle, less centre & nuts (8J x 18).

wheel only (each)
wheel set (4)

ANR4849MNH
ANR4849MNHK



'Prosport'

Land Rover alloy wheel (5-spoke) & tyre
Silver sparkle, less centre & nuts (8J x 18).

wheel & tyre (each)
wheel & tyre set (4)

ANR4849MNHHT
ANR4849MNHKT

BBS 2-PIECE

'BBS 2-Piece'

Land Rover alloy wheel (5-spoke)
Silver sparkle, less centre & nuts (8J x 18).

wheel only (each)
wheel set (4)

RRC500150MNH
RRC500150NHK



'BBS 2-Piece'

Land Rover alloy wheel (5-spoke) & tyre
Silver sparkle, less centre & nuts (8J x 18).

wheel & tyre (each)
wheel & tyre set (4)

RRC500150MNHHT
RRC500150MNHKT



TYRES

Tyre size;

255/55 R18 (18" wheel) (4) **255/55R18**

235/70 R16 (standard wheel) (4) **235/70R16**

255/65 R16 (standard wheel) (4) **255/65R16**

Several quality makes available.
Contact us for best prices and availability.



Wheel Nuts & Centres

NB: existing wheel nuts and centres may be re-used when changing wheel size (eg. from 7J x 16 to 8J x 18). However, we recommend locking wheel nuts if not fitted.

Wheel nuts;

standard

each (20) **ANR3679**
set of 20 (1) **ANR3679K**

locking

set of 4 (1) **STC8513**
set of 4 + 16 standard nuts (1) **STC8513K**

spare wheel retaining (3) **RRD100640**

Wheel centre cap (with logo);

Silver sparkle

all silver (4) **ANR3522MNH**

with green logo (4) **RRJ500030MNH**

Gunsmoke silver (4) **RRJ100140MNZ**

Badge - centre cap - gold (4) **DAG100310**



Autoglym 'Clean Wheels' (a/r) **RX1322**
500ml. Alloy wheel cleaning solution.

Autoglym 'Tyre Dressing' (a/r) **RX1368**
Makes tyres look like new!

DESCRIPTION	QTY REQ.	PART No.	DESCRIPTION	QTY REQ.	PART No.	DESCRIPTION	QTY REQ.	PART No.
-------------	----------	----------	-------------	----------	----------	-------------	----------	----------



VINYL

Spare Wheel Covers

Spare wheel cover;
All with Land Rover badge.

vinyl

215 x 16	STC50068
235 x 16	STC8486AB
255 x 16 & 18	STC50069

moulded

215 x 16	STC50041
235 x 16	STC50042
255 x 16 & 18	STC50043

rigid (s/steel rim)

215 x 16	STC50137
235 x 16	STC50138
255 x 16	STC50139
255 x 18	STC50140



MOULDED



RIGID
STAINLESS
STEEL



MUDFLAPS

Mudflaps

Mudflap kit;	
front	(1) STC50067
rear	(1) RD1204
Mudflaps - individual;	
rh - front & rear	(2) CAS100900
lh - front & rear	(2) CAS100910
Fittings - mudflaps;	
bracket - mudflap	
front	
rh	(1) CAX100060
lh	(1) CAX100070
rear	
rh	(1) CAX100200
lh	(1) CAX100210
studded plate - front	(2) MXC6068
nut - studded plate	(4) FN106047L
stay - rear mudflap	
rh	(1) CNG100020
lh	(1) CNG100030



TOOLS



Hydraulic Jack	(1)	ANR4489
Handle for jack	(1)	NTC6856
Wheel Brace	(1)	NTC7829
Wheel Chock (each)	(a/r)	ANR3052
Tyre Pump	(1)	523638A



EBC UPGRATED FRONT DISCS & PADS

EBC UPGRATED REAR DISCS & PADS

Brake Discs

Brake disc;			
front			
standard (each)	(2)	SDB000380	
EBC uprated (pair)	(1)	SDB000380UR	
Rossini (pair)	(1)	SDB000380ROS	
rear			
standard (each)	(2)	SDB000470	
EBC uprated (pair)	(1)	SDB000470UR	
Rossini (pair)	(1)	SDB000470ROS	
Screw for discs	(4)	SF108201L	

Disc Shield

Shield - brake disc;			
front			
rh	(1)	FTC4908	
lh	(1)	FTC4909	
rear	(2)	FTC4778	



FRONT CALIPER STC1916



EBC BRAKE DISCS

EBC turbo groove discs are handed (lh & rh) with curved grooves and dimples to offer superb stopping power when combined with 'Green Stuff' Kevlar pads.



EBC
BRAKES

ROSSINI UPGRATED BRAKE DISCS

Performance drilled and grooved. Improved stopping power, reduced brake fade. Unique signature for improved safety. Superb quality. Use EBC Brake Pads with these discs.



Rossini

Brake Pads

See 'Brake Calipers' for Pin Kits.

Brake pads;			
front (axle set)			
standard	(1)	SFP000210	
uprated (Green stuff)	(1)	SFP000210GS	
rear (axle set)			
standard	(1)	SFP100470	
uprated (Green stuff)	(1)	SFP100470GS	

Brake Calipers

Caliper - front;			
piston housing assembly			
Complete assembly.			
rh	(1)	STC1916	
lh	(1)	STC1915	
carrier	(2)	STC1917	
Caliper - rear;			
piston housing assembly			
Complete assembly.			
rh	(1)	STC1906	
lh	(1)	STC1905	
carrier	(2)	STC1907	
Piston - caliper;			
front	(4)	STC1918	
rear	(2)	STC1908	
Seal kit - caliper;			
front	(2)	STC1919	
rear	(2)	STC1909	
Brake pad guide pin set - caliper;			
Supplied with dust cover.			
front	(1)	STC1920	
rear	(1)	STC1910	
Dust cover kit - guide pin	(a/r)	STC1911	
Bolt - guide pin	(8)	STC1914	
Bleed nipple - caliper	(4)	RTC1115A	
Front and rear.			



CALIPER PISTON STC1918 AND SEAL KIT STC1919

DESCRIPTION QTY REQ. PART No.



BRAKE MASTER CYLINDER
SJC100442

Brake Hydraulics

- | | |
|----------------------------------|---------------|
| Master cylinder - brakes; | |
| RHD | (1) SJC100442 |
| LHD | (1) SJC100432 |
| Repair kit - master cylinder | (1) SJJ100362 |
| Cap and float switch - reservoir | (1) SJL000040 |
| <i>All models.</i> | |



MASTER CYLINDER REPAIR KIT
SJJ100362

DESCRIPTION QTY REQ. PART No.

Brake Servo

- | | |
|-----------------|---------------|
| Servo assembly; | |
| RHD | (1) SJG000040 |
| LHD | (1) SJG000050 |
| Filter - servo | (1) SID100040 |
| Seal - servo | (1) SJO100080 |

Brake Hoses

Brake hoses are available as standard (ie rubber) or stainless steel braided. Braided hoses have a smaller internal diameter, as well as a far greater resistance to sidewall flexing, both of which contribute to improved pedal "feel".

- | | |
|--------------------------------|---------------|
| Brake hose - flexible - front; | |
| RH | (1) SHB101190 |
| LH | (1) SHB101180 |
| Jump hose - front left hand | (2) SHB101350 |
| Brake hose - flexible - rear; | |
| RH | (1) SHB101170 |
| LH | (1) SHB101200 |



Brake Fluid

- | | |
|--|-----------------|
| Brake fluid; | |
| Dot 3 - 1 litre | (a/r) GBF103 |
| Dot 4 - 1 litre | (a/r) SIJ000030 |
| silicone fluid | |
| <i>Replaces conventional clutch/brake fluid. Doesn't absorb water - doesn't degrade. Will not harm paintwork if spilt.</i> | |
| 0.5 litre | (a/r) RX1327 |
| 1 litre | (a/r) RX1326 |
| Brake cleaner - aerosol | (a/r) GBF901 |

DESCRIPTION QTY REQ. PART No.



ABS SENSOR, FRONT
SSW500020

ABS Components

- | | |
|----------------------|---------------|
| Modulator - ABS | (1) SRB101203 |
| Wheel sensors - ABS; | |
| front | (2) SSW500020 |
| rear | (2) SSW500030 |

Handbrake

For Handbrake Component, see Transfer Gearbox section.

Miscellaneous

- | | |
|-----------------------|---------------|
| Pedal rubber - brake; | |
| manual | (1) 575818 |
| automatic | (1) ANR2941 |
| Switch - brake light | (1) XKB000010 |





STEERING BOX SEAL KIT QAF100140

Steering Box

- Steering box (power assisted);
- RHD (1) QAF000010
 - LHD (1) QAF000040
- Seal kit - steering box;
- main kit (1) QFW100140
 - input seal (1) QFW100150
 - output seal (1) QFW100180
- Lever - drop arm (1) QJF100140
- Tab-washer - drop arm nut (1) QGK100060
- Nut - drop arm (1) QFG100090



STEERING SHAFT QME500020

Steering Shaft & Coupling

- Steering shaft - lower (1) QME500020
- Complete assembly, comprises lower shaft and universal joint.
- The universal joint is not available separately.

Power Steering Pump

- Power steering pump;
- Td5 (1) QVB101240
 - V8 (1) QVB50008
- Seal - coolant pump - Td5 (1) ERR6711
- Coolant pump to PAS pump bracket.



SHORT ARM BALL JOINT QFS000010

Track Rod

- Track rod assembly (1) TIQ000010
- Comprising tube and balljoints.
- Balljoint - track rod end (1) QFS000010
- Short arm balljoint.
- Long arm only available as part of track rod assembly.
- Nut - balljoint (2) ANR1000
- Clamp - balljoint;
- large (1) QJK100000
 - small (1) QJK100010

Drag Link

- Drag link assembly;
- Comprises drag link tube, ball joints and clamps.
- RHD (1) QHG000040
 - LHD (1) QHG000050
- Balljoint -drag link (1) QFS000010
- Short arm balljoint.
- Nut - balljoint (2) ANR1000
- Clamp - balljoint;
- large (1) QJK100000
 - small (1) QJK100010



Steering Damper

- Steering damper;
- standard (1) QHH100001
 - uprated (Bilstein) (1) QHH100001UR
- Bush - steering damper;
- standard (2) RBX101340
 - polyurethane (2) RBX101340PY



STANDARD AND UPDATED STEERING DAMPERS

Steering Wheel & Column

- Steering wheel - original.
- Please enquire for price & availability of original steering wheels.
- Steering wheel switches;
- cruise control set/resume (1) YUH100320
 - in-car entertainment (1) YUH100330
 - horn (2) QTN100270
- Steering column - upper (1) QMB000120PMA
- Cowl - steering column (black);
- upper (1) QRB100750PMA
 - lower (1) QRB100740PMA
- Grommet - steering lock (1) QYA100000

Ignition Lock

- Ignition lock - steering column(1) QRF101180H
- Including ignition switch.
- Shear bolt - ignition lock (2) STC2867



DESCRIPTION	QTY REQ.	PART No.	DESCRIPTION	QTY REQ.	PART No.	DESCRIPTION	QTY REQ.	PART No.
-------------	----------	----------	-------------	----------	----------	-------------	----------	----------

TD5 STARTER MOTOR NAD101240



WIPER MOTOR ASSEMBLY DKD100620



Engine Electrics

Starter motor;		
Td5	(1)	NAD101240
V8	(1)	NAD101490
Solenoid - starter - V8	(1)	STC4462
Alternator;		
V8	(1)	ERR6413
Td5	(1)	ERR6999
Pipe - alternator vacuum pump oil feed - Td5	(1)	YKL100120
Pipe - oil drain (vac' pump)	(1)	SQC500010
Sensors - engine;		
Td5		
temperature inlet manifold	(1)	MHK100640
fuel connector block	(1)	ERR2081
coolant elbow	(1)	ERR2081
crank sensor	(1)	NSC100790
V8		
crank sensor manual	(1)	ERR7352
automatic	(1)	ERR7354
knock sensor	(2)	NSC100650
temperature sensor	(1)	MEK100160
camshaft sensor	(1)	ERR6169
lambda sensor	(2)	MHK100920
Oil pressure switch;		
Td5	(1)	NUC10003
V8	(1)	STC4104
Transmission sensors/switches;		
reverse light switch manual	(1)	AMR3918
reverse	(1)	PRC2911
low ratio detect switch	(1)	IGM100000
<i>Transfer box.</i>		
temperature sensor - V8	(1)	PRC7984
Switch - stop lamp	(1)	XKB000010

GLOW PLUG ERR6066



Ignition Components

Plug leads - V8;		
vehicle set	(1)	RA2001
individual leads		
no.1 cylinder	(1)	NGC103740
no.2 cylinder	(1)	NGC103750
no.3 cylinder	(1)	NGC103760
no.4 cylinder	(1)	NGC103770
no.5 cylinder	(1)	NGC103780
no.6 cylinder	(1)	NGC103790
no.7 cylinder	(1)	NGC103800
no.8 cylinder	(1)	NGC103810
Spark plug - V8	(8)	NLP100320
Ignition coil pack - V8;		
coil and bracket assembly	(1)	ERR6566
ignition coil only	(2)	ERR6045
Heater (glow) plug - Td5	(5)	ERR6066

Wipers & Washers

Wiper motor & mechanism assembly - front;
Nb. Front wiper motor not available separately.

RHD	(1)	DKD100620
LHD	(1)	DKD100630
Wiper motor - rear	(1)	DLB101640
Nut - wiper arm spindle;		
front	(2)	DLP000010
rear	(1)	FN108047L



AERFOIL DKD100030

Wiper arm;		
front		
standard arm		
RHD	(2)	DKB102830
LHD	(2)	DKB102840
aerfoil - wiper arm (optional)		
RHD	(1)	DKS100030
LHD	(1)	DKS100040
rear	(1)	DKB500130PMD
Wiper blade;		
windscreen	(2)	DKC100960
rear screen	(1)	DKC100890
Washer pump;		
windscreen	(1)	DMC100550
rear screen	(1)	DMC100540
headlamp	(1)	DMC100560
Jet assembly;		
windscreen	(2)	DNJ500090
rear screen	(1)	AWR2406
headlamp	(2)	AMR5114
Non-return valve;		
windscreen	(1)	AMR6676
rear screen	(1)	DNH500020
headlamp	(1)	DNE100050

HEADLAMP JET AMR5114



HEADLAMP XBC105120

Headlamps

Headlamp;		
up to VIN 2A		
rhd	(1)	XBC105120
lh	(1)	XBC105130
lhd		
rh	(1)	XBC105140
lh	(1)	XBC105150
VIN 3A on (complete with indicator)		
rhd	(1)	XBC001620
lh	(1)	XBC001630
lhd		
rh	(1)	XBC001640
lh	(1)	XBC001650
Fitting kit - headlamp	(2)	STC1232
Levelling motor - headlamp	(2)	AMR2706
Bulbs;		
headlamp standard	(2)	589783
xenon (pair)	(1)	589783X
sidelamp	(2)	AFU4481



FOG LAMP AMR5344

Fog Lamps

Replacement for existing fog lamps. See Accessories for fog lamp conversion kit.

Fog lamp - front;		
up to VIN 2A		
rh	(1)	AMR5344
lh	(1)	AMR5345
VIN 3A on		
rh	(1)	XBJ000080
lh	(1)	XBJ000090
Bulbs - fog lamp - front	(2)	XCD100030L

INDICATOR ASSEMBLY XBD100880



Side Lamps & Indicators - Front

Indicator assembly - front;		
rh	(1)	XBD100880
lh	(1)	XBD100870
Bulb holder - indicator	(2)	XBP100180
Side repeater	(2)	XGB000030
Bulb holder - side repeater	(2)	YPY100220
Bulbs;		
indicator	(2)	264591
side repeater	(2)	AFU4481

REAR LAMP XFB000160



Rear Lamps

Rear lamp assembly;		
'E'-post		
rh	(1)	XFB000160
lh	(1)	XFB000170
bumper-mounted		
rh	(1)	XFB101480
lh	(1)	XFB101490
Bulb holder - rear lamp;		
'E'-post lamp		
rh	(1)	XFM100320
lh	(1)	XFM100330
bumper-mounted	(2)	XFM100310
High-level stop lamp assembly	(1)	XFG100330
Bulbs;		
rear lamp assembly - 'E'-post		
single filament	(a/r)	264591
double filament	(a/r)	264590
rear bumper lamps		
clear bulb	(a/r)	264591
orange bulb	(a/r)	XZQ100190L
high-mounted stop lamp	(1)	264591

BUMPER - MOUNTED LAMP XFB101490



NUMBER PLATE LAMP XFC500050



Number Plate Lamp

Number plate lamp assembly	(2)	XFC500050
Gasket - number plate lamp	(2)	PRC7246
Bulbs - number plate lamp	(2)	RTC3633



Interior Lamps

Interior lamp;		
courtesy lamp	(2)	AMR2577
rear headlining lamp	(1)	AMR2329
glovebox lamp	(1)	ADU2066
footwell lamp	(1)	YUE10005
Bulb - interior lamps;		
courtesy lamp	(2)	586438
rear headlining lamp	(1)	RTC3633

Central Locking

Actuator - fuel filler flap release	(1)	FUG100580
-------------------------------------	-----	------------------



Cigar Lighter

Cigar lighter	(1)	DRC8395
---------------	-----	----------------

Horns

Horns;		
high note	(1)	YEB500040
low note	(1)	YEB500060
Air horns (pair)	(1)	RX1381
<i>Including fittings.</i>		

WASH/WIPE SWITCH STC4016



Switches & Controls

Ignition lock - steering column	(1)	QRF101180H
<i>Including ignition switch.</i>		
Shear bolt - ignition lock	(2)	STC2867
Wash/wipe switch only	(1)	STC4016
Lights/indicators/dip switch only	(1)	STC4017
Housing - column switches	(1)	STC2835
Steering wheel switches;		
cruise control set/resume	(1)	YUH100320
in-car entertainment	(1)	YUH100330
horn	(2)	QTN100270
Facia switches;		
hill descent control	(1)	YUG102382
hazard warning	(1)	YUG102372
heated windscreen	(1)	YUG102550
off-road vehicle height	(1)	YUF101751
fuel flap release	(1)	YUG102390
heated rear window	(1)	YUG102540
blank switch	(a/r)	AMR5432
master door lock	(1)	YUF000220LNF
Dashboard switches;		
headlamp levelling	(1)	YUK000020PUY
mirror switch		
with power folding	(1)	YUH100260PMA
without power folding	(1)	AMR2498
Binnacle switches;		
front fog	(1)	YUG102620
rear fog	(1)	YUE100670
rear screen wash	(1)	YUE100590
rear screen wipe	(1)	YUE100600
blank switch	(1)	AMR5433
cruise control on/off	(1)	YUH100370
thumbwheel - brightness	(1)	AMR2745
Bulb & holder - binnacle switches;		
orange	(1)	STC1877
green	(1)	STC1878
Sunroof switches;		
switch - sunroof	(3)	YUF000210LNF
isolator switch - sunroof	(1)	YUG102450
Centre tunnel switches;		
window lift		
front	(2)	YUF101521LNF
rear	(2)	YUF000200LNF
isolator	(1)	AMR2497
heated seat		
rh	(1)	YUG102440
lh	(1)	YUG102430
electric seat controls		
switch assembly		
<i>Less escutcheon and buttons.</i>		
rh	(1)	YUB101080
lh	(1)	YUB101060
escutcheon - electric seat switch		
rh	(1)	FIH100000LNF
lh	(1)	FIH100010LNF
buttons - electric seat switch		
seat back - rh	(1)	HSD100071
seat back - lh	(1)	HSD100061
seat base	(2)	HSD100080



DESCRIPTION QTY REQ. PART No.

Electric Motors

Motor;		
headlamp levelling	(2)	AMR2706
sunroof	(2)	EGQ100230
electric windows		
rh	(2)	CUR100440
lh	(2)	CUR100450
electric seats		
horizontal	(1)	HAK100040
front	(1)	HAK100050
rear	(1)	HAK100060
Actuator - fuel filler flap	(1)	FUG100580

Fuse Box & Relays

Fuse box;		
underbonnet	(1)	YQE103800
passenger side	(1)	YQE000410
Cover - fusebox - underbonnet	(1)	YQH101180

Fuses;
standard blade type, pack of 5*
**Except 40 amp and above, which are supplied individually.*

3 amp	(1)	GFS3103
5 amp	(1)	GFS3105
7.5 amp	(1)	GFS3107
10 amp	(1)	GFS3110
15 amp	(1)	GFS3115
20 amp	(1)	GFS3120
25 amp	(1)	GFS3125
30 amp	(1)	GFS3130
40 amp	(a/r)	YQF100170L
50 amp	(a/r)	YQF100290
80 amp	(a/r)	YQF100320
100 amp	(a/r)	YQF100330

Fusible link;		
30 amp	(a/r)	YQF100410
40 amp	(1)	YQF100420
50 amp	(1)	YQF100430
150 amp	(1)	YQG100260

Relay - underbonnet fusebox;		
black	(a/r)	YWB101300
<i>Glow plug, main/dip, auxiliary, heated windscreen & ABS.</i>		
yellow	(a/r)	YWB10004L
<i>ACE system, horn, front fogs & air conditioning.</i>		
SLS system	(1)	YWB10027L
washer pump	(1)	YWB10027L
fuel pump	(1)	YWB10027L
heater blower	(1)	YWB10027L
starter motor	(1)	YWB10027L

DESCRIPTION QTY REQ. PART No.



DESCRIPTION QTY REQ. PART No.

Electronic Control Units (ECUs)

The sophisticated electronics used in the Discovery incorporate a number of Electronic Control Units (ECUs). There are ECUs to look after fuelling and ignition timing, automatic transmission, cruise control, ABS and various on-board diagnostics.
Due to the variation in vehicle specifications, it's not possible to list every ECU. Please contact us for price and availability of new and reconditioned ECUs.

Instruments

Instrument pack;		
MPH	(1)	YAC001540PMA
KPH	(1)	YAC001550PMA
Lens - instrument pack	(1)	YAN100380
Bulb & holder - instruments;		
grey	(a/r)	YAW100020
brown	(a/r)	YAW100040
blue	(a/r)	YAW100050
Clock	(1)	YFB100500LNF

Battery & Fittings

Please note, batteries are not available mail order - counter collection only.

Battery;		
Td5	(1)	YGD100860
V8	(1)	YGD100850
Clamp - battery fixing	(1)	YJF100261
'J'-bolt - battery clamp;		
long	(1)	AMR5735
short	(1)	AMR5280
Tray assembly - battery	(1)	YJC000060
Cover - battery tray	(1)	YJM100100
Turnbuckle fixing - battery cover	(1)	DZM100070



Chassis Repair Sections

Crush can;	
rh	(1) DXE000040
lh	(1) DXE000050
Crossmember - rear	(1) KVB100100

Bonnet

Bonnet	(1) BKA700040
Hinge - bonnet;	
rh	(1) BKB700020
lh	(1) BKB700030
Insulation pad - bonnet	(1) ETB100820
Retaining clip - insulation pad	(12) AFU3711L
Seal - bonnet;	
front	
rh (739mm)	(1) CJE100800
lh (655mm)	(1) CJE100790
rear	(1) ASR1258
side	(2) CJE100820
Bonnet release cable	(1) FSE100600
Striker - bonnet	(1) FPB100160
Buffer - bonnet	(2) BTR966

Front Grille/Headlamp Mounting Panel

See **Body Fittings** (next section) for Front Grille.

Mounting panel assembly - grille	(1) ALR9531
<i>Comprises: bonnet closing platform, headlamp mounting panels, lower crossmember and crossbraces.</i>	
Bonnet closing platform	(1) ASR1047
Headlamp mounting panel;	
rh	(1) ALR9518
lh	(1) ALR9519
Lower crossmember	(1) ABC700020
Crossbrace;	
rh	(1) ABJ700011
lh	(1) ABJ700012

Front Wing

Front wing;	
rh	(1) ASB700100
lh	(1) ASB700010
Screw - front wing	(a/r) AYP100100
Nut - captive - front wing	(a/r) AYH100790
Rear baffle - front wing;	
rh	(1) ASU700040
lh	(1) ASU700050
Liner - front wheelarch;	
rh	(1) CLF102040
lh	(1) CLF102050
Plastic rivet - wheelarch liner	(a/r) MXC3119
Front cover - wheelarch liner;	
up to VIN 2A	
rh	(1) CLJ100240
lh	(1) CLJ100250
VIN 3A on	
rh	(1) CLJ100241
lh	(1) CLJ100251

Rear Wing/Side Panel

Rear wing/side panel assembly;	
<i>Includes rear corner panel.</i>	
rh	(1) ASR1084
lh	(1) ASR1085
Rear corner panel only;	
rh	(1) ASR2220
lh	(1) ASR2221

Fuel Filler Flap

Fuel filler flap	(1) BPA000030
------------------	----------------------



Inner Wing/Wheelarch - Front

Inner wing/ wheelarch assembly;	
rh	(1) ALR9530
lh	(1) ALR9529
Valance only - less wheelarch;	
rh	(1) ABD700022
lh	(1) ABD700023
Closing panel - inner wing;	
rh	(1) ABF700060
lh	(1) ABF700090
Reinforcement - valance;	
rh	(1) ALR8792
lh	(1) ALR8793

Inner Wing/Wheelarch - Rear

Inner wing - rear;	
rh	(1) ASR1288
lh	(1) ASR1289
Wheelarch - inner - rear;	
inner section	
rh	(1) ASR1286
lh	(1) ASR1287
outer section	
rh	(1) ASR1658
lh	(1) ASR1659



DESCRIPTION QTY REQ. PART No.

Sill - inner and outer

Sill - outer;		
rh	(1)	ASR1194
lh	(1)	ASR1195
Sill - inner	(2)	ALG700010

'A'-Post

'A'-post assembly;		
rh	(1)	ALB700060
lh	(1)	ALB700070

'BC'-Post

'BC'-post assembly;		
rh	(1)	ASR1202
lh	(1)	ASR1203

'D'-Post

'D'-post/rear outer wheelarch assembly;		
<i>Includes rear inner wheelarch, outer section (see above).</i>		
rh	(1)	ASR1294
lh	(1)	ASR1295
Closing panel - 'D'-post;		
rh	(1)	ASR1898
lh	(1)	ASR1899

Cantrail

Cantrail;		
rh	(1)	ASR1196
lh	(1)	ASR1197

DESCRIPTION QTY REQ. PART No.

Roof Panel

For Sunroof, see Body Fittings section.

Roof panel;		
plain roof (no sunroof)		
non roof-rack type	(1)	ASR1190
roof-rack type	(1)	AKP700030
sunroof		
non roof-rack type	(1)	AKP700050
roof-rack type	(1)	AKP700020
Roof header assembly	(1)	AKR700040
Roof stiffener;		
centre	(1)	ALR9521
rear	(1)	AKD700020

Rear Floor

Floor assembly - rear	(1)	ALR9762
Longitudinal support - rear floor	(2)	ASR1837
Plate - fuel pump - rear floor	(1)	MXC1420
Seal - fuel pump plate	(1)	MXC1421

Rear Load-Door Frame/'E'-Post

'E'-Post panel;		
rh	(1)	ALR9912
lh	(1)	ALR9913
Closing panel - 'E'-post;		
rh	(1)	AME700100
lh	(1)	AME700110
Header panel - load-door frame	(1)	AKC700020
<i>Comprises inner & outer header frame.</i>		
Outer panel only - header frame	(1)	ASR1862
Closing panel - header panel	(1)	ASR1309
Rear lower panel	(1)	ALR9701
Closing panel - rear lower panel	(1)	ALR9315
Rear floor panel - load door	(1)	ALR9705

DESCRIPTION QTY REQ. PART No.

Doors

See Body Fittings section for door trims, seals, hinges etc.

Door shell assembly;		
front		
rh	(1)	BDA700180
lh	(1)	BDA700190
rear		
rh	(1)	BFA700060
lh	(1)	BFA700070
Door skin only;		
front (all years)		
rh	(1)	BDA700100
lh	(1)	BDA700110
rear		
rh	(1)	BFA700100
lh	(1)	BFA700110
Frame - upper door;		
front		
rh	(1)	BDY700020
lh	(1)	BDY700030
rear		
rh	(1)	CUI100000
lh	(1)	CUI100010

Tailgate/Rear Load Door

See Body Fittings section for tailgate trim, including glass.

Tailgate/rear load door	(1)	BHD700132
-------------------------	-----	------------------





RADIATOR GRILLE
AWR3633PCM

Radiator Grille

Radiator grille (black primer) (1) **AWR3633PCM**
 Plastic rivet - radiator grille (3) **DYQ100230**
 Headlamp finisher - black primer;
 rh (1) **DHH100700PCM**
 lh (1) **DHH100710PCM**
 Badge - 'LAND ROVER' - grille (1) **DAG100330**

HEADLAMP FINISHER
DHH100700PCM

GRILLE BADGE
DAG100330



Bumpers

Front bumper;
 primed - ready to paint (1) **DPB104620LML**
 non-paint type
 foglamp type (1) **DPB104620**
 non-foglamp type (1) **DPB104630**
 Blanking plug - non h/lamp wash (2) **DPW100070**
 Cover plate - tow loop (1) **STC4351**
 Duct - engine intake (1) **DHN100130**
 Bracket - front bumper;
 rh (1) **ABU700381**
 lh (1) **ABU700391**
 Rear bumper (1) **DQB000410PMA**
 Finisher - rear bumper;
 rh (1) **DQR101080**
 lh (1) **DQR101090**
 Tread-plate - rear bumper (1) **DPP100970**

SEALANT PACK
RTC2063



Windscreen

Windscreen;
Windcreens are available for collection only.
 unheated (1) **CMB101040**
 heated (1) **CMB000300**
 Sealant pack - windscreen (1) **RTC2063**

Windscreen Lower Finisher

Finisher - plenum air intake;
Base of windscreen.
 up to VIN YA290236 (1) **JAG100110**
 VIN 1A 290237 on (1) **JAK000010PMA**
 Seal - finisher (1) **DDL100540**
 Foam strip - finisher (1) **JZL100120**
 Plastic rivet - finisher (2) **AWR3994**

Rear Side Windows

Rear side window;
 optikool
 with antenna
 rh (1) **CVB102000**
 lh (1) **CVB102010**
 no antenna (lh) (1) **CVB102040**
 Sundym
 with antenna
 rh (1) **CVB102380**
 lh (1) **CVB102390**
 no antenna (lh) (1) **AWR6623**
 Sealant pack - rear side windows(1) **RTC2063**

Alpine Windows

Alpine (roof-side) window;
 rh (1) **CPB000580**
 lh (1) **CPB000590**

Door Glass

Door glass;
 front (green tint)
 rh (1) **CUB102700**
 lh (1) **CUB102710**
 rear -main
 Sundym
 rh (1) **CVB102620**
 lh (1) **CVB102630**
 optikool
 rh (1) **CVB101920**
 lh (1) **CVB101930**
 rear - quarter glass
 Sundym
 rh (1) **CVB102640**
 lh (1) **CVB102650**
 optikool
 rh (1) **CVB102660**
 lh (1) **CVB102670**
 Glass channel - door glass;
 front (2) **CFE103200**
 rear
 main
 long (2) **ASR2096**
 short (2) **MTC9177**
 quarter glass (2) **CGE101510**
 Seal - rear door quarter glass (2) **CGE101510**

Window Regulators

Window regulator - electric;
 front
 rh (1) **CUH102300**
 lh (1) **CUH102310**
 rear
 rh (1) **CVH101240**
 lh (1) **CVH101250**
 Motor only - window regulator - front & rear;
 rh (2) **CUR100440**
 lh (2) **CUR100450**



WINDOW REGULATOR
CUH102300





Lock Sets & Door Handles

Lock set;
Lock sets comprise four outer door handles, key/transmitter & steering column lock assembly.

rh - UK (1) **CWB105090**
For other RHD markets, contact our sales department.
lh - Europe (1) **CWB105100**
For other LHD markets, contact our sales department.

Door handle only - outer;
front door
rh (1) **CXB103000H**
rh (1) **CXB103010**
lh (1) **CXB103020**
lh (1) **CXB103030H**
rear side door (2) **CXB102910**
tailgate (1) **CXB102190**

Tailgate Glass

Tailgate glass (green tint) (1) **CQB101900**
Tailgate glass is available for collection only.
Weatherstrip - tailgate glass (1) **CDB100230**

Sunroof Assembly

Sunroof assembly (glass) (1) **EED101471**
Manual & electric
Complete sunroof assembly, including glass panel, frame etc. Less motor/crank handle.
Replacement glass - sunroof (1) **AWR6577**
Manual & electric.
Motor - electric sunroof (2) **EGQ100230**

Wheelarch & Sill Finishers

Sill finisher;
with front & rear mudflaps
rh (1) **DDJ100840**
lh (1) **DDJ100850**
with rear mudflaps only
rh (1) **DDJ100820**
lh (1) **DDJ100830**
Plastic rivet - sill finisher (a/r) **ANR2224**
Finisher - rear side lower;
rh (1) **DDE101720**
lh (1) **DDE101730**
Wheelarch finisher;
front
rh (1) **DFJ500040PMA**
LH (1) **DFJ500050PMA**
rear
door
rh (1) **DFK500180PMA**
lh (1) **DFK500190PMA**
quarter panel
rh (1) **DFK500200PMA**
lh (1) **DFK500210PMA**
mini
rh (1) **DFK100900**
lh (1) **DFK100910**

'A' & 'D'-Post Finishers

Finisher;
'A'-post;
rh (1) **DCB00060PMA**
lh (1) **DCB00070PMA**
'D'-post
rh (1) **DDG100381**
lh (1) **DDG100391**
Clip - 'A'-post finisher (a/r) **AWR4426**

Rubbing Strips

Rubbing strip (black);
front wing
rh (1) **DGB000020PMA**
lh (1) **DGB000030PMA**
front door
rh (1) **DGC000020PMA**
lh (1) **DGC000030PMA**
rear door
rh (1) **DGD000020PMA**
lh (1) **DGD000030PMA**
rear quarter
rh (1) **DGD000040PMA**
lh (1) **DGD000050PMA**

DOOR HINGE
BDB700060



Door Fittings

Hinge assembly;
front & rear door;
rh (4) **BDB700060**
lh (4) **BDB700070**
tailgate
upper (1) **BHB700032**
lower (2) **BHB700051**
Gasket - tailgate hinge;
upper (1) **MXC8774**
lower (1) **MXC8775**
Bolt - door hinge;
side doors (a/r) **BYP100190**
tailgate
hinge to body (6) **FB108181L**
hinge to tailgate (4) **FB108111**
Check strap - door;
front & rear (4) **BDH700030**
tailgate (1) **ALR9290**

CHECK STRAP
BDH700030



Door Seals

Seal - door aperture;
front door
door-mounted
rh (1) **CFE500580**
lh (1) **CFE500590**
rear side door
door-mounted
rh (1) **CFE500600**
lh (1) **CFE500610**
tailgate (1) **CKE101000**
Seal - rear door to wheelarch;
rh (1) **CGE500300**
lh (1) **CGE500310**
Seal - tailgate - upper (1) **BHK700021**
Waist seal - door;
front door
inner
rh (1) **ETJ500040**
lh (1) **ETJ500050**
outer
rh (1) **CGE500240**
lh (1) **CGE500250**
rear side door
inner
rh (1) **ELT100240**
lh (1) **ELT100250**
outer
rh (1) **CGE500260**
lh (1) **CGE500270**



REAR STEP
STC50290

Rear Step

- Rear step assembly (original equipment);
 - up to VIN 1A298103 (1) **STC50290**
 - VIN 1A298104 on (1) **KVI000030**
- Tread-plate - rear step (1) **KVJ100010**
- Strut - rear step (1) **KVL100040**



Mudflaps

- Mudflap kit;
 - front (1) **STC50067**
 - rear (1) **RD1204**
- Mudflaps - individual;
 - rh - front & rear (2) **CAS100900**
 - lh - front & rear (2) **CAS100910**
- Fittings - mudflaps;
 - bracket - mudflap front
 - rh (1) **CAX100060**
 - lh (1) **CAX100070**
 - rear
 - rh (1) **CAX100200**
 - lh (1) **CAX100210**
 - studded plate - front (2) **MXC6068**
 - nut - studded plate (4) **FN106047L**
 - stay - rear mudflap
 - rh (1) **CNG100020**
 - lh (1) **CNG100030**

Roof Rails

- Roof rail;
 - rh (1) **CAC000100PMA**
 - lh (1) **CAC000110PMA**
- Gasket - roof rails;
 - front
 - upper
 - rh (1) **CAJ100380**
 - lh (1) **CAJ100390**
 - lower
 - rh (1) **CAJ100360**
 - lh (1) **CAJ100370**
 - rear
 - upper
 - rh (1) **CAJ100340**
 - lh (1) **CAJ100350**
 - lower
 - rh (1) **CAJ100320**
 - lh (1) **CAJ100330**
- Nut - roof rails (4) **ANR4477**

Roof Finisher - Drip Rail

- Finisher - roof drip rail;
 - rear centre (1) **AWR4418**
 - rear corner
 - rh (1) **DBC101400**
 - lh (1) **DBC101410**
 - side
 - rh (1) **DBC101620**
 - lh (1) **DBC101630**
 - front corner
 - rh (1) **DBC101680**
 - lh (1) **DBC101690**

Spare Wheel Carrier

- Carrier - spare wheel (1) **ASR1579**
- Spacer - spare wheel carrier (2) **ANR5040**
- Bolt - spare wheel carrier;
 - M8 x 80mm (5) **FB108161L**
 - M8 x 85mm (1) **FB108171L**
- Nut - flanged head (M8) (6) **FN108047L**
- Centre - spare wheel (1) **AFZ700010MNH**
- Nut - spare wheel retention;
 - steel wheel (3) **ANR5380**
 - locking (alloy wheel) (1) **RRB100510**
- Washer - plastic - spare wheel (3) **KYF100270**

Door Mirrors

- Door mirror - electric;
 - non power-folding
 - rh (1) **CRB501300PMA**
 - lh (1) **CRB501310PMA**
 - power-folding
 - rh (1) **CRB501380PMA**
 - lh (1) **CRB501370PMA**
- Mirror glass - door mirrors;
 - convex glass
 - rh (1) **CRD100640**
 - lh (1) **CRD100650**
 - flat glass
 - rh (1) **CRD100680**
 - lh (1) **CRD100690**
- Retaining plate - door mirror;
 - rh (1) **CRW500060**
 - lh (1) **CRW500070**
- Insulation pad - mirrors (2) **ETE100180**



DOOR MIRROR
CRB501300PMA

DESCRIPTION	QTY REQ.	PART No.	DESCRIPTION	QTY REQ.	PART No.	DESCRIPTION	QTY REQ.	PART No.
-------------	----------	----------	-------------	----------	----------	-------------	----------	----------



Badges & Transfers

- 'LAND ROVER' oval badge - grille (1) **DAG100330**
- Front badge - 'LAND ROVER' - bonnet; grey (1) **DAG100370LQQ**
- silver (1) **DAG100370MAD**
- gunsmoke silver (1) **DAG100370MNZ**
Adventurer.



- Rear Badge - 'DISCOVERY'; grey (1) **DAH100720LQQ**
- silver (1) **DAH100720MAD**
- gunsmoke silver (1) **DAH100720MNZ**
Adventurer.

- 'Td5' badge; grey (1) **DAM100750LQQ**
- silver (1) **DAM100750MAD**
- gunsmoke silver (1) **DAM100750MNZ**
Adventurer.

- 'V8' badge; grey (1) **DAL103720LQQ**
- silver (1) **DAL103720MAD**
- gunsmoke silver (1) **DAL103720MNZ**
Adventurer.

- 'SERIES II' badge (1) **DAH100820**

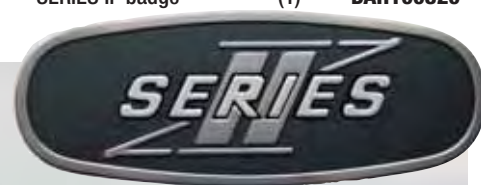

Door Trim Panels

Door trim panel

Please contact our sales department for price and availability of door trim panels.

Stud - door trim panel fixing (a/r) **MWC9134**
 Snap-clip - door trim panel fixing(a/r)**EYC101460**

GEAR LEVER SURROUND
FJV101830

GEAR LEVER SURROUND
FJV101650

Gear Lever Surround

Finisher/switch panel - gear lever;
Wood trim.

5-switch			
manual			
rhd	(1)	FJV101830	
lhd	(1)	FJV101840	
automatic			
rhd	(1)	FJV101850	
lhd	(1)	FJV101860	
7-switch			
manual			
rhd	(1)	FJV101630	
lhd	(1)	FJV101640	
automatic			
rhd	(1)	FJV101650	
lhd	(1)	FJV101660	

Bezel - gear selector - automatic (1) **AWR3700PMA**

Gaiter - outer - manual;
main gear lever
for wood trim (1) **FJL101900PMA**
for non-wood trim (1) **FJL101680PMA**
hi/low lever
for wood trim (1) **FJL101530PMA**
for non-wood trim (1) **FJL000010PMA**

Gaiter - inner - gear lever (1) **AWR5526**
Manual & auto.

Seal - gear selector mechanism(1) **AWR5525**
Manual & auto.

Insulation foam - gearlever;
manual (1) **AWR5528**
automatic (1) **AWR5527**



REAR VIEW MIRROR
AWR2146

Rear View Mirror

Rear view mirror;			
manual dim	(1)	AWR2147	
auto dim			
up to VIN XA232916	(1)	AWR2146	
with compass	(1)	CTB000010	
Adhesive pad - rear view mirror	(1)	STC118	



Sunvisors

Sunvisor - rhd:			
rh			
illuminated mirror	(1)	EDQ105600LUM	
non-mirror	(1)	EDQ105500LUM	
lh			
illuminated mirror	(1)	EDQ105590LUM	
non-illuminated mirror	(1)	EDQ105510LUM	
Sunvisor - lhd:			
rh			
illuminated mirror	(1)	EDQ105580LUM	
non-illuminated mirror	(1)	EDQ105480LUM	
lh			
illuminated mirror	(1)	EDQ105610LUM	
non-mirror	(1)	EDQ105490LUM	

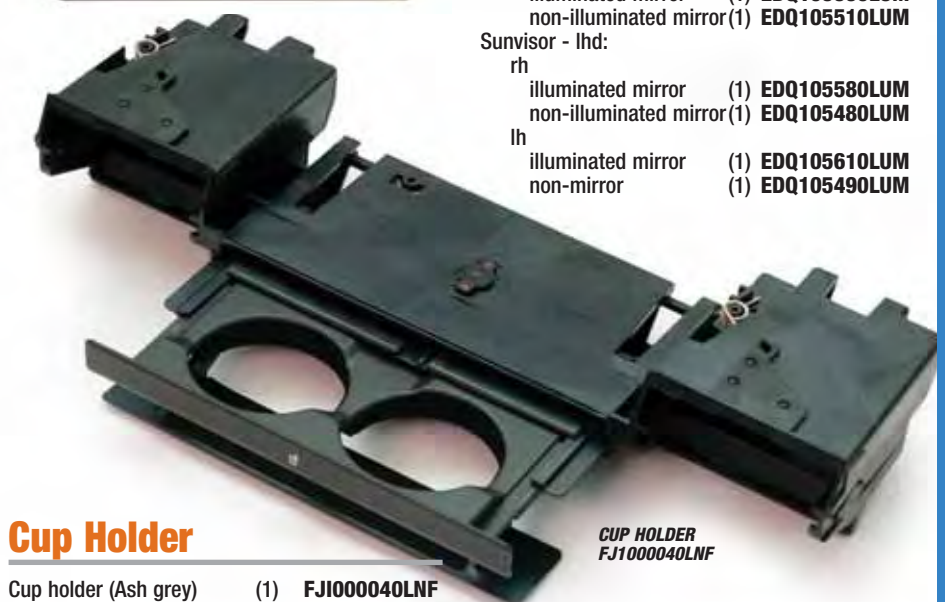

CUP HOLDER
FJ1000040LNF

Cup Holder

Cup holder (Ash grey) (1) **FJI000040LNF**

DESCRIPTION QTY REQ. PART No.

Seats

Please contact our sales department for price & availability of complete seats.

Heating element - heated seat - front;		
non-electric seats		
seat base	(2)	HGT500040
seat back	(2)	HGT500050
electric seats		
seat base	(2)	HGT500020
seat back	(2)	HGT500030
Module - seat heater - front (1)		AWR500030
Motor - front seat;		
front	(2)	HAK100050
rear	(2)	HAK100060
horizontal	(2)	HAK100040



Seat Covers

Waterproof seat covers;
Genuine Land Rover tailored seat covers available for all seats. Headrests included.
Seat covers come in the following colours (when ordering, add the appropriate colour code to the seat cover part number):

Alpaca	SMS
Light Tundra	HPP
Dark Tundra	HPQ
Dark Smokestone	LPW
Bahama Beige	SUC
Lightstone	SMK
Black	PUY

front pair		
electric seats	(1)	STC50054
manual seats	(1)	STC50055
rear (2nd row) pair	(1)	STC50056
occasional (3rd row) seats	(1)	STC50057



DESCRIPTION QTY REQ. PART No.



Seat Belts

Seat belt - front;
Belt only - not supplied with pretensioner.

driver's	
standard length	(1) EVB000710LNF
extended length	(1) EVB110520
passenger's (standard length)	
up to VIN YA281176	(1) EVB000700LNF
VIN YA281177 on	(1) EVB000720LNF

Seat belt - rear;	
2nd row seats	
outer	(2) EVL000450LNF
centre	(1) EVL000210PMA
3rd row seats	
up to VIN XA236340	(2) EVL000780LNF
VIN XA236341 on	(2) EVL000790LNF

DESCRIPTION QTY REQ. PART No.

Headlining

Headlining;		
non-sunroof		
without rear air-con	(1)	EDB000611LUM
with rear aircon	(1)	EDB000621LUM
with sunroof		
without rear air-con	(1)	EDF000471LUM
with rear aircon	(1)	EDF000441LUM
Fastener -		
headlining (fir tree)	(a/r)	EZM100320



Loadspace Cover

Loadspace cover;	
smokestone	(1) ERK500130LPW
Bahama beige	(1) ERK500130SUC



Carpets

Carpet;		
front floor		
rhd		
dark smokestone	(1)	AWR3580LPW
Bahama beige	(1)	AWR3580SUD
lhd		
dark smokestone	(1)	AWR3582LPW
Bahama beige	(1)	AWR3582SUD
centre section		
dark smokestone	(1)	AWR3584LPW
Bahama beige	(1)	AWR3584SUD
rear floor		
5 seats		
dark smokestone	(1)	AWR3586LPW
Bahama beige	(1)	AWR3586SUD
7 seats		
dark smokestone	(1)	EAG100620LPW
Bahama beige	(1)	EAG100620SUD



Floor Mats

Footwell mats;		
carpet mats - vehicle set		
<i>Tailored to fit the Discovery footwells (front & rear). With embroidered "Discovery" logo. Waterproof backing.</i>		
Tundra	(1)	STC53183HPQ
Black	(1)	STC53183PUY
Bahama Beige	(1)	STC50047
Slate Grey	(1)	STC50046
rubber mats		
<i>With Land Rover logo.</i>		
vehicle set (front & rear)	(1)	STC50048AA
front set (pair)	(1)	STC50049AA



Loadspace mat - rubber;		
<i>Available in full-length (rear seats folded down) or half-length (loadspace only).</i>		
full-length	(1)	STC50053AA
half-length	(1)	STC50052AA



Loadspace liner;		
<i>Very strong, rigid acrylic liner with high sides. Available in full-length (rear seats folded down) or half-length (loadspace only).</i>		
full-length	(1)	STC50051
half-length	(1)	STC50050

**LOADSPACE LINER
STC50050**



Tread Plate

Tread plate - door aperture;		
<i>Black.</i>		
front	(2)	EAP100700PUB
rear		
rh	(1)	EAP100720PUB
lh	(1)	EAP100730PUB
loadspace area	(1)	EAN101180PUB
Insert - tread plate;		
front	(2)	EBZ100000PUB
rear	(2)	EBZ100010PUB
loadspace area	(1)	EBZ100030PUB
Self-tapping screw -		
tread plate	(a/r)	AB610061L

DESCRIPTION PART No. DESCRIPTION PART No. DESCRIPTION PART No.

WIND DEFLECTOR



Wind deflectors - set of 4
Fit to door frames. **STC50066**

SIDE STEPS

Side steps - pair;
Original equipment & aftermarket.
black
'Chevron' design
'Oasis' design
stainless steel



STC50030
STC50031
STC50032



BLACK CHEVRON DESIGN



BLACK OASIS DESIGN



STAINLESS STEEL

UNDERSIDE PROTECTION BAR

Underside protection bar
Fits underneath the front of the vehicle
to protect steering linkages.

ABY100000

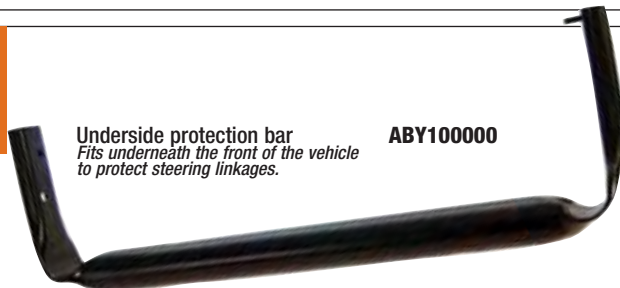

LAMP GUARDS



RD1205SS

DISCOVERY

RD1205

RD1205SS

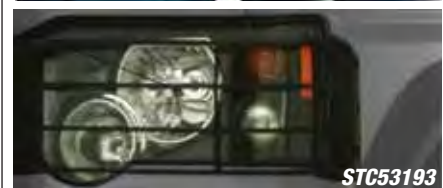

STC53193



STC53194



STC50026

Lamp guards (removable);

OE (Made from impact resistant plastic)

front - pair

up to '03 model year

STC50026

'03 model year on

STC53193

As shown in vehicle photo.

rear - pair

upper

STC53194

lower (rear bumper)

VUB500520

aftermarket - rear only

Made from black powder-coated steel

or polished stainless steel. As shown in vehicle photos.

black - upper lamps only

RD1205

stainless steel - upper & lower

RD1205SS



VUB500520

BULL BARS



WRAPAROUND BAR



'A' BAR



CENTRE FINISHER SECTION

Bull bars;

genuine Land Rover (polyurethane)

& aftermarket

Suitable for use with air bags.

Soft-type bars.

wraparound bar

up to '03 model year

STC50020

'03 model year on

STC53173

'A' bar

up to '03 model year

STC50021

'03 model year on

STC53174

centre finisher section

VUB500480

Optional, paintable finisher (supplied primed),
integrates the bull bar with the bumper.

LOCKABLE CROSSBARS



Lockable crossbars - pair
For standard roof rails.
Black powder-coated aluminium.

STC50175

ROOF RAILS EXTENSIONS



Roof rail extensions - pair
For vehicles with factory-fitted roof rails. Seamlessly extend the vehicle's roof rails to the full length of the roof. Compatible with lockable crossbars.

STC50034AA

SPORTS BARS

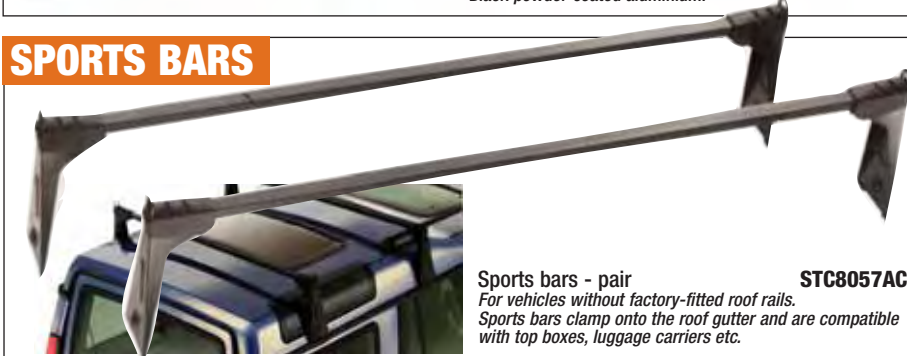

Sports bars - pair
For vehicles without factory-fitted roof rails. Sports bars clamp onto the roof gutter and are compatible with top boxes, luggage carriers etc.

STC8057AC

ACCESS LADDER



Access ladder
Neatly bolts to rear door for access to roof racks. Black powder-coated steel.

STC50134

ROOF RACKS

Roof rack;

Expedition roof rack
Heavy duty, full-length roof rack. Clamps to roof gutter.

STC8830AA

standard roof rack
Steel and aluminium roof rack for the raised part of the roof. Clamps to roof gutter.

RTC9539AB



REAR STEP



Rear step
For easier access to the rear of the vehicle and to the access ladder.

STC50290

LUGGAGE CARRIER RACK

Luggage carrier rack
Can be used either way up, to create a flat-bed or 'basket'. Fits either crossbars or Sports bars. Aluminium.

STC50176AA



QUICK STRAP KIT



Quick strap kit
For sports bars only. Kit contains 2 quick straps which easily adjust to any load.

STC7566

DESCRIPTION

PART No.

DESCRIPTION

PART No.

DESCRIPTION

PART No.

LUGGAGE BOX

Luggage box

450 litres volume, 160cm x 96cm x 41cm.
Fits roof rails with crossbars or Sports bars.
Lightweight acrylic.

CAK500010



CARRIERS



Ski carrier

Fits roof rails with crossbars or Sports bars.
Carries 2 pairs of water skis or 3 pairs of snow skis with poles.

CAN500020



Ski & snowboard carrier

Fits roof rails with crossbars or Sports bars.
Carries 3 pairs of snow skis with poles & 2 Snowboards.

STC50177AA



Sailboard carrier;

Includes: adjustable mast holders and straps, protective padding for sailboard and nylon tie-straps.

for crossbars
for Sports bars

CAB500030

STC8435

BIKE CARRIER



Bike carrier - tow bar-mounted

Carries 2 bikes without hindering trailer-towing.
Includes bike tie-down straps.

STC50063

TRAILER BOARD



Trailer board (4') (Including 4m cable)

RX1513

SPORTS BOX



Sports box

400 litres volume, 230cm x 62cm x 39cm.
Fits roof rails with crossbars or Sports bars.
Lightweight acrylic.

CAK500020

ROADSIDE EQUIPMENT



WARNING
TRIANGLE

FIRE EXTINGUISHER

FIRST AID KIT

AA MEMBERSHIP
& RELAY PACK

SAFETY
JACKET

RUBBER
GLOVES

Tool kit

Basic maintenance and repair kit in a moulded box.

STC8244AB

Touring kit

Includes: first aid kit, bulb kit, warning triangle and Land Rover umbrella.

STC7655

Tyre pressure/tread depth gauge kit

Lightweight Disposable Overalls

Medium (approx 47" chest)

Large (approx 51" chest)

Extra large (approx 55" chest)

Rubber Gloves (100)

Bulb kit (Contains the main bulbs and fuses);

'03 onwards

up to '03

AA membership & Relay pack

Warning triangle

Safety jacket (luminous)

First aid kit

Fire extinguisher

STC724

RX1408M

RX1408L

RX1408XL

RX1406

VUB001060

STC8247AA

RX1329

RX1344

GAC2999

RX1399

GAC9904

DRIVING LAMPS



Driving lamp kit - clear lens **STC53196AA**
Land Rover design, 55w halogen lamps with clear lens technology. Can be fitted to 'A' bar (if fitted) or on to bumper using the brackets.

Lamp covers (pair) - for STC53196AA **VUS500010**
 Mounting brackets - for STC53196AA **VUB500470**
For fitting driving lamps to bumper.

FOG LAMPS LAMPS



Rally 1000 lamps - up to '03 model year only;
With black plastic mesh grille and Land Rover logo.

driving lamp - each **STC7644**
 fog lamp - each **STC7643**
 Lamp covers - pair **STC7661**
 Steady bars - pair **STC8814**
Suitable for Rally 1000 & Safari 5000 lamps.
 Wiring kit - Rally 1000/Safari 5000 **STC50039**

FOG LAMPS



Fog lamp kit - spoiler-mounted **STC50029**
Pre-'03 model year.

Facia switch - fog lamp kit **STC50098**
 Adhesive - fog lamp kit **STC50162**

SAFARI 5000 LAMPS



Safari 5000 lamps - up to '03 model year only;
With silver plastic mesh grille.

driving lamp - each **STC8480**
 fog lamp - each **STC8481**
 Lamp covers -Safari 5000 - pair **STC50097**
 Steady bars - pair **STC8814**
Suitable for Rally 1000 & Safari 5000 lamps.
 Wiring kit - Rally 1000/Safari 5000 **STC50039**

HEADLAMP PROTECTORS



Headlamp protectors - pair **STC50064**
Pre-'03 models with air suspension.

HEADLAMP CONVERTERS



Headlamp converters - continental **STC50065**
Pre-'03 model year only. Pair.

LAMP MOUNTING BAR



Lamp mounting bar - Rally 1000/Safari 5000;
 black finish **STC50243**
 stainless steel **STC50244**

DESCRIPTION

PART No.

SPARE WHEEL COVERS



VINYL

MOULDED



RIGID
(S/STEEL RIM)

Spare wheel cover;
All with Land Rover badge.

vinyl

215 x 16

STC50068

235 x 16

STC8486AB

255 x 16 & 18

STC50069

moulded

215 x 16

STC50041

235 x 16

STC50042

255 x 16 & 18

STC50043

rigid (s/steel rim)

215 x 16

STC50137

235 x 16

STC50138

255 x 16

STC50139

255 x 18

STC50140

PARKING SENSOR KIT



Parking distance sensor kit **STC50424AA**

Ultrasonic sensors mounted in the rear bumper. When reverse is engaged, an intermittent 'beep' is heard, which becomes more rapid as the vehicle moves closer to an obstacle.

DESCRIPTION

PART No.

WHEEL ARCH MOULDINGS



Wheel arch mouldings
Required when fitting 18" alloys.
Vehicle set.

STC50242



BODY SIDE MOULDING KIT

Body side moulding kit;
plain black
black with bright inserts

STC50061

STC50168

GRAPHIC BODY SIDE PROTECTORS

Graphic body side protectors;
Self-adhesive 'graphic' film, which protects against scuffs
and scratches. Choice of 2 designs.

'Shades' for vehicles

with body side mouldings

STC50497

without body side mouldings

STC50040

'Chevron' for vehicles

with body side mouldings

STC50498

without body side mouldings

STC50060

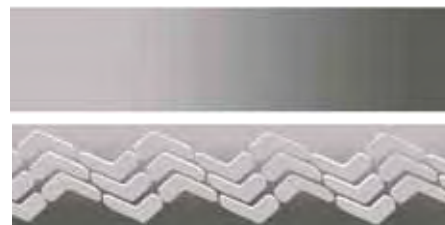

MUD FLAP KIT



Mud flap kit;
front
rear
See page 31 for mudflap fittings.

STC50067
RD1204

STANDARD SHOCK ABSORBER KITS



Standard shock absorber kit;
Includes 2 front and 2 rear standard shock absorbers.
(ACE = Active Cornering Enhancement).

- | | |
|------------------------------------|---------------|
| standard suspension
with ACE | RD1181 |
| non-ACE | RD1182 |
| active ride suspension
with ACE | RD1183 |
| non-ACE | RD1184 |

UPRATED SHOCK ABSORBER KITS

BILSTEIN



**BILSTEIN - GAS,
HEAVY DUTY,
NON ADJUSTABLE**



**KONI - OIL FILLED,
ADJUSTABLE**

Upated shock absorber kit - vehicle set;
Bilstein are heavy duty, gas, non-adjustable shock absorbers.

- | | |
|--|----------------|
| Koni are oil-filled, adjustable (off-car) shock absorbers. | |
| Bilstein (set of 4) | RD1200B |
| Koni (set of 4) | RD1200K |

- | | |
|---|-------------------|
| Upated shock absorbers - front or rear (pairs); | |
| Bilstein | |
| front (pair) | RNB103683B |
| rear (pair) | RNB103683K |
| Koni | |
| front (pair) | RPD102343B |
| rear (pair) | RPD102343K |

REAR COIL SPRING CONVERSION KIT

Rear coil spring conversion kit
A straightforward DIY conversion kit which replaces the Discovery's rear air suspension (where fitted) with conventional coil springs. A cost-effective solution for vehicles with faulty EAS or for owners who favour coil spring suspension. ECU will need re-programming.
Note: we recommend fitting new shock absorbers at the same time.



RD1206

STANDARD & UPRATED BUSH & BOLT KITS

**BOLT KIT -
RD1185**



Bolt kit - suspension **RD1185**
Contains the bolts and nuts required when renewing the suspension bushes.

**STANDARD
BUSH KIT -
RD1186**



Standard Bush Kit;
Direct replacement of original bushes. Kit contains a comprehensive vehicle set of standard suspension bushes, as follows: front & rear radius arm, panhard rod, Watts linkage, shock absorber and anti-roll bar/ACE assembly bushes, as appropriate.
(ACE = Active Cornering Enhancement).

- | | |
|------------------------|---------------|
| with ACE | RD1186 |
| non-ACE | |
| coil spring suspension | RD1187 |
| air suspension | RD1188 |

**POLY BUSH KIT -
RD1189**



Poly Bush kit **RD1189**
Polybush 'Dynamic' kit for more positive ride and handling. Easy to fit and very long lasting. Kit includes replacements bushes for front & rear radius arm, panhard rod and Watts linkage. Does not include shock absorber, anti-roll bar or ACE bushes. See **Supplementary Kits**, below, for these bushes.

Polyurethane bush kit (alternative) **RD1189AP**
High quality bushes made from black polyurethane. Kit includes replacements bushes for front & rear radius arm, panhard rod and Watts linkage. Does not include shock absorber, anti-roll bar or ACE bushes. See **Supplementary Kits**, below, for these bushes.

- | | |
|--|-------------------|
| Supplementary poly bush kit;
Includes bushes not supplied in polyurethane kits, as follows: shock absorber upper and lower, anti-roll bar (non-ACE vehicles) and steering damper. | |
| non-ACE vehicles | |
| coil spring suspension | RD1190POLY |
| air spring suspension | RD1191POLY |
| vehicles with ACE | RD1192POLY |
| Shock absorber and steering damper bushes only. | |

UPRATED STEERING DAMPER



Upated steering damper **QHH10001UR**

UPRATED BRAKE DISCS & PADS



EBC UPRATED FRONT DISCS & PADS

Brake disc - uprated;
front
EBC Turbo Groove (pair) **NTC8780UR**
Rossini (pair) **NTC8780ROS**
rear
EBC Turbo Groove (pair) **SDB000470UR**
Rossini (pair) **SDB000470ROS**

Brake pads - uprated;
EBC Kevlar "Green Stuff" fast road.
front (set) **SFP100460UR**
rear (set) **SFP100470UR**

EBC BRAKE DISCS

EBC turbo groove discs are handed (lh & rh) with curved grooves and dimples to offer superb stopping power when combined with 'Green Stuff' Kevlar pads.



EBC BRAKES

ROSSINI UPRATED BRAKE DISCS

Performance drilled and grooved. Improved stopping power, reduced brake fade. Unique signature for improved safety. Superb quality. Use EBC Brake Pads with these discs.



Rossini

STAINLESS STEEL EXHAUSTS

See pages 21-22 for details on standard and sports exhaust systems in Stainless steel.



K&N AIR FILTERS



See page 20 for details on the K&N replacement filter for the standard element and maintenance products.

WINTER WIPER BLADES



Winter wiper blades - front (pair) **DKC500010PMD**
Blade remains flexible in freezing conditions and is encased in rubber to prevent the ingress of snow and ice.



PERFORMANCE ENHANCEMENT

- Increased torque
- Improves mileage
- Cuts emissions



Hiclone is a simple non moving stainless steel device that sits inside the air induction system of an engine. Like a static mixer, it vigorously swirls the air. The swirling effect improves the fuel/air mixture promoting more complete combustion. Hiclone increases torque, improves fuel consumption and cuts hydrocarbon emissions: in particular smoke.

Fit Hiclone in front of a Land Rover Turbo Charger and feel the difference (see graph). See how it improves low down grunt, acceleration and reduces turbo lag. Hiclone can also be fitted to non turbo diesel and petrol engines - feel the difference!

Hiclone also smoothes out the engine torque curve, resulting in a reduction in gear changes and a quieter engine especially on the motorway. With Hiclone fitted you can corner in a higher gear, this makes the vehicle easier to drive and improves the ride.

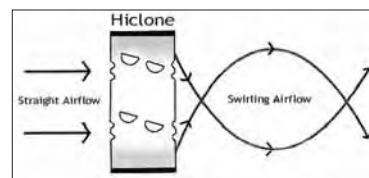
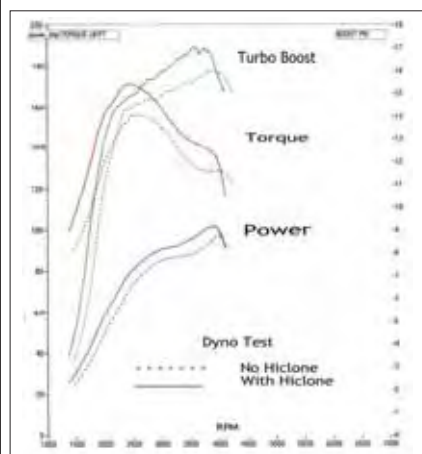

Application	Engine	Part No
DISCOVERY 2	TD5	RD1165
	4.0 V8 Efi	RD1166

18" ALLOY WHEEL & WHEEL-TYRE PACKAGES

We offer a superb range of Genuine Land Rover alloy wheels to enhance and upgrade your Discovery II.

Made from M25 alloy, they are X-ray checked to ensure safety and optimum performance.

The alloy wheels shown here are designed specifically for Land Rover vehicles, ensuring peace of mind in all situations.

HURRICANE



'Hurricane'

Land Rover alloy wheel (10-spoke)
Silver sparkle, less centre & nuts (8J x 18).

wheel only (each) **RRC501470MNH**
wheel set (4) **RRC501470MNHK**

Land Rover alloy wheel (10-spoke) & tyre
Silver sparkle, less centre & nuts (8J x 18).
Fitted with quality 255/55 R18 tyre and balanced.

wheel & tyre (each) **RRC501470MNHHT**
wheel & tyre set (4) **RRC501470MNHKT**

MONDIAL



'Mondial'

Land Rover alloy wheel (5-spoke)
Silver sparkle, less centre & nuts (8J x 18).

wheel only (each) **RRC115410MNH**
wheel set (4) **RRC115410MNHK**

Land Rover alloy wheel (5-spoke) & tyre
Silver sparkle, less centre & nuts (8J x 18).
Fitted with quality 255/55 R18 tyre and balanced.

wheel & tyre (each) **RRC115410MNHHT**
wheel & tyre set (4) **RRC115410MNHKT**

TRIPLE SPORT



'Triple Sport'

Land Rover alloy wheel (6-spoke)
Silver, less centre & nuts (8J x 18).

wheel only (each) **STC8516**
wheel set (4) **STC8516K**

Land Rover alloy wheel (6-spoke) & tyre
Silver, less centre & nuts (8J x 18).
Fitted with quality 255/55 R18 tyre and balanced.

wheel & tyre (each) **STC8516T**
wheel & tyre set (4) **STC8516TKT**

COMET



'Comet'

Land Rover alloy wheel (6-spoke)
Silver, less centre & nuts (8J x 18).

wheel only (each) **RRC000930MCM**
wheel set (4) **RRC000930MCMK**

Land Rover alloy wheel (6-spoke) & tyre
Silver, less centre & nuts (8J x 18).
Fitted with quality 255/55 R18 tyre and balanced.

wheel & tyre (each) **RRC000930MCMHT**
wheel & tyre set (4) **RRC000930MCMKT**

PROSPORT



'ProSport'

Land Rover alloy wheel (5-spoke)
Silver sparkle, less centre & nuts (8J x 18).

wheel only (each) **ANR4849MNH**
wheel set (4) **ANR4849MNHK**

Land Rover alloy wheel (5-spoke) & tyre
Silver sparkle, less centre & nuts (8J x 18).

wheel & tyre (each) **ANR4849MNHHT**
wheel & tyre set (4) **ANR4849MNHKT**

BBS 2-PIECE



'BBS 2-Piece'

Land Rover alloy wheel (5-spoke)
Silver sparkle, less centre & nuts (8J x 18).

wheel only (each) **RRC500150MNH**
wheel set (4) **RRC500150MNHK**

Land Rover alloy wheel (5-spoke) & tyre
Silver sparkle, less centre & nuts (8J x 18).

wheel & tyre (each) **RRC500150MNHHT**
wheel & tyre set (4) **RRC500150MNHKT**

Wheel Nuts & Centres

NB: existing wheel nuts and centres may be re-used when changing wheel size (eg. from 7J x 16 to 8J x 18). However, we recommend locking wheel nuts if not fitted.

Wheel nuts;

standard
each (20) **ANR3679**
set of 20 (1) **ANR3679K**

locking
set of 4 (1) **STC8513**
set of 4 + 16 standard nuts (1) **STC8513K**

spare wheel retaining (3) **RRD100640**

Wheel centre cap (with logo);

Silver sparkle
all silver (4) **ANR3522MNH**
with green logo (4) **RRJ500030MNH**

Gunsmoke silver (4) **RRJ100140MNH**

Badge - centre cap - gold (4) **DAG100310**

TYRES



Tyre size;

255/55 R18 (18" wheel) (4) **255/55R18**

235/70 R16 (standard wheel) (4) **235/70R16**

255/65 R16 (standard wheel) (4) **255/65R16**

Several quality makes available.
Contact us for best prices and availability.



Autoglym 'Clean Wheels'
500ml. Alloy wheel cleaning solution. (a/r) **RX1322**

Autoglym 'Tyre dressing'
Makes tyres look like new! (a/r) **RX1368**



Power Digital Box2

www.rimmerbros.co.uk

DIESEL PLUG-IN POWER UPGRADE

FOR LAND ROVER ENGINES:

TD4 FREELANDER	TD5 DISCOVERY DEFENDER	TD-V6 DISCOVERY 3 RANGE ROVER SPORT	TD6 RANGE ROVER (2002 ON)	2.5TD RANGE ROVER (1995-2002)
--------------------------	-------------------------------------	---	--	--

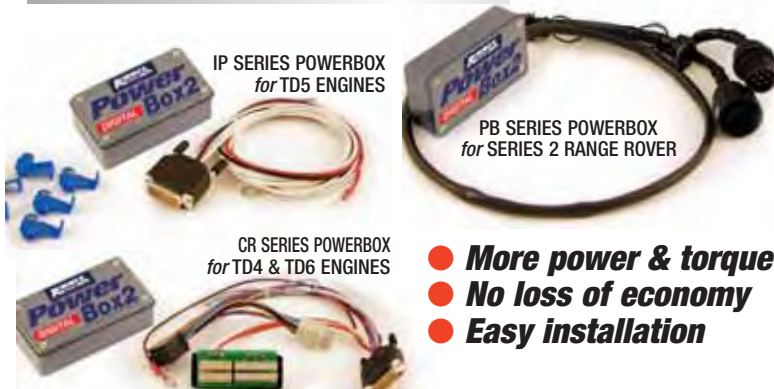

PLUG IN A Power Box!

Installation is relatively easy, with no specialist tools or skills required. No irreversible modifications are made - the Power Box can be removed just as easily and the vehicle reverts to its original state.

HOW DOES IT WORK?

Power Box is a high quality, *digital* management upgrade, incorporating a modern RISC microprocessor. The "chip" is carefully programmed - using the manufacturers standard fuel map as a foundation - and modifies the opening times of the injectors, which then accurately meters the extra fuel required. Unlike many *analogue* devices, which crudely over-fuel throughout the entire rev-range, each Power Box is specifically mapped for the intended application. Extra fuel is provided when needed - eliminating flat-spots and hesitation - but there is no unnecessary enrichment, meaning no loss of fuel economy and no *black smoke*. In fact, most Power Box users report a noticeable improvement in fuel economy, as they discover it's no longer necessary to work their vehicle so hard.

WHERE IS IT FITTED?

On most vehicles, the Power Box fits under the bonnet, interrupting the wiring loom from the engine ECU. All Power Boxes are fitted with the original vehicle connectors, so installation is simply a case of unplugging the relevant connector and plugging in the Power Box. Full instructions are supplied and no special tools or skills are required.

Power Boxes are small, neat and discrete. They are fully encapsulated in resin and are shock resistant. Care, of course, should be taken to locate the Power Box away from the effects of water.

HOW MUCH POWER WILL I GAIN?

On average, Power Boxes give around 20% increase in power and 15-20% increase in torque (see the power table opposite). However, more important is how the vehicle *feels*: throttle response, crispness and driveability are all immeasurably improved, while flat-spots and sluggishness are virtually eliminated.

ADDITIONAL POWER GAINS

We also strongly recommend fitting a K&N air filter with a Power Box. This will allow the engine to breathe and perform more efficiently (K&N's can also be cleaned and re-used). In addition, fitting one of our stainless steel exhausts will also have the benefits of extracting exhaust gasses more effectively, with reduced back pressure, increased flow and improved turbo response - they look good too! If you wish to go further than this, consider an uprated intercooler (see page 21) for a truly efficient turbo diesel engine. With each of these enhancements, your Power Box can be adjusted to give even better results. Please see the tables below.

WHY NOT JUST HAVE MY ECU RE-CHIPPED?

Unlike an ECU chip, a Power Box can be fitted and removed easily. Also, as the Power Box doesn't disturb the ECU, its presence cannot be detected by diagnostic equipment. Finally, when the vehicle is sold, the Power Box can simply be removed if required and refitted to another vehicle.

In addition, Power Boxes are:

- ✓ TUV approved.
- ✓ Fully compliant with original exhaust emissions standards.
- ✓ Non-damaging to your engine.
- ✓ Power Box is covered by a 3 year guarantee (limited liability).

ISSUE 4 © Copyright. Rimmer Bros Ltd, 2006.

Significant power & torque increases are achieved by simply plugging in a Power Box.

DIESEL PLUG-IN POWER UPGRADE

THE ADDITIONAL OUTPUT FIGURES ARE THE MINIMUM THAT CAN BE OBTAINED

MODEL	APPLICATION	VIN/ CHASSIS*	STANDARD OUTPUT		ADDITIONAL OUTPUT WITH POWER BOX		PART NO
			BHP	TORQUE (NM)	BHP	TORQUE (NM)	
Defender	Td5 1999 ON	TA ON	122	300	33	65	LL1340
Discovery 2	Td5 1999 ON	TA ON	137	300	21	65	LL1340
Discovery 3	TdV6 2005 ON	5A ON	189	440	22	50	RD1175
Range Rover	2.5td (P38) 1995 on	MA ON	136	268	25	42	RA1456
Range Rover	3.0 Td6 2002 on	2A ON	177	390	26	50	RA1458
Range Rover	SPORT 2005 on	5A ON	189	440	22	50	RD1175
Freelander	Td4 2000 on	YA ON	112	260	18	40	LF1071

*Please quote chassis number when ordering.

"It does what it says on the label"

Land Rover Enthusiast Magazine (March 2004) carried a 3 page feature fitting and testing a Plug-In Powerbox upgrade to a Series 2 (P 38A) Range Rover. A full version of this feature can be found on our website www.rimmerbros.co.uk

"Claim Rimmer Bros: you can expect an increase of 25 bhp and 42 Nm (31 lb ft) of torque. New printout figures with the Powerbox fitted showed it was producing 169 bhp at 4160 rpm - an increase of 31 bhp. And the torque had increased as well, to 242 lb ft (328 Nm) - an increase of 45 lb ft (60Nm)....."

"As for the claims on power and torque, then the Powerbox had done just what it claimed and more. Very impressive!....."

"You just unplug the wiring harness going to the fuel pump and connect the Powerbox in line, and then do the same with the wiring connection to the fuel filter. As for being easy to fit and remove... well, yes it is....."

"However the most impressive thing about the Powerbox is not a claim that is actually made for it. It's the better driveability it gives the vehicle. It gives more grunt, changing the sluggish diesel Range Rover into a much livelier vehicle, especially when pulling away....."

"The power is now there when you require it....."

"The Range Rover is much nicer to drive....."

"In all, we reckoned the Powerbox would be a good buy for any 38A owner. It totally changed the diesel Range Rover....."

STAINLESS STEEL EXHAUST SYSTEMS

MODEL (Cat back)	APPLICATION	PART NO.
Defender <i>Large bore exit</i>		
90	Td5	LR1127
110	Td5	LR1128
130	Td5	LR1129
Discovery <i>Large bore exit</i>	Td5	RD1198SS
Range Rover <i>Twin large bore or quad exit</i>	2.5td (P38A)	RA1088D
Range Rover <i>Twin large bore exit</i>	3.0 Td6	RA1455
Freelander <i>Rear Silencer</i>	Td4	LF1072



K&N AIR FILTERS

MODEL	APPLICATION	PART NO.
Defender	Td5	ESR4238KN
Discovery	Td5	ESR4238KN
Discovery	TdV6	PHE00012KN
Range Rover	2.5td to '99	ESR341KN
Range Rover	2.5td '00 on	ESR4238KN
Range Rover	3.0 Td6	PHE00040KN
Range Rover	TdV6	PHE00012KN
Freelander	Td4	PHE100500LKN

Power Boxes also available for other makes of diesel vehicle, including: ALFA AUDI BMW CHRYSLER CITROEN FIAT FORD HONDA HYUNDAI IVECO JEEP KIA LANCIA MAZDA MERCEDES MG MITSUBISHI NISSAN OPEL PEUGEOT RENAULT ROVER SAAB SEAT SKODA SUZUKI TOYOTA VOLVO VW

ORDER ON: 01522 568000 / www.rimmerbros.co.uk

PART NUMBERS: A 'P' suffix in the Price Guide denotes "Aftermarket".

DOG GUARD

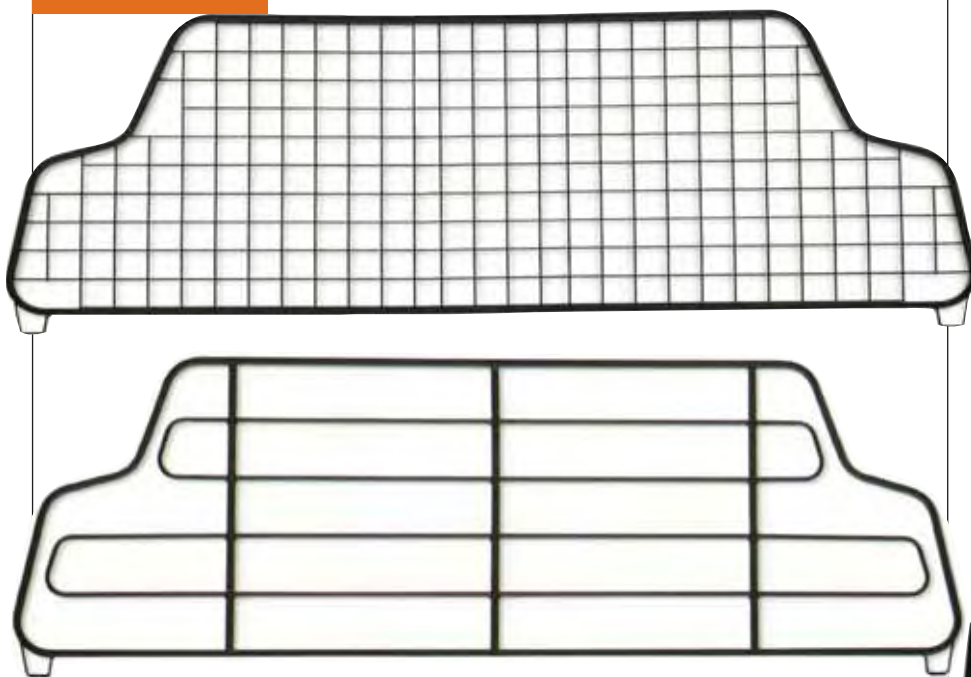

Dog Guard;
Available in 2 styles: mesh- and bar-type.
Easily removed when not required.

mesh-type
bar-type

STC50323
STC50082AA

TOY BIN



Toy bin;
Fits into loadspace recesses when occasional seats are in use. Features cup-holder recesses in the lid and a carrying strap.

Bahama beige
Dark Smokestone

STC50070SUC
STC50070LPW

GUN/SECURITY BOX



Gun/security box
Heavy gauge steel with two high-security locks.
The interior is foam-padded.

STC8018AB

Fitting kit - gun box

STC50076

WOOD INTERIOR ENHANCEMENT KITS



Wood interior enhancement kits;

burr walnut veneer kit **FDG500010ANV**
Real burr walnut veneer kit, includes centre console panel, side air vent surrounds and passenger facia trim panel.

wood enhancement kit **STC50285**
As above, but with replacement panel in burr walnut, rather than adhesive veneers.

wooden front door cappings **STC50317**
Burr walnut trims to complement the facia trim kits. Front doors only.

wooden gear knob kit
Includes manual and low ratio knobs.

with diff' lock **IGC500030ANV**
no diff' lock **IGC500020ANV**
wooden handbrake grip **SNE500010ANV**

CUBBY BOX PHONE LID

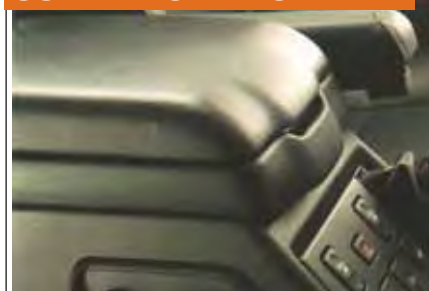

Cubby box phone lid;
A replacement double-lid for the cubby box.
The upper lid contains a phone recess; the lower lid gives access to the cubby box.

Available in leather or non-leather.
When ordering, add the appropriate colour code to the leather or non-leather part number:

Alpaca	SMS	(non-leather only)
Tundra	HPP	(non-leather only)
Dark Smokestone	LPW	
Bahama Beige	SUC	
Black	PUY	(non-leather only)

leather **STC50328**
non-leather **STC8934**

SILVER FACIA KIT



Silver facia kit **FDG500030MCE**
Plastic veneer panels in a silver finish.
Kit contains centre console panel, side air vent surrounds, passenger facia trim panel and electric window switch panel.

DESCRIPTION

DESCRIPTION

PART No.

DESCRIPTION

PART No.

FOOTWELL MATS



Footwell mats;
 rubber mats
 With Land Rover logo.
 vehicle set (front & rear) **STC50048AA**
 front set (pair) **STC50049AA**
 carpet mats - vehicle set
 Tailored to fit the Discovery footwells (front & rear).
 With embroidered "Discovery" logo.
 Waterproof backing.

Tundra	STC53183HPQ
Black	STC53183PUY
Bahama Beige	STC50047
Slate Grey	STC50046

WATERPROOF SEAT COVERS



Waterproof seat covers;
 Genuine Land Rover tailored seat covers available for all seats. Headrests included.
 Seat covers come in the following colours (when ordering, add the appropriate colour code to the seat cover part number):

Alpaca	SMS	Light Tundra	HPP
Dark Tundra	HPQ	Dark Smokestone	LPW
Bahama Beige	SUC	Lightstone	SMK
Black	PUY		

front pair
 electric seats **STC50054**
 manual seats **STC50055**
 rear pair **STC50056**
 occasional seats **STC50057**

LOADSPACE LINER



Loadspace liner;
 Very strong, rigid acrylic liner with high sides.
 Available in full-length (rear seats folded down) or half-length (loadspace only).

full-length	STC50051
half-length	STC50050



LOADSPACE MAT - RUBBER



Loadspace mat - rubber;
 Available in full-length (rear seats folded down) or half-length (loadspace only).

full-length	STC50053AA
half-length	STC50052AA

LOADSPACE NET



Luggage net;
 For safe transportation of luggage.

side nets (pair)	STC50133
loadspace net	STC50073

Not suitable for 7-seater vehicles.
 Supplied with 2 x ratchet straps for larger items.

TOW BAR KIT

Tow bar kit - less electrics;
 adjustable tow bar
 coil spring vehicles
 rear self-levelling suspension
 multi-height tow bar

STC50287AB
STC50289AB
STC50319



**MULTI-HEIGHT
 TOW BAR
 STC50319**



ADJUSTABLE TOW BAR KIT STC50287AB

Tow bar kit - with electrics;
 2-position tow bar kit.
 with 'N'-type electrics.
 with 13 pin electrics

ANR6643
STC50035



**TOW BAR KIT WITH
 'N'-TYPE ELECTRICS
 ANR6643**

TOWING ELECTRICS

Towing electrics;

'N'-type **STC50081**
 For standard trailers. Supplies the rear lamps, brake lamps, indicators and fog lamps. Also suitable for trailer boards.

'S'-type
 For additional power, such as caravan refrigerator, battery charging and interior lights. There are three systems, as follows:
 For pre-1999 caravans, the split-charge system protects the vehicle battery from drainage.
 For post-1999 caravans, the control of power distribution is incorporated into the caravan electrics.
 The third system provides a feed for reversing lights and has no fridge feed or battery charging.

pre-1999 caravans **STC50179**
 caravans 1999 onwards **STC50389**
 without fridge feed/charging **STC50180**

13-pin electrics **STC50178**
 European style electrics kit, which incorporates all trailer exterior and interior power requirements, including fridge feed and battery charging.
 Also includes a fog lamp cut-out.



'N' TYPE

'S' TYPE

13 PIN

REMOTE CONTROL

Remote control - rear suspension **STC50075**
 (UK & European models).
 Allows precise height adjustment of rear suspension on vehicles with self-levelling suspension.



TOW BALLS & ADAPTORS

**50MM
 TOW BALL**

**EXTENSION
 BOX WITH
 50MM TOW
 BALL**



**COMBINATION
 TOW BALL**

Tow balls and adaptors;

50mm tow ball **RTC8891AA**
 combination tow ball/jaw **RTC8159**
 detachable tow ball conversion kit **STC50036**
 Easily removed when not required. Lockable.

Extension box with 50mm tow ball **STC50038**
 Gives a greater range of tow ball heights.

Shocklink coupling **STC7669**
 Protects the trailer and vehicle from shocks and jarring during towing.



**DETACHABLE TOW BALL
 CONVERSION KIT**

REFERENCE / INFORMATION BOOKS

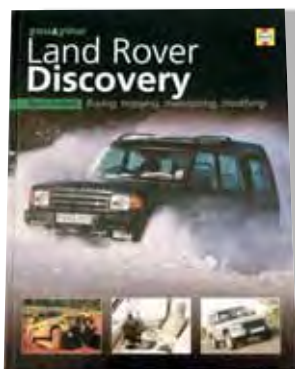

You & Your Land Rover Discovery
(Dave Pollard). 144 pages, 160 colour illustrations
Buying, enjoying, maintaining, modifying.
Workshop Manual (factory)

RD1156

RD1155

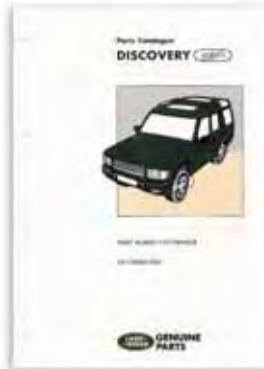

Parts catalogue (factory) **STC9049CB**
Covers all models.
Shrink wrapped - binder available separately (RTC9946).

ORIGINAL TECHNICAL PUBLICATIONS ON CD ROMS

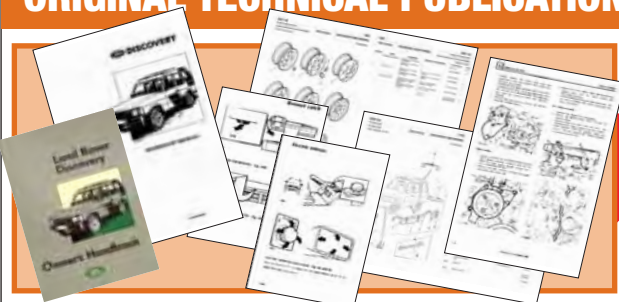

Land Rover Classic Parts (LRCP) have introduced 3 CD Roms covering Range Rover Classic and Discovery (to 1994). They represent excellent value for money since they combine the original factory publications for the Parts Manuals, Service Manuals (workshop) and Owners Handbooks which if bought individually, would far exceed the price of each CD!

RANGE ROVER CLASSIC CD ROM

1970-1985 Original publications **LHP1**
Includes:- Parts Manual 1970-1985 (RTC9846CH).
Service Manual 1970-1985 (AKM6330).
Owners Handbooks 1970-1980 (606917), 1981-1982 (AKM8139) & 1983-1985 (LS0001HB)

1986-1994 Original publications **LHP2**
Includes:- Parts Manuals 1986-1991 (RTC9908FAB), 1992-1994 (RTC9961FAB)
Service Manuals 1986-1989 (SRR60ENWM), 1990-1994 (LHAWMENA02) & 1995 MY (LRL0030ENG).
Electrical Trouble Shooting Manuals 1992 MY (LHAEMENA00) & 1993-1994 MY (LHAEMEN93).
Owners Handbooks 1986-1987 (LSM129HB) & 1988-1989 (SRR600ENHB).

LAND ROVER DISCOVERY CD ROM

1989-1994 Original publications **LHP3**
Includes:- Parts Manual 1989-1994 (RTC9947FAL).
Service Manual 1989-1994 (SJR900ENWM).
Owners Handbook 1990 MY (SJR900ENHB90).



VIDEOS

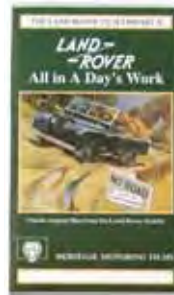
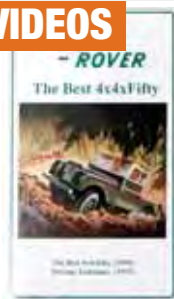

We are pleased to offer a selection of VHS (PAL) videos from the 'Heritage Motoring Films' Library. Essentially, original films from the Land Rover archives edited and enhanced for you to enjoy at home!

'The best 4x4 x fifty' **LL1006**
50 minutes (approx). Originally made for Land Rover North America in 1999 to celebrate 50th Anniversary. Sir Ranulph Fiennes explores 50 years of Land Rover history including contributions by Spen King, Geoff Miller, Tom Barton & Roger Crathorne. From first models to the luxury series 2 Range Rover, this film portrays the history of Land Rover in a very personal fashion. Also includes driving techniques film.

'Anything you can do' **LL1005**
53 minutes from archives dating back to 1955, 1956, 1957 & 1958 including 'newsreel' type footage.

'All in a day's work' **LL1003**
56 minutes including 'newsreel' film from 1957/8, overland to Singapore (1956), special equipment (1964), unusual military prototypes (1967) and Rover Pacific review (1955).

'A means to all ends' **LL1004**
61 minutes including promotional film for S3 (1973), South America tour (1959), 21st anniversary versatility demonstration (1969).

'Range Rover - The original Land Rover Films' **RA1451**
52 minutes. Includes 1970 launch film, the prototype story, a Sahara expedition, footage to promote into the German market and a short film of improved features of the 1985 model including factory assembly.

Also available from Haynes is this action packed overview of the modern and historic roles of Land Rover & Range Rover.

'Best of British - Land Rover' **RD1033**
60 minutes.

PERSONAL ORGANISER



Land Rover personal organiser
Superb value! 14 x 20cm (6 rings) in dark burgundy with Land Rover badge.

binder only **STC50440**
binder & diary insert **STC50440K**

VIDEO / DVD

CAMEL TROPHY - THE LAND ROVER YEARS

Focussing on the Land Rovers involved in the prestigious Camel Trophy. Footage from over a decade of competition 1988 - 1999. Available on DVD and VHS video.

DVD **RX1541D**
VIDEO **RX1541V**

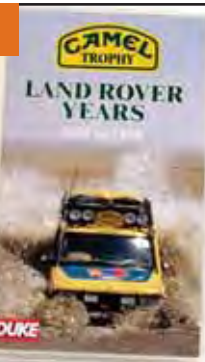

POWER SOURCE INVERTER



Great for in car entertainment and leisure use!

Power Source Inverter

A power source inverter converts car battery voltage (12v) into a 240v output. You can plug in a variety of mains voltage appliances into the standard UK socket. Three different inverters are available to suit a range of power requirements. There is overload, overheat and short circuit protection on all models.

150 WATT MODEL RX1551-150

Continuous power: 150w. Peak power: 300w
Cigar lighter plug connection. 15A fuse.
Suitable applications: TV, DVD, Video, Computer Consoles, Lights (not fluorescent) Phone charger etc.

300 WATT MODEL RX1551-300

Continuous power: 300w. Peak power: 660w
Cigar lighter or battery clip connection. 40A fuse.
Suitable applications: as 150w model plus small power tools, small fridges, stereo etc.

500 WATT MODEL RX1551-500

Continuous power: 500w. Peak power: 800w
Battery clip connection only. 70A fuse.
Suitable applications: as 300w model plus medium power tools, colour TV's with DVD's, battery chargers etc.



MOBILE FRIDGE/ TRAVEL COOLER



Ideal for keeping food and drinks cool in the summer! Simply plugs into cigar lighter. Fantastic value.

Mobile Fridge/Travel Cooler **RX1540**

KENLOWE ENGINE HOT START & INTERIOR PRE-HEATER SYSTEM



The ultimate in comfort & convenience: Kenlowe Engine Hotstart is a mains-powered pre-heater and coolant pump. Fitted in a convenient position in the engine bay, Hotstart rapidly heats the engine to operating temperature and holds it there, eliminating the engine wear, extra fuel costs and de-icing associated with cold winter mornings. The Kenlowe Interior Pre-Heater, working in conjunction with Hotstart, pre-heats the car's interior (as well as demisting iced-up windows) before you even turn on the ignition, making the start of your journey safer and more comfortable.

Kenlowe 'Hotstart' engine & interior pre-heater **RX1361**

WORK LAMPS



Portable Halogen Worklight (500w) **RX1263**
Replacement Bulb **RX1263B**

Ideal for working on you car or for jobs around the house. Inc. 240v-500w tungsten halogen lamp, 2m cable and BS plug.

Inspection Lamp/Halogen **RX1424**
Plugs into cigar lighter.

BATTERY CONDITIONER & CHARGER

The battery charger that turns on and off, automatically.



Suitable for all 12 volt batteries (from 5AH to 100AH), this superb product constantly revitalises the battery cells - helping to extend cell life, without the danger of overcharging. Comes complete with all fittings & operating instructions.

Battery Conditioner Kit **RX1410CTEK**
Battery Charger 6v/12v **GAC7106**
Standard Battery charger.

DIS-CAR-NECT



'Dis-Car-Nect' Starter Immobiliser **RX1356**
Replacement Screw Knob **RX1356K**
Replacement Fuse **RX1356F**

HOW DOES 'DIS-CAR-NECT' WORK?

When leaving your car, simply remove the knob to isolate the starter circuit. The 16amp by-pass fuse will maintain current to all other electrical circuits - stereo memories, alarm etc. Because the starter motor draws over 150amps, any attempt to connect (hot-wire) the starter motor will instantly cause the by-pass fuse to blow, this immobilises the car until the knob is replaced. If this should happen, simply replace the 16amp fuse at your convenience. As an added advantage, the 'Dis-Car-Nect' will also prevent battery drain if you intend to store your car, simply unscrew the knob and remove the fuse. For extra security you can unscrew and remove the immobiliser knob completely.

DESCRIPTION PART No.

TOOLS

HYDRAULIC JACK

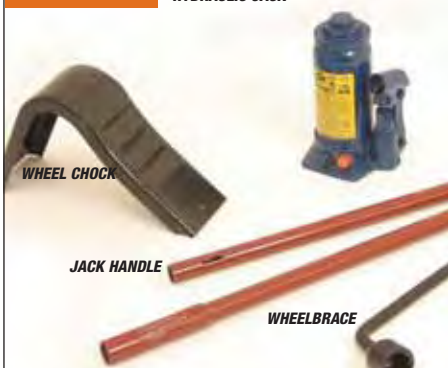

Hydraulic jack **ANR4489**
 Handle for jack **NTC6856**
 Wheel brace standard **NTC7829**
 heavy duty **595336HD**
 Wheel chock (each) **ANR3052**
 Tyre pump **523638A**



Valve spring compressor (OHV) **RX12260HV**



Spark plug spanner **GAT140**
 Oil filter strap wrench **RX1514**
 Sump key set (5 piece) **RX1515**
 Oil pump priming tool **RX1431**
 Grease gun **RX1423**
 Spark plug spanner **GAT140**



Road spring compressor **RX1328**

DESCRIPTION PART No. DESCRIPTION PART No.

LUBRICANTS & FLUIDS



Engine oil - V8;
 Unipart 20W50 **GGL104**
 4.55 litre (1 gallon)
 Castrol Classic XL (20W50) **RX1363**
 4.55 litre (1 gallon).
 Duckhams Q (20W50) **HMP190100**
 4.55 litre (1 gallon).
 Duckhams Q Storage Oil **HMP190104**
 4.55 litre (1 gallon)
 Castrol Running-in Oil **RX1417**
 4.55 litre (1 gallon)
For use in new or reconditioned engines during running-in. (Petrol & diesel).
 Engine oil - Diesel **GGL658**
 Unipart 15W40 (5 litres)

Power steering/EAS fluid - 1 litre **STC50519**
 Gear oil;
 Unipart **GGL190**
 EP90 - 0.5 litre **GUL805**
 EP90 - 5 litre **GUL255R**
 ATF - 0.5 litre **GGL505**
 ATF - 5 litre

Antifreeze;
It is recommended that a minimum 50% antifreeze mix is maintained all year round on aluminium engines, to inhibit corrosion.
 Unipart - 1 litre **GAC2018**
 Unipart - 5 litre **GAC2019**

Brake/clutch fluid;
 Dot 4 - 1 litre **SIJ000030**
 Silicone - 0.5 litre **RX1327**
 Silicone -1 litre **RX1326**

WORKSHOP CONSUMABLES



Grease;
 lithium grease - 400gm tube **GGL111**
 rubber grease (red) **514578**
For brake assemblies (2oz tube).
 Cam Lube **RX1358**
 WD40 (large, 400ml) **GAC111**
 Radweld (Holts, 250ml) **RX1508**
 Silicone Sealant (80ml tube) **GHF6093**

Hylomar (gasket sealant) 100g **GGC102**
 Exhaust jointing compound **GCH112**
 Copper grease (tube) **RX1345**
 Brake cleaner (aerosol) **GBF901**
 Loctite thread lock **GAC100**
 Trim adhesive (1 litre) **RX1353**
 Trim adhesive (370g aerosol) **RX1353A**
 Rubber gloves (box of 100) **RX1406**



Castrol oil jugs;
 1/2 pint **RX1395**
 1 pint **RX1396**
 2 pint **RX1397**
 all 3 jugs **RX1398**

NUMBER PLATES



STANDARD



ONLY AVAILABLE TO PERSONAL CALLERS.

New legislation from 1/1/03 states that number plates can only be sold directly to the owner of the vehicle together with proof of ownership and personal identification.

We will need sight of the following three original documents:-

- Vehicle registration document (V5)
- Driving Licence or utility bill.
- Passport or credit card (with photo ID), or travel/works pass (with photo ID).

Number plates are made to special order.

Please note that it is also now mandatory in the UK for all new number plates to bear the originating suppliers name, postcode and telephone number (i.e. Rimmer Bros).

Vehicle Number Plate - Front

- | | |
|-----------------------------------|---------|
| Standard | NPF |
| Standard with 'GB' logo | NPFGB |
| Deluxe - 3D effect | NPF3D |
| Deluxe - 3D effect with 'GB' logo | NPF3DGB |

Vehicle Number Plate - Rear (oblong)

- | | |
|-----------------------------------|---------|
| Standard | NPR |
| Standard with 'GB' logo | NPRGB |
| Deluxe - 3D effect | NPR3D |
| Deluxe - 3D effect with 'GB' logo | NPR3DGB |

Vehicle Number Plate - Rear (square)

- | | |
|-----------------------------------|----------|
| Standard | NPRS |
| Deluxe - 3D effect | NPRS3D |
| Deluxe - 3D effect with 'GB' logo | NPRS3DGB |

Fitting Kit - number plates

Universal kit including 4 self tap screws, 2 white cups, 2 yellow cups & 8 double sided adhesive pads.

NPK



'CONCOURS' SPECIALIST WHEEL CLEANER

The 'Concours' specialist wheel cleaning system will help you care for your Classic's wheels.

Suitable for all Steel, Alloy and Wire wheels (including painted & chromed), 'Concours' wheel cleaning system uses a unique 2-stage process that not only cleans, but gives wheels a superb lasting finish that helps to protect them, making them easier to care for and clean in the future.

'Concours' Wheel Cleaning Kit

RX1405

Kit includes; special cleaning solution (580ml), wooden handled cleaning brush & dispenser, finishing/protection solution (180ml), 2 pair of disposable gloves.

Cleaning solution breaks down brake dust & road grime. Brush & dispenser gets into all those awkward places. Finishing/protection solution leaves wheels like new.

BODY CARE

FINNEGANS 'ANTI-CORROSION' WAXOYL

Waxoyl starter kit **RX1032**

Includes; RX1028, RX1030, RX1031.

Waxoyl;

- | | |
|---------------------|--------|
| 5 Litre can | RX1027 |
| 2.5 Litre can | RX1029 |
| 2.5 Litre cartridge | RX1028 |

Trigger spray gun

RX1033

High pressure spray gun

RX1030

Use with 2.5 litre cartridge.

Extension probe

RX1031

Use with high pressure spray gun.

Aerosol (400ml)

RX1026

Aerosol (200ml)

RX1025

Underbody seal;

1 litre	RX1024
500ml	RX1023



AUTOGLYM CAR CARE PRODUCTS

Autoglym car care pack **RX1510**
Includes 1 of each item listed below.

- | | |
|--------------------------------------|--------|
| Silicone resin polish (300ml) | RX1312 |
| Bodywork shampoo conditioner (480ml) | RX1313 |
| Car interior shampoo (480ml) | RX1314 |
| Glass polish (300ml) | RX1315 |
| Cutting polish (300ml) | RX1316 |
| Extra gloss protection (300ml) | RX1317 |
| Bumper care (300ml) | RX1318 |
| Vinyl & rubber care (300ml) | RX1319 |
| Leather care cream (300ml) | RX1320 |
- Cleans and preserves.

- | | |
|------------------------------------|--------|
| Superglym chrome polish (75g) | RX1321 |
| Clean wheels (500ml) | RX1322 |
| Perfect polishing cloth (21 Sq Ft) | RX1323 |
| Aqua-dry (Synthetic chamois) | RX1324 |
| Clean machine (1 Litre) | RX1325 |

Engine Degreaser.

The following items are not included in the 'Car Care Pack';

Instant Tyre dressing	RX1368
Intensive Tar remover	RX1367
Hood care & maintenance kit	RX1433
Alloy wheel seal (450ml)	RX1443

Silicone spray.

GENERAL CAR CARE PRODUCTS

- | | |
|--------------|--------|
| Sponge | RX1415 |
| Wash leather | RX1416 |

DESCRIPTION

PART No.

DESCRIPTION

PART No.

DESCRIPTION

PART No.

SNOWCHAINS



Snow chains;
Supplied in vinyl carry-bag. 1 pair for rear wheels.
215 & 235 tyres **STC8518**
255 tyres (inc. 18") **STC7565**

PICNIC TABLES - PAIR



Picnic tables - pair **STC50071**
Picnic tables fit into the rear of the front seats and fold out for eating or writing.
Available in 5 colours to match your vehicle's trim.
When ordering, add the appropriate colour code to the part number:
Alpaca **SMS**
Tundra **HPP**
Dark Smokestone **LPW**
Bahama Beige **SUC**
Black **PUY**

MOBILE PHONE BRACKET



Mobile phone bracket;
Attaches to the side of the centre console to create a space for a mobile phone cradle.
rhd **STC50462**
lhd **STC50461**

AEROSOL PAINTS & TOUCH-IN CRAYONS



Add the suffix T or A to the appropriate part number:
eg. STC3686T = Touch-in crayon
STC3686A = Aerosol
Suffixes VT and VA include lacquer, accordingly.

Body Colour	Paint Type	Paint Code	Part No.
Alveston red	micatallic	LRC696	STC4325
Beluga black	solid	LRC416	RTC5979
Blenheim silver	metallic	LRC642	STC4235
Bonatti grey	metallic	LRC659	STC4597
Caledonian blue	micatallic	LRC507	STC3822
Carmen pearl	micatallic	LRC843	STC1350
Charleston green	metallic	LRC610	STC3174
Chawton white	micatallic	LRC603	STC3828
Cobar blue	metallic	LRC624	STC3825
Coniston green	solid	LRC570	STC1348
Highland green	micatallic	LRC639	STC4234
Icelandic blue	micatallic	LRC621	STC4323
Java black	micatallic	LRC697	STC4281
Kent green	micatallic	LRC647	STC4324
Kinversand	micatallic	LRC609	STC4238
Monte Carlo blue	micatallic	LRC608	STC4595
Niagara grey	metallic	LRC574	STC1449
Oslo blue	micatallic	LRC644	STC4596
Oxford blue	micatallic	LRC602	STC2864
Rioja red	micatallic	LRC601	STC2828
Rutland red	solid	LRC607	STC3823
Stirling silver	metallic	LRC735	STC4598
White gold	solid	LRC618	STC3251
Woodcote green	micatallic	LRC623	STC3827

GENERAL ITEMS



'Rimmer Bros' baseball cap **RX1425**



Rimmer Bros 'Vouchers';
Vouchers make an ideal present for Classic car owners.
£5 value **RX1337**
£10 value **RX1338**
£20 value **RX1339**
£50 value **RX1341**

QUALITY PARTS AND ACCESSORIES

RIMMER BROS

LAND ROVER RANGE ROVER - DEFENDER DISCOVERY - FREELANDER AUTHORISED PARTS DISTRIBUTOR

Triumph TIGER SPITFIRE, 600, 500A, 500B, 500C, 500D, 500E, 500F, 500G, 500H, 500I, 500J, 500K, 500L, 500M, 500N, 500O, 500P, 500Q, 500R, 500S, 500T, 500U, 500V, 500W, 500X, 500Y, 500Z

TEL: 01522 568000

www.rimmerbros.co.uk



'Rimmer Bros' decal (black & silver) **RA1055**

Tax disc holder (Free of charge) **RX1355**



Land Rover Headphones **STC50072**



Leather V8 Key Fob **RX1537**

GENERAL USE AEROSOLS

Black - Gloss (400ml)	RX4070A
Black - Matt (500ml)	RX1266
Black - Satin (500ml)	RX1538
Silver (Suitable for wheels) (450ml)	RX1265
Lacquer - Clear (Suitable for wheels) (400ml)	RX1261
Primer - White (150ml)	RX4048A
Primer - Red Oxide (150ml)	RX4049A
Primer - Grey (150ml)	RX4047A
Engine Black (High Heat)	
Aerosol Hy-cote (400ml)	
Black	RX1432A
Aluminium	RX1432AL
Tin - Brush-on (125ml)	RX1432B
Chassis Paint (Black) (For general touch-up)	
Brush on (125ml)	RX4070B

GENERAL FASTENERS

ACCESSORIES

BOLTS (Imperial)

Bolts have a NON Threaded Shoulder.

The threaded length can be calculated by multiplying the diameter by 2 and adding 1/4".

Thread Diameter	Bolt Length	Thread Type	Thread Pitch	PART NUMBER	Spanner Size
1/4"	1.5"	UNF	—	GHF102	7/16 AF
1/4"	2"	UNF	—	GHF118	7/16 AF
5/16"	1.5"	UNF	—	GHF104	1/2" AF
5/16"	2"	UNF	—	GHF121	1/2" AF
3/8"	1.5"	UNF	—	GHF106	9/16" AF
3/8"	3"	UNF	—	GHF126	9/16" AF
1/2"	2"	UNF	—	BH608161	3/4" AF
1/2"	2.5"	UNF	—	BH608201	3/4" AF
1/2"	3"	UNF	—	BH608241	3/4" AF
5/8"	3"	UNF	—	GHF113	15/16" AF
5/8"	4"	UNF	—	BH610321	15/16" AF

BOLTS (Metric)

Bolts have a NON Threaded Shoulder.

The threaded length can be calculated by multiplying the diameter by 2 and adding 6mm.

Thread Diameter	Bolt Length	Thread Type	Thread Pitch	PART NUMBER	Spanner Size
M 6	40mm	Metric Fine	1.0	GHF132	10mm
M 8	40mm	Metric Fine	1.25	GHF134	13mm
M 10	40mm	Metric Fine	1.5	GHF136	17mm
M 12	50mm	Metric Fine	1.75	BH112101	19mm
M 12	60mm	Metric Fine	1.75	BH112121	19mm
M 12	80mm	Metric Fine	1.75	BH112161	19mm
M 16	60mm	Metric Fine	2.0	BH116121	21mm
M 16	80mm	Metric Fine	2.0	BH116161A	21mm



STEEL NUTS (Plain NON Locking - Imperial)

Thread Diameter	Thread Type	Thread Pitch	PART NUMBER	Spanner Size
3/16"	UNF	—	HN2005	3/8" AF
1/4"	UNF	—	GHF200	7/16" AF
5/16"	UNF	—	GHF201	1/2" AF
3/8"	UNF	—	GHF202	9/16" AF
7/16"	UNF	—	GHF203	5/8" AF
1/2"	UNF	—	GHF204	3/4" AF
1/4"	UNC	—	GHF207	7/16" AF
5/16"	UNC	—	GHF208	1/2" AF
3/8"	UNC	—	GHF209	9/16" AF

STEEL NUTS (Plain NON Locking - Metric)

Thread Diameter	Thread Type	Thread Pitch	PART NUMBER	Spanner Size
M 4	Metric Fine	0.7	NH104041	7mm
M 6	Metric Fine	1.0	GHF212	10mm
M 8	Metric Fine	1.25	GHF213	13mm
M 10	Metric Fine	1.5	GHF214	17mm
M 12	Metric Fine	1.75	GHF215	19mm

STEEL NUTS (Nylon Insert Self Locking - Imperial)

Thread Diameter	Thread Type	Thread Pitch	PART NUMBER	Spanner Size
3/16"	UNF	—	GHF220	5/16" AF
1/4"	UNF	—	GHF221	7/16" AF
5/16"	UNF	—	GHF222	1/2" AF
3/8"	UNF	—	GHF223	9/16" AF
7/16"	UNF	—	GHF224	5/8" AF
1/2"	UNF	—	GHF225	3/4" AF
5/8"	UNF	—	138563	15/16" AF

STEEL NUTS (Nylon Insert Self Locking - Metric)

Thread Diameter	Thread Type	Thread Pitch	PART NUMBER	Spanner Size
M 6	Metric Fine	1.0	NY106041	10mm
M 8	Metric Fine	1.25	GHF232	13mm
M 10	Metric Fine	1.5	GHF233	17mm
M 12	Metric Fine	1.75	NY112041	19mm

BRASS NUTS (Standard & Deep Section - Imperial)

Thread Diameter	Thread Type	Thread Pitch	PART NUMBER	Spanner Size
5/16"	Std	UNF	515369	1/2" AF
3/8"	Std	UNF	GHF262	9/16" AF
3/8"	Deep	UNF	AEC350	9/16" AF

POP RIVETS

Open End Type

Size	PART NUMBER
2.9mm x 5mm	RA607096
1/8" x 3/16"	RA608126
1/8" x 1/4"	RA608176
1/8" x 5/16"	RA608236
1/8" x 3/8"	RA608253

POP RIVETS

Closed End Type

Size	PART NUMBER
1/8" X 3/8"	RU608123
1/8" x 1/2"	RU608313
3/16" x 5/16"	RU612123

SETSCREWS (Imperial)

Set screws are Fully Threaded.

Thread Diameter	Bolt Length	Thread Type	Thread Pitch	PART NUMBER	Spanner Size
1/4"	3/4"	UNF	—	GHF117	7/16" AF
1/4"	1"	UNF	—	GHF101	7/16" AF
5/16"	3/4"	UNF	—	GHF120	1/2" AF
5/16"	1"	UNF	—	GHF103	1/2" AF
3/8"	1"	UNF	—	GHF105	9/16" AF
7/16"	1.5"	UNF	—	GHF107	5/8" AF
1/2"	1.5"	UNF	—	GHF109	3/4" AF
1/4"	1"	UNC	—	GHF161	7/16" AF
1/4"	1.5"	UNC	—	SH504121	7/16" AF
5/16"	1"	UNC	—	GHF163	1/2" AF
5/16"	1.5"	UNC	—	GHF164	1/2" AF
3/8"	1"	UNC	—	GHF165	9/16" AF
3/8"	1.5"	UNC	—	GHF166	9/16" AF

SETSCREWS (Metric)

Set screws are Fully Threaded.

Thread Diameter	Bolt Length	Thread Type	Thread Pitch	PART NUMBER	Spanner Size
M 6	25 mm	Metric Fine	1.0	GHF131	10mm
M 8	25 mm	Metric Fine	1.25	GHF133	13 mm
M 10	25 mm	Metric Fine	1.5	GHF135	17mm

SELF TAPPING SCREWS

Countersunk - PoziDrive

Screw Size No	Screw Length	PART NUMBER
6	1/2"	GHF400
6	3/4"	GHF401
8	1/2"	GHF402
8	3/4"	GHF403
10	1/2"	GHF404
10	3/4"	GHF405
12	1/2"	AC612041A
12	1"	AC612081
14	3/4"	AC614061
14	1"	AC614081

SELF TAPPING SCREWS

Pan Head - PoziDrive

Screw Size No	Screw Length	PART NUMBER
6	1/2"	GHF421
6	3/4"	GHF422
8	1/2"	YZ3404
8	3/4"	GHF424
10	1/2"	GHF425
10	3/4"	YZ5505
12	1/2"	GHF427
12	3/4"	GHF428
12	1"	GHF429
14	3/4"	GHF430
14	1"	GHF431

WASHERS (Imperial)

Internal Diameter	Plain Standard Diameter	Repair Large Diameter	Spring Standard Diameter	Shakeproof Standard Diameter
	PART NUMBER	PART NUMBER	PART NUMBER	PART NUMBER
3/16"	WP20	—	—	—
1/4"	GHF300	GHF314	GHF331	GHF321
5/16"	GHF301	GHF315	GHF332	GHF322
3/8"	GHF302	GHF316	GHF333	GHF323
7/16"	WC600071	—	GHF334	GHF324
1/2"	WA112081	—	GHF335	GHF325
5/8"	PWZ110	—	LWZ310	LWZ410

WASHERS (Metric)

Internal Diameter	*Plain Standard Diameter	*Repair Large Diameter	Spring Standard Diameter	Shakeproof Standard Diameter
	PART NUMBER	PART NUMBER	PART NUMBER	PART NUMBER
M 6	GHF300	GHF314	WL106001	GHF371
M 8	GHF301	GHF315	GHF382	WF108001
M 10	GHF302	GHF316	GHF383	WF110001
M 12	GHF304	—	WL112001	WF112001
M 16	PWZ110	—	WL116001	WF116001

*Please Note: Some plain and repair washers are suitable for imperial and metric applications eg: GHF300 = 1/4" ID or 6mm ID.

SPLIT PINS

(Imperial)

Pin Thickness	Pin Length	PART NUMBER
1/16"	1.5"	GHF500
5/64"	1.5"	GHF501
3/32"	1.5"	PC34
7/64"	1.5"	GHF503
1/8"	2.25"	PC15
9/64"	2.25"	GHF505
5/32"	2.25"	GHF506
11/64"	2.25"	GHF512
3/16"	3"	GHF513
7/32"	3"	PS614240
1/4"	3"	PS616240

SPLIT PINS (Metric)

Pin Thickness	Pin Length	PART NUMBER
2.0mm	40mm	PS104400
2.5mm	40mm	GHF509
3.2mm	56mm	GHF510
4.0mm	56mm	GHF511

HOSE CLAMPS

Stainless Steel (Metric)

To suit Diameter	PART NUMBER
8-12mm	GHC10408
12-18mm	GHC10410
8-16mm	GHC10411
12-20mm	GHC10412
16-25mm	GHC10413
20-32mm	GHC10414
25-40mm	GHC10415
32-50mm	GHC10416
46-60mm	GHC10417
50-70mm	GHC10418
60-70mm	GHC10419
70-90mm	GHC10420
80-100mm	GHC10421

CABLE TIES

DIAMETER	PART NUMBER
3 1/2"	GHF1265
5 1/4"	GHF1266
6"	RTC222A
8 3/4"	GHF1267
11"	GHF1268



ALL PARTS ARE GUARANTEED

“It’s our objective to ensure the satisfaction of every one of our customers.”

Please refer to our Price Guide for warranty information.



HOW TO FIND US

We’re 2 miles south of Lincoln, on the A15 Lincoln to Sleaford road.

When approaching Lincoln from the A1/A46, follow the A1434 signposted to city centre, through North Hykeham, then pick up signs for the A15 to Sleaford.

BUSINESS HOURS

8.30am - 5.30pm Monday to Friday.

8.30am - 1pm Saturday.

(Closed Sunday and Bank Holidays except Good Friday)



A BRITISH COMPANY SUPPORTING BRITISH CARS

Rimmer Bros Ltd. Triumph House, Sleaford Road, Bracebridge Heath, Lincoln LN4 2NA, England.

Telephone: 01522 568000

Fax: 01522 567600. E-mail: sales@rimmerbros.co.uk

www.rimmerbros.co.uk

LAND ROVER

RANGE ROVER · DEFENDER
DISCOVERY · FREELANDER

AUTHORISED PARTS DISTRIBUTOR
Original Parts & Accessories



Triumph

TR2-8, SPITFIRE, GT6, STAG, 2000/2500,
HERALD/VITESSE, DOLOMITE/SPRINT.



BRITISH MOTOR
HERITAGE APPROVED



AUTHORISED PARTS DISTRIBUTOR
Original Parts & Accessories