

**ARMY CODE No.
18358**

Issued March 1962

**(Reprinted March 1966 incorporating
amendments 1 to 5)**

**TRUCK, $\frac{1}{4}$ TON, GS, FFR, 4x4,
ROVER 8**

**TRUCK, $\frac{3}{4}$ TON, GS, FFR, 4x4,
ROVER 9**

For Vehicle Contract Nos. See Title Page

USER HANDBOOK

**(VEHICLES WITH 24 VOLT
ELECTRICAL EQUIPMENT)**

**PRODUCED TO THE REQUIREMENT OF
THE MINISTRY OF DEFENCE**

ARMY
CODE NO.

18358

Issued March 1962

(Reprinted March 1966 incorporating amendments 1 to 5)

TRUCK, $\frac{3}{4}$ TON, GS, FFR, 4×4, ROVER 8

TRUCK, $\frac{3}{4}$ TON, GS, FFR, 4×4, ROVER 9

CONTRACT Nos.
War Office

KL/H/01291
KL/H/01330
KL/H/01362
WV/33
WV/34
WV/1327
WV/1540
WV/2086
WV/2651, Items 3 and 4
WV/2985
WV/3269
WV/3518
WV/3692
WV/3694
WV/4629
WV/4630

USER HANDBOOK

VEHICLES WITH 24-VOLT ELECTRICAL EQUIPMENT

Part No. 4354

Amdt. No. 1, 2, 3, 4 and 5

AMENDMENTS

It is essential that this book be kept up to date with all amendments. Immediately an amendment is inserted, particulars will be entered hereunder.

Amdt. No.	Date	Sig.	Amdt. No.	Date	Sig.
1					
2					
3	} Incorporated				
4					
5					

Amdt. No. 1, 2, 3, 4 and 5

Contents

List of Illustrations	ix
Notes to Readers	xiii
List of Associated Publications	xiv

SECTION I

GENERAL DESCRIPTION

<i>Chapter</i>	
1. Introduction	
VEHICLE SERIAL NUMBERS	1
NOMENCLATURE	1
2. Description of Vehicle	8
3. Data	9

SECTION II

OPERATION

1. Controls and Instruments	
CONTROLS	18
INSTRUMENTS	26
2. Operating Instructions	
BEFORE STARTING THE ENGINE	29
STARTING THE ENGINE	30
WHEN THE ENGINE STARTS	31
MOVING OFF	31
GEAR SELECTION	31
ENGAGING FOUR-WHEEL DRIVE	33
PARKING THE VEHICLE	34
STATIONARY RUNNING	34
3. Special Instructions	
RUNNING-IN PERIOD	34
MAXIMUM SPEEDS IN ALL GEARS	34
FROST PRECAUTIONS	35
TOWED EQUIPMENT	35
FIRE AND SAFETY PRECAUTIONS	35
USE OF JACKS	36
FORDING	36
TOWING EQUIPMENT	36
DO'S AND DON'TS	37

CONTENTS—continued

Chapter		Page
	SECTION III	
	USER SERVICING AND ADJUSTMENTS	
1. Engine		
Description	38
ENGINE LUBRICATION		
Oil Level	39
Oil Pressure	40
Engine Oil Changes	40
Oil Filters	40
Engine Breather Filters	41
Checks	42
Engine Oil Cooler	43
ENGINE TIMING		
Routine Adjustments and Servicing	43
Flywheel Markings	43
To Fit New Timing Chain	44
Tappet Adjustment	47
DECARBONIZING		
Cylinder Head, To Remove	48
Inlet Valves, To Remove	49
Exhaust Valves, To Remove	49
Decarbonizing	49
Valve Grinding	49
Re-assembling	49
2. Cooling System		
Description	50
Radiator Filler	51
Coolant Pump	51
Thermostat	52
Checks	52
Routine Adjustments and Servicing	
Generator and Fan Belt Adjustment	52
Draining and Flushing the Cooling System	54

CONTENTS—continued

Chapter		Page
3. Fuel System		
FUEL TANKS		
Description	55
Checks	55
FUEL PUMP AND FILTER		
Description	56
Checks	56
Routine Adjustments and Servicing	56
Clean Filter Sediment Bowl	56
Fuel Pump Fault Location	57
AIR CLEANER		
Description	57
Checks	57
Routine Adjustments and Servicing	57
Air Cleaner, Change Oil and Clean Bowl	57
CARBURETTER		
Description	59
Lubrication	59
Checks	60
Routine Adjustments and Servicing	60
Cleaning Carburetter Filter	60
Carburetter Slow-running Adjustment	61
Cleaning Carburetter Jets	61
Accelerator Pump Operating Rod	62
Draining the Fuel System	63
4. Clutch		
Description	63
Clutch Operation	63
Clutch and Brake Fluid Reservoir	64
Lubrication	64
Routine Adjustments and Servicing	64
Clutch Adjustment	64
Master Cylinder, Free Play, to Adjust	65
Pedal, Free Play, to Adjust	65
Bleeding the Clutch System	65

CONTENTS—continued

Chapter		Page
5.	Gearbox	
	MAIN GEARBOX	
	Description	67
	Lubrication	67
	Oil Level	67
	Bell Housing Drain Plug	68
	Gearbox Oil Changes	
	Checks	68
	TRANSFER GEARBOX	
	Description	69
	Lubrication	69
	Oil Level	70
	Transfer Gearbox Oil Changes	70
	Checks	70
6.	Propeller Shafts	
	Description	70
	Lubrication	71
	Checks	71
7.	Rear Axle, Fully Floating	
	Description	72
	Lubrication	73
	Differential Oil Level	73
	Differential Oil Changes	73
	Checks	74
	Routine Adjustments and Servicing	74
	Hub Adjustment	74
8.	Front Axle	
	Description	74
	Lubrication	
	Differential Oil Level	76
	Differential Oil Changes	76
	Swivel Pin Housing Lubrication	76
	Swivel Pin Housing Oil Level	76
	Swivel Pin Housing Oil Changes	76
	Swivel Pin Housing Gaiter	77
	Checks	77
	Routine Adjustments and Servicing	77
	Hub End-float Adjustment	77

CONTENTS—continued

Chapter		Page
9.	Steering	
	RECIRCULATING BALL TYPE	
	Description	79
	Steering box	80
	Lubrication	80
	Checks	80
	Routine Adjustments and Servicing	
	Rocker Shaft Adjustment	80
	Steering Column Adjustment	81
	Steering Ball Joints	82
	Steering Link Adjustment	82
	Front Wheel Alignment	82
	Lock Stop Bolt Adjustment	83
10.	Brake System	
	Description	84
	Foot Brake	
	Brake and Clutch Fluid Reservoir	84
	Master Cylinder	84
	Pipe System	84
	Wheel Brake Units, Rover 8	84
	Wheel Brake Units, Rover 9	85
	Brake Pedal	85
	Hand Brake	85
	Lubrication	86
	Checks	86
	Routine Adjustments and Servicing	
	Wheel Brake Adjustment, Rover 8	86
	Wheel Brake Adjustment, Rover 9	87
	Master Cylinder Adjustment	88
	Hand Brake (Transmission Brake) Adjustment	88
	Bleeding the Brake System	89
11.	Chassis and Suspension	
	CHASSIS	
	Chassis Frame	90
	Front Bumper and Bumperettes	90
	SUSPENSION	
	Description	90
	Checks	90

CONTENTS—continued		
Chapter		Page
12.	Wheels and Tyres	
	WHEELS	
	Description	91
	Checks	91
	Routine Adjustments and Servicing	
	Wheel Changing	92
	TYRES	
	Description	
	Tyre Treads	92
	Factors Affecting Tyre Life	93
	Checks	93
	Routine Adjustments and Servicing	
	Tyre Pressures	93
	Changing Wheel Positions	93
	Tyre Removal	94
	Tyre Replacement	94
	Wheel and Tyre Balance	95
13.	Electrical Equipment	
	Suppression of Electrical Interference to Radio Services	95
	IGNITION SYSTEM	
	Distributor	
	Description	97
	Lubrication	98
	Checks	98
	Routine Adjustments and Servicing	99
	Clean and Adjust Distributor Points	99
	To Adjust Ignition Timing	99
	Ignition Coil	100
	Filter Unit	100
	Sparking Plugs	100
	High Tension Cables	101
	BATTERIES	
	Description	101
	Checks	102
	Routine Adjustments and Servicing	103
	Topping-up Vehicle and Radio Batteries	103
	Checking Electrolyte	103
	Refitting Battery Connectors	103
	GENERATING SYSTEM	104
	Generator CAV type A.C. 724/1	
	Description	104
	Generator No. 10 Mk 2	
	Description	104A
	Lubrication	104B
	Checks	104B

vi

Amdt. No. 4.

CONTENTS—continued		
Chapter		Page
	RECTIFIER	
	Description	105
	GENERATOR PANEL CAV TYPE 323/2	
	Description	106
	Servicing	106A
	GENERATOR PANEL No. 9 Mk 3	
	Description	106A
	Servicing	106B
	OPERATION OF 90 AMP GENERATING SYSTEM	
	FUSE BOXES	
	Description	107
	STARTER MOTOR	
	Description	108
	Checks	108
	Routine Adjustments and Servicing	108
	Check Starter Motor Brush Gear	108
	Commutator	109
	STARTER SOLENOID SWITCH	
	Description	109
	HORN	
	Description	109
	Checks	109
	Routine Adjustments and Servicing	109
	To Adjust	109
	HORN RELAY	
	Description	110
	WINDSCREEN WIPERS	
	Description	110
	LIGHTS	
	Description	111
	Checks	111
	Routine Adjustments and Servicing	
	Headlight Lamp Replacement	112
	Headlight Setting	112
	Side, Tail/Stop and Turnlight Lamp Replacement	113
	Number Plate Light Lamp Replacement	114
	Instrument Panel and Warning Light Lamp Replacement	114
	Convoy Light Lamp Replacement	114
	Warner and NATO Trailer Plug Sockets	114

vii

Amdt. No. 4 and 5

CONTENTS - continued

Chapter Page

14. Fittings for Radio Stations	
General	115
FFR Equipment	116
To Dismantle the FFR Equipment	125
FFR Equipment to be Transferred	126
To Fit the FFR Equipment	127

15. Body	
Description	129
Bonnet	129
Spare Wheel	130
Rifle Clips	130
Front Seats	130
Radio Operator's Seat	131
Tool Stowage	131
Windscreen	131
Windscreen Wipers	132
Windscreen Wiper Arm and Blade Replacement	132
Windscreen Ventilators	132
Doors	133
Tailboard	133
Cleaning Body	133
Jerrican Holder	133
Soft Hood	133
Checks	134
Fire Extinguisher	135

SECTION IV

FAULT-FINDING CHART

ENGINE FAILS TO START	135
ENGINE STARTS BUT SOON STOPS	137
ENGINE MISFIRES	137
LACK OF ENGINE POWER	138
CHARGING CIRCUIT	139
STARTER MOTOR	140
LIGHTING CIRCUIT	141
CIRCUIT DIAGRAM	142

APPENDIX I

CROSS REFERENCES TO SERVICING OPERATIONS	143
--	-----

List of Illustrations

Figure No.	Description	Page
1.	Vehicle Serial Number	1
2.	Engine Serial Number	1
3.	Three-Quarter Front View—Rover 8	2
4.	Three-Quarter Front View—Rover 9	3
5.	General Side View	4
6.	General Plan View	6
7.	Main Gear Change Lever	18
8.	Transfer Gear Change Lever and Front Wheel Drive Control	18
9.	Hand Brake	19
10.	Starter Switch and Mixture Control (Cold Start)	19
11.	Layout of Controls and Instruments	20
12.	Hand Throttle Control	22
13.	Ignition Switch and Key	22
14.	Light Switch (6-Way)	23
15.	Headlight Dip Switch	23
16.	Instrument Panel Light Switch	23
17.	Turnlight Self-Cancelling Switch and Warning Light	24
18.	Windscreen Wiper Motor	24
19.	Inspection Light Socket	25
20.	Fuel Change-over Tap and Switch	25
21.	Bonnet Catches	26
22.	Ammeters and Fuse Box, 40 amp models	26
22A.	Ammeters, 90 amp models	26
23.	Fuel Level Gauge	27
24.	Speedometer	27
25.	Ignition Warning Light	27
26.	Mixture Control Warning Light	28
27.	Headlight Main Beam Warning Light	28
28.	Oil Temperature Gauge	29
29.	Mixture Control (Cold Start)	29
30.	Main Gear Change Lever	32
31.	Transfer Gear Change Lever and Front Wheel Drive Control	33
32.	Lifting and Towing Bracket	36
33.	Rotating Towing Hook	37
34.	Bumperettes, Front Illustrated	37
35.	Engine Oil Level Dipstick	39
36.	Engine Sump Drain Plug	40
37.	Engine Oil Filter	41
38.	Engine Breather Filters, 40 amp models	41
38A.	Engine Breather Filters, 90 amp models	41
39.	Engine Oil Cooler	43
40.	Flywheel Markings	44

LIST OF ILLUSTRATIONS—*continued*

Figure No.	Description	Page
41.	Checking No. 1 Exhaust Valve "Fully Open" position	45
42.	Timing Gear Arrangement	46
43.	Tappet Adjustment	47
44.	Order of Tightening Cylinder Head Bolts	50
45.	Radiator Filler	51
46.	Fanbelt Adjustment (Coolant Pump)	53
47.	Generator Belt Adjustment, 40 amp models	53
47A.	Generator Belt Adjustment, 90 amp models	53A
47B.	Generator and Fan Belt Layout, 90 amp models	53A
48.	Drain Taps	54
49.	Fuel Filler, Twin Fuel Tanks	55
50.	Fuel Pump and Sediment Bowl	56
51.	Air Cleaner	58
52.	Carburetter Filter	60
53.	Carburetter Adjustment	61
54.	Carburetter Jets	62
55.	Setting Accelerator Pump Operating Rod	62
55A.	Early Type Clutch Mechanism	64A
55B.	Late Type Clutch Mechanism	64A
56.	Clutch Adjustment	64A
57.	Clutch Linkage Setting	66
58.	Bleed Nipple for Clutch Slave Cylinder	66
59.	Gearbox Oil Filler, early models	67
59A.	Gearbox Oil Filler, late models	67
59B.	Bell Housing Drain Plug	68
60.	Gearbox Drain Plugs	68
61.	Transfer Box Lubrication	69
62.	Propeller Shaft Lubrication	71
63.	Cross Section of Fully Floating Rear Hub	72
64.	Identification of Strengthened Differential Units and Axle Shafts	73
65.	Rear Differential Lubrication	73
66.	Front Axle Cross Section	75
67.	Front Differential Lubrication	75
68.	Swivel Pin Housing Lubrication	76
69.	Swivel Pin Housing Gaiter	77
70.	Checking Hub End Float	78
71.	Oil Filler Plug, Axle Hub	79
72.	Steering Box Oil Filler Plug	80
73.	Rocker Shaft Adjustment	81
74.	Steering Ball Joint	82
75.	Adjusting Lock Stop Bolt	83
76.	Brake and Clutch Fluid Reservoir	84
77.	Wheel Brake Adjustment, Rover 8	87

x

Amdt. No. 2, 4 and 5

LIST OF ILLUSTRATIONS—*continued*

Figure No.	Description	Page
78.	Wheel Brake Adjustment, Rover 9, Front	87
79.	Wheel Brake Adjustment, Rover 9, Rear	87
80.	Transmission Brake Adjustment	89
81.	Leaf Clips and U Bolts	91
82.	Divided Wheel	92
83.	Changing Wheel Positions	94
84.	Sequence of Tightening Divided Rim Nuts	95
85.	Electrical Equipment in Engine Compartment, 40 amp Generator	97
85A.	Electrical Equipment in Engine Compartment, 90 amp Generator	97A
86.	Ignition Timing	98
87.	Distributor	98
88.	Flywheel Markings	99
89.	Sparking Plug	100
90.	Vehicle Batteries	101
91.	Radio Batteries	102
92.	Warning Plate, Rectified A.C. System	102
93.	Generator, CAV type A.C. 724/1, 40 amp	104A
93A.	Generator No. 10 Mk 2, 90 amp	104A
94.	Oil Cooler and Rectifier	105
95.	Generator Panel, CAV Type 323-2	106
95A.	Generator Panel No. 9, Mk 3	106A
96.	Fuse Box and Ammeters, 40 amp models	107
96A.	Ammeters, 90 amp models	107
97.	Fuse Boxes on Engine Side of Bulkhead, 40 amp models	108
97A.	Fuse Boxes on Engine Side of Bulkhead, 90 amp models	108
98.	Horn Adjustment	110
99.	Windscreen Wiper	110
100.	Headlight Vertical Dip	112
101.	Headlight Setting Dimensions	112
102.	Sidelight and Front Turnlights	113
103.	Stop/Tail Lights and Rear Turnlights	113
104.	Number Plate Light	113
105.	Warner and NATO Trailer Plug Sockets	114
106.	Rear Body Compartment	116
107.	Aerial Mounting Bracket	117
108.	Aerial Tuning Unit	117
109.	Front Wing Strengthening Plate	118
110.	Aerial Co-Axials Removed from Dummy Socket and Located on Front Wing	119
111.	Aerial Co-Axials in Rear Body	119

xi

Amdt. No. 4 and 5

LIST OF ILLUSTRATIONS--continued

<i>Figure No.</i>	<i>Description</i>	<i>Page</i>
112.	Aerial Co-Axials and Dummy Socket on Wing Valance	119
113.	Cable Clips for Aerial Co-Axial Leads	120
114.	Radio Table	120
115.	Radio Batteries	121
116.	Terminal Boxes	122
117.	Insulated Terminals	122
118.	Operator's Seat	124
119.	Ammeters and Radio Fuse, 40 amp models	124
119A.	Ammeters, 90 amp models	124
120.	Radio Table Earth Braid	125
121.	Position of Battery Carrier Holes	127
122.	Position of Battery Table Earth Braid	128
123.	Holes for Angle Framework	128
124.	Bonnet Catches	129
125.	Spare Wheel Mounting on Bonnet	130
126.	Seat Adjustment, Rover 9 Vehicles	130
127.	Radio Operator's Seat	131
128.	Windscreen Fixing Screws, early models	131
128A.	Windscreen Fixing Screws, late models	131
129.	Windscreen Wiper Motor	132
130.	Windscreen Ventilators	133
131.	Fire Extinguisher	135
132.	Circuit Diagram, 40-Amp Generator	142
132A	Circuit Diagram 90-Amp Generator	142A

NOTES TO READERS

The subject of this publication may be affected by Army Council Instructions. If possible, amendments are issued to correct this publication accordingly. When an Instruction contradicts any portion of this publication, the Instruction is to be taken as the overriding authority.

~~This publication covers all types of Rover 8 and 9 FFR vehicles.~~

When the suffix figure after Rover 8 and 9, e.g., '8/2', '9/1' appears in the nomenclature on the vehicle inscription plate it indicates the following:

(a) Suffix '1' indicates that strengthened differential and axle shafts are fitted to the rear axle only.

(b) Suffix '2' indicates that neither differentials nor axle shafts have been strengthened.

When no suffix figure is shown on the vehicle inscription plate after 'Rover 8' or 'Rover 9' it indicates the following:

Rover 8, indicates an 88 in. W.B. model with strengthened front and rear differentials and strengthened rear axle shafts.

Rover 9, indicates a 109 in. W.B. model with strengthened front and rear differentials and strengthened rear axle shafts.

LIST OF ASSOCIATED PUBLICATIONS

Publication	Army Code No.
Parts List	20873
Technical Handbook	EMER, Wh. Vehs. Q.022.
Servicing Schedule	14044
User Handbooks	
Radio Stations for Rover 8 and 9	12793
Wireless Sender C11	12052
Wireless Station No. C42	11197
Wireless Set C12	11562
Wireless Set B47	11791
Reception Set R210	12051

SECTION I
General Description

CHAPTER 1

INTRODUCTION

VEHICLE SERIAL NUMBERS

1. The vehicle serial number, comprising eight digits and a suffix letter, will be found on the transfer box instruction plate on the dash panel over the gearbox cover. It is the same as the chassis number, which is stamped on the left-hand rear spring shackle bracket.

The engine serial number is stamped on the left-hand side of the cylinder block at the front.

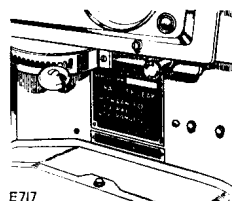

Fig. 1
Vehicle Serial Number

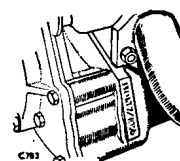

Fig. 2
Engine Serial Number

Other units bear serial numbers as detailed below, but they should not be quoted unless specifically requested:—

Gearbox number: Right-hand side of gearbox casing at rear.

Rear axle: On top of axle casing on left-hand side.

Front axle: On top of axle casing on left-hand side.

NOMENCLATURE

2. Reference is made throughout the text to the "left-hand" and "right-hand" sides of the vehicle, rather than to "near-side" and "off-side". The "left-hand" side is that to the left hand when sitting in the driver's seat.

In some instances the abbreviation "R.H.D." is used to denote right-hand drive.

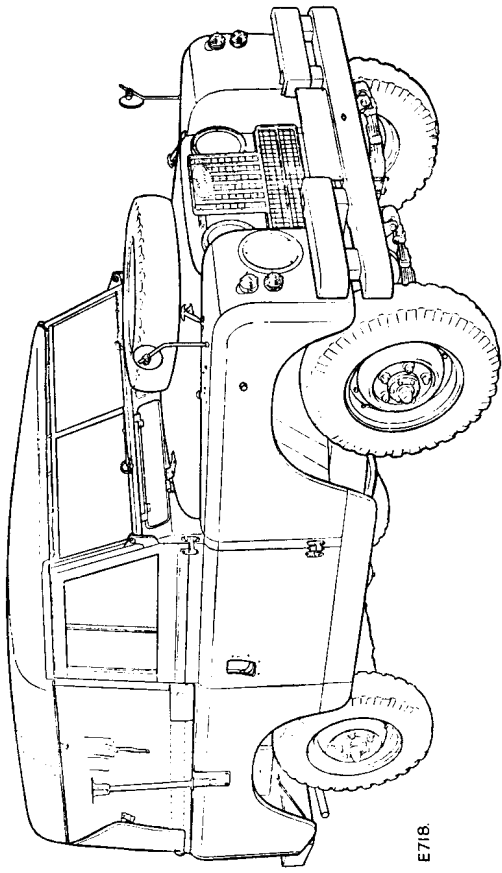

E718.

Fig. 3. Three-quarter front view. Rover 8

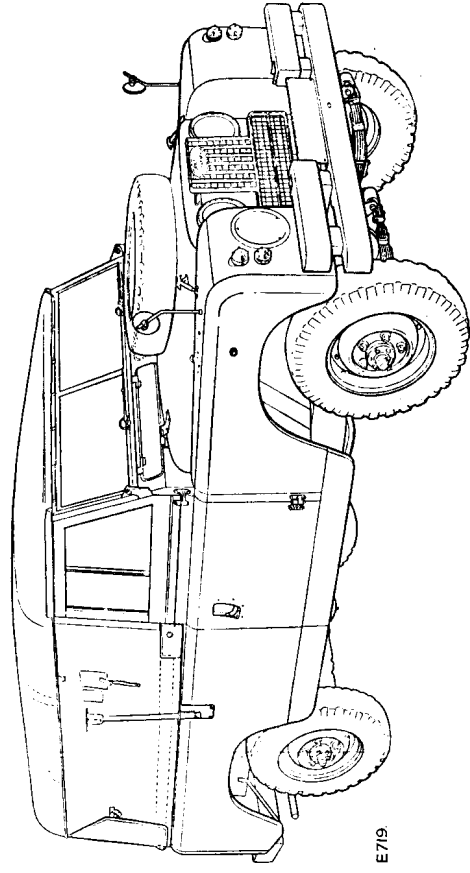

E719.

Fig. 4. Three-quarter front view. Rover 9

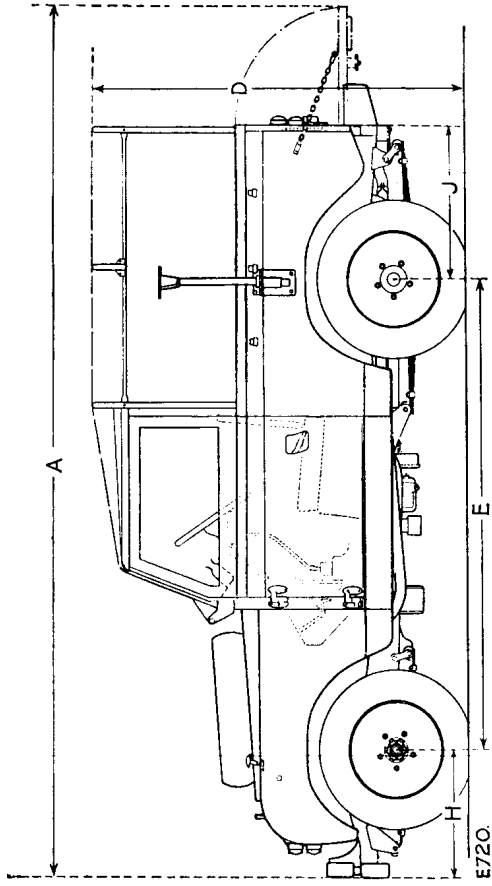

Fig. 5. General side view
General Arrangement

	Rover 8	Rover 9
A. Overall length (tailboard down)	162½ in. (4.11 m)	195½ in. (4.95 m)
B. Overall length (tailboard up)	147 in. (3.73 m)	180 in. (4.57 m)
C. Overall width	72 in. (1.82 m)	72 in. (1.82 m)
D. Overall height (unladen)	77½ in. (1.97 m)	77½ in. (1.97 m)

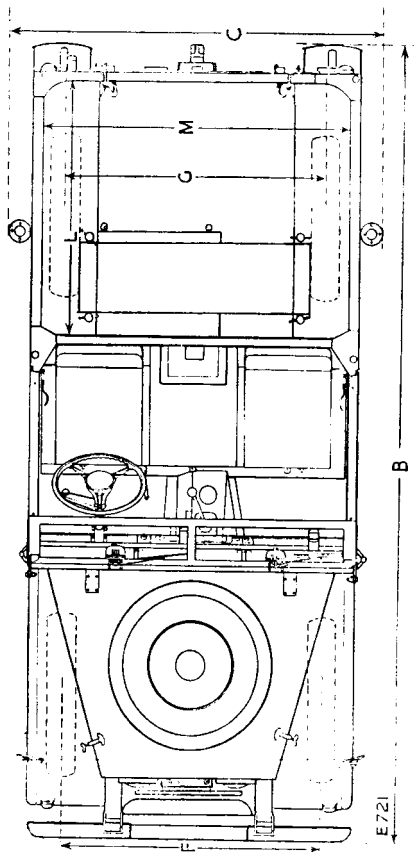

Fig. 6. General plan view
General Arrangement

	Rover 8	Rover 9
E. Wheelbase	88 in. (2,23 m)	109 in. (2,77 m)
F. Track, front	51½ in. (1,31 m)	51½ in. (1,31 m)
G. Track, rear	51½ in. (1,31 m)	51½ in. (1,31 m)
M. Length of body (internal)	43 in. (1,09 m)	72½ in. (1,85 m)
N. Width of body (internal)	56½ in. (1,44 m)	56½ in. (1,44 m)

CHAPTER 2
DESCRIPTION OF VEHICLE

3. The vehicles drive on the rear wheels with the option of front wheel drive when conditions make it necessary to drive on all four wheels. The description that follows applies to all vehicles unless the paragraph states otherwise.
 4. Engine, four-cylinder, detachable cylinder head; flexibly mounted on rubber at four points, three crankshaft bearings, four camshaft bearings, overhead inlet and exhaust valves operated by followers and push rods, camshaft driven by duplex chain automatically adjusted by hydraulic tensioner.
 5. Lubrication is full pressure from gear type oil pump to all bearings and valve gear, external A.C. full-flow oil filter and an intake filter on the oil pump.
 6. Impeller type coolant pump and fan driven from crankshaft, temperature controlled by thermostat, pressurised system to decrease loss of coolant under hard working conditions.
 7. Front-wheel drive is transmitted through spiral bevel gearing and normal type differential to the half-shafts and thence via enclosed universal joints to the front hubs.
 8. The rear axle is of the "fully-floating" type, the drive being transmitted by spiral bevel gearing and normal type differential to the axle shafts.
 9. The gearbox unit comprises a main gearbox, four forward speeds and a reverse and a two-speed transfer box mounted on the rear of the main gearbox with output shafts to front and rear axles.
 10. The suspension is by semi-elliptic leaf springs at both front and rear. As a safeguard in the event of main spring fracture, the ends of each second leaf are curled over the bushes to afford some measure of support until the defect can be rectified.
 11. The steering is of the re-circulating ball type.
 12. Hydraulic brakes on all wheels, with mechanical hand brake operating on the transmission output shaft from the transfer box.
 13. All vehicles have a 24-volt negative earth electrical system with an alternating current (A.C.) generator. Some vehicles have a 40-ampere output generator with an external rectifier to convert the A.C. output to direct current (D.C.). Others have a 90-ampere generator with a built-in rectifier system. A screened and waterproof coil ignition system is fitted.
- The vehicles are prepared to receive a radio station and are completely suppressed to prevent interference to radio. See Chapter 13.

CHAPTER 3

Dimensions	Rover 8		Rover 9	
	British	Metric	British	Metric
Overall length	147 in.	3,73 m	180 in.	4,57 m
Overall width	72 in.	1,82 m	72 in.	1,82 m
Overall unladen height:				
Hood up	77½ in.	1,97 m	—	—
Hood down, screen up	68 in.	1,73 m	—	—
Hood down, screen down	57½ in.	1,46 m	—	—
Wheel base	88 in.	2,23 m	109 in.	2,77 m
Track	51½ in.	1,31 m	51½ in.	1,31 m
Internal body dimensions:				
Length, between cappings	43 in.	1,09 m	72½ in.	1,85 m
Width, between cappings	56½ in.	1,44 m	56½ in.	1,44 m
Depth	19½ in.	495 mm	19 in.	483 mm
Height of wheel-arch	8½ in.	216 mm	9 in.	229 mm
Width of wheel-arch, to boot side	13½ in.	349 mm	13½ in.	349 mm
Width of floor, between wheel-arches	36½ in.	921 mm	36½ in.	921 mm
Turning circle	38 ft.	11,6 m	45 ft.	13,72 m
Unladen ground clearance:				
6.50 × 16 tyres	8½ in.	213 mm	—	—
7.50 × 16 tyres	—	—	9½ in.	248 mm

	Rover 8		Rover 9	
	British	Metric	British	Metric
Weights				
Unladen:				
Total, dry, less coolant and fuel	3,508 lb.	1,588 kg.	3,895 lb.	1,810 kg.
Running with coolant, oil, 20 gallon fuel	3,690 lb.	1,674 kg.	4,077 lb.	1,849 kg.
Front axle	1,929 lb.	875 kg.	2,203 lb.	999 kg.
Rear axle	1,761 lb.	799 kg.	1,874 lb.	850 kg.
Laden:				
* Total, maximum approved gross loaded	4,453 lb.	2,020 kg.	5,705 lb.	2,588 kg.
Front axle	1,828 lb.	829 kg.	2,140 lb.	971 kg.
* Rear axle	2,625 lb.	1,190 kg.	3,565 lb.	1,617 kg.
Shipping tonnage:				
Hood down, screen down	—	—	—	—

* Cross-country work, rear pay load must be reduced by 200 lbs. (91 kg.)

10

Amdt. No. 3

Bridge classification	—
Shallow fording depth (unprepared)	20 in. (508 mm)
Performance	
Average safe speed (cross-country)	5-30 m.p.h., depending upon terrain.
Maximum gradient climbable (fully laden)—	
Rover 8	Over 1 : 1.71
Rover 9	1 : 1.71
Range of action on road (average speed 30 m.p.h. (50 km/h))—	
Rover 8	360 miles (580 km)
Rover 9	280-360 miles (450-580 km)
Fuel consumption target (normal road conditions)—	
Rover 8	18 m.p.g. (6.4 km/litre)
Rover 9	14-17 m.p.g. (4.9-6.02 km/litre)
Nett power/gross wt. ratio—	
Rover 8	38.7 b.h.p./ton
Rover 9	30.2 b.h.p./ton
Maximum tractive effort—top gear and high transfer engaged (95 per cent efficiency)—	
Rover 8	206 lb./ton
Rover 9	160 lb./ton
Tyre size	6.50 × 16, or 7.50 × 16 cross-country and dual purpose.
Tyre pressures (recommended)—	
Road (normal)	Front 25 lb./sq. in. Rear 25 lb./sq. in.
(Fully laden)	Front 25 lb./sq. in. Rear 30 lb./sq. in.
Cross-country (soft ground—load under 5 cwt.)	Front 15 lb./sq. in. Rear 15 lb./sq. in.
Soft ground—load over 5 cwt.	Front 15 lb./sq. in. Rear 20 lb./sq. in.

NOTE.—Reference to be made to current instructions.

Wheel type Divided rim

11

Capacities

	<i>Imp. Unit</i>	<i>U.S. Unit</i>	<i>Litres</i>
Fuel	20 galls.	24 galls.	90
Coolant	17½ pints	21 pints	10,0
Engine sump, 3 pints (1,75 litre) extra when refilling after fitting new filter	11 pints	13 pints	6,0
Gearbox	2½ pints	3 pints	1,5
Transfer box	4½ pints	5½ pints	2,5
Rear axle	3 pints	3½ pints	1,75
Front axle	3 pints	3½ pints	1,75
Hydraulic brakes	—	—	—
Swivel pin housing (each)	1 pint	1.2 pints	0,5
Air cleaner	1½ pints	2 pints	0,85

Engine

Type	Gasoline
Number of cylinders	4
Cylinder arrangement	Vertical in line
Maximum b.h.p. at clutch	77 at 4,250 r.p.m.
Loss of efficiency at altitudes of:—	
5,000 feet	18 per cent
10,000 feet	34 per cent
Maximum torque	124 lb. ft. (17 kg.m) at 2,500 r.p.m.
Bore	90.47 mm (3.562 in.)
Stroke	88.9 mm (3.500 in.)
Cylinder capacity	2,286 c.c. (139.5 cu. in.)
Compression ratio	7.0-1
Tappet clearance—inlet010 in. (0.25 mm.) engine cold or at running temp.
Tappet clearance—exhaust010 in. (0.25 mm) engine cold or at running temp.
Valve timing (No. 1 exhaust valve peak)	95° B.T.D.C.

12

Ignition

Distributor—Model	Lucas type D.Z.S. 4A (Screened) Part No. 40753
Distributor contact breaker gap014 to .016 in. (0,35 to 0,40 mm).
Ignition timing (static—full retard)	T.D.C. when using 74-76 octane fuel 3 deg. B.T.D.C. when using 80-85 octane fuel. 6 deg. B.T.D.C. when using 90-96 octane fuel.
Firing order	1, 3, 4, 2
Coil	Lucas type 5C.10
Sparking plugs (fitted on Production)	Screened type Champion RSN BPA
Replacement sparking plugs	LV6/MT4/3343 or LV6/MT4/79698
Sparking plug point gap	0.015 to 0.018 in. (0,381 to 0,457 mm).

Engine Lubrication System

Type	Full pressure
Oil filter—internal	Gauze pump intake filter in sump.
Oil filter—external	Full-flow filter, AC type: KF; element: AC type FF 50.
Oil pump	Gear type, camshaft operated
Oil pressure	55 to 65 lb./sq. in. (3.8 to 4.6 kg/cm ²) at 30 m.p.h. (50 k.p.h.) in top gear with engine warm.
Pressure relief valve	55 to 65 lb./sq. in. (3.8 to 4.6 kg/cm ²).

Cooling System

Type	Pressurized. 9 lb./sq. in.
Radiator	Fin and tube type
Fan	Eight-bladed, belt driven from crankshaft.
Circulation	By centrifugal impeller type coolant pump.
Cooling control	By thermostat. Start to open at 164°-173°F. (73-78°C.). Fully open at 193°F. (89°C.)

13

Fuel System	
Fuel pump	A.C. mechanical with sediment bowl.
Carburetter	Down-draught type, Solex type. 40 PA10-5A.
Carburetter jets	Main jet 125 Jet accelerator pump 65 Choke tube 28 Correction jet 185 Pilot jet 50 Jet, air bleed 1.5 Starter jet, gasoline 145 Starter jet, air 6.5
Air cleaner	AC oil bath type with integral centrifugal pre-cleaner.
Filter	Sediment bowl type.
Clutch	
Type	Single dry plate 9 in. (230 mm), diameter Borg and Beck.
Adjustment	1½ in. (38 mm) free movement at pedal pad.
Operation	Hydraulic
Main Gearbox	
Type	Single helical constant mesh on top, third and second with synchro-mesh top and third speeds.

Main Gearbox Ratios

	Contract	
	Prior to WV/2985	From WV/2985 onwards
Top	Direct	Direct
Third	1.377-1	1.512-1
Second	2.043-1	2.22-1
First	2.996-1	3.6-1
Reverse	2.547-1	3.02-1

Transfer Gearbox	
Type	Two-speed reduction on main gearbox output.
Front-wheel drive	Two/four wheel drive control on transfer gearbox output.

Transfer Gearbox Ratios

	Contract	
	Prior to WV/2985	From WV/2985 onwards
High transfer	1.148-1	1.148-1
Low transfer	2.888-1	2.4-1

Front Axle

Differential	Spiral bevel
Front wheel drive	Enclosed universal joints
Ratio	4.7-1

Rear Axle

Type	Spiral bevel; fully-floating shafts.
Ratio	4.7-1

Overall Ratio Including Final Drive

	Contract		Contract	
	Prior to WV/2985		From WV/2985 onwards	
	High transfer	Low transfer	High transfer	Low transfer
Top	5.40-1	13.60-1	5.40-1	11.28-1
Third	7.40-1	18.69-1	8.15-1	17.00-1
Second	11.00-1	27.70-1	12.00-1	25.00-1
First	16.20-1	40.60-1	19.40-1	40.60-1
Reverse	13.77-1	34.60-1	16.30-1	34.00-1

Change speeds for all the above ratios. See para. 48.

Rover 8

Brakes

Front and rear brakes—		
Type		Girling hydraulic, by leading and trailing shoes.
Size of lining: Length	8½ in. (215 mm)
Width	1½ in. (38 mm)
Total lining area	104 sq. in. (657,5 cm²)
Brake drum diameter	10 in. (254 mm)
Brake pedal free movement at master cylinder	⅜ in. (5 mm)

		Rover 9
Front brake—		
Type	Girling hydraulic by two leading shoes.
Size of lining: Length	10.45 in. (265,4 mm)
Width	2½ in. (57,15 mm)
Total braking area of linings	94 sq. in. (606,49 cm²)
Brake drum diameter	11 in. (279,4 mm)
Brake pedal free movement at master cylinder	⅜ in. (5 mm)
Rear brake—		
Type	Girling hydraulic by leading and trailing shoes.
Size of lining: Length	8.6 in. (218,4 mm)
Width	2½ in. (57,15 mm)
Total braking area of linings	77.8 sq. in. (501,643 cm²)
Brake drum diameter	11 in. (279,4 mm)
Brake pedal free movement at master cylinder	⅜ in. (5 mm)

		Rover 8 and 9
Hand brake—		
Type	Mechanical on transfer box output shaft
Size of lining: Length	7.69 in. (195,3 mm)
Width	1½ in. (44,5 mm)
Area	27 sq. in. (173,5 cm²)
Drum diameter	9 in. (228 mm)
Steering (Re-circulating Ball Type)		
Type	Burman re-circulating
Gear ratio—variable	Straight ahead 15.6-1
	Full lock 23.8-1
Diameter of steering wheel	17 in. (431 mm)
Front wheel toe-in	¼ to ⅜ in. (1.2-2.4 mm)
Camber angle	1¼°
Castor angle	3°
Swivel pin inclination	7°
Steering wheel free movement	⅜ in. (16 mm)

Suspension	
Road springs Semi-elliptic leaf
Hydraulic dampers Telescopic, non-adjustable. Make: Woodhead-Monroe; Front and Rear.

Electrical Equipment	
System 24-volt, negative earth having a rectified AC generating system.

	Vehicles with 40-Amp generator	Vehicles with 90-Amp generator
Batteries		
Type	Lucas type BT7A	Lucas type BT7A
Voltage	24V 2 x 12V in series	24V 2 x 12V in series
Capacity	38 a.h.	38 a.h.
Generator	CAV type AC724/1	No. 10 Mk 2—FV546125
Generator Panel	CAV type 323/2	No. 9 Mk 3—FV546128
Starter	CAV type SCA/150	CAV type SCA/150
Fuses—engine side of bulkhead	35-Amp cartridge type	35-Amp cartridge type
Adjacent to instrument panel	40-Amp (25 SWG tinned copper)	—

Lamps

Position	Make and Type	Voltage	Wattage
Headlights (vertical dip)	Lucas No. 368	24	50/50 double filament
Sidelights	Lucas No. 149	24	6
Stop/tail lights	Lucas No. 337	24	Double filament 7/30
Instrument panel lights	Lucas No. 650	24	2.8 M.E.S.
Warning lights	Lucas No. 650	24	2.8 M.E.S.
Convoy light	Lucas No. 149	24	6
Turnlights	Lucas No. 339	24	24
Number light	Lucas No. 149	24	6

SECTION II

Operation

CHAPTER 1

CONTROLS

Controls

14. The controls and instruments are illustrated at Fig. 11.

Pedals

15. Pendant type accelerator, footbrake and clutch with hydraulic clutch operation.

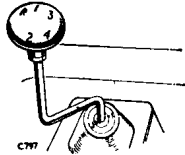

Fig. 7. Main gear change lever

Main Gear Change Lever

16. The lever position for engaging the gears is indicated on the knob of the lever. See para. 48 for gear changing instructions.

Transfer Gearbox Lever

17. The lever controlling the two-speed transfer box is situated to the right of the gearbox cover; it must be pushed right forward for normal high ratio work. See para. 50 for instructions on use of the transfer box.

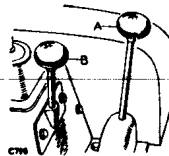

Fig. 8. Transfer gear change lever and front wheel drive control
A—Transfer gear change lever. B—Front wheel drive control

Front Wheel Drive Control

18. The yellow knob, protruding from the gearbox cover, engages the front wheel drive. The operation is described in para. 51.

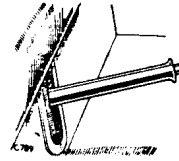

Fig. 9. Hand brake

Hand Brake

19. Protrudes through the front of the seat box. To release the brake, pull upwards slightly, depress the button in the top of the hand grip and push down as far as possible; to apply the brakes, pull the lever upwards.

Horn, Push Button

20. The horn push is in the centre of the steering wheel.

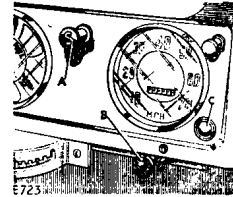

Fig. 10. Starter switch and mixture control (cold start)
A—Starter switch. B—Mixture control (cold start)
C—Mixture control (cold start) warning light

Starter Switch

21. The starter switch is located centrally on the main instrument panel between the speedometer and instrument group. It is marked "S" for identification purposes and should be depressed to operate the starter motor and released as soon as the engine fires.

Mixture Control (Cold Start)

22. Marked "Cold Start" and mounted on the dash panel below the speedometer. See para. 41 for operation.

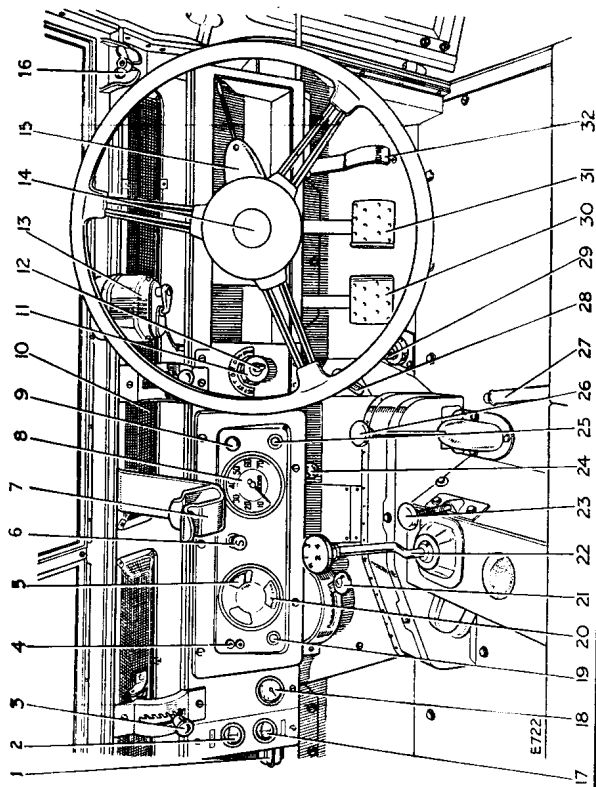

Fig. 11. Layout of controls and instruments

Key to Fig. 11

	See Para. No.
1.—Fuse box (not fitted to vehicles with 90A generator)	236
2.—Vehicle ammeter (scale 0-100A on vehicles with 90A generator).....	33
3.—Ventilator knob	314
4.—Inspection socket	30
5.—Fuel level gauge	34
6.—Starter switch	21
7.—Rifle clip	130
8.—Speedometer	35
9.—Panel light switch	27
10.—Flyscreen	314
11.—Switch for lamps	25
12.—Ignition key	24
13.—Windscreen wiper	29
14.—Horn push	20
15.—Turnlight switch and indicator	28
16.—Wingnut securing windscreen	312
17.—Radio ammeter (scale 0-100A on vehicles with 90A generator)	33
18.—Oil temperature gauge	39
19.—Oil pressure warning light	36
20.—Main beam warning light	38
21.—Hand throttle control	23
22.—Main gear lever	16
23.—Front wheel drive control	18
24.—Mixture control (cold start)	22
25.—Mixture control (coldstart) warning light	37
26.—Transfer gear change lever	17
27.—Handbrake	19
28.—Fuel change-over switch	31
29.—Dip switch	26
30.—Clutch pedal	15
31.—Brake pedal	15
32.—Accelerator	15

NOTE:—Ignition warning light (red) at bottom centre of instrument panel on vehicles with 90A generator. Not illustrated.

Hand Throttle Control

23. The hand throttle control, which is the quadrant type, is mounted just below the instrument panel.

The quadrant has a number of notches for the operating lever. The notch to the extreme right is for use when the hand throttle is not required. In order to bring the hand throttle control into operation move the lever to the left into one of the remaining notches.

See Para. 231 for use of this control, when stationary battery charging is required.

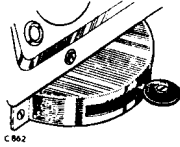

Fig. 12. Hand throttle control

Ignition Switch and Key

24. Integral with the light switch fitted to a panel on the right-hand side of the instrument panel; turn the key clockwise for 'on'. The key is detachable.

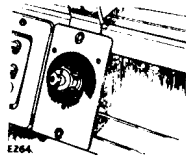

Fig. 13. Ignition switch and key

This switch controls the engine electrical equipment and the windscreen wipers. See wiring diagram.

Light Switch, 6-way

25. Situated on a panel at the right-hand side of the instrument panel. Also fitted to the panel is an indicator plate showing the switch positions.

Stop and turnlights are on at all switch positions except when turned to right, i.e. when convoy lights are on.

Turn switch to right:

First position—convoy light.

Second position—side and convoy lights.

Turn switch to left.

First position—tail and number lights.

Second position—side, tail and number lights.

Third position—head, side, tail and number lights.

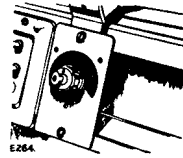

Fig. 14. Light switch, 6-way

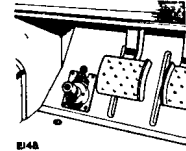

Fig. 15. Headlight dip switch

Headlight Dip Switch

26. When the foot-operated dip switch, situated to the left of the clutch pedal, is used it replaces the primary filaments in both headlamps by secondary filaments directed downwards or vice-versa.

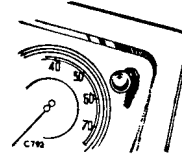

Fig. 16. Instrument panel light switch

Instrument Panel Light Switch

27. The push-pull switch controlling the panel lights, in the top right-hand corner of the panel, is only operative with the light switch at HST, ST, S. CONV.

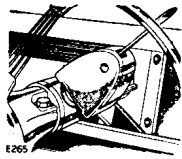

Fig. 17. Turnlight self-cancelling switch and warning light

Turnlights Switch

28. The self-cancelling switch, complete with warning light, is attached to the steering column and is cancelled by movement of the steering wheel.

When the turnlights are functioning correctly the warning light will flash and the flasher unit will be audible.

Should either a front or rear turnlamp fail, the other lamp will continue to flash, but the warning light will not glow and the flasher will not be heard.

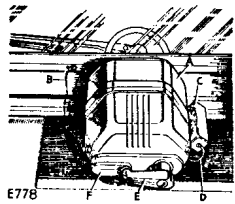

Fig. 18. Windscreen wiper motor

A—Wiper motor. B—Earth lead. C—Suppressor for wiper motor
D—Lead for suppressor. E—Blade lever. F—Switch lever

Windscreen Wiper Switch

29. To set the wiper in operation, pull out the blade lever, turn it to clear the switch lever and turn the latter through 90°. To park the blade, reverse these operations.

Two windscreen wipers are fitted, each is operated independently as detailed above.

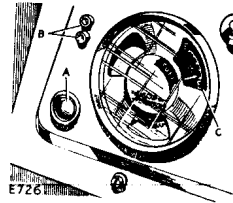

Fig. 19. Inspection light socket

A—Oil pressure warning light B—Inspection light socket
C—Fuel gauge.

Inspection Light Socket

30. In the top left-hand corner of the instrument panel are a pair of inspection light sockets; the black socket is earthed.

Fuel Change-over Tap and Switch

31. The combined fuel change-over tap and switch is located on the toe-board. Turn lever to left for L.H. tank and right for R.H. tank; movement of the control also switches on the fuel level tank unit for the particular tank in use and so indicates on the fuel gauge the amount of fuel in either tank according to the position of the control.

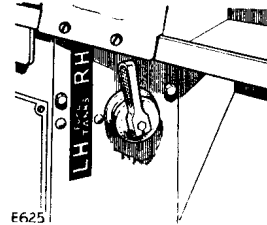
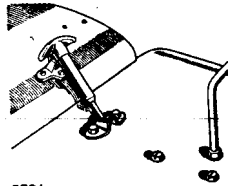

Fig. 20. Fuel change-over tap and switch

Bonnet

32. The bonnet top panel is secured by two pull-on type catches, one at each side.

To open bonnet release catches and raise until it is held open by the support stay. To close, release support stay, lower and secure the bonnet with the catches at either side.



E724
Fig. 21. Bonnet catches

INSTRUMENTS

Ammeters

33. Situated on the left of the main instrument panel are two ammeters. The upper ammeter is identified by a large label marked "VEHICLE"; the lower one is marked "RADIO". On vehicles fitted with a 40A generator the ammeters are graduated 40-0-40 and indicate the charge or discharge currents of the respective batteries. On other vehicles the ammeters are graduated 0-100A and indicate the charging current to the respective batteries.

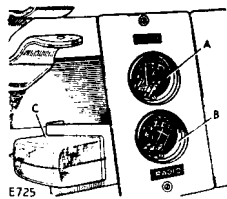

E725
Fig. 22. Ammeters and fuse box, 40 amp models
A—Vehicle ammeter.
B—Radio ammeter.
C—Fuse box.

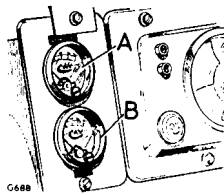

G688
Fig. 22A. Ammeters, 90 amp models
A—Vehicle ammeter.
B—Radio ammeter.

Fuel Level Gauge

34. The fuel level gauge, in the multiple panel, only operates with the ignition "on". This gauge is not a precision instrument and cannot be used to derive fuel consumption figures. See para. 31 for fuel level reading.

26

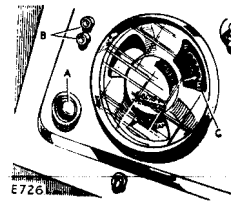

E726
Fig. 23. Fuel level gauge
A—Oil pressure warning light. B—Inspection light sockets
C—Fuel gauge.

Speedometer

35. A speedometer is situated to the right of the multiple gauge, it indicates the speed of the vehicle and also shows total mileage.

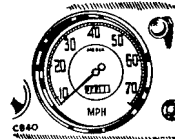
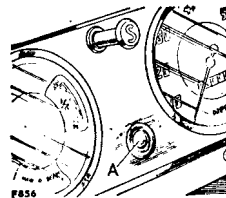

Fig. 24. Speedometer

Ignition Warning Light, vehicles fitted with 90A generator



F856
Fig. 25. Ignition warning light
A—Ignition warning light.

35A. The red warning light, at the bottom centre of the instrument panel, glows when the generator fails to charge or the generator charging rate is low. It will glow when the ignition is switched on and the engine is stationary or running slowly and will go out when the engine speed rises.

Oil Pressure Warning Light, Fig. 23(A)

36. The green light, at the bottom left-hand corner of the panel, glows when the engine oil pressure drops below a safe figure. It will light up when the engine is stationary and fade out when the engine starts and the oil pressure builds up to normal. See para. 80 for further details.

27

Mixture Control (Cold Start) Warning Light

37. The amber light at the bottom right-hand corner of the panel, glows when the engine is hot and the mixture control (cold start) is "out", thus reminding the driver to push in the control. See para. 45.

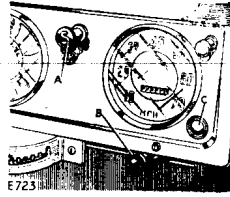

Fig. 26. Mixture control (cold start) warning light

A—Starter switch B—Mixture control (cold start)
C—Mixture control (cold start) warning light

Headlight Main Beam Warning Light

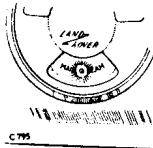

Fig. 27. Headlight main beam warning light

38. The small red light at the bottom centre of the multiple gauge glows when the main headlight beams are in use; its purpose is to remind the driver to switch off or dip the headlights on entering a brightly-lit area.

Oil Temperature Gauge

39. The oil temperature gauge mounted on a panel at the left-hand side of the instrument panel gives a continuous indication of the oil temperature. The oil temperature should never exceed 90°C. and the engine must be switched off and the oil allowed to cool down if this temperature is reached under working conditions.

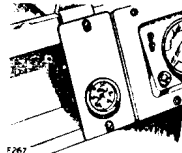

Fig. 28. Oil temperature gauge

CHAPTER 2

OPERATING INSTRUCTIONS

BEFORE STARTING THE ENGINE

40. Before attempting to start the engine, read the following notes concerning the mixture control (cold start) and accelerator.

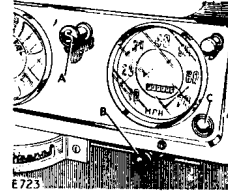

Fig. 29. Mixture control (cold start)

A—Starter switch. B—Mixture control (cold start).
C—Mixture control (cold start) warning light.

Mixture Control (Cold Start)

41. Marked "Cold Start" and mounted on the dash below the speedometer.

It is fully progressive and it is only necessary to pull it out sufficiently to start the engine.

The half-way position, which is indicated when a light click is felt, should be sufficient to start the engine at temperatures around freezing point.

The control should only be pulled out fully when starting at extremely low temperatures such as 0°F. (-17°C.) or below.

When the engine has started, the control must be returned to the normal position as soon as possible, consistent with even running.

Accelerator

42. The carburettor is fitted with an accelerator pump, so that when the accelerator is fully depressed, an extra rich mixture is provided to assist acceleration. As this is not required when starting the engine, except under abnormal starting conditions, the accelerator must not be touched when starting with a cold engine.

It may assist starting a hot engine if the accelerator is depressed half-way and then released as soon as the engine fires.

Never pump the accelerator pedal under any circumstances.

STARTING THE ENGINE

43. To start the engine adopt one of the methods detailed below.

- (1) Ensure that the main gear lever is in the neutral position and that the transfer box lever is in high ratio position, i.e. right forward.
- (2) Start the engine as follows:—
 - (a) Engine cold.
 - (i) Pull the mixture control approximately half-way out. See para. 41.
 - (ii) Keep the foot clear of the accelerator.
 - (iii) Switch on the ignition, check that the green oil pressure warning light and, when fitted, the ignition warning light, both glow.
 - (iv) Press the starter button, when the engine should start after a turn or two. Release the starter button immediately the engine fires.
 - (b) Engine warm or hot.
 - (i) Set the mixture control right in.
 - (ii) Depress the accelerator half-way.
 - (iii) Switch on the ignition, check that the green oil pressure warning light and, when fitted, the ignition warning light, both glow.
 - (iv) Press the starter button.
 - (v) Release the starter button, remove the foot from the accelerator as soon as the engine fires.

NOTE. If the engine makes a false start, allow the starter to come to rest before pressing the starter button again. Should the engine fail to start after two or three attempts, investigate and correct the cause before the battery is run down needlessly.

30

Amdt No. 4

WHEN THE ENGINE STARTS

44. The following points should be noted when the engine starts.

- (1) The mixture control must be returned to the normal position as soon as possible, consistent with even running.
- (2) A glow from the "Amber Warning Light" on the instrument panel will indicate that the control has been left out inadvertently and must be pushed in at once.
- (3) Do not race the engine; drive away at moderate speed immediately after starting, so stimulating lubrication of the cylinder walls as the engine warms up.
- (4) Check that the green (oil) and, when fitted, the red (ignition) warning lights go out. See Paras. 80 and 35A.

Warning Lights

45. Like all mechanical devices, the mixture control warning system is not completely fool-proof and the responsibility for pushing in the mixture control rests with the driver, especially as the warning light may not glow due to lamp failure. Suspected lamp failure may be confirmed by pulling out the mixture control (cold start) momentarily when the engine is hot, when the lamp should be illuminated.

To guard against lamp failure in the oil pressure and, when fitted, the ignition warning lights, a check should be made that the lamps glow each time the ignition is switched on.

MOVING OFF

46. Start the engine as detailed in para. 43 and select the appropriate gear. The latter will be dependent upon the type of terrain to be negotiated. See paras. 48, 49, 50 and 51.

After observing the above, proceed as follows:—

- (1) Depress the clutch pedal fully and engage first gear. Increase the engine speed slightly, release the hand brake lever and gradually release the clutch pedal. As the engine begins to take the load, increase the engine speed.
- (2) Accelerate the engine sufficiently to enable the next higher gear to be engaged without overloading the engine. See para. 48.

GEAR SELECTION

Main Gear Lever

47. The positions of the main gear change lever are marked on the lever knob. It should be noted that the only reverse stop is a spring in the selector mechanism which tends to hold the lever away from the reverse selector shaft.

31

Amdt. No 4

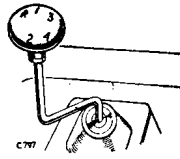

Fig. 30. Main gear change lever

Gear Changing

48. Synchro-mesh gears are provided for changing from second to third, third to top and top to third and in these cases single declutching may be used; for all other changes, it is advisable to use the double de-clutch method.

Until experience is gained under differing operating conditions, the following speeds may be used as a guide when changing gear:—

	High ratio	Low ratio
First to second	5-8 m.p.h. (8-13 k.p.h.)	Within two or three vehicle lengths of starting
Second to third	15 m.p.h. (25 k.p.h.)	6 m.p.h. (10 k.p.h.)
Third to top	20-25 m.p.h. (32-40 k.p.h.)	10 m.p.h. (16 k.p.h.)

Transfer Box Lever

49. The transfer box gives two ratios in the output from the main gearbox, termed "high" and "low", thus giving a total of eight forward and two reverse speeds in all. It is controlled by the lever to the right of the gearbox cover; this has three positions—right forward for high ratio, mid-way for neutral and right back for low ratio.

For normal usage and road work the lever should be in the high position. Low ratio is used when the vehicle is to be operated on heavy ground and for heavy pulling.

The neutral position mid-way between "high" and "low" is quite definite and is used with the power take-off for stationary work: the vehicle cannot be driven with the lever in neutral.

Transfer Gear Changing

50. Changing from "high" to "low" transfer ratio should only be attempted when the vehicle is stationary. The engine may be left running, but the main gear lever must be in the neutral position. Depress the clutch pedal and pull the transfer box lever right back; release the clutch. Should there be any hesitation in the gear engaging, do not force the lever. With the engine running, engage a gear in the main gearbox and let in the clutch momentarily; then return the main gear lever to neutral and try the transfer control again.

Changing from "low" to "high" transfer ratio may be accomplished at any time, regardless of vehicle speed. Release the accelerator pedal, depress the clutch pedal and push the transfer box lever right forward, pausing slightly in the neutral position; let in the clutch.

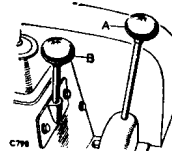

Fig. 31. Transfer gear change lever and front wheel drive control
A—Transfer gear change lever. B—Front wheel drive control

ENGAGING FOUR-WHEEL DRIVE

51. The vehicle may be operated in two-wheel or four-wheel drive as required; the drive to the front wheels is through a dog-clutch in the casing on the front of the transfer box, controlled by the yellow knob on the gearbox cover.

When operating the vehicle in "high" transfer ratio, the drive is normally to the rear wheels only; should conditions call for drive on all four wheels, i.e. when traversing soft country or descending a steep, muddy gradient, the front-wheel drive should be engaged by pressing down the knob on the gearbox cover. In order to regain two-wheel drive, on resuming hard surface travelling, stop the vehicle, engage "low" transfer ratio—gear lever with red knob—and return to "high" transfer ratio, when the dog-clutch is automatically disengaged and the yellow control knob returns to the "up" position.

On surfaced roads never engage four-wheel drive.

When operating the vehicle in "low" transfer ratio, four-wheel drive is automatically engaged at the same time as "low" ratio is selected; the front-wheel drive is automatically disengaged on regaining "high" transfer ratio.

Low transfer should only be engaged with the vehicle stationary.

PARKING THE VEHICLE

52. Stop the vehicle and apply the hand brake. If the vehicle is standing on a gradient it is advisable to engage first gear at the gearbox.

STATIONARY RUNNING

53. When the engine is operated for stationary running, see paras. 85 and 86.

CHAPTER 3

SPECIAL INSTRUCTIONS

RUNNING-IN PERIOD

54. Progressive running-in of a new vehicle is of the utmost importance and has a direct bearing on durability and smooth running throughout its life.

The running-in period is 500 miles (750 km), during which time 35-40 m.p.h. (55-65 k.p.h.) in high transfer ratio top gear should not be exceeded. The engine must not be allowed to labour at any time and full use should be made of the indirect gears to ensure that full throttle is not used even to achieve 40 m.p.h. (65 k.p.h.). If the vehicle is used in low transfer ratio when new, 15 m.p.h. (24 k.p.h.) should not be exceeded in top gear. Corresponding maximum speeds should be used in the lower gears.

Thereafter, maximum speeds may be increased gradually, but the vehicle should not be driven at prolonged high speeds until it has done 1,000 miles (1,500 km).

Never race the engine when cold at any time during the life of the vehicle.

MAXIMUM SPEEDS IN ALL GEARS AT 4,100 R.P.M.

55. Gear	M.P.H.	
	High transfer	Low transfer
Top	62	25
Third	45	18
Second	30	12
First	21	8
Reverse	24	10

FROST PRECAUTIONS

56. In cold weather, when the temperature may drop to or below freezing point, precautions must be taken to prevent freezing of the coolant in the cooling system.

As a thermostat is fitted in the system, it is possible for the radiator block to freeze in cold weather even though the engine running temperature is quite high.

57. In cold weather, unless the vehicle is kept in a well-heated garage or anti-freeze solution has been used, the cooling system must be completely drained. After the coolant has drained out, it is well to run the engine at a fast idling speed for not more than half a minute, so as to dry out any coolant that may have been retained in the bottom of the jacketing.

For draining instructions see para. 97.

Precautions concerning the battery will be found in Chapter 13.

TOWED EQUIPMENT

58. Before commencing to tow, the driver of the towing vehicle and the officer in charge must refer to the User Handbook/Service Schedule of the towed equipment or plant in order to familiarize themselves with:—

- (1) Special checks that may be required before starting and during the journey.
- (2) Types of lubricant required for road wheel bearings, etc., and method of application.
- (3) Speed restriction and bridge classification imposed by the nature of the towed equipment or plant.

NOTE.—When a vehicle tows an equipment or plant, except in the case of a standard train where the dual classification is usually given, the classification of the train should normally be taken as the sum of the separate classification of the prime mover and the towed equipment or plant.

FIRE AND SAFETY PRECAUTIONS

59. One fire extinguisher is provided with each vehicle. This is mounted horizontally on the dash panel below the instrument panel.

To operate proceed as follows:—

- (1) Free the extinguisher from the spring clip with a sharp pull and lift it out of the support cup.
- (2) Hold in one hand and point the nozzle in the base of the container towards the base of the fire.

- (3) With the other hand give the handle a half-turn to unlock it from the body and pull the handle outwards in an ordinary pumping cycle until the fire is out.

NOTE.—The pump has a double action and will operate on the first upwards stroke.

- (4) If the fire is extinguished before the liquid content of the unit is exhausted, the handle can be relocked in position and the extinguisher used again. It must, however, be replenished as soon as possible.

USE OF JACKS

60. When lifting the vehicle, place the jack under the road spring (below the axle casing) or below the chassis rear cross-member, ensuring that the wheels remaining on the ground are scotched.

FORDING

61. Fording depth is given below.
Maximum depth unprepared 20 in.

TOWING EQUIPMENT

Lifting and Towing Bracket

62. Lifting and towing rings are incorporated in the front bumperettes, one on each side of the front bumper.

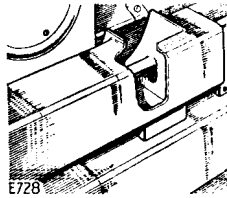

Fig. 32. Lifting and towing bracket

Rotating Towing Hook

63. This is a heavy duty towing hook and is attached to the rear of the chassis frame.

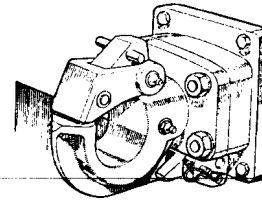

Fig. 33. Rotating towing hook

Bumperettes

64. Bumperettes are fitted to the front and rear. At the front they incorporate the lifting and towing rings.

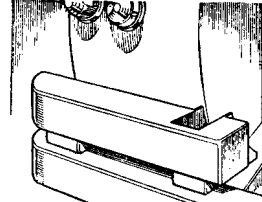

Fig. 34. Bumperettes, front illustrated

DO'S AND DON'TS

65. **Don't** keep your foot on the clutch pedal longer than it is necessary. It will avoid unnecessary wear.
- Don't** slacken the clamping nuts holding the two halves of the wheels together, unless the tyre is fully deflated. This is not applicable when road wheels with well base rims are fitted.
- Don't** agitate the accelerator pedal when starting the engine.
- Don't** push a metallic object through the radiator grille as it may touch the rectifier, and cause serious damage. This only applies to vehicles fitted with 40A generators.
- Do** keep radiator filled with soft water.
- Do** maintain recommended pressures in tyres, including the spare wheel.
- Do** ensure bonnet panel is fastened before driving away.

SECTION III
**User Servicing and
Adjustments**

GOOD SERVICING IS ESSENTIAL FOR
SUCCESSFUL FORDING

CHAPTER 1
THE ENGINE

Description

66. The four cylinder engine has overhead inlet and exhaust valves operated by push rods and roller tappets.
67. The engine is built in unit construction with a dry single-plate clutch and the main and transfer gearboxes, the whole being carried on four flexible rubber mountings.
68. The crankshaft is carried in three main bearings. At the front of the crankshaft is a pulley which drives the coolant pump and generator, while a spigot diameter at the rear, carries the flywheel.
69. Aluminium alloy pistons with two compression rings, and one slotted ring are fitted.
70. The camshaft is driven from the crankshaft by a duplex roller chain and runs in four white metal steel-backed bearings. The chain is kept in adjustment by the hydraulic tensioner.
71. The detachable 'flat' cylinder head carries both the inlet and exhaust valves.
72. A removable pressed steel sump carries the oil, which is pressure fed by a gear type oil pump in the sump driven from the camshaft through skew-gearing, to the main and connecting rod bearings and valve rocker shafts through a gallery pipe in the cylinder block. The oil is cleaned by means of a gauze strainer on the pump intake and an external full-flow filter.
73. An oil cooler is fitted to maintain the correct running temperature when the engine is run for long periods with the vehicle stationary. See para. 85.

38

74. A thermostat is fitted in the coolant system and the coolant is circulated by means of an impeller type pump, driven by a "V" belt from the crankshaft pulley. The belt tension is adjustable.

75. The fuel supply is by Solex down-draught carburetter, incorporating a two-phase acceleration and economy device.

76. Ignition is by screened coil, the distributor being mounted on an extension of the oil pump driving shaft. Automatic advance and retard mechanism is fitted, and, in addition, hand-setting facilities are provided to give control over the ignition setting when low quality fuel is used.

77. The sparking plugs are fully screened to prevent radio interference.

ENGINE LUBRICATION

Oil Level

78. A certain amount of oil is consumed during the normal operation of the vehicle, the oil in the sump must be checked and replenished daily, in addition to periodic oil changes.

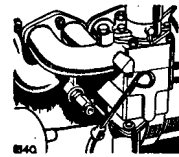

Fig. 35. Engine oil level dipstick

The oil level dipstick is on the left-hand side of the engine and is accessible when the bonnet panel is raised. There are three marks H (High), L (Low) and Min (Minimum). When using the Land-Rover on the road the oil level should not be allowed to fall below the minimum level mark, that is the lower line on the dipstick. However, when using the Land-Rover on cross-country work in circumstances which involve it being used at steep angles the oil should not be allowed to fall below the intermediate mark, that is the low level. This will obviate any danger of oil pump starvation when the vehicle is facing downhill at a steep angle. The oil filler is on the right-hand front corner of the engine. (See Fig. 38).

39

79. To check the oil level, proceed as follows:—

Stand the vehicle on level ground and allow a few minutes for the oil to drain back into the sump from the valve gear, etc. Withdraw the dipstick upwards, wipe it clean, re-insert to its full depth and remove a second time to take the reading. Add oil as necessary; never fill above the H mark.

Oil Pressure

80. The oil pressure warning light on the instrument panel will glow when, for any reason, the pressure drops below 10 to 12 lb./sq. in. (0,7 to 0,8 kg/cm²). It will light up when the engine is stationary and will go out when the engine has started and the oil pressure has built up to exceed this figure.

NOTE.—The light may flicker when the engine is running at idling speed, but providing it fades out immediately the engine is speeded up, the oil pressure can be considered satisfactory.

Should the warning light appear at any time when the engine is running above idling speed, stop the engine immediately and investigate the cause; usually it will be due to low oil level in the sump, or occasionally, to a choked oil pump intake filter.

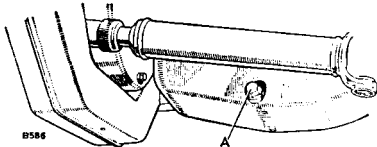

Fig. 36. Engine sump drain plug
A—Drain plug.

Engine Oil Changes

81. To change the engine oil, proceed as follows:—

Run the engine to warm up the oil, switch off the ignition and remove the drain plug in the right-hand side of the sump. Allow time for the oil to drain away completely and replace the plug.

Refill with oil of the correct grade through the filler at the front of the engine, the capacity is 11 Imperial pints (6 litres). See para. 78.

It is essential to add a further 3 pints (1,75 litres) of engine oil when the full flow filter element has been changed, to bring the oil level up to the High level mark on the dipstick.

Oil Filters. (To be carried out by a vehicle mechanic)

82. In addition to the gauze pump intake filter in the sump, the oil is cleaned by means of a full-flow pressure filter mounted externally on the engine.

40

The element of the full-flow filter should be renewed at regular intervals, preferably at a routine oil change.

To renew the external filter element proceed as follows: Place oil tray under the filter. Unscrew the bolt in the bottom of the filter container and remove the container complete with the filter element. Remove and discard the used filter element and large rubber washer. Wash the container in kerosene. Place the new filter element in the container and reassemble the unit, using the new large rubber washer supplied with the element. Ensure that all the sealing washers are in position and intact and that the container is correctly located in the top cover.

Refill with correct grade of engine oil and run engine for five minutes, then check for leaks. Check oil level and replenish if necessary.

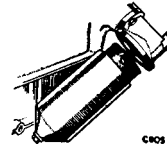

Fig. 37. Engine oil filter

Engine Breather Filters

83. The oil-wetted gauze filters fitted to the top rocker cover breather and oil filler pipe cap should be cleaned at regular intervals in the following manner:—

Remove the filters and wash the gauze thoroughly by swilling in kerosene. Re-wet the gauzes by dipping in clean engine oil and shake off the surplus; replace the top rocker cover breather (B) with the slot facing the front of the vehicle and the oil filler pipe cap (A) with the slot facing the rear. See Fig. 38.

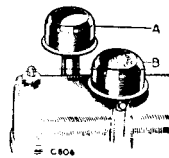

Fig. 38. Engine breather filters,
40 amp models
A—Oil filler cap.
B—Rocker cover breather.

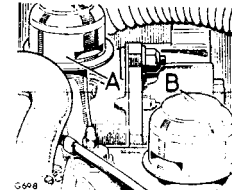

Fig. 38A. Engine breather filters,
90 amp models
A—Oil filler cap.
B—Rocker cover breather.

41

Checks

84. The following checks should be made:—

- (1) Check the engine sump for oil leaks and the securing bolts for tightness.
- (2) Check the front cover for oil leaks and the securing bolts for tightness.
- (3) Check the rocker covers for oil leaks and the securing cap bolts for tightness.
- (4) Check for leaks at the banjo bolts and the oil pipe cylinder head to cylinder block at the rear of the engine. Check the bolts for tightness.

NOTE.—After the bolts have been checked for tightness any leaks from the joints mentioned in para. 84 (1)—(4) must be reported.

(5) *(To be carried out by a vehicle mechanic)*

Ensure that the clamps securing the exhaust manifold are tight and correctly positioned. Also check the nuts securing the front exhaust pipe to the manifold, the front exhaust pipe to the intermediate exhaust pipe (in front of the rear left-hand wheel) and the intermediate exhaust pipe to the silencer. Check the exhaust pipe mountings to the chassis side members (in front of the rear axle and behind the rear right-hand wheel).

(6) *(To be carried out by a vehicle mechanic)*

Check the nuts securing the inlet manifold for tightness. Also check the two nuts securing the carburetter to the manifold for tightness.

(7) Inspect the front engine mountings. The rubber bushes should be free from oil or grease and the mounting bolts tight.

(8) Check the oil filter adaptor for leaks, and the securing bolts for tightness. The joint washer should be renewed if necessary. Ensure that the bolt at the bottom of the filter container is tight and that there is no oil leak at the gasket (Fig. 37).

(9) Check the tension of the fan and generator belts and adjust if necessary. See para. 96.

(10) Ensure that the engine sump drain plug is tight.

(11) *(To be carried out by a vehicle mechanic)*

Check cylinder head bolts for tightness.

Proceed as follows:—

- (a) Remove the bonnet.
- (b) Remove air cleaner connection hose.
- (c) Disconnect the screened leads from the sparking plugs.

(d) Remove the top rocker cover.

(e) Tighten the cylinder head nuts in the order shown in Fig. 44. For tightening torque, see para. 90.

(f) Reverse the removal procedure, renewing the rocker cover joint washer if there is any sign of deterioration. Carry out ignition timing. See Chapter 13.

Engine Oil Cooler

85. The oil cooler radiator is inserted in the engine oil system and mounted just in front of the engine coolant radiator, see para. 65; a gauge on the dash panel gives continuous indication of the oil temperature.

The oil temperature should never exceed 90°C., and the engine must be switched off and the oil allowed to cool down if this temperature is reached under working conditions.

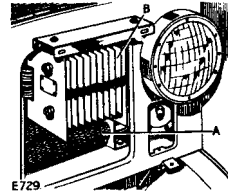

Fig. 39. Engine oil cooler

A—Engine oil cooler. B—Rectifier (40A generator vehicles only).

Checks

86. The following checks should be made:—

- (1) Check all pipe connections for oil leaks at oil cooler, engine oil sump, oil filter adaptor and thermometer pocket.
- (2) Check all connections for tightness.
- (3) Check fan belt for tension. See para. 96.

ENGINE TIMING

Routine Adjustments and Servicing Flywheel Markings

87. Ignition and valve timing is based on markings on the engine flywheel which are visible, adjacent to a pointer, under the inspection cover on the right-hand side of the flywheel housing.

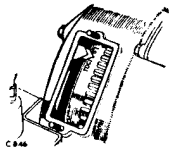

Fig. 40. Flywheel markings

The markings and their meanings are as follows:—

- (1) The line against which the letters T.D.C. are stamped, when brought opposite the pointer, indicates that No. 1 (front) piston is at top dead centre, i.e. at the top of its stroke.
- (2) The line against which the letters T.D.C. are stamped is also used for ignition timing, that is the position at which the distributor points should be just opening with the rotor in the firing position on No. 1 cylinder. For ignition timing details see page 13.
- (3) The line against which the letters E.P. are stamped, when set opposite the pointer, indicates the point at which No. 1 exhaust valve should be at the peak of its lift (fully open) 95° before T.D.C.

To Fit New Timing Chain. (To be carried out by a vehicle mechanic)

88. Proceed as follows:—

- (1) Drain and remove radiator.
- (2) Remove fan and generator belts.
- (3) Remove crankshaft damper.
- (4) Remove timing chain cover complete with water pump.
- (5) Remove timing chain and tensioner.
- (6) Remove top rocker cover.
- (7) Rotate the camshaft until the dwell of the cam serving the exhaust valve for No. 1 cylinder is nearest the tappet and set the tappet clearance to .010 in. (0.25 mm).
- (8) Fit a dial test indicator so that the "fully open" position of the valve can be ascertained in the following manner:—

44

- (9) The use of a dial indicator is the only reliable method of determining this point. It should be mounted on a stud adjacent to No. 1 exhaust rocker and with its aid the possibility of an error in determining the exhaust peak is eliminated. It is possible to do the job correctly without a dial indicator, but much time is wasted and the possibilities of an error very much magnified.

- (10) Turn the camshaft in direction of rotation until the lobe of cam has nearly opened the valve fully, then stop turning and mark the chainwheel and timing casing to record the position.

- (11) Note the reading on dial test indicator, then continue to turn the chainwheel slowly in direction of rotation until the needle has again reached the same position.

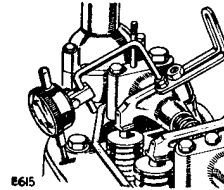

Fig. 41. Checking No. 1 exhaust valve "fully open" position

- (12) Mark the chainwheel at a point opposite to the mark on timing casing and make a third mark on the chainwheel, exactly between those made previously.

- (13) Turn the camshaft **against** direction of rotation until the third mark is in line with that on timing casing, whereon the valve should be fully open.

- (14) Fit the timing chain with "**no slack**" on the driving side. It may be necessary to remove and re-position the camshaft chainwheel to obtain this "no slack" condition on the driving side when the flywheel and camshaft are correctly positioned.

- (15) Fit the compression spring over piston, locate the cylinder assembly, compress the spring and hold in compressed position.

45

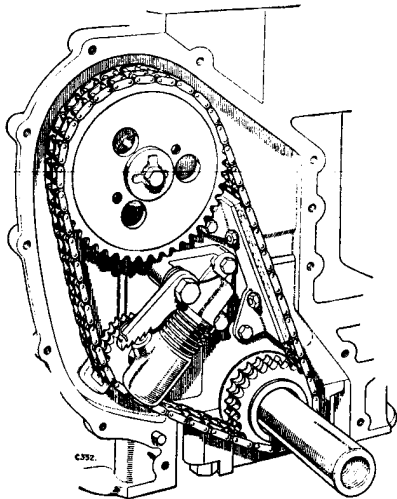

Fig. 42. Timing gear arrangement

Place the idler wheel on piston spindle and offer the assembly to the cylinder block, locating by means of the dowels. Also ensure that the spigot for the idler wheel spindle on the piston is correctly located in the slot in the cylinder block. Screw the stepped bolt with ratchet and spring in position into cylinder block, then finally secure with set bolt and nut. Release the spring and allow the idler wheel to take up the chain slack.

- (16) Turn the flywheel **against** direction of rotation approx. 90° then slowly **in** direction of rotation, checking that the exhaust valve reaches the "fully open" position, as indicated by the dial test indicator, exactly when the "E.P." mark on the flywheel is in line with the pointer on flywheel housing.
- (17) Adjust if necessary by means of the six irregularly spaced keyways in the timing chainwheel. This arrangement allows a variation of 2° between each position.

Tappet Adjustment. (To be carried out by a vehicle mechanic)

89. It is most important that tappet clearances be maintained at the correct figure and adjustment is therefore provided on each valve rocker. If anything less than the correct clearance is used, a fall in power output will follow, while greater clearance will mean noisy tappets.

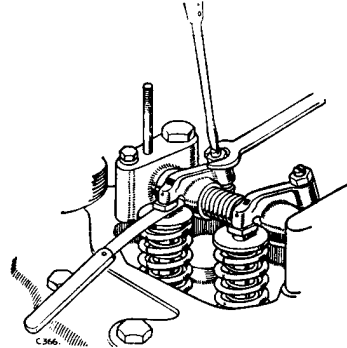

Fig. 43. Tappet adjustment

The correct clearance is 0.010 in. (0.25 mm) for both inlet and exhaust valves, with the engine either cold or at running temperature. The cylinder firing order is 1, 3, 4, 2.

To carry out tappet adjustment, proceed as follows:—

- (1) Remove the top rocker cover.
- (2) Turn the engine with the starting handle in the running direction until the valve receiving attention is fully open and then rotate the engine one complete turn, to bring the tappet on to the back of the cam.
- (3) Check the tappet clearance with a feeler gauge. If adjustment is required, slacken the locknut and rotate the tappet adjusting screw until the clearance is correct; re-tighten the locknut, holding the adjusting screw to prevent it turning. Recheck the clearance to ensure that it is still correct.
- (4) Repeat for the other valves in turn.

DECARBONIZING

90. (To be carried out by a vehicle mechanic)

The following procedure should be carried out when decarbonizing.

Cylinder Head, to remove

Joint face "flat" type gasket.

Copper and asbestos. Normal thickness .037 in. Compressed thickness .032 in.

Tightening torque for securing bolts. $\frac{1}{2}$ in. U.N.F. 65 lb. ft. (8,9 kg.m). $\frac{5}{8}$ in. U.N.F. 12 lb. ft. (1,6-1,7 kg.m). Engine hot for final check.

- (1) Remove the filler cap and open the tap at base of radiator and drain the coolant from this point only.
- (2) Remove spare wheel and lift bonnet panel clear.
- (3) Remove the air cleaner and carburetter air intake pipe complete.
- (4) Disconnect: throttle return spring linkage, at a ball joint; mixture control cable, at clamp-bolt; hand throttle control at ball joint.
- (5) Disconnect plug leads, oil feed pipe to head and petrol pipe to carburetter.
- (6) Remove sparking plugs. Disconnect distributor cap and remove thermostat from left-hand of cylinder head.
- (7) Disconnect the top water hose at radiator, and thermostat by-pass hose.
- (8) Remove generator adjusting strut eye bolt, unscrew locking nut and slide adjusting bolt clear of the cylinder head.
- (9) Remove exhaust manifold head shield and securing nuts for exhaust down pipe.
- (10) Unscrew the dome nuts securing rocker cover and lift the cover clear.
- (11) Remove the rocker pedestal securing bolts, then pressing the extreme end pedestals towards the centre of the rocker shaft, lift the complete assembly clear.
- (12) Withdraw the push-rods, but ensure that they are retained in the correct order for refitment.
- (13) Slacken the cylinder head bolts evenly, then remove them completely and lift the head clear.

48

Amdt. No. 4

- (14) Remove the carburetter, inlet and exhaust manifolds.

To Remove Inlet and Exhaust Valves

- (15) Using a valve spring compressing tool, remove the valves, valve springs and retaining collets.

Position each valve with its springs and collets together and chalk mark the bench to ensure refitment to the guide from which they were removed. Inner and outer valve springs are a selected interference fit and must not be interchanged.

Decarbonizing

- (16) Remove the carbon from the cylinder head, face and ports and then from the piston crown, using a blunt scraper.
- (17) Examine the valves and valve guides for wear and renew as necessary. The guides may be drifted out and new ones fitted.

Valve Grinding

- (18) Reface the valves to 45°— $\frac{1}{4}$ exhaust, and 30°— $\frac{1}{4}$ inlet, then lap them into their seats. Re-cut valve seats only when necessary and then remove the minimum amount of metal.
- (19) Wash the valve seats and ports thoroughly with kerosene and wipe down with a smooth rag. Fit a new rubber seal to each guide.
- (20) Refit the valves, springs and collets, then pour kerosene into each port and check for tightness.

Re-assembling

- (21) Reverse the removal procedure.
- (22) Renew all joint washers.

The cylinder head gasket must be correctly fitted with the lettering "Petrol 520039" facing the cylinder head, jointing compound must not be used.

- (23) Tighten down the cylinder head bolts in the order indicated in Fig. 44. The $\frac{1}{2}$ in. U.N.F. bolts including those that secure the rocker shaft brackets must be pulled down to 65 lb. ft. (8,9 kg.m), $\frac{5}{8}$ in. U.N.F. bolts should be tightened to 12 lb. ft. (1,6 kg.m). Engine hot for final check.

49

Amdt. No. 4

Damage to the tappet slides can be caused after refitting the cylinder head and rocker assembly to the cylinder block by rotating the engine before any tappet adjustment is carried out. Excessive tappet clearance at this stage of assembly can allow the push rods to be lifted out of the spherical seat and on to the top of the tappet slide. Further rotation of the engine will then cause the push rod to damage the tappet as the rocker fully compresses the valve spring. It is therefore important that excessive tappet clearance is eliminated as follows:—

- (a) Before rotating the engine, or the camshaft after a complete strip-down, adjust all the tappets which are slack.
- (b) Then rotate engine or camshaft a quarter of a turn at a time. After each movement of the camshaft adjust any tappets which are slack.
- (c) When the excessive clearance on all the tappets has been eliminated finally adjust the tappets in the normal manner to the correct clearance.

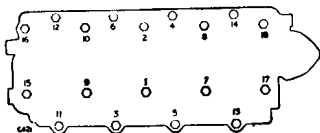

Fig. 44. Order of tightening cylinder head bolts

$\frac{1}{2}$ in. bolts to 65 lb. ft. (8,9 kg.m).
 $\frac{3}{8}$ in. bolts to 12 lb. ft. (1,6 kg.m).

- (24) Carry out ignition timing, static full retard T.D.C. See Para. 219.
- (25) Adjust the tappet clearances to .010 in. (0,25 mm). See para. 89.
- (26) Adjust generator belt, para. 96.
- (27) Run the engine for a few minutes and check for leaks.
- (28) Finally check the tightening torque of the cylinder head bolts with the engine hot.

CHAPTER 2 THE COOLING SYSTEM

Description

91. Coolant enters the pump through a pipe from the bottom of the radiator, and is then forced down into the cylinder block.

50

The coolant circulates round the cylinder jackets in the block, from where it rises to the cylinder head. After circulation round the valve ports in the cylinder head casting, the greater part of the coolant passes to the front of the head and so into the thermostat housing. If the thermostat is open, it returns through the top hose to the radiator.

On vehicles with a 40A generator there are two "V" type fan belts driven from the crankshaft pulley, one driving the generator, the other driving the water pump and fan via a jockey pulley. See para. 96.

On vehicles with a 90A generator there are three "V" type belts driven from the crankshaft pulley, two driving the generator, the other driving a water pump and fan.

Radiator Filler

92. Access to the radiator filler is gained by lifting the bonnet panel.

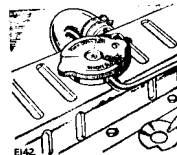

Fig. 45. Radiator filler

The cooling system is pressurised and *great care must be taken when removing the radiator filler cap*, especially when the engine is hot, to avoid steam which may be blown out with considerable force.

When removing the filler cap, first turn it anti-clockwise to the stop and allow all pressure to escape, before pressing it down and turning further in the same direction to lift it off.

When replacing the filler cap it is important that it is tightened down fully, not just to the first stop. Failure to tighten the filler cap properly may result in water boiling away rapidly, with possible damage to the engine through overheating.

The correct coolant level is one inch below the bottom of the filler neck; the total capacity of the system is 17½ Imperial pints (10 litres).

The radiator incorporates an overflow pipe, fitted with a valve, from the filler neck which serves as a steam escape and air inlet for the sealed filler cap; it also prevents over-filling of the system.

NOTE.—Use soft water wherever possible; if the local water supply is hard, rain or distilled water should be used.

Coolant Pump

93. The impeller type coolant pump is mounted on the front of the cylinder block and is belt driven. See para. 91.

51

Thermostat

94. The bellows type thermostat is fitted above the coolant pump casing. Its purpose is to provide rapid warming up by causing the coolant to circulate only round the engine until a pre-determined temperature is reached, when it opens to allow full circulation through the radiator. The unit operates at 162°-191°F. (72°-88°C.).

Checks

95. Check the following points (see para. 65):—

- (1) Examine the hose connections, which should be free from cracks or signs of peffishing. Tighten the hose clips as necessary.
- (2) Examine the cylinder block core plugs for signs of leaks. Renew if necessary.
- (3) Check the following connections for signs of leakage. Inlet manifold to outlet pipe; inlet elbow to thermostat; inlet pipe to coolant pump.
- (4) Check connection between coolant pump and thermostat housing. Check coolant pump and thermostat housing for signs of leakage.
- (5) Check that the radiator drain tap and cylinder block drain tap are fully closed. See para. 97, Fig. 48.
- (6) Ensure that the bolts securing the radiator block to the grille panel are tight.
- (7) Check that the bolts and nuts securing the fan to the fan pulley are tight.
- (8) Check that the bolts securing the coolant pump and the thermostat housing to the cylinder block are tight.
- (9) Check the fan belt tension and adjust if necessary. See para. 96.
- (10) Check that the radiator block is not damaged.

Routine Adjustments and Servicing

Fan and Generator Belt Adjustment. (To be carried out by a vehicle mechanic)

96. As the fan belts are of the "V" type, the drive is on the sides of the belts and it is not therefore necessary to adjust them tightly and so put an excessive load on the coolant pump and generator bearings; the tension is correct when the belts can be depressed as follows:—

Fan belt $\frac{1}{8}$ to $\frac{1}{2}$ in. (9 to 12 mm).

52

Amdt. No. 1

Generator belt (or belts) $\frac{1}{4}$ to $\frac{1}{2}$ in. (12 to 19 mm).
by thumb pressure between the two pulleys.

(1) Fan belt adjustment (coolant pump)

Fan belt adjustment is by means of a jockey pulley situated on the left-hand side of the engine. See Fig. 46. To adjust:

- (a) Slacken the jockey pulley fixing bolt.
- (b) Slacken the adjustment nut.
- (c) Pivot the jockey pulley inwards or outwards until the correct tension is obtained.
- (d) Tighten the jockey pulley fixing bolt and adjustment nut.

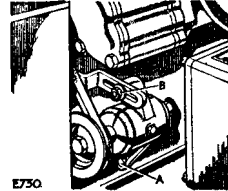

Fig. 46. Fan belt adjustment (coolant pump)

A—Jockey pulley fixing bolt. B—Jockey pulley adjustment nut.

(2) Generator belt adjustment.

Generator belt adjustment is by means of an adjustment strut at the top of the generator. See Fig. 47 and 47A. To adjust:

- (a) Slacken the two generator pivot bolts.
- (b) Unscrew the outer nut on the generator adjustment strut.
- (c) Adjust by screwing or unscrewing the inner nut until the correct tension has been obtained.

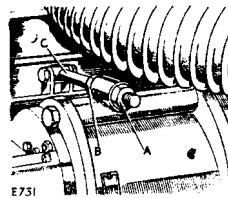

Fig. 47. Generator belt adjustment, 40 amp models

A—Outer nut on adjusting strut. B—Inner nut on adjusting strut.
C—Adjusting strut.

53

Amdt. No. 4 and 5

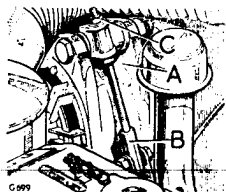

Fig. 47A. Generator belt adjustment, 90 amp models
A—Generator. B—Adjustment strut. C—Outer nut on adjustment strut.

(d) 90 amp models only. A steady pulley is fitted to the generator belts to prevent twist at fluctuating engine speeds. See Fig. 47b. It is important that the steady pulley is not used for generator belt adjustment otherwise premature bearing wear will occur. If at any time new generator belts are fitted, the steady pulley should be set so that the belts are inside the grooves on the pulley. Then position the unit so that the pulley can just be turned by hand, but does not distort the belts in any way.

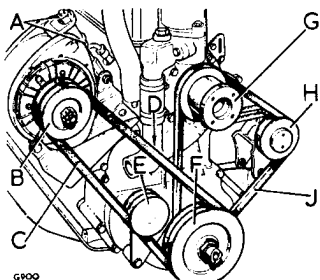

Fig. 47B. Generator and fan belt layout, 90 amp models

- A—Nuts for generator belt adjustment.
- B—Pulley for generator, twin groove.
- C—Belts for generator.
- D—Check belt free movement at this point.
- E—Steady pulley for generator belts, twin groove.
- F—Crankshaft pulley, three groove.
- G—Pulley for water pump, single groove.
- H—Pulley for jockey pulley, single groove.
- J—Belt for fan.

- (e) The generator and fan belt layout on 40 amp models is similar to that used on 90 amp models but there is a single belt drive to the generator and no steady pulley.

Draining and Flushing the Cooling System

97. As a precaution against corrosion, the cooling system should be drained and flushed out at least twice each year in the following manner:—

NOTE.—The cooling system is pressurised and great care must be taken when removing the radiator filler cap, especially when the engine is hot, to avoid steam which may be blown out with considerable force. When removing the filler cap, first turn it anti-clockwise to the stop and allow all pressure to escape, before pressing it down and turning further in the same direction to lift it off.

- (1) Remove the radiator filler cap.
- (2) Open the coolant drain taps at the bottom of the radiator and on the right-hand side of the cylinder block at the rear.
- (3) When the coolant flow has ceased, insert a piece of wire in each tap, to make sure that a blockage has not been caused by rust or scale.
- (4) Place a hose in the radiator filler neck and adjust the flow of water to equal that draining from the taps.

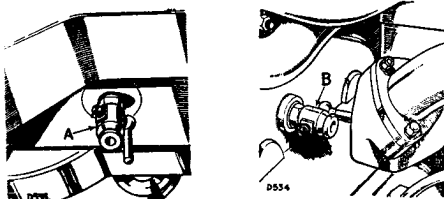

Fig. 48. Drain taps
A—Radiator drain tap. B—Cylinder block drain tap.

- (5) Run the engine for a short time to ensure thorough cleaning of the whole system.
- (6) Switch off the engine, remove the hose and close the taps. Refill the system with clean coolant to the bottom of the filler neck and replace the filler cap. The total capacity is 17½ Imperial pints (10.0 litres).

NOTE.—Use soft water wherever possible; if the local water supply is hard, rain or distilled water should be used.

- (7) Run the engine until working temperature is reached and top up the coolant level as necessary.

54

CHAPTER 3 FUEL SYSTEM

98. The fuel system comprises two tanks, pipe lines, sediment bowl, pump, carburetter and air cleaner.

It is most important that the entire system be kept clean and free from leaks.

FUEL TANKS

Description.

99. Twin fuel tanks are fitted, they are both located under the seat box.

The fuel filler caps are located beneath the locker lids on each side of the seat box, accessible after the seat cushions are removed. When the cap is removed, a telescopic tube may be drawn out of the tank neck and locked by a slight anti-clockwise movement, to facilitate filling. Each tank capacity is 10 Imperial gallons (45 litres.)

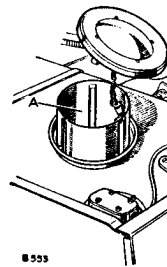

Fig. 49. Fuel filler, twin fuel tanks

Checks

100. The following points on the fuel tank should be checked:—

- (1) Check that the bolts securing the tanks to the chassis brackets are tight.
- (2) Check that the drain plugs are tight.
- (3) Check that the gauge electrical lead fitted to each fuel tank is secure.
- (4) Ensure that the vent hole in each filler cap is clear

55

FUEL PUMP AND FILTER

Description

101. The mechanically operated fuel pump with hand primer, located on the right-hand side of the engine, is actuated by a lobe on the camshaft. The sediment bowl is attached to the pump.

Checks

102. The following points should be checked on the pump:—

- (1) Check the inlet and outlet union for signs of leakage and tighten if necessary.
- (2) Check for tightness the screws securing the two halves of the pump together, and the bolts securing the pump to the engine.
- (3) Check for signs of a leak from the diaphragm, replace if necessary.

Routine Adjustments and Servicing

Clean filter sediment bowl (*To be carried out by a vehicle mechanic*)

103. Should the filter become choked or if an appreciable amount of foreign matter has collected in the bowl the unit should be cleaned as follows:—

- (a) Remove the bowl by slackening the thumb screw and swinging the retainer aside.
- (b) Remove and clean filter gauze in gasoline.
- (c) Ensure that the sealing washer is in good condition.
- (d) Replace gauze and refit bowl.
- (e) Prime by operating hand lever.

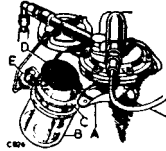

Fig. 50. Fuel pump and sediment bowl

A—Hand priming lever. B—Sediment bowl. C—Sealing washer.
D—Gauze filter. E—Retainer.

Fuel Pump Fault Location

104. If fuel pump trouble is suspected:—

(1) Disconnect the fuel pipe from the carburetter and check that fuel is delivered to the carburetter when the hand lever on the fuel pump is operated. If fuel is not delivered from the pipe:—

(i) Check that the fuel pipes and filters are clear.

(ii) Check that there are no air leaks in the suction line to the fuel pump.

(iii) Check that the diaphragm is not leaking and that the retaining screws are tight.

Failure to locate and rectify the fault in this manner will indicate that the pump itself is at fault and it should receive workshop attention.

AIR CLEANER

Description

105. The AC oil-bath type air cleaner is mounted on a carrier bracket over the right-hand chassis sidemember, to which it is secured by means of a clamping strap.

An integral centrifugal pre-cleaner separates out the coarser particles of foreign matter. The air passes down a large diameter tube in the centre of the cleaner, at the bottom of which a sharp reversal of direction takes place, thus depositing the majority of the dust into the oil reservoir in the detachable tray forming the bottom of the cleaner. It then passes up through the woven steel packing, where the remaining particles are extracted.

Checks

106. Check the air cleaner as follows:—

(1) Check the tightness of the wing nut securing the air cleaner.

(2) Inspect oil in bowl. See para. 107.

(3) Examine the hose connection. Tighten the clip if necessary.

Routine Adjustments and Servicing

Air Cleaner, Change Oil and Clean Bowl

107. Attention to the air cleaner is extremely important, especially under dusty conditions, as engine wear generally will be seriously affected if the vehicle is run with an excessive amount of sludge in the cleaner oil bath.

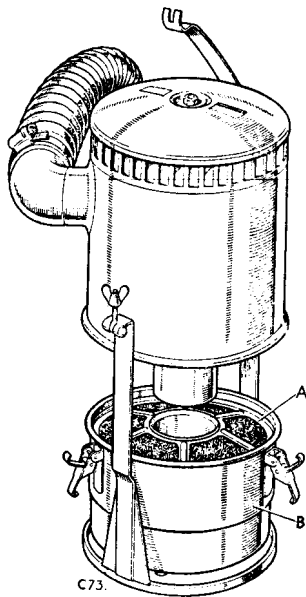

Fig. 51. Air cleaner
A—Oil bowl. B—Oil level mark.

Under clean road or stationary conditions, the cleaner oil bath should be cleaned and refilled periodically. In cases where the vehicle is operated under dusty road or field conditions, attention must be more frequent, even to the extent of a daily oil change; under extremely bad conditions, cleaning twice daily may be called for.

Proceed as follows:—

- (1) Release the clamping strap securing the air cleaner, disconnect the outlet elbow from the carburetter intake pipe by slackening the clip and remove the cleaner from the vehicle.

58

- (2) Remove the oil bowl from the bottom of the cleaner by releasing the three securing clips.
- (3) Clean all dirty oil and sludge from the bowl and refill with fresh engine oil to the level indicated by a ring formed in the pressing; the capacity is approximately $1\frac{1}{2}$ Imperial pints (0,85 litre).
- (4) Clean the filter in the cleaner body by swilling the complete body in kerosene and shake off the surplus.
- (5) Replace the bowl.
- (6) Refit the complete unit in the vehicle.

CARBURETTER

Description

108. Solex carburetter, type 40 P.A. 10-5. No adjustment is normally required to the carburetter, and the only manual setting provided is that to obtain smooth engine idling.

A gauze filter is provided in the inlet banjo union, and this should be removed and cleaned periodically. See Fig. 52.

"Econostat"

109. This gives a weaker cruising range mixture and improves the accuracy of metering under full throttle conditions. At the same time, it is non-mechanical in operation, avoiding valves, diaphragms, or other moving parts.

Progressive Fast Idler

110. The progressive fast idler is bolted to the carburetter, it is operated by the Cold start control and ensures easy and certain starting from cold.

The Accelerator Pump

111. An accelerator pump is incorporated in the carburetter to eliminate a weak mixture flat spot occurring during rapid throttle opening by injecting fuel into the engine during the change-over from slow running to cruising conditions.

Lubrication

112. The throttle linkage should be lubricated by means of an oil-can at the following points:—

- (1) Accelerator pedal shaft at points of contact with brackets.
- (2) The ball joints on the rods from pedal shaft to relay shaft, and from relay shaft to carburetter.

59

- (3) Relay shaft at points of contact with bracket.
- (4) Carburetter bell-crank and spindle, on inlet manifold.

Checks

113. The following points should be checked on the carburetter:
- (1) A general examination of the carburetter and pipe lines should be made for fuel leaks, for tightness of the unions and securing bolts. Renew joint washers if necessary.
 - (2) Examine the cold start control cable for any damage that would prevent the control from fully closing the cold start control lever.
 - (3) Check the accelerator and hand throttle linkage for damaged or weak return springs and the throttle restriction mechanism on 8/2 vehicles.
 - (4) Examine ball joints for excessive wear and ensure that the levers are secure on the shafts.
 - (5) Check that the spring on the accelerator pump control rod is not broken or weak.
 - (6) Check hose connection on carburetter intake. Tighten if necessary.

Routine Adjustments and Servicing

114. The carburetter is adjusted on assembly and, apart from occasional cleaning of the filter, should require no further attention. The only normal adjustment provided is that to obtain smooth engine idling.

Cleaning Carburetter Filter. (To be carried out by a vehicle mechanic)

115. When necessary, disconnect the fuel pipe from the carburetter and withdraw the gauze filter from the float chamber cover. Clean the filter in gasoline, using a stiff brush.

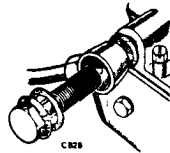

Fig. 52. Carburetter filter

60

Carburetter Slow-running Adjustment. (To be carried out by a vehicle mechanic)

116. It may occasionally become necessary to adjust the slow-running qualities of the carburetter, in which case proceed as follows:—

- (1) Run the engine until hot—never set the idling with a cold engine.
- (2) Set the slow-running screw until the idling speed is rather high.
- (3) Slacken the volume screw until the engine begins to hunt.
- (4) Screw it in very gradually until the hunting just disappears.
- (5) If the engine speed is too high, reset the slow-running screw to slow it down to an idling speed of not more than 500 r.p.m.
- (6) This may cause a resumption of slight hunting. If so, turn the volume control screw gently in a clockwise direction until the idling is once more satisfactory.

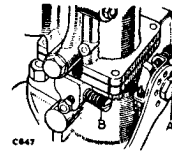

Fig. 53. Carburetter adjustment

A—Slow-running screw B—Volume screw

Cleaning Carburetter Jets. (To be carried out by a vehicle mechanic)

117. For jet sizes see page 14, Data—Fuel System.

When trouble is experienced with blocked jets, the following notes will assist in location of the jets which need cleaning:—

- (1) Main jet: the jet proper is screwed into the inner end of the carrier, which must be removed to gain access to the jet.
- (2) Pilot jet has a screwdriver slot in the hexagon head.
- (3) Accelerator pump jet is located above the starter jet.
- (4) Starter jet is a plain hexagon-headed unit at the rear of the carburetter.
- (5) Under no circumstances should wire be used for cleaning jets. Use compressed air or a hand pump.

61

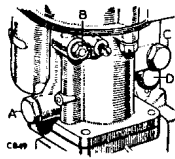

Fig. 54. Carburettor jets

A—Main jet. B—Pilot jet. C—Accelerator jet. D—Starter jet.

Accelerator Pump Operating Rod. (To be carried out by a vehicle mechanic)

118. To adjust:—

- (1) Remove the split pin behind the spring and allow the spring to move back along the rod.
- (2) Slacken the slow-running screw right off.
- (3) With the throttle fully closed and the operating lever just about to operate the pump diaphragm, add washer or washers on the end of the rod up to the nearest split pin hole, ensuring that there remains a 0.020 in. (0.5 mm) clearance between the lever and the first washer when the outer split pin is fitted. (See Fig. 55). This clearance ensures the correct travel of the pump lever.

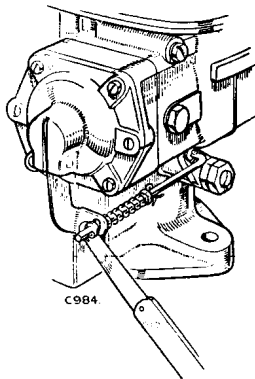

Fig. 55. Setting accelerator pump operating rod, showing .020 in. feeler gauge

- (4) Compress the spring and replace the inner split pin.
- (5) Check that the spring is not coil-bound when the throttle is fully open.

Draining the Fuel System

119. If the vehicle is to be stored for an extended period, the fuel system should be completely drained to prevent the formation of gum in the pump and carburettor. Remove the drain plug from the bottom of each fuel tank and replace when the tanks are empty; then run the engine until the fuel in the pipe-lines from each tank is exhausted.

CHAPTER 4

CLUTCH

Description

120. The Borg and Beck type clutch unit is of the single dry plate type, consisting of a driven plate and a cover assembly.

121. The 9 in. (230 mm) driven plate is of the spring type pattern, in which the splined hub is indirectly attached to a disc bearing the two lining faces through three drive and three over-drive coil springs.

122. The cover assembly consists of a pressed steel cover and a cast-iron pressure plate loaded by nine thrust springs. Mounted in the pressure plate are three operating (release) levers, which pivot on floating pins retained by eyebolts.

123. The clutch withdrawal mechanism is carried in a housing, bolted inside the bell housing to the front face of the gearbox casing. The withdrawal bearing and clutch release fork are immersed in oil from the main gearbox.

124. Pressure on the clutch release fork, spline-located on the cross-shaft protruding from an aperture in the side of the bell housing, is transmitted through the withdrawal bearing and sleeve to the operating levers, to pull the pressure plate clear of the driven plate.

Clutch Operation

125. The clutch, which is hydraulically operated, must only be used when starting the vehicle from rest or when changing gear; at all other times the foot should be kept clear of the clutch pedal to avoid unnecessary lining wear.

The hydraulic clutch system comprises a pendant foot pedal, mounted in the dash and operating a master cylinder, which in turn is connected by pipes to the slave cylinder fitted adjacent to the bell housing. The slave cylinder is connected to the clutch lever by means of an adjustable push rod.

Clutch and Brake Fluid Reservoir

126. The combined fluid reservoir for the brakes and clutch is mounted above the foot pedals on the engine side of the dash.

Check the fluid level in reservoir as follows:—

The level is correct when the fluid is just above the top of the inner reservoir; periodically remove the filler cap and replenish as necessary making sure that both clutch and brake reservoirs are topped up.

Lubrication

127. The withdrawal housing is filled with oil from the main gearbox casing and ample lubrication is thereby ensured for the thrust ball bearing; no individual lubrication attention is required for the withdrawal mechanism.

The only regular lubrication attention required for the linkage is to the relay shaft. Lubricate by means of an oil-can the following points:—

- (1) At relay shaft pins.
- (2) Adjuster rod joint pin.

Routine Adjustments and Servicing

Clutch Adjustment. (To be carried out by a vehicle mechanic)

Late models are fitted with a hydrostatic clutch, that is a clutch mechanism which is correctly set on initial assembly to give approximately $\frac{1}{8}$ in. (8 mm) free movement at the pedal pad, and which requires no adjustment throughout the life of the clutch plate. Models with the latest type clutch mechanism can be easily identified as follows:

- (a) The support bracket for clutch slave cylinder on early models encloses the cylinder; on late models the cylinder is exposed.
- (b) The operating lever on early models is straight; on late models it is cranked.
- (c) The return spring is not fitted to the operating lever on late models.

All these differences are clearly shown at Figs. 55A and 55B.

64

Amdt. No. 2

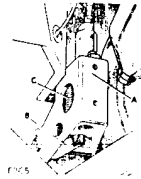

Fig. 55A

Early type clutch mechanism

- A—Enclosed slave cylinder
- B—Straight operating lever
- C—Return spring for operating lever

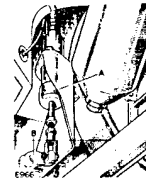

Fig. 55B

Late type clutch mechanism

- A—Exposed slave cylinder
- B—Cranked operating rod

Do not adjust the pedal free movement on models fitted with a hydrostatic clutch.

128. **Early type only.** See Fig. 55A. To ensure efficient operation of the clutch unit, there must be free movement, to the extent of $1\frac{1}{2}$ in. (38 mm) measured at the pedal pad.

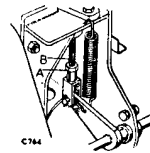

Fig. 56. Clutch adjustment, early models only

- A—Locknut for rod.
- B—Push rod.

Many drivers do not recognise the symptoms of hydraulic clutch maladjustment in time to prevent slipping and excess wear.

It should be noted that the feel of the pedal is in three stages:

- (1) Master cylinder free play against the pedal return spring.
- (2) Slave cylinder free play through the hydraulic system and against the slave cylinder return spring.
- (3) Operating the clutch against the full force of the pressure springs.

64A

Amdt. No. 2

These points must be checked from time to time. If the free movement is incorrect, adjustment must be made as follows:

Master cylinder free play to adjust. Early and late type clutch mechanism. *(To be carried out by a vehicle mechanic)*

- (1) Check the free play between the master cylinder piston and the push rod. See Fig. 57. This free play should be $\frac{1}{8}$ in. (1,5 mm) at the push rod and is felt as approximately $\frac{3}{8}$ in. (8 mm) at the pedal pad. If the movement is less than the given figure:
- (2) Slacken off the locknut and rotate the push rod with the fingers until the correct movement has been obtained.

Pedal free play to adjust. Early type only. See Fig. 55A. *(To be carried out by a vehicle mechanic)*

- (1) Slacken the push rod locknut at the slave cylinder. See Fig. 56.
- (2) Adjust the push rod by rotating until the free movement at the pedal is $1\frac{1}{4}$ in. (38 mm). The total free play is felt in two stages:
 - (a) Light movement of approximately $\frac{3}{8}$ in. (8 mm) which takes up the master cylinder free play against the pedal return spring.
 - (b) Slightly heavier movement which should be approximately $1\frac{1}{8}$ in. (30 mm) which takes up the slave cylinder free play through the hydraulic system and against the slave cylinder return spring.
- (3) When the correct movement of the pedal pad has been obtained secure the push rod with the locknut.

Bleeding the Clutch System. *(To be carried out by a vehicle mechanic)*

129. If the level of the fluid in the combined brake and clutch reservoir is allowed to fall too low or if the pipe has been disconnected, the clutch will not operate correctly due to air having been absorbed in the system. This air lock must be removed by bleeding the hydraulic system at the slave cylinder.

- (i) Attach a length of rubber tubing to the bleed nipple and place the lower end of the tube in a glass jar.
- (ii) Slacken the nipple and pump the clutch pedal, pausing at each end of each stroke, until the fluid issuing from the tube shows no sign of air bubbles when the tube is held below the surface of the fluid in the jar.

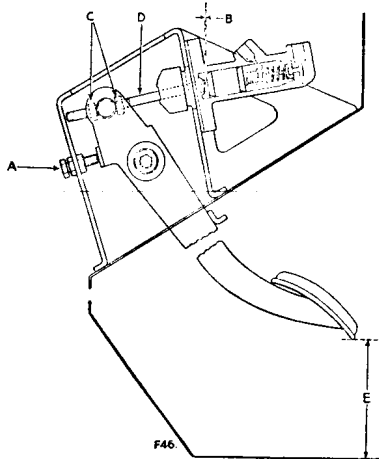

Fig. 57. Clutch linkage setting

- A—Pedal position setting bolt.
- B—Free play against master cylinder push rod $\frac{1}{8}$ in. (1.5 mm).
- C—Master cylinder push rod locknuts.
- D—Master cylinder push rod.
- E—Models with non-hydrostatic clutch mechanism $6\frac{1}{4}$ in. (158 mm)
Models with hydrostatic clutch mechanism $5\frac{1}{4}$ in. (140 mm)

} From underside of pedal pad to floor board

Adjust dimension "E" by means of bolt "A", always check master cylinder free play after adjustment has been made at this point.

(iii) Hold the tube under the fluid surface and tighten the bleed screw.

(iv) Adjust pedal movement as necessary.

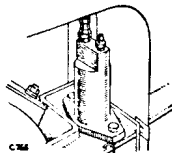

Fig. 58. Bleed nipple for clutch slave cylinder

66

Amdt. No. 2

- (v) The fluid in the reservoir should be replenished throughout the operation to prevent another air-lock being formed. Note particularly that the fluid reservoir for the clutch is the small central tube in the combined reservoir.

CHAPTER 5 GEARBOX

130. The gearbox unit comprises the main gearbox (four speeds forward and reverse), the two-speed transfer box and the output shafts to the front and rear axles.

MAIN GEARBOX

Description

131. The complete gearbox is flexibly mounted as a unit with the engine, the main gearbox being offset to the left, to allow clearance for the front axle drive. Synchromesh operates on third and top speeds, second speed is through constant mesh helical gears and first and reverse speeds through sliding spur gears. The main gear change lever, centrally mounted, is secured directly to the gearbox casing.

Lubrication

132. The main gearbox and clutch withdrawal mechanism are lubricated as one unit.

Oil Level

133. The main gearbox oil level must be checked periodically and replenished as necessary to the bottom of the oil level plug hole. This plug is accessible from under the vehicle, it can be seen when the rubber grommet on the side of the gearbox cover is removed. The filler plug is accessible through the grommet on the gearbox cover.

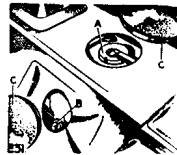

Fig. 59. Gearbox oil filler, early models;

- A—Filler cap.
- B—Oil level plug.
- C—Rubber grommet.

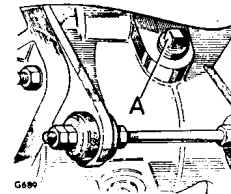

Fig. 59A. Gearbox oil filler, late models
A—Oil level/filler plug

67

Amdt. No. 5

Bell Housing Drain Plug

134. A plug is provided for fitting into a drain hole in the bottom of the flywheel bell housing to seal it against the entry of mud or water when fording. When not in use, the plug is screwed into a bracket adjacent to the housing drain hole.

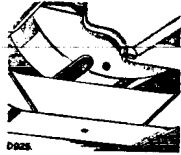

Fig. 59B. Bell housing drain plug

The plug should only be fitted into the drain hole when the vehicle is fording or travelling over very muddy terrain and it must be removed periodically to allow all oil to drain before being replaced.

Gearbox Oil Changes

135. To change the oil, remove the drain plug from the bottom of the main gearbox casing, immediately after a run when the oil is warm; allow the oil to drain away completely then replace the plug. Refill with oil of the correct grade; the capacity is approximately 2½ Imperial pints (1,5 litres).

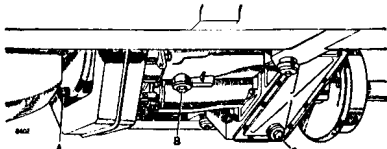

Fig. 60. Gearbox drain plugs

A—Bell housing plug. B—Gearbox plug. C—Transfer box plug.

Checks

136. Check the following points for oil leakage and mounting bolts for tightness. Tighten the bolts and nuts if necessary:—

- (1) Bell housing to flywheel housing.
- (2) Gearbox casing to bell housing.
- (3) Top cover to gearbox casing.
- (4) Gearbox drain plug.

68

Amdt. No. 4 and 5

TRANSFER GEARBOX

Description

137. The rear end of the main gearbox mainshaft extends into the transfer casing, bolted at right angles to the gearbox. From a gear on the mainshaft, the drive is through an intermediate gear cluster to high and low speed gears on the output shaft; high speed is obtained through constant mesh helical gears and low speed through a sliding spur gear. Transfer gear changing is obtained via a long selector shaft passing forwards through the front output housings to the transfer gear change lever on the right of the main lever; the transfer control is interlocked with that for the front-wheel drive.

138. The rear axle output flange is bolted to the rear of the output shaft, which passes through the speedometer drive housing; this housing also carries the mechanical transmission brake operated by the hand brake lever.

139. The forward end of the output shaft is splined into the sliding member of the front-wheel drive dog-clutch which, along with the front output shaft, is enclosed in a long housing on the front of the transfer casing. This housing carries the front bearing for the front output shaft, which is located at its rear end on a phosphor bronze bush running on an extension of the transfer box output shaft.

Lubrication

140. The transfer box and front-wheel drive housing are lubricated as one unit.

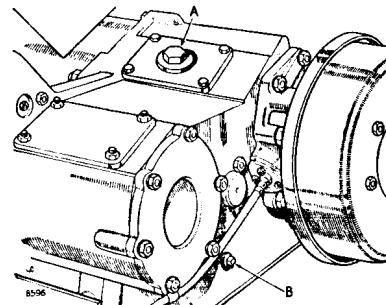

Fig. 61. Transfer box lubrication
A—Filler plug. B—Level plug.

69

Oil Level

141. The transfer box oil level must be checked periodically and replenished as necessary until oil commences to flow from the level plug hole. The level plug is in the rear face of the transfer box and the filler plug on the cover plate on top of the box on the right-hand side (see Fig. 61); both are accessible when the seat box centre panel is removed.

Transfer Box Oil Changes

142. To change the oil, remove the drain plug (see Fig. 60) from the bottom of the transfer box immediately after a run when the oil is warm; allow the oil to drain away completely, replace the drain plug, then remove the filler and level plugs. Refill with oil of the correct grade; the capacity is $4\frac{1}{2}$ Imperial pints (2,5 litres).

Checks

143. Check the following points for oil leakage and mountings for tightness. Tighten bolts and nuts as necessary and report if leakage persists.

- (1) Bottom cover plate to transfer casing.
- (2) Transfer casing to main gearbox casing.
- (3) Rear mainshaft bearing housing to transfer casing.
- (4) Front output shaft housing to transfer casing.
- (5) Speedometer pinion housing to transfer casing.
- (6) Transfer box drain plug.
- (7) Transfer box oil level plug.

Check front and rear output shafts for sign of leakage. Check the rear engine mountings, situated on either side of transfer box. They should be free from oil or grease and the mounting bolts tight.

CHAPTER 6 PROPELLER SHAFTS

Description

144. The two propeller shafts, of Hardy Spicer manufacture, are identical in design. To accommodate fore and aft movement of the axles and the float of the engine and gearbox unit, one end of each shaft is provided with a splined sliding joint. Each universal joint consists of a centre spider, four needle roller bearing assemblies and two yokes.

Lubrication

145. At regular intervals apply oil, using the oil gun, at the lubrication nipple on the sliding portion of the propeller shafts.

Apply oil at the lubrication nipples fitted to the universal joints. It is preferable to use the oil gun, but if high pressure equipment is used, care must be taken not to damage the seals in the joints.

A rubber grommet is fitted over the sliding spline, to prevent ingress of dirt and water. This does not affect lubrication in any way.

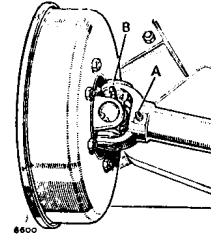

Fig. 62. Propeller shaft lubrication
A—Sliding sleeve nipple. B—Universal joint nipple.

Checks. (To be carried out by a vehicle mechanic)

146. The following points should be checked:—

- (1) Periodically check the security of the propeller shaft securing bolts and rectify as necessary.
- (2) Check the bearing races and spider journals for excessive wear.

Wear on the thrust faces of the bearings can be located by testing the lift in the joint, either by hand or with the aid of a bar suitably pivoted.

Any circumferential movement of the shaft relative to the flange yokes indicate wear in the roller bearings or the splined joint.

- (3) Check the universal joint bearings for oil leaks.
- (4) Check that rubber grommet on prop-shaft spline is not damaged and is securely fastened.

CHAPTER 7
REAR AXLE, FULLY FLOATING

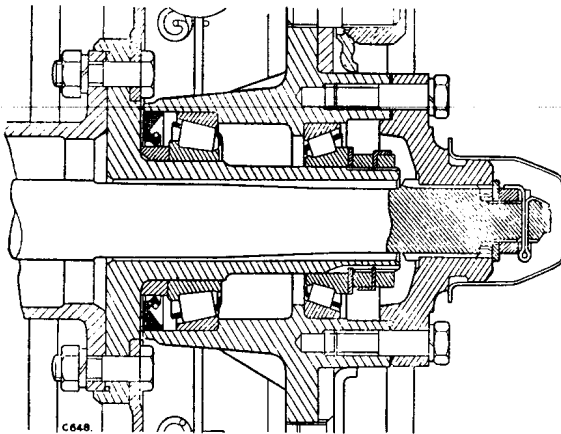

Fig. 63. Cross section of fully-floating rear hub

Description

147. The rear hub is based on the hub arrangement used on the front axle, and many of the parts are interchangeable between front and rear axles. The unit comprises rear hub bearing sleeves bolted to the existing rear axle casing, with the rear hubs fitted to these sleeves and retained by a key washer, special nuts and lockers in exactly the same way as the front hub.

The one-piece axle shafts are splined into the differential wheels at the inner end with hub driving members fitted to splines at the outer end. The hub driving members are bolted to the rear hubs and secured to the axle shafts by means of washers, nuts and split pins.

Rear axles, fitted with strengthened differential units and axle shafts, are identified by a brass or aluminium plate attached to the pinion seal housing, embossed with a part number. See Fig. 64 and also NOTES TO READERS on page xiii.

72

Amdt. No. 3 and 4

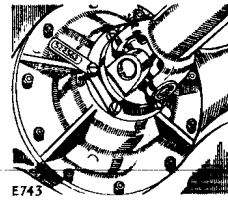

Fig. 64. Identification of strengthened differential units and axle shafts

Lubrication

Differential Oil Level

148. The differential oil level must be checked periodically, immediately after a run when the oil is warm, and replenished as necessary to the bottom of the filler plug hole. The level/filler plug is on the right-hand side of the differential casing. (See Fig. 65).

Differential Oil Changes

149. Immediately after a run, when the oil is warm, drain off the oil by removing the drain plug(s) in the bottom of the axle casing(s). Replace the drain plug(s) and refill with oil of the correct grade; the capacity of each differential is approximately 3 Imperial pints (1.75 litres).

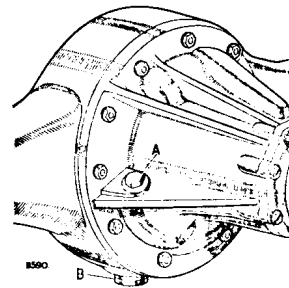

Fig. 65. Rear differential lubrication
A—Filler level plug. B—Drain plug.

73

Checks

150. Check the following:—

- (1) Check that the nuts securing the bevel pinion housing to the axle casing are tight and that there is no oil leak at this point.
- (2) Check that the bevel pinion and hub oil seals do not leak.
- (3) Check that the oil level and drain plugs are tight.

Routine Adjustments and Servicing
Fully-floating rear axle

Hub Adjustment. (To be carried out by a vehicle mechanic)

151. The adjusting procedure for the rear hub is exactly as that on the front hub. Page 77, Paragraph 66 covers the procedure to be carried out except that items 2 and 10 are not applicable. See Fig. 70.

CHAPTER 8
FRONT AXLE

Description

152. The front axle is a live driving unit of the "fully-floating" type, the drive being transmitted through spiral bevel gearing and normal type differential to the half shafts and thence via universal joints to the wheel hubs.

153. The inner end of each half shaft is splined into the differential assembly, while the outer end is carried in a taper roller bearing enclosed in a spherical housing secured to the axle casing.

154. The lower swivel pin is mounted in a taper roller bearing carried in a spherical housing, while the upper pin is carried in a spring-loaded cone to provide additional steering damping.

155. Vehicles on Contracts prefixed with the letters 'WV' have railko bush type steering damping.

156. The spherical and swivel pin housing (known together as the universal joint housing) enclose the universal joint.

157. The driving shaft is carried in a bush pressed into the hollow stub axle bolted to the swivel pin housing. Two taper roller bearings support the hub on the stub axle.

74

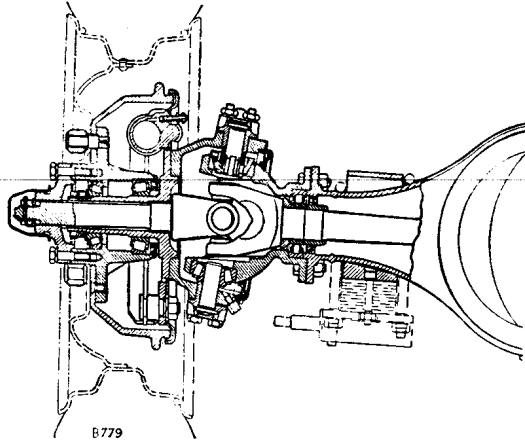

Fig. 66. Front axle cross section

158. A nut and a locknut provide adjustment of the hub end-float. The drive is transmitted from the driving shaft to the hub by means of a driving member, which also serves to enclose the hub assembly.

Contracts prefixed with the letters 'WV' for Rover 8 and 9 models are fitted with a strengthened differential at the front. Identification is by a plate attached to the pinion seal housing and embossed with a part number. See Fig. 64 and also NOTES TO READERS on page xiii.

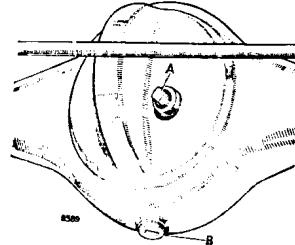

Fig. 67. Front differential lubrication
A—Filler/level plug. B—Drain plug.

75

Lubrication

Differential Oil Level

159. The differential oil level must be checked periodically, immediately after a run when the oil is warm, and replenished as necessary to the bottom of the filler plug hole. The front axle level-filler plug is at the front of the axle casing.

NOTE.—A second plug fitted at the rear of the front axle casing can be disregarded.

Differential Oil Changes

160. See Para. 149, Fig. 65.

Swivel Pin Housing Lubrication

161. The front-wheel drive universal joints and the swivel pins and front hubs, receive their lubrication from the swivel pin housings.

Swivel Pin Housing Oil Level

162. The swivel pin housing oil levels must be checked periodically and replenished as necessary to the bottom of the filler/level plug holes at the rear of the housings. See Fig. 68.

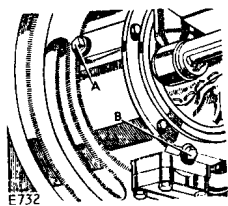

Fig. 68. Swivel pin housing lubrication
A—Filler/level plug. B—Drain plug.

Swivel Pin Housing Oil Changes

163. To change the oil, remove the drain plug from the bottom of each housing, see Fig. 68, immediately after a run when the oil is warm; allow the oil to drain away completely and replace the plugs. Refill with oil of the correct grade through the filler/level plug holes; the capacity of each housing is approximately 1 Imperial pint (0,5 litre).

76

Swivel Pin Housing Gaiter

164. Chamois leather gaiters fitted to the spherical and swivel pin housings give protection to the ball of the spherical housing. They do not interfere with draining or refilling the swivel pin housing and should not be disturbed when carrying out this operation.

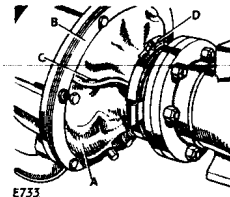

Fig. 69. Swivel pin housing gaiter

A—Gaiter. B—Retainer. C—Lace. D—Clip.

Checks

165. The following points should be checked:—

- (1) Check that the nuts securing the bevel pinion housing to the axle casing are tight and that there is no oil leak at this point.
- (2) Check that the bevel pinion oil seal, swivel pin housing oil seal and hub oil seal do not leak.
- (3) Check that the bolts and nuts securing the swivel pins to the housing are tight.
- (4) Check that the bolts securing the driving member to the front hubs are tight.
- (5) Check that the differential and swivel pin housing filler and drain plugs are tight.
- (6) Report any oil leakage from the flange joints.
- (7) Check chamois leather gaiter on swivel pin housing for signs of damage, displacement or tears.

Routine Adjustments and Servicing

Hub End-Float Adjustment. (*To be carried out by a vehicle mechanic*)

166. Check and adjust hub end-float as follows:—

- (1) Jack up the front of the vehicle and remove the road wheel and brake drum.

77

- (2) Drain off the oil from the universal joint housing (remove both drain and filler plugs).
- (3) Remove hub cap (press fit on the driving member).
- (4) Place a drip tray below the hub and remove the driving member and joint washer from the stub shaft and the hub.
- (5) Mount a dial test indicator on one of the road wheel studs, using the bracket illustrated at Fig. 70. The total hub movement should be .004 to .006 in. (0,10 to 0,15 mm).

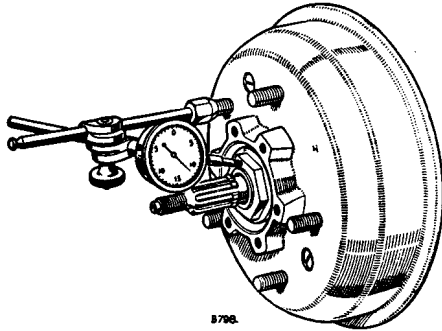

Fig. 70. Checking hub end-float

- (6) Should the end-float prove to be correct, reassemble by reversing the stripping procedure. Replace the drain plug and refill the universal joint housing with oil.
- (7) If the end-float is not correct, prise-up the locking tabs and unscrew the outer locknut.
- (8) Adjust the inner hub nut, tighten the locknut and again check the end-float. When the hub movement is correct, tighten the locknut and bend over two new tabs of the locking washer. As a safeguard, the end-float should be checked once more after locking the nuts.
- (9) Replace the driving member and joint washer and complete the assembly by reversing the stripping procedure, taking care not to over-tighten the nut securing the driving shaft to the driving member.

78

- (10) Replace the drain plug and refill the universal joint housing with oil.

NOTE 1.—If no dial test indicator is available, the hub end-float can be satisfactorily adjusted as follows: Tighten up the adjusting nut until the bearings are felt to bind, then slacken off the nut just sufficiently to permit the hub to revolve freely, but without noticeable end-float. Then proceed as described above.

NOTE 2.—The oil filler plug located in the driving member is for initial filling only. During normal running the oil level is maintained from the differential and the hub requires no further attention in this respect. If the hub is replaced or has been stripped down for any purpose, it must be filled on assembly with one-third pint of the same grade of oil as used in the differential.

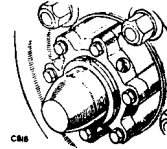

Fig. 71. Oil filler plug, axle hub

CHAPTER 9

STEERING

RECIRCULATING BALL TYPE

Description

167. The steering unit is secured to a chassis bracket at the steering box and to a bracket on the dash panel at its upper end. It is of the recirculating ball type, the inner column having a spiral thread on which operates the main nut assembly.

The nut is free to move longitudinally in the steering box. The steering box is fitted with two replaceable bushes, in which operates the rocker shaft. The rocker shaft is attached to the main nut assembly by a fork and roller joint.

168. The 17 in. steering wheel is splined on to the inner column and secured by a pinch bolt.

169. A longitudinal steering tube, having left-hand and right-hand threaded ball joints, connects the drop arm to the upper lever of the steering relay unit mounted in the chassis cross-member below the radiator. This relay unit incorporates spring loaded split "Tufnol" cone bushes which damp the steering action and prevent minor road shocks being transmitted to the steering wheel.

79

170. The lower lever of the relay unit is connected to one steering arm by the drag link, which has left-hand and right-hand ball joints; the system is completed by the track rod connecting both steering arms, which is of a similar construction to the drag link.

Steering Box Lubrication

171. The steering box oil level must be checked periodically and replenished as necessary to the bottom of the filler plug hole on the top cover plate. Access to the plug is gained by lifting the bonnet panel. See Fig. 72.



Fig. 72. Steering box oil filler plug
A—Filler plug.

Checks

172. The following points should be checked:—

- (1) Check for tightness the bolts securing steering box to the chassis bracket.
- (2) Check the side and bottom plates of the steering box for oil leakage and tightness.
- (3) Check that the drop arm, mounted on the steering box rocker shaft is secure.
- (4) Check steering column for wear or end play. Adjust as necessary (see para. 174).
- (5) Check for tightness the bolts securing the steering column support bracket to dash panel.
- (6) Check end play in rocker shaft and adjust as necessary (see para. 173).
- (7) Check ball joint for wear. (See para. 175).

Routine Adjustments and Servicing

Rocker Shaft Adjustment

173. End play in the rocker shaft may be taken up by means of the adjuster in the top cover plate; need for attention at this point will be indicated by a slight rattle from the steering column.

The adjustment should be carried out after the first 750 miles (1,000 km), but thereafter will only be required at long intervals.

Proceed as follows:—

With the road wheels set straight ahead, slacken the locknut and screw the adjuster down by hand until it contacts the top of the rocker shaft; then secure with the locknut. See Fig. 73.

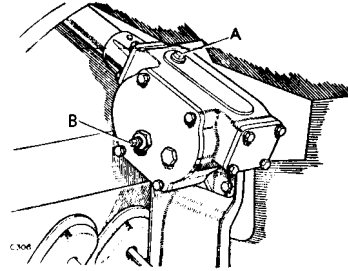

Fig. 73. Rocker shaft adjustment
A—Filler plug. B—Adjuster.

Steering Column Adjustment (To be carried out by a vehicle mechanic)

174. End thrust in the steering column is taken up by removing shims and joint washers under the bottom cover of the steering box.

Wear or end play in the steering unit can therefore be taken up when necessary in the following manner:—

- (1) This adjustment will be made more accessible by the removal of the offside front wheel.
- (2) Remove bottom cover of steering box which is retained by four nuts.
- (3) Withdraw bottom cover and remove all shims and joint washers. Take care that the inner column ball races are not dislodged, otherwise it will be necessary to remove the steering unit to enable replacement to be made.
- (4) Replace bottom cover only and tighten up until no end-float is experienced on rotating the steering wheel. Measure with a feeler gauge the gap that has been caused by the removal of the shims and joint washers.
- (5) Remove bottom plate and insert required number of shims and alternate joint washers, checking on assembly that no end thrust is apparent.

- (6) Lower vehicle and top up steering box with correct grade of oil.

Steering Ball Joints

175. The steering joints have been designed in such a way as to retain the initial filling of grease for the normal life of the ball joints, however this applies only if the rubber boot remains in position on the ball joint. The rubber boot should be checked every 3,000 miles (5,000 km) to ensure that they have not become dislodged or the joint damaged.

To check for wear move the ball joint vigorously up and down. Should there be any appreciable free movement the complete joint must be replaced. Should any of the rubber boots be pushed out of position proceed as follows:—

- (1) Remove ball end from lever;
- (2) Remove rubber boot;
- (3) Thoroughly clean all parts;
- (4) Apply suitable grease round taper of ball joint and also fill the boot;
- (5) Reassemble all parts using new rubber boot and springs as required.

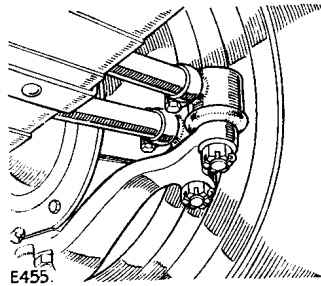

Fig. 74. Steering ball joint

Steering Link Adjustment

176. All ball joints are of the non-adjustable type and are screwed into the ends of the steering tubes and retained by clips and pinch bolts. Adjustment to each steering link can be made by releasing the ball joint clips and rotating the tube to lengthen or shorten the link as required.

Front Wheel Alignment. (To be carried out by a vehicle mechanic)

177. No adjustment is provided for castor, camber or swivel pin inclination.

The toe-in is adjustable. Proceed as follows:—

- (1) Set vehicle on level ground with the road wheels in the straight-ahead position and push it forward a short distance.
- (2) Measure the distance between the edges of the rims, at the height of the hub centres, in front of the axle, marking the points between which the measurement is taken.
- (3) Move the vehicle forward until the marks on the rim are at hub height, at the rear of the axle.
- (4) Measure the distance between the marks. The measurement at the front of the axle should be $\frac{1}{8}$ to $\frac{1}{4}$ in. (1,2 to 2,4 mm) less than that at the rear.
- (5) If correction is required to the toe-in, slacken the clips securing the ball joints to the track rod, and turn the rod to decrease or increase its effective length as necessary, until the toe-in is correct.
- (6) Tighten the ball joint clips.

Lock Stop Bolt Adjustment (To be carried out by a vehicle mechanic).

178. An adjustable lock stop bolt is fitted to each swivel pin housing oil seal retainer.

To adjust:—

- (1) Slacken the stop bolt locknut.
- (2) Adjust the stop bolt so that the distance from the head of the bolt to the face of the oil seal is $\frac{1}{4}$ in. (12,5 mm).
- (3) Tighten the locknut.

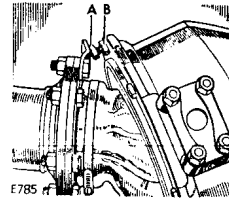

Fig. 75. Adjusting lock stop bolt
A—Lock stop bolt. B—Locknut.

Distance between head of bolt and oil seal retainer $\frac{1}{4}$ in. (12,5 mm).

CHAPTER 10 BRAKE SYSTEM

Description

Foot Brake

179. The wheel brakes, operated by a pendant foot pedal, are of the Girling hydraulic type, while the hand brake operates a Girling mechanical brake unit mounted on the output shaft from the transfer box.

Brake and Clutch Fluid Reservoir

180. The combined fluid reservoir for the brakes and clutch is mounted above the foot pedals on the engine side of the dash.

The level is correct when the fluid is just above the top of the inner reservoir; periodically remove the filler cap and replenish as necessary making sure that both clutch and brake reservoirs are topped up.

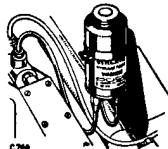

Fig. 76. Brake and clutch fluid reservoir

Master Cylinder

181. The master cylinder is bolted to a bracket on the engine side of the dash.

Pipe System

182. From the master cylinder a pipe leads to a five-way piece on the chassis side member. Two separate pipes lead to each front wheel cylinder via flexible hoses; the third pipe runs to a "T" junction on the rear axle casing, via a flexible hose situated between the right-hand chassis side member and the rear axle casing. The connection is completed by pipes to the rear wheel cylinders, secured to the axle casing with clips. A hydraulic stop lamp switch is also located in the five-way piece.

Wheel Brake Units—Rover 8

183. Hydraulic wheel brake units with leading and trailing shoes fitted to each front and rear wheel. The hydraulic cylinders fitted to the front brakes are slightly larger than those fitted to the rear.

84

The brake shoes pivot at a common point and are free to float at the hydraulic expander unit (wheel cylinder). Two pistons having pressure seals (cups) in the wheel cylinder are held apart by a spring which prevents misalignment of the cups and keeps the pistons in light contact with the brake shoes. A bleed screw nipple and non-return valve are provided on the wheel cylinder, access to the nipple being gained from the rear of the anchor plate (Fig. 77). Rubber covers are fitted over the bleed nipple and pistons to exclude dust and mud. A single adjuster cam is fitted to each brake anchor plate.

Wheel Brake Units—Rover 9

184. **Rover 9 Front.** Two leading shoe arrangement operated hydraulically by individual wheel cylinders connected to each other by an external pipe.

Each piston has one pressure seal (cup) which keeps the piston in light contact with the brake shoe. A bleed screw nipple and non-return valve is fitted in one cylinder only, access to the nipple is gained from the rear of the anchor plate. Fig. 78. Rubber covers are fitted over the bleed nipple and pistons to exclude dust and mud. Two adjusting cams, one for each shoe, are fitted to both the front anchor plates. See Fig. 78.

Rover 9 Rear. Hydraulically operated with leading and trailing shoes.

The brake shoes pivot at a common point and are free to float at the hydraulic expander unit (wheel cylinder). Two pistons having pressure seals (cups) in the wheel cylinder are held apart by a spring which prevents misalignment of the cups and keeps the pistons in light contact with the brake shoes. A bleed screw nipple and non-return valve are provided on the wheel cylinder, access to the nipple being gained from the rear of the anchor plate (Fig. 79). Rubber covers are fitted over the bleed nipple and pistons to exclude dust and mud. Two adjusting cams, one for each shoe, are fitted to the rear anchor plates.

Brake Pedal

185. The pendant type brake pedal is mounted on the dash and operates the master cylinder by means of a short push rod. The adjustment on the stop bolt which controls the position of the brake pedal is set on initial assembly and should not be disturbed.

Hand Brake

186. The hand brake shoes are mounted at the rear of the transfer box on the speedometer drive housing and operate on the transfer box output shaft.

85

The brake shoes pivot on two adjuster plungers and are operated by an expander cone and two expander plungers. The hand brake lever of the normal ratchet type, is mounted on the right-hand chassis side member, and is connected to the relay lever by means of a vertical adjuster rod. The relay lever, mounted on a spindle in the chassis side member, pulls forward the operating rod fixed to the expander cone when the hand brake is operated.

Under adverse conditions it is advisable to engage four-wheel drive as well as applying the hand brake. By this method the hand brake will be effective on all road wheels.

Lubrication

187. The hand brake linkage should be lubricated by means of an oil can at the following points:—

- (1) At the connection between hand brake lever and operating rod.
- (2) At the joints on the hand brake bell crank lever.

Checks

188. The following points should be checked:—

- (1) Check the three flexible hoses and the pipe lines for signs of damage and the unions for tightness.
- (2) Check the level of the fluid in the supply tank. See para. 180.
- (3) Check the bolts securing the master cylinder to dash bracket for tightness.
- (4) Check the set screws fixing the brake drums for tightness after the road wheels have been removed.
- (5) Check that the master cylinder push rod has $\frac{1}{8}$ in. (1.5 mm) free movement.

Routine Adjustments and Servicing

Wheel Brake Adjustment, Rover 8. (To be carried out by a vehicle mechanic)

189. When lining wear has reached the point where the pedal travel becomes excessive, it is necessary to adjust the brake shoes in closer relation to the drum.

Proceed as follows:—

- (1) Jack up the vehicle.
- (2) On the back face of the brake anchor plate will be found a hexagon adjustment bolt (Fig. 77 (A)), which operates a snail adjuster bearing on the leading shoe. Only one of these is fitted to each wheel brake unit, thereby providing single-point adjustment.

86

- (3) Spin the wheel and rotate the adjuster until the brake shoe contacts the drum, then ease the adjuster until the wheel again rotates freely.
- (4) Repeat for the other three wheels.

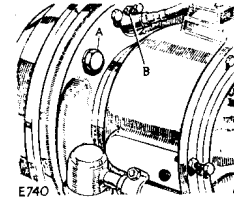

Fig. 77. Wheel brake adjustment, Rover 8, front and rear
A—Adjuster bolt. B—Bleed nipple.

Wheel Brake Adjustment, Rover 9. (To be carried out by a vehicle mechanic)

190. When lining wear has reached the point where the pedal travel becomes excessive, it is necessary to adjust the brake shoes in closer relation to the drum.

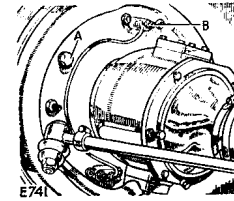

Fig. 78. Wheel brake adjustment, Rover 9, front
A—Adjuster bolt. B—Bleed nipple.

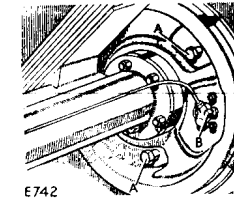

Fig. 79. Wheel brake adjustment, Rover 9, rear
A—Adjuster bolt. B—Bleed nipple.

87

Front and Rear: Each shoe is independently set by means of an adjuster operating through a serrated snail cam.

- (1) With the vehicle jacked up, ensure that the wheels rotate freely; slacken off the adjuster if necessary by turning anti-clockwise.
- (2) Turn the adjuster for each shoe clockwise until the shoe contacts the brake drum, then slacken off until the wheel rotates freely.

Master Cylinder Adjustment. (To be carried out by a vehicle mechanic)

191. If the free movement on the master cylinder push rod is less than $\frac{1}{8}$ in. (1,5 mm) adjust as follows:—

- (1) Remove top cover plate from master cylinder mounting bracket.
- (2) Slacken off the locknut and rotate the push rod with the fingers until the correct movement has been attained.
- (3) Tighten the locknut and re-check the free play.
- (4) Refit the top cover plate.

Hand Brake (Transmission Brake) Adjustment. (To be carried out by a vehicle mechanic)

192. Periodic adjustment of the transmission brake unit will be required; proceed as follows:—

- (1) Release the hand brake.
- (2) Adjustment is made by means of the adjuster wedge spindle (A) (Fig. 80) protruding from the front of the brake back-plate, accessible from beneath the vehicle; during rotation of the adjuster a click will be felt and heard at each quarter revolution.
- (3) Rotate the spindle as far as possible in a clockwise direction, i.e. until the brake shoes contact the drum.
- (4) Then unscrew the adjuster two clicks and give the brake a firm application to centralize the shoes; the brake drum should now be quite free to rotate.
- (5) No other adjustment to the hand brake system is necessary to compensate for lining wear.

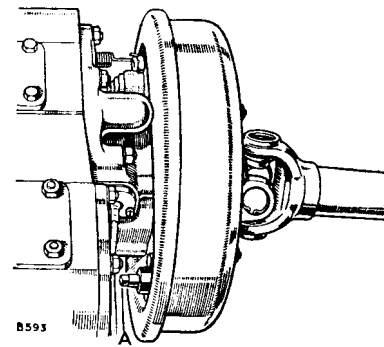

Fig. 80. Transmission brake adjustment
A—Adjuster.

Bleeding the Brake System. (To be carried out by a vehicle mechanic)
193. If the level of fluid in the reservoir is allowed to fall too low, or if any section of the brake pipe system is disconnected, the brakes will feel "spongy", due to air having been absorbed into the system. This air lock must be removed by bleeding the hydraulic system at the wheel cylinders; bleeding must always be carried out at all wheels, irrespective of which portion of the pipe-line is affected.

- (1) Attach a length of rubber tubing to the bleed nipple on the wheel unit farthest from the brake pedal and place the lower end of the tube in a glass jar.
- (2) Slacken the bleed screw behind the nipple and pump the brake pedal sharply two or three times and then more slowly, pausing at the end of each stroke, until the fluid issuing from the tube shows no signs of air bubbles when the tube is held below the surface of the fluid in the jar.
- (3) Hold the tube under the fluid surface and tighten the bleed screw.
- (4) Repeat for the other three wheels in turn, finishing at the one nearest the brake pedal.
- (5) Readjust the brakes.
- (6) The fluid in the reservoir should be replenished throughout the operation, to prevent more air getting into the system. Note particularly that the fluid reservoir for the brake is the outer portion of the combined reservoir.

CHAPTER 11 CHASSIS AND SUSPENSION

CHASSIS

Chassis Frame

194. The chassis frame is of box section throughout, providing extreme rigidity, and requires no attention.

Front Bumper and Bumperettes

195. Attached by bolts and readily detachable for attention to accidental damage. Bumperettes incorporating front lifting and towing brackets are situated on each side of the front bumper.

Rear bumperettes are attached to the rear cross member.

SUSPENSION

Description

196. The suspension is by semi-elliptic leaf springs at both front and rear. As a safeguard, in the event of main spring leaf fracture, the ends of each second leaf are curled over the bushes, to afford some measure of support until the defect can be rectified.

197. The road springs are attached directly to the chassis at the front, while swinging shackles are fitted at the rear ends of the springs. Each shackle pin is mounted through a bonded rubber bush; the bushes do not rotate, angular movement being taken by torsional deflection of the rubber elements. Flexible fabric check straps, secured to the chassis side members, are provided to limit the downward movement of the rear axle. To avoid the possibility of the check straps chafing through the rear brake pipes, suitable shields are fitted between the axle casing and the road springs.

198. A rubber bump block is secured to the underside of the chassis side member above each road spring.

199. Non-adjustable telescopic hydraulic dampers are fitted to each spring; they are secured in rubber mounting bushes, to pins in the chassis side members and road spring bottom plates. This type of damper incorporates a special seal which prevents leakage of hydraulic fluid; consequently no "topping-up" or other servicing attention is required at any time.

Checks. (To be carried out by a vehicle mechanic)

200. The following points should be checked:—

- (1) The U-bolt nuts (Fig. 81 (B)) should be tight and the lock-plates correctly secured.

90

- (2) Examine the spring leaves for cracks or displacement and correct as necessary.
- (3) Check that leaf clips (Fig. 81 (A)) are tight.
- (4) Check that all damper retaining nuts are tight.
- (5) Check the spring bushes for excessive wear or damage and replace as necessary.
- (6) Check that the bump rubbers are secure and undamaged; replace as necessary.
- (7) Ensure that the check straps are not excessively worn or damaged, and that the securing bolts are tight.
- (8) Check the hydraulic dampers by bouncing each corner of the vehicle in turn. Uniform movement would indicate that no attention is required, but if the damping effect is slight or erratic, the damper should be renewed.

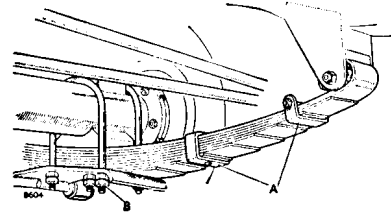

Fig. 81. Leaf clips and U-bolts
A—Leaf clips. B—U-bolt nuts.

CHAPTER 12 WHEELS AND TYRES

WHEELS

Description

201. Divided type wheels are attached to the axle flange at the rear and to the hubs at the front by means of five studs and nuts.

Checks

202. The points detailed below should be checked:—

- (1) Ensure that the wheel securing nuts are tight.
- (2) Ensure that the clamping nuts which hold the two halves of the wheel together are tight. See para. 211, Fig. 84 for tightening order.

91

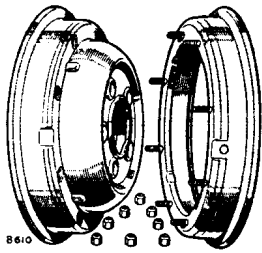

Fig. 82. Divided wheel

Routine Adjustments and Servicing

Wheel Changing

203. Proceed as follows:—

- (1) Slacken the double-ended wheel securing nuts.
- (2) Jack up the corner of the vehicle, fitting the jack under the road spring below the axle casing.
- (3) Remove the nuts and withdraw the wheel over the studs.
- (4) If available, place a drop of oil on the stud threads, to assist in subsequent removal.
- (5) Fit the new wheel, with the "V" tread directed to the front at the top; tighten the nuts securely and lower the vehicle to the ground.

WARNING.—Divided type wheels. Do not touch the outer ring of nuts painted red unless the wheel is removed and the tyre fully deflated, otherwise severe personal injury may result.

TYRES

Description

204. Dual purpose 6.50 x 16 tyres cross-country tread are fitted to Rover 8 vehicles and 7.50 x 16 cross-country tread to Rover 9 vehicles.

Tyre Treads

205. The tread form of the tyres makes them uni-directional. They must be fitted with the "V" or arrow in the tread pattern pointing forwards at the top of the wheel, to ensure maximum grip and efficient tread cleaning when operating on soft ground. For this reason, it may be necessary to reverse the spare tyre on its wheel (depending on which side of the vehicle it is to be fitted) when putting it into service.

Factors Affecting Tyre Life

206. The most important factors, among many which have an adverse effect on tyre life, are:—

- (1) Incorrect tyre pressures.
- (2) High average speeds.
- (3) Harsh acceleration.
- (4) Frequent hard braking.
- (5) Warm, dry climatic conditions.
- (6) Poor road surfaces.
- (7) Impact fractures caused by striking a kerb or loose brick, etc.
- (8) Incorrect front wheel alignment. Alignment should be checked periodically and adjusted as necessary. See para. 177.

Checks

207. Check tyre pressures, including the spare wheel.

Routine Adjustments and Servicing

Tyre Pressures

208. "Butyl" synthetic rubber inner tubes are fitted and can be identified by the blue ring round the valve stem, or the blue valve stem.

- (1) Check the pressure with the tyres cold, as the pressure is about 2 lb./sq.in. (0.14 kg/cm²) higher at running temperature.
- (2) Always replace the valve caps, as they form a positive seal on the valves.
- (3) Any unusual pressure loss (in excess of 1 to 3 lb./sq.in. (0.07 kg/cm² to 0.21 kg/cm²) per week) should be investigated and corrected.
- (4) Always check the spare wheel, so that it is ready for use at any time.
- (5) Remove embedded flints, etc., from the tyre treads with the aid of a penknife or similar tool. Clean off any oil or grease on the tyres, using gasoline sparingly.

Changing Wheel Positions

209. In the interests of tyre mileage and even wear, it is desirable to change the position of the tyres on the vehicle (including the spare) at regular intervals. The front and rear wheels should be interchanged on each side of the vehicle; at the same time, the spare wheel, see Fig. 83, should be fitted to give it a spell of duty and one of the other wheels removed to become the spare.

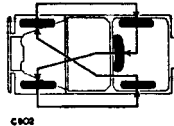

Fig. 83. Changing wheel positions

Tyre Removal. Divided Rim Type Wheels

210. Do not touch the nuts securing the two halves of the wheel together before the tyre is deflated or serious personal injury may result.

Remove the tyre as follows:—

- (1) Remove the valve cap and core to deflate the tyre.
- (2) Press each bead in turn away from the flange, using levers and working round the tyre in small steps. Two or three circuits of the tyre may be necessary to free the beads completely.
- (3) Slacken and remove the clamping nuts. Remove the upper half of the wheel. Push the valve through the lower half of the wheel and remove the cover and tube.

Minor tyre injuries, such as from nails, require no attention other than removal of the object, but more severe tread or wall cuts require vulcanized repairs. Avoid the use of gaiters or liners except as a temporary expedient.

Owing to "Butyl" synthetic inner tubes being fitted, all repairs must be vulcanized.

Tyre Replacement. Divided Rim Type Wheel

211. Proceed as follows:—

- (1) Thoroughly examine the cover for nails, flints, etc., and ensure that no loose objects have been left inside. Clean the wheel rim flanges and seatings.
- (2) Inflate the inner tube until it is just rounded out, dust with french chalk and insert it in the cover with the white spots near the cover bead coinciding with the black spots on the tube.
- (3) Fit the protection flap, starting at the valve position. Make sure that the edges of the flap are not turned over inside the cover and that it lies centrally between the beads. See that the flap fits closely against the tube round the valve.

- (4) Lay the studded half of the wheel on the floor or bench with the studs pointing upwards. Fit the cover over the wheel and thread the valve through the hole, making sure that it points downwards.
- (5) Fit the other half of the wheel and tighten the clamping nuts lightly. Finally, tighten the nuts in the sequence illustrated. Check that the valve is free and inflate the tyre to the recommended pressure.

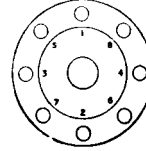

Fig. 84. Sequence of tightening divided rim nuts

Wheel and Tyre Balance

212. Wheel and tyre units are accurately balanced on initial assembly with the aid of small weights secured to the inner side of the wheel slot flanges by means of set bolts. In the interests of smooth riding and even tyre wear, it is advantageous to check the balance whenever a tyre is refitted.

CHAPTER 13

ELECTRICAL EQUIPMENT

SUPPRESSION OF ELECTRICAL INTERFERENCE TO RADIO SERVICES

213. The introduction of VHF radio sets to the services calls for a high standard of vehicle suppression if interference is to be adequately suppressed and full advantage of the sets obtained; good maintenance of the electrical system is therefore essential. It should be remembered that even if a radio set is not fitted the vehicle electrical system can cause interference to nearby radio sets. Attention to the following details will do much to maintain the required standard of suppression.

(a) Sparking plugs

Ensure that the mating surface of the plug, gasket and cylinder head are clean and that the plug is fitted tightly into the cylinder head.

- (b) Ignition leads
 - (i) Ensure that connections to the plugs are clean and tight.
 - (ii) Ensure that the screening is not corroded or frayed, but is continuous and properly earthed at both ends.
- (c) Distributor
 - (i) Keep all connections and mating surfaces tight, clean, free from paint, corrosion, and lubricant.
 - (ii) Maintain a good contact between screen of L.T. and H.T. ignition leads and that of the distributor, which must be properly earthed.
- (d) Coil
 - (i) Ensure good, clean and tight connection of all coil leads.
 - (ii) Maintain a good metal-to-metal contact, free from paint, corrosion and lubricant, between the body of the coil and its mounting and between the junctions of the screen.
- (e) Battery

Keep the battery terminals and leads clean and properly fitted to provide a good electrical connection.
- (f) Earthing and bonding strips

Keep all junctions clean, free from corrosion or paint and ensure that they are tight.
- (g) Remainder of electrical systems
 - (i) Ensure that there is no intermittent contact on any of the fuses, leads, switches or connections.
 - (ii) Ensure that any screening is continuous and is properly earthed at both ends.
- (h) Do not interfere with the vehicle wiring system.
- (i) Avoid making improvised connections to the electrical system.
- (j) Avoid tampering with any parts of the electrical system which are not understood.
- (k) Do not paint under bonding strips, or earth braids or other parts intended to be in electrical contact.
- (l) Do not remove any suppression equipment that may be fitted to the vehicle.
- (m) Refrain from using switches unnecessarily.
- (n) Report immediately any defects which may affect the standard of suppression of the vehicle.

96

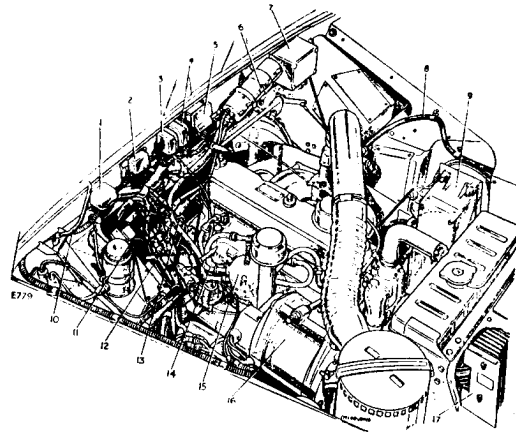

Fig. 85. Electrical equipment in engine compartment, 40 amp generator

- | | |
|--|--|
| 1 Fuse box, auxiliary feed to NATO socket and interior lights when fitted. | 9 Generator panel CAV type 323/2 |
| 2 Turnlight relay. | 10 Bonding for suppression. |
| 3 Fuse box, A1-A2, turn and stop lights. | 11 Mixture control switch (cold start). |
| 4 Fuse box, A3-A4, engine auxiliaries and windscreen wipers. | 12 Fuel change-over tap and switches |
| 5 Horn relay. | 13 Starter solenoid switch. |
| 6 Ignition coil. | 14 Screened high tension leads for ignition. |
| 7 Filter unit for coil. | 15 Distributor. |
| 8 Aerial cable. | 16 Generator. |
| | 17 Rectifier—only fitted with 40A generator |

IGNITION SYSTEM

DISTRIBUTOR

Description

214. The distributor is mounted on an extension of the oil pump driving shaft. It is of the screened type having a centrifugal automatic advance mechanism which has an operating range of 0-22 degrees over a distributor speed range of 750-2,400 rev./min. (1,500-4,800 rev./min. engine speed).

97

Amdt. No. 4 and 5

215. Further adjustment to the distributor may be made by slackening off the retaining bolt and moving distributor body round to either R (retard) or A (advance) as shown on the calibrated scale. The standard setting is with the bolt in the centre of the scale, leaving two divisions possible advance and two divisions retard. See Fig. 86.

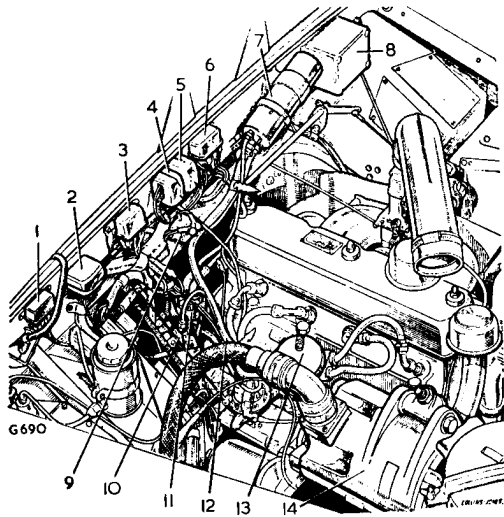

Fig. 85A. Electrical equipment in engine compartment, 90 amp generator

- | | |
|----------------------|--|
| 1 Relay, stop light. | 8 Filter for coil. |
| 2 Fuse box. | 9 Mixture control switch (cold start). |
| 3 Relay, indicator. | 10 Change-over switch, fuel gauges. |
| 4 Fuse box. | 11 Starter solenoid switch. |
| 5 Fuse box. | 12 Screened high tension leads. |
| 6 Relay, horn | 13 Distributor. |
| 7 Coil. | 14 Generator. |

97A

- (3) The distributor rotor should now correspond with No. 1 cylinder high tension lead terminal.
- (4) Set distributor adjustment so that the retaining bolt is central between the 'A' and 'R' marks on the calibrated scale.
- (5) Slacken the pinch bolt at the base of the distributor; rotate the distributor body until the contact breaker points are just opening with the fibre cam follower on the leading side of the cam; re-tighten the pinch bolt.

IGNITION COIL

Description

220. The ignition coil is a 10 volt oil filled unit and to make it suitable for the 24 volt system a ballast resistor is connected in series with the primary winding of the coil. The ballast resistor is housed with the filter unit.

FILTER UNIT

Description

221. The filter unit is fitted to suppress interference to radio equipment. It consists of a choke, connected in series with the supply to the ignition coil, and two capacitors connected one across each end of the choke and earth.

SPARKING PLUGS

Description

222. The sparking plug is a 14 mm $\frac{1}{4}$ in. reach, 3-piece type with a built-in 1,000-3,000 ohm resistor and a rolled-steel washer. The resistor suppresses interference to radio equipment and also reduces the burning rate of the electrodes.

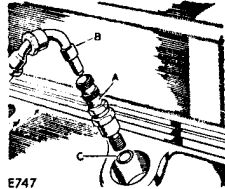

Fig. 89. Sparking plug

A—Sparking plug B—Screened lead C—Washer for sparking plug

Routine Adjustments and Servicing

Clean and Adjust Sparking Plugs. (To be carried out by a vehicle mechanic)

223. At regular intervals remove the plugs, clean and if necessary, reset the electrode gaps to 0.015 to 0.018 in. (0.38 to 0.45 mm). Do not adjust the central electrode.

HIGH TENSION CABLES

224. Examine the screen and glands on each cable to ensure that the metallic screen is undamaged and metal-to-metal contact is maintained throughout the ignition screened system.

BATTERIES

Description

225. Vehicle and radio batteries are located as follows:—

- (1) **Vehicle batteries.** A negative earth return system is used, employing two 12 volt batteries connected in series, giving 24 volts output. They are located in the centre of the seat box between the driver and passenger seats, and are protected by a metal cover secured by two wing nuts. See Fig. 90.

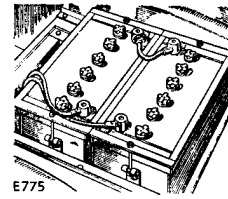

Fig. 90. Vehicle batteries

- (2) **Radio batteries.** Two 12 volt batteries connected in series giving 24 volts output are used for the radio system. They are housed in the body beneath the radio table and are protected by a metal cover. See Fig. 91.

226. The gases liberated from a battery are highly inflammable, therefore, it is important that electrical connections are maintained clean and tight as an insurance against fire.

It is equally important to ensure that the vents in the battery cell filler plugs are kept clear, as pressure within the battery cell is produced if the gases resulting from charging cannot escape. A blocked cell vent may result in a burst battery.

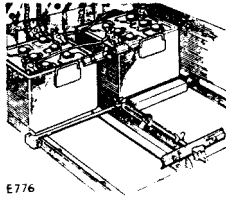

Fig. 91. Radio batteries

NOTE — For full user information on lead acid batteries reference should be made to EMER'S Power J 318 and J 330

WARNING — This vehicle is fitted with a rectified AC system. See Fig. 92.

- (1) The battery connections must always be clean and tight
- (2) Never run the engine without vehicle batteries being connected to the system, this applies even when using slave batteries.
- (3) The radio battery leads must be connected to the battery or correctly stowed, see para. 296.
- (4) Ensure batteries are regularly maintained, see para. 235A.

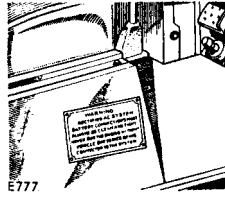

Fig. 92. Warning plate, rectified AC system

Checks 227.

- (1) Check the state of charge of the batteries. See para. 229.
- (2) Check that the battery terminals are clean. Clean if necessary by removing the lugs, and refit as described in para. 230.
- (3) Check that the lead from the battery to starter switch is not damaged and is secured tightly at the starter switch.
- (4) Check that the earth lead is not damaged and has a good connection with the chassis side member.
- (5) Ensure that the vent holes in the centre of the filler plugs are clear.
- (6) Ensure that the battery clamps and housings are tight.

102

Amdt. No. 2 and 3

Routine Adjustments and Servicing

Topping-up Vehicle and Radio Batteries (Two 12 volt in Series)

228. Proceed as follows:—

- (1) Wipe all dirt and moisture from the battery top.
- (2) Remove the filler plug from each cell in turn. If necessary add sufficient distilled water to raise the level to the top of the separators. Replace the filler plug. Avoid the use of a naked light when examining the cells.

In hot climates it will be necessary to top-up the battery at more frequent intervals.

In very cold weather it is essential that the vehicle be used immediately after topping-up, to ensure that the distilled water is thoroughly mixed with the electrolyte. Neglect of this precaution may result in the distilled water freezing and causing damage to the battery.

To Check Electrolyte. (To be carried out by a vehicle mechanic)

229. Occasionally check the condition of the battery by measuring the specific gravity of the electrolyte in each cell, using a hydrometer. Specific gravity readings and their indications are as follows:—

1.280 to 1.300 (32° to 34° Baumé)	Battery fully charged.
About 1.210 (25° Baumé)	Battery about half discharged.
Below 1.150 (19° Baumé)	Battery fully discharged

These figures assume an electrolyte temperature of 60°F. (15.5°C.). If one cell gives a reading very different from the rest, it may be that acid has leaked from that particular cell, or there may be a short circuit between the plates, in which case the battery should be inspected at a workshop.

Never leave the battery in a discharged condition for any length of time; it should be given a short refreshing charge every fortnight, to prevent permanent sulphation of the plates.

Refitting Battery Connectors

230. If the battery connectors have been removed for any reason, see page 102, para. 226 WARNING, they must always be refitted as follows:—

- (1) Clean the terminal post and connector.

103

Amdt. No. 2 and 4

- (b) The diodes are located in heat sinks in the end shield at the slip-ring end of the machine; they are cooled by means of a fan attached to the rotor shaft inside the generator which draws air through the machine via apertures in the end shields.
- (c) The rotor consists of two 6-fingered cup-shaped portions mounted on the shaft to form a 12-pole unit. The field coil is wound around the shaft and is enveloped by the 12 poles of the rotor, the field current being supplied through carbon brushes and the slip rings which, since the field current is approximately only half amp, will give long and trouble-free service.
- (d) As stated above the generator is self excited, the field circuit being taken from the positive line of the generator via the regulator (para. 235C(b)).
- (e) The rotor is carried by a ball bearing at the slip-ring end and a roller bearing at the driving end, the bearings being located in waterproofed housings which are packed with grease XG271 on assembly and require no additional lubrication between major overhauls of the unit.
- (f) Water can enter into the body of the unit, but is prevented from reaching the bearing housings and the brush gear assembly from the inside and from the outside by means of oil seals, sealing gaskets and by the application of sealing compound to screws and joints.
- (g) The brush gear assembly is enclosed in the bearing housing, the bearing at this end being of the semi-sealed type, the seal being located facing the brush gear to prevent grease reaching this assembly. The brush gear is carried by an insulating moulding which is bolted to a web in the housing and helps to separate the bearing from the brush gear.
- (h) Connection to the generator is made via a multi-pin plug.

Lubrication, 40A and 90A generators

232. The generator requires no lubrication to its bearings as they are pre-packed on manufacture.

Checks, 40A and 90A generators

233. The following points should be checked on the generator:

- (1) Check the driving belt tension (see para. 96).
- (2) Check that the cable harness is secure.

104B

Amdt. No. 4 and 5

(3) Ensure that pivot bolts fixing generator to anchor brackets are tight.

(4) Check adjustment strut nuts for tightness.

NOTE: The field connection of the AC 724/1 generator is "alive" when the ignition switch is ON; when checking the generator this switch must be turned OFF.

RECTIFIER, CAV type RUS-3, FOR USE WITH THE 40 amp GENERATOR

Description

234. This rectifier (Fig. 94) is used in conjunction with the AC 724/1 generator, it is a 3-phase full-wave rectifier with selenium elements. It is mounted in front of the engine radiator and is protected by a metal grille. Never push a metallic object through the radiator grille, as it may touch the rectifier, and cause serious damage.

There are three groups of three rectifier cells, each group being connected to the three phases of the generator. (See wiring diagram). The arrangement is such that the generator is connected to the input side of two of the groups, the three leads of the output side of each of these two groups are joined together and constitute the positive connections to the vehicle and radio batteries respectively. The third group is connected in the return circuit, its input side is joined together and connected to 'earth' via the current coil of the regulator and its output side is connected to the three phases of the generator.

The generated 3-phase alternating current is therefore rectified and divided into the two battery (and load) circuits, the return circuit being as outlined above. If both batteries are connected the generator output is shared between them in an amount proportionate to their state of charge.

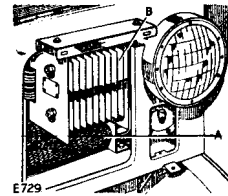

Fig. 94. Oil cooler and rectifier
A—Oil cooler B—Rectifier

105

Amdt. No. 1, 2, 4 and 5

GENERATOR PANEL, CAV type 323-2, FOR USE WITH THE 40 amp GENERATOR

Description

235. This unit (Fig. 95) is used in conjunction with the AC 724/1 generator. It is fitted on the left-hand wing valance in the engine compartment. The unit is accurately set before leaving the factory and should require no further attention under normal circumstances.

It incorporates a CAV 'N' type regulator together with associated resistors and radio interference suppression chokes and capacitors.

The regulator is of the current-voltage control type, it consists of a current and a voltage regulator (of the open, vibrating contact type) mounted on a common base with a centrally disposed support pillar and block to which are secured the two contact assemblies. The regulators control the insertion of a resistance in the generator field circuit to control the generator output.

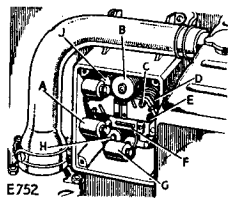

Fig. 95. Generator Panel, CAV type 323/2

- | | |
|----------------------|---------------------------------|
| A—Bushing capacitor | E—Control spring pressure screw |
| B—Choke | F—Compensating resistor |
| C—Adjustable contact | G—Capacitor |
| D—Current regulator | H—Choke |
| J—Voltage regulator | |

106

Amdt. No. 4 and 5

235A. A normal type cut-out is not fitted because the rectifier itself prevents the battery from discharging through the generator when the generator is either stationary or is not delivering a voltage in excess of the voltage in the battery. There is, however, a very small leakage of current through the rectifier which is insufficient to adversely affect the battery provided the battery is efficiently and regularly serviced.

NOTE: If the vehicle is not in use it is important to ensure that the discharge does not drain the battery. A more frequent maintenance cycle must be adopted; each 14 to 21 day interval is suggested.

Servicing

235B. User servicing of the generator panel is not permitted; the panel must not be tampered with.

GENERATOR PANEL No. 9 Mk 3, FOR USE WITH THE 90 amp GENERATOR

Description

235C. Generator Panel No. 9 Mk 3 is used in conjunction with generator No. 10 Mk 2, it is located in the rear body at the right-hand front corner and is bolted to a bracket attached to the body side above the wheel arch, it is a cast aluminium box with cover housing the control units for the generator.

- (a) The interior of the box is divided into two compartments, one of which houses a BCK 102 relay and the other the regulator and its associated resistances, high/low voltage setting link and radio interference suppression filters. The partition between the compartments, together with capacitors, provide a radio interference screen around the regulator.
- (b) A vibrating contact CAV 'N' type regulator is used to control the voltage of the generator, current regulation is inherent in the design of the generator, maximum impedance being reached at its rated output of 90A.

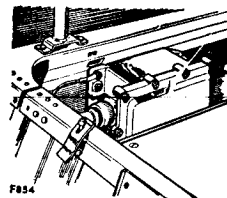

Fig. 95A. Generator panel No. 9, Mk 3

106A

Amdt. No. 2, 4 and 5

- (c) The regulator contacts are connected in the field circuit, the main operating coil being connected across the output terminals of the generator and hence responds to output voltage.
- (d) The regulator operating voltage can be set to a high or low range by means of the high/low setting link. The low position is for high ambient temperature conditions (tropical); the high position is for normal ambient temperatures.
- (e) the CAV BCK 102 relay is fitted to connect the radio batteries (when fitted) in parallel with the vehicle batteries for charging purposes when the generator is functioning. The operating coil of the relay is connected to the auxiliary rectified output terminal of the generator. Two pairs of contacts are fitted to the relay, these are used to connect the positive line of the generator to the vehicle battery positive connection and to the radio battery positive connection respectively when the relay closes.
- (f) A normal type of cutout is not fitted but the relay has a second winding incorporated to work in conjunction with two blocking diodes to hold the relay open in the event of reversed battery connections.

Servicing

235D. User servicing of the generator panel is not permitted; the panel must not be tampered with.

Operation of 90 amp generating system

235E. Closing the ignition switch preparatory to starting the engine completes the field circuit through the closed contacts of the relay and of the regulator.

- (a) As the engine is started and its speed increases the generated voltage rises and when it reaches 18-20 volts the BCK relay closes and the generator positive line is connected to the vehicle and radio batteries. The rate of charge of the two circuits is indicated by ammeters in front of the driver. If the radio battery connections are reversed the RADIO ammeter will read excessively high.
- (b) When the generated voltage reaches 28.5-29.0 volts the regulator contacts open to insert a resistance in the field circuit, the voltage falls and the regulator contacts close again. This cycle repeats continuously and rapidly until the speed of the generator is reduced and the voltage is below the regulator operating voltage.
The generated voltage is reduced to 26.5-27.0 volts for the low setting (para 235c(d)).

106B

Amdt. No. 2, 4 and 5

- (c) If the batteries are discharged and normal running of the vehicle is not contemplated they may be charged by running the engine with the vehicle stationary. The hand throttle control should be adjusted so that the engine runs at the lowest speed at which maximum generator output is obtained; as the battery voltage rises and the charging rate falls the speed should be decreased.

FUSE BOXES

Description

236. Three fuse boxes are fitted on the engine side of the bulk-head; Fig. 97 and 97A show their location and list the circuits protected. The fuses are of the 35 amp cartridge type and a spare fuse is carried in each fuse box.

On vehicles fitted with an AC 724/1 generator an additional fuse box is fitted to the left-hand side of the instrument panel (Fig. 96 and 96A) to protect the radio circuit. It is fitted with a 40 amp (25 S.W.G.) fuse; spare fuse wire is wrapped round the fuse holder.

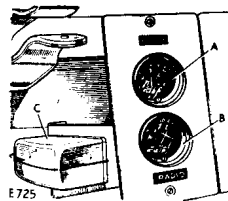

Fig. 96. Fuse box and ammeters, 40 amp models
A—Vehicle ammeter.
B—Radio ammeter.
C—Fuse box

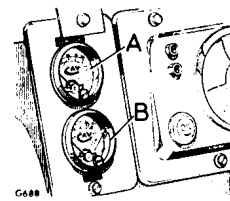

Fig. 96A. Ammeters, 90 amp models
A—Vehicle ammeter.
B—Radio ammeter.

A blown fuse is indicated by the failure of all the units protected by it and is confirmed by examination of the fuse. Before replacing a blown fuse, locate and remedy the fault in the wiring of the units which have failed. If the cause of the trouble cannot be found and a new fuse blows immediately, the vehicle should be examined at a workshop.

Only use the correct size fuse as a replacement.

107

Amdt. No. 2, 4 and 5

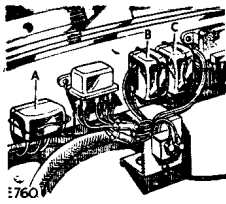

Fig. 97. Fuse boxes on engine side of bulkhead, 40 amp models

- A—Fuse box, auxiliary feed to NATO socket and interior light when fitted
- B—Fuse box A1-A2 for turn and stop lights
- C—Fuse box A3-A4, engine auxiliaries and windscreen wipers

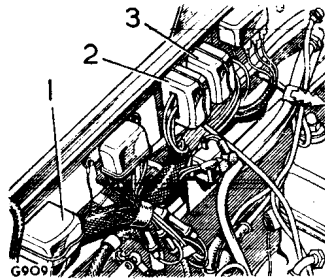

Fig. 97A. Fuse boxes on engine side of bulkhead, 90 amp models

- 1 Fuse box auxiliary feed to NATO socket and interior light when fitted
- 2 Fuse box, A3-A4 engine auxiliaries and windscreen wipers
- 3 Fuse box, A1-A2 turn and stop lights

STARTER MOTOR

Description

237. The starter motor is of the standard 24 volt type, situated at the left-hand side of the engine and mounted to the flywheel housing. It is operated by a remote switch on the dash.

In the event of the starter pinion becoming jammed in mesh with the flywheel, it can usually be freed by withdrawing the dust cap and turning the starter armature by means of a spanner applied to the shaft extension at the commutator end.

Checks

238. The following points should be checked on the starter motor:—

- (1) Check that the nuts securing the starter to the flywheel housing are tight.
- (2) Check that the electrical connections are tight.
- (3) Check that the feed lead is not damaged and is secure at the starter switch.

Routine Adjustments and Servicing

Check Starter Motor Brush Gear. (To be carried out by a vehicle mechanic)

239.

- (1) Remove the starter motor end cover.

108

- (2) Check that the brushes move freely in their holders by holding back the brush springs and pulling gently on the flexible connectors. If a brush is inclined to stick, remove it from its holder and clean it with a gasoline-moistened rag.
- (3) If the brushes are worn, or if the brush flexible connector is exposed to the running face, new brushes should be fitted by an electrician.

Commutator

240. At the same time examine the commutator, which should have a bright burnished appearance. Remove any oil or dirt with a gasoline-moistened cloth.

STARTER SOLENOID SWITCH

Description

241. A solenoid type switch is fitted to the bulkhead and operates the starter motor. No user servicing is necessary. See Fig. 85 (13).

HORN

Description

242. The horn is mounted on the left-hand radiator baffle and is secured by two bolts.

Checks

243. Check horn as follows:—

- (1) Check that the bolts securing the horn are tight.
- (2) Check that the connection of the feed lead is not loose.

Routine Adjustments and Servicing

To Adjust. (To be carried out by a vehicle mechanic)

244. The horn is adjusted on initial assembly and should not require attention for a considerable time. Adjustment merely take, up wear of the moving parts and is not intended to alter the tones proceed as follows:—

- (1) Ascertain that the horn failure or faulty note is not due to some outside source, such as a discharged battery, loose connection, loose part adjacent to the horn, etc.
- (2) If the above suggestions are in order proceed as follows:— Disconnect the leads at the horn, then remove the securing bolts and withdraw the unit. Then adjust by rotating screw 'A' (Fig. 98) clockwise or anti-clockwise until the tone is satisfactory.
- (3) If adjustment of the horn does not produce satisfactory results, it should then be returned to a workshop.

109

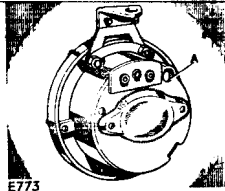

E773

Fig. 98. Horn adjustment, 24 volt
A—Adjusting screw

HORN RELAY

Description

245. The horn relay (Fig. 85 (5)) is mounted at the top centre of the engine side of the dash. It is of the simple single-pole totally enclosed type fitted to prevent burning of the horn push-button contacts.

246. The operating coil of the relay is connected to the vehicle supply and to the horn push-button; its normally open contacts are connected to the supply and to the horn. Operation of the horn push-button energizes the relay which operates to close its contacts and so complete the horn circuit.

WINDSCREEN WIPERS

Description

247. Two windscreen wipers are fitted. They have a radio interference suppressor unit at one side (Fig. 99 (C)) and a lead which plugs into sockets located on the ledge above the instrument panel.

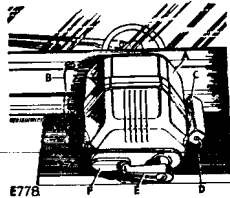

E77B

Fig. 99. Windscreen wiper

A—Windscreen wiper motor D—Lead for suppressor unit
B—Earth lead E—Arm parking lever
C—Suppressor unit F—Wiper switch

110

LIGHTS

Description

Headlights

248. The headlights, mounted in the radiator grille panel, incorporate a combined reflector and front lens assembly known as the Lucas Light Unit. Double filament lamps give a vertical dip.

Side Lights

249. The side lights are mounted in the wing front panels, and the covers are secured by a threaded type holder.

Stop/Tail Lights

250. Two combined stop/tail lights similar to the side lights are fitted at the rear body.

Turnlights

251. The front turnlights are mounted in the front wing panels above the side lights. The rear turnlights are situated on the rear body below the stop/tail lights.

Number Plate Light

252. The number plate light is mounted on the right-hand side at the rear of the body adjacent to the turnlight.

Convoy Light

253. The convoy light is situated centrally under the rear chassis member.

Instrument Panel Lamps

254. The instrument panel incorporates an illumination lamp, the ignition, mixture control, oil pressure and main beam warning lamps.

Checks

255. The following points should be checked:—

- (1) Check lights for broken or cracked glass. If the headlight glass is broken the complete light unit must be renewed. If the lamps are discoloured as a result of long service they should be renewed.
- (2) Ensure that the stop/tail light, turnlight and side light covers are secure.

111

Routine Adjustments and Servicing

Headlight Lamp Replacement

256. Press in the light unit against the tension of the springs on the three adjustment screws, turn it anti-clockwise and withdraw. Twist the back shell in an anti-clockwise direction and pull it off the light unit; the lamp can then be replaced and the unit reassembled.

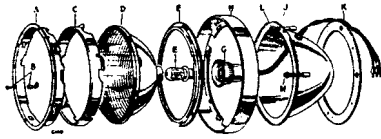

Fig. 100. Headlight, vertical dip

- | | |
|-------------------------------------|------------------------------|
| A—Mask adaptor rim | G—Lamp contact housings |
| B—Fitting securing mask adaptor rim | H—Fairing rim |
| C—Light unit securing rim, front | J—Light shell |
| D—Light unit | K—Rubber gasket |
| E—Lamp | L—Adjusting screw—vertical |
| F—Light unit securing rim, rear | M—Adjusting screw—horizontal |

Headlight Setting. (To be carried out by a vehicle mechanic)

257. The headlights should be set so that the main driving beams are parallel with the road surface. If adjustment is required, the vertical light setting can then be made by turning the screw at the top of the lamp and horizontal adjustment by means of the screws at the side of the unit.

When checking headlights to the dimensions shown at Fig. 101, the vehicle must be unladen, on level ground and 12 ft. (365 cm) from the level marks. Adjust so that area of concentrated light corresponds with marks.

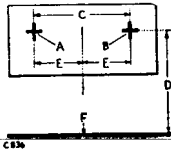

Fig. 101. Headlight setting dimensions

- | | |
|---|-----------------|
| A—Concentrated area of light, L.H. headlight. | |
| B—Concentrated area of light R.H. headlight. | |
| C—20 in. (508 mm). | |
| D—35½ in. (810 mm) 8 vehicles. 37½ in. (945 mm) 9 vehicle | |
| E—10½ in. (271 mm). | F—Ground level. |

Side, Tail/Stop and Turnlight Lamp Replacement

258. All lights are of the same design, the difference being in the colour of the lens, side lights have white, rear lights red and turnlights amber lenses.

To replace lamps in any of the above the glass is unscrewed from its threaded holder when the lamp is readily accessible and can be replaced. Finally screw back the lens.

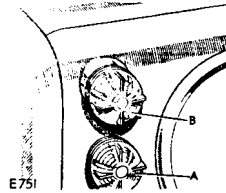

Fig. 102. Side lights and front turnlights
A—Side light. B—Front turnlight.

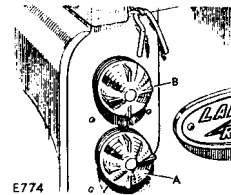

Fig. 103. Stop/tail lights and rear turnlights
A—Stop/tail light. B—Rear turn light.

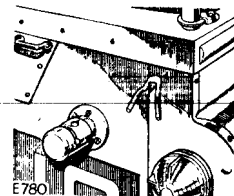

Fig. 104. Number plate light

Number Plate Light Lamp Replacement

259. To replace lamps, unscrew the light locking ring which is situated inside the vehicle body and withdraw holder.

Instrument Panel and Warning Light Lamp Replacement

260. Should a warning lamp burn out, operation of the corresponding component will not be affected, but it should be replaced at the earliest opportunity to safeguard that particular item of equipment.

The mixture control and oil pressure warning lamps can be renewed after unscrewing the respective bezels from the front of the instrument panel. Access to the instrument panel illumination and headlight warning lamps is gained by withdrawing the instrument panel fascia; this is effected by removing the five bolts, washers and nuts securing the panel.

Convoy Light Lamp Replacement

261. To replace the lamp, remove the screws holding the rim cover and withdraw rim and glass cover. The lamp can now be removed. Push new lamp into the holder turning the lamp to the left.

Warner and NATO Trailer Plug Sockets

262. A NATO 12-pin trailer socket is situated on the left-hand side body rear panel. The sockets are protected by a spring-loaded flap. (Fig. 105 (B)). See circuit diagram for wiring connections.

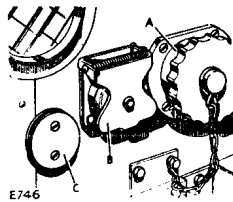

Fig. 105. Warner and NATO trailer plug sockets
A—Warner trailer socket. B—NATO trailer socket.
C—Adaptor for Warner socket cap.

Warner Trailer Socket

263. A 4-pin Warner trailer socket is situated to the right of the NATO socket (Fig. 105 (A)). It is protected by a screw cap secured by a chain fastener. An adaptor is provided to the left of the NATO socket to retain the screw cap when the trailer plug is connected. See circuit diagram for wiring connections.

CHAPTER 14

FITTINGS FOR RADIO STATIONS

General

264. Various radio stations are authorized for this vehicle in its different roles, and to facilitate the installation the items comprising the complete installation are divided into kits—multi-purpose kit, set kit and set ancillary kit—plus Fitted For Radio (FFR) equipment which is fitted in the vehicle during manufacture. The use and location of FFR equipment is described below.

265. The multi-purpose kit is fitted by the user. It consists of items which are common to all radio stations.

266. The set kit consists of the radio set, power supply unit, set carrier and standard set connectors. The set ancillary kit is 'tied' to the set kit and consists of those items required to fit the set kit into the vehicle; it includes the aerial base and special connectors for the set.

267. Rover 8 and 9 cargo vehicles are, in a measure, prepared to receive a radio station in the event of an emergency, *i.e.* certain items of FFR equipment may readily be transferred from an FFR vehicle to a cargo vehicle. References to cargo vehicles in the following paragraphs refer to 8 and 9 vehicles only.

268. The cargo vehicle has certain stiffening plates fitted and holes provided to accept the appropriate components. These holes are normally sealed with slave nuts and bolts or grommets, some have captive nuts to facilitate the fitting of the components.

269. Cargo vehicles have a 12 volt vehicle supply and when a station is transferred to these vehicles the radio equipment is connected direct to the radio batteries.

270. Certain items of the kit may be removed from the vehicle when it is required to use the station in the ground role.

271. The introduction of VHF radio sets to the services calls for a high degree of suppression and filtering if interference is to be avoided (see Chapter 13). Earth braids are located at the following:

- (a) Seat back, R.H. and L.H.
- (b) Exhaust tail pipe.
- (c) Starter motor to chassis.
- (d) Chassis to scuttle.
- (e) Gearbox to chassis.
- (f) Bonnet to scuttle.
- (g) Radio table.
- (h) Wiper motors (2 off).

Aerial Tuning Unit

Plate and Screw Assembly

278. In installations where two VHF sets are used the associated Aerial Tuning Units (ATU) are fitted to the top of the front wings. In installations where only one VHF set is used, the left-hand position is used. The ATU are part of the ancillary kit and transferable with it.

279. Three holes (Fig. 109(B)) are provided in each wing to accept the ATU's, these holes are temporarily sealed by nuts and bolts or grommets by the vehicle erector. The centre hole accepts the special winged screw securing the ATU; the two outer holes are for locating dowels.

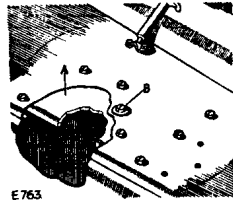

Fig. 109. Front wing strengthening plate
A—Strengthening plate. B—Blanking screws.

280. The front wings are strengthened to carry the ATU by plates bolted to their undersides. Similar strengthening plates are fitted to cargo vehicles. See Fig. 109(A).

Connector Co-Axial

281. Two connector co-axials (Fig. 110) are fitted to the vehicle to connect the ATU to the appropriate radio set. The rear end of the connectors (Fig. 111(A)) are stowed vertically at the centre of the driver's compartment seat rest adjacent to the location of the VHF sets. Captive screw caps (Fig. 111(B)) are provided to protect the ends of the connectors when disconnected. The sockets on the front end of the connectors fit on dummy plugs (Fig. 112) fitted to the inside of the wing valance beneath the engine bonnet.

282. These connectors are not transferable to a cargo vehicle. To re-route the front end of the connector in preparation for connection to the ATU:—

- (1) Unscrew the locking ring securing the connector socket to the dummy plug and withdraw the socket. See Fig. 112.

118

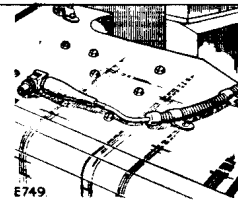

Fig. 110. Aerial co-axials removed from dummy socket and located on front wing

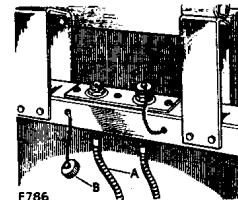

Fig. 111. Aerial co-axials in rear body
A—Aerial co-axials. B—Captive screw cap.

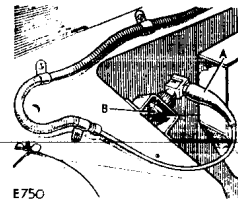

Fig. 112. Aerial co-axial and dummy socket on wing valance
A—Aerial co-axial. B—Dummy socket.

119

- (2) Release the last two cable clips (Fig. 113), each secured by a screw and captive nut. Replace the screws to seal the holes.
- (3) Unscrew the two screws (Fig. 113) located in the holes leading to the ATU. Captive nuts are fitted to the underside of these holes.

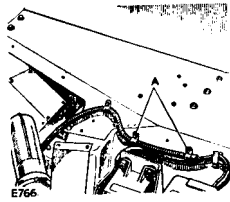

Fig. 113. Cable clips for aerial co-axial leads
A—Clips to be removed and transferred to wing top

- (4) Re-route the connector securing the clips at the points uncovered at (3) above. A suitable notch is formed in each side of the engine bonnet to accommodate the connector; the connector and clips must be arranged so that the connector locates in the notch and runs neatly to the ATU. Similar notches are formed in cargo vehicle bonnets.

**Table top
Runner assembly
Stiffening plate**

283. A table top (Fig. 114 (A)) to carry one or two radio sets is located immediately behind the driver's compartment seat rest. It is secured by four screw clamps (Fig. 114 (D)) to a pair of runner assemblies (Fig. 114 (B)) bolted to the vehicle body wheel arches. The table top is earthed to the vehicle by a copper braid located at the right-hand side.

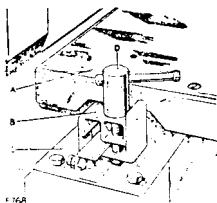

Fig. 114. Radio table
A—Table top
B—Clamping bracket
C—Runner assembly
D—Screw clamp

120

284. Stiffening plates are riveted to the underside of each wheel arch and also to the wheel arch of cargo vehicles.

Batteries and Associated Equipment

Battery Carrier

285. A battery carrier (Fig. 115) is bolted to the floor plate of the vehicle beneath the table. This carrier is designed to house two sets of two 12 volt batteries connected in series to give 24 volts. One set is fitted at the front of the carrier, the remaining set being fitted in service if the radio station requires additional power, and is connected in parallel with the first set.

286. Each set of batteries is secured in the carrier by a centrally disposed swivel bolt with clamp plate and wingnut. The clamp plate locates on the rear top edges of the batteries (Fig. 106(12)).

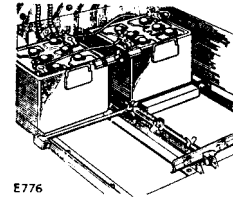

Fig. 115. Radio batteries

Batteries, see page 102, para. 226 WARNING

287. The batteries are of the lead acid type and require the same maintenance as the vehicle batteries (see para. 227). To obtain access to the batteries see para. 302 (2), (3), (4), (6) and (7) and to replace the cover para. 304 (17) and (18).

Battery Cover

288. Protection of the batteries is afforded by a box-shaped steel cover, having its front and bottom sides open. The top front edge of the cover is located by two angle brackets fixed to the back of the driver's compartment seat rest. The cover is secured at its rear end by means of two spring-loaded fasteners (Fig. 106 (13)) bolted to the floor plate which engage hooks fixed to the cover.

289. The cover is robustly designed to permit its use as a platform for the radio sets when the station is being used in the ground role.

121

Battery Post Connectors

290. Radio set battery leads are fitted with spade terminals, and when the set is used in a cargo vehicle or in the ground role, the LT interconnecting box on the set is connected directly to the battery. To accommodate these terminals, special battery post connectors are provided. These connectors are of the split clamp type to fit the battery terminal post and incorporate a lead-coated terminal stud fitted with a D.T. spring washer and wing nut to which the spade terminal is fitted.

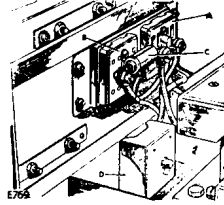

Fig. 116. Terminal boxes

A—Radio batteries and charging circuit terminal box.
B—Radio station box. C—Capacitor. D—Box cover.

Batten Terminal, 2-Point, No. 4

291. Two 2-point terminal boxes (Fig. 116) are located on the left side of the vehicle adjacent to the table.

292. The radio batteries and the charging circuit are connected together at the forward terminal box (Fig. 116 (A)) which is identified —BTY+ and hence the batteries are charged simultaneously with the vehicle batteries. See Wiring Circuit and para. 234.

293. The radio station is connected to the second box (Fig. 116 (B)) which is identified +EQPT— and has a 2 micro-farad F capacitor (Fig. 116 (C)) connected across its terminals. The positive terminal is also connected to the generator side of the radio ammeter, and the negative terminals of the two boxes are connected together and to earth. The radio station is therefore connected to the radio batteries via the ammeter.

294. The radio ammeter indicates radio battery charging current when the generator is 'on line', and discharge current when the generator is not 'on line' and the radio station is being fed from the radio batteries.

122

Amdt. No. 2

295. The terminals of the capacitor are very close to the sides of the terminal box cover (Fig. 116 (D)) and to prevent short circuiting, before removing the cover, the fuse located at the left side of the instrument panel must be withdrawn and one terminal of the radio batteries disconnected, either at the battery or at the —BTY— terminal box.

Insulated Terminals

296. A pair of insulated terminals (Fig. 117) are mounted on a bracket attached to the left wheel arch beneath the radio table. These terminals provide a safe stowage for the ends of the battery/terminal box leads when disconnected from the battery. When the engine is running, these leads are 'live' and must be stowed on the insulated terminals when disconnected.

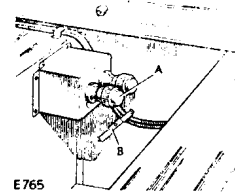

Fig. 117. Insulated terminals

A—Insulated terminals. B—Spring clips.

Cable Clips, Special

297. Two, open-ended spring clips, bolted to the wheel arch below the insulated terminals, are provided to house the battery inter-connector when the radio batteries are disconnected.

298. Two clips, similar to the above but larger, are bolted to the rear of the bulkhead between cab and cargo compartment to accommodate the cables connecting the radio batteries to the junction box and also to accommodate these cables when re-routed to stow on the insulated terminals (para. 296).

Slotted Angle Framework

299. A slotted angle framework (Fig. 106 (1)) is mounted transversely across the vehicle just forward of the radio set table. This unit provides a mounting for miscellaneous radio control units.

123

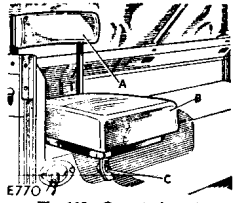

Fig. 118. Operator's seat

A—Backrest. B—Seat cushion. C—Strap retaining stud.

Seats

300. Two operators' seats are provided in 9 $\frac{1}{2}$ ton vehicles and one in 8 $\frac{1}{2}$ ton vehicles (Fig. 118). These are lightweight, quickly detachable seats which rest upon the wheel arches of the vehicle and have hooks on their backs to locate on the sides of the body.

The seats are secured, particularly for cross-country work, by means of a strap fitted to the underside of the seat which locates on a stud (Fig. 118 (C)) fitted to the side of each wheel arch; $\frac{1}{2}$ ton vehicles have a stud on the left side only.

Top Hat Sections

301. When it is required to fit additional radio equipment this may be done by fitting three top hat sections to the rear of each wheel arch.

Slave nuts and bolts are used to plug the fixing holes for these sections.

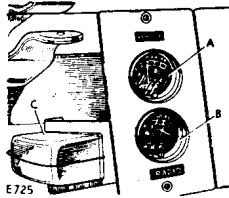

Fig. 119. Ammeters and radio fuse, 40 amp models

A—Vehicle ammeter.
B—Radio ammeter.
C—Fuse box

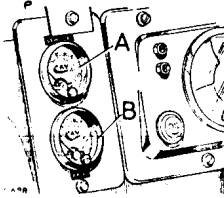

Fig. 119A. Ammeters, 90 amp models

A—Vehicle ammeter.
B—Radio ammeter.

124

Amdt. No. 3 and 5

To dismantle FFR Equipment

302. To dismantle the FFR equipment for transfer to a cargo vehicle:—

- (1) Remove the fuse (Fig. 119 (C)) located on the left side of the instrument panel assembly and stow in some convenient bin.
- (2) Unscrew the four table top clamping screws (Fig. 114 (D)).
- (3) Slide the retaining brackets from the runners.
- (4) Release the table earth braid (Fig. 120 (A)) from its fixing at the right-hand forward stay of the slotted angle framework (Fig. 106 (1)) and lift off the table.

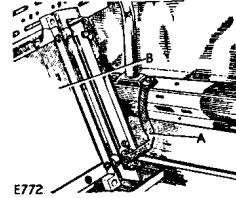

Fig. 120. Radio table earth braid
A—Earth braid. B—Table top.

- (5) Release the two runner assemblies, each is secured by four bolts with nuts and locknuts.
- (6) Release the two spring-loaded fasteners from the hooks on the front of the battery cover.
- (7) Carefully withdraw the cover rearwards from the batteries.
- (8) Slacken the wingnuts securing the slotted battery interconnector and remove the connector. Do not remove the battery post connectors. If two sets of batteries are fitted, disconnect the second set similarly.
- (9) Similarly release the remaining two battery connections, double back the leads and secure the spade terminals to the insulated terminals (Fig. 117 (A)) on the side of the left sill. Locate the doubled-back section of the leads in the spring clips (Fig. 117 (B)) alongside their forward run.
- (10) Release the batteries secured by the swivel type clamps, and lift them from the carrier.
- (11) Release the battery carrier secured by ten countersunk bolts with nuts and spring washers.

125

- (12) Release the two spring-loaded fasteners used to secure the battery cover. Two bolts with spring washers secure each fastener; captive nuts are provided beneath the floor.
- (13) Unscrew the four nuts and bolts securing each aerial mounting bracket (left-hand bracket for one H.F. set installation) and remove the bracket complete with mounting. Alternatively first remove the mounting from the bracket by unscrewing the captive screw at the bottom of the mounting and then withdrawing the mounting; use a tommy bar to turn the screw.
- (14) Only if required, release the slotted angle framework. Six bolts with plain washers screwed into captive nuts secure the assembly.
- (15) Release the seat strap/s from the stud/s on the wheel arches and lift the seat/s from the vehicle.
- (16) 9 (¾ ton) vehicles only.
 - (a) Release the small table, if fitted, secured by four nuts and spring washers.
 - (b) Release the three top hat sections, if fitted, from each wheel arch; each section is secured by two bolts with nuts and spring washers and distance pieces.
- (17) Re-route and stow the ATU co-axial connectors in the reverse sequence to that indicated at para. 228.

FFR Equipment to be transferred

303. Transfer the following items of FFR equipment to the cargo vehicle:—

- (1) Radio batteries complete with battery post connectors.
- (2) Battery inter-connectors.
- (3) Battery carrier with fixing bolts, nuts and spring washers.
- (4) Battery cover.
- (5) Two spring-loaded fasteners with securing bolts, and spring washers for securing the battery cover.
- (6) Aerial mounting brackets each with four bolts, nuts and washers.
- (7) Aerial base mountings.
- (8) Table top complete with four clamping screws and brackets, together with the earth braid and securing wingnut, plain washer and shake-proof washer.
- (9) Two runner assemblies each complete with two mounting blocks and four bolts with nuts and locknuts.

126

- (10) If required, the slotted angle framework complete with six bolts and washers. If the framework is not required the table top earth braid securing bolt and washer must be transferred.
- (11) Operator's seat or seats.
- (12) If required for 9/1 vehicles:
 - (a) Small table.
 - (b) Six top hat sections, if fitted, each complete with two bolts, nuts and spring washers, and distance pieces.

To Fit FFR Equipment

304. To fit the FFR equipment in a cargo vehicle:—

- (1) Remove the nuts and bolts or grommets from the holes in the vehicle floor plate immediately behind the driver's compartment seat rest; ten for the battery carrier and four for the battery cover securing fasteners.

NOTE.—Four additional sealed holes are provided to secure the battery carrier baseboard used in earlier radio installation kits. If the baseboard is fitted it must be removed and the holes sealed.

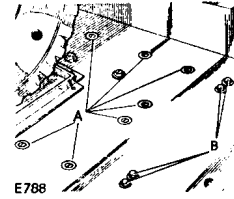

Fig. 121. Position of battery carrier holes

A—Position for battery carrier. B—Position for cover fasteners.

- (2) Fit the battery carrier and the two spring-loaded battery cover fasteners.
- (3) Locate the batteries in the carrier, forward section if only one set of batteries are being used, and secure by the swivel clamps. The clamp locates on the top rear edges of the batteries.
- (4) Ensure that the battery post connectors are clean and tight.
- (5) Fit the battery inter-connector and fully tighten the securing wingnuts.
- (6) Remove the four nuts and bolts or grommets from the two sills immediately behind the seat rest.

127

- (7) Fit the two runner assemblies (see Fig. 114 (B)).
- (8) If disconnected, fit the earth braid to the stud on the underside of the table and secure by the plain washer, shake-proof washer and wingnut. Ensure that the connection is clean and tight.
- (9) Slide the four table top clamping brackets in the runners and secure the table top by the clamping screws. The earth braid locates in the forward, right-hand position.

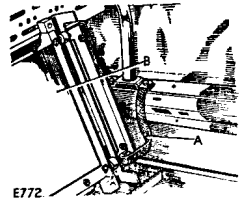

Fig. 122. Position of radio table earth braid
A—Earth braid. B—Table top.

- (10) Remove the six nuts and bolts or grommets from the holes in the side cappings of the vehicle, adjacent to the table top, for the slotted angle framework. Fig. 123.
- (11) Fit the slotted angle framework. Secure the table top earth braid by the rear bolt of the forward stay. The braid locates on the top of a shake-proof washer. Ensure that the earth connections are clean and tight.

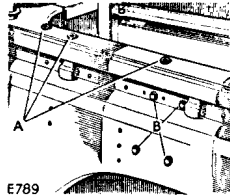

Fig. 123. Holes for angle framework and aerial bracket
A—Position for angle framework. B—Position for aerial bracket.

128

- (12) Remove the four nuts and bolts or grommets from the holes (Fig. 123 (B)) in the two side plates for the aerial mounting bracket. Left-hand side for one H.F. set.
- (13) Fit the aerial mounting bracket/s.
- (14) Locate the aerial base mounting in the boss on the bracket and secure by the captive screw. Use a tommy bar to tighten the screw.
- (15) Remove the three nuts and bolts or grommets from the left-hand, front wing (Fig. 109 (B)) and fit the ATU assembly (see para. 279). If required, fit the second ATU assembly on the right-hand, front wing.
- (16) When the radio station is fitted, connect the station leads to the battery and fully tighten the securing wingnuts.
- (17) Carefully slide the battery cover forward over the batteries, and locate the top front edge under the two brackets on the seat rest.
- (18) Fit the spring fasteners to the staples on the battery cover.
- (19) Locate the operator's seat/s in the vehicle.

CHAPTER 15

BODY

Description

305. With the exception of the dash panel, which is steel, the body panels are constructed throughout from Birmabright 2 with steel cappings and corner plates, which are galvanized.

Bonnet

306. The bonnet top panel is secured by two pull-on type catches, one at either side of the bonnet.

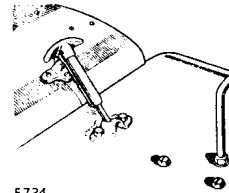

Fig. 124. Bonnet catches

129

To open the bonnet release the catches and raise until it is held open by the support stay. To close, release support stay, lower and secure by catches.

The panel can be removed from the vehicle as follows:—

- (a) Withdraw one of the split pins securing the prop rod.
- (b) Slide the panel off the hinges on the dash.

Spare Wheel

307. The spare wheel is mounted on the bonnet panel.

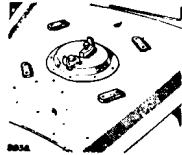

Fig. 125. Spare wheel mounting on bonnet

Rifle Clips

308. Rifle clips are fitted behind the front seats and on top of the dash panel.

Front Seats

309. The fore-and-aft position of the driver's seat, on the 9 vehicles, is readily adjusted by pushing to the left the lever at the left-hand side of the seat base and moving the seat into the most convenient position.

The seat cushions can be removed by lifting at the front and pulling forwards.

The seat backs are secured in the upright position to the backrest panel by straps; if the vehicle is parked in inclement weather without a covering, they may be folded down on to the seat cushions.

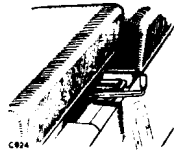

Fig. 126. Seat adjustment—Rover 9 vehicles

130

Radio Operator's Seat

310. Rover 8 vehicles have a single seat mounted on the left-hand wheel arch. On Rover 9 vehicles two seats are used, one at each side of the rear wheel arch.

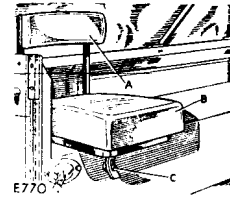

Fig. 127. Radio operator's seat

A—Backrest. B—Seat cushion. C—Seat strap retaining stud.

The seats can be quickly removed by pulling the retaining strap off the stud and lifting the complete seat upwards.

Tool Stowage

311. Small tools are carried in a container underneath the bonnet adjacent to the rear of the left-hand wing on the bulkhead.

Windscreen

312. Provision is made for folding the windscreen down on to the bonnet as follows:—

Remove the hood, then disconnect the windscreen wiper lead at the plug adjacent to the wiper motor. Slacken the nuts at the bottom corners of the windscreen. Lower the windscreen to the bonnet.

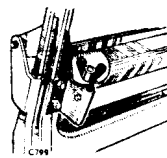

Fig. 128. Windscreen fixing screws, early models

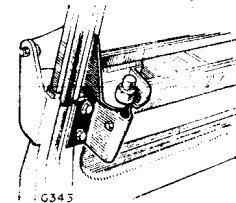

Fig. 128A. Windscreen fixing screw, late models

131

Windscreen Wipers

313. To set the wipers in operation, pull out the blade lever, turn it to clear the switch lever and turn the latter through 90°. To park the blade, reverse these operations.

Windscreen Wiper Arm and Blade Replacement

To replace windscreen wiper blade, remove the rubber bush securing the old blade to the arm; insert the tongue on the replacement blade through the slot in the arm and secure it by fitting the rubber bush through the hole in the tongue.

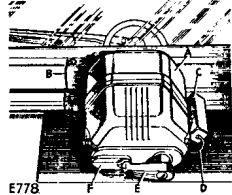

Fig. 129. Windscreen wiper motor

A—Windscreen wiper motor. D—Lead for suppressor unit.
B—Earth lead. E—Parking lever.
C—Suppressor unit. F—Wiper switch.

To replace windscreen wiper arm and blade, slacken the fixing nut and tap sharply to release the collet which clamps the arm on to the spindle; then remove the complete assembly.

When fitting the replacement arm and blade, slacken the securing nut and push the arm boss over the end of the spindle as far as it will go. Secure by tightening the nut.

Windscreen Ventilators

314. The two ventilators in the windscreen frame may be opened independently. Use of the ventilators may be found advantageous when traversing dusty roads as they greatly reduce the amount of dust blown into the vehicle from the rear.

Fine gauze flyscreens are fitted over the apertures. To open or close the ventilators the lever is raised or lowered as necessary.

To open ventilator push lever upwards to register in required notch, to release reverse the operation.

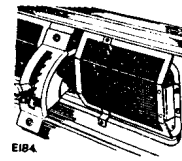

Fig. 130. Windscreen ventilators

Doors

315. Occasionally apply a few drops of oil on the door hinges and door locks.

Tailboard

316. In the horizontal position, the tailboard is retained by two chains. To remove the tailboard completely, remove the split pin and plain washer from one of the hinges, unhook the chains and slide it off its hinges.

Cleaning Body

317. It is always preferable to clean the bodywork with water and sponge, using plenty of water; wherever possible the surface should be freely hosed. Dry with a chamois leather.

Periodically wash the underside of the vehicle, to prevent the formation of mud pockets.

Jerrican Holder

318. A jerrican holder is provided between the front seats above the vehicle batteries.

Soft Hood

319. The soft hood completely encloses the vehicle and can be opened at the rear to facilitate loading.

Should the hood and hood sticks have been removed at any time, they may be refitted in the following sequence:-

- (1) Fit the two hood sticks in the sockets at the corners of the rear body and secure with clamp arms, bolts, washers and nuts.
- (2) Secure the tie tubes between the sticks by means of four self-locking nuts.
- (3) Fit the intermediate hood stick between the tie tubes, securing it with locknuts.

- (4) Secure the door top drain channels between the windscreen and front hood stick with bolts, plain washers and self-locking nuts.
- (5) If not already fitted, secure the door rear drain channels to the front hood stick with bolts, plain washers and self-locking nuts.
- (6) Place the hood over the sticks and secure it to the windscreen top rail.
- (7) Secure the front support straps to the support stays at the top of the windscreen.
- (8) Secure the rear hood straps to the staples on the body and the side curtain straps to the front hood stick.
- (9) Pass the side ropes round the hooks at the front corners of the body, secure under the side hooks and, together with the rear ropes, which have been previously laced round the rear hood stick, to the hooks at the rear of the body.
- (10) Push the rear curtain side flaps through the side pockets and secure.

If it is desired to raise the rear curtain, release the side flaps and the curtain bottom rope. Fold in the flaps and roll the curtain into three folds; secure by means of the short straps sewn inside the curtain.

Checks

- 320.** The following points on the body should be checked:—
- (1) Check that nuts and screws securing the lock to the door are tight.
 - (2) Check that the bolts fixing the support bracket for striking plate are tight.
 - (3) Check that the door slightly compresses the rubber draught excluders when fully closed. If necessary, adjust the position of the striking plate by slackening the two securing bolts and nuts.
 - (4) Check bolts securing door hinges.
 - (5) Check the rear body securing bolts for tightness at the rear of chassis frame and at chassis brackets in front of the rear wheels.
 - (6) Check for tightness the bolts securing the front wings to the dash pillar, radiator grille, dash and wing stay.

- (7) Check for tightness the bolts securing the radiator grille panel to the chassis frame.

Fire Extinguisher

- 321.** The fire extinguisher is secured to the dash panel below the instrument panel. Ensure securing screws are tight.

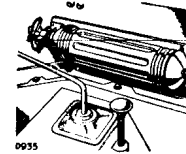

Fig. 131. Fire extinguisher

SECTION IV

FAULT-FINDING CHART

322. Although every precaution is taken to eliminate all possible causes of trouble, failure may occasionally develop through lack of attention to the equipment, or damage to the wiring. The following pages set out the recommended procedure for a systematic examination to locate and remedy the causes of some of the more probable faults which may occur during the life of the vehicle.

All the checks listed can be readily carried out without special equipment; if the fault is not located in this way, the vehicle should receive workshop attention.

ENGINE FAILS TO START

323. Proceed as follows:—

- (1) Check that the ignition is switched on.
- (2) Check that there is sufficient fuel in the tank.
- (3) Check that the cold start control is set correctly for starting (see para. 41).
- (4) Check that the engine is being turned at an adequate speed by the starter motor; this speed will be recognised after some experience with the vehicle.

If the cranking speed is too low:—

- (i) Check the battery connections for tightness and cleanliness.

- (ii) Check the state of charge of the batteries by switching on the headlights and pressing the starter button; if the headlights go out or are very dim when the starter is operated, the battery requires recharging. See para. 231.
- It should be possible to start the engine by cranking with the starting handle.
- (5) Remove the screened lead from each sparking plug terminal in turn and hold it so that the end is about $\frac{1}{4}$ in. (7 mm) away from some metal part of the chassis, while the engine is turned over; if sparks jump the gap regularly, the coil and distributor are functioning correctly.
 - (i) If the sparks are strong and regular, remove and clean the sparking plugs and reset the side electrode to give a .015 to .018 in. (0,38 to 0,45 mm) gap.
 - (ii) If the sparks are not regular:—
 - (a) Check that the distributor rotor is in position.
 - (b) Check that the L.T. connections on the coil and distributor are clean and tight.
 - (c) Check that the distributor points are:—
 1. Clean.
 2. Opening and closing correctly.
 3. Correctly set when open—gap .014 to .016 in. (0,35 to 0,40 mm).
 - (d) Check that current is present at the SW terminal on the coil, by disconnecting the wire at the coil end and touching it against the SW terminal, with the ignition switch on and the distributor contact-breaker points closed. If sparks occur, low tension current is flowing through the coil correctly; if there is no spark, either the coil or the low tension wiring is defective and the vehicle should receive workshop attention.
 - (iii) If the sparks are weak and in addition there is a flashing at the distributor contact breaker points, a faulty distributor condenser is indicated.
 - (iv) If the sparks are present on some leads, but not on others, check the distributor cap for cracks and the plug leads for damage.
 - (6) Disconnect the petrol pipe from the carburetter and check that petrol is delivered to the carburetter when the hand lever on the petrol pump is operated. If petrol is not delivered from the pipe:—
 - (i) Check that the petrol pipes and filters are clear.

- (ii) Check that there are no air leaks in the suction line to the petrol pump.
- (iii) Check that the diaphragm is not leaking and that the retaining screws are tight.

ENGINE STARTS BUT SOON STOPS

324. Check as detailed below:—
- (1) Check that the controls are set correctly (see para. 43).
 - (2) Check the fuel feed to the carburetter. See para. 323, item 6. If there is little or no flow:—
 - (i) Check the fuel level in the tank.
 - (ii) Check that the air vent in the filler neck is clear.
 - (iii) Check the fuel pump for correct operation (see para. 104).
 - (iv) Check that the fuel filters are clear.
 - (v) Check that the fuel pipes are clear (see para. 113).
 - (3) Check that the carburetter jets are clear, in the following order (para. 117):—
 - (i) Starter fuel jet.
 - (ii) Main jet.
 - (iii) Pilot jet.
 - (4) Check for a fault in the ignition circuit by connecting a wire between the ammeter and the SW connection on the coil, thus by-passing the ignition switch. At the same time the wire from the ignition switch must be disconnected from the coil.
 - (5) Remove the carburetter top cover and check that there is no water in the float chamber.

ENGINE MISFIRES

325. Engine running on less than four cylinders, either intermittently or continually.
- (1) Stop the engine and endeavour to re-start with the starter motor to check the state of the battery and connections. If the battery is in a low state of charge, the charging circuit should be checked as directed under charging circuit below

- (2) Remove the screened lead from each sparking plug in turn and check:—
- (i) By holding the end of the lead about $\frac{1}{4}$ in. (7 mm) away from a metal part of the engine with the engine running. Sparks should jump the gap regularly.
- If no spark is present on one or more cylinders:—
- (a) Check for moisture on the ignition system.
- (b) Check, clean and reset the distributor contact-breaker points to .014 to .016 in. (0.35 to 0.40 mm) as necessary.
- (c) Check the distributor cap for cracks and the plug leads for damage.
- If the spark is irregular on all cylinders:—
- (a) Check for moisture as in (i) (a).
- (b) Check the distributor points as in (i) (b).
- (c) Check the cap and leads as in (i) (c).
- (d) Check the L.T. connections for tightness and cleanliness
- (e) Check for flashing or "bluing" of the contact-breaker points. If present, the distributor condenser should be renewed.
- (f) Check for a fault in the ignition circuit by connecting a wire between the ammeter and the SW connection on the coil, thus by-passing the ignition switch. At the same time, the wire from the ignition switch must be disconnected from the coil.
- (ii) For any audible alteration in the running of the engine, as each screened lead is removed. No alteration will indicate that the sparking plug in question is at fault:—
- (a) Remove and clean the plug; reset the gap to .015 to .018 in. (0.38 to 0.45 mm) as necessary.
- (b) If still faulty, fit a new sparking plug.
- (3) If the "missing" is accompanied by "spitting back" through the carburetter, a valve may be sticking. This can often be cured by slowly dropping oil or upper cylinder lubricant into the carburetter intake, while the engine is running.

LACK OF ENGINE POWER

326. Check the following points:—
- (1) Check that the carburetter throttle is opening fully

- (2) Check that the brakes are not binding and that the tyre pressures are correct.
- (3) Check that the carburetter jets are not blocked (in the following order). See para. 117.
- (i) Main jet.
- (ii) Pump jet.
- (iii) Economy jet.
- (4) Check the ignition timing.
- (5) Check the tappet adjustment.
- (6) If items 1—5 are satisfactory, it is probable that the engine needs decarbonizing.

CHARGING CIRCUIT

327. Proceed as follows:—

(1) **Battery in low state of charge.**

- (a) This state will be shown by lack of power when starting, poor light from the lamps and hydrometer readings below 1.200, and may be due to the generator either not charging or giving low or intermittent output. Check the ammeter reading when the vehicle is running steadily in top gear with no lights in use; a definite steady charge should be indicated.
- (b) Examine the charging and field circuit wiring, tightening any loose connections, or replacing broken cables. Pay particular attention to the battery connections.
- (c) Examine the fan and generator driving belt; take up any undue slackness by turning the generator on its mounting (see para. 96).
- (d) If the cause of the trouble is not apparent, the vehicle should receive workshop attention.

(2) **Battery overcharged.**

- This will be indicated by burnt-out lamps, very frequent need for topping-up of battery and high hydrometer readings. This indicates that the regulator setting should be tested and adjusted.

STARTER MOTOR

328. Check points detailed below:—

(1) **Starter motor lacks power or fails to turn engine.**

- (a) See if the engine can be turned over by hand. If not, the cause of the stiffness of the engine must be located and remedied.
- (b) If the engine can be turned by hand, check that the trouble is not due to a discharged battery.
- (c) Examine the connections to battery, starter and starter switch, making sure that they are tight and that the cables connecting these units are not damaged.
- (d) It is also possible that the starter pinion may have jammed in mesh with the flywheel, although this is by no means a common occurrence. To disengage the pinion, pull off the dust cap and rotate the squared end of the starter shaft by means of a spanner.

(2) **Starter operates, but does not crank engine.**

This fault will occur if the pinion of the starter drive is not allowed to move along the screwed sleeve into engagement with the flywheel, due to dirt having collected on the screwed sleeve. Clean the sleeve carefully with kerosene.

(3) **Starter pinion will not disengage from flywheel when engine is running.**

Stop the engine and ascertain if the starter pinion is jammed in mesh with the flywheel. Release it, if necessary, by withdrawing the dust cap and rotating the squared end of the starter shaft in the opposite direction to normal rotation. If the pinion persists in sticking in mesh, the vehicle should receive workshop attention. Serious damage may result to the starter if it is driven by the flywheel.

LIGHTING CIRCUITS

329. Check the following points:—

(1) **Lamps give insufficient illumination.**

- (a) Test the state of charge of the battery, recharging it if necessary. See para. 231.
- (b) Check the setting of the headlights (see para. 257).
- (c) If the lamps are discoloured as a result of long service, they should be renewed.

(2) **Lamps light when switched on, but gradually fade out.**

As para. 1 (a).

(3) **Brilliance varies with speed of vehicle.**

- (a) As para. 1 (a).
- (b) Examine the battery connection, making sure that they are tight; replace faulty cables.

(4) **Lights flicker.**

Examine the circuits of the lamps for loose connections.

(5) **Failure of lights.**

- (a) As para. 1 (a).
- (b) Examine the wiring for a loose or broken connection and remedy.

**GOOD SERVICING IS ESSENTIAL FOR
SUCCESSFUL FORDING**

Fig. 132 Circuit diagram 40 amp generator

KEY TO CABLE COLOURS

B—BLACK	N—BROWN	R—RED	W—WHITE
G—GREEN	O—ORANGE	S—SLATE	Y—YELLOW
	P—PURPLE	U—BLUE	

When cables have two code letters, the first is the main colour and the second the tracer, i.e. RG—Red with Green
Circuits in dotted line are not fitted when the vehicle leaves the factory.

KEY TO WIRING DIAGRAM

- | | | |
|--|---|--|
| <p>142</p> <p>1 Vehicle batteries—two 12-volt</p> <p>2 Radio batteries—two 12-volt</p> <p>3 Radio ammeter</p> <p>4 Fuse for radio leads, at left-hand side of instrument panel</p> <p>5 Radio transmitter</p> <p>6 Horn</p> <p>7 Relay for horn</p> <p>8 Horn push-button</p> <p>9 Inspection sockets on instrument panel</p> <p>10 Panel illumination</p> <p>11 Panel illumination</p> <p>12 Sidelamp, RH</p> <p>13 Sidelamp, LH</p> <p>14 Convoy lamp</p> <p>15 Warner trailer socket, 4-pin</p> <p>16 Tail lamp, LH</p> <p>17 Number plate illumination</p> <p>18 Tail lamp, RH</p> <p>19 Headlight, RH main beam</p> <p>20 Headlight, LH main beam</p> <p>21 Warning light headlight main beam</p> <p>22 Headlight, LH, dip beam</p> <p>23 Headlight, RH, dip beam</p> <p>24 Stop lamp, RH</p> <p>25 Stop lamp, LH</p> <p>26 Starter solenoid switch</p> <p>27 Starter motor</p> <p>28 Vehicle ammeter</p> | <p>29 Starter switch on instrument panel</p> <p>30 Ignition and lighting switch, 6-way</p> <p>31 Oil pressure gauge illumination</p> <p>32 Panel light switch</p> <p>33 Headlight dip switch</p> <p>34 Stoplight switch</p> <p>35 Voltage regulator</p> <p>36 Fuses, A1-A2, A3-A4 on bulkhead engine side</p> <p>37 Generator</p> <p>38 Rectifier for generator</p> <p>39 Oil pressure warning light</p> <p>40 Filter unit for ignition coil</p> <p>41 Ignition coil</p> <p>42 Switch, mixture control (cold start)</p> <p>43 Warning light, mixture control (cold start)</p> <p>44 Extension lead for carburettor heater</p> <p>45 Switch for heater motor</p> <p>46 Fuel gauge</p> <p>47 LH switch for fuel gauge</p> <p>48 Fuel change-over switch</p> <p>49 RH switch for fuel gauge</p> <p>50 Screen wiper plug and socket</p> <p>51 Turnlight relay</p> <p>52 Turnlight unit</p> <p>53 Warning light, turnlight</p> <p>54 Turnlight, RH rear</p> <p>55 Turnlight, LH rear</p> | <p>56 Turnlight, RH front</p> <p>57 Turnlight, LH front</p> <p>58 Switch, turnlight</p> <p>59 Interior lights</p> <p>60 Switch, interior lights</p> <p>61 Fuse interior lights and auxiliary feed to NATO socket at bulkhead engine side</p> <p>62 Switch, oil pressure warning light</p> <p>63 Distributor</p> <p>64 Thermostat switch, mixture control (cold start)</p> <p>65 Heater motor</p> <p>66 Fuel gauge, RH fuel tank</p> <p>67 Fuel gauge, LH fuel tank</p> <p>68 Screen wiper</p> <p>69 Screen wiper</p> <p>70 'K' auxiliary</p> <p>71 'D' earth, vehicle</p> <p>72 'L' earth, trailer</p> <p>73 'N' turnlight, trailer, RH</p> <p>74 'M' turnlight, trailer, LH</p> <p>75 'P' spare</p> <p>76 'C', 'A', 'H' Convoy</p> <p>77 'E' tail light</p> <p>78 'J', 'B' stop light</p> <p>79 Snap connector</p> <p>80 Earth connection</p> |
|--|---|--|

Amdt. No. 1 and 4

NATO trailer socket 12-pin

CIRCUIT DIAGRAM, 40 AMP GENERATOR

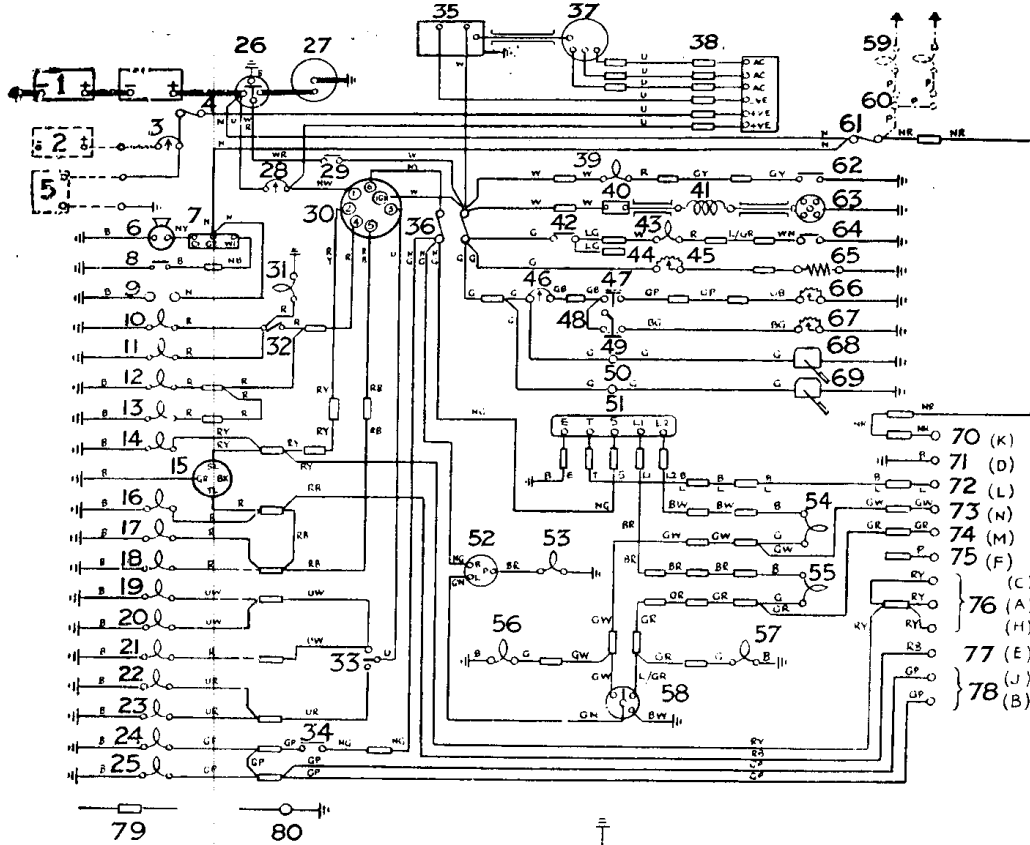

E787

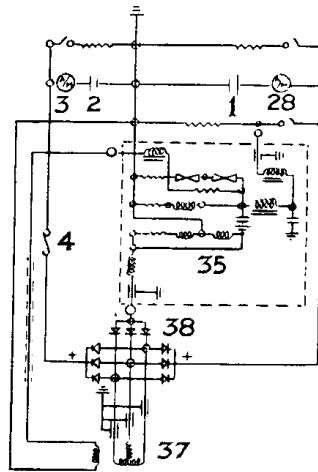

Fig. 132 Circuit diagram 40 amp generator

KEY TO CABLE COLOURS

B—BLACK	N—BROWN	R—RED	W—WHITE
G—GREEN	O—ORANGE	S—SLATE	Y—YELLOW
	P—PURPLE	U—BLUE	

When cables have two code letters, the first is the main colour and the second the tracer, i.e. RG—Red with Green
Circuits in dotted line are not fitted when the vehicle leaves the factory.

APPENDIX 1

CROSS-REFERENCES TO SERVICING OPERATIONS

The 'Op. No.' in the table below refers to operation numbers in the Servicing Schedule contained in the Vehicle Log Book.

Against the operation numbers are the numbers of the paragraphs in this Handbook describing how the operations will be carried out and the Fig. Nos. of the appropriate illustrations.

<i>Op. No.</i>	<i>Para. No.</i>	<i>Fig. No.</i>	<i>Op. No.</i>	<i>Para. No.</i>	<i>Fig. No.</i>
1	90 (23)	44	26	149, 160	65, 67
2	90 (23)	37	27	163	68
3	84 (5), (6)	—	30	171	72
4	172	—	31	—	—
5	200 (1)	72	32	180	76
6	—	—	33	—	—
7	—	—	34	—	46
11	89	43	38	115	—
12	223	89	39	103	50
13	216, 218	87	40	—	—
14	96 (2)	47	41	—	—
15	—	—	42	—	—
16	185, 191	—	46	146	62
17	128	57	47	—	—
18	177	—	48	145	62
22	81, 82	37	49	—	33
23	107	51	53	127	—
24	135	60	54	—	—
25	142	—	55	187	—

CIRCUIT DIAGRAM, 90 AMP GENERATOR

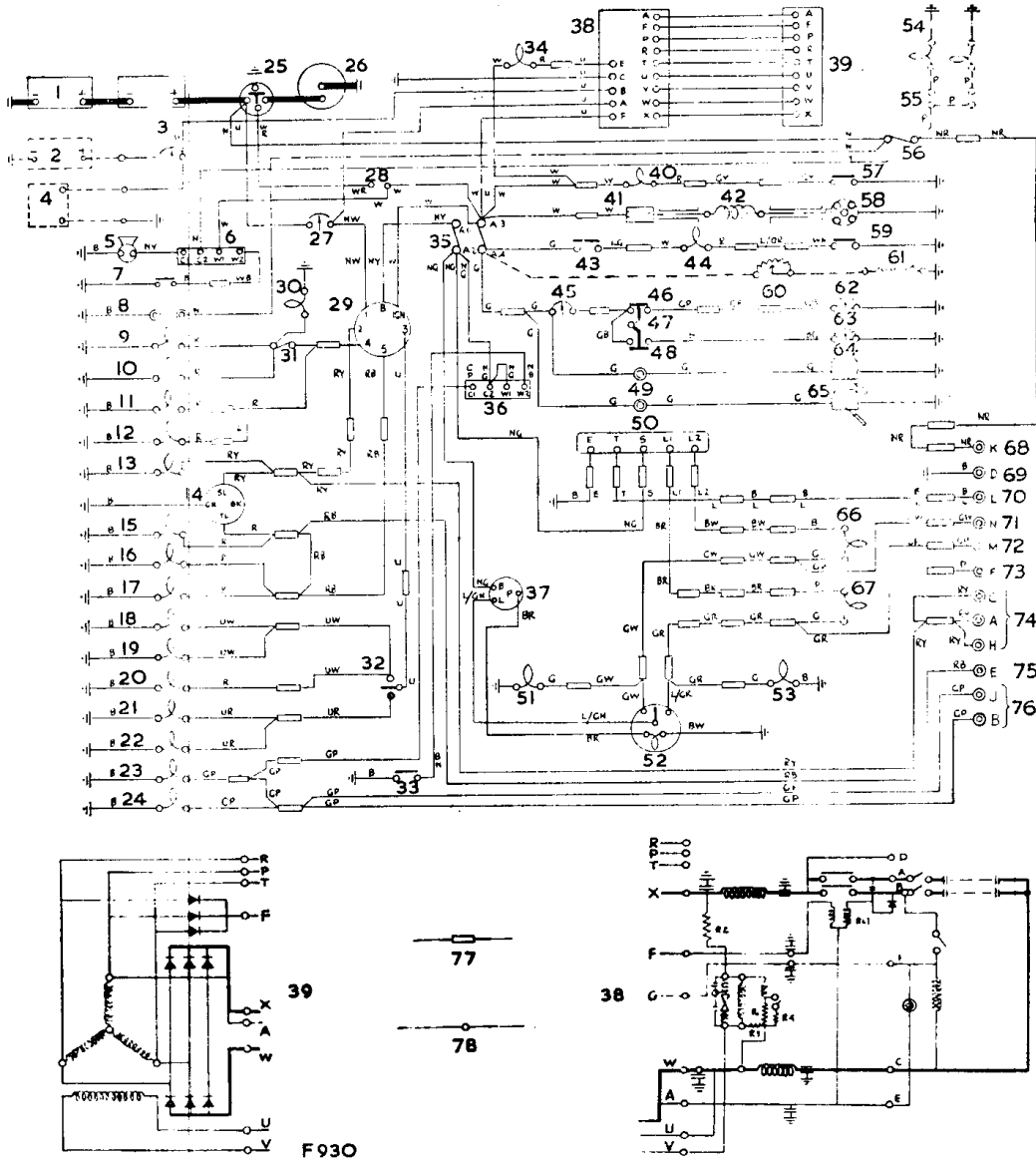

Fig. 132A. Circuit diagram 90 amp generator

KEY TO CABLE COLOURS

B—BLACK	N—BROWN	R—RED	W—WHITE
G—GREEN	O—ORANGE	S—SLATE	Y—YELLOW
	P—PURPLE	U—BLUE	

When cables have two code letters, the first is the main colour and the second the tracer, i.e. RG—Red with Green.
Circuits in dotted line are not fitted when the vehicle leaves the factory.

KEY TO CABLE COLOURS

B—BLACK
G—GREEN

N—BROWN
O—ORANGE
P—PURPLE

R—RED
S—SLATE
U—BLUE

W—WHITE
Y—YELLOW

When cables have two code letters, the first is the main colour and the second the tracer, i.e. RG—Red with Green.
Circuits in dotted line are not fitted when the vehicle leaves the factory.

KEY TO WIRING DIAGRAM

- | | | |
|---|---|--|
| <p>1. Vehicle batteries—two 12 volt
2. Radio batteries—two 12 volt
3. Radio ammeter
4. Radio transmitter
5. Horn
6. Relay for horn
7. Horn push-button
8. Inspection sockets on instrument panel
9. Panel illumination
10. Panel illumination
11. Sidelight R.H.
12. Sidelight L.H.
13. Convoy light
14. Warner trailer socket, 4-pin
15. Taillight L.H.
16. Number plate light
17. Taillight R.H.
18. Headlight, R.H. main beam
19. Headlight, L.H. main beam
20. Warning light, headlight main beam
21. Headlight, L.H. dip beam
22. Headlight, R.H. dip beam
23. Stoplight R.H.
24. Stoplight L.H.
25. Starter solenoid switch
26. Starter motor
27. Vehicle ammeter</p> | <p>28. Starter switch on instrument panel
29. Ignition and lighting switch, 6-way
30. Oil pressure gauge illumination
31. Panel light switch
32. Headlight dip switch
33. Stoplight switch
34. Warning light, ignition
35. Fuses, A1-A2, A3-A4 on bulkhead engine side
36. Stoplight relay
37. Turnlight unit
38. Generator panel
39. Generator
40. Oil pressure warning light
41. Filter unit for ignition coil
42. Ignition coil
43. Switch, mixture control (cold start)
44. Warning light, mixture control (cold start)
45. Fuel gauge
46. L.H. switch for fuel gauge
47. Fuel changeover switch
48. R.H. switch for fuel gauge
49. Screen wiper plug and socket
50. Turnlight relay
51. Turnlight, R.H. front
52. Turnlight switch and warning light</p> | <p>53. Turnlight, L.H. front
54. Interior lights, where fitted
55. Switch, interior lights, where fitted
56. Fuse
57. Switch, oil pressure warning light
58. Distributor
59. Thermostat switch, mixture control (cold start)
60. Switch for heater } where
61. Vehicle heater } fitted
62. Fuel gauge, R.H. fuel tank
63. Fuel gauge, L.H. fuel tank
64. Screen wiper
65. Screen wiper
66. Turnlight, R.H. rear
67. Turnlight, L.H. rear
68. 'K' auxiliary
69. 'D' carb, vehicle
70. 'L' carb, trailer
71. 'N' turnlight, trailer, R.H.
72. 'M' turnlight, trailer, L.H.
73. 'F' spare
74. 'C', 'A', 'H' convoy
75. 'E' taillight
76. 'J', 'B' stoplight
77. Snap connector
78. Earth connection</p> |
|---|---|--|

NATO
trailer
socket,
12-pin