



**SUZUKI**

**SUZUKI MOTOR CO., LTD.**

Part No. 99011-63600

Printed in Japan '74-2/7  
'75-6

**SUZUKI**  
OWNER'S  
MANUAL

LJ50

LJ50V



## CONGRATULATIONS

You are now the owner of the Suzuki LJ50 or LJ50V, a sensational mini-car from Japan.

Suzuki LJ50 and LJ50V are unique cars which run not only town street but also rough road, for example - sands and mountains etc., and gives play to motive power at such places.

We are pleased to present you this manual as a guide to daily care and maintenance of the Suzuki LJ50 and LJ50V. For further information, please contact your Suzuki dealer.

** SUZUKI MOTOR CO., LTD.**

# CONTENTS

SPECIFICATIONS . . . . .	4
IDENTIFICATION AND KEY . . . . .	8
BREAKING-IN . . . . .	9
TRANSFER GEARING MECHANISM . . . . .	10
SUZUKI CCI LUBRICATIION SYSTEM . . . . .	11
PARTS IDENTIFICATION . . . . .	12
CONTROLS	
Control layout . . . . .	14
Meters . . . . .	15
Switches . . . . .	16
Driving related instruments . . . . .	19
Indicator lamps . . . . .	23
Miscellaneous . . . . .	24
FLUID RECOMMENDATIONS	
Coolant supply and change . . . . .	34
Refill of oil and other fluids . . . . .	37
AIDS FOR SAFE, COMFORTABLE DRIVING	
Daily overall check-up . . . . .	40
TIPS ON DRIVING . . . . .	48

## DO-IT-YOURSELF MAINTENANCE

Tool kit . . . . .	55
Sparkplug . . . . .	56
Air cleaner . . . . .	57
Main fuse . . . . .	57
Fuse box . . . . .	57
Bulb replacement . . . . .	58
Tire . . . . .	61
Soft top and canvas door removal (LJ50) . . . . .	63
Cleaning the car . . . . .	65
Hints for protecting the finish . . . . .	67
Safe keeping . . . . .	68
Notice . . . . .	69

## TROUBLE SHOOTING AND EMERGENCY REPAIRS

First of all, if . . . . .	70
When the starter motor fails to work . . . . .	70
In case the starter works, but the rpm are too slow, a discharged battery is to blame . . . . .	70
While the starter works, the engine fails to start . . . . .	71
Engine power is weak and acceleration is poor . . . . .	72
The brake is a little strange . . . . .	72
Overheat . . . . .	73
Notice . . . . .	74

LUBRICATION CHART . . . . .	76
-----------------------------	----

PERIODIC INSPECTION CHART . . . . .	78
-------------------------------------	----

WIRING DIAGRAM . . . . .	80
--------------------------	----

TIGHTENING TORQUE OF IMPORTANT PARTS . . . . .	82
--	----

# SPECIFICATIONS

	<u>LJ50</u>	<u>LJ50V</u>
<b><u>DIMENSIONS</u></b>		
Overall length	3,180 mm (125.2 in)	3,025 mm (119.1 in)
Overall width	1,295 mm (51.0 in)	←
Overall height	1,710 mm (67.3 in)	1,660 mm (65.4 in)
		*1,690 mm ( 66.4 in)
Wheelbase	1,930 mm (76.0 in)	←
Road clearance	240 mm ( 9.4 in)	210 mm ( 8.3 in)
		* 240 mm ( 9.4 in)
Tires front	6.00-16-4PR	5.60-15-4PR
		* 6.00-16-4PR
rear	6.00-16-4PR	5.60-15-4PR
		* 6.00-16-4PR
Tread front	1,090 mm (42.9 in)	←
rear	1,100 mm (43.3 in)	←
Weight	700 kg (1,543 lb)	730 kg (1,609 lb)
		* 740 kg (1,628 lb)
<b><u>PERFORMANCE</u></b>		
Maximum horse power	33.0 Hp at 5,500 rpm	←
Maximum torque	5.85 kg-m (41.6 ft-lb) at 3,500 rpm	←
Climbing ability	$\tan \theta = 0.74, \theta = 37^\circ$	$\tan \theta = 0.681, \theta = 34^\circ$ * $\tan \theta = 0.75, \theta = 37^\circ$
Braking distance	14.0 m at 50 kph (45.0 ft at 31 mph)	←
<b><u>ENGINE</u></b>		
Type	2-cycle, water cooled gasoline engine	←
Number of cylinders	Three, in line	←
Bore	61 mm (2.40 in)	←
Stroke	61.5 mm (2.42 in)	←
Piston displacement	539 cc (32.9 cu-in)	←
Correct compression ratio	6.0	←
<b><u>FUEL SYSTEM</u></b>		
Carburetor	VCI 30-25	←
Air cleaner	Wet polyurethane	←
Fuel tank capacity	30 ℓ (7.93/6.60 US/Imp gal)	←

LJ50LJ50VLUBRICATION SYSTEM

Engine	Suzuki CCI system	←
Oil tank capacity	3.4 ℓ (7.18/6.04 US/Imp pt)	←
Transmission case oil	1,000 cc (2.12/1.76 US/Imp pt)	←
Transfer case oil	900 cc (1.90/1.60US/Imp pt)	←
Axle shaft oil	1,300 cc (2.75/231 US/Imp pt)	←

COOLING SYSTEM

Type	Water cooled, pressure forced circulation	←
Radiator	Corrugated fin the tube pressure type	←
Water pump	Centrifugal type, V-belt drive	←
Thermostat	Wax pellet element type	←
Coolant amount	3.5 ℓ (7.40/6.21 US/Imp pt) including 0.6 ℓ (1.27/1.07 US/Imp pt) reserve at full level	←

IGNITION SYSTEM

Ignition	Battery	←
Ignition timing	8° B.T.D.C.1,000 rpm and below	←
Spark plug	NGK B-7HS or NIPPON DENSO W22FS	←

TRANSMISSION

Clutch	Dry, single disc	←
Transmission gears	4-speed forward, all synchromesh, 1 reverse	←
Gear ratio		
Low	3.835 (30/14 x 34/19)	←
2nd	2.359 (29/22 x 34/19)	←
3rd	1.524 (23/27 x 34/19)	←
Top	1.000	←
Reverse	4.026 (27/12 x 34/19)	←
Final reduction ratio	4.875 (39/8)	←
Transfer gears	2-speed	←

	<u>LJ50</u>	<u>LJ50V</u>
Gear ratio		
H	1,714 (24/29 x 29/14)	← * 1,563 (25/27 x 27/16)
L	3,012 (32/22 x 29/14)	← * 2,571 (32/21 x 27/16)
Overall reduction ratio	"H"position "L"position	"H"position "L"position
Low	32.046 56.324	←
2nd	19.713 34.603	←
3rd	12.739 22.391	←
Top	8.537 14.638	←
Reverse	33.648 59.140	←
Low		*29.209 *48.069
2nd		*17.945 *29.532
3rd		*11.612 *19.107
Top		* 7.617 *12.536
Reverse		*30.669 *50.473

### SUSPENSION

Suspension		
Front	Semi-elliptic, leaf spring	←
Rear	Semi-elliptic, leaf spring	←
Shockabsorber		
Front	Telescopic, double action	←
Rear	Telescopic, double action	←

### STEERING

Type	Ball screw nut type	←
Steering angle		
Inner	30°	←
Outer	26°	←
Toe-in	5 mm (0.20 in)	←
Camber	1°	←
Caster	30'	←
King pin angle	9°	←
Turning radius	4.6 mm (15.3 ft)	←



LJ50LJ50VBRAKES

Foot brake	Hydraulic, four wheels	←
Parking brake	Mechanical, propeller shaft	←
Brake shoes		
Front	2-leading	←
Rear	Leading and trailing	←

CARRYING CAPACITY

Height of load deck from ground	640 mm (25.2 in)	610 mm (24.0 in)
Size of load deck (L x W x H)	930 x 1,205 x 1,040 mm (36.6 x 47.4 x 40.9 in)	* 640 mm (25.2 in)
Maximum load	250 kg (550 lb)	820 x 1,160 x 865 mm (32.3 x 45.7 x 34.1 in)
Seat	2 persons	220 kg (440 lb)

ELECTRICAL EQUIPMENT

Generator	12V	35	A	←
Starting motor	12V	600	W	←
Battery	12V	35	A·H	←
Front turn signal lamp	12V	23	W	←
Front parking lamp	12V	3.4	W	←
Side turn signal lamp	12V	6	W	←
Rear turn signal lamp	12V	23	W	←
Tail/brake lamp	12V	8/23	W	←
Parking lamp	12V	3.4	W	←
Back-up lamp	12V	10	W	←
License lamp	12V	10	W	←
Room lamp	12V	5	W	←
Head lamp	12V	50/40	W	←
Positioning lamp	12V	8	W	←

\* Mark shows the specifications for LJ50V equipped with tires of 6.00 - 16, 4PR

These specifications subject to change without notice.

# IDENTIFICATION AND KEY

## IDENTIFICATION PLATE

On opening the front hood you will notice a number impressed on the chassis. This number is particular to your new LJ50 or LJ50V, and is used by SUZUKI for all after-sale service. Whenever you have occasion to consult your SUZUKI dealer or agency, remember to use this number. Should you find the number difficult to read, note the identification plate attached to the raised area next to it. Your chassis number also appears on this plate.

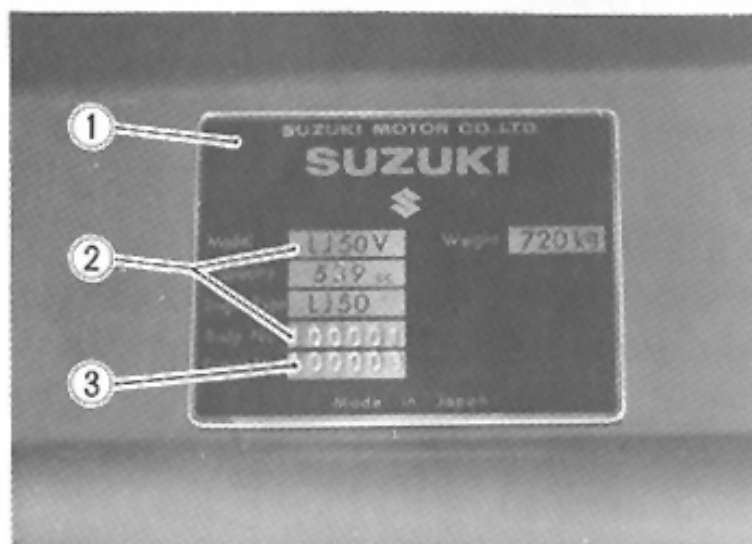

## KEY

You need two or three keys to operate your vehicle. As the company cannot sell just a car key, take good care of both keys.



### 1. Identification plate

Chassis type, Engine type,  
Weight and Piston displacement

### 2. Chassis type and number

### 3. Engine type and number

### 4. Ignition switch key

Tail gate and door lock key (LJ50V)

Globe compartment lid lock key (LJ50)

### 5. Parking brake lever lock key (LJ50)

Fuel tank cap lock key



# BREAKING-IN

In the process of manufacture the best possible materials are used and all machines parts are finished to a very standard but it is still necessary to allow the moving parts to "BRAKING-IN" before subjecting the engine to maximum stresses. The future performance and reliability of the engine depends on the care and restraint exercised during its early life. The general rules are as follows.

Transfer gear is in "Normal" or "H" position:

Mileage	Maximum recommended speeds			
	Low	Second	Third	Top
Initial 1,000 km (600 miles)	10 mph 15 kph	16 mph 25 kph	25 mph 40 kph	35 mph 55 kph
Up to 3,000 km (1,800 miles)	Speed limits may be gradually increased up to the maximum rates speeds			

Transfer gear is in "L" position:

Mileage	Maximum recommended speeds			
	Low	Second	Third	Top
Initial 1,000 km (600 miles)	2 mph 4 kph	8 mph 12 kph	12 mph 20 kph	20 mph 30 kph
Up to 3,000 km (1,800 miles)	Speed limits may be gradually increased up to the maximum rated speeds.			

- \* Never exceed the braking-in speeds indicated above.
- \* Never drive at the maximum speeds recommended above for long stretches, especially on climbs.
- \* After starting, do not race the engine, warm up gradually.

# TRANSFER GEARING MECHANISM

The "transfer gearing" is a term given to the auxiliary transmission adopted for carrying the drive torque to all the drive wheels.

The transfer gear assembly installed on the Suzuki LJ50 and LJ50V consists of the 2-speed gear box and all-wheel drive system including 3-shaft parallel constant mesh gears. The 2-speed gear box permits selection of high and low speeds while the all-wheel drive system permits switching of rear wheel drive and all wheel drive.

Both the 2-speed gear box and all wheel drive system are controlled by means of single transfer gear control lever positioned near the floor tunnel in the cabin.

## OPERATION OF TRANSFER GEARING

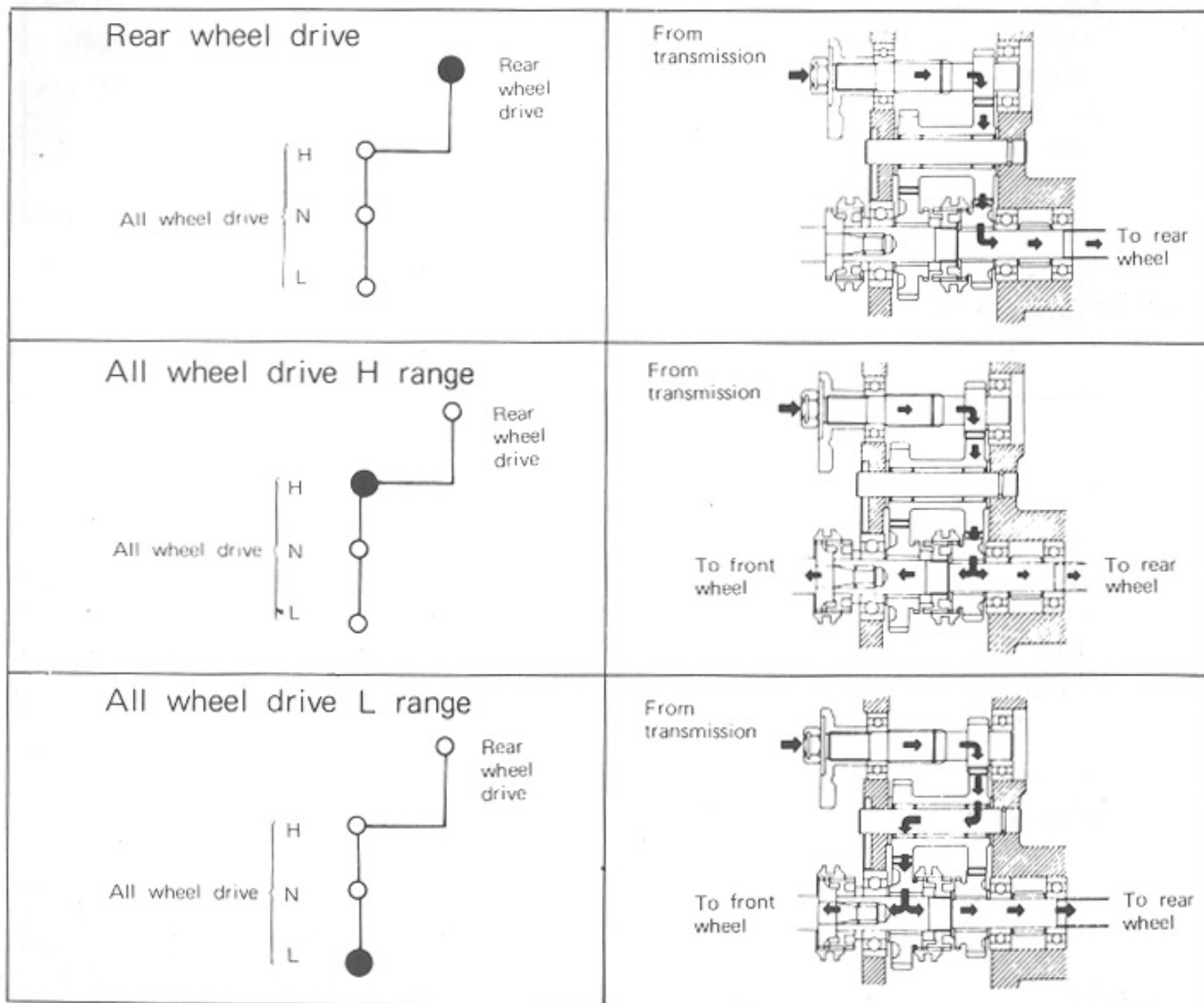

# SUZUKI CCI LUBRICATION SYSTEM

The Suzuki CCI lubrication system as used in the LJ50 and LJ50V is one of the world's most advanced lubrication systems for two-cycle engine.

This system has been developed by many years of experience in the two-cycle field and has reached its present high level of dependability due to a program of continuous refinement and testing. In the "CCI" lubrication system, the oil is fed by the oil pump to the crankshaft bearings, connecting rod bigs and small end bearings, the piston surface and cylinder walls.

The amount of oil fed to these areas is regulated by the oil pump control lever which is controlled by engine speed and amount of throttle opening.

Since the engine is constantly lubricated by a fresh charge of oil which is properly regulated to meet all operating conditions, the "CCI" system assures that proper lubrication for high performance and clean engine operation is always maintained.

This result in less carbon build-up and less exhaust smoking than was previously possible when troublesome pre-mixing of gasoline and oil was necessary.

# PARTS IDENTIFICATION

## FRONT (LJ50)

1. Windshield wiper
2. Rear view mirror
3. Engine hood hook shaped grip
4. Engine hood
5. Canvas door handle
6. Side turn signal lamp
7. Front parking lamp
8. Front towing hook
9. Headlamp
10. Front turn signal lamp



## REAR (LJ50)

11. Rear turn signal/parking lamp
12. Tail/Brake lamp
13. Back-up lamp
14. Rear towing hook
15. Fuel tank cap
16. Rear gate handle

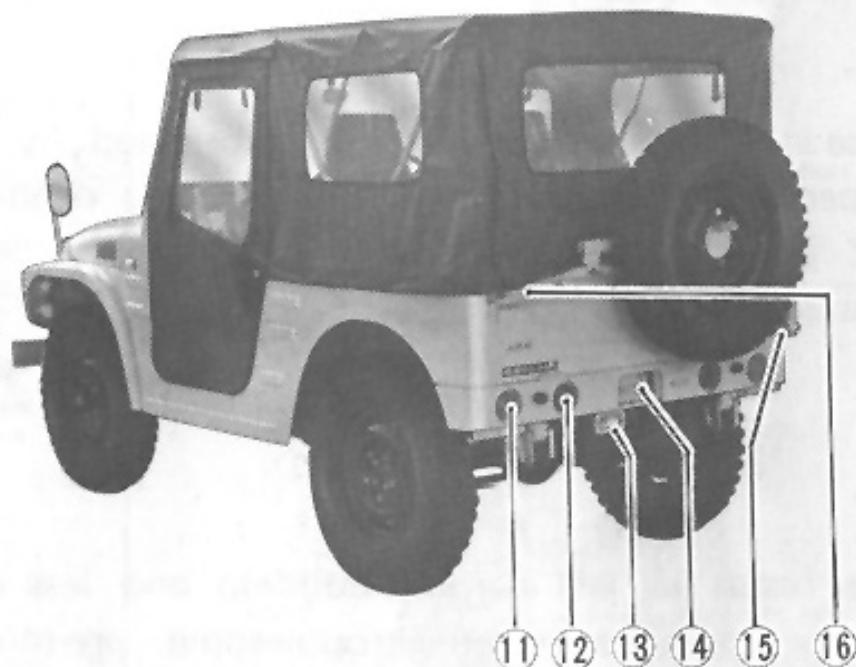

## FRONT (LJ50V)

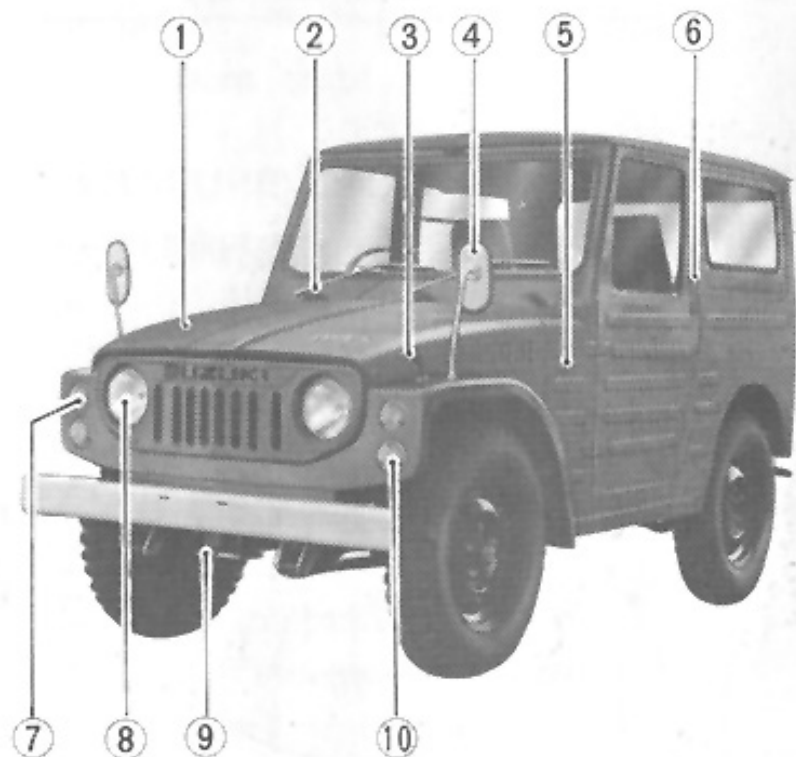

1. Engine hood
2. Windshield wiper
3. Engine hood hook shaped grip
4. Rear view mirror
5. Side turn signal lamp
6. Side door handle
7. Front turn signal lamp
8. Headlamp
9. Front towing hook
10. Front parking lamp

## REAR (LJ50V)

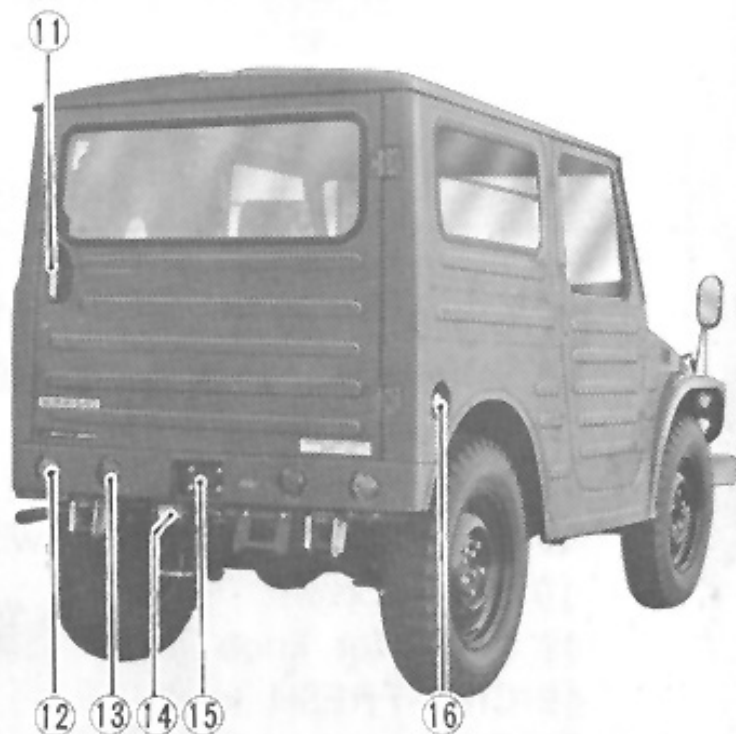

11. Rear gate handle
12. Rear turn signal/parking lamp
13. Tail/Brake lamp
14. Back up lamp
15. Rear towing hook
16. Fuel tank cap

# CONTROLS

## CONTROL LAYOUT

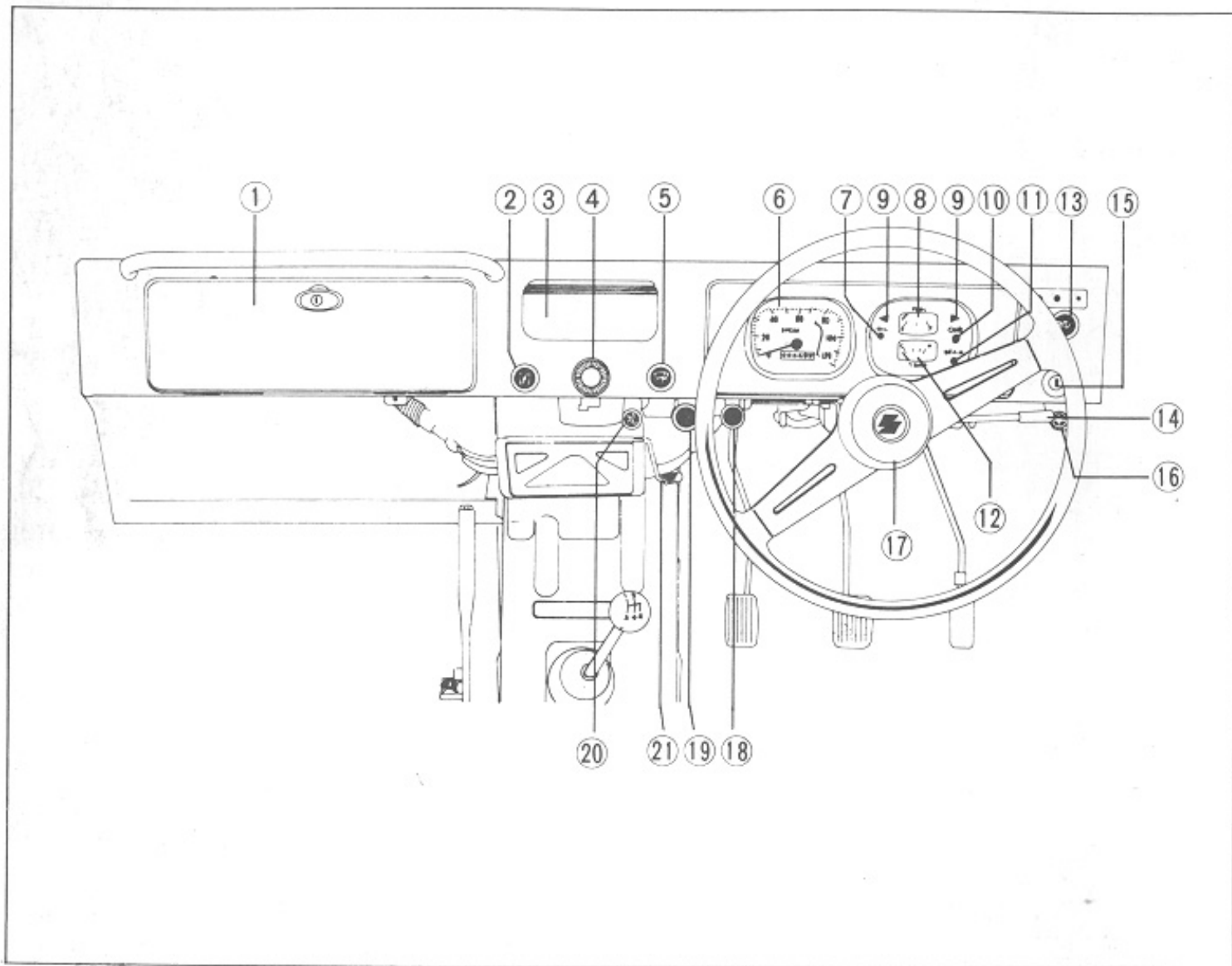

- |                                   |   |
|-----------------------------------|---|
| ① Glove compartment lid           | ⑫ Temperature gauge                             |
| ② Choke control knob              | ⑬ Lighting switch                               |
| ③ Ashtray                         | ⑭ Self-cancelling turn signal and dimmer switch |
| ④ Windshield washer               | ⑮ Ignition switch                               |
| ⑤ Windshield wiper switch         | ⑯ Hazard warning flasher switch                 |
| ⑥ Speedometer                     | ⑰ Horn button                                   |
| ⑦ Engine oil level indicator lamp | ⑱ Ventilator knob                               |
| ⑧ Fuel gauge                      | ⑲ CIRC-FRESH knob                               |
| ⑨ Turn signal indicator lamp      | ⑳ Blower switch knob                            |
| ⑩ Charging indicator lamp         | ㉑ Defroster control lever                       |
| ⑪ High beam indicator lamp        |   |



## METERS

### FUEL GAUGE

When the ignition switch is on, this gauge indicates the amount of gasoline in the tank. "F" stands for full and "E" means empty.

### TEMPERATURE GAUGE

Water temperature will be indicated immediately after the ignition has been turned on. From engine turnover to departure, the gauge indicator will register a temperature of about 122° F (50° C). While you are driving it will vary but should remain within the normal, acceptable temperature range. If the indicator exceeds this range and veers toward "H", overheating is indicated.

### SPEEDOMETER

The speedometer records road speed in miles per hour or kilometers per hour.

### ODOMETER

The odometer registers the total distance the LJ50 or LJ50V has been driven.

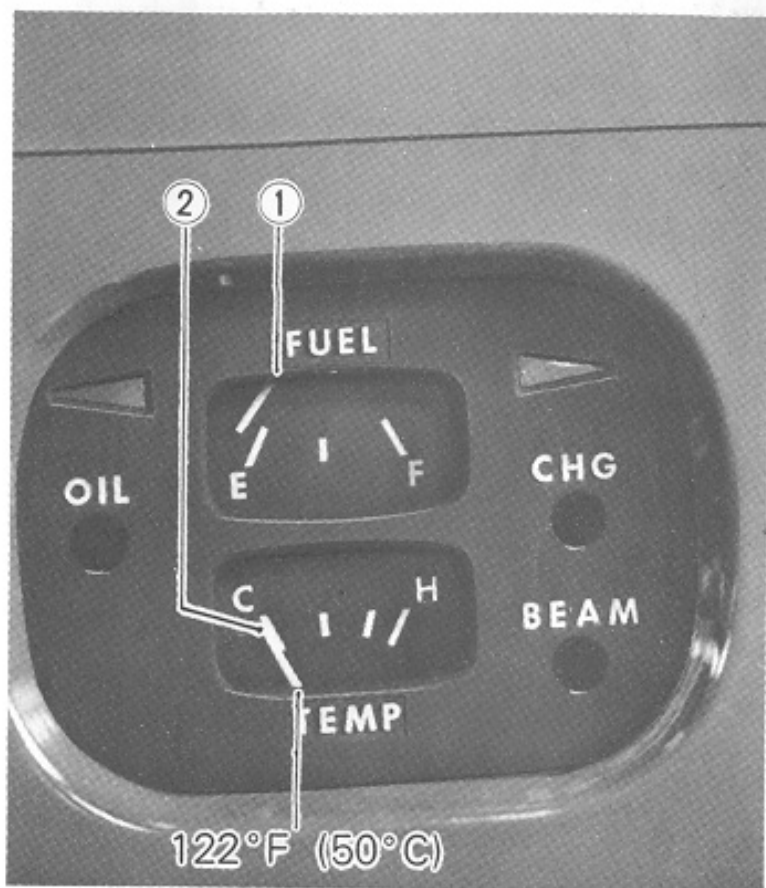

- ① Fuel gauge
- ② Temperature gauge

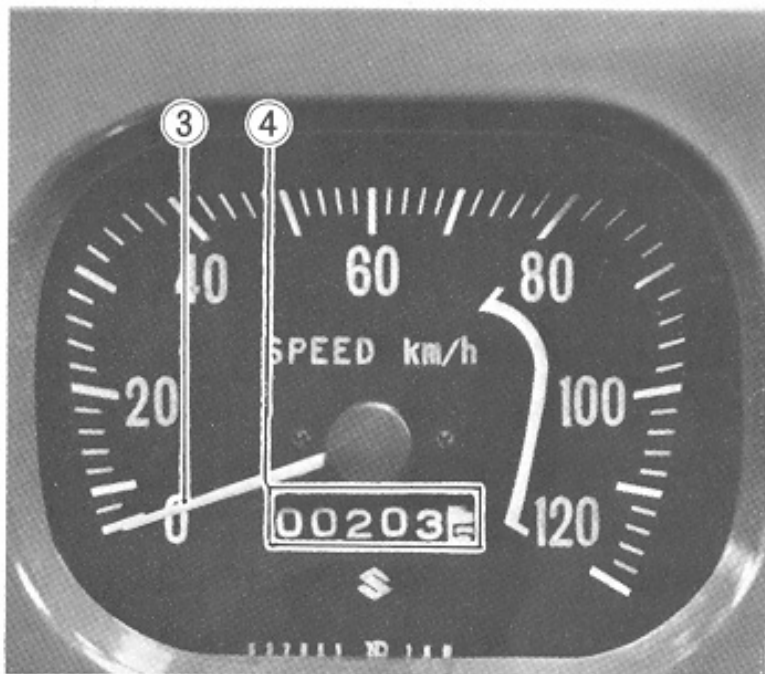

- ③ Speedometer
- ④ Odometer

## SWITCHES

### IGNITION SWITCH

This switch serves as the main switch and the starter switch.

\* **On:**

The position at which the engine is ready to turn over and the electric system is operative. Do not leave the switch at this position for prolonged period.

\* **Start:**

At the position the starter motor starts the engine. Remove your hand the moment the engine starts.

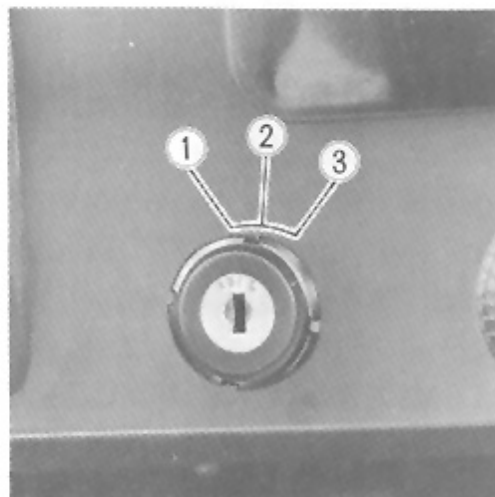

- ① Stop
- ② On
- ③ Start

### LIGHTING SWITCH

The lighting switch is pulled in two stages. Pull the switch to the first stage to switch on the all small lights, taillights, number-plate light and dashboard meter lights.

If you pull up two steps from the original position, the headlights, number-plate light and dashboard meter lights will go on.

If you return the switch to the original position and then turn it to clockwise, the front and rear auxiliary parking lamps are turned on.

④ **Lighting switch**

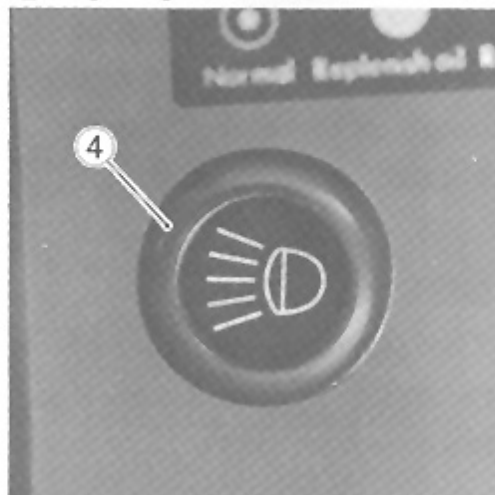

### TURN-SIGNAL AND HIGH-LOW BEAM LEVER

\* **Turn signal:**

With the ignition switch at "ON" move the lever up or down, as illustrated, for directional signals. Move the lever upward for a right-turn signal. Once the turn has been executed, the lever will return to the initial position.

\* **High-low beam**

Pulling the lever toward you will switch the headlight's from high beam to low beam (dimmer) and vice versa.

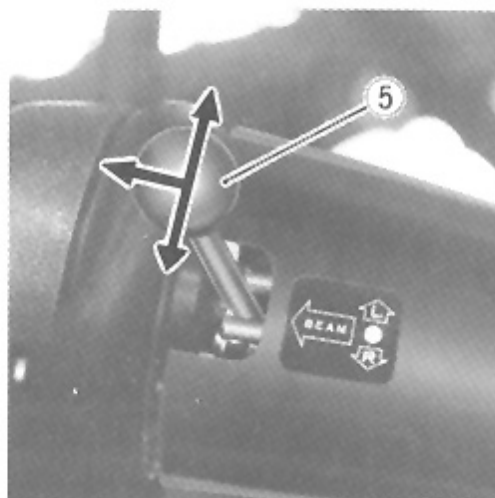

- ⑤ **Turn signal and High-low beam lever**

## 4-WAY FLASHER SWITCH

Use this 4-way flasher as a warning light to prevent a rear-end collision when emergency parking is necessary.

**NOTE:** Do not use this switch in any case other than an emergency.

⑥ 4-way flasher switch

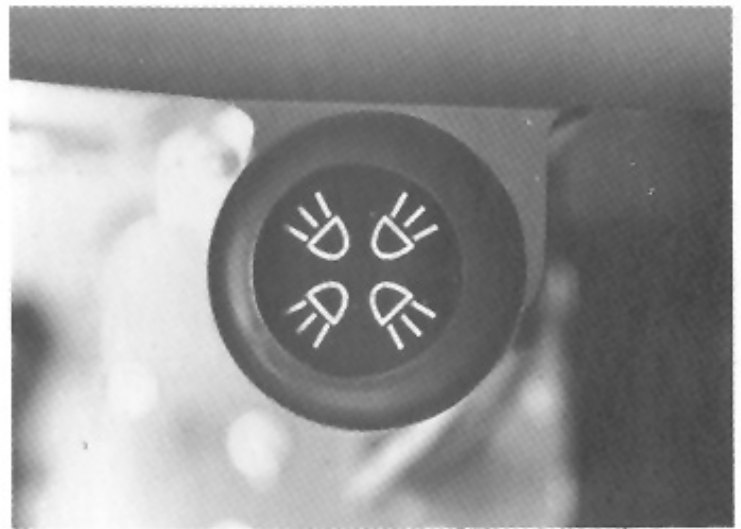

## WINDSHIELD WIPER SWITCH

Definitely use the windshield washer to help keep the windshield clean. The windshield wipers are operated by pulling out the switch.

⑦ Windshield wiper switch

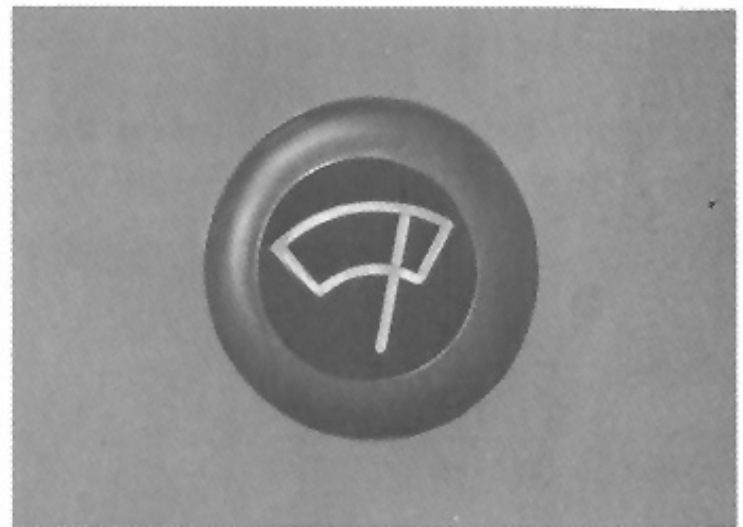

**NOTE:** Using the wipers only to clean dirt away is not good for windshield.

## BLOWER SWITCH (Only for a vehicle provided heater unit)

This knob operates the blower in two stages.

- I position : blower switch off
- II position : blower running at half speed
- III position : blower running at full speed

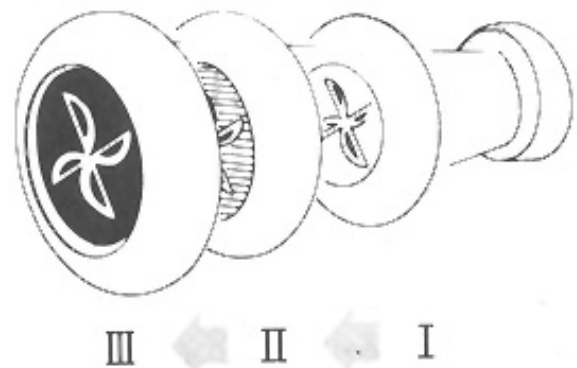

**NOTE:** In order to prevent engine overcooling, the blower does not operate while a pointer of the temperature indicator is below "C" mark.

## ROOM LAMP

It is turned on or off by a switch which is provided under the room lamp housing.

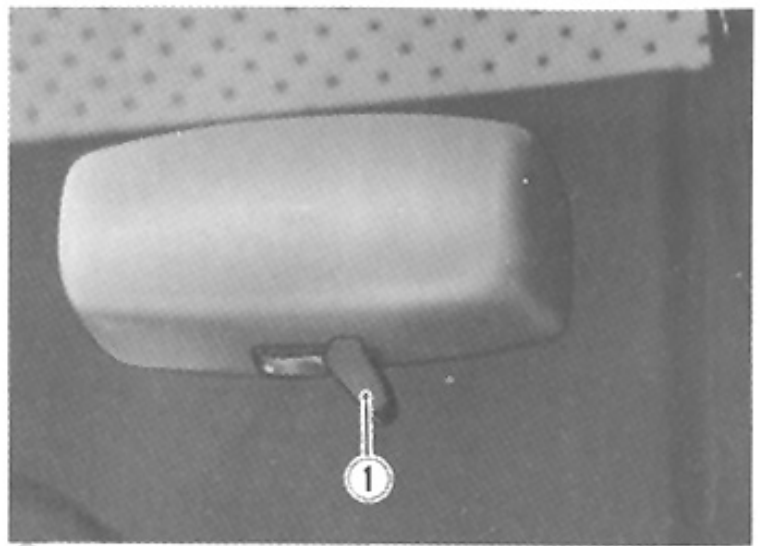

① Room lamp switch

## HORN

The horn is sounded by pressing the center pad of the steering wheel.



② Horn

## DRIVING RELATED INSTRUMENTS

### CHOKE KNOB

The carburetor starter system gives easy starts even in cold weather by supplying a rich fuel/air mixture to the engine. When starting a cold engine, pull out the choke knob. Be sure to return it to its original position when the engine warms up and your LJ50 or LJ50V is run. Do not open the throttle when this knob is pulled. If the accelerator pedal is depressed even a small amount, the engine becomes hard to start. When engine is already warm, operation of choke knob is not necessary.

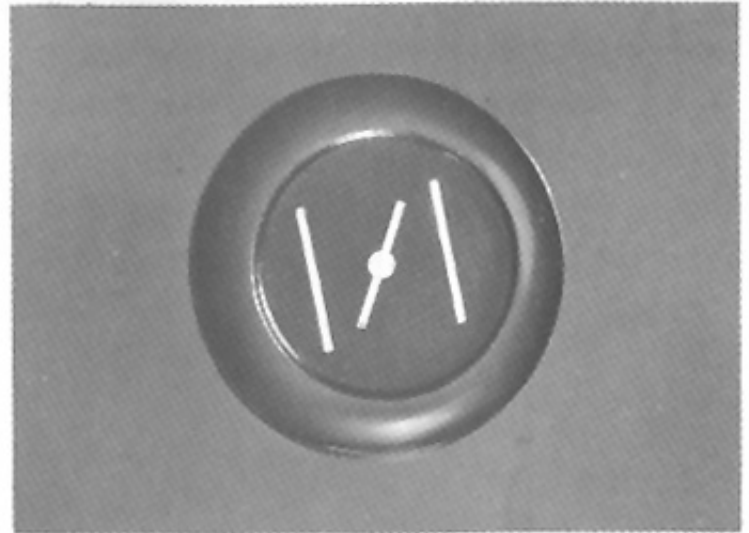

③ Choke knob

### ACCELERATOR PEDAL

Engine speed is controlled by accelerator pedal. If the pedal is depressed, engine speed rises. A slow, gentle application of pressure is the key to good accelerator pedal control. Quick, jerky action will simply waste fuel.

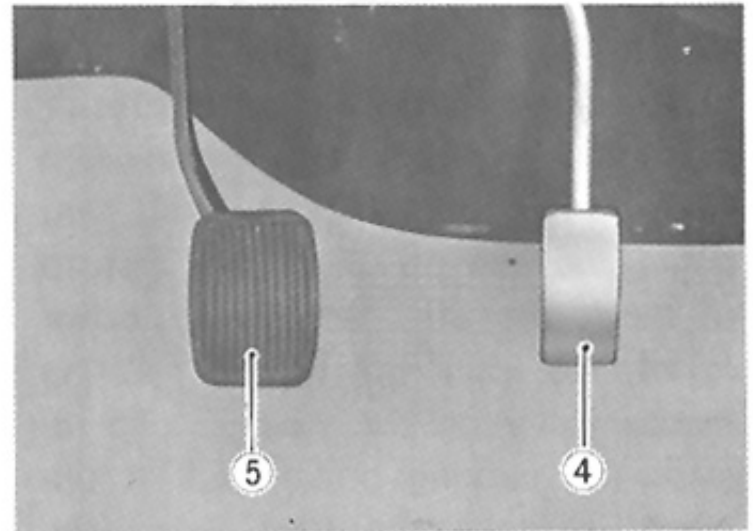

④ Accelerator pedal

⑤ Brake pedal

### BRAKE PEDAL

When bringing the car to a stop, apply pressure to the brake pedal briefly a number of times, rather than all at once. Rough, heavy use of the brake pedal is not good for the brakes and may also lead to a dangerous skid. When the brake pedal is depressed, the stop lamp lights and braking forces are applied to the front and rear wheels.

## CLUTCH PEDAL

The clutch pedal is used to disengage the crankshaft with the countershaft, when starting or shifting the transmission gears. Depressing the pedal disengage the clutch and releasing it connect the engine with the rear wheels.

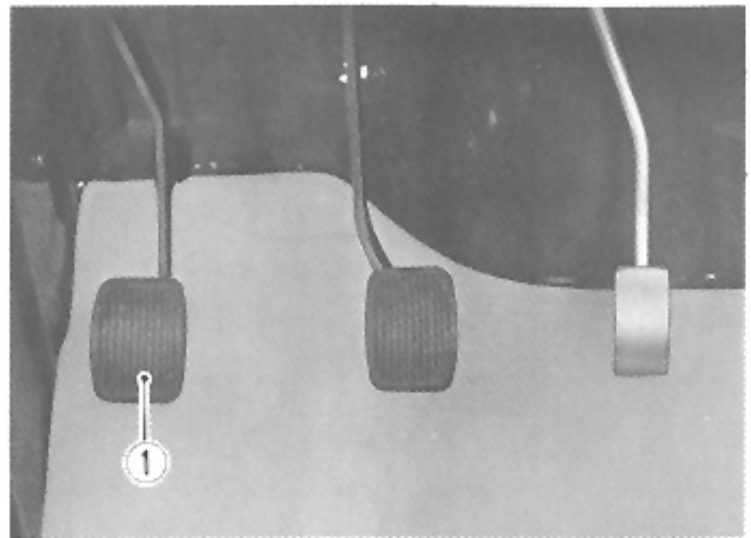

① Clutch pedal

**NOTE:** The clutch pedal should not be used as a foot rest as excessive clutch release bearing and lining wear will result.

## PARKING BRAKE LEVER

LJ50 and LJ50V are provided an exclusive brake drum for parking to lock the rear propellershaft. The foot brake should not effect as the result of soaking water in the brake drum while driving on puddle road, you could use the parking brake instead of the foot brake. The parking brake is of the pull up type, operating mechanically on the wheels. To release the parking brake, pull it upwards to take the load, press the ratchet release button located in the end of the lever with the thumb and push the lever down into the off position.

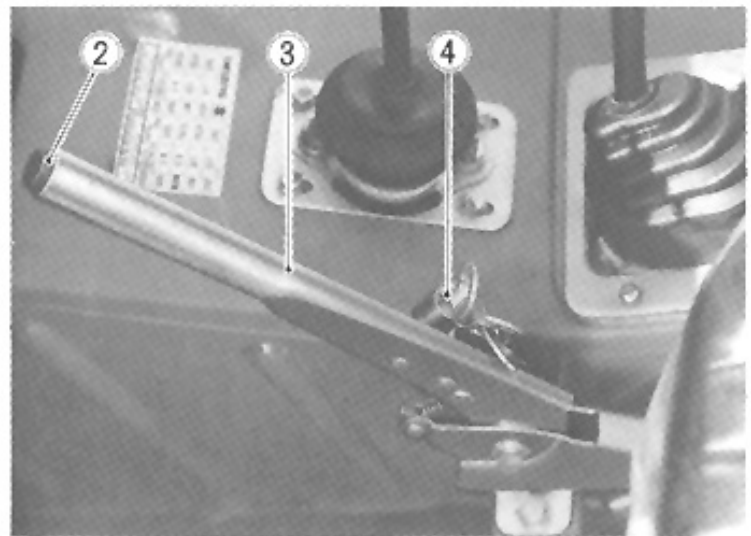

- ② Knob
- ③ Parking brake lever
- ④ Lock

**NOTE:** For LJ50, the parking brake lever lock is provided on the base of the lever to prevent theft. To lock, insert the lock key and turn it clockwise.

## GEARSHIFT LEVER

These LJ50 and LJ50V equipped with a 4-speed forward and 1 reverse transmission which operates as shown in the figure.

All forward gears are synchronized.

N position : neutral

1 position : Move the lever to the left and forward.  
first speed for starting and very steep grades

2 position : Move the lever to the left and backward.  
second speed for not so steep grades

3 position : Move the lever forward from its normal position  
third speed for small grades.

4 position : Move the lever backward from its normal position  
forth speed for city traffic

R position : While pressing down on the lever, move it to the right and backward.

**NOTE:** The gearshift lever must be pushed down and moved to the right to overcome the resistance of the locking mechanism before engaging reverse.

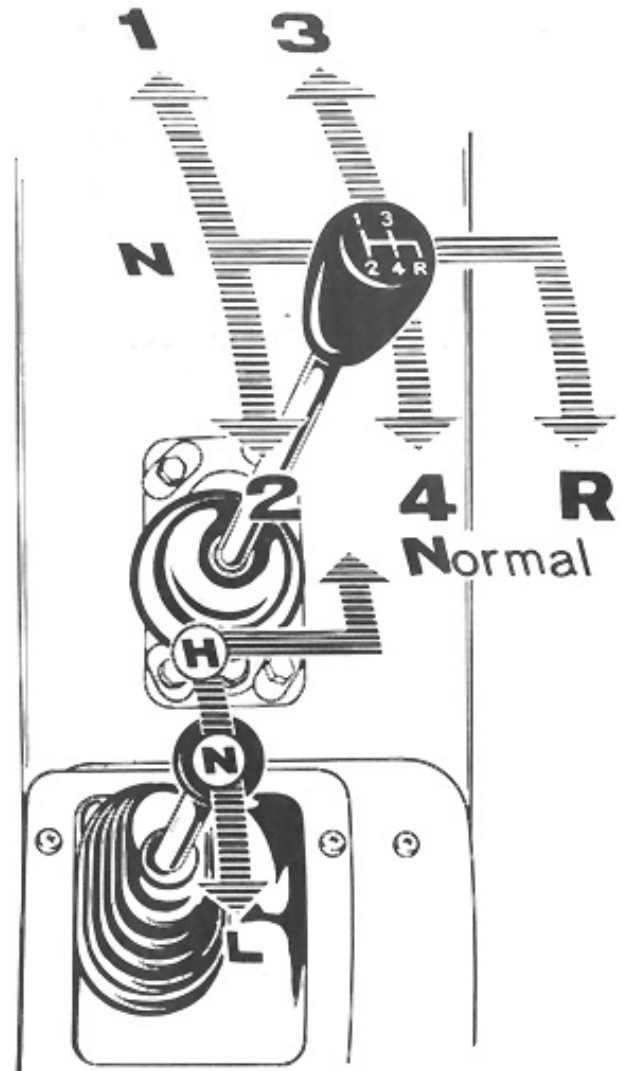

## TRANSFER CONTROL LEVER

Normal position: rear wheel drive for city traffic

H position: high speed four wheels drive for muddy or sundy field

N position: engine power is not transfered

L position: low speed four wheels drive for waste land or extreme steep grades.

**Caution:** Any gear of transfer must be engaged only when the vehicle is not in motion. Use the four wheels drive only off-the-road condition.

## STEERING

The ball screw type steering is employed, because it is easy to operate, superior in durability, stability and controllability.

The steering power is transmitted in the following route:

Steering wheel, steering shaft, rubber joint, steering gearbox, pitman arm, drag link, intermediate arm (steering tie rod lever) tie rod, knuckle arm and front wheels.

**NOTE:** Do not forget to operate the turn signal lever just before turning.

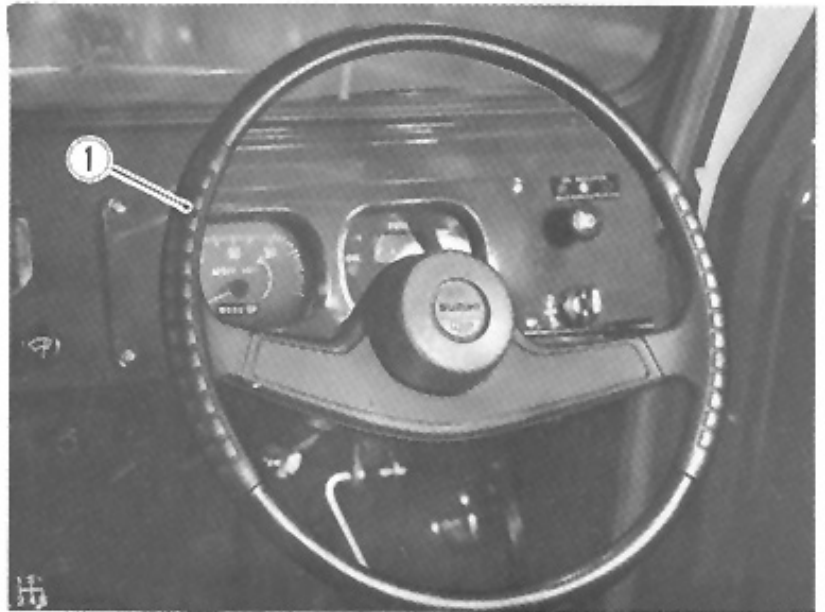

① Steering wheel

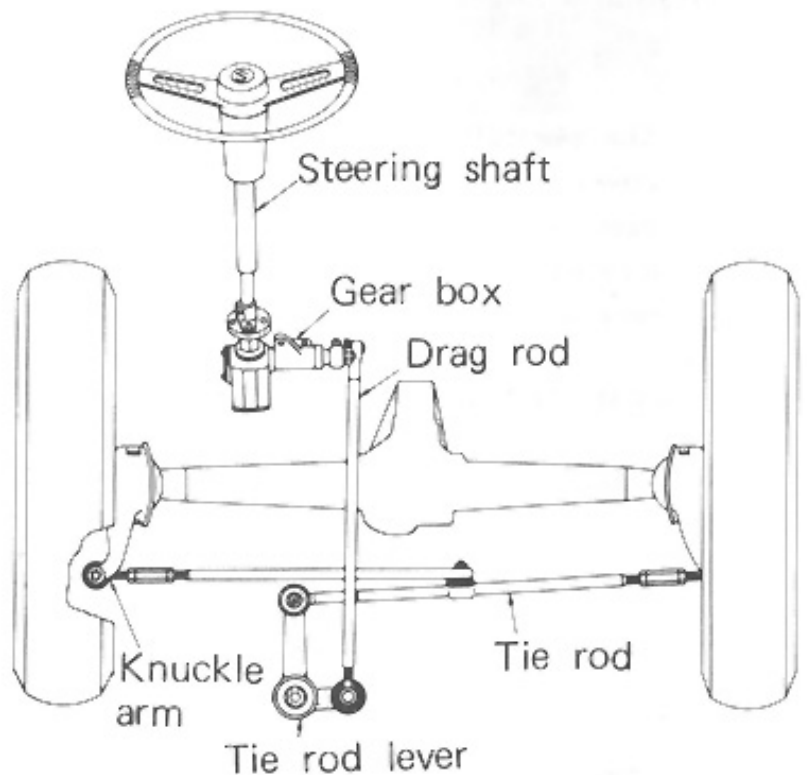



# INDICATOR LAMPS

## TURN SIGNAL INDICATOR LAMPS

Turn signal indicator lamps are located upper part in the combination meter. This indicator flickers when the turn-signal switch is used. When this indicator is blinking at a normal rate, the turn signal lamp is in good working order.

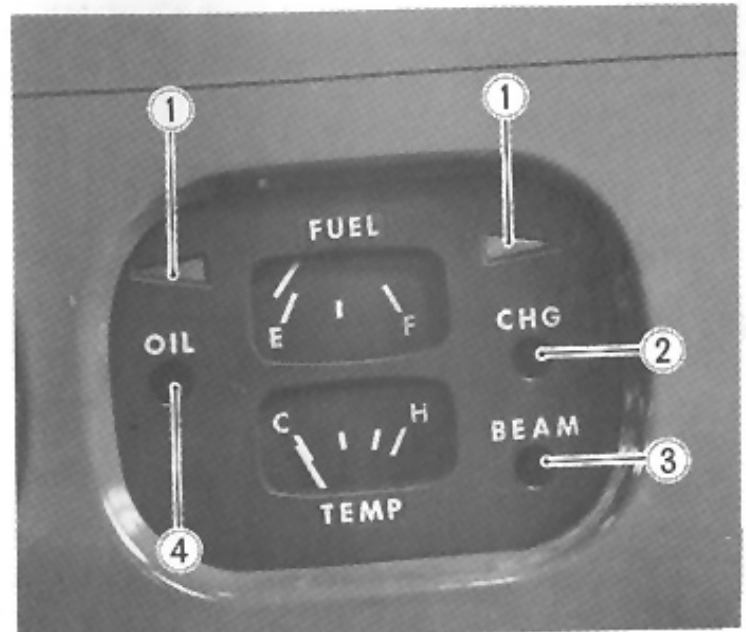

- ① Turn signal indicator lamp
- ② Charging indicator lamp
- ③ High beam indicator lamp
- ④ Engine oil level indicator lamp

## CHARGING INDICATOR LAMP

Charging indicator lamp is located the right part in the combination meter. It will show red when the ignition is switched on. The lamp is not lighted when engine speed are above idle speed and the generator is charging the battery.

## HIGH BEAM INDICATOR LAMP

The high beam indicator lamp is located under the charging indicator lamp. The indicator grows blue when the headlamp's high beam is employed. When the low beam is used the indicator lamp is extinguished.

## ENGINE OIL LEVEL INDICATOR LAMP

The indicator lamp is located the left part in the combination meter. When prescribed amount of engine oil is in the tank, the indicator shows a dim glow in the center with the ignition switch on. When the remaining oil volume registers below 0.8 ℓ (1.2/1.3 US/Imp pt) indicator light brightens. Refill at once.

Should the indicator fail to light at all, there is something wrong with the wiring. Have it repaired.

## MISCELLANEOUS

### GLOBE COMPARTMENT LID

The spring loaded glove compartment lid stays either in the closed or fully open position.

The glove compartment lid of the LJ50 can be locked with the ignition key.

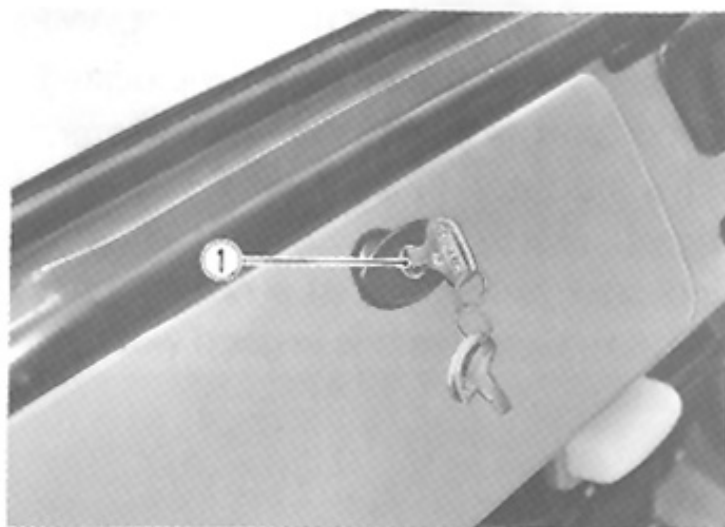

① Lock

### HOOD LOCK KNOB

To lock the hood, first pull the hood lock lever, located in the glove compartment.

In the case of the LJ50, do not forget to lock the glove compartment lid, when parking.

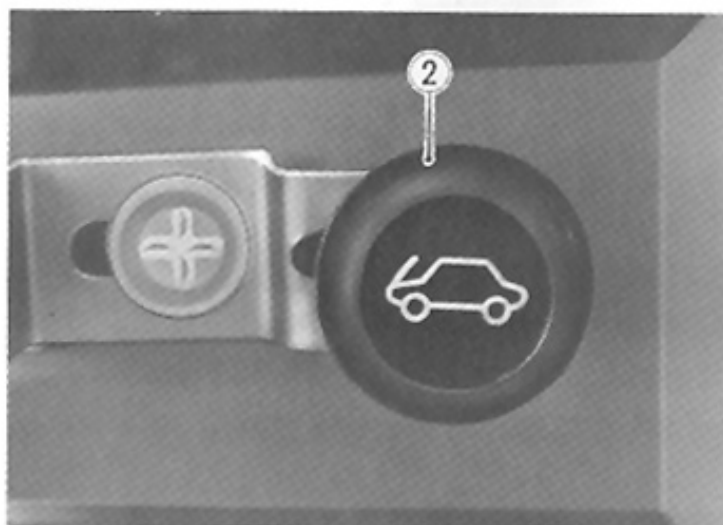

② Hood lock knob

### WINDSHIELD WASHER PUMP

The windshield washer is operated by depressing on the pump when the windshield wipers are switched on. The water reservoir is in the engine compartment. It is advisable to add an approved cleaning solvent and anti-freeze to the water in the container.



③ Windshield washer pump

## ASHTRAY

The ashtray is located in the central part of the dashboard. Pull it out to use. To clean ashtray withdraw the whole unit by pressing down on the part indicated by the arrow in the illustration.

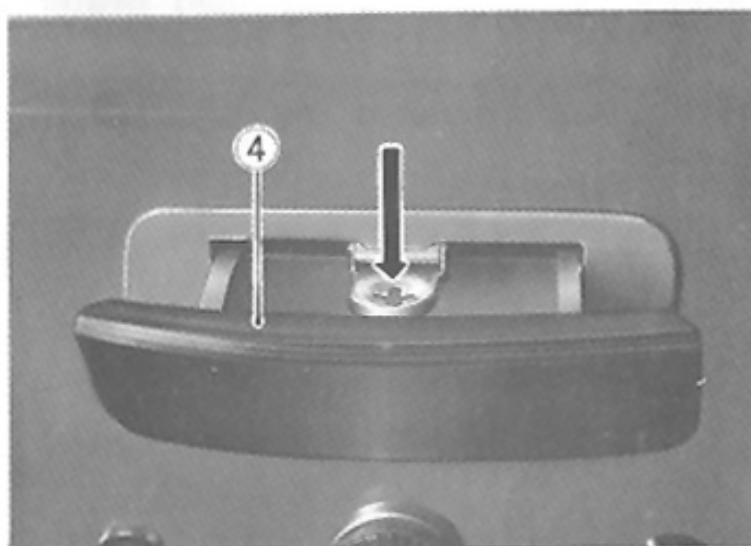

④ Ashtray

## VENTILATOR KNOB

The ventilator knob opens and closes the ventilator lid. In order to allow the stale air to escape, open the ventilator by depressing the knob to the bottom position.

**NOTE:** For a vehicle which is not provided heater unit, pull the knob to open the ventilator lid.

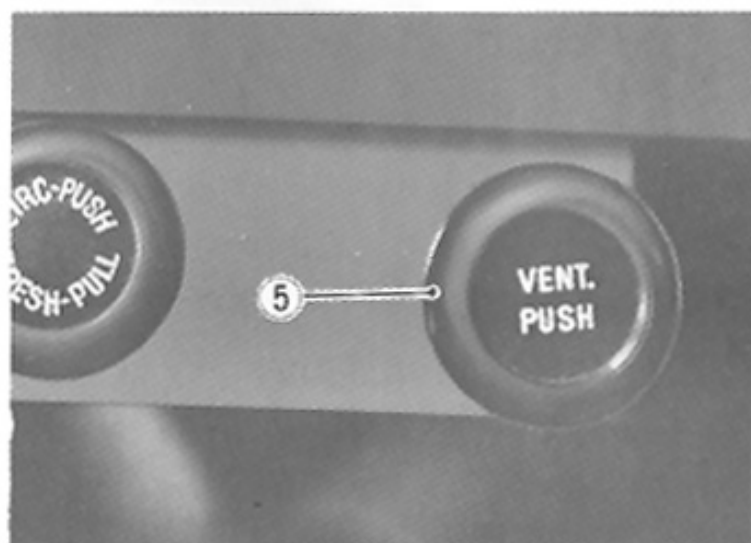

⑤ Ventilator knob

## CIRC-FRESH KNOB (Only for a vehicle provided heater unit)

This knob regulates the temperature either cold or warm.

Forward position . . . . . Warm  
Backward position . . . . . Cold

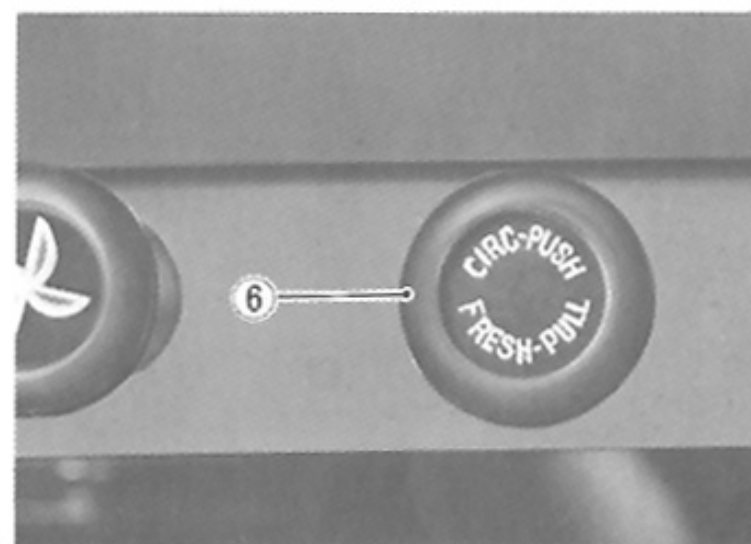

⑥ CIRC-FRESH knob

## DEFROSTER CONTROL LEVER (Only for a vehicle provided heater unit)

This lever regulates the distribution of air.

- I Forward position:  
defroster jets
- II Backward position:  
heater outlet and any desired  
position within this range.

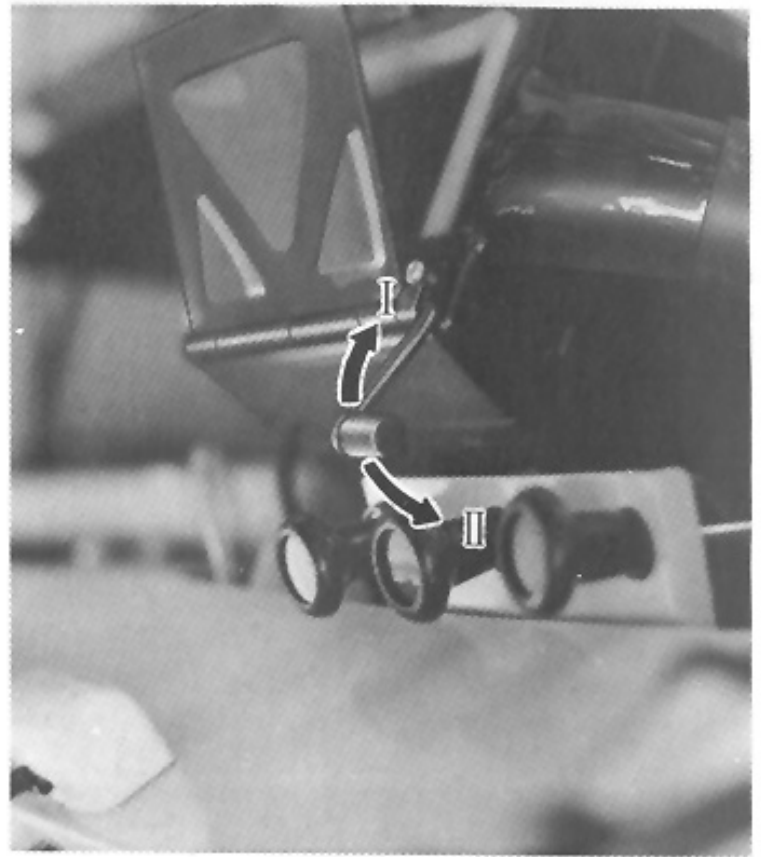

## SIDE WINDOW (LJ50V)

The window is opened and closed by a handle located on the front part of the door.

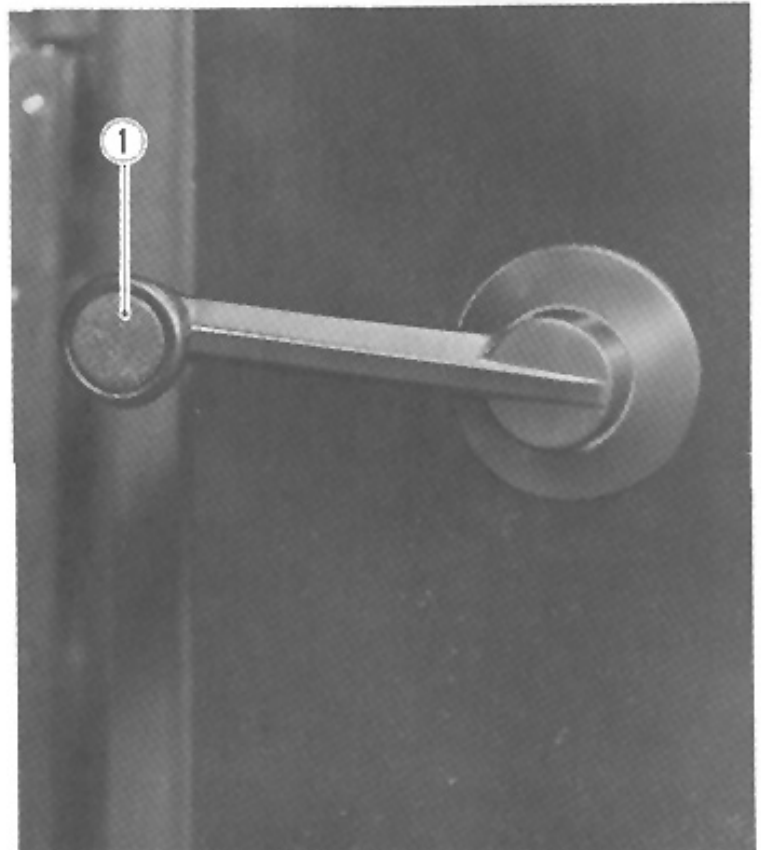

① Handle

## ENGINE HOOD

Remove two hook shaped grips located on the front fenders.

To support the open hood, gently lean it against the rubber stopper which is fixed above the windshield.

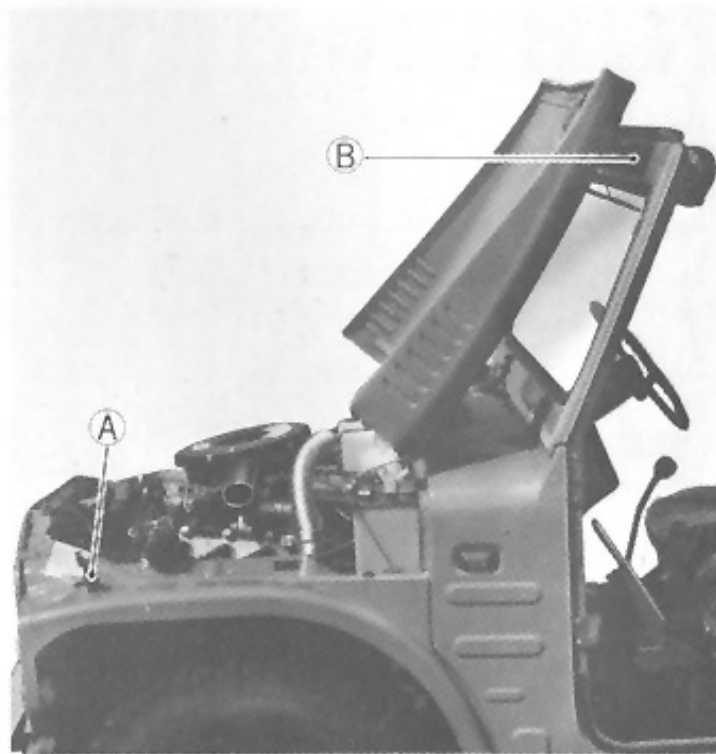
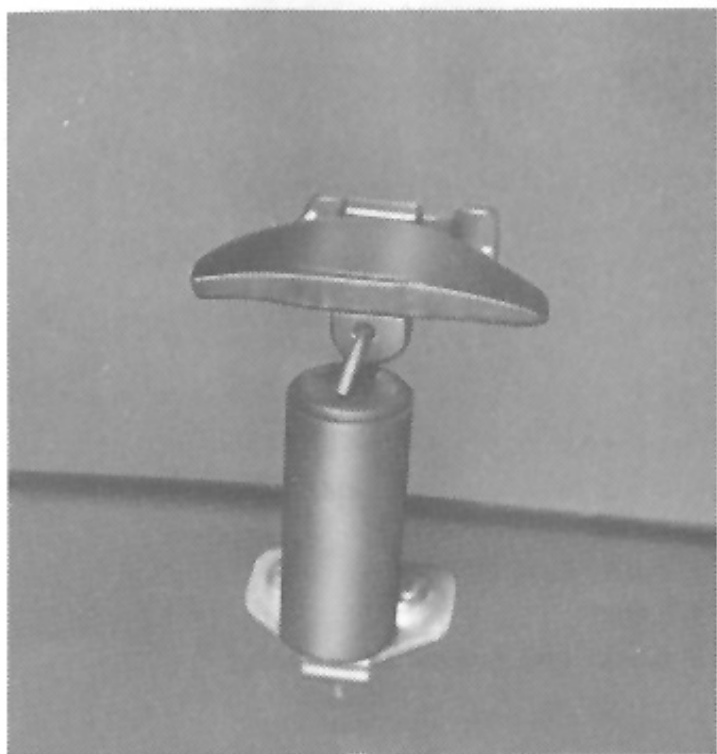

## FRONT WINDOW (LJ50)

The windshield of the LJ50 can be leaned by removing the brackets. It will be more comfortable for you to drive a vehicle in summer. Be sure to use the windshield fixing belts (optional parts).

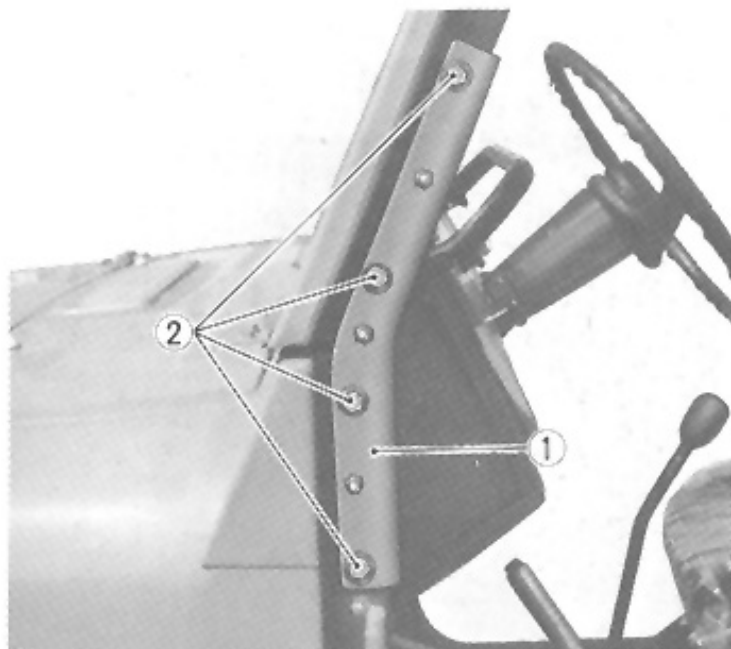

① Bracket ② Setting bolt

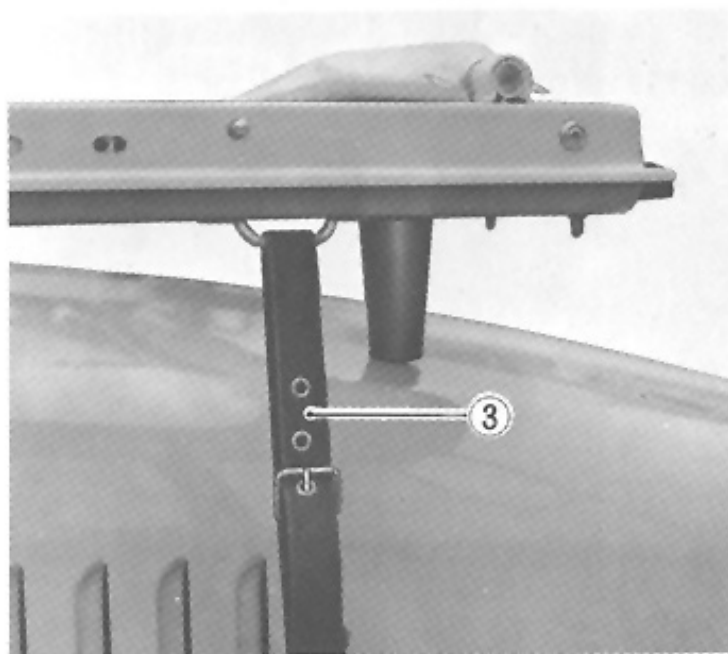

③ Fixing belt

## SIDE DOOR (LJ50V)

The ignition key fits the driver's door lock. After unlocking the door can be opened by pulling out the door handle. The assistant door can also be secured by moving the door inside handle forward.

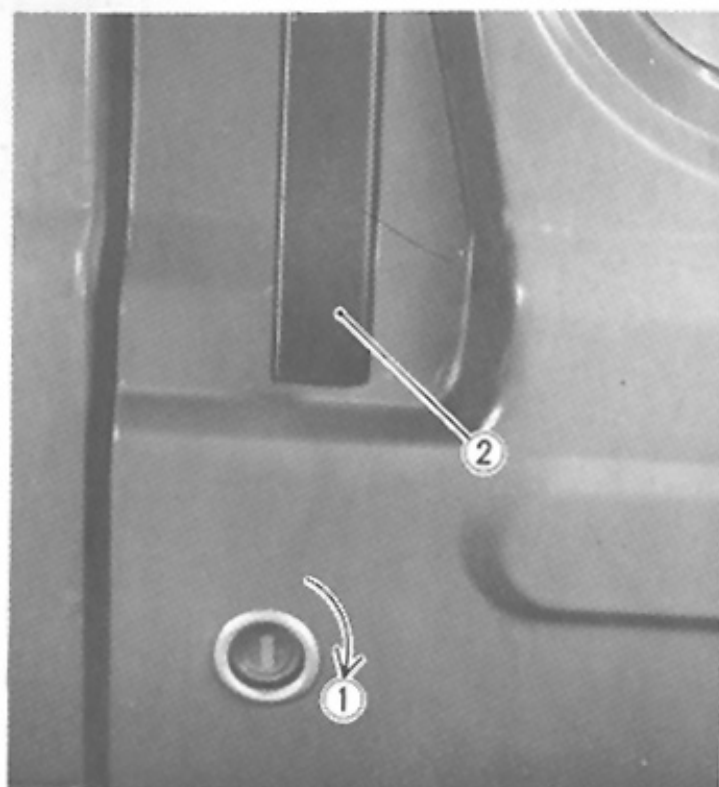

- ① Lock
- ② Side door handle
- ③ Open
- ④ Lock (assistance door only)

## CANVAS DOOR AND WINDOW (LJ50)

The canvas door can be opened by turning the handle downward. To open the windows, roll the windows after removing the hooks and fix it with two bands provided on the door.

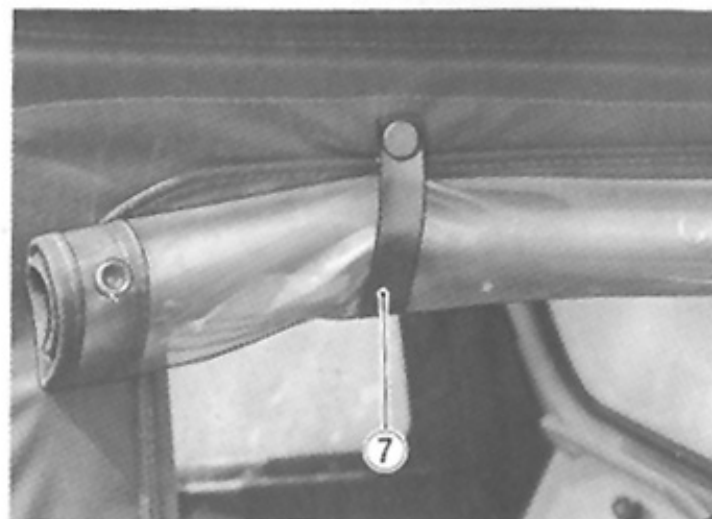
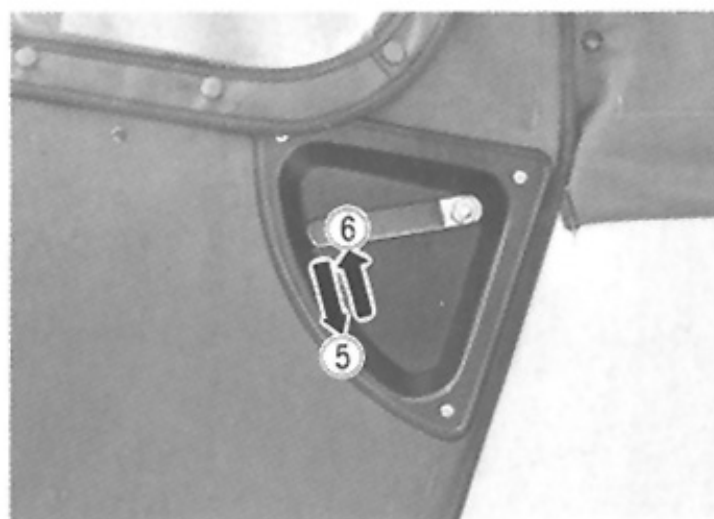

- ⑤ Open
- ⑥ Lock

- ⑦ Band

## FRONT GATE BAR (LJ50)

Getting on and off a vehicle, pull the knob toward you and let the bar down with the knob pulled. Be sure that the front gate bars are locked securely before starting the vehicle.



- ⑧ Release
- ⑨ Close

## TAIL GATE (LJ50)

The tail gate of the LJ50 can be opened and shut with the lock handle after removing the spare tire holder.

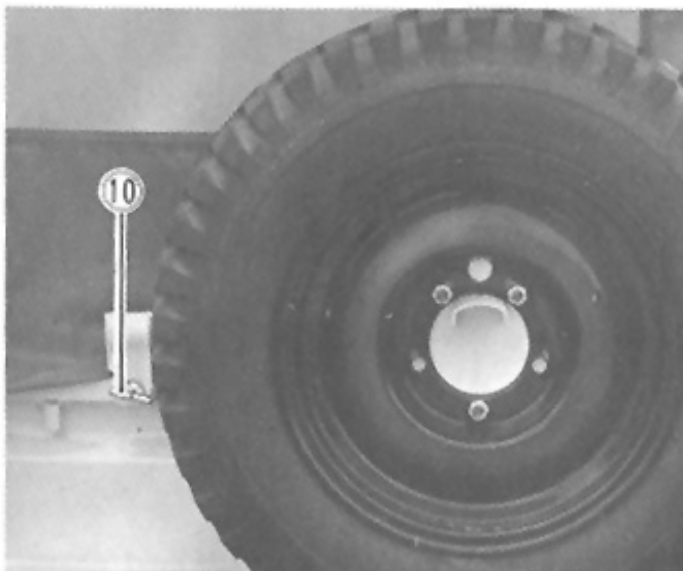

- ⑩ Tire mounting bar fitting screw

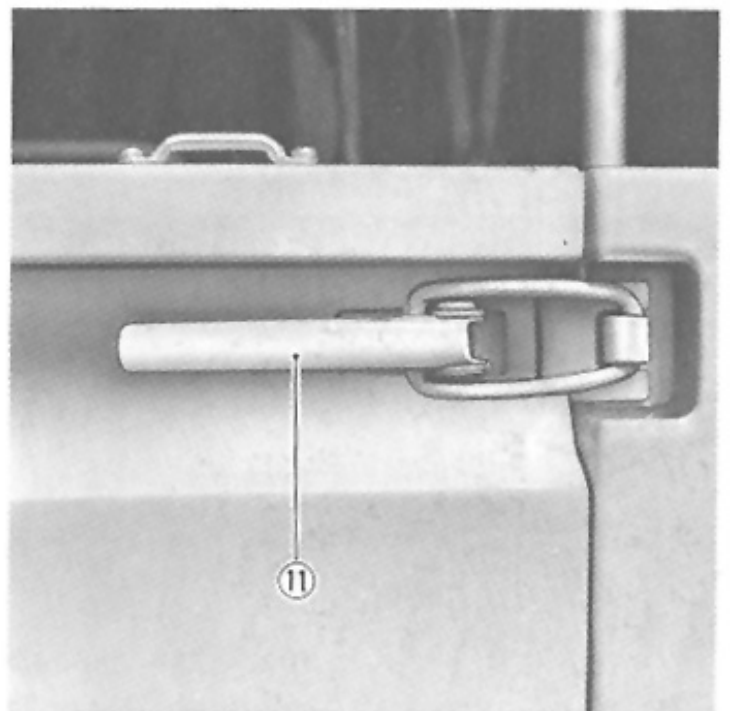

- ⑪ Lock handle

## TAIL GATE (LJ50V)

The tail gate of the LJ50V is locked with the door and ignition key. To lock the tail gate, turn the key counter-clockwise  $\frac{1}{2}$  turn. There are two methods to open the locked rear gate. The first method is to turn the key clockwise  $\frac{1}{2}$  turn from the outside of the rear gate. The second is to pull the handle of the rear gate from the inside of the LJ50V.

- ① Rear gate handle
- ② Lock
- ③ Release

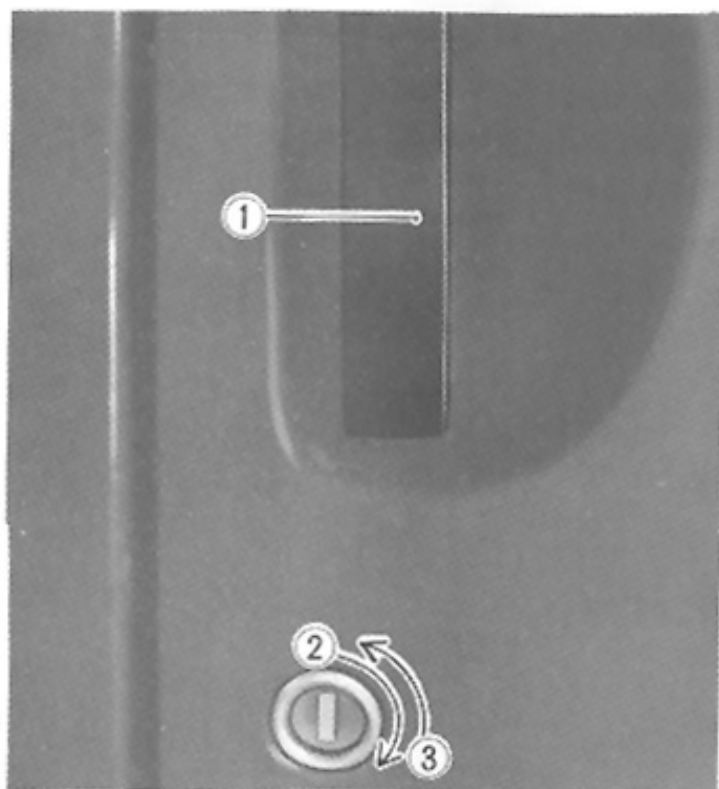

## REAR CURTAIN (LJ50)

To open the rear curtain, remove three rubber bands from the hooks of the rear gate and unfasten two belts. Twist a knob of the clasp and separate it one after another. Roll the rear curtain and fix it with two bands.

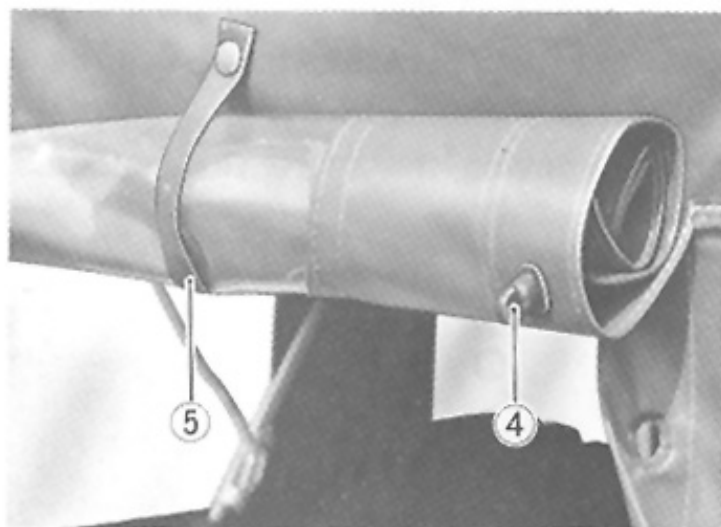
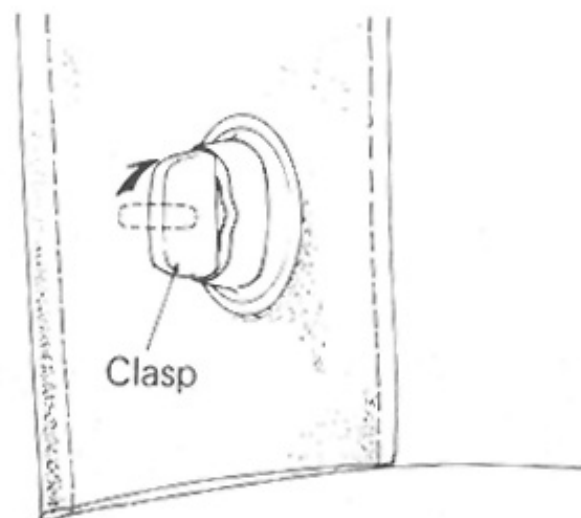

- ④ Clasp
- ⑤ Belt

**NOTE:** Side curtain opening can be performed by similar procedure as described above.



## HEATER CONTROL VALVE (Only for a vehicle provided heater unit)

The water passage to the heater unit should be shut in summer season by screwing in the valve, which is provided in the engine compartment, until it bottoms completely.

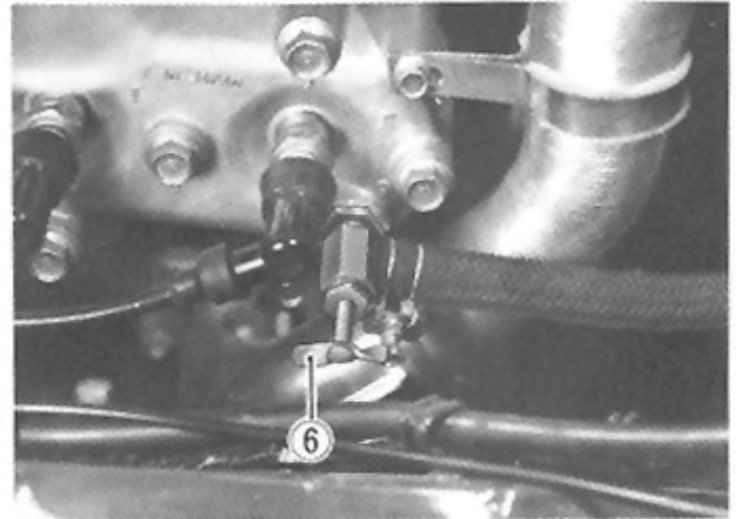

⑥ Heater control valve

## AIR INTAKE CONTROL LEVER

To ensure adequate engine protection rotate the lever located on cleaner intake duct to exclude the admission of cold air. Rotate the lever according to the labelled instruction.

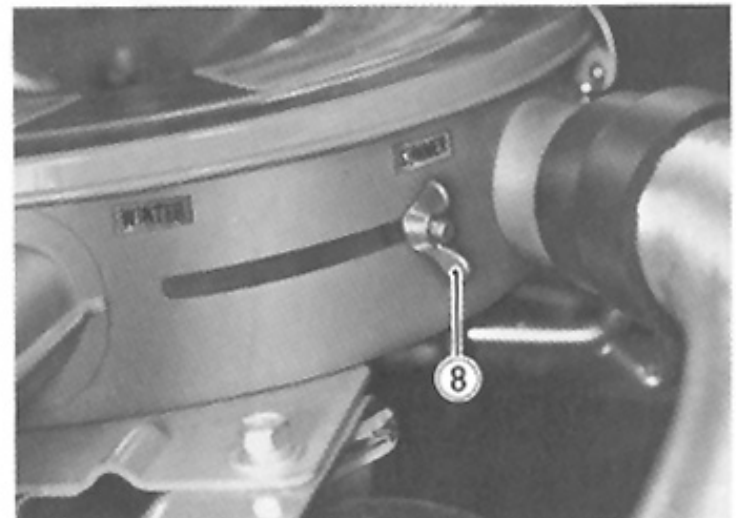

⑧ Air intake control lever

## SEAT BELT

Secure the seat belt by inserting the tongue into the buckle. To release, press the "S" mark of the buckle and two parts will separate. After buckling the seat belt, adjust for a comfortable fit.

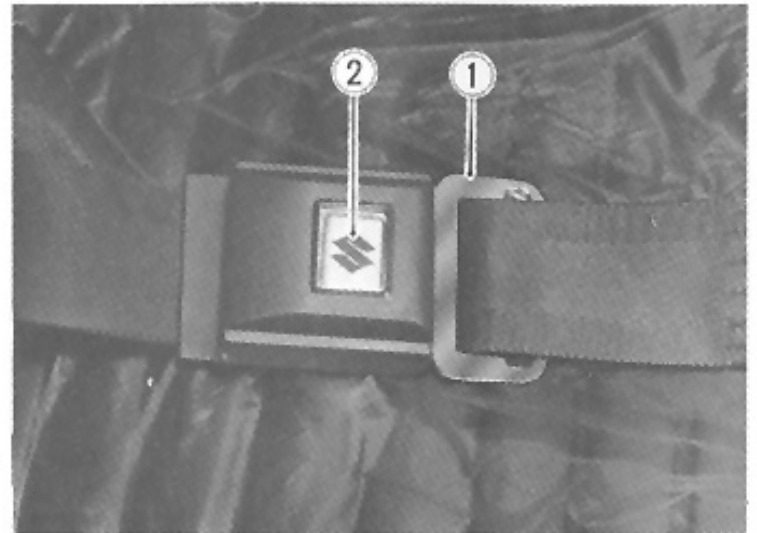



- ① Seat belt
- ② mark



## CAR HEATER (Only for a vehicle provided heater unit)

When the atmospheric temperature falls below 68° F (20° C), loose the heater control valve. Car heater is able to use.

\* FOR HEATING ROOM (in cold season)

 WITH THE HEATER VALVE OPENED		
TEMPERATURE	 FAN SWITCH	 CIRC-FRESH KNOB
HIGH	ON	CIRC
MEDIUM	ON	FRESH
LOW	OFF	FRESH
STOP (No air supplied)	OFF	CIRC

\* FOR VENTILATING ROOM (in warm season)

 WITH THE HEATER VALVE CLOSED		
VENTILATION	 FAN SWITCH	 CIRC-FRESH KNOB
HIGH	ON	FRESH
LOW	OFF	FRESH
STOP	OFF	CIRC

## HOOK

LJ50 and LJ50V have the front and rear towing hooks.

Use the towing hook to attach the rope for pulling the other vehicle and being pulled the vehicle.

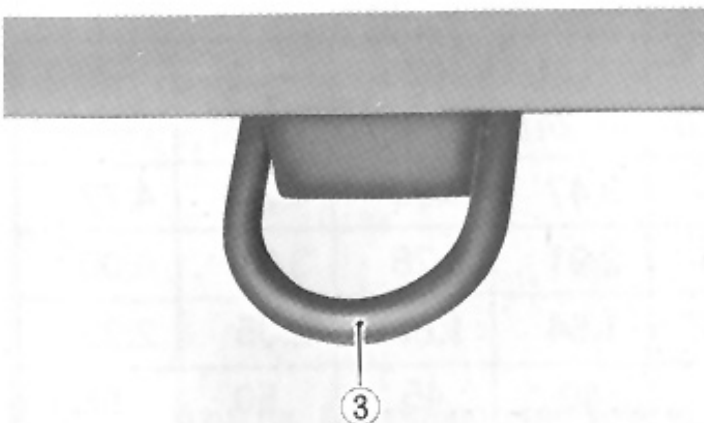

③ Front towing hook

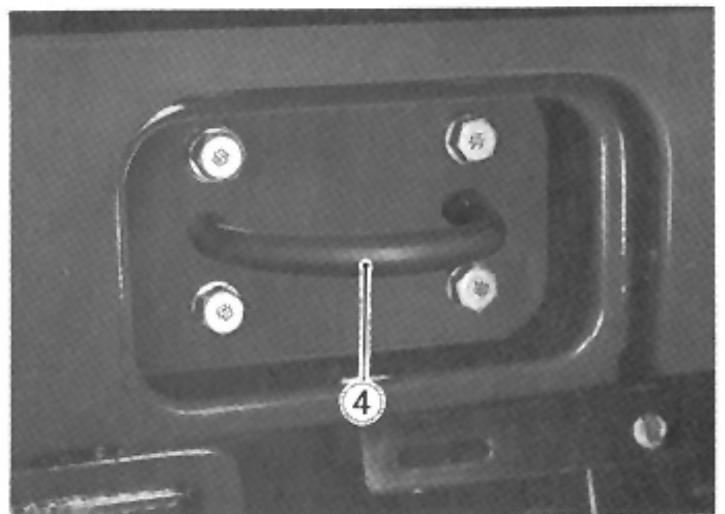

④ Rear towing hook

# FLUID RECOMMENDATIONS

## COOLANT SUPPLY AND CHANGE

### COOLANT

Use GOLDEN CRUISER # 1200 or equivalents as your water additive the whole year round.

Change the coolant once very two years.

Cooling water must be soft water - such as city water.

Hard water (which includes well water and river water) contains many impurities (iron and the like) which many rust or otherwise contaminate the inside of the radiator and lead to engine trouble.

### \* GOLDEN CRUISER # 1200

The GOLDEN CRUISER # 1200 serves not only as an anti-freeze element, but also anti-foam, anti-rust and anti-corrosion purposes besides being a lubricant for the water pump. To achieve these objectives the cooling water mixture should be 30% GOLDEN CRUISER # 1200.

The freezing temperature of water with a 30% coolant mixture will be 3 F (-16 C). However, as northern areas many experience even lower temperatures than this, the coolant mixture proportion should be adjusted according to the table shown here. (Should the cooling water freeze solid, the cylinder block will often be broken.)

Radiator capacity : 4.1 ℓ (8.67/7.28 US/Imp pt)

Temperature °F (°C)		Intense cold districts					
		5 (-15)	-4 (-20)	-11 (-24)	-20 (-29)	-33 (-36)	-47 (-44)
Am't GOLDEN CRUISER #1200	US pt	2.60	3.04	3.47	3.90	4.34	4.77
	Imp pt	2.18	2.55	2.91	3.28	3.64	4.00
	ℓ	1.23	1.44	1.64	1.85	2.05	2.23
Proportion (%)		30	35	40	45	50	55
Safe-use temperature F (°C)		14 (-10)	5 (-15)	-4 (-20)	-13 (-25)	-24 (-31)	-38 (-39)

Proportion Temperature	30%	35%	40%	45%	50%	55%
Spec. gravity 50°F (10°C)	1.047	1.055	1.063	1.070	1.078	1.083
" 68°F (20°C)	1.043	1.051	1.058	1.066	1.072	1.078
" 86°F (30°C)	1.039	1.046	1.053	1.060	1.067	1.072
" 112°F (40°C)	1.034	1.041	1.048	1.054	1.061	1.066
" 122 F (50°C)	1.029	1.035	1.042	1.048	1.055	1.059

**NOTE:** In case you use anti-freeze and summer coolant other than GOLDEN CRUISER # 1200, observe the instructions given by each manufacturer.

Before winter has arrived be sure to accurately measure the coolant proportion of the mixture. Doing this will be helpful in preparing for any exceptionally cold periods that occur often in cold districts.

Measurement of the mixture proportion can be done at any authorized SUZUKI dealer or agency.

#### \* SUPPLY

Lift the front hood and the cooling mixture inlet is readily observed. To remove the radiator cap, turn it counterclockwise and pour in the cooling mixture.



① Radiator cap

**NOTE:** Wait for the radiator contents to cool somewhat before removing the cap, since removing cap when the water is very hot can be dangerous. When removing radiator cap, do so slowly so as to let some of the steam escape bit by bit, for your own protection.

## Refilling:

Refill whenever the fluid surface goes down below upper limit line of the reserve tank. In the natural evaporation, replenishing with water is sufficient. However, if there is an acute reduction of fluid, or if it must frequently be refilled, have it checked for leakage at a dealer or agency.

### \* CHANGE

After opening the front hood, drain the radiator by removing drain plug located in its lower part.

- For this operation first remove the cap of the radiator completely.
- After draining the radiator completely, thoroughly flush out the accumulated rust and any other contaminations may be removed.
- The water-coolant mixture should be poured in slowly after tightening the drain plug.
- The radiator should be filled to the very top - - - until no more can enter.
- Then the reserve tank should be filled to the full level too.

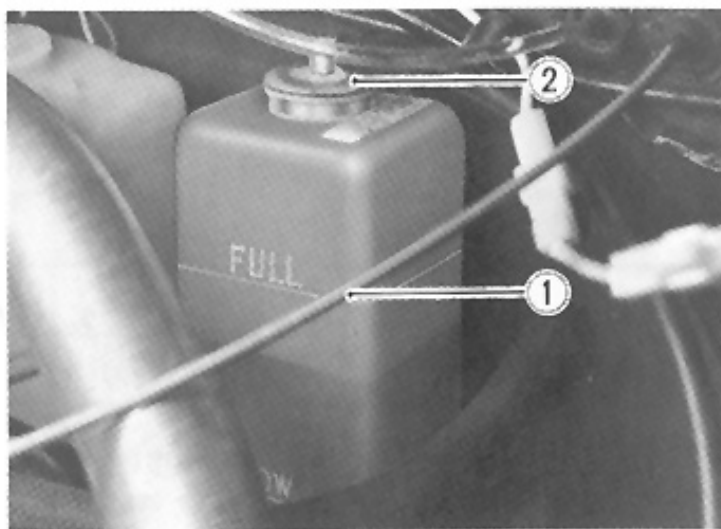

- ① Full level
- ② Reserve tank cap

## REFILL OF OIL AND OTHER FLUIDS

### WINDSHIELD WASHER FLUID

The container for this fluid is contained in the front hood. Lift the hood and replenish, as needed, with either water or special cleaning fluid.

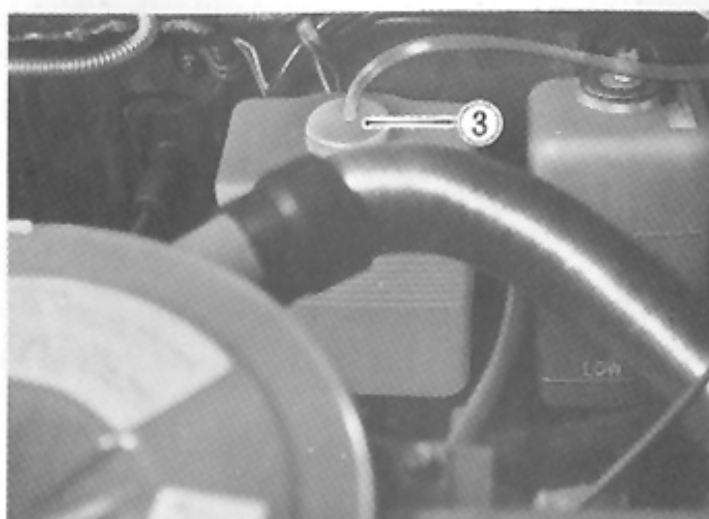

③ Windshield washer fluid container cap

**NOTE:** In cold area, it is better to use such special cleaning fluids, rather than water to keep the water from freezing.

### GASOLINE

The fuel tank inlet is located on the rear-right side of the car. For your protection the tank is locked. Unlock the fuel tank cap with ignition key, remove the fuel tank cap and fill the tank.

Tank capacity is 30ℓ.  
(7.9/6.6 US/Imp gal).

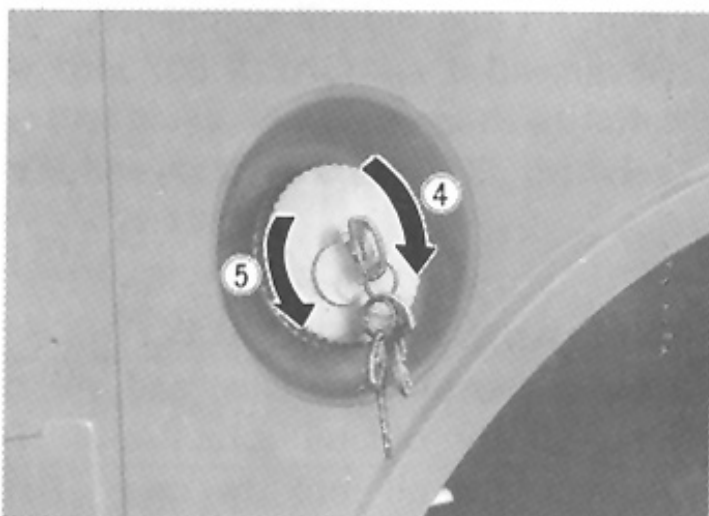

④ Lock    ⑤ Release

### ENGINE OIL

Open the engine cover and the oil tank is immediately visible on the extreme left of the engine area. Twist the cap off and fill with SUZUKI CCI OIL or good quality non diluent two stroke oil of around SAE # 30. Tank capacity is 3.4ℓ  
(7.1/6.0 US/ Imp pt).

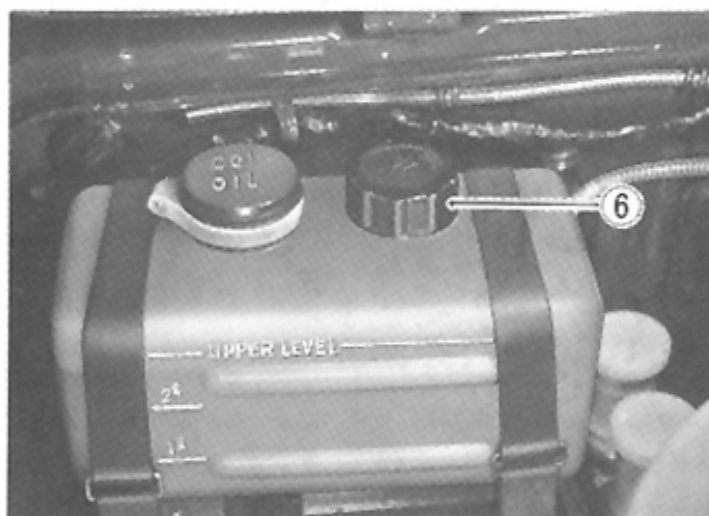

⑥ Engine oil tank cap

## TRANSMISSION OIL

Draining oil should be performed while the engine is still warm as this will assure complete and rapid draining, saving much time.

Remove the oil filler plug located on the right side of the transmission case and the drain plug located on the lower part of the case. Drain off the old oil completely.

After tightening the drain plug, pour the recommended oil (A good brand of SAE # 80 gear oil should be used for this vehicle.) into the case from the filler hole until oil over flows from the hole.

Screw in the filler plug.

Specified oil amount is 1,000 cc (2.12/1.76 US/Imp pt).

## TRANSFER OIL

Remove the oil filler plug located on the upper part of the transfer case and the oil drain plug located on the lower part of the case.

Drain off the old oil completely. Then tighten the drain plug and pour the recommended oil (SAE # 80) into the case.

Refit the filler plug.

Specified oil amount is 900 cc (1.90/1.60 US/Imp pt).

## REAR AND FRONT AXLE

Remove the oil filler plug and the oil drain plug.

Drain off the old oil completely. Then retighten the drain plug and pour the recommended oil into the case. Refit the filler plug.

Specified oil amount is 1300 cc (2.75/2.31 US/Imp pt).

**NOTE:** Transmission, transfer, steering gearbox, rear and front axle oil is SAE # 80.  
Regular intervals to change oil is written in LUBRICATION CHART.



## BATTERY SOLUTION

The battery solution must be kept above the lower limit line at all times. If the level is found below the lower limit line, and pure distilled water up to the upper limit line. Do not add diluted sulphuric acid.

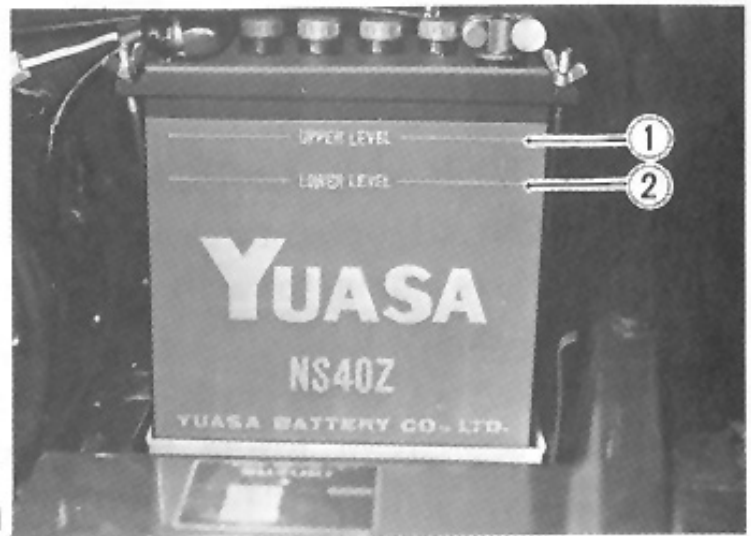

- ① Upper level
- ② Lower level

**NOTE:** Check the battery every two weeks. Be careful not to bend the plastic air vent tube or obstruct the venting.

## BRAKE FLUID

Open the front hood and, you will see the brake fluid reservoirs. Remove rubber caps and check brake fluid level. If the fluid level is lower than 1 cm (.4 in) from the top of the tanks refilling is necessary. Fill the reservoir with one of the brake fluid graded below.

SPECIFICATION AND CLASSIFICATION	REMARKS
DOT 3	In USA
DOT 4	In USA
SAE J1703a	
SAE J1703b	
SAE J1703c	
SAE 70R3	A classification in obsolete specification of SAE J70b

**NOTE:** Since the brake system of this vehicle is filled with a glycol-based brake fluid in the manufacturer, do not use or mix different type of fluid for refilling the system, otherwise the serious damage will be caused. Do not use any brake fluid taken from old or used or unsealed containers.

# AIDS FOR SAFE, COMFORTABLE DRIVING

## DAILY OVERALL CHECK-UP

The condition of your car will vary day by day. So why not check, this morning before going to work, how it is now? Such a check-up will ensure your driving safety today. A few minutes of your time may protect you from an accident. A daily check-up will reveal defective or worn parts as well as possible sources of future trouble so that the necessary repairs can be done in good time. This will help prolong the life of your new LJ50 or LJ50V. Why not make it a habit - - - starting today!

- \* Observe the following points before taking your LJ50 or LJ50V on an expressway for high speed travel.
  - Are the tire pressure and thread condition correct?
  - Are the correct sparkplugs installed?
  - Is there sufficient battery fluid?
  - Are the battery terminals in good condition?
  - Is the tension and wear of water pump generator belt in good condition?



Check the following items yourself everyday before driving your new LJ50 or LJ50V.

1. Steering operation
2. Brakes
3. Tires
4. Chassis spring
5. Engine
  - oil
  - cooling system
  - V belt
6. Fuel
7. Driver's equipment
8. Luggage load equipment
9. Lighting system
10. Indicator lamps
11. Mirrors
12. Number plate
13. Instruments and gauges
14. Parts noted in yesterday's check-up



## STEERING WHEEL AND RELATED PARTS

- Set tires so that they are pointed directly ahead, shake the steering wheel vertically and check whether there is any play in the shaft or not.
- Check for play in the steering wheel by turning the wheel back and forth. The play tolerance should be within 1 - 3 cm (0.4 - 1.2 in) at the circumference.
- Check whether the steering wheel has deflection, turn-resistance, abnormally heavy feeling.

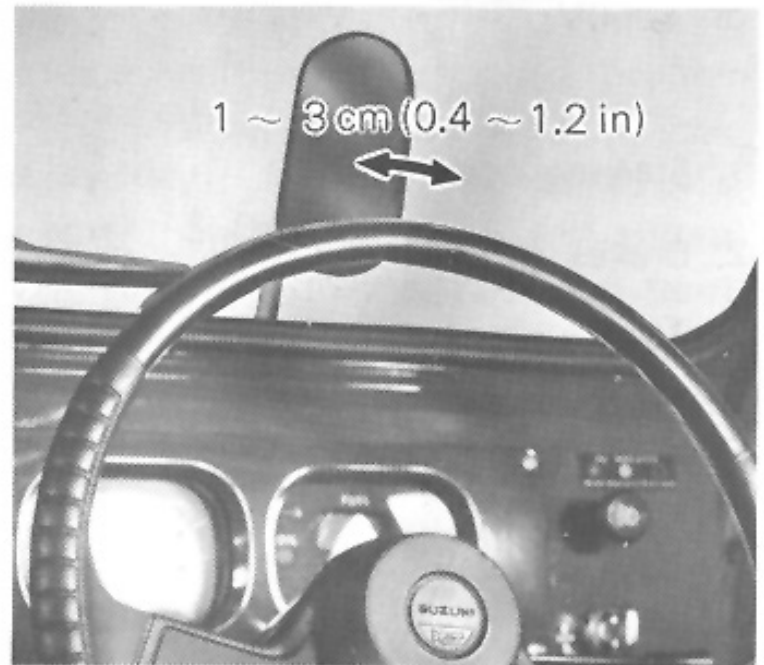

## BRAKE PEDAL

- Find resistance moment by pressing down on the pedal. Brake pedal play tolerance of 1.5 - 2 cm (0.6 - 0.8 in) is proper. Moreover, clearance between a depressed brake pedal and the floor should be 10 cm (4 in) or more.
- If you feel as if you've touched something sponge-like when depressing the brake pedal, repairs are necessary. Also if you work the brake pedal two times and notice a difference between the two, or if, after pumping the brake pedal a few times, it becomes dull and lifeless, repairs are indicated.
- Check on whether the brake's effectiveness is impaired and whether there is a left-right imbalance.

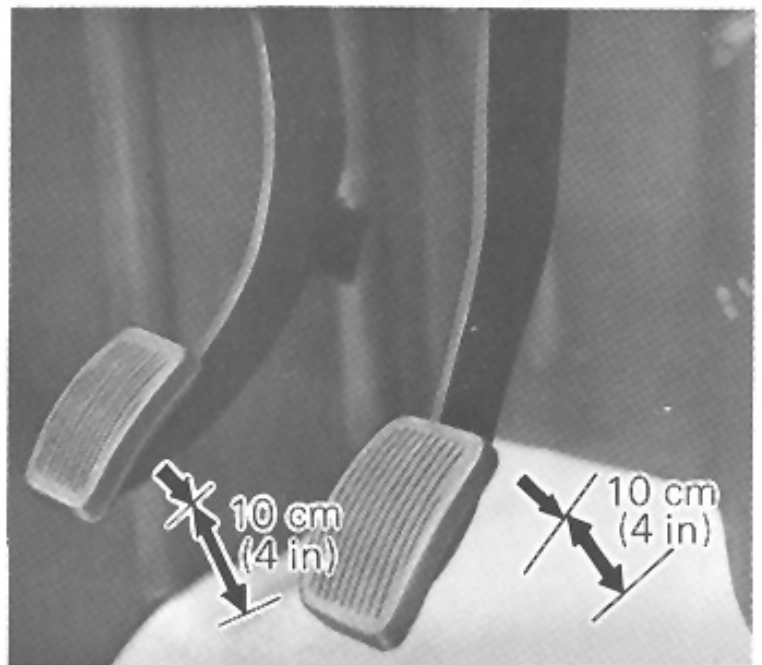

## CLUTCH PEDAL

The clutch serves as an intermediate agent in the transmission of force from the engine to the driving system. Between the 'at rest' position of the clutch pedal and the depressed position where it takes hold, there should be, normally, 2 - 3 cm (0.8 - 1.2 in) play. Furthermore, the clearance between the floor and the fully depressed clutch pedal should be 10 cm (4 in) or more.

## PARKING BRAKE LEVER

- When putting the brake on, see whether it is firmly applied when using 7 or less ratchet teeth of the brake lever.
- See if the knob in the tip of the brake lever is in working order and work easily.

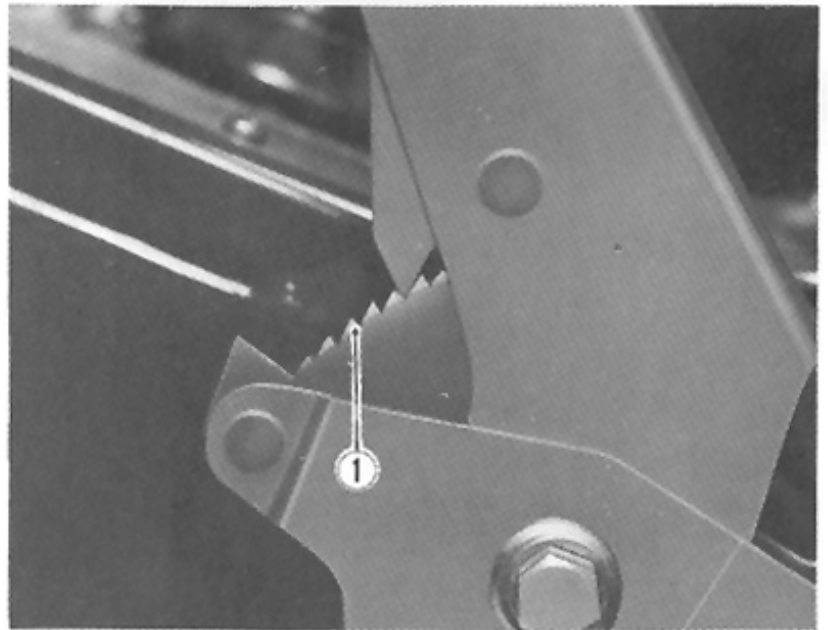

① 7 or less ratchet teeth

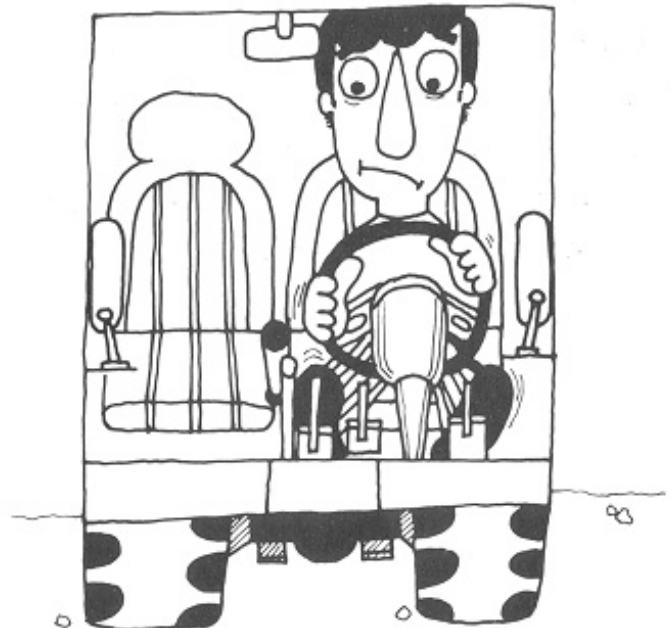

## TIRE

- Measure air pressure with a gauge.
- Check depth of tire flap (side) to see if full enough.
- Check whether there is any wear or damage.
- Check for loose hub nuts.
- Check tire for nails, stones and similar alien items.

Proper air pressure for tires

	psi	kg/cm <sup>2</sup>
Front wheel	17	1.2
Rear wheel	26	1.8



Excessive

Short

Correct

Tire size . . . . . 6.00-16 4PR (LJ50)  
5.60-15 4PR or 6.00-16 4PR (LJ50V)

**NOTE:** Air pressure measurement should be done when the tires are cool.



## BATTERY

The electrolyte in the battery gradually evaporates due to its make-up. The amount of battery fluid can be seen from the outside. (If hardly visible, shake the car body which will cause a visible wave in the fluid surface.) Fluid surface should be between the UPPER LEVEL and the LOWER LEVEL. Refill with distilled water up to UPPER LEVEL.



## GASOLINE

After turning on the ignition switch you can check whether or not the fuel gauge is working. You can also check on the amount of gasoline in the tank. When the needle of the fuel gauge points to 'F' the tank is full, but at 'E' 5.0  $\ell$  (1.3/1.1 US/Imp gal) still remains. If you will be doing expressway high-speed travel, be sure to have a full tank of gasoline.



## ENGINE OIL

On turning on the ignition switch, if the oil indicator glows faintly, it indicates that there is anywhere from a full tank to 3.4  $\ell$  (7.1/6.0 US/Imp pt) present. Before entering an expressway, remove the oil tank cap and check the supply visually. If the oil indicator glows brightly, then a refill of engine oil is necessary immediately.



**NOTE:** When the indicator fails to glow at all, something is wrong either with the wiring or the bulb.

## LIGHTS AND SWITCHES

Check the following items by turning the light switch clockwise:

- Whether both front and rear parking lights work.

Return the switch to its original position and then pull it out one step or degree. Check the following items:

- Do the parking lights work all right?
- Does the number-plate light work all right?
- Do the meters and gauges work all right?

Pull the switch out one more degree or step and check the following items:

- Do the headlamps work correctly?
- Do the high and low beams work correctly?
- Do the taillamps work correctly?
- Does the number-plate lamp work correctly?
- Do the meter lights work correctly?

After pulling the 4-way flasher switch, check the next point:

- Can the turn-signal lamps - front, rear and side - all be lit simultaneously?

After pulling the dimmer switch toward yourself, check the passing light:

- Can the headlamp be switched to the high-beam regardless of the lighting switch, while pulling the dimmer lever toward yourself?

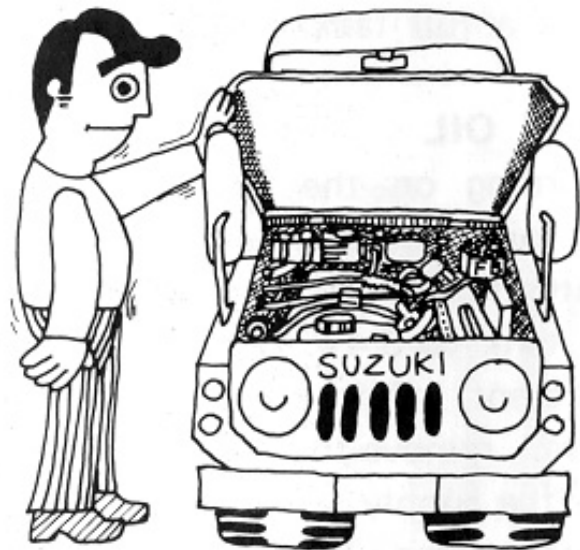



## IGNITION SWITCH ON

The following check should be conducted with the ignition switch on position.

- Does the charge indicator lamp work?
- Does the oil indicator glow faintly?
- Do the brake lamps go on and off as the brake pedal is depressed and released?
- Does the back-up lamp go on when the gearshift is put into reverse 'R' gear?
- Does the horn work the moment it is pushed?
- Do the windshield wipers work correctly?
- Check also whether all the turn signal lamps work when the lever is operated.
- Check also whether all lamps for dashboard instruments are in working order.

## WATER PUMP AND ALTERNATOR BELT

The adequate flex for the water pump and alternator belt, measured at the center of the belt between the pump and alternator, is 13 - 17 mm (0.5 - 0.65 in). Measure by forcefully pushing the belt with your finger. If the flex is either greater or less than the specified amount, it should be corrected at once. Adjust the tension of the belt according to the following manner. First, loosen the set-bolt of the alternator, which then becomes movable, and adjust the belt tension. When the appropriate of flex is achieved, refasten the set-bolt.

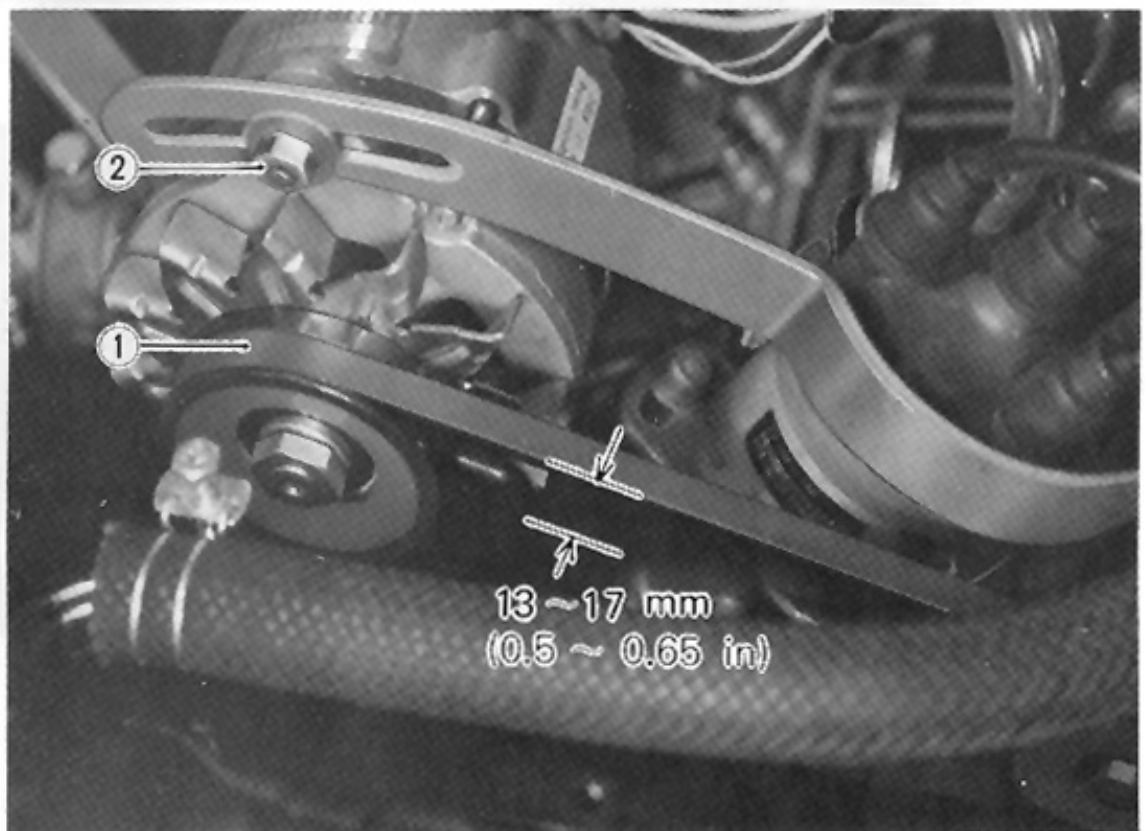

# TIPS ON DRIVING

## STARTING THE ENGINE

### \* Starting a warm engine

- Make sure, first of all, of the following points before starting the engine.
- Is the hand brake applied?
  - Is the gearshift in neutral and select the transfer gear according to the road condition?

Depress the clutch pedal (never omit) and turn the key clockwise to the 'ON' position. Next, check the charge indicator, the oil indicator and the fuel gauge. Then move the key clockwise to 'START' to start the engine. The starting motor should not be used longer than 5 seconds at a time. If the engine fails to turn over, wait for 5 seconds or so before trying again. As soon as the engine starts, release the key.

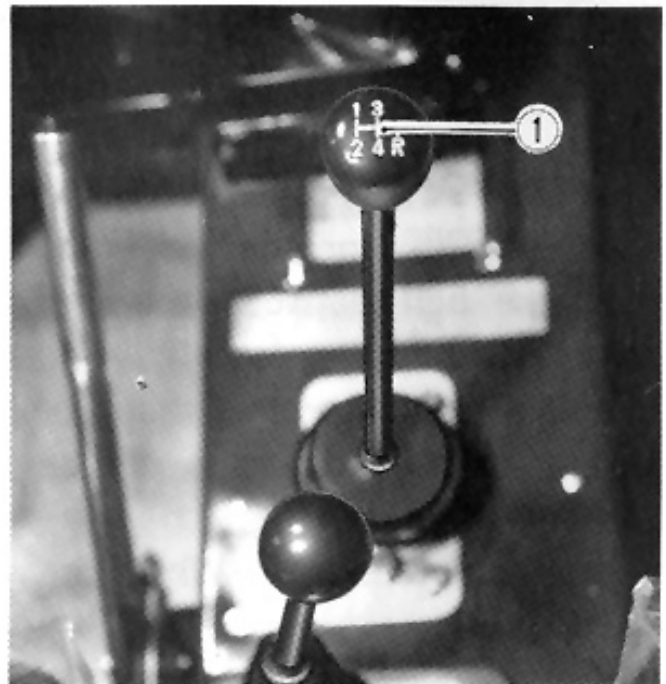

① Neutral position

### \* Starting a cold engine

- Pull the choke out completely.
- Work the clutch pedal.
- Start the engine without using the accelerator.
- Once the engine starts and its rpm increases to some extents, push the choke in half way.

Then, after working the accelerator three at four times, put the car in motion.

- After driving 500 - 1,000 m (0.3 - 0.6 miles) push the choke completely in.

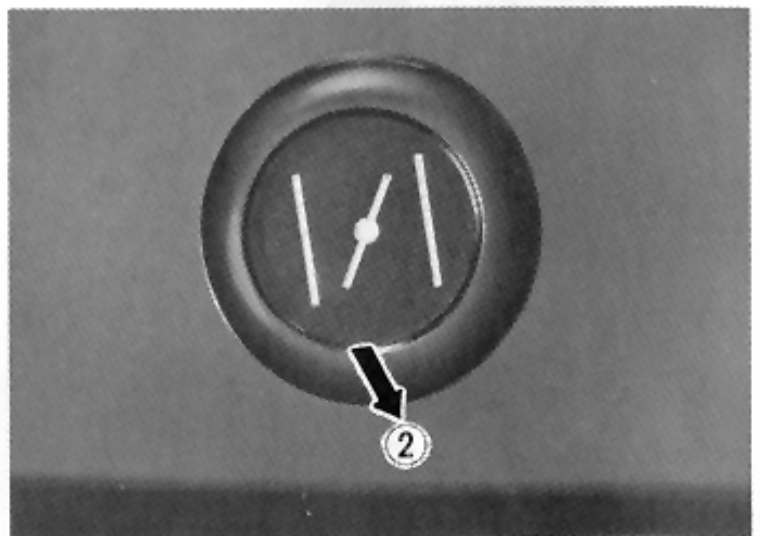

② Pull

## DRIVING THE CAR

First, check all around (front, side and rear) to see if any other vehicles are coming. Depress the clutch while putting the gearshift into low gear. If you experience any difficulty, press down on the clutch again and try again. Once the car is in low gear, release the hand brake and press down on the accelerator slowly while releasing the clutch. Listening to the engine sound is helpful in dealing with the clutch. As you gradually release the clutch there will be a change in the engine's sound. It is at this time that the accelerator is to be depressed, while you continue to ease up on the clutch gradually. Do not use your clutch pedal as a footrest while driving.

Nor should you use a half-depressed clutch to keep the car stationary on a hill. Such misuse of the clutch damages it.

During operation of the car the driver should periodically observe the instruments and indicator lamps. Avoiding sharp brake applications and fast accelerations whenever possible will increase fuel economy.

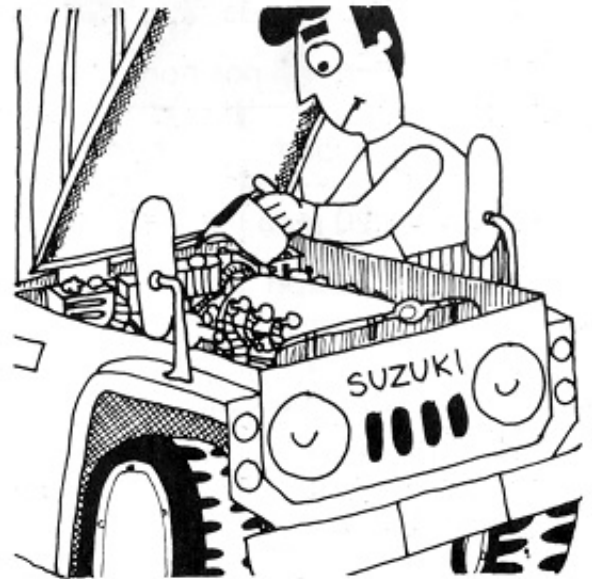

## USE OF THE TRANSMISSION

When changing gears or starting do not race the engine. This shortens the engine life and prevents smooth shifting. All forward speeds are synchronized, which provides for noiseless gearshifting. The synchronization makes gearshifting easy, and only little effort is required to move the control lever. It is not necessary to double de-clutch nor to accelerate in neutral when shifting down.

Good gearshift control refers to keeping the engine rpm always within a certain range regardless of car speed changes. If this is well done, fuel will be conserved and the car's lifespan will be prolonged. To help your gearshift handling, keep the following criterion in mind.

Transfer gear is normal position:

Low	Second	Third	Top
- 10 mph	2 - 20 mph	6 - 34 mph	20 - 50 mph
- 15 kph	5 - 30 kph	10 - 55 kph	30 - 80 kph

Transfer gear is 'H' position:

Low	Second	Third	Top
- 10 mph	2 - 20 mph	6 - 30 mph	13 - 37 mph
- 15 kph	5 - 30 kph	10 - 45 kph	20 - 60 kph

Transfer gear is 'L' position:

Low	Second	Third	Top
- 2 mph	2 - 10 mph	5 - 16 mph	6 - 25 mph
- 5 kph	5 - 15 kph	8 - 25 kph	10 - 40 kph

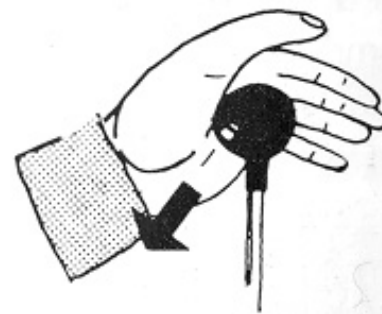

CORRECT

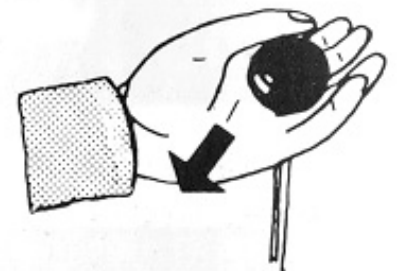

WRONG

It is well known that the distance needed to bring a car to a halt increases with the speed of the car. The braking distance, for example, at 60 kph (37 mph) will be 4 times greater than the braking distance at 20 kph (13 mph). Start to brake the car some distance from the stopping point and slow the car down gradually. Keep in mind that if water gets into the brake drums, the brake system may temporarily fail to work. This may occur when driving in a downpour or where much water has accumulated.

At such times it is helpful to lightly work the brake pedal while you are driving. This should help to dry the brake-shoe and restore braking power.

## HILLS

When driving in mountains and hills this vehicle will not only climb any grade encountered in public road, but off-the-road because of its distinguished gradeability. The most common error made, is delaying a shift into the next lower gear. Many times the vehicle is driven in forth until the engine labors and vehicle speed drops too low to operate in third gear, thus making it necessary to shift into second or even first gear.

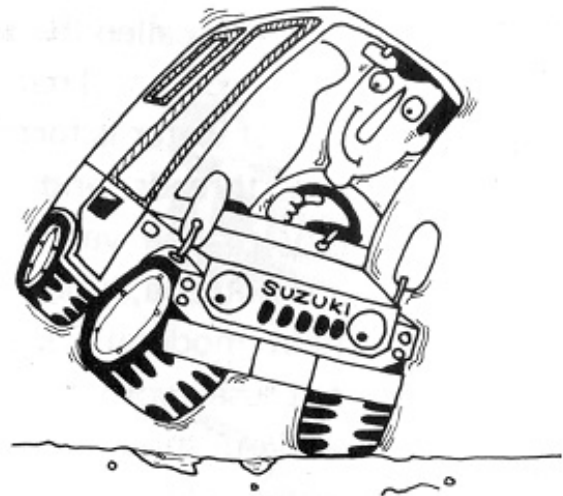

**NOTE:** Never try to avoid gearshifting by slipping clutch.

When descending, it is better to shift into the gear just below the one used when ascending (use third instead of top, for example). This method contributes to safe driving since it employs the engine as a braking power, thus lessening the need to use the foot brake. If only the foot brake is used on hills, a fade phenomenon or vapor-lock may develop which can eventually ruin the brakes.

**NOTE:** **Fade phenomenon**

When the brake-shoe becomes overheated, its frictional force is greatly reduced. Thus, compared with a brake-shoe in good condition, even if the same amount of pressure were expended, the overheated one would produce an exceedingly lengthened stopping distance and a general loss of effectiveness.

This is called the fade phenomenon.

**Vapor-lock**

When the brake fluid in the brake cylinder vaporizes due to overheating of the brake system, the foot brake pedal becomes loose and efficiency is lost. This is called vapor-lock.

## HIGH-SPEED DRIVING

Since tire-thread contact with the ground during high-speed driving in heavy rain is greatly reduced, remember to refrain from sudden acceleration or braking and slow down on any dangerous curves.

When the car is travelling at high speed in a heavy rain or on drenched roads a phenomenon called 'hydroplaning' sometimes occurs. That is, a wedgelike stratum of water is formed between the tire threads and the directional stability of the vehicle.

To avoid such phenomena, you should observe the following points.

Maintain moderate speed (-60 kph, -38 mph)

Do not use worn tires.

If, unfortunately, you should experience such difficulties, first lower the speed by letting up somewhat on the accelerator pedal. Use the steering wheel as usual, but do not use the brake.

## DRIVING ON ICE AND SNOW

To keep the tires from slipping or skidding when driving on ice or snow-covered roads, tire chains, snow tires or studded snow tires can be used. Keep the following suggestions in mind.

- Rather than pressing down hard once on the brake pedal, the pedal should be worked briefly a number of times.
- When starting, refrain from sudden acceleration or too much rpm with no load or a light one.
- Turn the steering wheel bit-by-bit in small movements, rather than great ones, when it is necessary to round a curve.



## TIRE CHAIN

Incorrect use of the tire chains not only will shorten the life of the tires but may also cause a serious accident. Therefore keep the following points in mind.

- Lift up the chain to see if there are any kinks in the links or if it is twisted in any place.
- Then lay out the chain full length on the ground with the hook-tips facing downward. See illustration.
- When the chain is finally attached to the tire, if the hook-tips hit against it, the tire would be damaged.
- As the tire should be at the center of the chain, move the car forward or backward as necessary. For your information, if you are putting chains on only two of the wheels, make sure you put them on the drive wheels (rear wheels).
- After the chain is fitted onto the tire, the two hooks are linked together, both on the inside and outside of the tire, at two places.
- It is helpful to reinforce the chain tension with strong rubber bands and the like.
- After the chain have been on the wheels and the car has been used a while, it is a good idea to check whether the chains are well fitted to the tires.
- Keep a contact watch over the wear and damage to the chain.

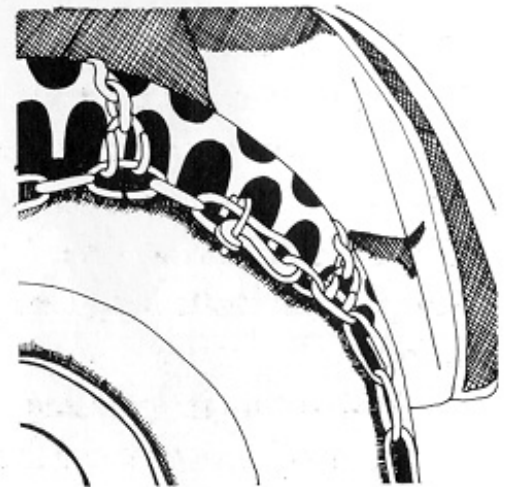
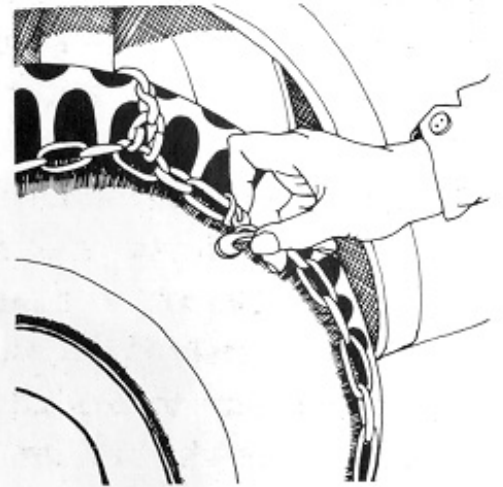

**NOTE:** It is suggested that the length of the chain be adjusted to fit your car's wheels with two links overlapping.

# DO-IT-YOURSELF MAINTENANCE





## PORTABLE WORK TOOLS

The work tools illustrated come with your LJ50 or LJ50V. Use them for your overall check-up, routine repairs and more serious difficulties.

1. Tool case
2. 19 x 22 mm offset box wrench
3. 21 mm box wrench
4. 14 x 17 mm open end wrench
5. 10 x 12 mm open end wrench
6. Combination screw driver
7. Driver handle
8. Box wrench handle
9. Pliers
10. Jack
11. Jack handle

**NOTE:** Jack and jack handle are provided under the driver's seat. To remove them, pull up the jack handle and take off the rubber band which fixes the jack.

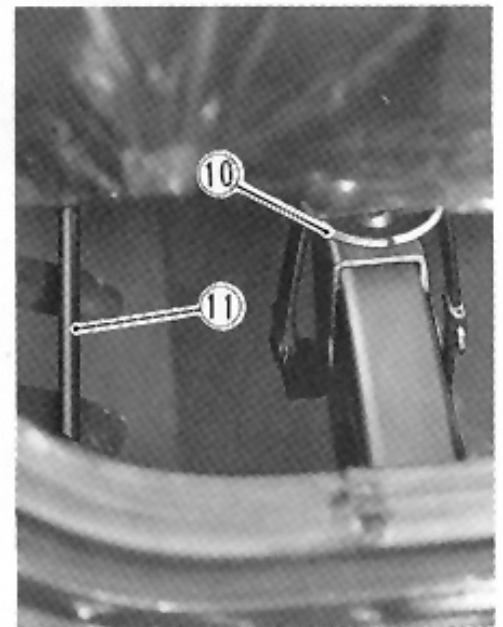
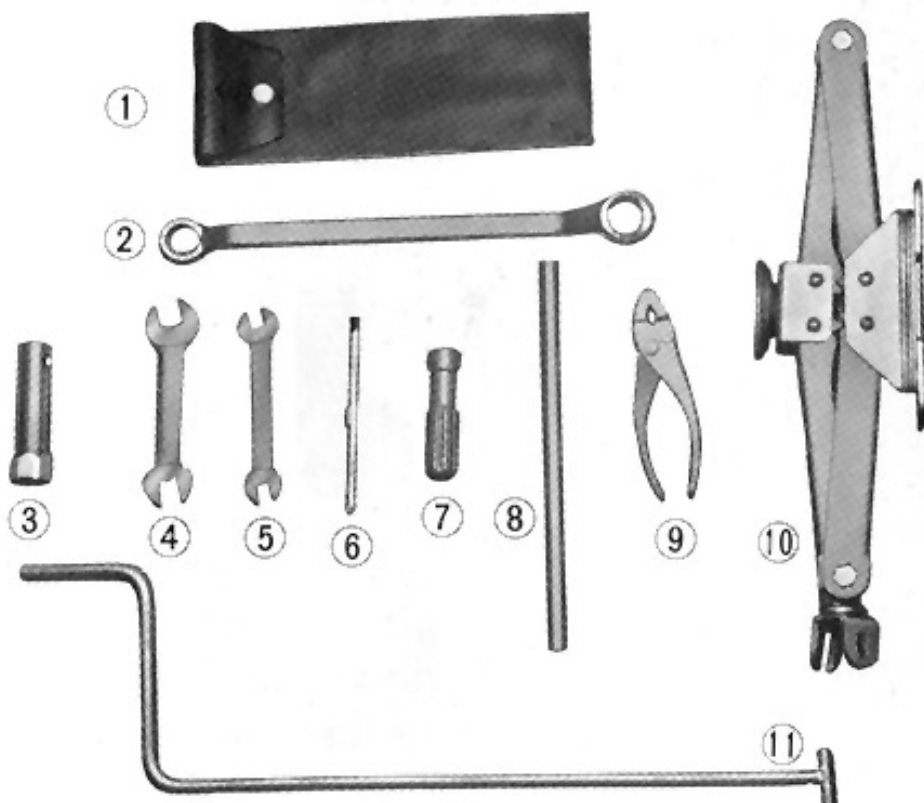

## SPARKPLUG

The NGK B-7HS or NIPPON DENSO W22FS sparkplug is standard for this LJ50 and LJ50V. If the standard sparkplug is unsuitable for your usage, that is apt to overheat (porcelain shows whitish appearance) or get wet (black appearance) change it as follows.

If another brand of sparkplug is to be used other than NGK or NIPPON DENSO, consult your authorized SUZUKI dealer.

**NOTE:** In discriminate experimentation with different brands and heat range of spark-plugs by owner, can, in some cases, cause engine problems. Problems resulting from such tampering would not be subject to warranty coverage.

HEAT RANGE	NGK	NIPPON DENSO	REMARKS
Hotter type	B-6HS	W20FS	If the standard plug is apt to get wet, replace with this plug.
Standard	B-7HS	W22FS	—————
Colder type	B-8HS	W24FS	If the standard plug is apt to overheat, replace with this plug.

When carbon accumulates on the sparkplug, a hot, strong spark will not be produced. Remove carbon deposits with a wire or pin and adjust the spark-plug gap to 0.6 - 0.7 mm (0.024 - 0.028 in).

**NOTE:** When installing the sparkplug, screw it in with your finger, to prevent stripping the threads, then tighten with a torque wrench to 18.0 - 22.0 ft-lb (2.5 - 3.0 kg-m).

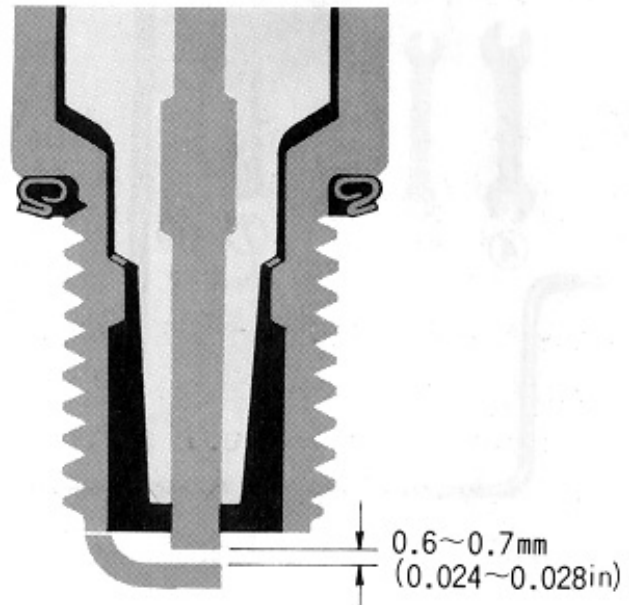
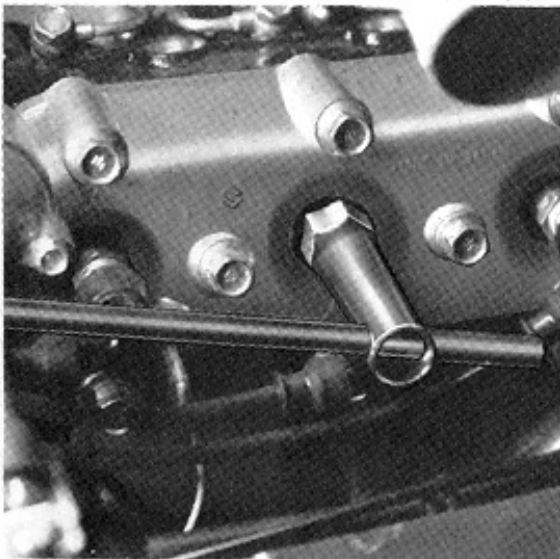

## AIR CLEANER

If the air cleaner is clogged with dust intake resistance will be increased with a resultant decrease in out put and increase in fuel consumption.

Check and clean periodically according to the following procedure.

- Release the hooks, lift off the cap and then remove the element from the cleaner.
- Dismantle the cleaner element.
- Take off the polyurethane filter from the element. Wash the filter with gasoline.
- After wringing gasoline out of the filter, soak it into the Suzuki CCI Oil or engine oil with around SAE #30.
- Wring oil out of the filter and then fit it to the element.

**NOTE:** Clean everytime used in extremely dusty or sandy condition.

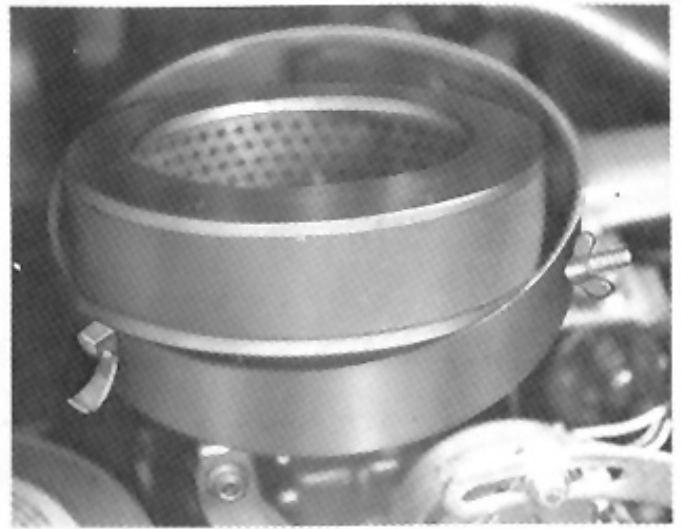

## MAIN FUSE

In case the engine will not start and the electrical equipment also fails to work, check the main fuse which is attached to the battery terminal cord. As it is impossible to judge that the main fuse has melted, check it with the tester. First search for the cause and repair its source, then replace the main fuse.

Main fuse capacity is 30A.

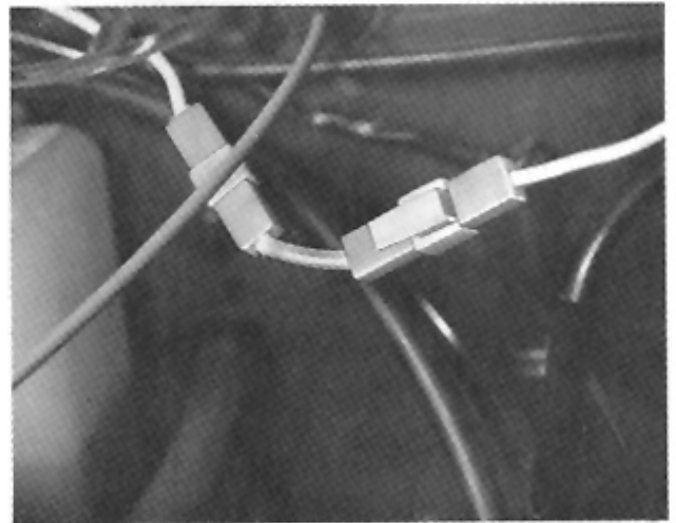

## FUSE BOX

The fuse box is located beneath the right part of the dashboard. The cover of the box can be removed by hand once the box has been pulled out. The fuses, also, are easily removed. When a fuse must be changed, replace with one of same specified capacity, Spare fuses are provided in the fuse box.

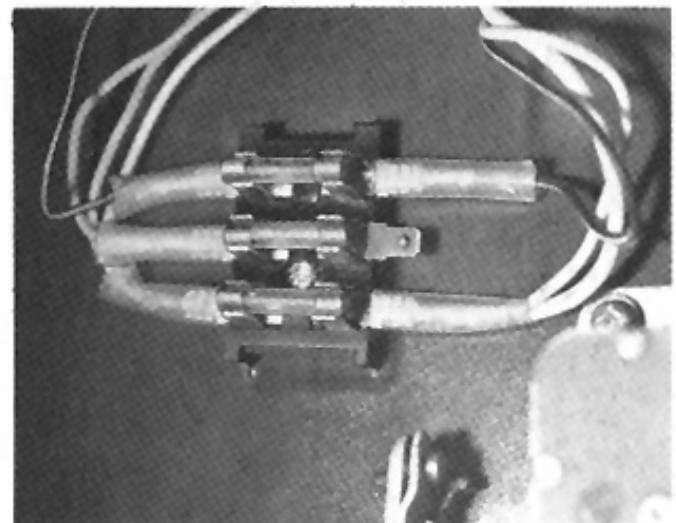

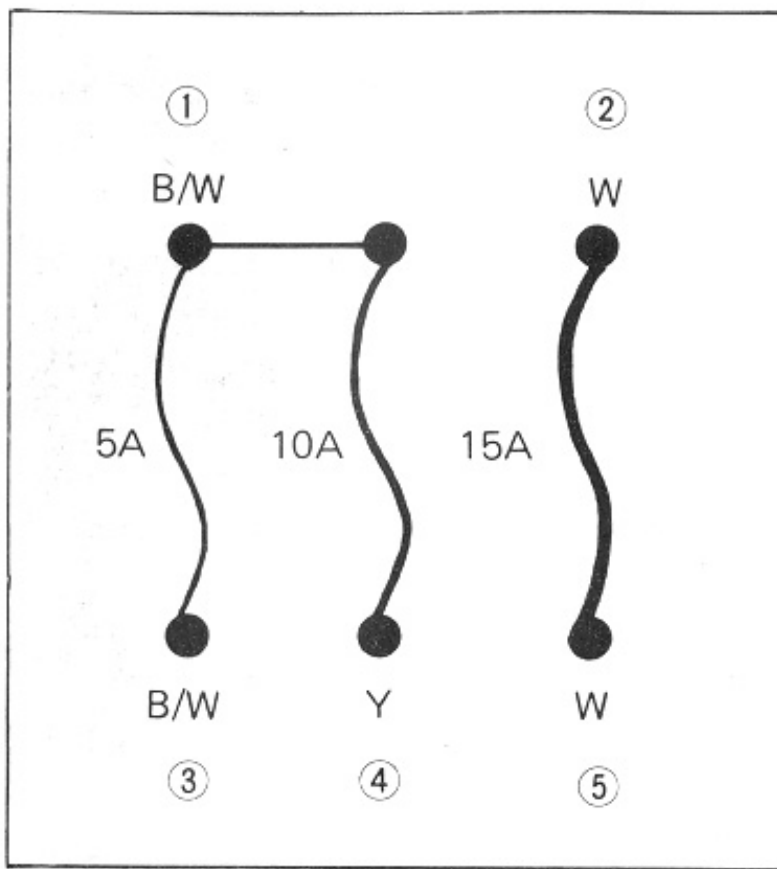

B/W : Black with White tracer

W : White

Y : Yellow

① Connect to Ignition switch

② Turn signal, 4-way flasher switch

③ Oil indicator, Charging indicator lamp and Starting motor

④ Windshield wiper switch, Heater blower switch, Stop lamp switch

⑤ Lighting switch, Room lamp

## BULB REPLACEMENT

### \* Front turn signal lamp

The bulb can be removed for replacement. Loosen the three set-screws holding the plastic cover and remove. Next, slightly push the bulb and turn it counterclockwise and it will come free.

Front turn-signal lamp: 12V 23W

Front parking lamp: 12V 3.4W

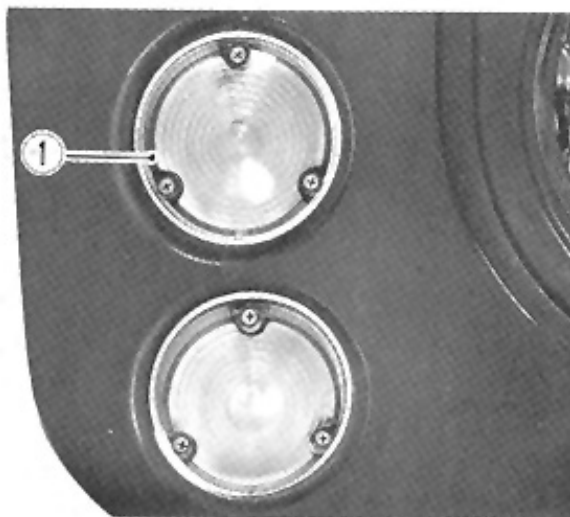

① Front turn signal and parking lamp

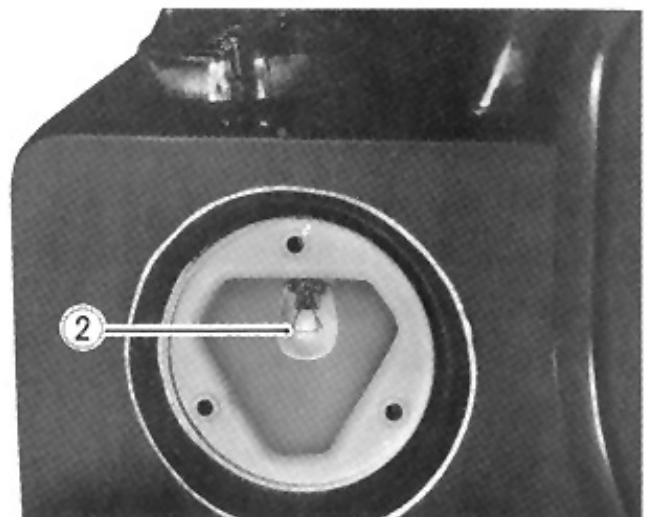

② Bulb

\* **Side turn signal lamp**

Remove the two set-screws holding the plastic cover in place, press the bulb inward slightly and turn it counterclockwise.

Side turn signal lamp: 12V 6W

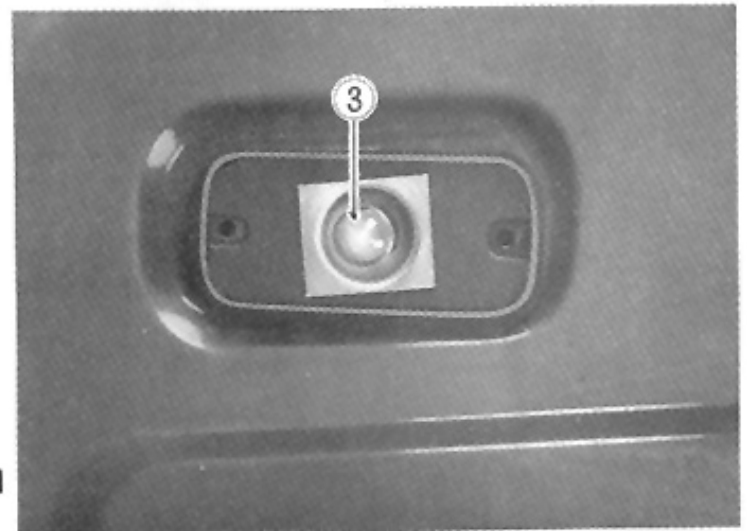

③ Side turn signal lamp

\* **Rear turn signal lamp**

First remove the three set-screws holding the plastic cover and then the cover itself. Press the bulb inward slightly, turn counterclockwise.

Rear turn signal lamp: 12V 23W

Parking lamp: 12V 3.4W

Tail/Brake lamp: 12V 23/8W

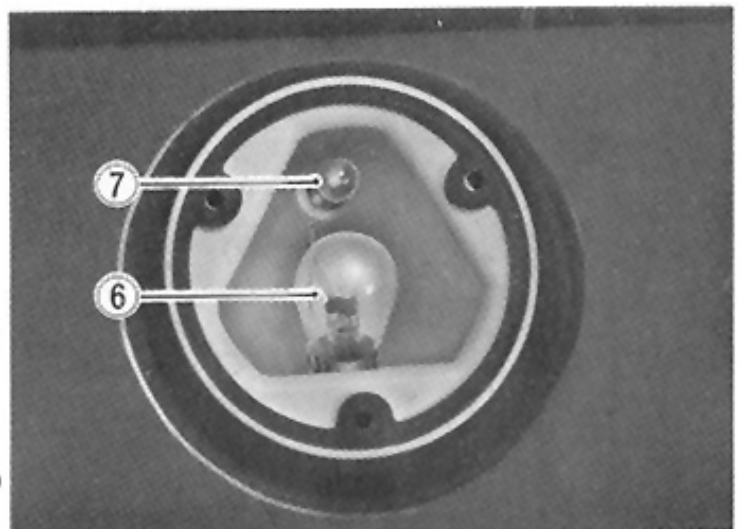

④ Rear turn signal parking lamp  
⑤ Tail/Brake lamp  
⑥ Turn signal bulb  
⑦ Parking bulb

\* **License lamp**

Remove the two set-screws holding the glass and remove glass and whole assembly. Bulb is removed by slightly pressing it and turning it counterclockwise.

License lamp: 12V 10W

① License lamp

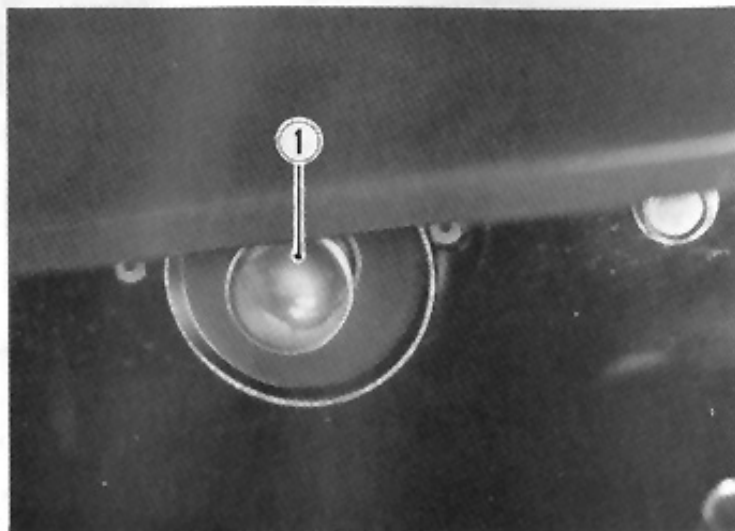

\* **Back-up lamp**

Remove the two set-screws holding the plastic cover and then the cover itself. Press the bulb inward slightly, turn counterclockwise.

Back-up lamp: 12V 10W

② Back-up lamp

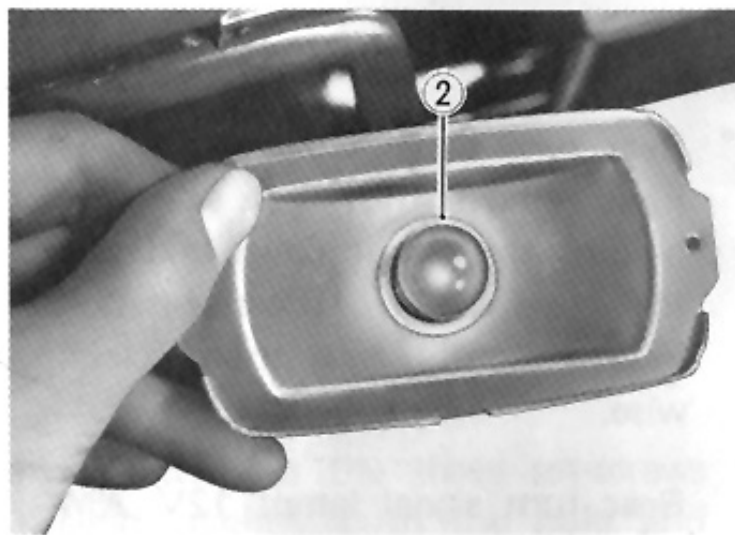

\* **Room lamp**

Pick the plastic cover and remove. Then the bulb is easily extracted.

Room lamp: 12V 5W

③ Room lamp



## TIRE

### \* Tire rotation

To prevent unbalanced wear of your car's tires and to prolong their lifespans, the tire's positions should be changed. An interchange of positions such as that illustrated every 5,000 km (3,000 miles). For your reference, tire rotation will be carried out at the periodic inspections by our dealers and agencies. Please ask us to take care of it at that time. Never fail to check the tire pressure.

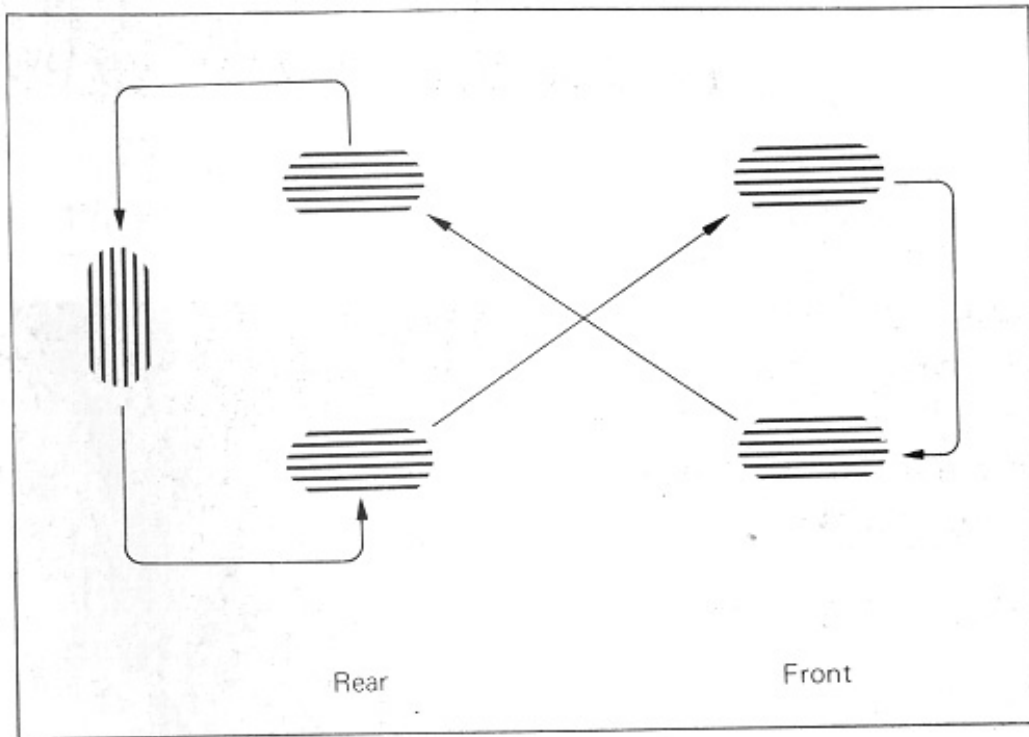

LJ50 spare tire

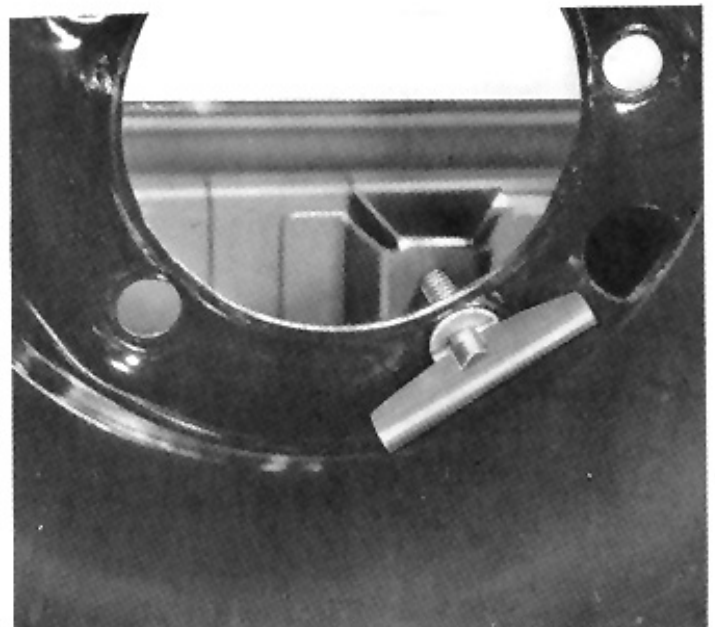

LJ50V spare tire

\* **Changing wheel**

To this job properly, proceed as follows. Place the vehicle possibly on level ground. Move the gearshift lever to the 'Low' or 'Reverse' position and lock wheels by the parking brake and stones, etc..

Using the offset box wrench in the tool kit slacken about one turn the five wheel fixing nuts.

Place jack head under the leaf spring seat, then jack up until the wheel to be removed clears the ground.

Undo the remove the five fixing nuts. Pull off the wheel.

Fit spare wheel so that the hole on the wheel disc may align with the rubber cap on the brake drum.

Screw in the five wheel fixing nuts and tighten uniformly.

Lower the vehicle and disinsert jack. Retighten the five nuts firmly



① **Front wheel jack-up**



② **Rear wheel jack-up**

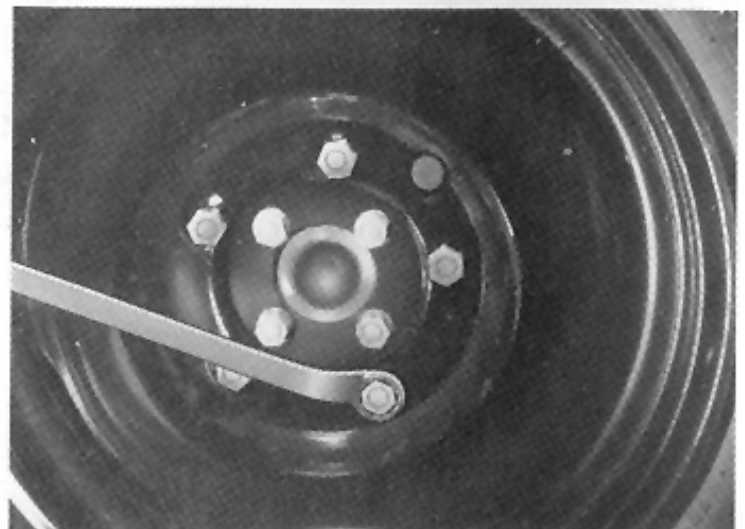



## SOFT TOP AND CANVAS DOOR REMOVAL (LJ50)

### \* Canvas door

Loosen the stopper fixing screws (A) and remove a door holder (B) after loosening two fitting screws and take out the door lifting up slightly.

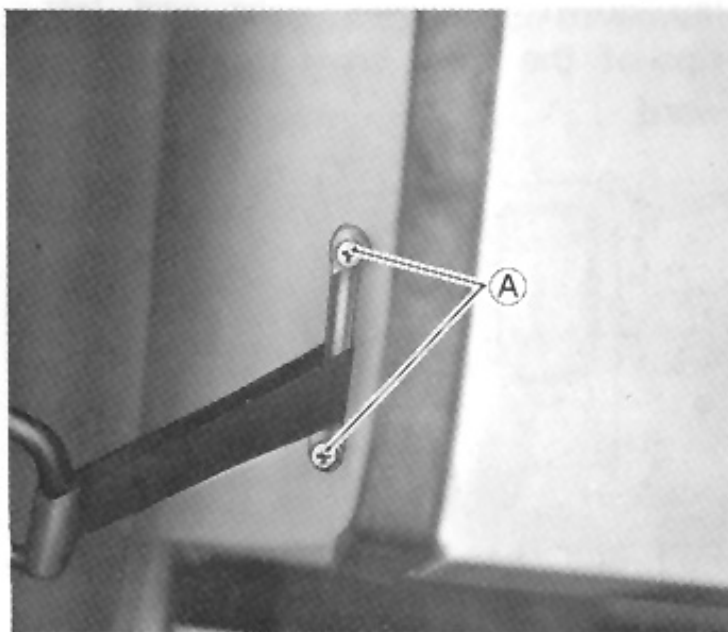

### \* Soft top

Roll the rear curtain as described on page 30. Remove all soft top fitting clasps and hooks and unlace the soft top from the frame.

Take out the rear cross top bow (C) from right and left brackets after slackening the wing nuts (D). Slacken right and left top bow rail knobs (E)

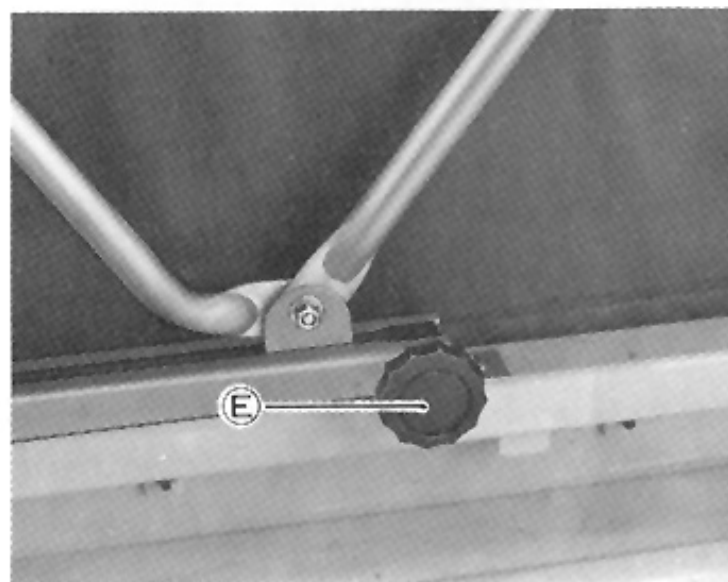
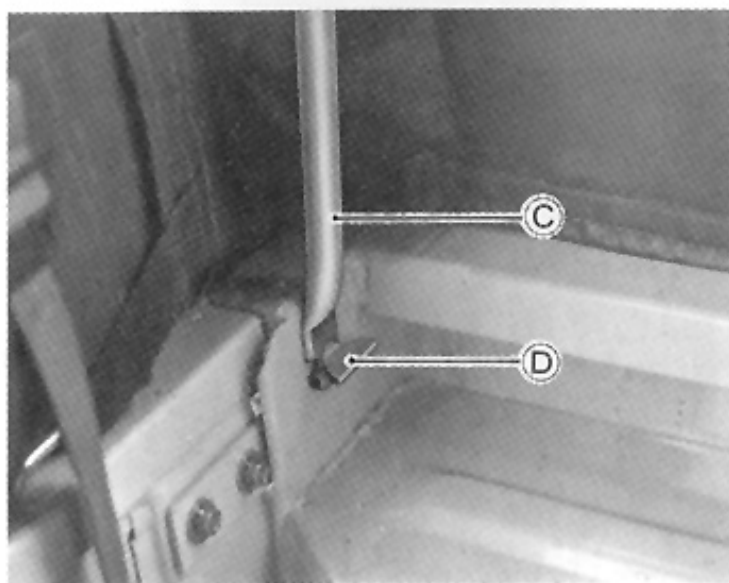
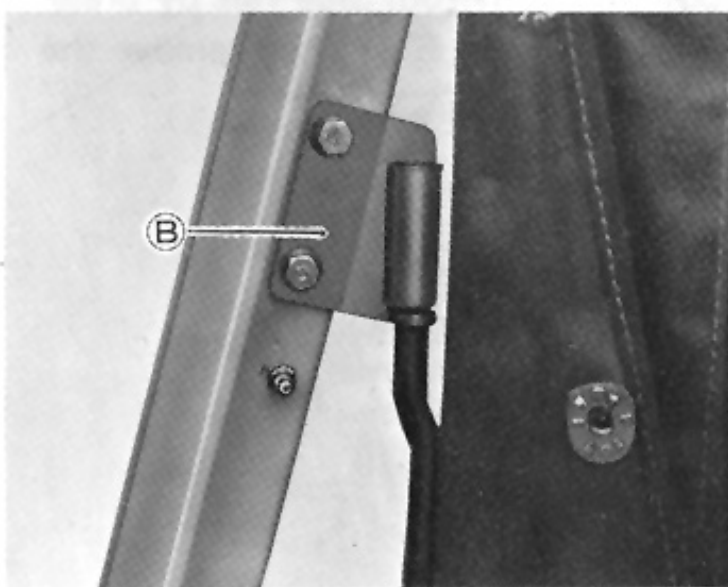

Take out the front cross top bow (A) from the front roof rail (B) and lay down it sliding right and left tips of the front cross top bow forward.

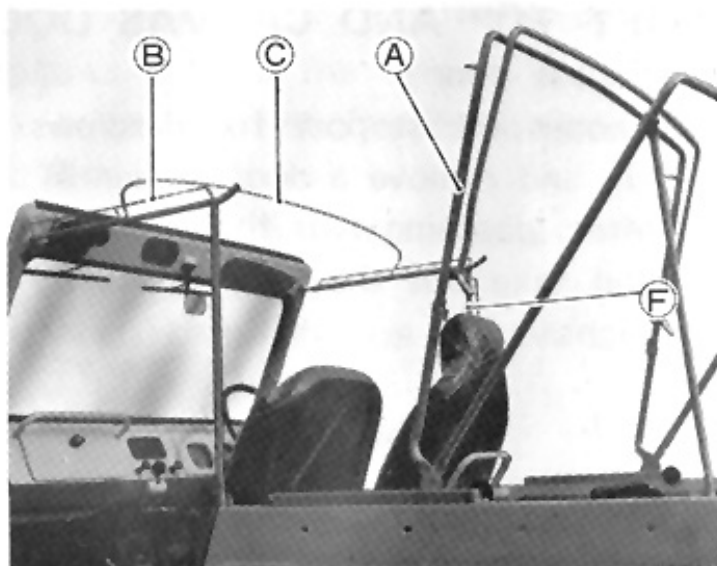

Pull out the front top bow (C) on the front roof side rail (D) and take out the front roof side rail by pressing the springs (E). Then remove the center pillars (F).

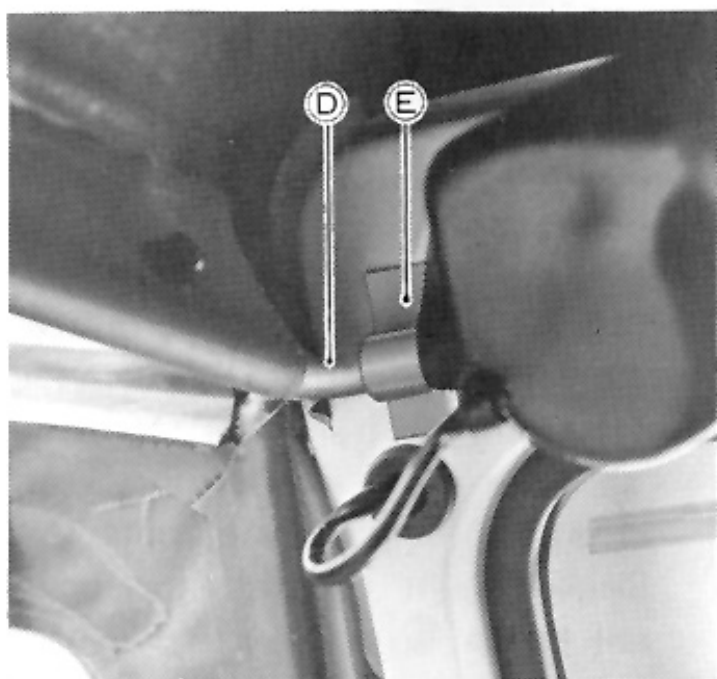

## CLEANING THE CAR

Dirt on a car not only harms its appearance but also affects car quality, leading eventually to a shorter lifespan for the car. Therefore, clean your car every chance you get - - - on Sundays or holidays, for example.

### \* Dusting

Clean the dust from the car with a feather duster rather than a dry cloth which may scratch or otherwise mar the finish.



### \* Washing with water

#### — Body

From top to bottom, pour water over the car and wash with a soft brush or a sponge. Do not use high-pressure water or steam directly on the car lest the finish be damaged.



### \* Tires

Refrain from dashing water directly on the tires lest some water enter the brake drum and harm the brakes. Use a brush to clean tires. (When using soapsuds, make sure all soapsuds are rinsed away.)

#### — Chassis, wheels and their related parts

These parts especially are subject to being smudged with oil and mud. Wash with high-pressure water. It is often necessary to use a steam cleaner. Moreover, if some of the rust-proofing has peeled from springs and suspension-related parts, give them a new coating of rust-proof paint.

\* **Removing moisture**

Remove any dampness with a soft cloth. Completely remove any moisture on windows or other parts.



\* **Waxing**

Put wax on the body surface and then apply it evenly with a soft cloth. After the wax dries sufficiently, polish car with a soft dry cloth.

Waxing should be done at least twice a month in order to keep the finish glossy.



**NOTE:** While polishing your car, if you should find a place that is peeling, check with your SUZUKI dealer or agency for repair. If you allow the flaw to remain, it will in time become an extensive (perhaps irreparable) rust corrosion. At this point it is readily repaired with a brush and some paint.

## HINTS FOR PROTECTING THE FINISH

- \* Wash your car as often as possible. In general, dirt is difficult to remove and, if left some time, many become irremovable. Also, leaving such alien particles to work their way into the finish will lead to all sort of adverse effects to the car's finish. Beware of such dangers.
- \* Avoid parking your car near factories with smoking chimneys, railroad sidings and street lights. Chimney smoke, dust, excretions and sap are all detrimental to the car's paint. Use some kind of cover, if necessary.
- \* Do not park by a construction site. A construction site can be very dangerous because of the sparks from welding and, sometimes, falling material.
- \* When you notice small rust spots coming from iron powder, wipe repeatedly with a soft cloth or sponge damaged with a special detergent. The detergent is made of a mixture of 1 - 2 spoonfuls of neutral cleaner, 200 - 250 g (0.44 - 0.55 lb) of oxalic acid and 5.0 ℓ (1.32/1.10 US/Imp gal) of water. Rinse afterward to completely remove mixture. If washing is not sufficient, a stain will remain.
- \* When smuges from chimney smoke and stains from insects, sap, fertilizer, etc. are left on your car, burnish with a polishing compound and wax after the car has been thoroughly washed with water.



## SAFEKEEPING

In general, a car is unused as much as half a day. Therefore the body finish and other parts - especially the chrome-plated metal parts - - need good safe-keeping methods if they are to remain in fine condition.

Consider the following points.

### \* Garage

- Housing the car in a garage is best. But keep it away from direct sun light, wind and rain as much as you can. If you do not have a garage, use a cover.
- Avoid parking the car in muddy, wet places. Select a dry spot and thus protect the tire's condition.
- In case of some calamity such as a flood, remember to get the car out of the garage and off to safety.

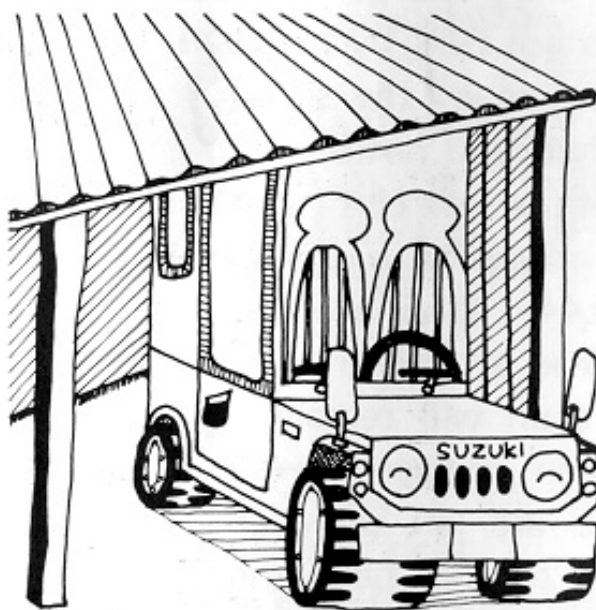











### \* Wintercome suggestions

As is well known, temperature varies with the place chosen. And can even vary within the same garage. With this in mind, position the car in the garage so that the motor end is where the temperature is highest and thus most protected from the cold. Thus you will be able to start the engine easier on cold mornings. When you leave your car outside, it is advisable to park it with the engine end in the lee of a building or on the leeward side of a building. If the car will be parked a long time, use a car cover.



## NOTICE

The following list shows the important safety parts which might cause unforeseen accident if these are serviced to the condition other than the factory's specification. Therefore, if you yourself are to service the vehicle, please limit your maintenance to the items excluding the following and take your authorized dealer whenever the required maintenance involves the following items.

-  BRAKE PEDAL ADJUSTMENT
-  CARBURETOR ADJUSTMENT
-  CLUTCH ADJUSTMENT
-  FUEL FILTER REPLACEMENT
-  HEADLAMP ADJUSTMENT AND REPLACEMENT
-  IGNITION TIMING
-  INSTRUMENT PANEL BULB REPLACEMENT
-  OIL PUMP ADJUSTMENT
-  PARKING BRAKE ADJUSTMENT
-  STEERING PLAY ADJUSTMENT
-  WHEEL ADJUSTMENT

# TROUBLE SHOOTING AND EMERGENCY REPAIRS

## FIRST OF ALL, IF

- \* Somewhat different tones from usual ones.
- \* An unusual sound is heard from somewhere unknown.
- \* A strange odor is detected.

If these symptoms occur, consult with your SUZUKI dealer or agency about an inspection as soon as possible. This is the way to prolong your car's life.

## WHEN THE STARTER MOTOR FAILS TO WORK

Check to see if headlamps and horn are all right.

- \* If they work all right, the trouble is in the ignition switch.
- \* Consult a SUZUKI dealer or agency.
- \* When they fail to work, or work only feebly.

There are three causes to be considered: the fuse, a discharged battery, or the wrong contact at the battery terminal. Check the main fuse and the fuses inside the fuse box. Remove and polish the battery terminal. Notwithstanding these checks, if the problem remains, the answer is a discharged battery.

Charge the battery at once.



## IN CASE THE STARTER WORKS, BUT THE RPM ARE TOO SLOW, A DISCHARGED BATTERY IS TO BLAME.

In this case, we suggest as follows. Switch the ignition to 'ON', put the gear-shift into 'THIRD' and keep the clutch depressed while two or three persons you asked for help push the car forward. When the speed gets up to 10 kph (6 mph) or thereabout, release the clutch pedal to make the engine start.



## WHILE THE STARTER WORKS, THE ENGINE FAILS TO START

First, check the fuel gauge and see if there is any gasoline.

### \* What about the fuel?

If the fuel doesn't enter the carburetor, it means something is wrong either in the fuel pipe or in the pump.

### \* How about the sparkplug?

If the sparkplug are dirty, or if you have used different ones from those specified, change them immediately.

The sparkplug gap should be in a range of 0.3 - 0.4 mm (0.024 - 0.028 in). The sparkplug must always be clean. If its ceramic part is incrustated with dust, electricity fails to run into the plug's electrode because it goes into the dust incrustated ceramic part. The reason is that dust tends to absorb moisture, thereby developing into a good conductor of electricity. Because of this, the sparkplug - - - especially the ceramic part - - - must be clean. If water splashes onto it, wipe the plug completely at once.

### \* Is the fuel intake too great?

When starting the engine, if you pump the accelerator this will cause excessive intake of fuel into the combustion chamber. This cause a dampening of the sparkplugs and hence the engine becomes hard to start. In this case, having shut off the choke completely fully depress the accelerator once only and then proceed to actuate the starter, holding it on for 5 seconds at a time. You may repeat this process with the starter 2 or 3 times (remember to keep the accelerator pedal depressed during the operation).



## ENGINE POWER IS WEAK AND ACCELERATION IS POOR

- \* Are the sparkplugs in good condition?

In both cases any or all of the sparkplugs may be dirty and may be subject to leakage. Engine power decreases.

- \* Is the ignition timing correct?
- \* Is the air-cleaner clogged?

When a car runs on dusty roads it often occurs that the air-cleaner gets clogged and engine power decreases to a great extent. Take the element out of the cleaner and wash the filter.

- \* Is the air pressure of the tires extremely low, it not only deteriorates tire performance, but is dangerous as well.
  - \* Is the parking brake off?
- Check to see if you hard released the parking brake.



## THE BRAKE IS A LITTLE STARNGE

If the brake loses efficacy, the resiliency of the pedal decreases and the resistance of the steering wheel causes it to become heavier than ever before, consult with a SUZUKI dealer or agency service department.

This is only a suggestion for consideration. Sometimes, when you drive through many puddles, or immediately after you've had your car washed there is poor braking. However, if you pump the brake

a number of times while driving, the braking power will soon be restored to normal.



## OVERHEAT

### \* What does 'overheat' mean?

There is a breakdown of some sort in the cooling mixture of the radiator so that if the engine is forced the radiator temperature rises extremely high, and the engine performance decreases precipitately. If overheating and take prompt action.

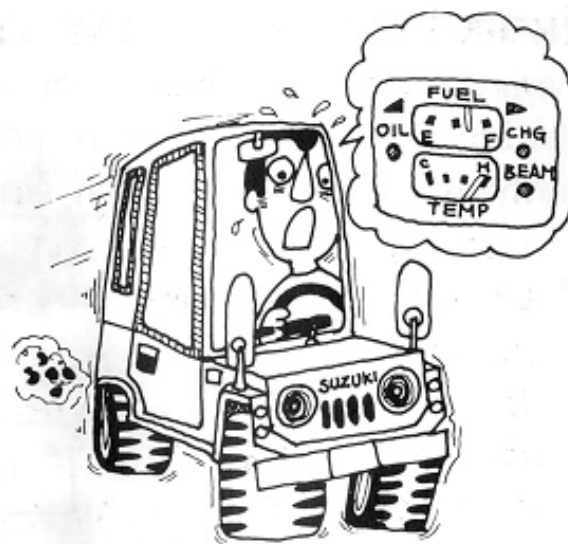

### \* Measures to be taken when car overheats

- Stop the car.
- Idle the engine, do not turn it off.
- Take in more air by opening the engine cover in the front.
- When the temperature gauge needle returns to the normal temperature range, stop the engine.
- Release steam from the overflow pipe by loosening the radiator cap little by little (with a cloth around cap for protection) till steam escapes. Then completely remove cap.
- If radiator mixture is depleted, refill.



**NOTE:** When the temperature fails to drop while the engine is idling, stop the engine.

### ATTENTION:

- Do not take the radiator cap off in a hurry since that is dangerous. Steam or hot water may blow out and hurt you.
- Do not change all of the radiator watercoolant mixture at one time, even if you are in a hurry. For the cylinder block and cylinder head are vulnerable to sudden temperature changes and may be damaged.



## NOTICE

When a trouble occurs with a vehicle, it is important to find the source of the trouble as rapidly as possible tracing it systematic procedure without bothering with parts which are functioning properly.

### \* Starter motor will not spin

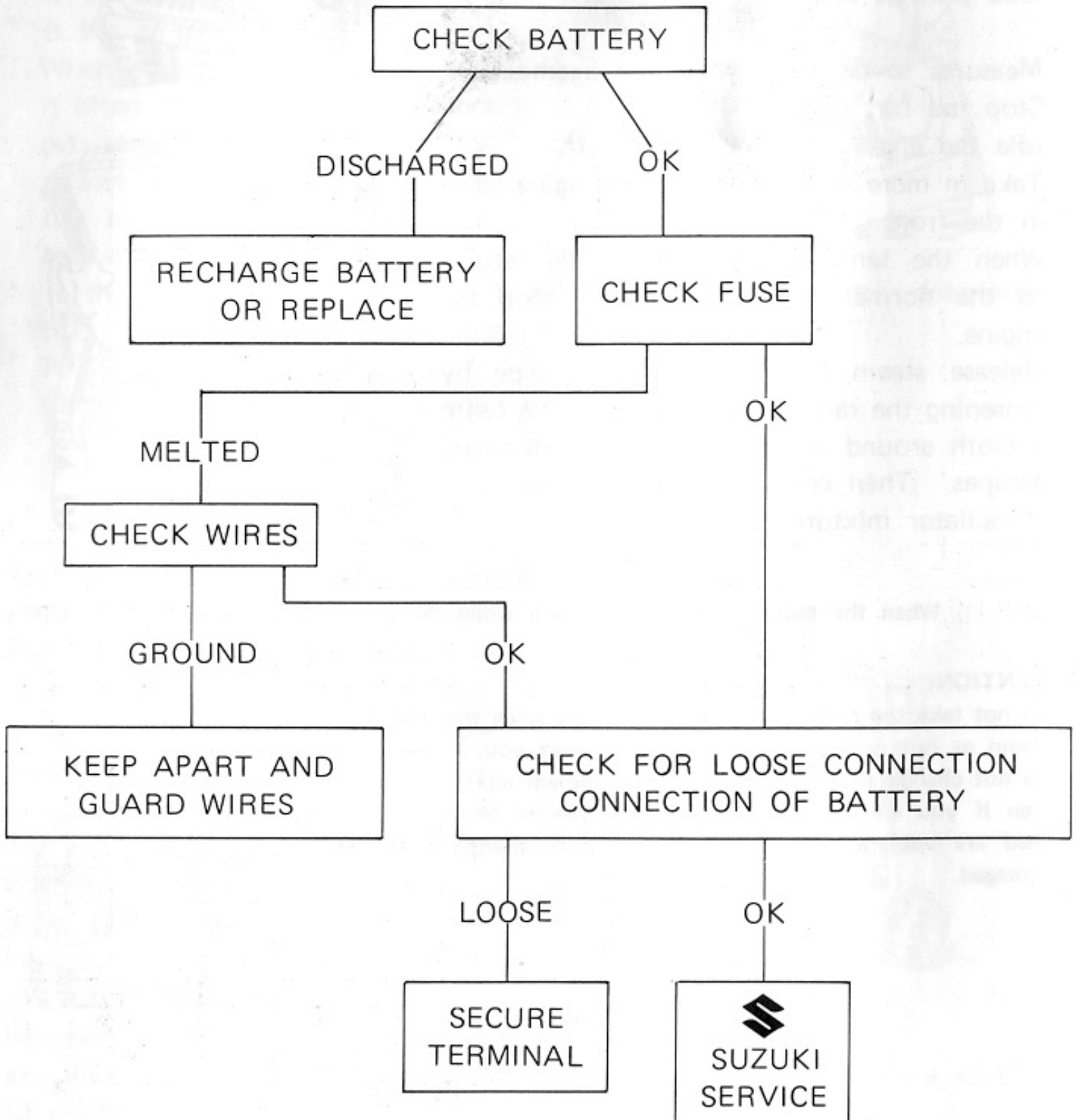

\* Engine does not start or does not run smoothly

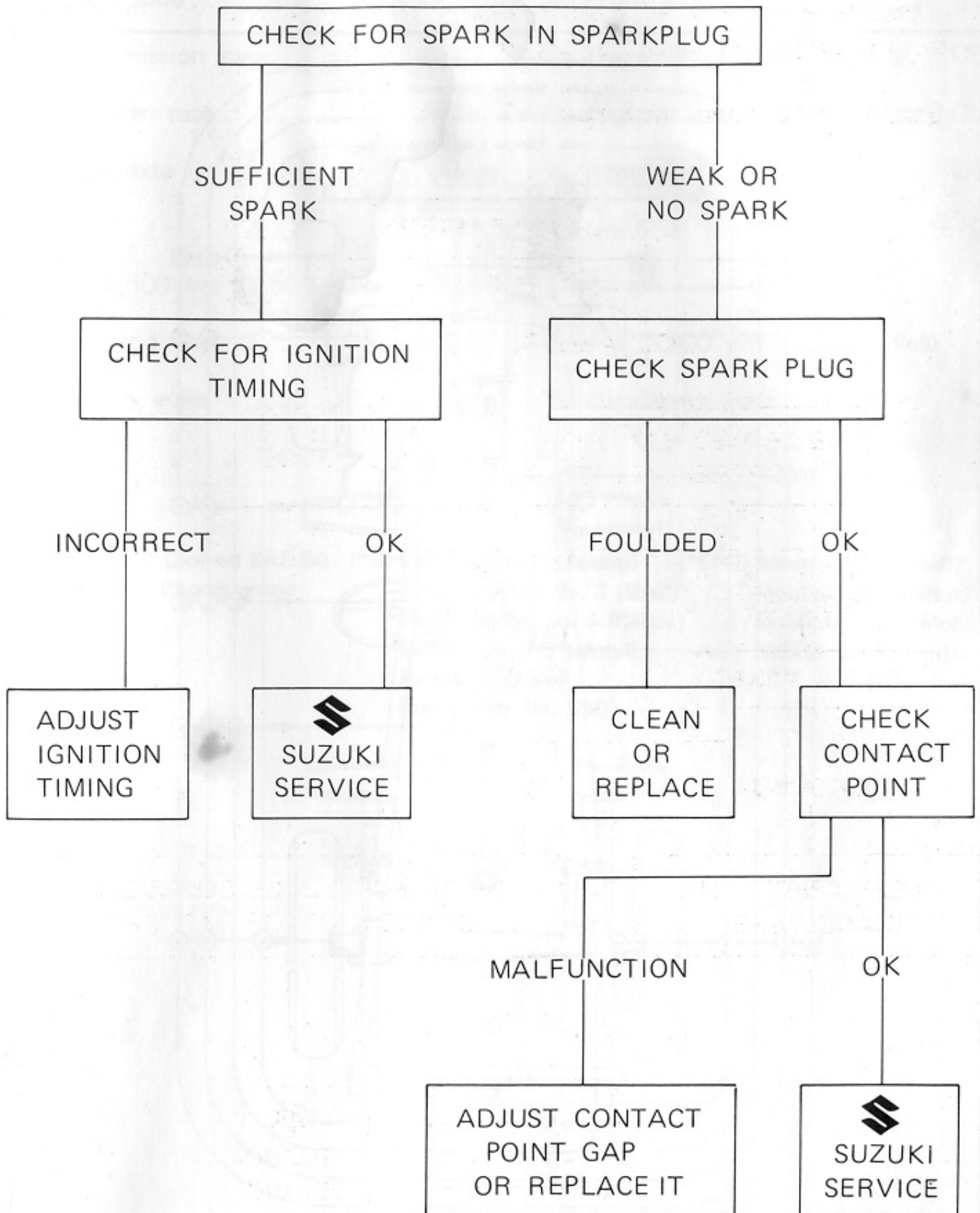

# LUBRICATIONS CHART

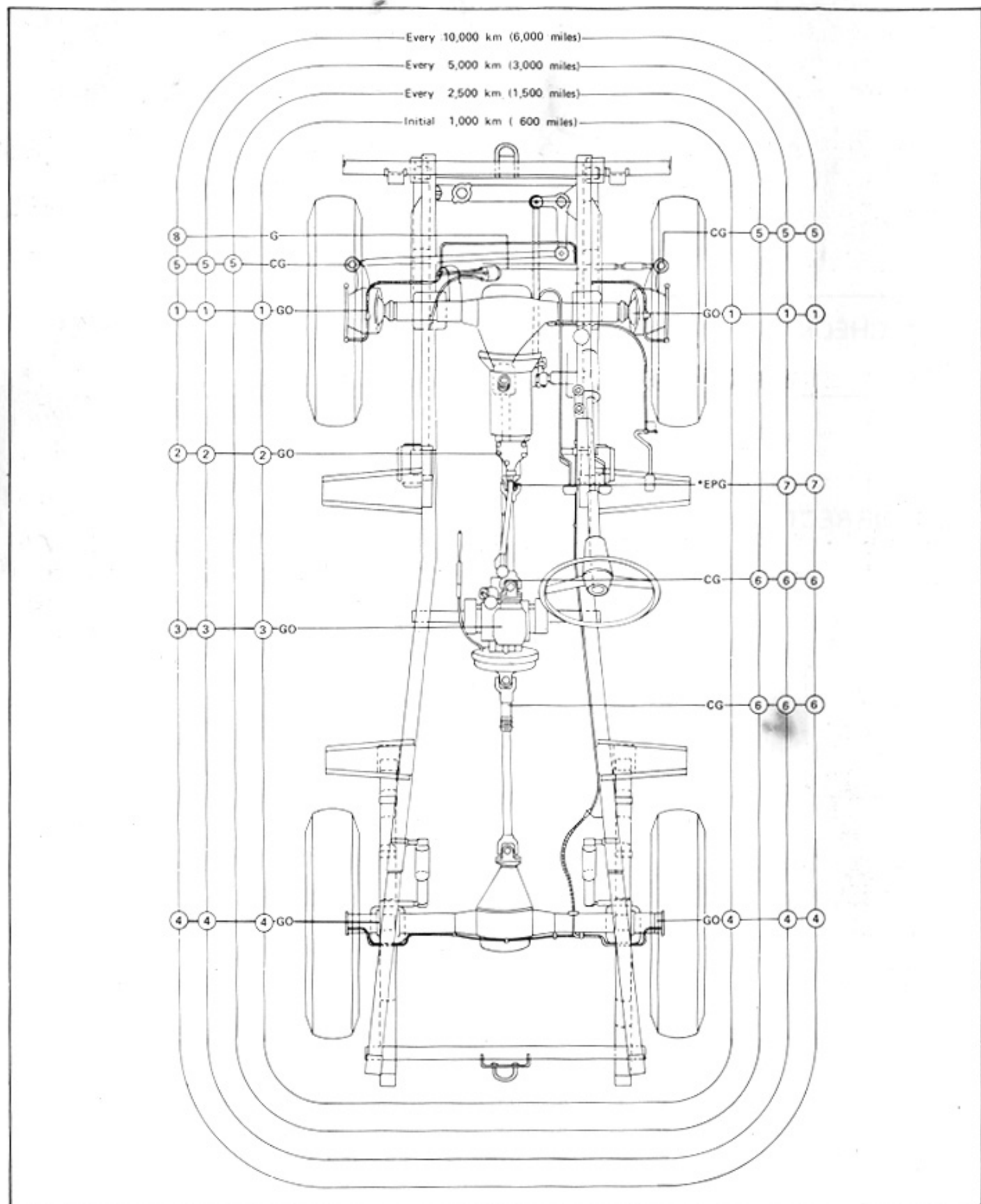

Initial 1,000 km (600 miles)

1. Front axle . . . . . GO
2. Transmission case . . . . . GO
3. Transfer case . . . . . GO
4. Rear axle . . . . . GO

Every 2,500 km (1,500 miles)

5. Tie rod end . . . . . CG
6. Sliding yoke . . . . . CG

Every 5,000 km (3,000 miles)

1. Front axle . . . . . GO
2. Transmission case . . . . . GO
3. Transfer case . . . . . GO
4. Rear axle . . . . . GO
7. Universal joint . . . . . \*EPG

Every 10,000 km (6,000 miles)

8. Distributor gear . . . . . \*G

NOTE: (GO) Gear oil SAE 80 (\*G) Super grease C (Suzuki) (\*EPG) Albania EP2 (Shell)  
 (CG) Chassis grease Albania grease No. 3 (Shell) Multifak EP2 (Caltex)  
 Regal Starfak No. 3 (Caltex) Mobilplex No.2 (Mobil)  
 Mobilux No. 3 (Mobil) Nebula EP2 (Esso)  
 Andok C (Esso)  
 Cup grease No. 250

# PERIODIC INSPECTION CHART

Maintenance items	Initial 1,000 km (600 miles)	Every 2,500 km (1,500 miles)	Every 5,000 km (3,000 miles)	Every 10,000 km (6,000 miles)	Remarks
Steering	<input type="radio"/>	<input type="radio"/>	<input type="radio"/>	<input type="radio"/>	Check play
Steering rod & arm		<input type="radio"/>	<input type="radio"/>	<input type="radio"/>	
Wheel alignment			<input type="radio"/>	<input type="radio"/>	
Brake pedal		<input type="radio"/>	<input type="radio"/>	<input type="radio"/>	
Brake lever & cable		<input type="radio"/>	<input type="radio"/>	<input type="radio"/>	below 7 teeth
Brake hose & pipe		<input type="radio"/>	<input type="radio"/>	<input type="radio"/>	check leakage
Brake oil		<input type="radio"/>	<input type="radio"/>	<input type="radio"/>	Change every 2 years
Brake drum & shoe		<input type="radio"/>	<input type="radio"/>	<input type="radio"/>	
Proportioning valve					replace every 2 years
Tire		<input type="radio"/>	<input type="radio"/>	<input type="radio"/>	
Wheel & hub nut	<input type="radio"/>		<input type="radio"/>	<input type="radio"/>	
Tire rotation			<input type="radio"/>	<input type="radio"/>	
Shockabsorber			<input type="radio"/>	<input type="radio"/>	
Clutch play		<input type="radio"/>	<input type="radio"/>	<input type="radio"/>	
Clutch disc		<input type="radio"/>	<input type="radio"/>	<input type="radio"/>	
Drive shaft				<input type="radio"/>	
Engine oil pump & pipe	<input type="radio"/>		<input type="radio"/>	<input type="radio"/>	
Distributor cap		<input type="radio"/>	<input type="radio"/>	<input type="radio"/>	
Ignition timing	<input type="radio"/>		<input type="radio"/>	<input type="radio"/>	8° B.T.D.C. 1,000 rpm
Sparkplug		<input type="radio"/>	<input type="radio"/>	<input type="radio"/>	clean every 2,500 km (1,500 miles)
					replace every 5,000 km (3,000 miles)
Battery			<input type="radio"/>	<input type="radio"/>	gravity 1.20 – 1.28 (68° F 30°C)



Maintenance items	Initial 1,000 km (600 miles)	Every 2,500 km (1,500 miles)	Every 5,000 km (3,000 miles)	Every 10,000 km (6,000 miles)	Remarks
Air cleaner element		<input type="radio"/>	<input type="radio"/>	<input type="radio"/>	replace every 20,000 km (12,000 miles)  clean every 2,500 km (1,500 miles)
cylinder head & manifold				<input type="radio"/>	retighten
Carburetor link		<input type="radio"/>	<input type="radio"/>	<input type="radio"/>	
Carburetor choke valve		<input type="radio"/>	<input type="radio"/>	<input type="radio"/>	
Fuel filter					replace every 40,000 km (24,000 miles)
Water pump & alternator belt		<input type="radio"/>	<input type="radio"/>	<input type="radio"/>	
Coolant					change every 2 years
Muffler			<input type="radio"/>	<input type="radio"/>	
Door lock			<input type="radio"/>	<input type="radio"/>	check

# WIRING DIAGRAM

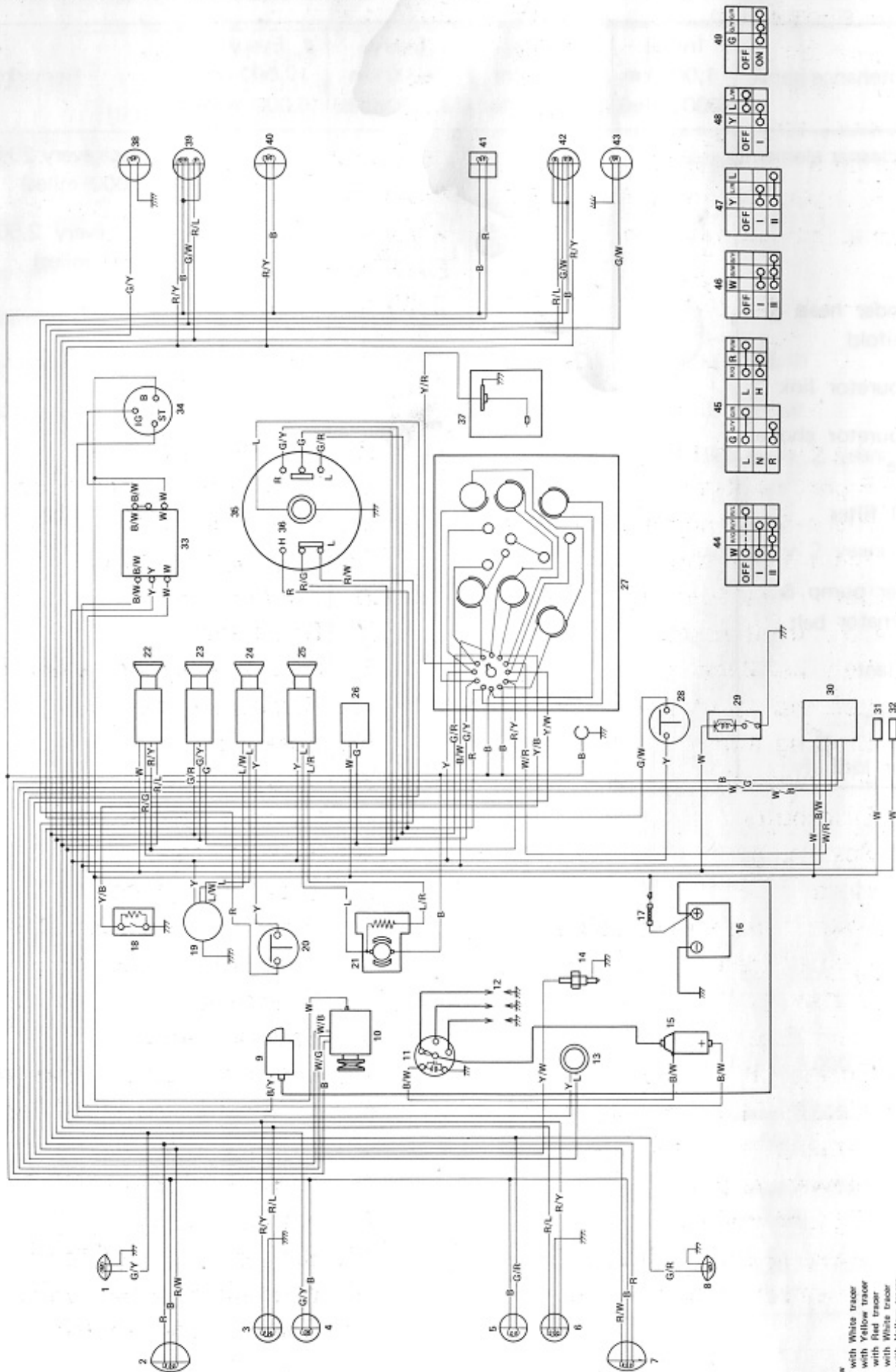

- B : Black
- G : Green
- L : Blue
- R : Red
- W : White
- Y : Yellow
- B/W : Black with White tracer
- B/Y : Black with Yellow tracer
- G/R : Green with Red tracer
- G/W : Green with White tracer
- G/Y : Green with Yellow tracer
- L/R : Blue with Red tracer
- L/W : Blue with White tracer
- R/G : Red with Green tracer
- R/L : Red with Blue tracer
- R/W : Red with White tracer
- R/Y : Red with Yellow tracer
- W/B : White with Black tracer
- W/R : White with Red tracer
- Y/B : Yellow with Black tracer
- Y/W : Yellow with White tracer

Headlamp *	12V	50/40W x 2
Turn signal lamp	12V	23W x 4
License lamp	12V	10W
Room lamp	12V	5W
Back-up lamp	12V	10W
Side turn signal lamp	12V	6W x 2
Front combination lamp	12V	8/34W x 2
Rear combination lamp	12V	23/8W 3.4W x 2
Instrument lamp	12V	3.4W x 6

- Right side turn signal
- Right headlamp
- Right front combination lamp
- Right front turn signal lamp
- Left front turn signal lamp
- Left front combination lamp
- Left headlamp
- Left side turn signal lamp
- Starting motor
- AC generator
- Distributor
- Sparkplug
- Horn
- Water temperature gauge
- Ignition coil
- Battery
- Main fuse
- Engine oil level gauge
- Windshield wiper motor
- Back-up lamp switch
- Blower motor
- Lighting switch
- 4-way flasher switch
- Windshield wiper switch
- Blower motor switch
- Turn signal/4-way relay
- Instrument panel lamp
- Stop lamp switch
- Room lamp
- Regulator
- Cigarette lighter terminal
- Radio terminal
- Fuse box
- Ignition switch
- Combination switch
- Horn button
- Fuel level gauge
- Right rear turn signal lamp
- Right rear combination lamp
- License lamp
- Back-up lamp
- Left rear combination lamp
- Left rear turn signal lamp
- Lighting switch
- Turn signal and Dimmer switch
- Ignition switch
- Blower motor switch
- Windshield wiper switch
- 4-way flasher switch

# TIGHTENING TORQUE OF IMPORTANT PARTS

It is necessary to retighten these items as shown below every 2,500 km (1,500 miles). Have your vehicle check to an authorized SUZUKI dealer.

Item	Q'ty	Tightening torque (kg-cm)
Nut, plate spring shackle	8	250 ~ 700
Nut, spring	4	400 ~ 800
Nut, U bolt	16	300 ~ 450
Nut, wheel	20	500 ~ 800
Nut, front wheel shaft	2	1500 ~ 2700
Nut, rear hub	8	500 ~ 800
Bolt, king pin	16	200 ~ 300
Nut, steering rubber joint	4	150 ~ 250
Bolt, rubber joint flange	2	300 ~ 400
Bolt, steering gearbox	3	700 ~ 900
Bolt, gearbox stay	1	350 ~ 550
Nut, rear backing plate	8	180 ~ 280
Bolt, cross joint flange yoke	24	150 ~ 250

MEMO



[The rest of the page contains extremely faint, illegible text that appears to be bleed-through from the reverse side of the document.]



KOSAI PLANT

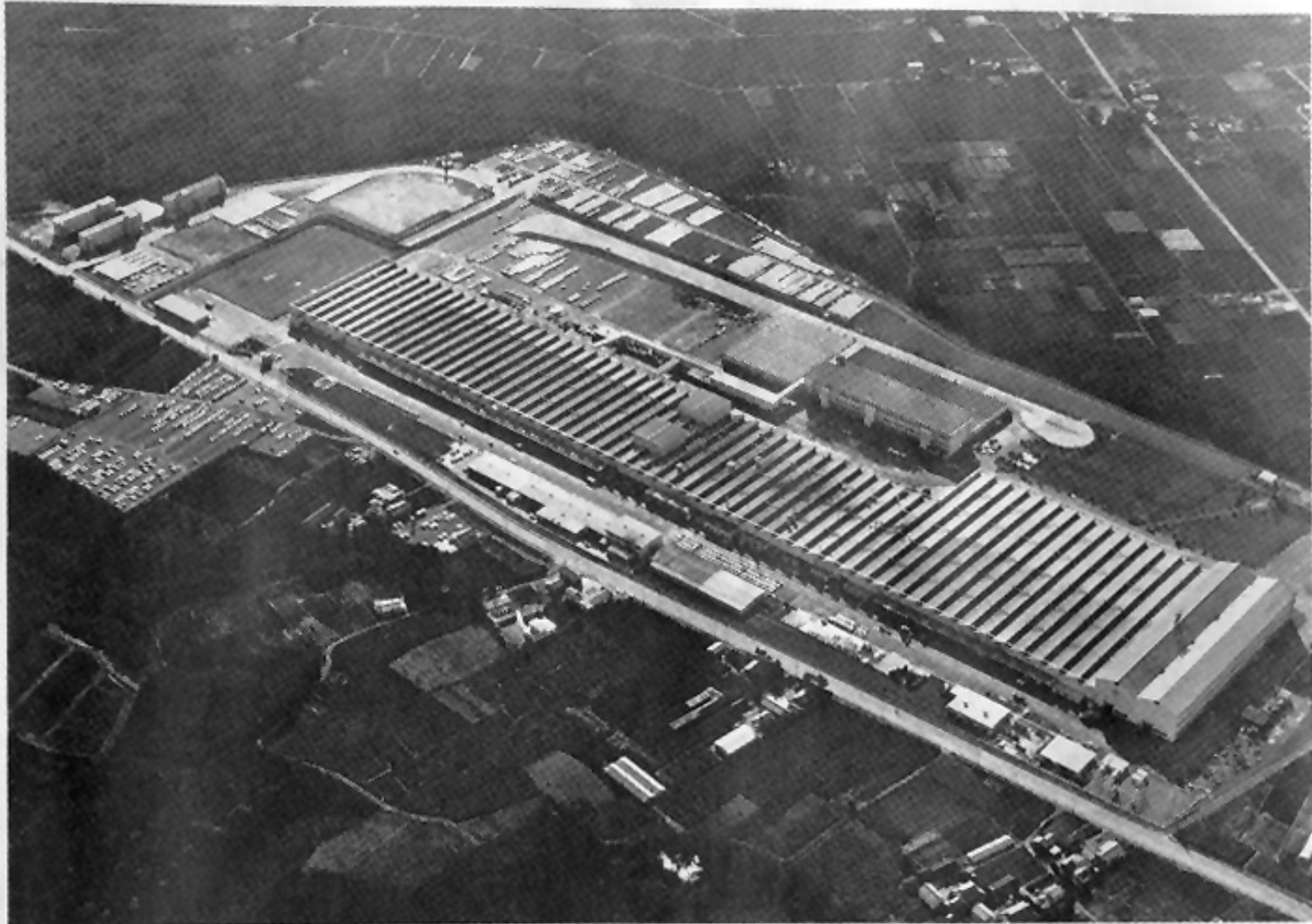

IWATA PLANT



RYUYO TEST COURSE





HEAD OFFICE