

# INSTRUCTION MANUAL

**BK** PRECISION

# 1405

## 3" OSCILLOSCOPE



**BK** PRECISION

**DYNASCAN  
CORPORATION**

## WARNING

Normal use of test equipment exposes you to a certain amount of danger from electrical shock because testing must often be performed where exposed voltage is present. An electrical shock causing 10 milliamps of current to pass through the heart will stop most human heartbeats. Higher voltages pose an even greater threat because such voltages can more easily produce a lethal current. However, voltage as low as 35 volts DC or AC RMS should be considered dangerous and hazardous since it can produce a lethal current under certain conditions. Your normal work habits should include all accepted practices that will prevent contact with exposed high voltage, and that will steer current away from your heart in case of accidental contact with a high voltage. You will significantly reduce the risk factor if you know and observe the following safety precautions:

1. Don't expose high voltage needlessly. Remove housings and covers only when necessary. Turn off equipment while making test connections in high voltage circuits.
2. Use an insulated floor material or a large, insulated floor mat to stand on, and an insulated work surface on which to place equipment; and make certain such surfaces are not damp or wet. Where insulated floor surface is not available, wear heavy gloves.
3. Use the time-proven "one hand in the pocket" technique while handling an instrument probe. Be particularly careful to avoid contacting a nearby metal object that could provide a good ground return path.
4. Always use an isolation transformer to power transformerless "hot chassis" equipment, where one side of the AC power line is connected directly to the chassis. This includes most recent television sets and audio equipment. Without an isolation transformer, the chassis of such equipment may be floating at line voltage (120 VAC, 60 Hz in USA), depending upon which way the 2-wire AC power plug is inserted. Not only does this present a dangerous shock hazard if the chassis is touched, but damage to test instruments or the equipment under test may result from connecting the ground lead of some test instruments to a "hot" chassis. The ground lead of most oscilloscopes and most other test instruments with 3-wire power plugs is an earth ground.
5. On test instruments or any equipment with a 3-wire AC power plug, use only a 3-wire outlet. This is a safety feature to keep the housing or other exposed elements at earth ground.
6. If possible, familiarize yourself with the equipment being tested and the location of its high voltage points. However, remember that high voltage may appear at unexpected points in defective equipment.
7. Also remember that AC line voltage is present on some power input circuit points such as on-off switches, fuses, power transformers, etc., even when the equipment is turned off.
8. Never work alone. Someone should be nearby to render aid if necessary. Training in CPR (cardio-pulmonary resuscitation) first aid is highly recommended.

---

**CONTENTS**

	Page
1. Features .....	2
2. Specifications .....	3
3. Circuit Description .....	4
Block Diagram & Drawing of External View .....	5
4. Operating Instructions .....	6
5. Applications .....	15
6. Caution on Handling the Scope .....	19
7. Adjustment .....	20
8. Maintenance .....	24



6460 West Cortland Street  
Chicago, Illinois 60635

## 1. FEATURES

The B & K Model 1405 Oscilloscope is a highly sensitive, stable oscilloscope employing a 3" cathode ray tube. Its unique design permits easy operation.

Make the most of your new B & K oscilloscope by carefully reading this instruction manual.

### Features

- A vertical-axis sensitivity of better than 10 mV/DIV and a frequency response from DC to 5 MHz.
- DC amplifiers are used for both vertical and horizontal axis.
- All transistorized circuitry for low power consumption and low heat generation.
- Compact and lightweight, easily portable.
- Direct deflection terminals for the vertical axis are provided to permit measurements at high frequencies
- The CRT uses a P31 (blue-green) phosphor to provide easier observation, excellent luminance and improve contrast.

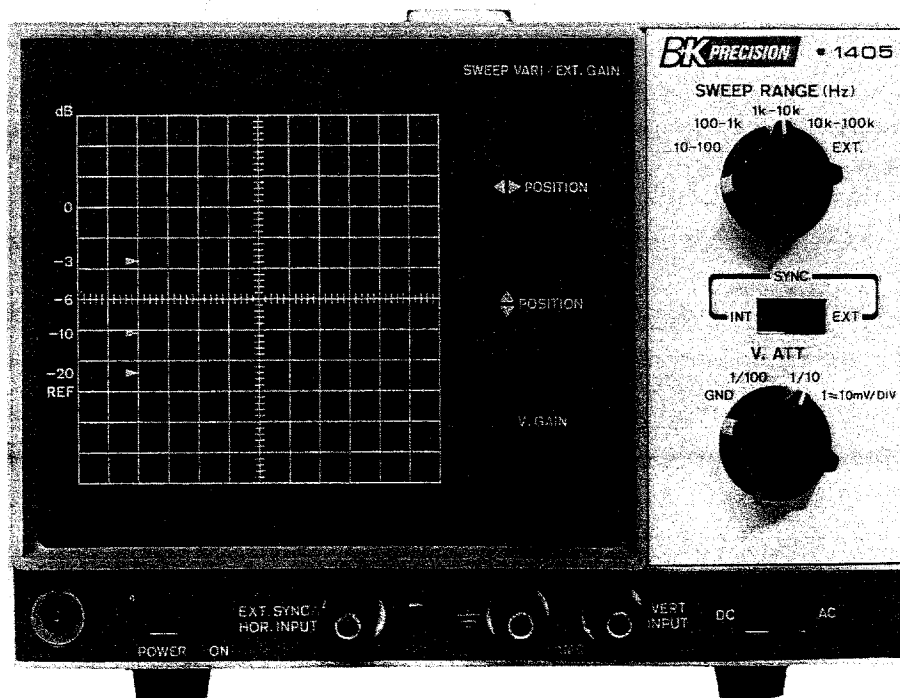

## 2. SPECIFICATIONS

CATHODE RAY TUBE	:	75AVB31
VERTICAL AMPLIFIER		
Deflection sensitivity	:	10 mV/DIV or better
Frequency response	DC	: DC to 5 MHz (-3 dB)
	AC	: 2 Hz to 5 MHz (-3 dB)
Input impedance	:	1 M $\Omega$ shunted by 35 pF max
Overshoot	:	5% or less
Attenuator	:	1, 1/10, 1/100 multiplier within $\pm 5\%$
Gain control range	:	Continuously variable range greater than 22 dB.
Rated maximum input voltage	:	300 VDC + AC peak or 600 Vp-p
HORIZONTAL AMPLIFIER		
Deflection sensitivity	:	300 mV/DIV or better
Frequency response	:	DC to 250 kHz with EXT. GAIN Control set at maximum. DC to approx. 40 kHz with EXT. GAIN Control set at mid-range.
Input impedance	:	1 M $\Omega$ ( $\pm 20\%$ ) shunted by 30 pF max. (SYNC $\rightarrow$ INT).
Attenuator (EXT. GAIN)	:	Continuously variable to zero
Rated maximum input voltage	:	100 Vp-p
SWEEP CHARACTERISTICS		
Sweep frequency	:	10 Hz to 100 kHz continuously variable in 4 ranges.
Sweep linearity	:	Within 5%
Synchronizing	:	Internal or external negative
Signal amplitude requirement for synchronization	:	Internal: more than 1 DIV deflection on cathode ray tube screen External: more than 2 Vp-p
INTENSITY MODULATION		
Required signal	:	25 Vp-p
DIRECT DEFLECTION TERMINALS		
Deflection sensitivity	:	10 V/DIV or better
Input impedance	:	2.2 M $\Omega$ shunted by 25 pF or less
POWER REQUIREMENTS	:	117/230 VAC, 50/60 Hz, 16 watts (Unit delivered for use on 117 VAC, 50/60 Hz)
DIMENSIONS, OVERALL	:	Width: 7-1/2" (190mm). Height: 6" (154mm). Depth: 11-27/32 (300mm).
WEIGHT	:	8.36 lbs. (3.8Kg).

### 3. CIRCUIT DESCRIPTION

Refer to BLOCK DIAGRAM on page 5.

#### **Vertical Circuit**

The input signal connected to VERT INPUT terminal is applied to an attenuator through the AC-DC switch.

The attenuator provides three steps (1, 1/10, 1/100).

The vertical amplifier is a highly stable, direct-coupled differential amplifier employing an FET (Q102, Q103) and silicon transistors Q104 to Q111, that provides a gain of approximately 61 dB.

#### **Horizontal Circuit**

The horizontal circuit consists of a saw-tooth generator for a time base and a horizontal amplifier circuit. The saw-tooth generator comprising transistors Q112 and Q113 employs a unique circuit with facilities for stabilizing the DC level.

The horizontal amplifier is a direct-coupled highly stable differential amplifier employing an FET (Q114) and silicon transistors (Q115 and Q116). The frequency response is from DC to greater than 250 kHz. It allows operation at slow sweep speeds below 1 Hz through the use of the EXT HOR INPUT terminals. The horizontal amplifier provides a gain of approximately 35 dB, which may be varied by approximately 10 dB using the EXT GAIN control.

#### **Power Supply Circuit**

The power supply circuit provides -6 VDC and  $\pm 15$  VDC, stabilized by zener diodes D105, D106 and D109; + 170V for the collectors of the final amplifier stage and - 1300V for the cathode ray tube circuit.

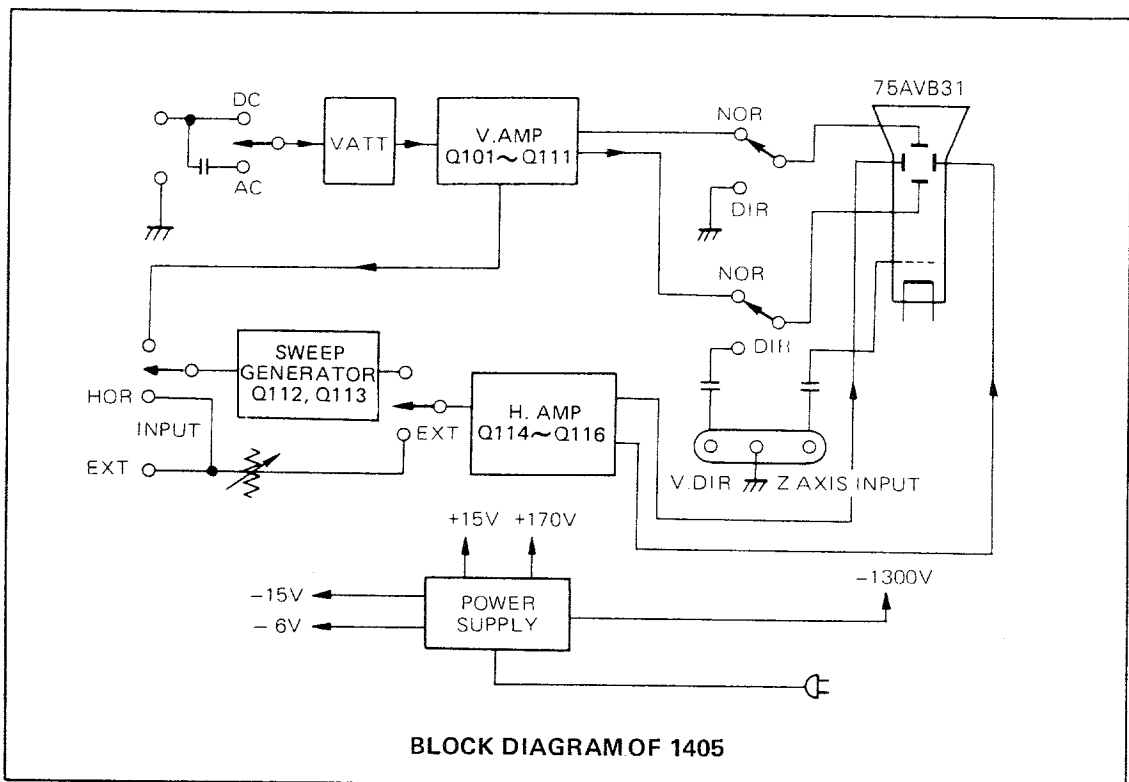

BLOCK DIAGRAM OF 1405

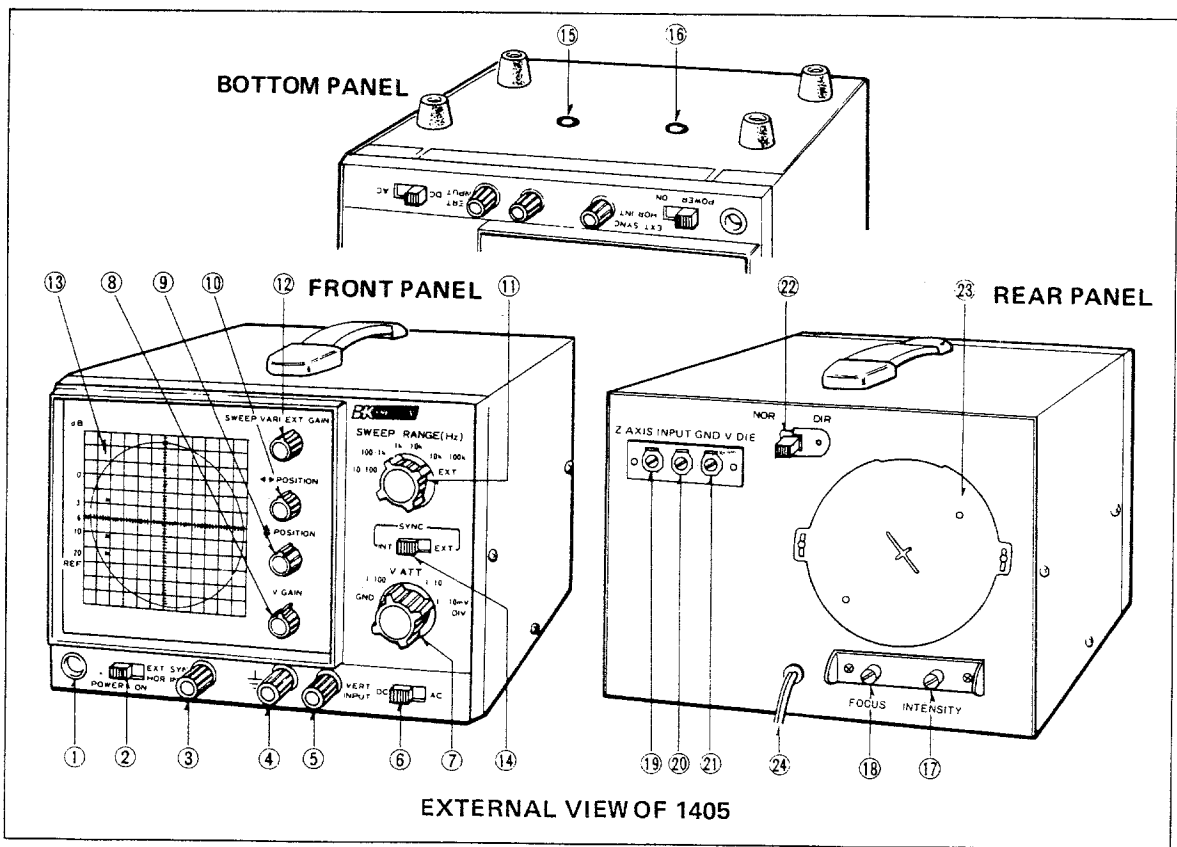

EXTERNAL VIEW OF 1405

## 4. OPERATING INSTRUCTIONS

The markings of controls and terminals on the front panel are given in the following table. When reading the table, refer to EXTERNAL VIEW, page 5.

(FRONT PANEL)

REF. NO.	PANEL MARKING	DESCRIPTION
( 1 )	(NEON PILOT)	Illuminated when the scope is operating.
( 2 )	POWER	Power ON-OFF switch. When this switch is in ON position, the scope is brought to operating condition.
( 3 )	EXT.SYNC/ HOR INPUT	Input terminal for external sync or an external horizontal signal. Use grounding terminal (4) as the common grounding terminal.
( 4 )		Grounding terminal.
( 5 )	VERT INPUT	Input terminal for the vertical signal. Note that terminals (4) and (5) are spaced for inserting a dual banana plug.
( 6 )	AC - DC	Selector switch for the vertical input coupling capacitor. In the DC position, the switch directly couples the VERT INPUT terminal (5) and V. ATT(7) and, therefore, allows the vertical amplifier to amplify input signals ranging from DC. In the AC position, a capacitor is placed between the vertical attenuator V. ATT(7) and VERT INPUT (5) and, therefore, the DC component of the input signal is blocked, permitting observation of the AC component only.



REF. NO.	PANEL MARKING	DESCRIPTION	
(7)	V. ATT	<p>Vertical attenuator. The vertical attenuator provides facilities to attenuate the signal voltage connected to the VERT INPUT terminal (5) to a suitable level before being applied to the vertical amplifier.</p> <p>When this attenuator is set to position 1, the signal applied to the VERT INPUT terminal (5) is directly coupled to the vertical amplifier. In positions 1/10 and 1/100, the attenuator attenuates the signal so that the input is reduced to 1/10 and 1/100 of the normal value, respectively.</p> <p>In GND position, the attenuator grounds the input of the vertical amplifier and opens the VERT INPUT terminal (5). The attenuator position GND is provided for making DC BAL adjustments.</p>	
		Signal voltage to be measured	V. ATTEN
		0.8 Vp-p (0.3 Vrms) or less 0.2 to 8 Vp-p (0.07 to 3 Vrms) Above 2 Vp-p (0.7 Vrms)	1 1/10 1/100
(8)	V. GAIN	<p>Vertical gain control. This control, operated in combination with vertical attenuator V. ATT(7), provides facilities to produce an appropriate amplitude on the cathode ray tube screen. If it is impossible to adjust the waveform to an appropriate amplitude by operating this control, turn the vertical attenuator V. ATT(7) to another position.</p>	
(9)	◆ POSITION	<p>Vertical position control. The control provides facilities to move the signal waveform up and down over the cathode ray tube screen. Clockwise rotation of the control moves the waveform up over the screen.</p>	
(10)	◀▶ POSITION	<p>Horizontal position control. The control provides facilities to move the signal waveform to the left or right over the cathode ray tube screen. Clockwise rotation of the control moves the waveform to the right.</p>	

REF. NO.	PANEL MARKING	DESCRIPTION
(11)	SWEEP RANGE	<p>Sweep-frequency selector switch, together with SWEEP VARI/EXT. GAIN (12), provides variable sweep frequencies allowing the appropriate number of cycles of signal waveform on the cathode ray tube screen for easy observation. Position markings 10 – 100, 100 – 1 K, etc., represent sweep frequencies. In the EXT position this switch connects the horizontal amplifier via the SWEEP VARI/EXT. GAIN control (12) to the EXT HOR INPUT terminal (3).</p>
(12)	SWEEP VARI/EXT. GAIN	<p>Sweep frequency fine adjustment and external signal gain control. When the SWEEP RANGE selector switch (11) is in the internal frequency range (10 – 100 K), this control acts as the fine adjustment of sweep frequency.</p> <p>When the SWEEP RANGE selector switch (11) is in the EXT position, this control provides facilities to adjust the gain of the signal connected to the EXT. HOR INPUT terminal (3) to change the amplitude of the horizontal signal on the cathode ray tube screen.</p> <p>Note that the horizontal frequency response varies with the position of this control. (Refer to Specifications)</p>
(13)	(GRATICULE)	<p>The graticule is made of acrylic resin and has engraved markings to aid in analyzing the waveform on the cathode ray tube screen.</p> <p>There are dB scales on the graticule (0, –3, –6, –10 and –20 dB) so calibrated as to provide a level corresponding to an amplitude of 6 DIV above the REF line.</p> <p>Thus, these graduations may be conveniently used for measuring signal levels in frequency response measurements.</p>
(14)	SYNC INT/EXT	<p>In the INT. position, sync is derived from the vertical amplifier. In the EXT. position, sync is derived from EXT SYNC/HOR INPUT jack (3).</p>

## (BOTTOM PANEL)

REF. NO.	PANEL MARKING	DESCRIPTION
(15)	D.C. BAL	DC balance adjustment for the vertical amplifier. This adjustment should be adjusted so that the trace line remains stationary as the V. GAIN control (8) is rotated from full clockwise to full counterclockwise.
(16)	HOR GAIN	The horizontal gain control adjusts horizontal amplifier calibration.

## (REAR PANEL)

REF. NO.	PANEL MARKING	DESCRIPTION
(17)	INTENSITY	The intensity adjustment provides a means to adjust the brightness of the waveform appearing on the cathode ray tube screen. Clockwise rotation of this control increases the waveform brightness.
(18)	FOCUS	The focus adjustment provides the means to adjust the waveform appearing on the cathode ray tube for maximum clarity.
(19)	Z-AXIS	Terminal for intensity modulation. This terminal requires an AC voltage of approx. 25 Vp-p to blank the screen. When a positive signal is applied to this terminal, the waveform intensity is increased. If a negative signal is applied, the intensity is reduced. This terminal is not effective when at DC.
(20)	GND	Grounding terminal.
(21)	V. DIR	Direct deflection terminals. They can be directly connected to the CRT vertical deflection plates by switching the DIR-NOR selector switch (22) to observe waveforms of high frequencies.

REF. NO.	PANEL MARKING	DESCRIPTION
(22)	DIR-NOR	Switch for the vertical deflection plates. In the NOR position, it connects the CRT to the amplifier for measurements through input terminals (4) and (5). In the DIR position, the internal amplifier is by-passed, permitting measurements to be made through input terminals (20) and (21), where signals under measurement are directly passed to the CRT deflection plates.
(23)	(CRT ADJ)	Adjustment plate for eliminating trace tilt.
(24)	(POWER CORD)	

### GENERAL OPERATION

Apply the signal voltage to be observed to the  $\frac{1}{\text{---}}$  (4) and VERT INPUT terminal (5) using the cable supplied with the unit. Connect the black cable to the grounding terminal  $\frac{1}{\text{---}}$  (4) and the red cable to the VERT INPUT TERMINAL (5). Adjust V. ATT(7) and V. GAIN control (8) until the waveform appearing on the cathode ray tube screen provides an amplitude of approx. 6 DIV.

Then, set the SWEEP RANGE selector switch (11) to the frequency range of the signal voltage to be observed or the next counterclockwise range.

Turn the SWEEP VARI/EXT. GAIN control (12) until the screen displays a waveform with the number of cycles adequate for observation (generally three cycles).

If the waveform includes only one wave, it means the sweep frequency of the time base is the frequency of the signal under observation. If the waveform includes five cycles it means the sweep frequency of the time base is 1/5 of the signal frequency.

Turn the AC-DC selector switch (6) to the DC position when it is desired to measure the DC component of the signal under observation, or to observe a frequency below 10 Hz.

When it is desired to observe the AC component only, turn the above selector switch to the AC position.

It should be noted that a positive (+) signal on the vertical amplifier causes the trace to move up. A positive signal applied to the horizontal input causes a deflection to the left.

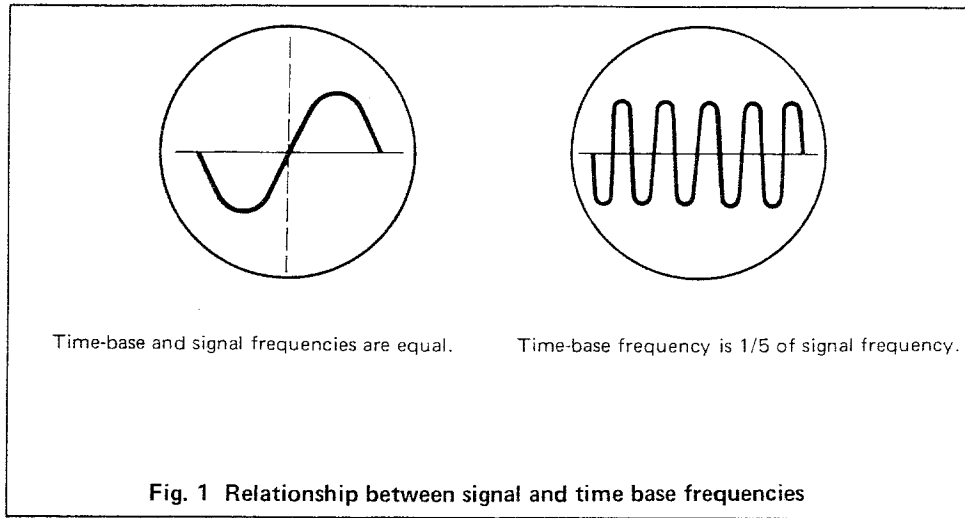

Position the waveform by adjusting the vertical position control (9) and horizontal position control (10) as required.

If the waveform includes a DC component, it is shifted up or down depending on the polarity of the component. In this case, correct the position of the waveform by means of the vertical position control (9). If the waveform cannot be brought within the screen of the cathode ray tube, it means a large DC component is included in the signal under observation. In such a case, turn the V. ATT(7) or V. GAIN control (8) counterclockwise until the waveform is brought back to an appropriate position.

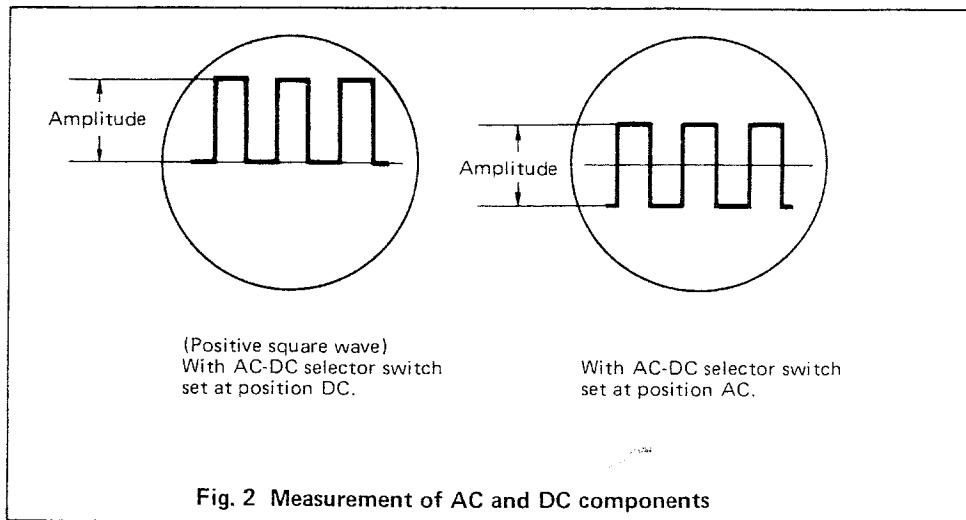

Any voltage measurements made on an oscilloscope are made in p-p or peak values. Because the effective, or rms value is often the one of interest, the following table gives the conversion between p-p and rms values for a number of common waveforms.

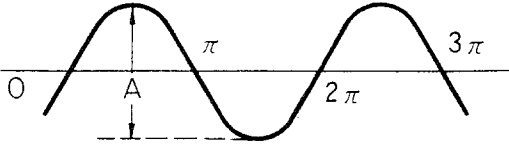
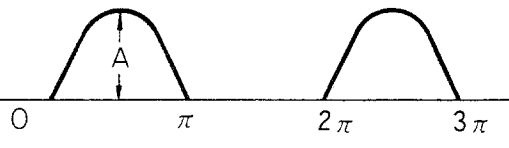
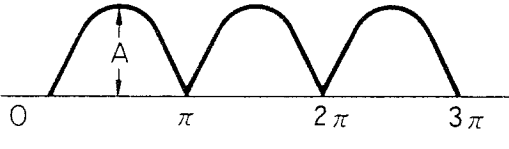
Waveform	Effective Value (r m s)
	$\frac{A}{2\sqrt{2}} = 0.354A$
	$\frac{A}{2} = 0.5A$
	$\frac{A}{\sqrt{2}} = 0.707A$

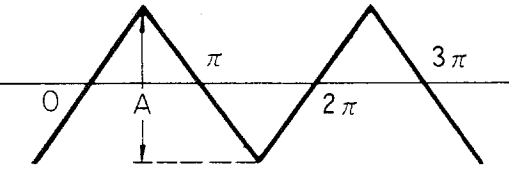
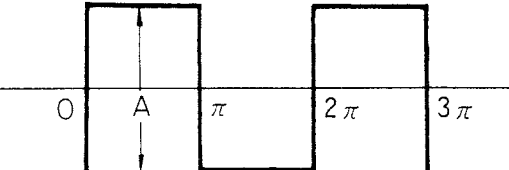
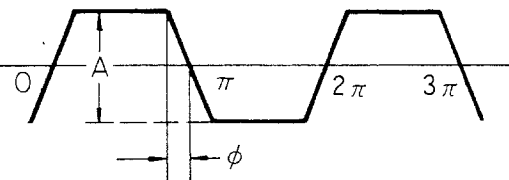
Waveform	Effective Value (r m s)
	$\frac{A}{2\sqrt{3}} = 0.288A$
	$\frac{A}{2} = 0.5A$
	$\frac{A}{2} \sqrt{1 - \frac{4\phi}{2\pi}}$

## MEASUREMENT BY LISSAJOUS' FIGURES

### (a) Frequency measurement

Lissajous' figures are a widely used method for measurement of the frequency of a signal. To make a frequency measurement using this method, proceed as follows:

Set the SWEEP RANGE selector switch (11) to the EXT position. Connect a signal generator across the EXT. HOR INPUT terminals (3) and  $\perp$  (4) and adjust the generator output until the waveform appearing on the cathode ray tube screen provides a trace width of approx. 6 DIV. Apply the unknown frequency signal across the  $\perp$  (4) and VERT INPUT (5) terminals and adjust the V. GAIN control (8) until the waveform appearing on the cathode ray tube screen has an amplitude of approximately 6 DIV.

Slowly vary the output frequency of the generator until the waveform appears as one of the following figures.

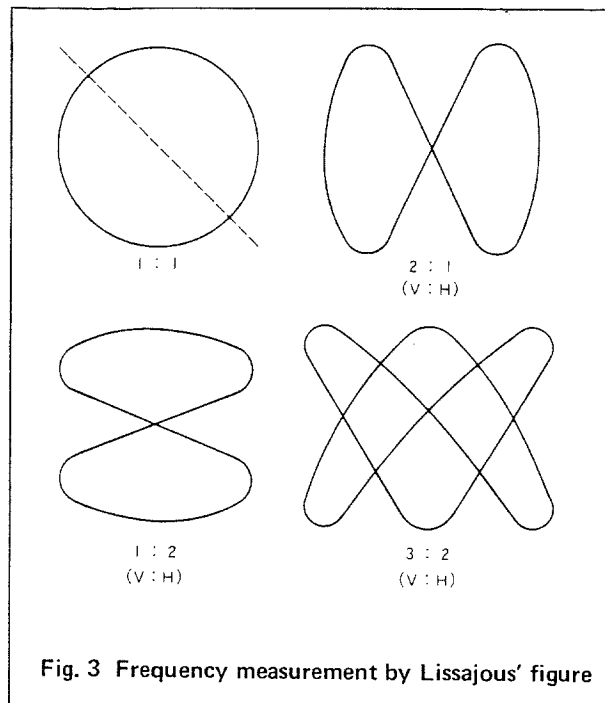

The frequency of the signal generator and the unknown frequency are equal when the waveform becomes a straight line, an ellipse or circle. The figure comes to a standstill only when there is such relation between the frequency of the signal generator and the unknown frequency that the former is an exact multiple of the latter or vice versa. This makes it possible to find the unknown frequency through a calculation.

The frequency ratio is determined by observing the number of tangent points on either vertical side and on either top or bottom. The frequency ratio is the ratio between these tangents. Several examples are given in the illustration.

## (b) Measurement of phase difference

Apply the two signals having the same frequency (for instance the R and L signals of a stereo signal) to EXT. HOR.INPUT (3) and VERT INPUT terminals (5) in the same manner as described in (a). A straight line running from the upper left corner to the lower right corner of the screen indicates both signals are in phase with each other. Increasing phase difference causes the straight line on the cathode ray tube screen to gradually turn into an ellipse. When the ellipse turns into a circle or an ellipse with a vertical or horizontal axis the signals are 90° out of phase with each other.

To make the measurement of the phase difference of the two signals mentioned above, measure the horizontal deflection of the overall figure and the length of figure on the horizontal axis, which are given as X and x respectively in Fig. 4. The phase difference  $\theta$  is given by  $\text{Sin } \theta = x/X$ .

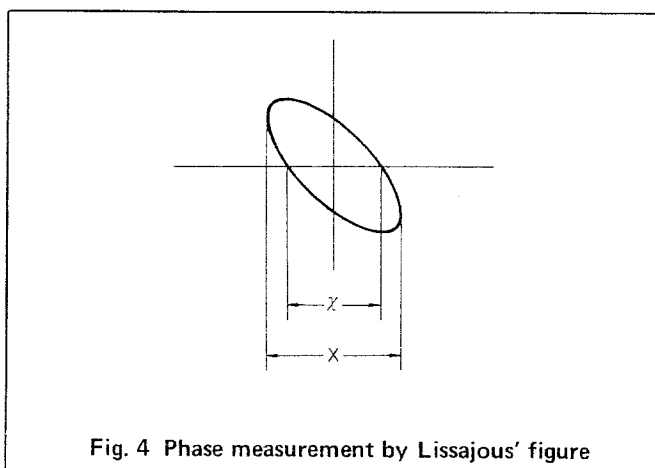

Fig. 4 Phase measurement by Lissajous' figure

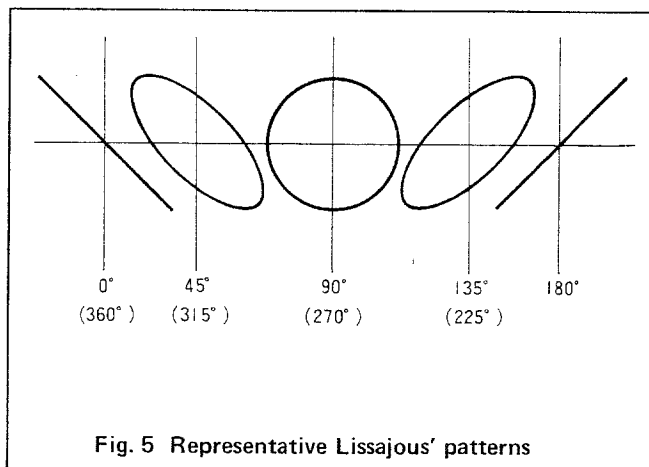

Fig. 5 Representative Lissajous' patterns

Note that if the EXT. GAIN control (12) is kept in the fully clockwise position in the above measurement, the vertical and horizontal signal phase difference of the oscilloscope is essentially zero up to about 2 kHz. Above 2 kHz, however, the unit will have a vertical and horizontal signal phase difference. Take the above fact into consideration when making phase difference measurements.

Also, it should be noted that if EXT. GAIN control (12) is not fully clockwise, the range of frequencies at which the vertical and horizontal signal phase difference is zero is reduced and will be approx. 500 Hz when the control is set at its mid-point.



## 5. APPLICATIONS

### (a) Frequency Response Measurement of an Audio Amplifier

Connect the sine wave output of a signal generator to the input terminal of the audio amplifier under measurement. Connect the VERT INPUT (5) and  $\perp$  (4) terminals of the oscilloscope across the speaker output terminals of the amplifier. The amplifier should be feeding a load resistor of the proper value.

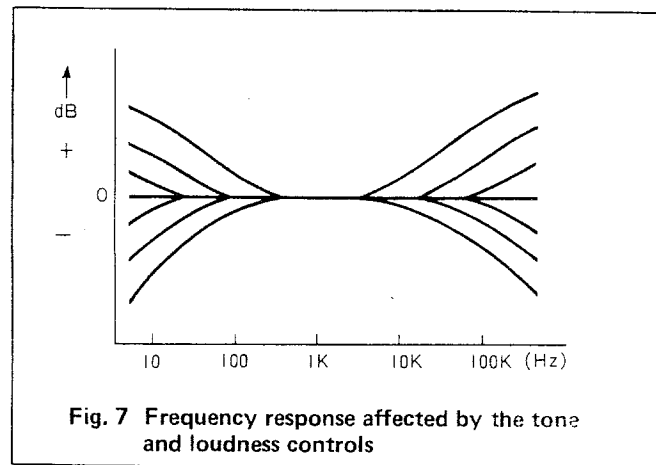
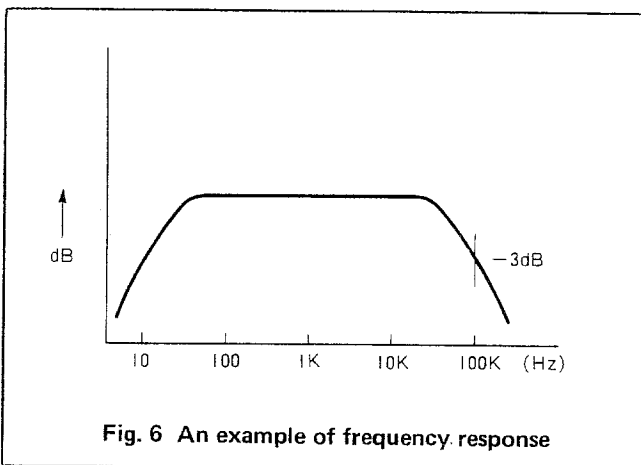

With the output voltage of the signal generator set at a constant value, change the output frequency of the generator and read the amplitude of the waveform in dB on the cathode ray tube screen using the dB scale for various major frequencies. Plot the amplitude readings thus obtained against the frequencies and you can obtain a general amplitude frequency characteristic as shown in Fig. 6.

If the tone and/or loudness controls on the amplifier are adjusted appropriately, then the characteristic curve will be changed as shown in the Fig. 7.

Note that the dB scale of this unit provides means to directly read the amplitude of a waveform on the cathode ray tube screen in dB, such as  $-3$  and  $-6$  dB.

### (b) Measurement with Square Wave Signal

If a square wave signal is used in lieu of the sine wave signal in the above frequency characteristic measurement, the frequency characteristics of the audio amplifier can be roughly estimated from the various output waveforms of the square wave signal in accordance with the diagram shown on the next page.

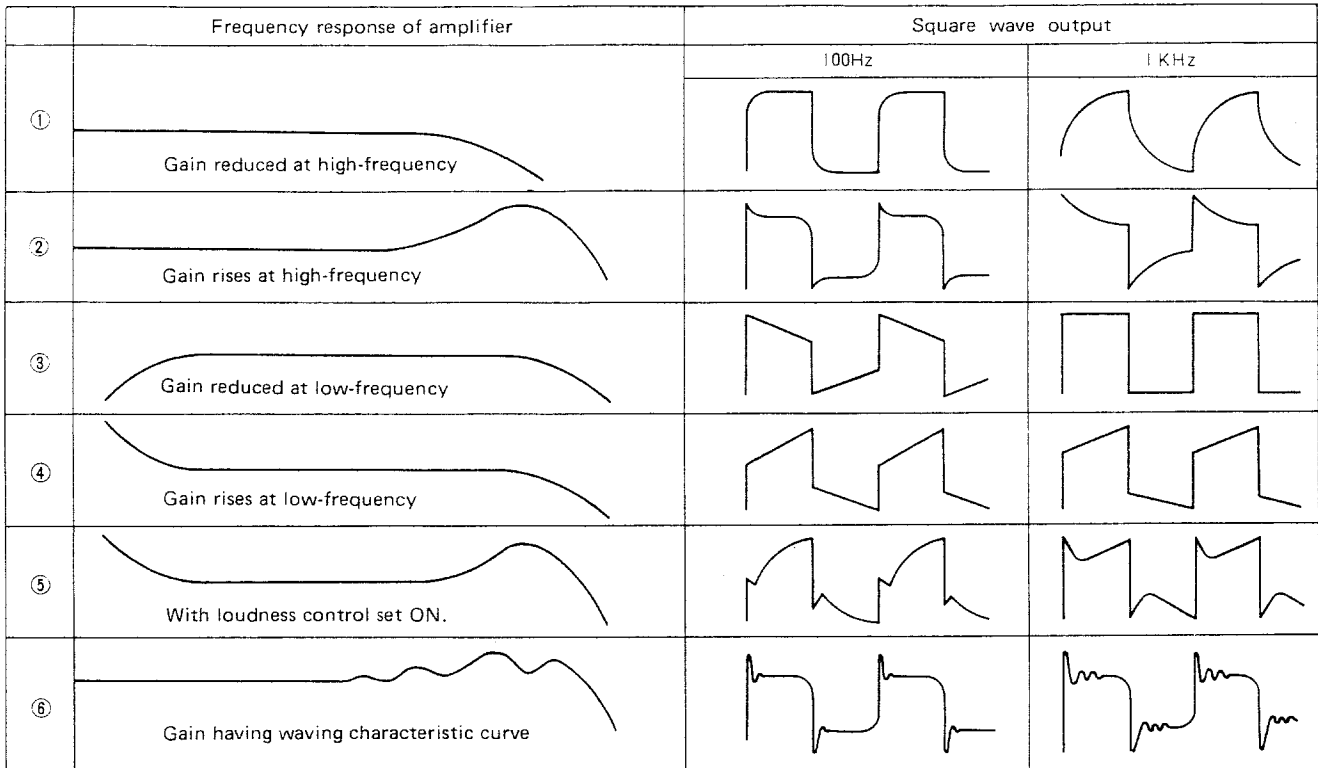

(c) Measurements through the Direct Deflection Terminals

Although frequencies below 5 MHz can be measured through the internal amplifier, higher frequencies must be measured through the direct deflection terminals. For direct connection, set DIR – NOR switch (21) to DIR, and connect the signal to be measured, to DIR (21) and GND (20).

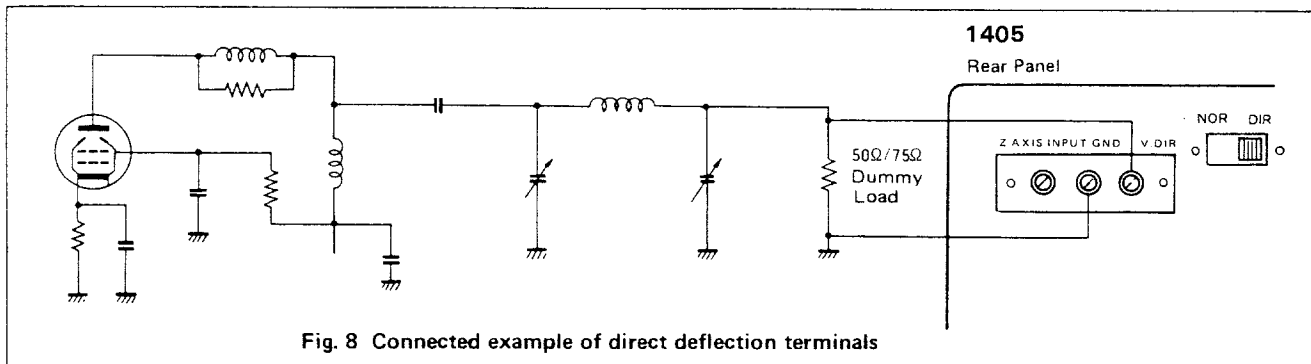

Fig. 8 Connected example of direct deflection terminals

The direct deflection terminals, however, require an input level of 10 Vp-p to 100 Vp-p because of their low sensitivity. Also, since the direct connection to the deflection plate puts the sensitivity control out of the circuit, adjustment must be made on the source side of the set-up.

The following examples are observations of output signals of communications instruments:

1) Modulation measurement

Make connections as shown in the Fig. 8. After obtaining a waveform on the CRT, measure maximum amplitude A and minimum amplitude B as shown in the Fig. 9. The degree of modulation can be found from the equation in the Fig. 9.

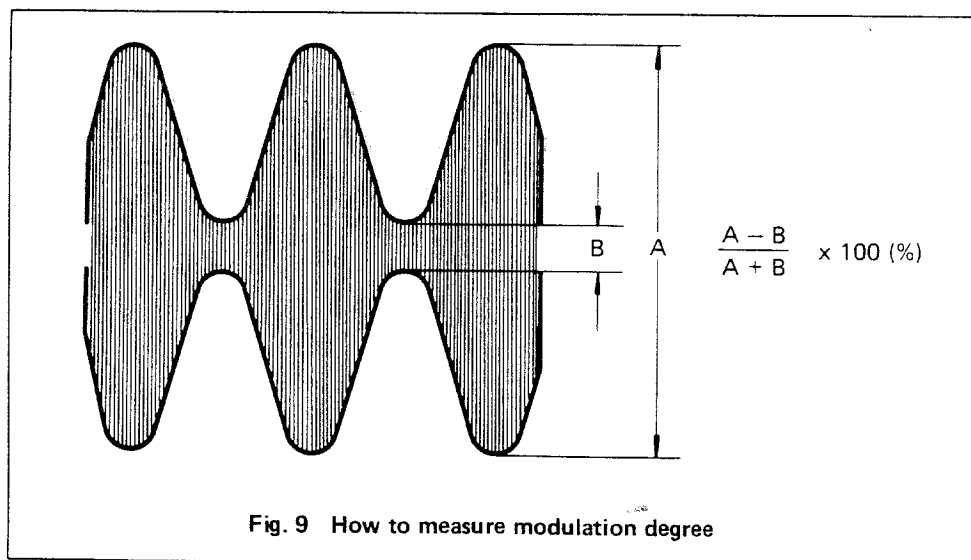

2) Measurement of Morse code envelopes

Employ the same connections as for the modulation measurement. Connect a high-speed keyer — an electronic keyer is preferable — to the key jack of the transmitter, and repeat dashes or dots to observe their waveform while adjusting SWEEP VAR1 (12).

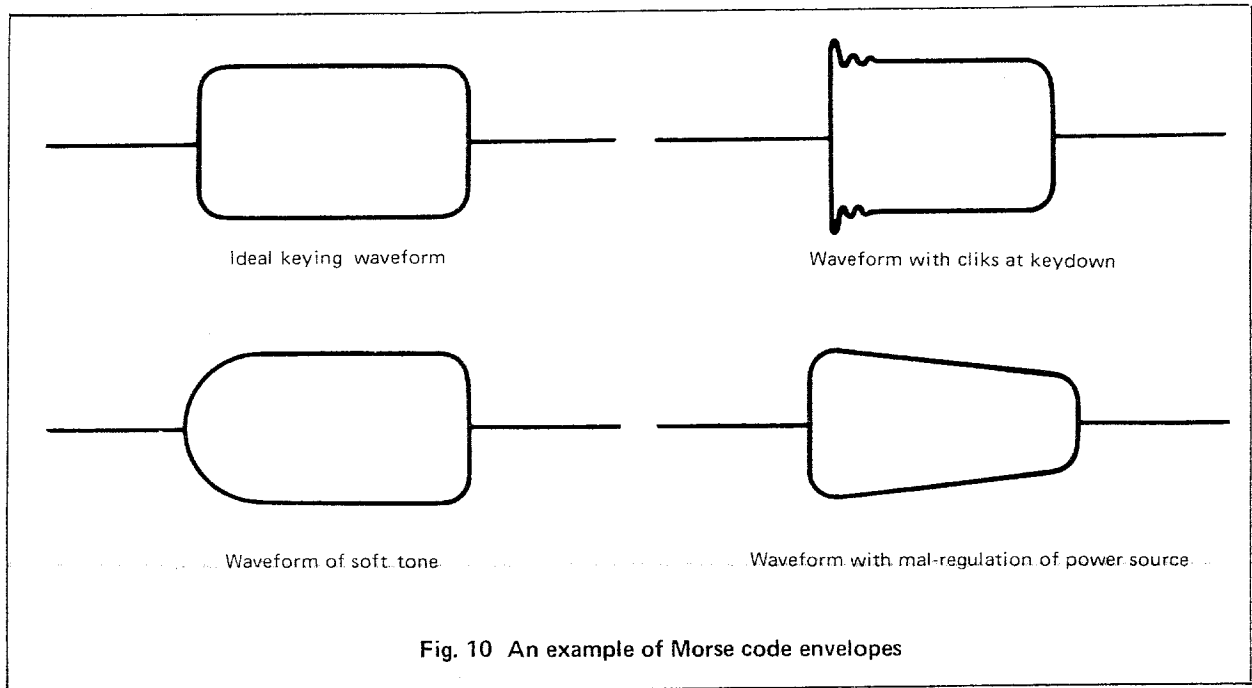

3) Observation of SSB waveforms

Make connections as in Fig. 8. Connect the output of a two-tone generator (for example, 500 Hz and 2400 Hz) to the microphone input jack of the SSB transmitter to observe modulation. Waveforms as shown in Fig. 11 are satisfactory; however, if peaks or nodes are dull or flat, the signal may be splattering. Note, however, that such distorted waveforms can also occur due to excessively large output from the two-tone generator.

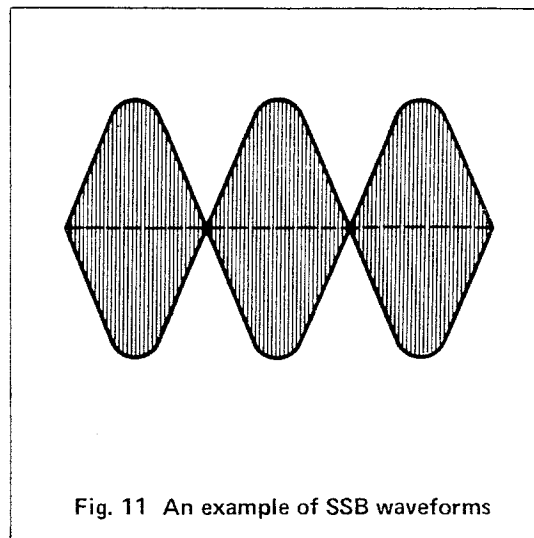

## 6. CAUTION ON HANDLING THE SCOPE

- (a) Do not operate this oscilloscope in a place where the set is exposed to direct sunlight. Otherwise, the unit may reach a high internal temperature with resultant unstable operation and, in some cases, result in damaged components.
- (b) Do not operate unit in a room where high temperature and high humidity prevail.
- (c) Do not operate unit where mechanical vibrations prevail or near equipment which generates strong magnetic fields or impulse voltages.
- (d) This unit is wired for 117 VAC. Refer to Maintenance section for conversion to 230 VAC or 100 VAC operation.
- (e) Do not allow the voltage across the VERT INPUT (5) and  $\underline{\underline{\text{---}}}$  (4) terminals to exceed 600 Vp-p and that across EXT. HOR INPUT (3) and  $\underline{\underline{\text{---}}}$  (4) terminals to exceed 100 Vp-p.
- (f) The trace line on the cathode ray tube screen changes its angular direction a little due to the earth's magnetic field when the scope is placed in various planes.

### WARNING

High voltage is present when the oscilloscope is operating. Line voltage of 120 or 240 VAC is present any time scope is connected to an AC power source, even if turned off. Always observe caution when the housing is removed from the unit. Contacting exposed high voltage could result in fatal electric shock.

## 7. ADJUSTMENT

## (a) Adjustment of D.C. BAL

When the trace line is moved up or down as the V. GAIN control (8) is turned, adjust the D.C. BAL adjustment as follows:

First set the operating controls as follows V. ATT (7) at GND. V. GAIN control (8) at fully counterclockwise position. Adjust  $\blacklozenge$  POSITION control (9) until the trace line is centered on the cathode ray tube screen.

Then, turn the V. GAIN control (8) clockwise and if the trace line shifts, insert a narrow-tip screwdriver (having a width of less than 2.5 mm) in the hole for D.C. BAL adjustment and fit the top of the screwdriver in the center groove of trim-pot adjustment D.C. BAL. Slowly turn the trim-pot in such a manner that the shifted trace line is restored to its original position.

Repeat the above step several times until the trace line remains stationary even though V. GAIN control (8) is rotated.

Allow at least 15 minutes of operation for the unit to stabilize before making the adjustment.

## (b) Adjustment of HOR GAIN

1) Apply a signal of 3 Vp-p at approx. 1 kHz to the EXT. HOR INPUT terminals (3) and  $\frac{1}{\equiv}$  (4). With SWEEP RANGE selector switch (11) set at the EXT position, turn the SWEEP VARI/EXT. GAIN control (12) to the fully clockwise position. Turn HOR GAIN (16) with narrow-tip screwdriver. Slowly turn the trim-pot until the trace line provides a horizontal deflection of 10 DIV and the set is calibrated for a horizontal sensitivity of 300 mV/DIV.

2) Set up the oscilloscope for internal sweep by placing the SWEEP RANGE selector switch (11) in a position other than EXT.

Apply an input signal to the  $\frac{1}{\equiv}$  (4) and VERT INPUT (5) terminals and adjust the V. GAIN control (8) until the waveform appearing on the cathode ray tube screen provides an amplitude of approximately 6 DIV.

Adjust SWEEP RANGE selector switch (11) and SWEEP VARI/EXT. GAIN control (12) until a normal waveform appears on the cathode ray tube screen. Adjust VR3 so as to set the horizontal deflection of the waveform to an appropriate length of deflection (for instance 10 DIV).

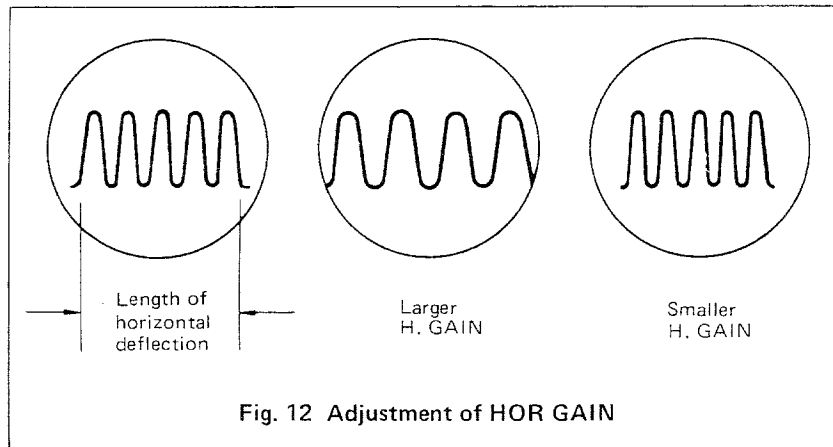

(c) Adjustment of V. ATT Frequency Correction

Remove the cabinet case from the unit.

**CAUTION:** The cathode ray tube socket pins carry voltage of approx. -1300 V. BE CAREFUL not to bring the hand or screwdriver into contact with the metal section of the socket while making these adjustment.

Apply a square wave signal of approx. 1 kHz to  $\frac{1}{10}$  (4) and VERT. INPUT (5) terminals.

With vertical attenuator V. ATT(7) set to position 1, adjust the output of the signal generator until the waveform appearing on the cathode ray tube screen provides an amplitude of approx. 6 DIV. Turn SWEEP RANGE selector switch (11) to the 100-1K position and adjust the SWEEP VARI/EXT. GAIN control (12) so as to make the waveform include two to four cycles.

Check that the waveform under the above condition is a good square wave and then turn the vertical attenuator V. ATT(7) to position 1/10. Then, increase the output of signal generator 20 dB to obtain an amplitude of 6 DIV.

If necessary, adjust trimmer capacitor TC102 using an insulated (adjustment) screwdriver until the square wave is restored to its original configuration.

Repeat the previous steps with the vertical attenuator set to position 1/100 and adjusting trimmer capacitor TC101.

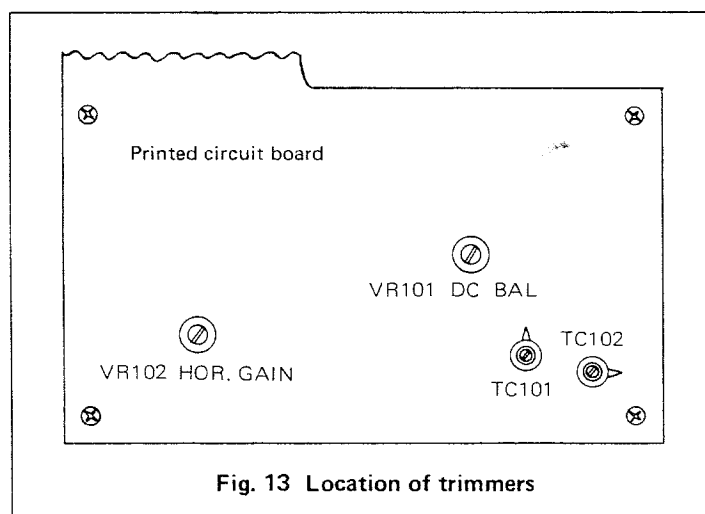

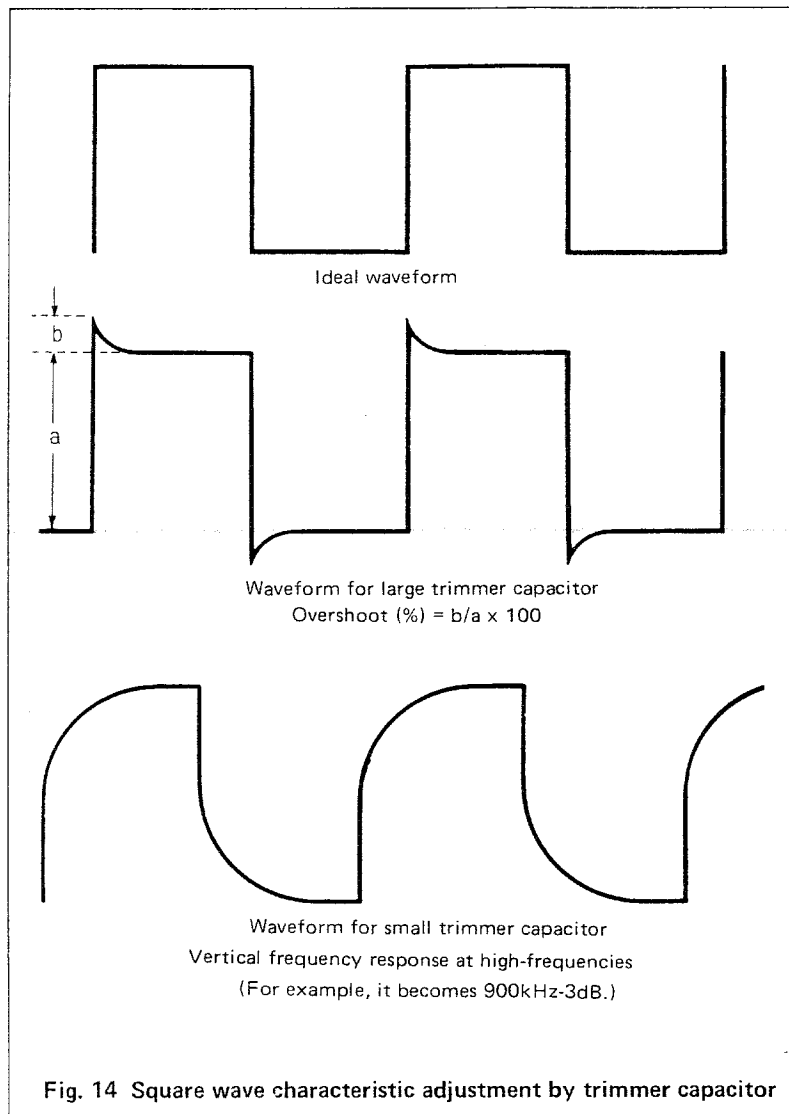

- (d) Correction of Cathode Ray Tube Position for Tilt (see Fig. 15)  
Loosen the screw (A) holding the CRT mounting plate at the rear.  
Place the oscilloscope on the normal operating position.  
Put the blade of a screwdriver in the slit (B) to turn the CRT mounting plate for setting the bright line correctly against the scale graduation.  
Carefully tighten the screw (A) observing that the horizontal bright line is not deviated.



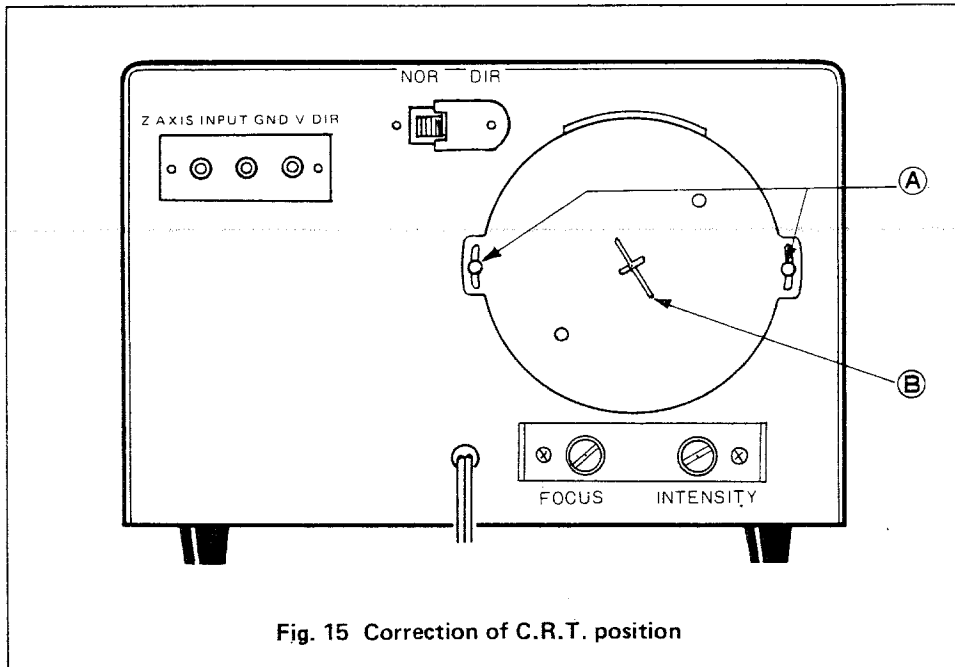

Fig. 15 Correction of C.R.T. position

8. MAINTENANCE

(a) Removal of Cabinet Case

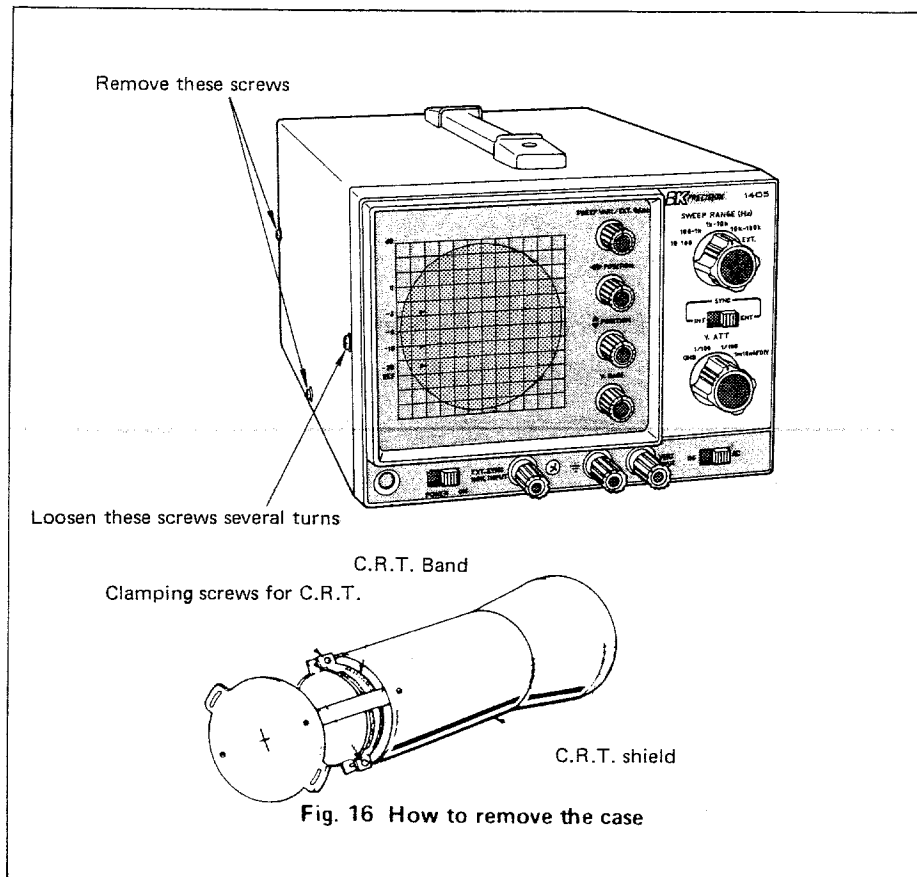

Fig. 16 How to remove the case

- 1) Remove four screws for the cabinet case from both side plates.
- 2) Loosen the screws located at the center front sections of both side plates several turns.
- 3) Take hold of carrying handle and slide case to rear; then lift case off.

(b) Removal of Cathode Ray Tube

- 1) Remove the cabinet case from the unit.
- 2) Remove the socket from the cathode ray tube.
- 3) Remove the two screws holding CRT mounting plate (Fig. 15)
- 4) Pull out the CRT with mounting plate from case.
- 5) Loosen the two screws retaining the CRT to the shield.

**CAUTION:** Handle the cathode ray tube with utmost care. When replacing the tube, BE CAREFUL to place the tube in the socket with the key positioned in the upper left direction when viewed from the face.

## (c) Removal of Panel

- 1) Remove the cabinet case.
- 2) Loosen mounting screws for control knobs (2 large knobs, 4 small knobs).
- 3) Unscrew the nut from the SWEEP RANGE selector switch shaft.
- 4) Remove the black screw between terminals (3) and  $\underline{\underline{4}}$  (4).
- 5) Remove two screws from the lower section of the front panel.
- 6) Carefully draw the panel forward.

**CAUTION:** Handle the panel carefully. Rough handling may bend or crack panel.

## (d) Voltage Conversion

- 1) To convert the power source voltage, first remove the power cord from the power source.
- 2) The power transformer is wired as shown in Fig. 17. If the oscilloscope is to be operated on another voltage, change the wiring and re-solder referring to Fig. 17.

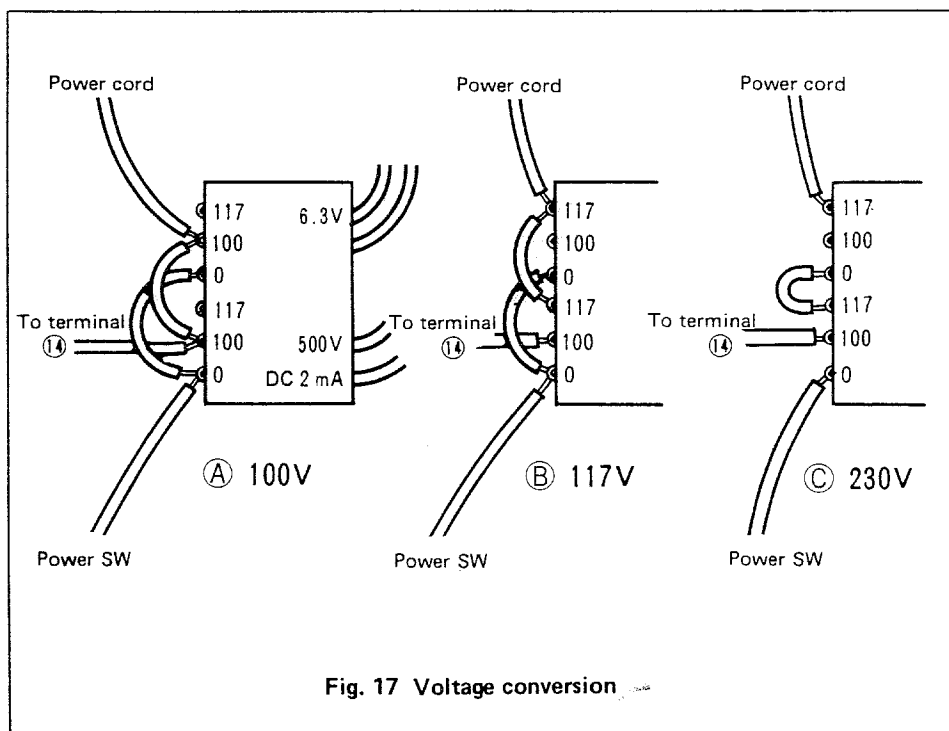

## (e) Replacement of Fuse

- 1) Always disconnect power supply before replacing a fuse.
- 2) Remove the cabinet case from the unit.
- 3) Remove the fuse inserted in its holder located on the upper right corner of printed circuit board and insert a new fuse in the fuse holder.
- 4) If the fuse taken out is blown out, trouble shoot the set for brown fuse, repair the trouble and then apply the power to the set.
- 5) For 117 V operation a 0.5 A fuse should be used and for 230 V operation a 0.3 A fuse should be used.