

INSTRUCTION MANUAL

OPERATION

MODEL 1605B

AUTOBALANCING

TRANSFER

STANDARD

VOLUME 1

Ballantine Laboratories, Inc. P.O. Box 97 Boonton, New Jersey 07005 U.S.A.
Telephone: 201-335-0900 FAX: 201-263-7141 TWX: 710-987-8380

WARRANTY

This Ballantine Laboratories, Inc. product is warranted against defects in materials and workmanship for a period of one year from the date of shipment, except for batteries, electron tubes, vacuum thermal elements, and certain other components, if any, listed in this manual. Ballantine Laboratories, Inc. will, at its option, repair or replace products which prove to be defective during the warranty period provided they are returned to Ballantine Laboratories, Inc. prepaid, and provided the proper preventive maintenance and calibration procedures as listed in this manual have been followed. Repairs necessitated by misuse of the product are not covered by this warranty. NO OTHER WARRANTIES ARE EXPRESSED OR IMPLIED, INCLUDING BUT NOT LIMITED TO THE IMPLIED WARRANTIES OF MERCHANTABILITY AND FITNESS FOR A PARTICULAR PURPOSE. BALLANTINE LABORATORIES, INC. IS NOT LIABLE FOR CONSEQUENTIAL DAMAGES.

CERTIFICATION

Ballantine Laboratories, Inc. certifies that this equipment meets all applicable Ballantine specifications at time of shipment from the factory as determined by thorough testing and inspection. Ballantine further certifies that its measurements are traceable to the United States National Bureau of Standards. All instruments used in calibrating Ballantine products are standardized by systematic reference to NBS-traceable standards as described in the validation procedures shown below.

REFERENCE STANDARDS

DC	10mV-750V	0.002-0.003%
20Hz-50kHz	0.5V-500V	0.004%
20Hz-10MHz	0.5V-100V	0.05%
DC-30MHz	0.5V-100V	0.35%
DC-700MHz	10uV-0.5V	1%-NBS
10MHz-1000MHz	1V-300V	1%-NBS

WORKING STANDARDS

THERMAL VOLTAGE CONVERTERS, BALLANTINE 1397A
TRANSFER STANDARD, BALLANTINE 1605A
MICROPOTENTIOMETERS, BALLANTINE 440
RATIO TRANSFORMERS, GERTSCH

TABLE OF CONTENTS

<u>PARAGRAPH</u>	<u>PAGE</u>	<u>PARAGRAPH</u>	<u>PAGE</u>
<u>Section 1. General Information</u>			
1-1. Introduction	1-1	3-42. Standby	3-12
1-9. Specifications	1-1	3-43. Initializing the ATS	3-12
1-11. Available Accessories and Current Shunts	1-1	3-45. Measuring an Unknown AC Voltage	3-13
1-14. Options	1-1	3-46. Calibrating a Stable AC Voltage Source	3-14
1-15. Instrument and Manual Identification	1-6	3-47. Enhancing Accuracy of a Stable AC Voltage Calibrator	3-15
<u>Section 2. Installation</u>			
2-1. Introduction	2-1	3-48. Verifying the Accuracy of an AC Voltmeter	3-16
2-3. Unpacking and Initial Inspection	2-1	3-49. Calibrating an AC Voltmeter	3-16
2-5. Performance Checks	2-1	3-50. Current Calibration and Measurement	3-17
2-7. Power Requirements	2-1	3-51. General	3-17
2-9. Grounding Requirements	2-2	3-59. Measuring an Unknown Current Using an Active Shunt	3-17
2-13. Installation and Mounting	2-2	3-60. Measuring an Unknown Current Using a Passive Shunt	3-19
2-15. Bench Mounting	2-2	3-61. Calibrating an AC/DC or AC Current Source Using an Active Shunt	3-20
2-17. Rack Mounting	2-2	3-62. Calibrating the AC/DC Difference of a Four Terminal Shunt or Resistor	3-22
2-22. Short Term Storage	2-2	3-63. Remote Operation Using the GPIB	3-25
2-24. Long Term Storage or Repackaging For Shipment	2-2	3-64. GPIB Description	3-25
2-29. Safety	2-5	3-66. 1605 Response to Bus Messages	3-25
2-30. Caution	2-5	3-68. Data	3-25
<u>Section 3. Operating Instructions</u>			
3-1. Introduction	3-1	3-70. Remote	3-25
3-3. Controls, Indicators, and Connectors	3-1	3-72. Local	3-25
3-5. AC Mains Power Requirements	3-1	3-74. Local Lockout	3-26
3-9. General Information	3-1	3-76. Clear Lockout	3-26
3-11. Required Auxiliary Equipment	3-1	3-78. Require Service (SRQ)	3-26
3-14. Certification	3-1	3-82. Status Byte	3-26
3-17. DC Voltage Read Out Equipment	3-8	3-85. Status Bit	3-28
3-21. Theory of Transfer Measurements	3-8	3-87. Pass Control	3-28
3-23. Preliminary Operation	3-9	3-89. Abort (Interface Clear)	3-28
3-24. Precautions	3-9	3-91. 1605 Addressing	3-28
3-27. Connection Errors and Loading Effects	3-9	3-93. Talk-Only (No Controller)	3-28
3-31. Attenuator Heating	3-10	3-94. 1605 GPIB Programming	3-28
3-32. Thermal EMFS	3-11	3-96. Algorithm	3-28
3-33. Operating Hints	3-11	3-99. Programming the 1605 Over the GPIB	3-30
3-34. Setting the RANGE Switch	3-11	3-101. Program Codes (Data Received by the 1605)	3-30
3-35. Mode Selection	3-12	3-103. Programming the SRQ Mask	3-30
3-36. Input Signal Stability	3-12	3-106. ASCII Format	3-30
3-37. DC Reversal Error	3-12	3-107. Reading the 1605's Status	3-30
3-38. Overvoltage Protection	3-12	3-109. Data Output	3-32
		3-111. Reading the 1605's Data Output	3-32
		3-113. Disabling the End Or Identify (EOI) Statement	3-32
		3-115. Complete Program Example	3-32
		3-118. Reading Ready	3-33
		3-120. Operator's Check	3-33
		3-121. Wake Up State	3-33
		3-123. Device Clear	3-33

LIST OF ILLUSTRATIONS

<u>NUMBER</u>		<u>PAGE</u>
1-1.	Model 1605 Transfer Standard	1-0
2-1.	Voltage Selection and Fused Receptacle	2-1
2-2.	Model 1605, Bench Mount Outline Dimensions	2-3
2-3.	Model 1605, Rack Mount Outline Dimensions	2-4
2-4.	Packing Diagram	2-6
3-1.	Model 1605 Front Panel Controls, Indicators, and Connectors . . .	3-2
3-2.	Model 1605 Rear Panel Controls, Indicators, and Connectors . . .	3-6
3-3.	Equipment Interconnections DC to 1 MHz	3-9
3-4.	Equipment Interconnections >1 MHz .	3-11
3-5.	AC Calibrator Accuracy Enhancement Test Set-Up	3-15
3-6.	AC Voltage Source Accuracy Enhancement >1 MHz	3-16
3-7.	Model 1625 Active Shunt	3-18
3-8.	Measuring Current Using Model 1625 Active Shunt	3-18
3-9.	Measuring Current Using a Resistive Shunt	3-20
3-10.	Calibrating a Current Source	3-21
3-11.	Calibrating AC/DC Difference of a Current Shunt	3-23
3-12.	Calibrating AC/DC Difference of a Current Shunt (Alternate Method). .	3-24

LIST OF TABLES

<u>NUMBER</u>		<u>PAGE</u>
1-1.	Specifications	1-2
1-2.	Accessories Available	1-6
1-3.	Available Options	1-6
2-1.	Safety Summary	2-7
2-2.	Safety Symbols	2-8
3-1.	Model 1605 Controls, Indicators, and Connectors	3-3
3-2.	Required Auxiliary Equipment	3-10
3-3.	Interface Functions	3-25
3-4.	Interrupt Control Codes	3-26
3-5.	Interrupt Response Codes	3-27
3-6.	1605 Address Codes	3-29
3-7.	1605 Program Codes	3-31
3-8.	Data Code	3-32

NOTE

The following sections and information are contained in Volume 2 of this Manual.

SECTION 4	THEORY OF OPERATION	4-1
SECTION 5	CALIBRATION AND MAINTENANCE	5-1
SECTION 6	PARTS LIST & CIRCUIT DIAGRAMS	6-1

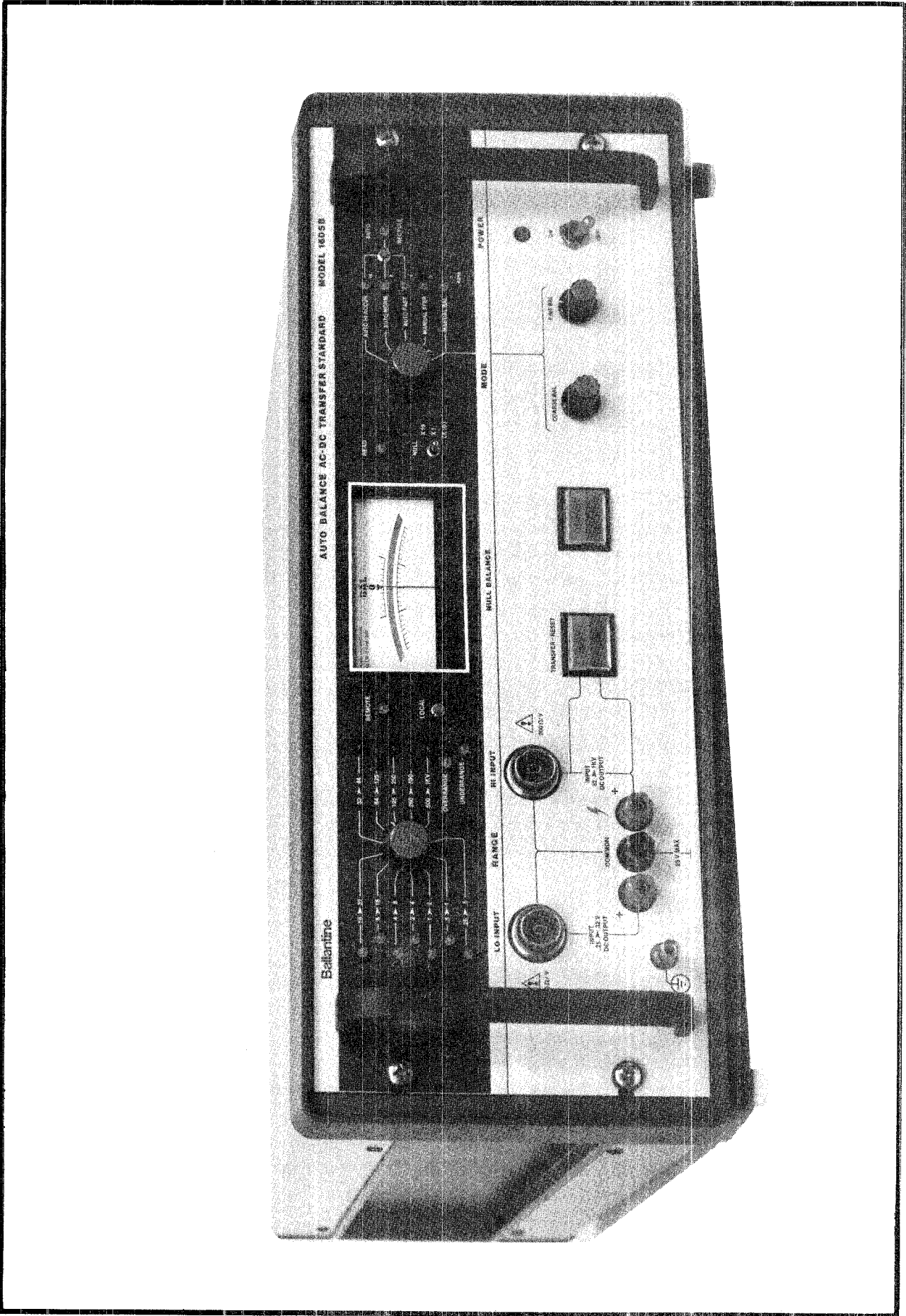

Figure 1-1. Model 1605 Transfer Standard

SECTION 1

GENERAL INFORMATION

1-1. INTRODUCTION

1-2. The Model 1605 is a precision Autobalancing AC-DC Thermal Transfer Standard. It is used to perform ac voltage and current measurements with uncertainties to 20 ppm. The instrument has input ranges from 0.5 volts to 1000 volts full scale. It is fully solid state and uses a multi-junction vacuum thermal element as the basic measurement device. There are no active elements or amplifiers in the measurement circuitry to limit bandwidth, limit crest factor, or add distortion. The instrument's basic machine error may be verified with dc voltages, and the ac bandwidth extends from less than 10 Hz to greater than 100 MHz. A rate sensing overload circuitry protects the 1605 against excessive inputs to 10 times full range. A microprocessor controls all functions and provides IEEE-488 interface bus control for systems applications.

1-3. The instrument input terminals and Transfer Assembly attenuators are floated off-ground so as to be independent with respect to the earth grounded instrument enclosure. This avoids common mode errors without the need for battery operation. An auxiliary dc digital voltmeter is used to read the output of the Transfer Standard. The optimum dc readout measuring point for this digital voltmeter is triggered over the interface bus and the measured dc output is averaged over a period of ten seconds to obtain best transfer accuracy.

The 1605 Autobalancing AC-DC Transfer Standard (ATS) is designed to permit manual or GPIB systems operation. A semi-skilled operator may make rapid, reliable, precise true rms responding measurements of ac voltages with minimum participation, which eliminates the possibility of operator error. The 1605 ATS will provide fully automatic transfers and may also be used in its semi automatic mode for manual transfers and manual balance which offers orthodox manual ac-dc transfer standard operation. The ac input signal is attenuated and applied to a multi junction thermal element which produces a dc voltage proportional to the rms heating value of the ac input signal. An internally generated dc voltage of the same heating value is then substituted (transferred) for the ac input signal and read out on an auxiliary precision digital dc voltmeter.

1-4. As the ac input voltage is applied to the thermal converter, the 1605 automatically balances the potential output of the thermal element. It then checks the null balance for drift of the input signal and subsequently locks the 18 bit DAC which serves as a stable analog memory for the null balance circuit. The input signal is then disconnected and a dc voltage is substituted. This dc voltage is automatically servoed to

provide the same thermal element null as the null balance point during the ac input state. This dc voltage is measured by the auxiliary digital voltmeter and is equal to the rms voltage of the ac input signal.

1-5. A multi junction thermal element joined with a unique Ballantine dc reversal difference correction circuit limits dc reversal error to approximately 10 ppm (0.001%) over the dynamic range of input signals. The unipolar dc transfer voltage therefore provides a single ac-dc transfer in less than 20 to 35 seconds without undue operator fatigue or training skills.

1-6. The 1605 is sufficiently stable to be used as a laboratory standard. Accuracy certification is available from Ballantine, the National Bureau of Standards, as well as other national standards laboratories throughout the world.

1-7. The 1605 does not require critical positioning or environmental controls. It is suitable as a laboratory standard, for ac calibrator accuracy enhancement, and may also serve as a reliable production line or field instrument. Computer aided software (Model 4060) for closed loop calibration of ac voltage calibrators and (Model 4052) for enhanced ac accuracy and complete digital multimeter calibration are available from Ballantine Laboratories.

1-8. The unit is normally supplied as a 19 inch rack unit encased in a sturdy enclosure. Rack mount slides are available as Option 15.

1-9. SPECIFICATIONS

1-10. Table 1-1 lists the specifications for the Model 1605.

1-11. AVAILABLE ACCESSORIES AND CURRENT SHUNTS

1-12. Table 1-2 lists the accessories and current shunts available for the 1605.

1-13. The Model 1625 Active AC-DC Current Shunt is available for current measurements. Transfer measurements with uncertainty of 100 ppm (0.01%) are applicable for currents from 20 uA to 100A over the frequency range of dc and 5 Hz to greater than 10 kHz. 100 kHz measurements are possible at reduced accuracy.

1-14. OPTIONS. The options available for the 1605 are listed in Table 1-3. Contact your Ballantine representative for additional options which may be available. Refer to Section 7 for specifications and information for the options.

TABLE 1-1. SPECIFICATIONS

Frequency Range:

± dc, 10 Hz to 100 MHz; Usable < 5 Hz to >250 MHz

Voltage Range:

12 Ranges, ± dc and ac rms

Low Voltage Input (Volts)

0.25 to 0.5 ± dc, 10 Hz to 100 MHz
 0.50 to 1.0 ± dc, 10 Hz to 100 MHz
 1 to 2 ± dc, 10 Hz to 100 MHz
 2 to 4 ± dc, 10 Hz to 100 MHz
 4 to 8 ± dc, 10 Hz to 30 MHz
 8 to 16 ± dc, 10 Hz to 30 MHz
 16 to 32 ± dc, 10 Hz to 1 MHz

High Voltage Input (Volts)

32 to 64 ± dc, 10 Hz to 1 MHz
 64 to 125 ± dc, 10 Hz to 1 MHz
 125 to 250 ± dc, 10 Hz to 100 kHz
 250 to 500 ± dc, 10 Hz to 100 kHz
 500 to 1000 ± dc, 10 Hz to 100 kHz

Underrange:

-10% of bottom of range. Minimum signal input is 225 mV. Indicator lamp illuminates when input signal is below underrange level and unit will not balance or transfer.

Overrange:

+10% of full range. Maximum signal input is 1100 Volts. Indicator lamp illuminates when overrange level is exceeded and unit will not balance or transfer.

Overvoltage Protection:

10 times full range voltage to maximum of 1100 Volts ±(dc + ac rms sinusoidal) applied continuously. Peak voltages may not exceed 1600 Volts. Overvoltage protection for the thermal element is complete and protects against change in reversal error characteristics as well as catastrophic destruction. Overvoltage protection is independent of frequency, crest factor, and does not load the input signal.

Standby Operation:

STANDBY pushbutton disconnects the thermoelement in INPUT mode. Overload condition forces STANDBY until overload is removed. Unit will return to OPERATE when STANDBY/OPERATE switch is pushed or OPERATE command is sent over the bus.

Crest Factor:

>100 to one of full range to a maximum of ± 300 Volts peak on the low voltage input and ± 1600 Volts peak on the high voltage input.

Input Resistance:

200 Ohms per Volt.

Input Isolation:

Input connectors may be floated ± 25 V (dc + peak ac) referenced to case ground.

Input-Output Transfer Uncertainty:

Uncertainty of the transferred voltage is specified at the center of a Series 874 Tee or the 16056A 5 port Tee connector.

DC to DC Transfer:

The transfer standard input is dc coupled and may be certified for all systematic errors by performing ± dc input to +dc output transfer. This establishes the uncertainty between input and output. Reversal error and thermal potentials are internally compensated and are included in the dc-dc transfer uncertainty budget.

$$\text{dc to dc uncertainty \%} = \frac{E_{\text{dc in}} - E_{\text{dc out}}}{E_{\text{dc in}}} \times 100$$

TABLE 1-1. SPECIFICATIONS - Cont'd.

AC to DC Transfer Uncertainty

90 day calibration interval at 23°C ± 5°C

Voltage Range	Transfer Error ±(% FS + μ V) --- DC i_{in}/DC_{out} ---	Error Limits as ± % of DC Output With AC/DC Correction Factors Applied							
		10 Hz to 20 Hz	20 Hz to 20 kHz	20 kHz to 50 kHz	50 kHz to 100 kHz	100 kHz to 1 MHz	1 MHz to 10 MHz	10 MHz to 30 MHz	30 MHz to 100 MHz
.25 to .5V	.002 + 10 μ V	0.014	0.003	0.004	0.008	0.025	0.2	0.5	2.5
.5 to 1	.0017 + 10 μ V	0.013	0.0025	0.0035	0.007	0.022	0.18	0.45	1.5
1 to 2	.0016 + 10 μ V	0.013	0.0023	0.0035	0.007	0.022	0.18	0.45	1.5
2 to 4	.0016 + 10 μ V	0.013	0.0023	0.0035	0.007	0.022	0.18	0.45	2.0
4 to 8	.0016 + 10 μ V	0.013	0.002	0.003	0.007	0.022	0.18	0.5	-
8 to 16	.0015 + 15 μ V	0.013	0.002	0.003	0.007	0.022	0.2	0.5	-
16 to 32	.0015 + 15 μ V	0.013	0.002	0.003	0.007	0.025	--	--	-
32 to 64	.0015 + 200 μ V	0.013	0.003	0.004	0.007	0.025	--	--	-
64 to 125	.0015 + 200 μ V	0.015	0.003	0.0045	0.01	0.025	--	--	-
125 to 250	.0016 + 200 μ V	---	0.003	0.0045	0.01	---	--	--	-
250 to 500	.0017 + 250 μ V	---	0.004	0.005	0.01	---	--	--	-
500 to 1000	.002 + 300 μ V	---	0.005	0.005	0.015	---	--	--	-

*All ranges are calibrated relative to 1 kHz using Ballantine's reference standards, which are traceable to NBS. The dc transfer output voltage is measured with a high resolution DVM, whose dc uncertainties are algebraically additive as are the NBS standard uncertainties. The dc output is averaged for 10 s after the READ command over successive ac to dc transfer measurements. All measurements are related to the center of the 16056A Tee, mounted at the input connector.

AC/DC difference correction factors referenced to 1 kHz are supplied by Ballantine for frequencies and amplitudes to obtain the above stated transfer accuracies. They are traceable through Ballantine standards that are typically 2 to 5 times better than the above specified ac/dc transfer accuracies. The uncertainties of the National Standards Laboratory may be added algebraically to obtain absolute accuracy.

**For 1 year accuracy, add the following % of dc output:

10 Hz to 20 kHz	± 0.001%	1 MHz to 10 MHz	± 0.015%
20 kHz to 100 kHz	± 0.0025%	10 MHz to 30 MHz	± 0.15%
100 kHz to 1 MHz	± 0.005%	30 MHz to 100 MHz	± 0.35%

TABLE 1-1. SPECIFICATIONS - Cont'd.

OPERATING MODES

Automatic Balance AC to DC Transfer:

Auto High Accuracy Mode:

Transfers instrument only after verifying input signal rms amplitude stability drift to be less than 10 ppm within 10 s.

Auto Normal Mode:

Transfers instrument only after verifying input signal rms amplitude stability drift to be less than 20 ppm within 5 s.

Auto Fast Mode:

Transfers instrument only after verifying input signal rms amplitude stability drift to be less than 40 ppm within 5 s.

Auto Recycle:

Repeats transfer measurement cycle approximately 15 s after each output READ command; Auto Recycle is an auto-zero mode, which avoids errors due to thermal drift.

Manual Transfer:

Balance is automatic. Operator decides exact moment to transfer from ac INPUT to dc OUTPUT mode when "null" balance is indicated.

Manual Balance:

Permits operator to manually balance the transfer standard in ac INPUT to dc OUTPUT transfer voltage measurement mode. Manual balance also offers reverse transfers in the dc OUTPUT to ac INPUT voltage setting mode which permits setting an ac input signal amplitude to a specific rms level with exacting accuracy.

GENERAL

DC Output:

Output Voltage:

Automatically provided by internal programmable dc power supply which is servoed through the thermoelement null balance reference. Output voltage range is +0.225 to +1100 V dc. DC output measurements are averaged over the 10 seconds following the READ command.

Output Load:

Accuracy specified into 10 Megohm load. Maximum load current is 2 mA.

Ripple and Noise:

95 dB below the level of the dc output voltage or 100 microvolts, whichever is greater. Noise is rms, measured over a 10 Hz to 100 kHz bandwidth, and averaged for 10 seconds.

Output Voltage Drift:

Referenced to output voltage at time of READ cycle. Applicable to each 15 second waiting period and after full temperature stabilization of the instruments.

0.5 to 15 Volt Ranges	± 20 ppm
32 to 125 Volt Ranges	± 80 ppm
250 to 500 Volt Ranges	± 100 ppm
1000 Volt Range	± 200 ppm

Null Balance:

A zero center null meter is provided with resolution of ± 50 ppm for each of 5 minor divisions on either side of zero. A meter x10 null expansion push button provides 5 ppm null resolution.

READ Command:

Automatic command sent over IEEE 488 interface bus which triggers auxiliary dc voltmeter used to read the transferred dc output voltage. READ command occurs when the transfer standard dc output has settled. A front panel READ indicator lamp is provided.

Calibration Facility

Transfer assembly (Model 16053B) may be removed from the frame for calibration. Thermo-element output is accessible for convenient ac-dc difference certification. Input-output command signal is provided for computer aided calibration of dc to dc, and ac to dc calibration verification.

TABLE 1-1. SPECIFICATIONS - Cont'd.

Interface Bus IEEE-488-1978:

Functions:

SH1, AH1, T10, LEO, T5, L4, SR1, PPO, RL1, DC1, DT0, CO.

Bus Controls:

Range (12), Balance (5), Operate, Standby, Recycle (3), Measure Input, Measure Output.

Isolation:

Opto-isolated from measuring circuits. Bus digital ground connected to case.

Environmental:

Temperature:

Operating: 0 to 50°C
 +10°C to +40°C to full specifications
 Storage: -40°C to +75°C

Humidity:

95% RH to 35°C
 90% RH 35°C to 50°C
 non-condensing

Altitude:

Operating: to 3 km (10,000 feet)
 Storage: to 15 km (50,000 feet)

Compliant with MIL-T-28800, Class 5 for shock, vibration, bench handling, fungus resistance.

Power:

100, 120, 220, 240 Volts ac, +8% -10%; 50 to 400 Hz.
 Approximately 80 VA.

Dimensions:

	<u>Basic Unit</u>	<u>Overall Enclosure</u>
Height	178 mm (7")	203 mm (8")
Width:	425 mm (16.75")	521 mm (20.5")
Width of Front Panel:	482 mm (19")	
Depth:	508 mm (20")	527 mm (20.75")
Depth Behind Front Panel:	470 mm (18.5")	
Weight:	16.4 kg (36 lbs.)	25.5 kg (56 lbs.)
Shipping Weight:	25.5 kg (56 lbs.)	31.7 kg (70 lbs.)

Supplied Accessories:

Model 16056A 5 Port Tee Connector
 AC Mains Power Cable
 Operation Manual Vol 1
 Maintenance Manual Vol 2

Options Available

Option 15 Rack Mount (bench enclosure not provided)

Accessories Available

Model 12620A Type 874 to BNC female adapter
 Model 16051A 4 Port Tee Connector (< 100 kHz)
 Model 16052A BNC Port Tee Connector (to 100 MHz)
 Model 16053B Transfer Assembly
 Model 16054A Maintenance Accessory Kit
 Model 16057A Software for computer-aided calibration of 1605B
 Model 6400A AC Voltage Standard
 Model 1620A 100 A DC/AC Transconductance Amplifier
 Model 1621A 20 A 100 kHz DC/AC Transconductance Amplifier
 Model 1625A 100 A DC/AC Active Shunt
 Model 4060H Computer aided calibration system for AC Voltage Standards
 Model 4052H Computer aided calibration system with enhanced ac accuracy for DVM and DMM calibration
 89-11627-1A Spare parts support kit for 1605B (2 year)

1-15. INSTRUMENT AND MANUAL IDENTIFICATION

1-16. These Ballantine instruments are identified by a two section serial number. The first three-digit section of this number identifies the configuration code. This code number appears on the front page of the manual and must coincide

with the first three digits of the serial number of your instrument. Addendum sheets supplied with the manual will define technical corrections or differences between your instrument and the unit described in this manual. If applicable, back dating information is located at the end of this manual. This back dating information pertains to instruments with serial number prefixes listed on the front page.

TABLE 1-2. ACCESSORIES AVAILABLE

ACCESSORY	BALLANTINE PART NO.	DESCRIPTION
Active AC-DC Current Shunt	Model 1625A	Provides current measurement capability from 20 uA to 100A in 7 decade ranges dc and 10 Hz to 10 kHz. Includes amplifier with sensed output to drive ATS 200 uA to 100A in 7 decade ranges.
Transconductance Amplifier	Model 1620A-60-04	Used as GPIB controllable precision current source to 100 Amps.
Transconductance Amplifier	Model 1621A-60	Used as GPIB controllable precision current source to 20 Amps.
4 Port Tee	Model 16051A	Provides precision input Tee for ATS usable to 100 kHz.
3 Port Tee	Model 16052A	Provides input tee for ATS with BNC signal input.
Transfer Assembly	Model 16053B	Additional transfer assembly for the 1605 ATS.
Maintenance Accessory Kit	Model 16054A	Provides extender cables for operating the 16053 transfer assembly outside the main frame. Provides relay to automatically switch external dc DVM between input and output connectors.
IEEE Bus Cable	88-10136-0A	2m GPIB bus cable
Adapter, 874 to BNC	Model 12620A	Adapter, 874 to BNC female for input connection
Adapter, Dual Banana to BNC	Model 12616A	Shielded adapter, dual banana plug to BNC female. For dc output voltage connections.
Spare Parts Kit	89-11627-1A	2 year spare parts kit

TABLE 1-3. AVAILABLE OPTIONS

OPTION	INSTALLATION	DESCRIPTION
Option 15	Field or Factory	Rack mount slide kit for 1605. Includes rack slides and deletes bench cabinet.

SECTION 2

INSTALLATION

2-1. INTRODUCTION

2-2. This section contains information and instructions necessary for the installation and shipping of the Model 1605 ATS. Details are provided for initial inspection, power connection, grounding safety requirements, installation information, and repacking instructions for storage or shipment.

2-3. UNPACKING AND INITIAL INSPECTION

2-4. Unpacking and handling of the voltmeter requires only the normal precautions and procedures applicable to the handling of sensitive electronic equipment. The contents of all shipping containers should be checked for included accessories and certified against the packing slip to ascertain that the shipment is complete. If there is indication of shipping damage save the shipping container and immediately notify the freight company.

2-5. PERFORMANCE CHECKS

2-6. This instrument was carefully inspected for mechanical and electrical performance before shipment from the factory. It should be free of physical defects and in perfect electrical order upon receipt. Check the instrument for damage in transit and perform the electrical procedure outlined in paragraph 5-10, Volume 2. For performance deficiencies not attributable to shipping damage see the warranty in this manual and notify your local Ballantine field engineering representative or the factory.

CAUTION

It is recommended that the operator be fully familiar with the specifications and all sections of this manual. Failure to do so may compromise the warranty and the accuracy which Ballantine has engineered into your instrument.

2-7. POWER REQUIREMENTS

2-8. The instrument may be operated from any one of the following ac sources:

- a. 90 to 110 volts (100 volts nominal)
- b. 108 to 132 volts (120 volts nominal)
- c. 198 to 242 volts (220 volts nominal)
- d. 216 to 264 volts (240 volts nominal)

e. All instruments operate over the power frequency range of 48 to 440 Hz. Always verify that the operating mains voltage is the same as that specified on the rear panel power receptacle switch plug. See Figure 2-1.

CAUTION

Failure to switch the instrument to match the operating mains voltage will damage the instrument and may void the warranty.

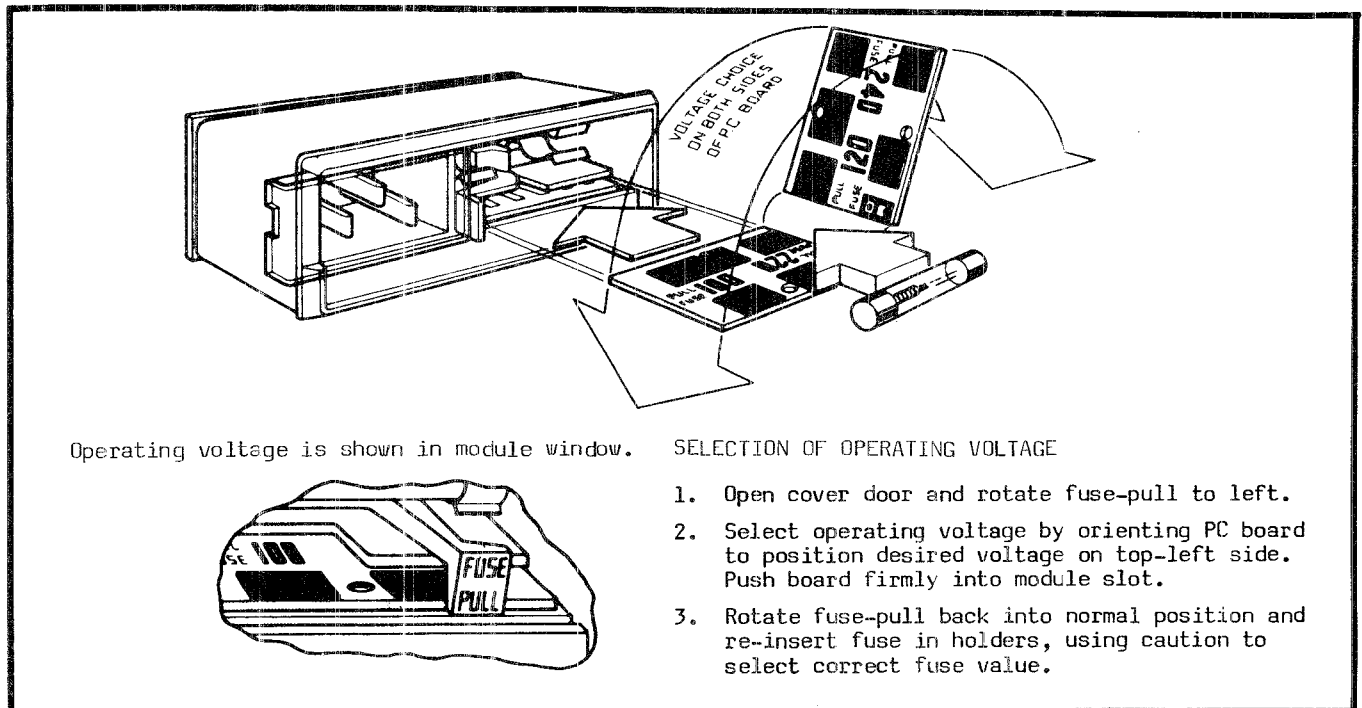

Figure 2-1. Voltage Selection and Fused Receptacle

f. The instrument should be operated from a power source with its neutral at or near ground (earth) potential. The instrument is not intended for operation from two phases of a multiphase ac system or across the legs of a single-phase, three-wire ac power system. Crest factor (ratio of peak voltage to rms) should be typically within the range of 1.3 to 1.6 at -8%/+10% of the nominal rms main voltage. Use a true rms responding voltmeter, such as the Ballantine Model 9648 or 3036, to measure the ac mains power voltage.

2-9. GROUNDING REQUIREMENTS

2-10. To insure the safety of operating personnel, the U.S. O.S.H.A. (Occupational Safety and Health) requirement and good engineering practice mandate that the instrument panel and enclosure be "earth" grounded. All Ballantine instruments are provided with an Underwriters Laboratories (U.L. and C.S.A.) listed three-conductor power cable, which when plugged into an appropriate power receptacle, grounds the instrument. The long offset pin on the male end of the power cable carries the ground wire to the long pin of the Euro connector (DIN standard) receptacle on the rear panel of the instrument.

2-11. To preserve the safety protection feature when operating the instrument from a two-contact outlet, use a three-prong to two-prong adapter and connect the green lead on the adapter to an "earth" ground.

2-12. For best measurement accuracy, always connect all instruments used in conjunction with the 1605 to the same mains branch circuit so as to minimize power mains common mode effects and circulating ground currents.

2-13. INSTALLATION AND MOUNTING

2-14. The instrument is fully solid state and dissipates minimal power. No special cooling is required. However, the instrument should not be operated where the ambient temperature exceeds 55°C (131°F), when the relative humidity exceeds 95% or condensation appears anywhere on the instrument.

2-15. BENCH MOUNTING

2-16. The instrument is shipped with feet and tilt stand in place and ready for use as a bench or portable instrument. See outline drawing Figure 2-2 for dimensions of the unit in its enclosure. The 1605 is normally furnished with a sturdy "Optima" case and requires no special installation procedures. The unit may be withdrawn from its case by removing the four retaining screws at the front panel and the four retaining screws at the rear panel. The 1605 may then be removed from its case using the handles at the front panel and pulling it out of the case.

2-17. RACK MOUNTING

2-18. The 1605 ATS may be mounted in a standard 19 inch rack. It will occupy seven inches of panel height.

2-19. To mount the bench unit in a rack, remove it from the "Optima" bench mount cabinet as indicated in paragraph 2-16. If the 1605 has slide bars attached for use with the bench mount cabinet, then remove the slide bars.

2-20. Ballantine supplies a set of rack slides for the 1605 which are Option 15. These rack mount slides are bolted onto the 1605 using the threaded inserts at the sides of the unit. If rack installation is subject to shock and vibration, rear mechanical supports for the 1605 are recommended.

2-21. See Figure 2-3 for Rack Mount outline dimensions.

NOTE

The 1605 ATS is a thermally sensitive precision instrument. DO NOT mount next to high temperature equipment or in strong magnetic or RF fields. DO NOT exceed the specified temperature range and avoid temperature change rates exceeding 5°C per hour when the 1605 is used to make precision measurements. Avoid forced air cycled ventilation system to optimize measuring accuracy. DO NOT mount the ATS or its cables in strong AC magnetic fields or subject it to excessive radiated or conducted EMI. Provide accessibility to rear connectors and switches when the 1605 is rack mounted.

2-22. SHORT TERM STORAGE

2-23. If the instrument is to be stored for a short period of time (less than three months) place cardboard over the panel, and cover the instrument with suitable protective covering such as a plastic bag or strong kraft paper. Place power cable and other accessories with the instrument. Store the covered instrument in a clean dry area that is not subject to extreme temperature variations or conditions which may cause moisture to condense on the instrument.

2-24. LONG TERM STORAGE OR REPACKAGING FOR SHIPMENT

2-25. If the instrument is to be stored for a long period or shipped, proceed as directed below. If you have any questions contact your local Ballantine field engineering representative or the Ballantine Service Department at the factory.

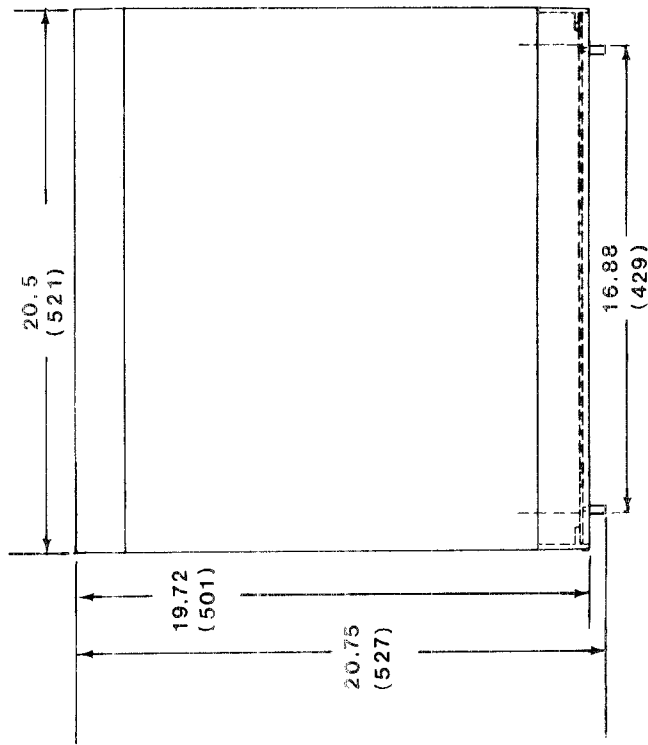

BENCH

Dimensions are in inches and (mm).

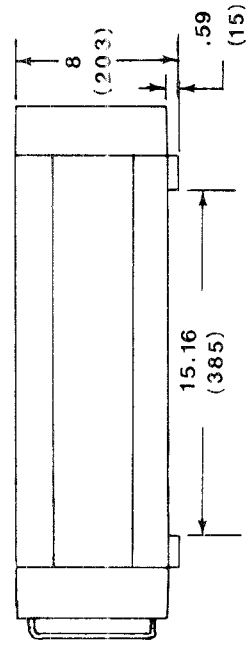
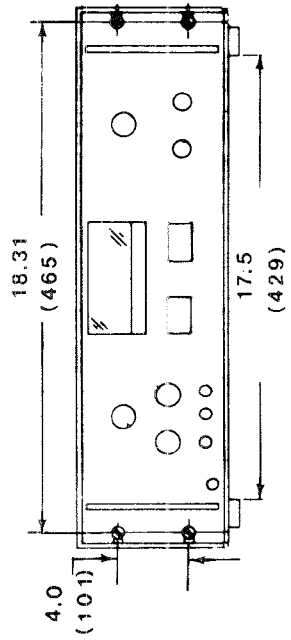

Figure 2-2. Model 1605, Bench Mount Outline Dimensions

RACK

Dimensions are in inches and (mm).

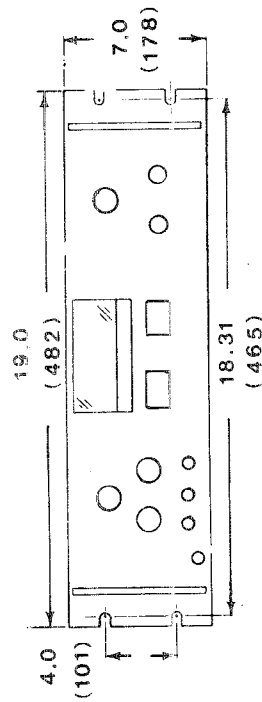
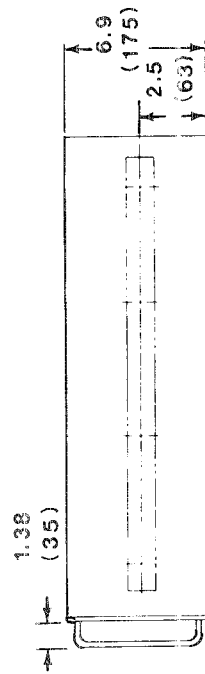
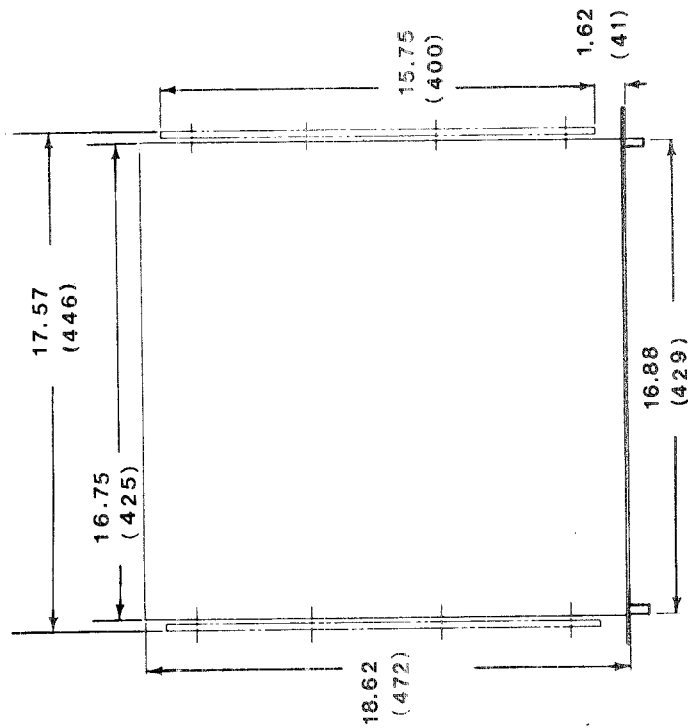

Figure 2-3. Model 1605; Rack Mount Outline Dimensions

2-26. If the original Ballantine supplied packing is to be used proceed as follows:

a. If the original wrappings, packing material and container have been saved, repack the instrument and accessories originally shipped to you. If the original container is not available, one may be purchased through the Ballantine Service Department at the factory.

b. Be sure the carton is well sealed with strong tape or metal straps.

c. Mark the carton with the model number and serial number with indelible marking. If it is to be shipped, show sending address and return address on two side of the box; cover all previous shipping labels.

2-27. If the original container is not available, proceed as follows: (See Figure 2-4).

a. Before packing the unit, place all accessories into a plastic bag and seal the bag.

b. For extended storage or long distance shipping only, use U.S. Government packaging method II C and tape a two-unit bag of desiccant (per MIL-D-3464) on the rear cover.

c. Place a 178 mm (7 inch) by 483 mm (19 inch) piece of sturdy cardboard over the front panel for protection.

d. Place the instrument into a plastic bag and seal the bag.

e. Wrap the bagged instrument and accessories in one inch thick flexible cellular plastic film cushioning material (per PPP-C-795) and place in a barrier bag (per MIL-B-131). Extract air from bag and heat seal.

f. Place bagged instrument and accessories into a 356 mm (14 inch) x 660 mm (26 inch) x 711 mm (28 inch) fiber board box (per PPP-B-636 type CF, class WR, variety SW, grade V3C). Fill additional spaces with rubberized hair or cellular plastic cushioning material. Close box in accordance with container specifications. Seal with

sturdy water resistant tape or metal straps. It is strongly recommended that this box be placed into another box 10 cm (4 inches) larger in each dimension. Space the packed inner box with corner inserts. This double boxing assures safe arrival after shipment.

g. Mark container "DELICATE INSTRUMENT", "FRAGILE", etc. Mark instrument model and serial number and date of packaging. Affix shipping labels as required or mark according to MIL-STD-129.

NOTE:

If the instrument is to be shipped to Ballantine for calibration or repair, attach a tag to the instrument identifying the owner. Note the problem, the symptoms, and service or repair desired. Record the model and serial number of the instrument. Show the work authorization number as well as the date and method of shipment.

2-28. Always contact factory for return authorization and a control number BEFORE shipping to Ballantine.

2-29. SAFETY

2-30. CAUTION. This instrument measures and provides potentials to 1600 Volts peak which are potential personnel hazards. Operate ranges above 32 Volts with great care. Read and understand this manual to operate the 1605 safely.

WARNING

The high voltage dc output terminals may have potentials to 1600 Volts which present severe personnel shock hazard and require care in handling and interconnections to auxiliary instruments.

2-31. See Table 2-1 for a safety summary and Table 2-2 for a listing of safety symbols.

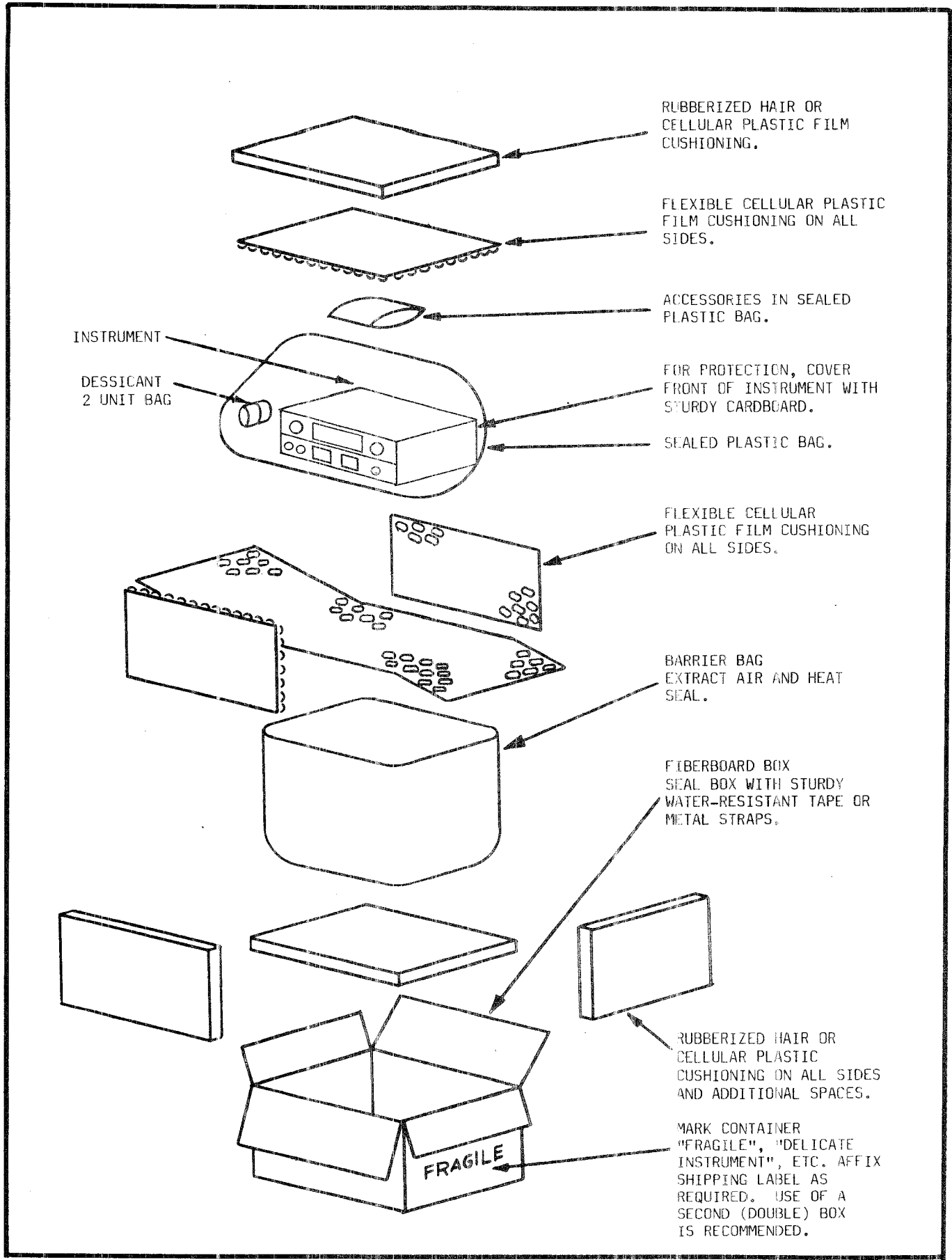

Figure 2-4. Packing Diagram

SAFETY SUMMARY

The following general safety precautions must be observed during all phases of operation, service, and repair of this instrument. Failure to comply with these precautions or with specific warnings elsewhere in this manual violates safety standards of design, manufacture, and intended use of the instrument. Ballantine Laboratories assumes no liability for the customer's failure to comply with these requirements.

GROUND THE INSTRUMENT

To minimize shock hazard, the instrument chassis and cabinet must be connected to an electrical ground. The instrument is equipped with a three-conductor ac power cable. The power cable must either be plugged into an approved three-contact electrical outlet or used with a three-contact to two-contact adapter with the grounding wire (green) firmly connected to an electrical ground (safety ground) at the power outlet. The power jack and mating plug of the power cable meet International Electrotechnical Commission (IEC) safety standards.

DO NOT OPERATE IN AN EXPLOSIVE ATMOSPHERE

Do not operate the instrument in the presence of flammable gases or fumes. Operation of any electrical instrument in such an environment constitutes a definite safety hazard.

KEEP AWAY FROM LIVE CIRCUITS

Operating personnel must not remove instrument covers. Component replacement and internal adjustments must be made by qualified maintenance personnel. Do not replace components with power cable connected. Under certain conditions, dangerous voltages may exist even with the power cable removed. To avoid injuries, always disconnect power and discharge circuits before touching them.

DO NOT SERVICE OR ADJUST ALONE

Do not attempt internal service or adjustment unless another person, capable of rendering first aid and resuscitation, is present.

DO NOT SUBSTITUTE PARTS OR MODIFY INSTRUMENTS

Because of the danger of introducing additional hazards, do not install substitute parts or perform any unauthorized modification to the instrument. Return the instrument to Ballantine Laboratories Service Department for service and repair to ensure that safety features are maintained.

DANGEROUS PROCEDURE WARNINGS

Warnings, such as the example below, precede potentially dangerous procedures throughout this manual. Instructions contained in the warnings must be followed.

WARNING

Dangerous voltages to 2000 Volts, capable of causing death, are present in this instrument. Use extreme caution when handling, testing, and adjusting.

TABLE 2-2

SAFETY SYMBOLS

General Definitions of Safety Symbols Used On Equipment or In Manuals



Instruction manual symbol: the product will be marked with this symbol when it is necessary for the user to refer to the instruction manual in order to protect against damage to the instrument.



Indicates dangerous voltage (terminals fed from the interior by voltage exceeding 1000 volts must be so marked).

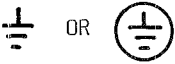

Protective conductor terminal. For protection against electrical shock in case of a fault. Used with field wiring terminals to indicate the terminal which must be connected to ground before operating instrument.



Low-noise or noiseless, clean ground (earth) terminal. Used for a signal common, as well as providing protection against electrical shock in case of a fault. A terminal marked with this symbol must be connected to ground in the manner described in the installation (operating) manual, and before operating the equipment.

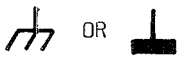

Frame or chassis terminal. A connection to the frame (chassis) of the equipment which normally includes all exposed metal structures.



Alternating current (power line).



Direct current (power line).



Alternating or direct current (power line).

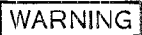

The WARNING sign denotes a hazard. It calls attention to a procedure, practice, condition or the like, which, if not correctly performed or adhered to, could result in injury or death to personnel.



The CAUTION sign denotes a hazard. It calls attention to an operating procedure, practice, condition or the like, which, if not correctly performed or adhered to, could result in damage to or destruction of part or all of the product.



The NOTE sign denotes important information. It calls attention to procedure, practice, condition or the like, which is essential to highlight.

SECTION 3

OPERATING INSTRUCTIONS

3-1. INTRODUCTION

3-2. This section contains instructions required for the operation of the Ballantine 1605 Autobalancing Thermal Transfer Standard (ATS). Included are identification of controls, connectors, and indicators as well as turn on procedures and operating instructions.

3-3. CONTROLS, INDICATORS, AND CONNECTORS

3-4. The instrument controls, indicators, and connectors are identified in Figure 3-1 for the front panel and Figure 3-2 for the rear panel. They are described in Table 3-1.

3-5. AC MAINS POWER REQUIREMENTS

3-6. See paragraphs 2-7 through 2-12 for ac mains voltage and grounding requirements.

3-7. Before connecting ac mains be sure that the Voltage Selector switch on the rear panel is set for the corresponding ac mains voltage. See Figure 2-1.

WARNING

Failure to have the AC Mains Voltage Selector switch in the correct position can cause serious damage to your instrument and may void the warranty.

3-8. To power up the instrument, connect the ac mains power cable and turn the POWER toggle switch to ON. Note that the green pilot lamp lights.

WARNING

Be sure to connect the case ground of the instrument to earth ground through the power cable, or faulty measurements and possible personnel shock hazard may result.

3-9. GENERAL INFORMATION

3-10. Although the ATS is a relatively simple instrument to use, the operator should read and be fully familiar with paragraphs 2-11 through 2-21 for the background material required to obtain maximum service from the instrument.

3-11. REQUIRED AUXILIARY EQUIPMENT

3-12. The 1605 ATS with the equipment listed in Table 3-2 will form a complete system capable of measuring an ac voltage or current. The ATS will also calibrate ac voltage or current as well as measure frequency response from less than 10 Hz to greater than 100 MHz. No auxiliary thermal voltage converters such as the Ballantine 1394A Series or the Fluke A55 Series are required since this capability is built into the 1605 ATS.

3-13. The 1605 ATS is a transfer instrument. It is a nulling device and is inherently stable. Since all transfer measurements are made by comparison, accuracy is dependent upon (1) the machine errors of the ATS, (2) the ac-dc difference calibration and stability of the ATS, and (3) the accuracy of the dc read out measuring equipment. It is also necessary that the input signal being measured is somewhat more stable in its rms amplitude than the degree of desired measurement accuracy. The 1605 ATS includes circuitry to ascertain input signal stability and drift, and the unit will not provide automatic transfers when input signal stability is not commensurate with the desired measurement accuracy.

3-14. CERTIFICATION

3-15. Each new Ballantine 1605 ATS is supplied with test data traceable to the National Bureau of Standards. NBS will also check your 1605 and issue a test report at frequencies and voltages specified by your request. Recertification of your 1605 may be accomplished in your laboratory using certified Ballantine Thermal Converters traceable to NBS. Ballantine also provides this recertification service which helps to reduce the NBS work load and customer waiting time.

3-16. The error budget for ac-dc transfer measurements applicable to the 1605 consists of:

a. Machine Error. This is the basic systemic transfer uncertainty. It is expressed as DC to DC transfer uncertainty and may be readily verified by the user. Only a stable, low noise dc voltage source and the auxiliary 7 1/2 digit voltmeter are required to determine DC INPUT to DC OUTPUT transfer uncertainty. The limits for DC INPUT to DC OUTPUT transfer uncertainty include the dc reversal error, and are included in the measurement error uncertainties shown in Table 1-1.

To minimize systematic machine transfer uncertainty it is required to ensure the DC OUTPUT voltage is averaged over a ten second period which begins after the 1605 has stably settled in the DC OUTPUT state as indicated by the READ command and front panel READ indicator lamp.

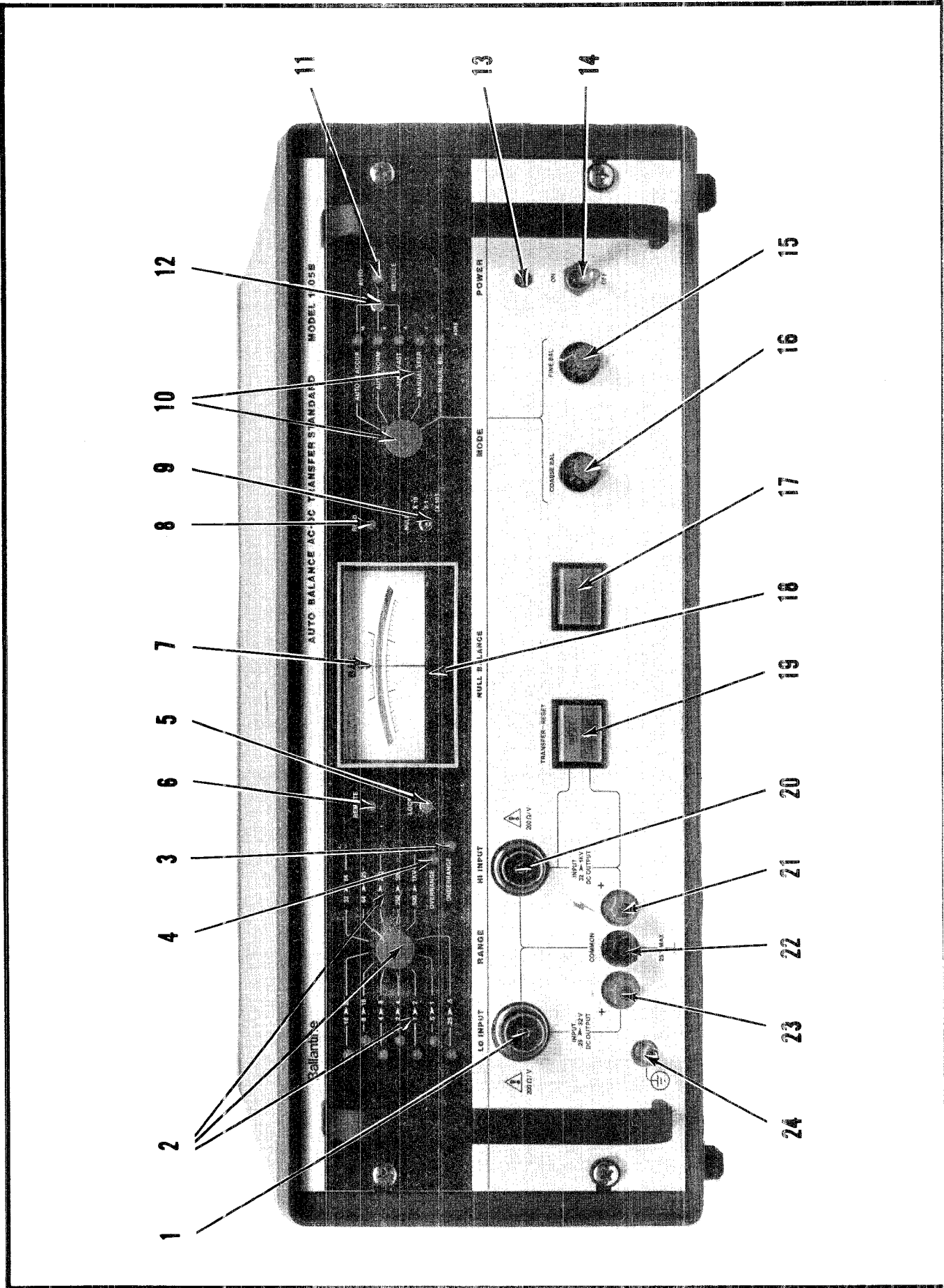

Figure 3-1. Model 1605 Front Panel Controls, Indicators, and Connectors

TABLE 3-1. MODEL 1605 CONTROLS, INDICATORS, AND CONNECTORS

INDEX NO.	CONTROL, INDICATOR, OR CONNECTOR	REFERENCE DESIGNATOR	DESCRIPTION
1	LO INPUT connector	A1-J43	Input connector; 0.25V to 32V
2	RANGE selector with indicators	A14-S2 A14-DS1 A14-DS2 A14-DS3 A14-DS4 A14-DS5 A14-DS6 A14-DS7 A14-DS8 A14-DS9 A14-DS10 A14-DS11 A14-DS12	Switch selects one of 12 ranges 0.25 to .5 V .5 to 1 V 1 to 2 V 2 to 4 V 4 to 8 V 8 to 16 V 16 to 32 V 32 to 64 V 64 to 125 V 125 to 250 V 250 to 500 V 500 to 1000 V
3	UNDERRANGE indicator	A14-DS14	Lights when input signal amplitude is less than 10% below minimum range. Flashes intermittently to alert operator.
4	OVERRANGE indicator	A14-DS13	Lights when input signal amplitude exceeds 10% above maximum range.
5	LOCAL push switch	A14-S4	Push to set unit for local operation with front panel controls.
6	REMOTE indicator	A14-DS15	Lights when unit is under remote GPIB control with front panel controls inactive.
7	NULL BALANCE meter	A20-M1	Indicates proximity to thermo-element null balance condition when in INPUT mode. Null balance indicator for MANUAL BALANCE, MANUAL TRANSFER, and AUTO operating modes.
8	READ indicator	A24-DS1	Lights after transfer to OUTPUT mode when dc output is to be measured. Extinguishes after 15 seconds to indicate that dc output reading time has elapsed.
9	NULL x10 momentary push switch	A24-S7	Increases NULL BALANCE meter resolution by factor of 10 to 5 ppm (0.0005%).

TABLE 3-1. MODEL 1605 CONTROLS, INDICATORS, AND CONNECTORS - Cont'd.

INDEX NO.	CONTROL, INDICATOR OR CONNECTOR	REFERENCE DESIGNATOR	DESCRIPTION
10	<p>MODE switch with indicators</p> <p style="text-align: center;"><u>NOTE</u></p> <p>The 5 MODE INDICATOR lamps also annunciate the bus address as selected by the BUS ADDRESS switch located on the rear panel. The uppermost LED shows the MSD while the lower LED shows the switch setting for the LSD. A lit lamp shows the switch ON condition. The MODE indicators serve as bus address annunciators during a ten second period following the POWER ON self test start up sequence.</p>	<p>A24-S8</p> <p>A24-DS2</p> <p>A24-DS3</p> <p>A24-DS4</p> <p>A24-DS5</p> <p>A24-DS6</p>	<p>Permits selection of 5 operating modes:</p> <p>AUTO HI ACCURACY Use to automatically measure the most stable input signals.</p> <p>AUTO NORM Use to automatically measure input signals having amplitude drift of less than 20 ppm within 5 sec.</p> <p>AUTO FAST Use to automatically measure input signals in minimum time. The input signal amplitude drift must be less than 40 ppm within 5 sec.</p> <p>MANUAL TRANSFER Use to automatically Null Balance input signals having considerable amplitude drift and instability. The operator makes the decision exactly when to measure the input signal by pushing the INPUT/OUTPUT switch.</p> <p>MANUAL BALANCE Use to manually Null Balance the input signal. Also used "in reverse" to permit adjusting an input signal to a precisely established dc output amplitude. Transfer from input to output state is done by pushing the INPUT/OUTPUT switch.</p>
11	AUTO RECYCLE indicator	A24-DS7	Lights to indicate unit is in AUTO RECYCLE mode.
12	AUTO RECYCLE switch	A24-DS9	Momentary switch. Push to activate or deactivate AUTO RECYCLE mode which automatically reverts the unit dc OUTPUT to ac input state approximately 15 seconds after READ indication. This mode is an auto zero feature applicable only to the 3 automatic measurement modes.
13	Power ON indicator	A24-DS8	Green LED lights when ac mains power is switched ON.
14	ON/OFF power switch	A20-S1	Toggle switch for turning instrument ON and OFF.
15	MANUAL BAL FINE BAL control	A20-R1	10 turn control permits vernier adjustment of NULL BALANCE when operating in the MANUAL BALANCE mode.

TABLE 3--1. MODEL 1605 CONTROLS, INDICATORS, AND CONNECTORS - Cont'd.

INDEX NO.	CONTROL, INDICATOR OR CONNECTOR	REFERENCE DESIGNATOR	DESCRIPTION
16	MANUAL BAL COARSE BAL control	A20-R2	10 turn control used for coarse adjustment of NULL BALANCE when operating in the MANUAL BALANCE mode.
17	STANDBY/OPERATE switch	A20-S6	Illuminated momentary switch used to activate and indicate OPERATE mode and STANDBY mode. STANDBY disconnects the input signal and reduces the dc output to safe levels. Input overvoltage, RANGE, and MODE setting changes automatically set unit to STANDBY.
18	Meter Mechanical Zero adjustment	A20-M1	Screwdriver service adjustment permits mechanical zero setting of meter pointer at BAL center line when power is OFF.
19	INPUT/OUTPUT switch	A20-S5	Illuminated momentary switch used to transfer from INPUT measuring state to dc OUTPUT state and also to reset from dc OUTPUT state to INPUT state. When INPUT is illuminated, the input connectors present a 200 ohms/volt load and connect the thermoelement. When OUTPUT is illuminated, the LO INPUT and HI INPUT connectors are safely disconnected and dc output voltage will be present at the DC OUTPUT binding posts.
20	HI INPUT 874 connector	A1-J44	Input connector; 32V to 1000V.
21	DC OUTPUT 32 ▶ 1 kV	A1-J42	Red binding post connector supplies positive dc output voltage from 32V to 1000V. It is active whenever red LED (safety alert) high voltage RANGE indicators are illuminated.
22	COMMON connector	A1-J41	Black binding post connector is common terminal for both dc output connectors. COMMON is isolated and floating with respect to earth ground to 25V ±(dc + peak ac).
23	DC OUTPUT .25 ▶ 32V	A1-J40	Red binding post connector supplies positive dc output voltage from 0.25V to 32V. It is active whenever amber LED RANGE indicators are illuminated.
24	 case ground terminal	A1-J39	Metal binding post connector provides connection to case and earth ground. It is common to GPIB digital output ground and permits earth grounding the COMMON connector when severe peaks or excessive common mode voltages are encountered with the input signal.

25 26 27 28 29 30

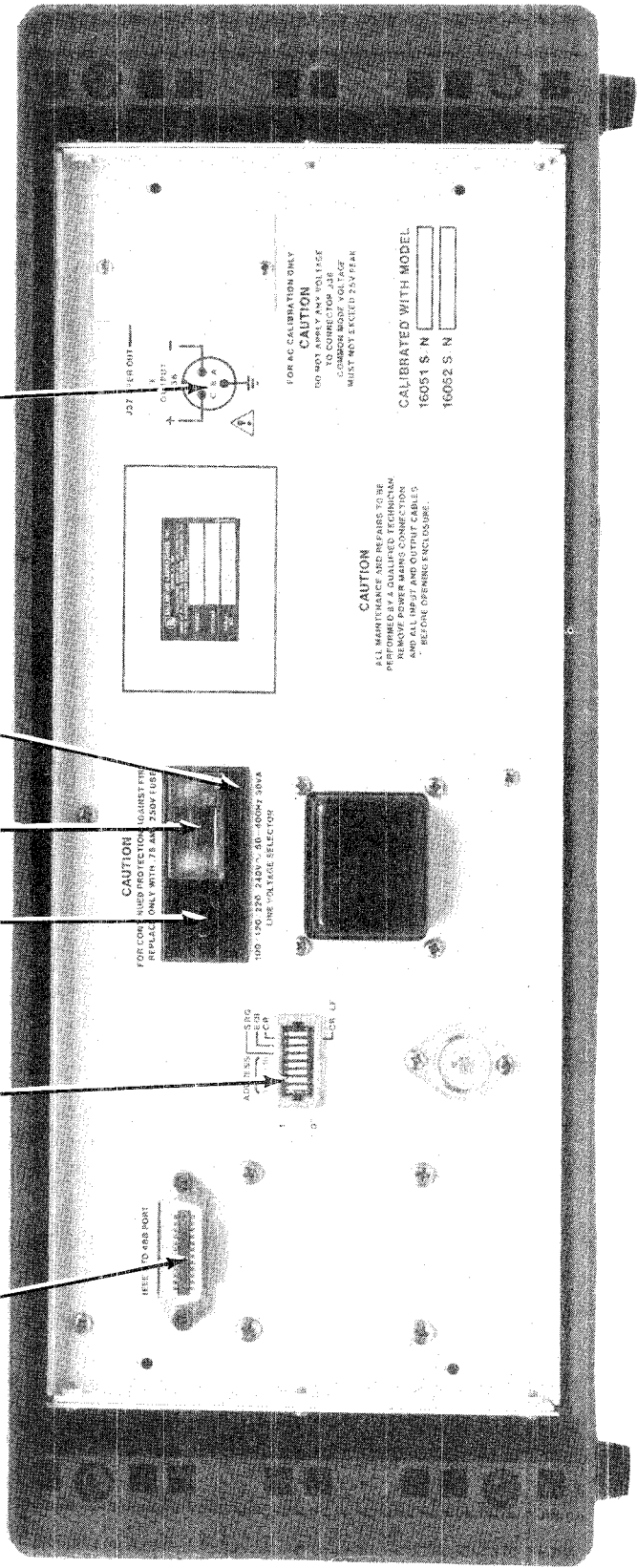

Figure 3-2. Model 1605 Rear Panel Controls, indicators, and Connectors

TABLE 3-1. MODEL 1605 CONTROLS, INDICATORS, AND CONNECTORS - Cont'd.

INDEX NO.	CONTROL, INDICATOR OR CONNECTOR	REFERENCE DESIGNATOR	DESCRIPTION
25	IEEE STD 488 port	A19-J1	IEEE-488-1978 bus connector.
26	BUS ADDRESS switches	A19-S19	IEEE-488 Address setting switches (5) and selection of SRQ, EO1, and CR or CR/LF.
27	AC mains power cable receptacle	A19-J34	Receptacle for ac mains power input cable 33-10000-0.
28	AC mains fuse	A19-F1	AC mains fuse 0.75A at 250V.
29	AC mains voltage selector switch	A19-S34	AC mains voltage selector switch selects 100, 120, 220, and 240 Volt operation. See Figure 2-1.
30	Thermal element output voltage access connector	J36/J37 (dual) J36 (ms)	Dual banana receptacle in units with serial prefix 020. In units with serial prefix 021, 3 pin MS receptacle provides buffered access to thermoelement A1-IC1 output for use only when calibrating ac frequency response of the ATS. Use with MS plug.

b. AC-DC Difference Uncertainty. This is the frequency response error of the 1605. Since the dc to 1 kHz error of approximately 2 ppm is inconsequential within the error budget, the 1605 is specified as ac to 1 kHz difference uncertainty. Using a 1 kHz reference simplifies calibration and improves effective calibration accuracy because switching between ac and dc sources is not required. Nor do reversal errors or thermal offset voltages impact on the frequency response calibration with ac to 1 kHz difference frequency response calibration.

c. Table 1-1 states the corrected uncertainty limits of the 1605 when NBS traceable AC-DC (or AC to 1 kHz) difference correction factors have been applied. The instrument may be used without correction of the AC-DC difference. Transfer measurements made by the 1605 will then be within the accuracies stated in Appendix 1.

d. For the most precise transfer measurements it is necessary to correct for the actual AC-DC difference. Correction factors provided by precisely comparing the 1605 to NBS traceable standards must be provided at appropriate amplitudes and frequencies as indicated above in paragraph 3-15. A positive correction factor means that the input signal must be increased by the correction percentage, i.e., the instrument indicates low compared to the reference (dc or 1 kHz). A negative correction factor means that the input signal must be decreased by the correction percentage, i.e., the instrument reads high compared to the reference (dc or 1 kHz).

e. Correction factors are expressed as a \pm percentage. To apply correction factors to the transferred DC OUTPUT measurement, apply the following formula:

CF = Correction Factor in percent

M = Corrected Transferred DC OUTPUT Voltage

$$M = \text{Measured DC OUTPUT} \times \left(\frac{100}{100 - CF} \right)$$

f. Stability of AC-DC Difference Uncertainty. The Ballantine 1605 ATS uses castings to house the low voltage attenuators and extremely stable construction for the high voltage attenuators. All components are carefully chosen for best response and stability so as to maintain accuracy of calibration over long periods of time. More than 14 years of experience with the attenuator construction permits the 1605 to offer 90 day AC-DC difference stability of ± 5 ppm and one year stability of ± 15 ppm in laboratory environments. This very high stability permits corrected AC-DC difference to be within the above limits and provide reliable transfer measurements with state of the art uncertainty for extended periods of time.

g. Absolute Accuracy of the Transfer Measurement. To obtain the most accurate absolute transfer accuracy, the following factors com-

prising all aspects of the error budget must be applied to the DC OUTPUT voltage measured at the ATS:

1a. Machine Error (Dc to DC Transfer Error). This is included in the Error Limits of Table 1-1.

1b. AC-DC (1 kHz) Difference Error with NBS traceable correction factors (Corrected Frequency Response). This is included in the Error Limits of Table 1-1.

2. Stability of AC-DC (1 kHz) Difference (Uncertainty Increase with Time). 90 day stability is included in the Error Limits of Table 1-1.

3. These errors may be added algebraically to provide absolute transfer measurement uncertainty for the ac input signal.

This absolute value applies to the transfer measurement and does not include accuracy of the auxiliary 7 1/2 digit DC DVM or the spectral impurity of the ac input signal. It cannot be presumed that the effects of the latter are negligible since even the the best ac voltage calibrators available have 400 ppm of spectral impurity. It is unlikely that the device under test and the 1605 ATS have identical frequency response and will therefore react similarly to the same ac input. The ATS features true rms frequency response beyond 250 MHz. The ac voltage source may have distortion and noise which is measured by the 1605 but not noticed by an ac voltmeter under test. This ac voltmeter may also be average or peak responding which causes substantial errors when the ac input signal has distortion, noise, and other unwanted out-of-band spectral and energy components. Errors caused by spectral impurity of the ac source may therefore substantially affect the test accuracy. In the most demanding applications, the user may add a low pass or band pass filter in series with the ac source to improve its spectral purity.

3-17. DC VOLTAGE READ OUT EQUIPMENT

3-18. Special attention must be given the dc voltmeter used to read out the transferred dc output voltage from the 1605 ATS. A bus controlled 7 1/2 digit voltmeter with accuracy of better than 0.002% is recommended. Under IEEE-488 GPIB control, this DVM should be triggered from the 1605 READ command. For manual operation of the ATS, it is desirable that the DVM has a 10 second averaging capability. At least 10 readings (>20 preferred) should be averaged over the 10 second interval.

3-19. The 7 1/2 digit read out DVM should be connected to the 1605 ATS DC OUTPUT and COMMON terminals with a low thermal cable which is shielded and which has a twisted pair of signal carrying connectors. The DVM input should be floating (not grounded). The DVM guard terminal must be connected to the 1605 COMMON terminal through the interconnecting cable shield. 7 1/2 digit voltmeters such as the Datron Model 1071,

the Solartron Model 7071 (or equal) are recommended. See Figure 3-3 for equipment interconnection details.

NOTE

Some earth ground return path should always be provided to control common mode signals. Never totally float or short the 1605 DC OUTPUT COMMON to earth ground. A 100 ohm (or 100 ohm to 1 k ohm) resistor tied from 1605 COMMON to case ground must be used to control common mode signals and circulating ground currents.

3-20. The auxiliary equipment listed in Table 3-2 is required to obtain best available accuracies. For reduced accuracies which may suffice for other than the most demanding applications of the ATS, auxiliary equipment with lesser specifications than those listed in Table 3-2 may be substituted.

NOTE

Always use the 16056 Tee or other tee to which your 1605 has been calibrated.

3-21. THEORY OF TRANSFER MEASUREMENTS

3-22. There are a number of different methods of making accurate ac-dc transfer measurements. The methods detailed in this manual are recommended since they have been proven to provide uncertainties to 30 ppm and standard deviations of less than 10 ppm. Additional information about thermal transfer measurements, theory, procedures, absolute certification, etc. may be found in the following references:

- a. Williams, E.S., THE PRACTICAL USES OF AC-DC TRANSFER INSTRUMENTS, NBS Technical Note 1166, (Oct. 1982).
- b. Hermach, F.L. and Williams, E.S., THERMAL CONVERTERS FOR AUDIO-FREQUENCY VOLTAGE MEASUREMENTS OF HIGH ACCURACY, IEEE Trans. Instrum. Meas. Vol. IM-15, p. 260-268, (1966).
- c. Williams, E.S., THERMAL VOLTAGE CONVERTERS AND COMPARATORS FOR VERY ACCURATE AC VOLTAGE MEASUREMENTS, Jour. Res. NBS, Vol. 75C, p.145-154, (1971).
- d. Hermach, F.L., THERMAL CONVERTERS AS AC-DC TRANSFER STANDARDS FOR CURRENT AND VOLTAGE MEASUREMENTS AT AUDIO FREQUENCIES, Journal Research 48, 121 (1952) RF2296.
- e. Hermach, F.L. and Williams, E.S., A WIDE-RANGE VOLT-AMPERE CONVERTER FOR CURRENT AND VOLTAGE MEASUREMENTS, IEEE Transactions, Communications and Electronics, Paper No. 59-161 (1959).
- f. Williams, E.S., CALIBRATION OF VOLT-AMPERE CONVERTERS, National Bureau of Standards Technical Note 188, (1963).

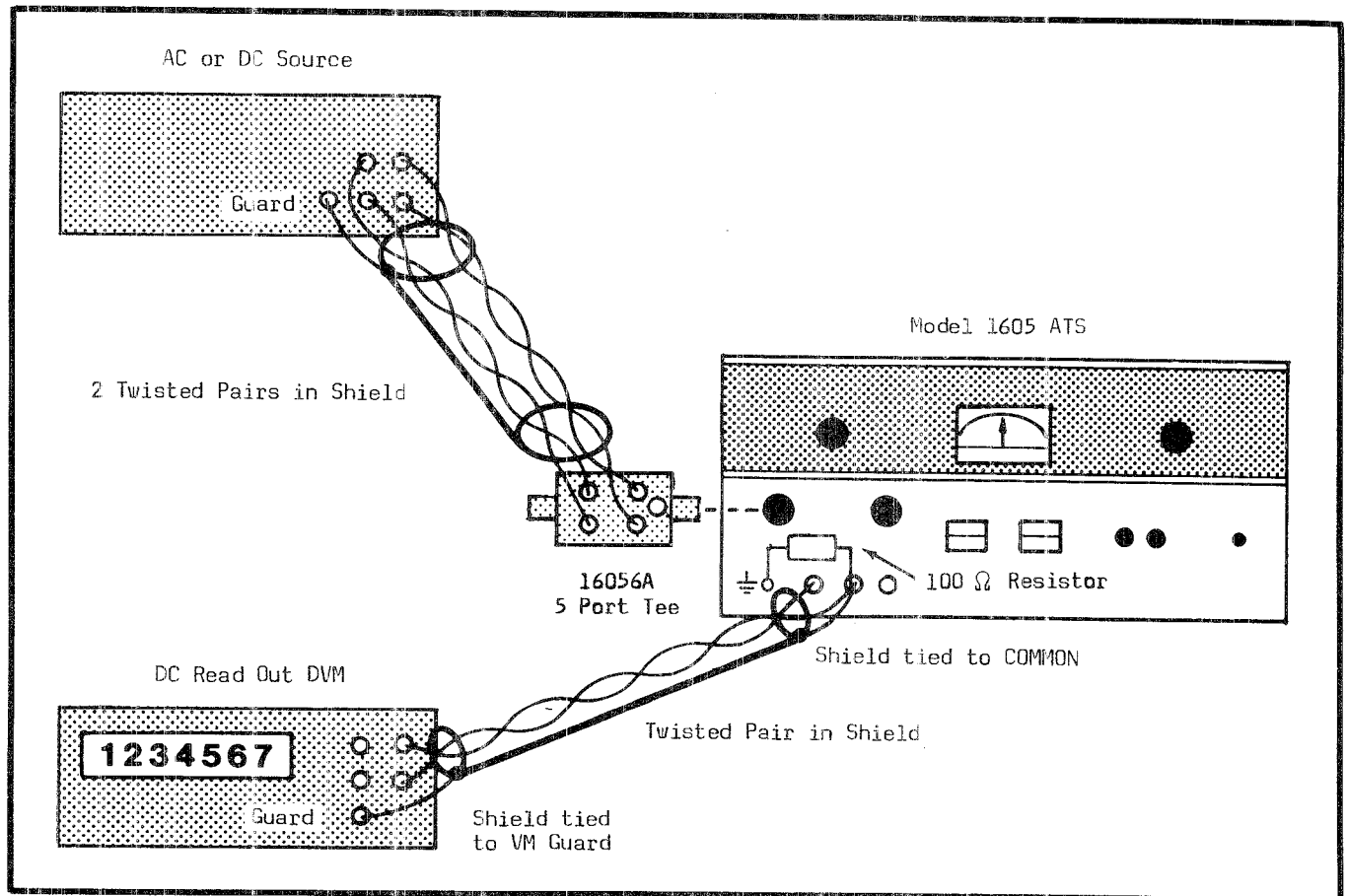

Figure 3-3. Equipment Interconnections DC to 1 MHz

- g. Katzmann, F.L., RECENT IMPROVEMENTS TO AN AUTOMATED PRECISION WIDE-BAND AC-DC TRANSFER STANDARD, IEEE Transactions on Instrumentation and Measurement Vol. IM-36, No. 2, (June 1987)

3--23. PRELIMINARY OPERATION

3--24. PRECAUTIONS

3--25. The high accuracy, stable operation, and low standard deviations can be obtained with the 1605 ATS only if the user is aware of, and understands certain measurement techniques and takes the following into consideration.

3--26. The 1605 is a thermal instrument. It must be temperature stabilized for sufficient time to permit the operating instrument to reach thermal equilibrium. Depending on lab conditions this may require 10 minutes to several hours if minimum measurement uncertainty is to be achieved. Nevertheless, measurements at somewhat increased uncertainty may be made within several minutes after mains power is turned on. All auxiliary equipment should also be fully warmed up and stable before attempting tests aiming for maximum accuracy.

3-27. CONNECTION ERRORS AND LOADING EFFECTS

3-28. Connection errors should be evaluated and minimized when the Transfer Standard is used to calibrate other instruments. These errors can often be detected by changing the length and position of the leads. Short coaxial leads should be used when possible. These errors can be significant at high test frequencies.

NOTE

The HI and LO input connectors of the 1605 are floating. Always connect a 100 ohm to 1000 ohm resistor between case ground and DC OUTPUT COMMON to minimize the effects of ground currents and capacitively coupled common mode voltages.

3-29. Losses in interconnecting wiring may occur since the ATS has an input impedance of approximately 200 ohms/volt. The voltage drop in the wiring interconnecting the voltage source and the ATS may introduce a measurement error, particularly when the low voltage ranges are employed. It is recommended that short heavy leads be employed when interconnecting the

TABLE 3-2. REQUIRED AUXILIARY EQUIPMENT

FUNCTION	SPECIFICATIONS FOR MAX. ACCURACY	APPLICATION	RECOMMENDED INSTRUMENT
DC Readout Voltmeter	Voltage Range 220 mV to 1.1 kV; Accuracy 20 ppm; 7 1/2 digits; IEEE-Bus Talker/Listener Guarded input	Measures transferred DC OUTPUT voltage from 1605 ATS	Solartron Model 7071, Datron Model 1071 or equivalent
DC Voltage Source	Amplitude Stability short term < 5 ppm; Output 0.200 V to 1.1 kV; Output current 5 to 10 mA; Sensed output	Supplies dc voltage to ATS to check machine error for performance verification tests. DC driver for transconductance amplifier current source	Fluke 5442A, Datron 4100 or equivalent
AC Voltage Source	Amplitude stability short term < 10 ppm; Output voltage 200 mV to 1.1 kV; Frequency 10 Hz to 1 MHz and to 100 MHz as required; Sensed to 100 kHz; Output current > 15 mA; High Spectral Purity > -70 dB	Supplies stable ac voltage for setting up calibrated ac voltage and measures frequency response of ac voltage amplifiers and ac voltmeters. AC driver for transconductance amplifier current source.	Several instruments will be required to cover the voltage and frequency range. 10 Hz to 1 MHz - Ballantine 6400A, Datron 4200, or Fluke 5200A/5215A. To 100 MHz - Ballantine 6190A or Tektronix SG503 with tuned power amplifier. HP Model 230 A or untuned power amplifier ENI Model 411LA.
AC/DC Current Source Transconductance Amplifier	Amplitude stability short term < 50 ppm; Output current 20 mA to 100A; Output Voltage 4 V \pm (dc + ac rms); Frequency DC, 10 Hz to 10 kHz or or higher depending on application	Current source to provide calibrated ac or dc current for measuring frequency response and accuracy of current shunts and current measuring devices	Ballantine 1620A-04-60. Use with ac or dc voltage source. For currents of 10 mA or less, and at frequencies from 10 kHz to 100 kHz use the ac voltage source. Use Ballantine 1621A for ac current applications to 100 kHz.
Current Shunts AC and DC	Range 20 μ A to 100 A Accuracy DC \pm 0.01% AC to 1 kHz: 0.25%	Shunt resistors to make ac and dc current measurements. Use active shunt for low (and high) current measurements	Ballantine 1625A Active Shunt; 20 μ A to 100 A, dc to 10 kHz. Fluke A40 shunts; 2.5 mA to 20 A to 100 kHz

equipment. For measurements to 100 kHz always use the 16051A 4 Port Tee with sensed output signals from the ac or dc source to assure accuracy and stability. Use the 16052A 3 Port Tee with ac sources that do not provide sensed outputs and for all measurements above 1 MHz. The Model 16056A 5 Port Tee may be used for the entire dc to 100 MHz frequency range. Use the 4 banana jack sensed ports for lower frequencies and the BNC input for all frequencies. Always use the tee connector which is calibrated to your 1605 (check serial number on tee and its listing on the 1605 rear

panel). See Figure 3-3 and 3-4.

NOTE

The voltage accuracy is specified at the center of a tee connected directly to the LO INPUT or HI INPUT connectors of the 1605 ATS. Always use the Model 16051A Four Port Tee with sensed input connections when making precision measurements at frequencies < 1 MHz.

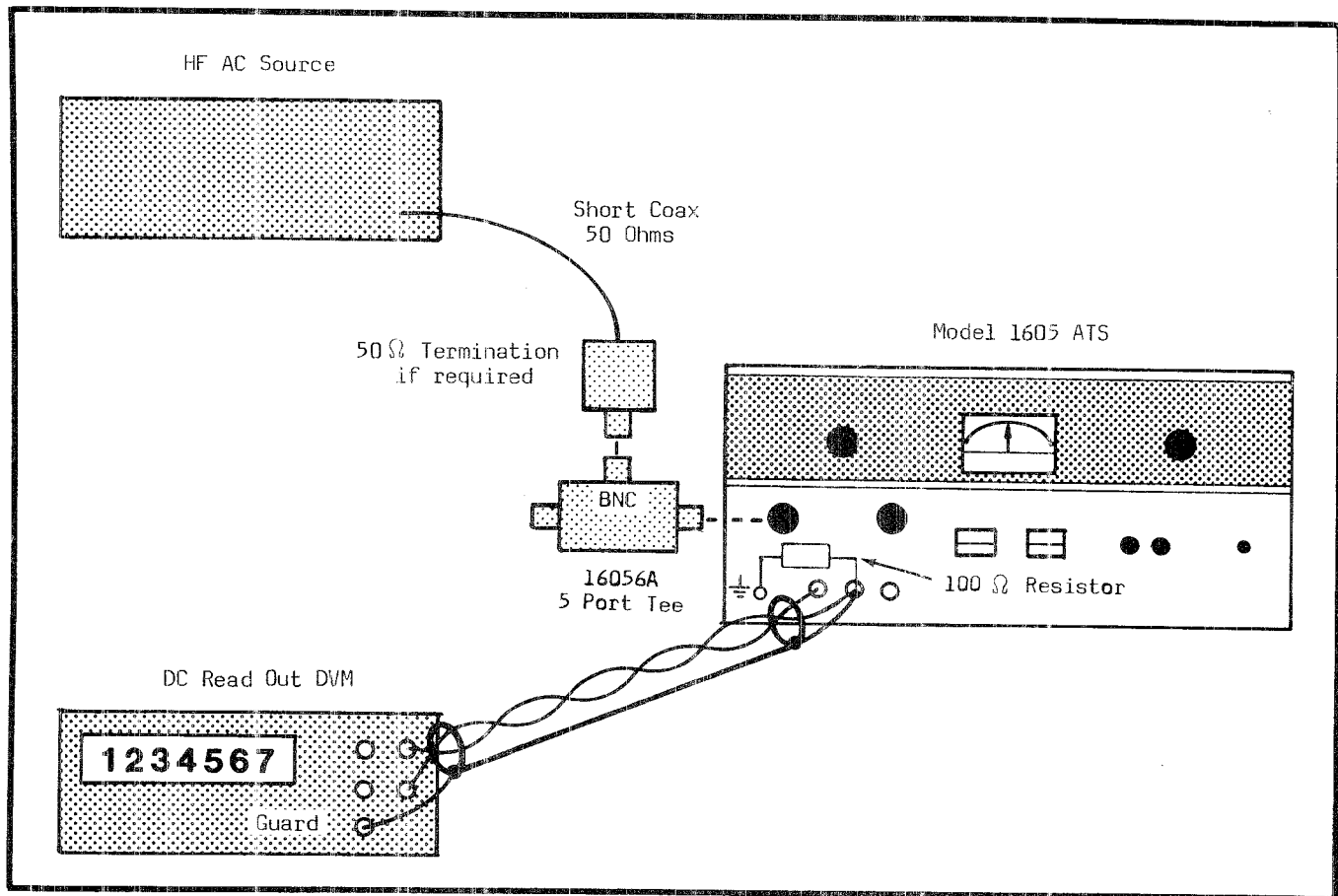

Figure 3-4. Equipment Interconnections > 1 MHz

3-30. Loading effects due to the 200 ohm/volt input impedance of the ATS must be considered. This is particularly so on the low voltage ranges. Due to the current required for the thermoelement heater and the shunt input capacitance presented by the relay controlled range attenuator, the ATS will load the source. Voltage sources having a non-zero output impedance and/or poor regulation characteristics will therefore develop two different output levels: one while the ATS is in the ac input state (loading the source) and a second when the ATS is in the dc output state (voltage source removed from ATS input attenuator). The output voltage of the ATS, as indicated on the dc readout DVM, will be the voltage of the loaded source.

3-31. Attenuator heating effects may be observed when measuring voltages between 250 and 1000 volts since the power dissipated by the input attenuators may produce a slight change in resistance. It may be desirable that the MANUAL TRANSFER mode be employed when measuring such voltages and that transfer be made after the signal under measurement has been applied for approximately two minutes (thereby allowing the input attenuator resistors to stabilize).

3-32. Thermal emfs in dc output system. Non-similar conductors employed to couple the DC OUTPUT binding posts to the readout instrument will introduce thermal emfs. It is recommended

that shielded and twisted conductors of the same material (copper) be employed to avoid thermals and magnetic or RF interference effects.

3-33. OPERATING HINTS

3-34. Setting the RANGE switch. If the voltage range of the applied signal is known, the operator need only set the RANGE switch to the appropriate position and couple the voltage to be measured to either the LO INPUT 0.25 ▶ 32V or HI INPUT 32 ▶ 1 kV connector, as required. Should the signal be of unknown level, employ the conventional voltmeter technique of setting the RANGE switch to the highest voltage range (500 ▶ 1 kV) and couple the signal to be measured to the HI INPUT 32 ▶ 1 kV connector. If balance cannot be achieved, the operator should increase the sensitivity of the ATS, switching input connectors when required, until a balance is achieved. Range may be set over the bus for remote and systems operation. Always transfer the dc readout DVM in conjunction with the input connection.

WARNING

A substantial personnel shock hazard can occur if the operator inadvertently contacts the DC OUTPUT 32 to 1 kV binding post when the OUTPUT indicator and any of the red LED RANGE indicator lamps are illuminated.

3-35. Mode Selection. The ATS has five modes of operation, each selected by the setting of the front panel switch or remotely over the bus. When the ATS is set to MANUAL BALANCE, the operator manually adjusts the MANUAL BALANCE COARSE and/or FINE controls until a null (0 on the meter BAL scale) is attained. After transfer, the voltage at the DC OUTPUT binding posts will be equal to the rms value of the applied ac signal. While this semi-automatic mode of operation is slightly more time consuming, it is substantially faster than conventional AC-DC transfer standard measurements since the 1605 DC OUTPUT is automatically servoed to its final "transfer" value.

When the ATS mode is set to any of the three AUTO modes or to the MANUAL TRANSFER mode, the ATS balances automatically. In the AUTO mode, INPUT to OUTPUT transfer is performed automatically, while in the MANUAL TRANSFER mode the INPUT to OUTPUT transfer point is determined by the operator. MANUAL TRANSFER mode is used for moderately unstable input signals.

Selection of the three AUTO modes depends on the stability of the input signal to be measured. The AUTO NORM mode is suitable for stable INPUT signals drifting less than 20 ppm in 5 seconds. AUTO FAST mode is suitable for input signals drifting less than 40 ppm in 5 seconds. The AUTO HI ACCUR mode is reserved for the most stable of input signals which change less than 10 ppm in 10 seconds. It is the mode to be used when ATS measuring uncertainties of 20 ppm are expected with smallest standard deviation.

NOTE

The 1605 always reverts to STANDBY state whenever RANGE or MODE selection is changed.

3-36. Input Signal Stability. The ATS is designed to measure the rms value of stable ac voltages. Should the INPUT indicator light remain illuminated and/or the NULL BALANCE Meter continuously "hunt" or "slew" when the ATS is operated in either the AUTOMATIC or MANUAL TRANSFER modes, it is likely that the input signal is unstable. To judge the stability of the applied signal, the operator should switch to the MANUAL BALANCE mode and attempt to null the meter using the MANUAL BALANCE COARSE and/or FINE controls. If a balance condition cannot be maintained, the applied signal is fluctuating too rapidly to permit a measurement of specified accuracy to be made. Under these conditions the measurement should be made in the MANUAL TRANSFER mode and the reduced accuracy due to the fluctuation and drift of the signal should be noted.

3-37. DC Reversal Error. The 1605 ATS incorporates a Ballantine developed multi junction thermal element and an electronic reversal error correction circuit. The dc reversal error effects are normally less than 10 ppm. The reversal error is included in the dc to dc transfer error budget. Unlike older and more difficult to use instruments, dc reversal error need not be further considered even though only a single, rapid, unipolar ac to dc transfer is required for high accuracy measurements with the 1605.

3-38. OVERVOLTAGE PROTECTION

3-39. A unique rate of change sensing double differentiated over voltage protection circuit is incorporated in the 1605 ATS. This circuit will anticipate the probability of overheating the sensitive thermal element and disconnect the input signal in approximately one millisecond. Full protection against burn out and reversal error change of the thermal element is achieved to rms levels of 10 times the full scale value of the RANGE selected. LO INPUT is limited to 300 Volts and HI INPUT to 1100 Volts rms sinusoidal or 1550 Volts peak.

3-40. The overvoltage protection circuit derives its signal from the output of the thermal element. It is not connected to the input signal and therefore does not affect accuracy at any input amplitude level or input frequency.

3-41. It should be stressed that the overload protection circuitry is not intended to serve as a range finder and that continuous overloading of the ATS may result in the eventual degradation of the thermoelement. The thermoelement is not covered by the warranty.

3-42. Standby. The STANDBY mode is provided to eliminate the possibility of damaging the thermoelement when changing input cables or switching signal levels. The STANDBY switch is provided to disconnect the input signal from the attenuator and the thermal element. STANDBY is activated by depressing the momentary pushbutton switch on the front panel. STANDBY mode also assures operator safety by shutting off the DC OUTPUT voltage.

NOTE

The ATS may be manually set to the safe STANDBY mode at any time in the INPUT or OUTPUT state except when the 1605 is in REMOTE. If local lockout is not invoked over the bus, then the operator may push the LOCAL momentary pushbutton switch and the 1605 will automatically revert to STANDBY.

3-43. INITIALIZING THE ATS

3-44. To initialize the ATS for LOCAL operation proceed as follows:

a. Remove all input cables. Set RANGE switch to 1 kV.

b. Connect the ac mains power cable to the same branch circuit used to power the dc read-out voltmeter and auxiliary equipment.

c. Turn power toggle switch to ON. Note that the green LED power indicator lamp is illuminated.

d. Push LOCAL momentary pushbutton. Note that all indicator lamps for RANGE and MODE correspond to the setting of the switches and that the STANDBY and INPUT lamps are illuminated.

e. The ATS can now be connected to the required auxiliary equipment to make measurements in the manner indicated below.

NOTE

Always be certain that the common mode voltage applied to the 1605 INPUT terminals be less than 25 volts \pm (dc + ac peak). The input signal LO should be grounded whenever possible. The ground should be a short heavy gauge copper strap tied between the 1605 COMMON and case (earth ground) binding posts. If all the instruments connected to the ac input and dc output connectors are not guarded then the operator should test for the presence of ground currents which may cause small circulating ac mains currents in the connecting cables and ground connections. To minimize these ground current errors, replace the above ground wire with a resistor to limit the current flow. A resistor in the range of 5 ohms to 100 ohms is usually adequate. When ground currents are induced by an RF transmitter or other source having high high frequency content it may be necessary to shunt the grounding resistor with a suitable capacitor. Always make certain that common mode voltages are kept to an absolute minimum to obtain the specified transfer measurement accuracy of the 1605.

3-45. MEASURING AN UNKNOWN AC VOLTAGE

a. Determine the frequency of the ac voltage to be measured. If the frequency is below 1 MHz and is derived from a sensed source, use the Model 16051A Four Port Tee Connector and connect the test set-up of Figure 3-3. When the frequency of the input signal to be measured is above 1 MHz, use the Model 16052A Tee Connector and connect the test set-up of Figure 3-4. Observe all the initializing instructions of paragraph 3-43. If the unknown input voltage is known to be below 32V rms, use the LO INPUT. If it is unknown or above 32V rms, use the HI INPUT connector and connect the auxiliary dc voltmeter to the corresponding DC OUTPUT connectors.

b. Set the 1605 controls as follows:

LOCAL/REMOTE	LOCAL
RANGE	1 kV (or 32V)
MODE	AUTO NORM
INPUT/OUTPUT	INPUT
STANDBY/OPERATE	STANDBY

c. Set the auxiliary dc digital voltmeter to: DC input, Filter In, Autorange, 7 1/2 digit display, Triggered operation.

If the dc voltmeter is so equipped, it should be triggered to read by using the IEEE-488 bus command sent by the 1605.

Set the voltmeter or the bus controller to average the readings over a period of 10 seconds immediately following the READ command. If the voltmeter is manually triggered by the operator, this must be done immediately upon illumination of the 1605 READ LED indicator.

NOTE

To obtain specified transfer measurement accuracy, at least 10 readings must be averaged within the 10 second interval following the READ command. Failure to make the DC OUTPUT measurement in this manner will result in substantial errors due to the minor variations in the DC OUTPUT signal caused by noise and continual correction of the servoed dc output voltage circuitry. Measure the DC OUTPUT voltage only during the 10 to 15 second period when the 1605 READ indicator is illuminated to prevent errors caused by thermal drifts.

d. Turn on the ac signal source to be measured and allow it to warm up and stabilize.

e. Set the 1605 to OPERATE. Note that the NULL BALANCE meter will move toward balance within a few seconds if the input voltage is in range. Observe that the UNDERRANGE indicator lights when the input voltage is lower than the selected range.

f. Note that an input voltage which is too high for the range selected will trip the 1605 into STANDBY unless the overvoltage is very slight (+ 10%) which is indicated by the OVERRANGE lamp.

CAUTION

Never apply an input voltage greater than 10 times the selected full scale RANGE or greater than the maximum applied input voltages listed in Table 1-1. Failure to observe this precaution may damage your transfer standard and void the warranty.

WARNING

NEVER USE THE OVERVOLTAGE PROTECTION CIRCUITS AS A RANGE FINDER.

g. Should the 1605 trip to STANDBY, re-connect to the HI INPUT and DC OUTPUT connectors. Set RANGE to 1 kV.

h. When the transfer standard remains in the OPERATE mode with the ac input signal applied, the operator must switch RANGE until the UNDERRANGE lamp is extinguished and the meter balances to NULL. Always wait several seconds before switching to the next lower range. Reset to OPERATE whenever the RANGE is changed since the 1605 safety system sets STANDBY when changing RANGE or MODE.

i. Observe that the NULL meter balance is stable. The 1605 should trip to the OUTPUT state in 10 to 20 seconds after NULL balance is indicated by the meter.

j. If the meter shows continuing efforts to balance, then the input signal amplitude may not be sufficiently stable for the AUTO NORM mode. Set to the AUTO FAST mode if this instability is observed.

k. If transfer to the OUTPUT state will not occur in AUTO FAST mode then select MANUAL TRANSFER mode. Note the best balance on the NULL meter and manually transfer from INPUT to OUTPUT state by pushing the INPUT/OUTPUT switch.

NOTE

The operator determines the exact measurement point on a drifting input signal when using the MANUAL TRANSFER mode. Measurement accuracy is thereby fully dependent on the operator's judgement.

l. Note that the READ LED indicator on the 1605 lights some 10 or more seconds after the transfer from INPUT to OUTPUT state. Start the 10 second average of DC OUTPUT measurements on the auxiliary dc voltmeter no more than one second after the READ LED lights.

m. The reading on the auxiliary dc voltmeter indicating the average over a 10 second measuring period is the transferred value representing a true rms measurement of the ac input signal rms amplitude.

n. Since the frequency and amplitude are known, the correction factors may be applied to the measured dc output. A positive correction factor will mean that the measured dc output is low and must be increased by correction and vice versa. Apply the following correction formula to obtain an absolute measured value for the applied ac input signal:

$$EA = E_m \times \frac{100}{100 - CF}$$

Where

EA is the absolute measured value

E_m is the measured dc reading

CF is the correction factor in % as determined by NBS traceable calibration of the 1605

3-46. CALIBRATING A STABLE AC VOLTAGE SOURCE

a. When calibrating the output amplitude of an AC Voltage Calibrator or other stable ac voltage source, a precisely known absolute reference is required. The 1605 may be used to generate such an absolute voltage by operating in the reverse MANUAL BALANCE mode. The auxiliary dc voltmeter then becomes the basic reference and the NULL meter indicates deviation of the AC INPUT signal from the reference set during the DC OUTPUT state.

b. The reverse MANUAL BALANCE mode is a semi-automatic mode which provides the same uncertainties specified for the normal ac to dc transfer modes. It will be necessary to periodically check the dc OUTPUT state reference setting to correct for thermal drifts. A reference setting verification should normally be made at 1 to 3 minute intervals depending on the desired measurement uncertainty. This is convenient since the auxiliary dc voltmeter is always on-line and monitoring the reference setting. All equipment should be fully warmed up and thermally stabilized when using the reverse MANUAL BALANCE mode.

c. When calibrating a stable ac source connect the test set up of Figure 3-3 if the ac source is sensed and in the frequency range to 1 MHz. Use Figure 3-4 if the ac source frequency is above 1 MHz. The ac source which is to be calibrated is considered the unit under test (UUT).

d. Set the 1605 controls as follows:

LOCAL/REMOTE	LOCAL
RANGE	Set RANGE to correspond to the UUT output amplitude
MODE	MANUAL BALANCE
INPUT/OUTPUT	OUTPUT
STANDBY/OPERATE	STANDBY (hookup) OPERATE (measuring)

e. Set the auxiliary dc digital voltmeter to: DC Input; Filter In; Autorange; 7-1/2 digit display; and continuously displaying a 10 second average.

NOTE

To obtain specified transfer measurement accuracy, at least 10 readings must be averaged within the 10 second interval following the READ command. Failure to make the DC OUTPUT measurement in this manner will result in substantial errors due to the minor variations in the DC OUTPUT signal caused by noise and continual correction of the servoed dc output voltage circuitry.

f. Decide on and set the UUT to the amplitude and frequency to be used for the desired UUT calibration set point. For optimum absolute precision the corresponding correction factor may

be applied to the amplitude setting of the 1605 as displayed on the auxiliary dc voltmeter. A positive correction means that the displayed dc output voltage must be increased and vice versa. Apply the following correction formula to modify the voltage displayed on the auxiliary dc voltmeter.

$$EA = ED \times \frac{100}{100 - CF}$$

EA is the absolute displayed value
 ED is the voltage set point for the UUT
 CF is the correction factor in % as determined by NBS traceable calibration of the 1605

g. Once the absolute displayed reading of the auxiliary dc voltmeter has for the desired set point been computed, set the 1605 to OPERATE. Then adjust the COARSE BAL and FINE BAL controls until the auxiliary dc voltmeter displays the computed voltage. Allow some warmup time until the system is fully stabilized to this setting.

h. Switch INPUT/OUTPUT to INPUT and adjust the internal calibration adjustment control of the UUT until the 1605 NULL meter indicates BALANCE. If some time has elapsed the reference setting may have drifted. To verify the reference setting reset to OUTPUT state and note that the auxiliary dc voltmeter remains at the reading computed in step f within the required uncertainty.

i. Ballantine makes available ATE software to automate the calibration of AC Voltage Calibrators. The COMPUTEST 40601 software using an IBM PS/2130 provides fast and precise closed loop verification with minimum operator interaction.

3-47. ENHANCING ACCURACY OF A STABLE AC VOLTAGE CALIBRATOR

a. AC Voltage Calibrators are used to test the response of ac voltmeters, amplifiers, and other filters. The best accuracy of currently available ac voltage calibrators is in the 100 to 400 ppm range. This ac amplitude accuracy is not sufficient to calibrate ac voltmeters which have accuracies to 60 ppm. In fact, these high accuracy ac voltmeters are intended to enhance the accuracy of ac voltage calibrators. Your 1605 may be used to further enhance the accuracy of any ac voltage calibrator by providing NBS traceable uncertainties to 20 ppm.

b. The 1605 ATS may therefore optimally enhance the accuracy of any ac voltage calibrator providing the calibrator has sufficient resolution and is stable within a few ppm over the period of measurement.

c. See Figure 3-5 and 3-6 for the test set-up. Always use the shortest and lowest capacitance interconnections between the tee and the ac voltmeter, filter, or amplifier under test. Connect the ac voltmeter guard to the ac input LO.

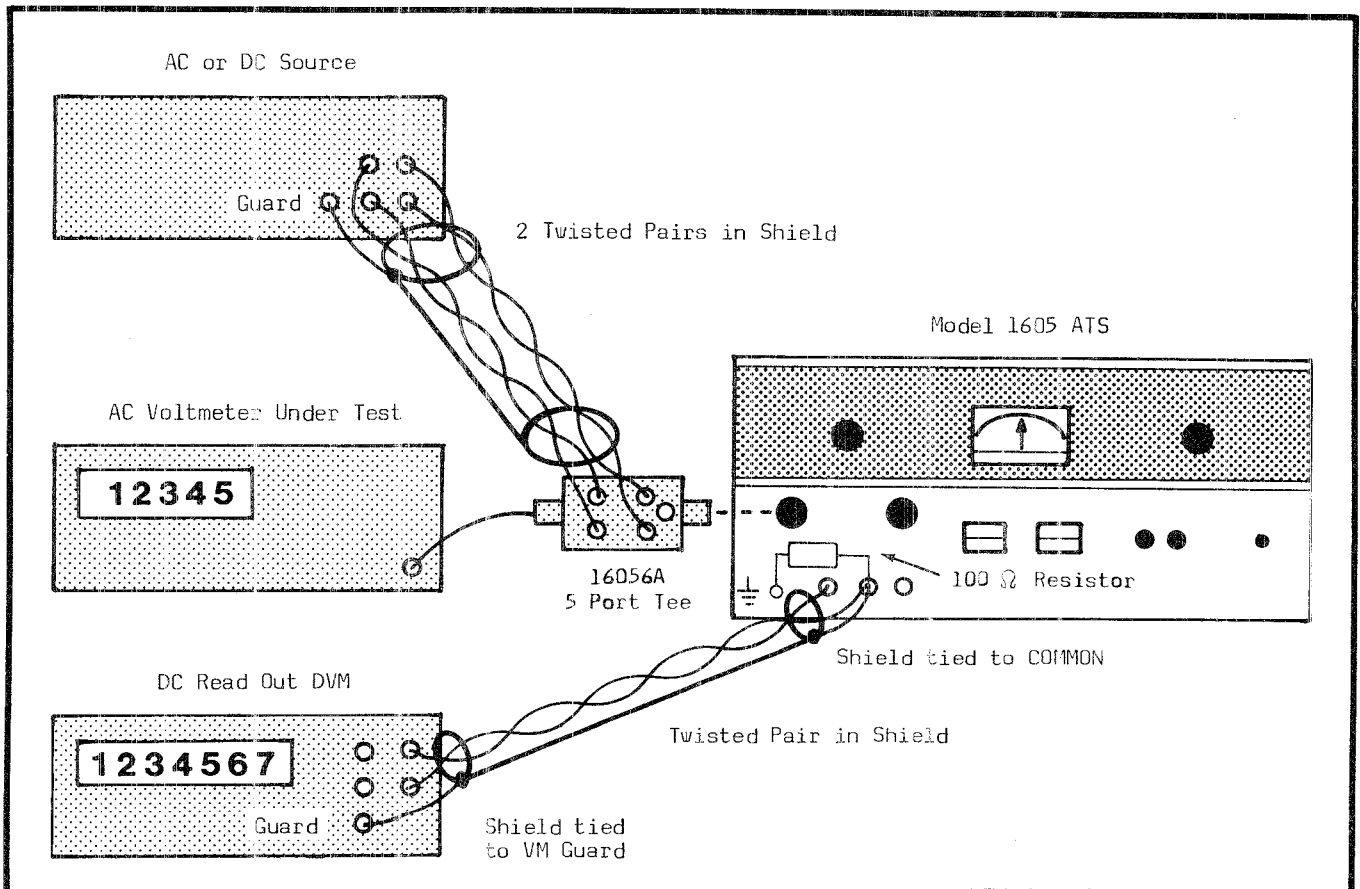

Figure 3-5. AC Calibrator Accuracy Enhancement Test Set-Up

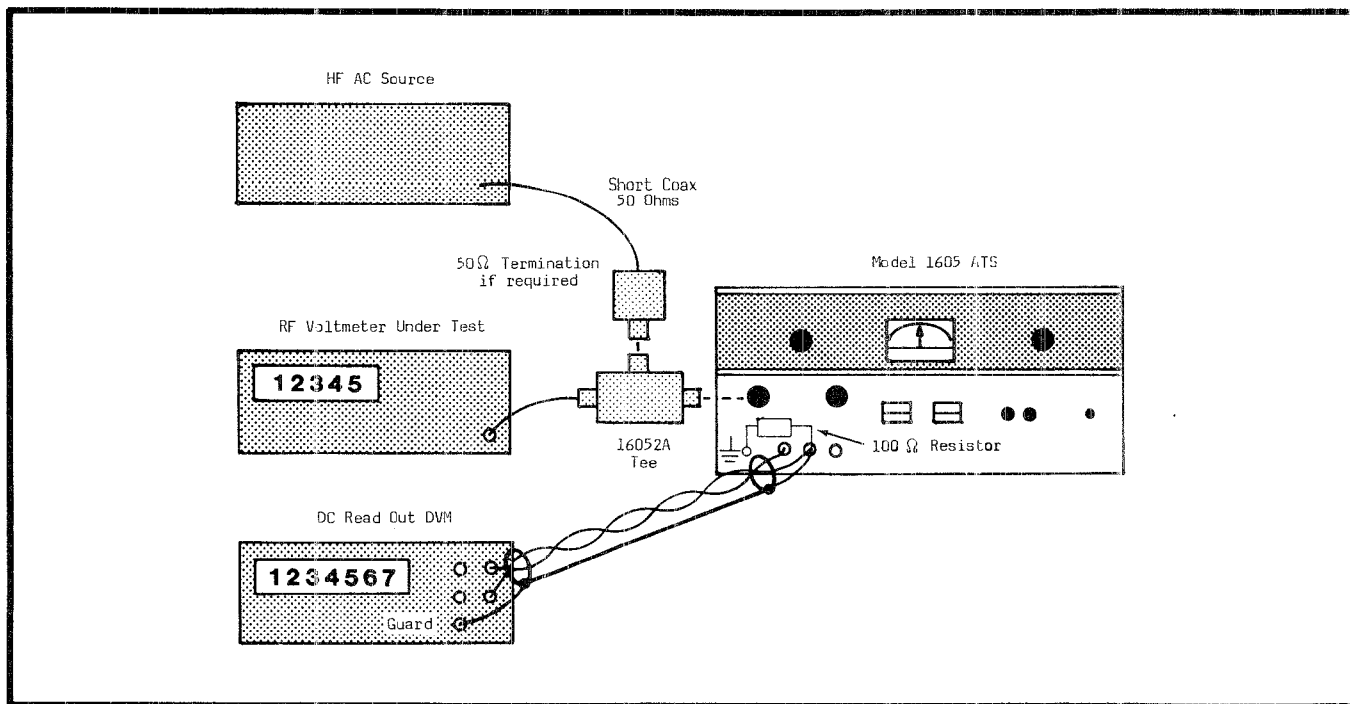

Figure 3-6. AC Voltage Source Accuracy Enhancement > 1 MHz

d. For optimum accuracy the spectral purity of the ac voltage calibrator must be considered. If the unwanted energy consisting of noise spurious or harmonic components exceeds the uncertainty of the desired measurement, then an appropriate low pass filter must be inserted between the ac voltage source and the input of the tee connector. This filter should attenuate all frequency components beginning at a frequency just above the fundamental frequency and provide attenuation of at least 6 dB per octave well beyond 300 MHz. The 1605 is wide band true rms responding and the filter assures that the 1605 measures only the signal content to which the voltmeter under test is responding.

e. To make transfer measurements which enhance the amplitude accuracy of an ac voltage calibration proceed as indicated in paragraph 3-45. There is no need to search for the correct RANGE setting since the

f. Ballantine provides ATE software systems which calibrate ac voltmeters with NBS traceable accessories enhancing ac voltage calibrators with the 1605 ATS. The COMPUTEST 4052 family of software using the IBM PS/2130 with color monitor display permit fast and precise closed loop and open loop certification of precision ac voltmeters with minimum operator interaction. The 4052 uses the 1605 as an enhancement voltmeter for any stable ac source to provide 20 ppm ac uncertainty.

3-48. VERIFYING THE ACCURACY OF AN AC VOLTMETER

a. To calibrate or verify the accuracy of an ac voltmeter with the 1605 ATS follow the procedure for enhancing the accuracy of an ac voltage calibrator outlined in paragraph 3-47.

b. Compare the reading of the ac voltmeter against the applied ac input signal as measured by the ATS and the auxiliary dc voltmeter. Compare this difference against the error budget specification of the ac voltmeter to establish pass or fail conditions at the various amplitudes and frequency points for the individual ranges of the ac voltmeter under test.

c. Contact Ballantine for information on available COMPUTEST software using the IBM pc to perform closed loop enhanced accuracy verification of the ac voltmeter under test.

3-49. CALIBRATING AN AC VOLTMETER

a. To make calibration adjustments on an ac voltmeter, establish an amplitude and frequency point using the Enhanced Accuracy of an AC Voltage Source procedure outlined in paragraph 3-47. If a precise amplitude point is required use the procedure of paragraph 3-46 entitled Calibrating a Stable AC Voltage Source. Use the test set-up of Figure 3-5 for frequencies to 1 MHz and Figure 3-6 for frequencies above 1 MHz.

b. Once the amplitude is read on the auxiliary dc voltmeter and correction factors are applied, then set the ac voltmeter calibration adjustment controls to make the ac voltmeter under test display the same reading as the auxiliary dc voltmeter.

c. The above procedure may also be used for ac voltmeters whose calibration is adjusted digitally from their front panel (AUTOCAL). Digital calibration using the 1605 ATS to precisely set the amplitude may also be performed over the IEEE-488 bus.

3-50. CURRENT CALIBRATION AND MEASUREMENT

3-51. General

3-52. The 1605 ATS will measure current directly in the 0.25 to .5 Volt RANGE. This range provides direct access to the thermal element at a nominal impedance of 100 ohms. Relative current measurements may be made with accuracies to 30 ppm over the specified range of the 1605.

NOTE

When using the 1605 for current measurements be certain the common mode voltage does not exceed 25 volts \pm (dc + ac peak). Always connect the outside shell of the 1605 input connector to the lowest common mode signal in the measurement test set up.

3-53. The overload protection of the 1605 is fully operative when measuring current as described in paragraph 3-52.

3-54. Current shunts are available to measure currents which are greater than the 5 mA capability of the 1605. These passive resistive shunts are resistors with established ac/dc difference. These shunts carry the current to be measured less a current of 2.5 to 5 mA which flows through the 1605 thermal element. Current from 2.5 mA to more than 20 amperes may be measured in this manner. The Ballantine Model 600 Series of AC/DC Shunts and the John Fluke Manufacturing Company Model A40 and A40A Series are representative of these ac/dc passive current shunts. Frequency capability extends from dc to 100 kHz although the high crest factor true rms measuring capability will reproduce harmonics and other wide band current components to 100 MHz. The required compliance voltage of passive shunts must be in the range of 250 to 500 millivolts. This suggests a 10 watt power rating for the 20 ampere shunt with consequent heating and thermal instability which substantially adds to measurement uncertainty.

3-55. Ballantine provides the Model 110055A input adapter to permit current measurements using binding post and UHF input connections.

3-56. The ac/dc frequency response certification of shunt resistors is available from the National Bureau of Standards as well as from Ballantine. Passive shunts require known connector and cable reactance. Always send the cables and all adapters with the resistive current shunts when NBS traceable certification of ac/dc difference is required.

3-57. Passive shunts which bypass the current to be measured from the 1605 are common use and required for high frequency current measurements. These shunts have limitations:

a. High compliance voltage of 250 to 500 mV.

b. High power dissipation and consequent thermal instability for higher current shunts.

c. Dependence on connecting cables and connectors to minimize uncertainty.

d. Applicable only to a 2:1 input current measuring range.

e. Not usable for currents below 2.5 milliamperes.

3-58. The limitations of passive shunts for ac/dc transfer measurements may be overcome by using active shunts such as the Ballantine Model 1625A. An active shunt employs resistors with excellent ac/dc difference and a precision amplifier to sense the voltage across the shunt resistor. Shunt resistors in active shunts generally operate with low compliance voltage with 100 mV being typical. These units may be used with 10 to 1 (decade) ranging capability instead of the 2 to 1 (octave) range of resistive shunts. The amplifier in the Model 1625 active shunt has a gain of precisely ten over a bandwidth of 10 kHz (-3 dB at approximately 100 kHz). The amplifier presents minimal loading to the shunt resistors and therefore does not divert current from the shunt. Output sensing from the precision amplifier overcomes the interconnection uncertainty of the passive shunts. The Model 1625 Active Shunt includes battery power for off-line power operation and minimum noise contribution. See Figure 3-7 for a photograph of the Model 1625 Active Shunt. Advantages of using an active shunt for current transfer measurements include:

a. Ability to measure currents below 2.5 mA.

b. Low shunt power dissipation and optimum thermal stability with fast settling time.

c. Lowest compliance voltage.

d. Decade current range capability.

e. Accuracy independent of output cables and connectors.

f. Independent of transfer standard thermocouple and input resistance.

g. NBS traceable certification may be performed on the active shunt using any transfer standard.

3-59. MEASURING AN UNKNOWN CURRENT USING AN ACTIVE SHUNT

a. Connect the test set-up of Figure 3-8. Be certain that the active shunt has NBS traceable certification of ac/dc difference.

b. Select the current shunt range on the active shunt which carries the rms current to be measured.

c. Set the active shunt to operate on batteries for minimum noise contribution. Connect the active shunt sensed output cable to the LO INPUT of the 1605.

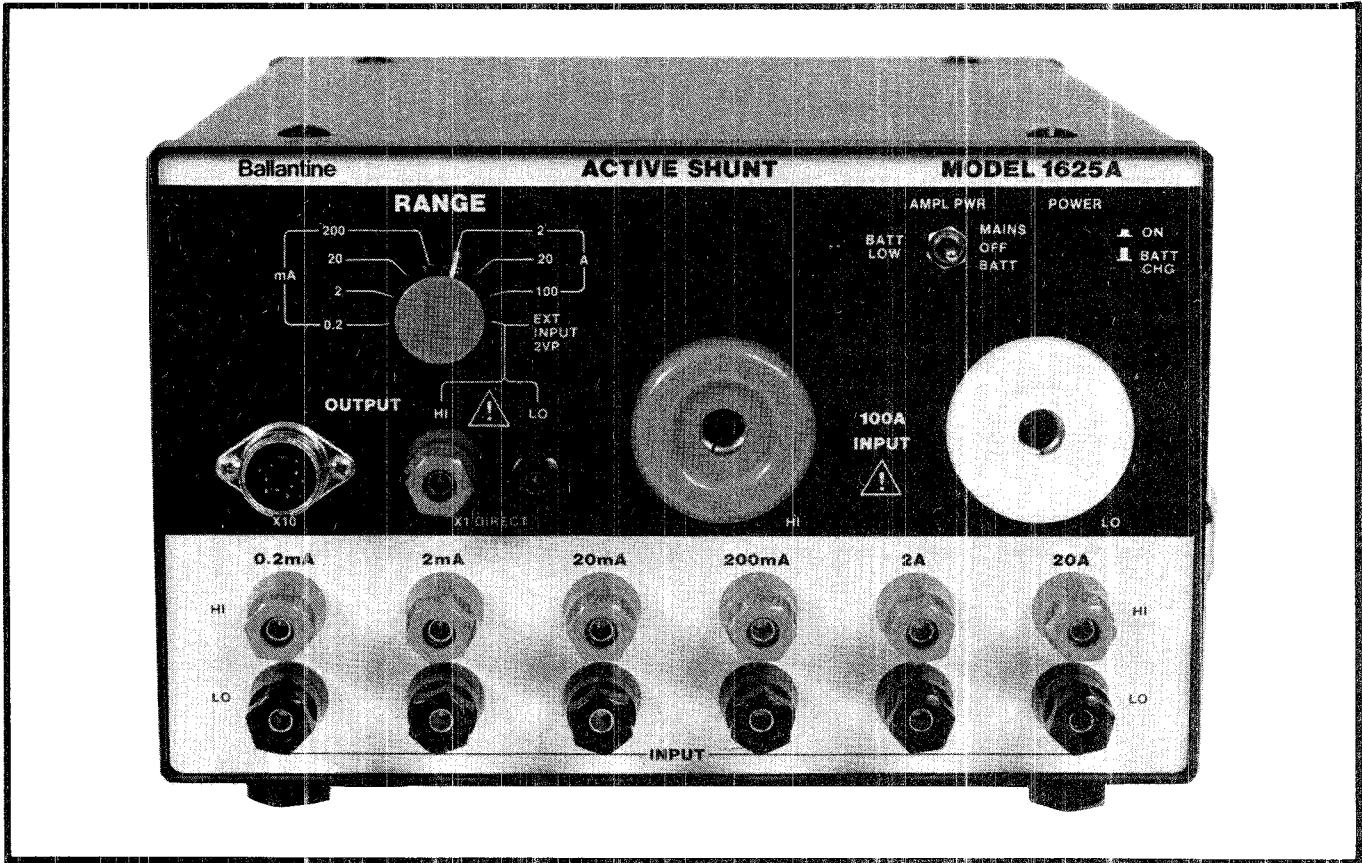

Figure 3-7. Model 1625 Active Shunt

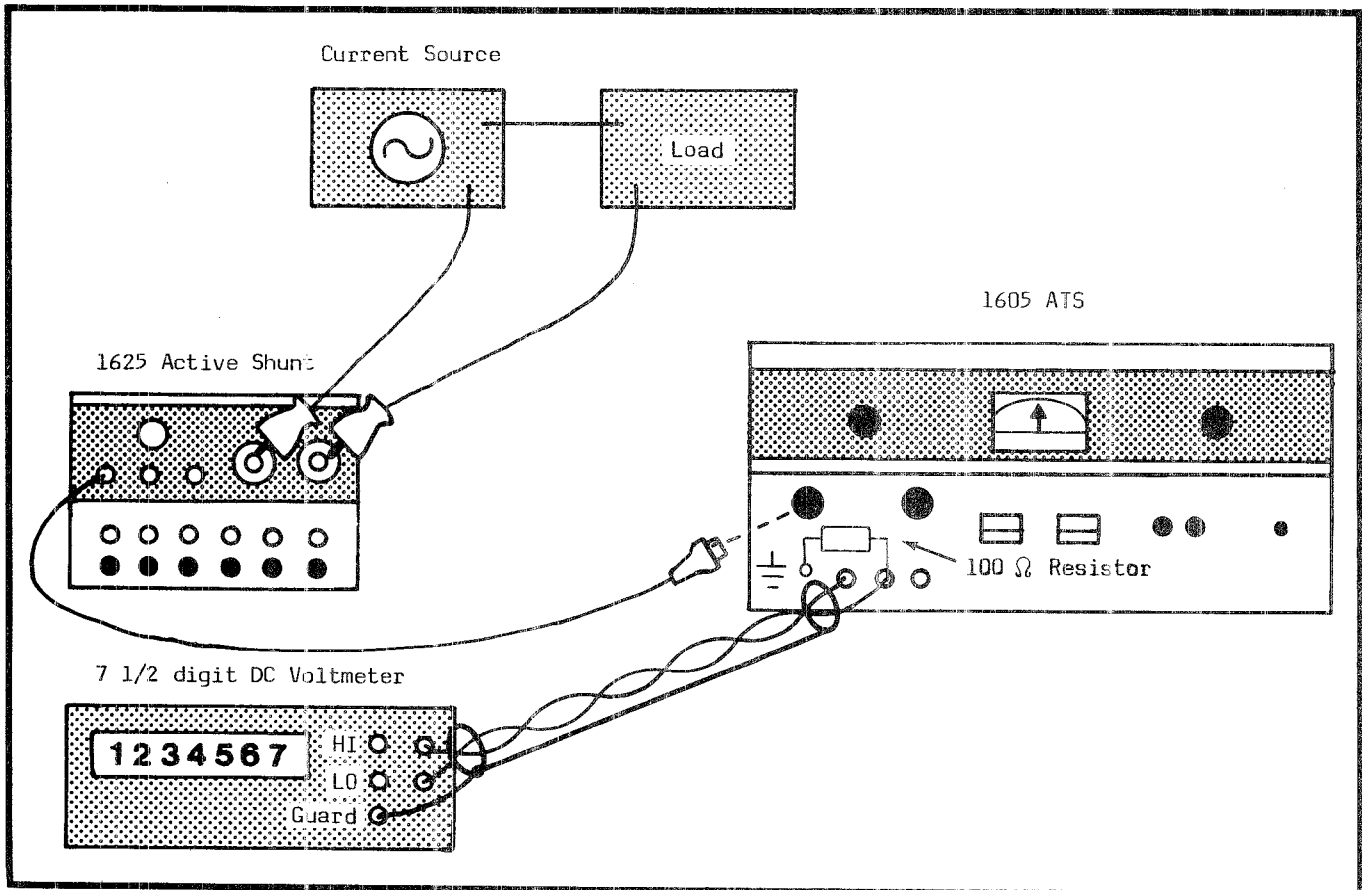

Figure 3-8. Measuring Current Using Model 1625 Active Shunt

d. Set the 1605 controls as follows:

LOCAL/REMOTE	LOCAL
OPERATE/STANDBY	STANDBY
RANGE	1 ► 2 Volts
MODE	AUTO NORM
INPUT/OUTPUT	INPUT

e. Turn on the current to be measured and set the 1605 to OPERATE. Observe the NULL meter on the 1605 to see that it reaches BAL after a few seconds waiting. If the NULL meter does not balance and the underrange indicator lights, there is insufficient input signal amplitude.

f. Change the 1605 to the 0.5 ► 1 Volt RANGE. Reset to OPERATE and observe that the UNDERRANGE indicator is not lit and the NULL meter balances. Should use of the 0.5 to 1 Volt RANGE still indicate UNDERRANGE, then select the 0.25 to 0.5 Volt RANGE and set to OPERATE. The 1605 will balance on one of the three most sensitive ranges or recheck the test set-up.

g. The DC OUTPUT Voltage measured on the auxiliary output voltmeter relates to the current being measured by a multiplier provided by the active shunt range setting. Multiply the dc output voltage as follows when using the Ballantine Model 1625 Active Shunt to obtain the value of the current being measured.

<u>SHUNT RANGE</u>	<u>MULTIPLIER</u>
100 A	x100 in Amperes
20 A	x 10 in Amperes
2 A	x 1 in Amperes
200 mA	x100 in milliamperes
20 mA	x 10 in milliamperes
2 mA	x 1 in milliamperes
200 mA	x100 in microamperes

h. Example:

On the 200 mA shunt range a 1605 dc output reading of 1.843254 equates to a measured current of 184.3254 milliamperes.

i. AC/DC correction factors may be applied for the Active Shunt and for the 1605. These correction factors may be added arithmetically or algebraically as indicated below:

Ic = Absolute value of measured current
 Im = measured current (DC OUTPUT x MULTIPLIER)
 CFS = Combined correction factor in percent for the Active Shunt and the 1605 as traceable to NBS for the applicable range and frequency.

Arithmetic addition of correction factors:

$$CFS = CFA_S + CF_{1605}$$

or

Algebraic addition of correction factors:

$$CFS = \sqrt{(CFA_S)^2 + (CF_{1605})^2}$$

$$Ic = Im \times \frac{100}{100 - CF}$$

j. Although usually not necessary, the operator may wish to substitute a dc current source and make a transfer measurement as indicated above to verify the absolute value and eliminating all ac factors.

3-60. MEASURING AN UNKNOWN CURRENT USING A PASSIVE SHUNT

a. Connect the test set-up of Figure 3-9. Be certain that the passive shunt has NBS traceable certification of ac/dc difference.

b. Connect the Ballantine Model 1605 Adapter to the LO INPUT connector of the 1605 ATS. The 16055A provides binding post input connection capability with controlled impedance so as to optimize shunt connection and cabling impedance.

c. Select the shunt which is rated for the rms current to be measured. Connect the shunt to the 1605 through the 16055A adapter. Passive shunts are intended to operate with 5 mA thermal elements in 180 to 200 ohm 1 volt Transfer Standards.

d. Set the 1605 controls to:

LOCAL/REMOTE	LOCAL
STANDBY/OPERATE	STANDBY
RANGE	.25 ► .5
MODE	AUTO FAST
INPUT/OUTPUT	INPUT

e. Turn on the current to be measured and set the 1605 to OPERATE. Observe that the NULL meter goes to BAL after a few seconds. If the NULL meter does not balance or the UNDERRANGE indicator illuminates, change the shunt for one with a lower current rating. If the OVERRANGE indicator lights or the 1605 trips into STANDBY, immediately shut down the current source to avoid damage to the shunt and change the shunt for one with a higher current rating.

CAUTION

Always shut off the current source and put the 1605 in STANDBY when reconnecting the test set-up to avoid connector or thermoelement damage due to the possibility of large transient voltages which may damage the connectors or the ATS.

f. If the NULL meter comes to BAL but the 1605 does not transfer from INPUT to OUTPUT state, it is an indication of instability in the shunt, the load, or the current source. Passive shunts have higher power dissipations so that some shunts

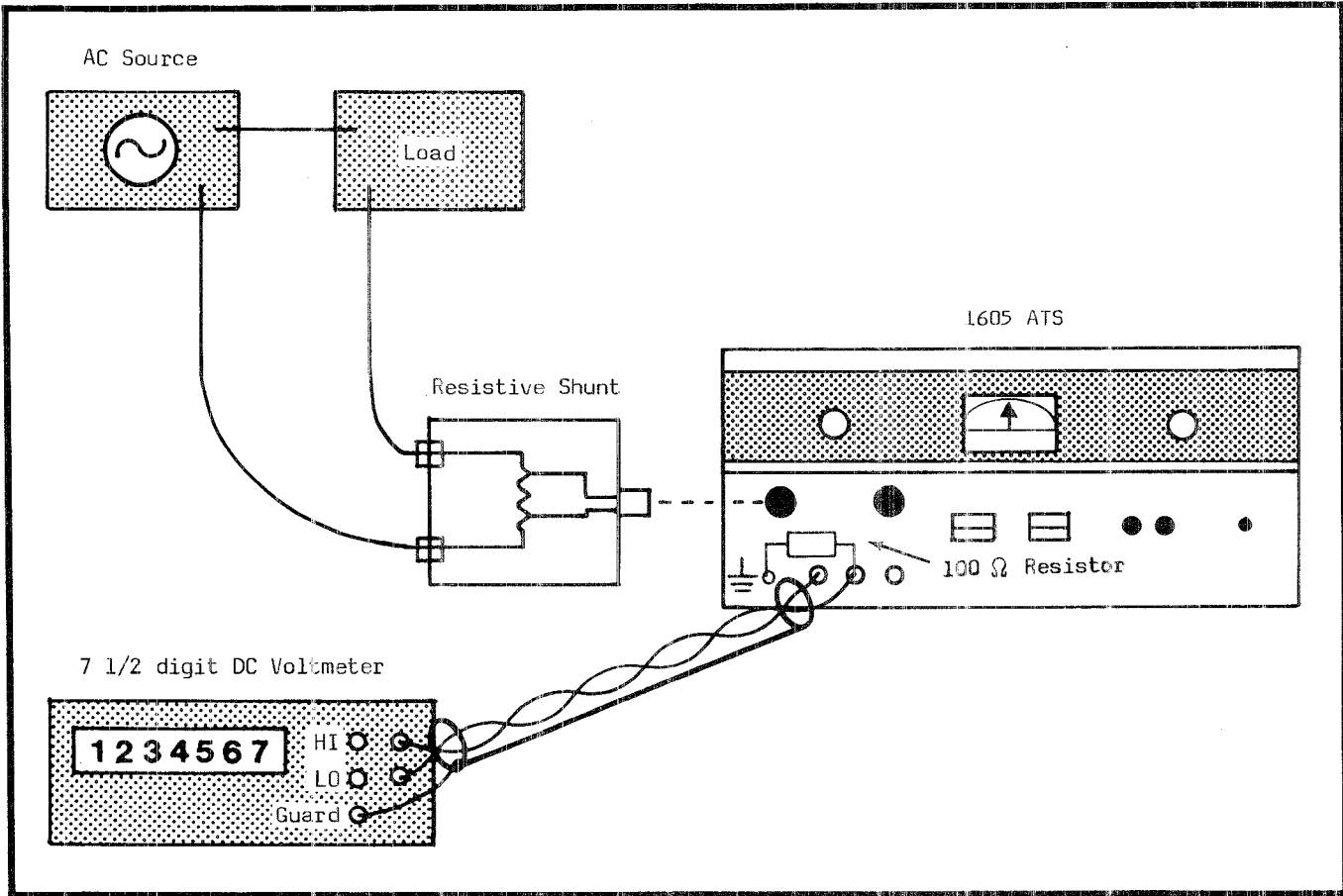

Figure 3-9. Measuring Current Using a Resistive Shunt

in the range above 100 nA may take many minutes to stabilize. The 1605 will recognize this instability and will not transfer until the test set-up is stable. If necessary, change the 1605A to MANUAL TRANSFER or MANUAL BALANCE mode when making current measurements in drifting systems.

3-61. CALIBRATING AN AC/DC OR AC CURRENT SOURCE USING AN ACTIVE SHUNT

The 1605 ATS may be used to calibrate an ac current source or transconductance amplifier such as the Ballantine Model 1620.

a. A calibrated and NBS traceable reference shunt such as the Ballantine Model 1625A Active Shunt is used. The shunt has precision dc calibration as well as ac/dc difference certification to simplify and speed measurements. If desired, a resistance standard may be used to certify dc output calibration but for most measurements the Ballantine Model 1625A Active Shunt will be sufficiently accurate to serve as a reference standard.

b. Connect the test set-up shown in Figure 3-10.

c. Connect the Model 1625A Active Shunt as indicated. Connect a stable dc voltage standard to the input terminals of the transconductance amplifier. If another ac/dc current source

is to be calibrated, select dc output. The following example will refer to the calibration of a transconductance amplifier such as the Ballantine Model 1620A.

d. DC calibration of the current source

1. DC calibration is performed by applying a dc input of 1 volt after the transconductance amplifier under test (UUT) is set to "zero".

2. Disconnect the auxiliary 7 1/2 digit dc voltmeter from the 1605 and reconnect it to the standard output terminals of the Model 1625A Active Shunt. For dc calibration the 1625A amplifier is not used. Set the voltmeter to the 200 mV dc range.

3. Select the current output range to be calibrated and set this RANGE on both the Active Shunt and the transconductance amplifier under test.

4. Apply 1.000000 volts dc to the input of the transconductance amplifier under test.

5. Adjust the range calibration of the transconductance amplifier until the dc voltmeter connected to the shunt reads exactly 100.0000 millivolts. If the Active Shunt calibration certificate has a correction at dc it must be applied at this point to provide absolute accuracy.

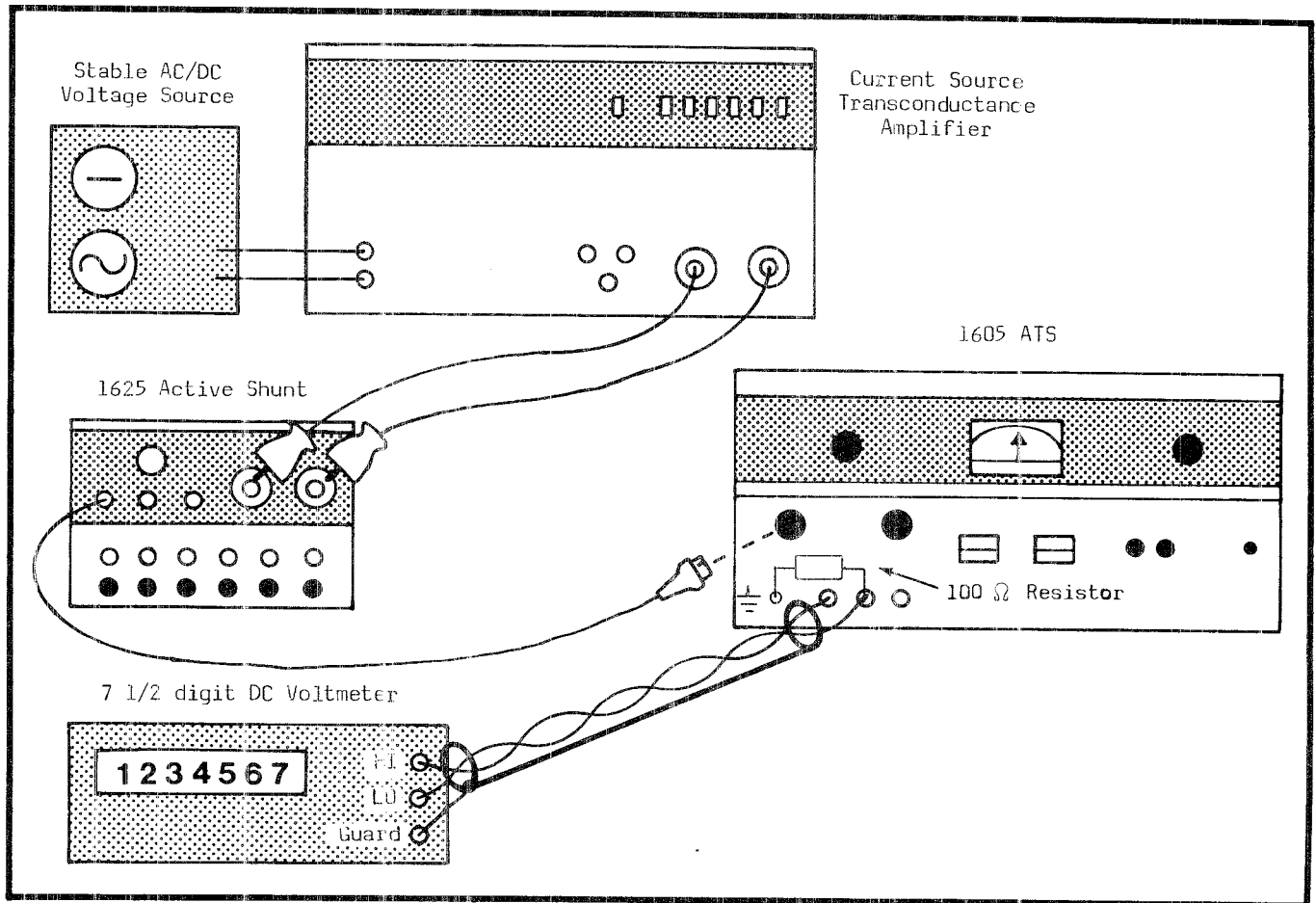

Figure 3-10. Calibrating a Current Source

6. Repeat this calibration for all other ranges of the transconductance amplifier and active shunt.

7. Another technique would use the auxiliary dc digital voltmeter in the dc/dc 4 wire ratio mode with the dc input to the transconductance amplifier serving as the ratio reference to the voltmeter. This method uses nulling techniques and is fundamentally most precise.

8. Reconnect the auxiliary dc digital voltmeter to the 1605 as indicated in Figure 3-10.

e. AC calibration of the current source

1. Verify the test set-up of Figure 3-10 and connect an ac voltage calibrator to the input terminals of the transconductance amplifier under test (UUT). Be certain all equipment is fully warmed up and stabilized when performing these tests.

2. Set the 1605 ATS controls to:

LOCAL/REMOTE	LOCAL
STANDBY/OPERATE	STANDBY
MODE	MANUAL BAL
INPUT/OUTPUT	OUTPUT
RANGE	.5 ▶ 1

3. Couple the output voltage of the 1605 at the frequency in question on the 1 volt range of the 1605 and the current range used on the 1625A Active Shunt. Add the ac/dc correction factors provided in the NBS traceable calibration test reports for the 1605 and the 1625A. Both correction factors are in percent. Observe polarity.

$$CF_T = (CF_{1605}) + (CF_{1625})$$

Then apply the following formula to compute the corrected output voltage

E_0 = auxiliary dc digit voltmeter reading

$$E_0 = 1 + \left(\frac{CF_T}{100} \right)$$

The absolute corrected output will be approximately 1 volt.

4. Set the range switches of the transconductance amplifier (UUT) and the Active Shunt to the same current value. Set the 1605 to OPERATE.

5. Set the AC Voltage input to the transconductance amplifier to 1.00000 volts at the frequency in question. Allow some minutes for the system to stabilize.

6. Verify that the 1605 ATS is in OUTPUT state and adjust the MANUAL BAL controls until the auxiliary voltmeter displays the voltage calculated in step 3. Use 1.0000 volts if correction factors are not used in step 3.

7. Set the 1605 to INPUT state. Adjust the transconductance amplifier under test for ac calibration on the selected range until the 1605 NULL meter is at BAL. This sets the UUT to the amplitude reference provided by the 1605 ATS and the 1625A Active Shunt.

8. Set the 1605 to OUTPUT state and check the digital voltmeter reading. If the system has drifted beyond the required uncertainty limit, repeat step 6 and step 7.

9. Repeat steps 3 through 8 for other frequency points on the range in question.

10. Repeat steps 3 through 9 for other ranges of the transconductance amplifier under test.

3-62. CALIBRATING THE AC/DC DIFFERENCE OF A FOUR TERMINAL SHUNT OR RESISTOR

a. This procedure calibrates the ac/dc difference of a four terminal current shunt or a four terminal resistor using the 1605 ATS.

b. Connect the test set-ups shown in Figure 3-11 or Figure 3-12. Use the test set-up of Figure 3-11 if two 1605 ATSs are available or switch one ATS from the reference shunt to the shunt under test (UUT) if the system components are very stable. The 1605 ATS connected to the reference shunt is used only to precisely monitor the constant ac output of the reference shunt. Figure 3-12 depicts a test set-up using a Ballantine 1397A-0.5 Precision Coaxial Thermal Converter to monitor the constant ac output of the reference shunt. A Lindeck Potentiometer such as the Ballantine Model 1610A control unit or a stable digital voltmeter with 1 microvolt or 100 nanovolt resolution may be used to monitor the output from the 1397A-0.5 Thermal Converter.

c. Use short high quality cables and connectors for the current connections. Use the 16055A adapter to connect the shunts to the 1605 ATS or the 1397A-0.5 Thermal Converter. Use a stable current source and allow adequate time for system warm-up and shunt stability. This is especially important when higher currents are used or if the shunts require extended stabilizing time. The Ballantine Model 1625A Active Shunt is recommended for the reference shunt because it has a very rapid settling time. When the 1625A is used as a reference shunt and/or as the shunt under test, then the 1605 ATS RANGE and the 1397A must be chosen to provide either 0.25 to .5, or .5 to 1, or 1 to 2 volts as required.

d. The following procedure is offered as an example for calibrating the ac/dc difference of passive shunts such as the Fluke A40 and A40A Series. The test set-up of Figure 3-12 will be used in the following test procedure.

e. The initial tests provide dc positive and dc negative reference points.

1. Connect a stable dc current source to the system.

2. Set up the required dc positive current and pass this current through the system. Allow sufficient warm-up time to stabilize all equipment.

3. Balance the Lindeck Potentiometer for a NULL on the 1610A control unit. If you use a digital voltmeter to read out the 1397A Thermal Converter then record the voltage reading which will be between 2.300 and 10.500 millivolts.

4. Set the 1605 ATS controls to

LOCAL/REMOTE	LOCAL
STANDEY/OPERATE	OPERATE
RANGE	.25 ▶ .5
MODE	MANUAL TRANSFER
INPUT/OUTPUT	INPUT

5. Recheck step 3 to assure that the test set-up is fully stable.

6. Observe that the 1605 ATS NULL meter is at BAL. Then push the INPUT/OUTPUT switch to change to the OUTPUT state.

7. Immediately after the READ indicator lights, read the average of the DC OUTPUT over the following 10 second period. Record this reading.

8. Change the output cables from the dc current source to provide a negative current of identical magnitude.

9. Note the magnitude of the changed NULL on the Lindeck Potentiometer or the changed reading of the voltmeter connected to the 1397A Thermal Converter. Record these changes.

10. Repeat steps 4, 5, 6, and 7 and record the output reading measured on the auxiliary dc digital voltmeter connected to the 1605 ATS.

11. Compute the average of the Lindeck Potentiometer NULL settings or the output voltage measured at the 1397A Thermal Converter as determined in steps 3 and 9.

$$\frac{(E_{dc+}) + (E_{dc-})}{2} = E_{dc \text{ ref}}$$

Record this reference value for future use.

12. Compute the average of the dc output reading for the two 1605 transfers determined in steps 7 and 9.

$$\frac{(E_{dc+}) + (E_{dc-})}{2} = E_{dc \text{ av}}$$

Record this value for future use.

f. Disconnect the dc current source and connect the ac current source. Allow sufficient time for warm-up.

g. Adjust the ac current source to the required test frequency.

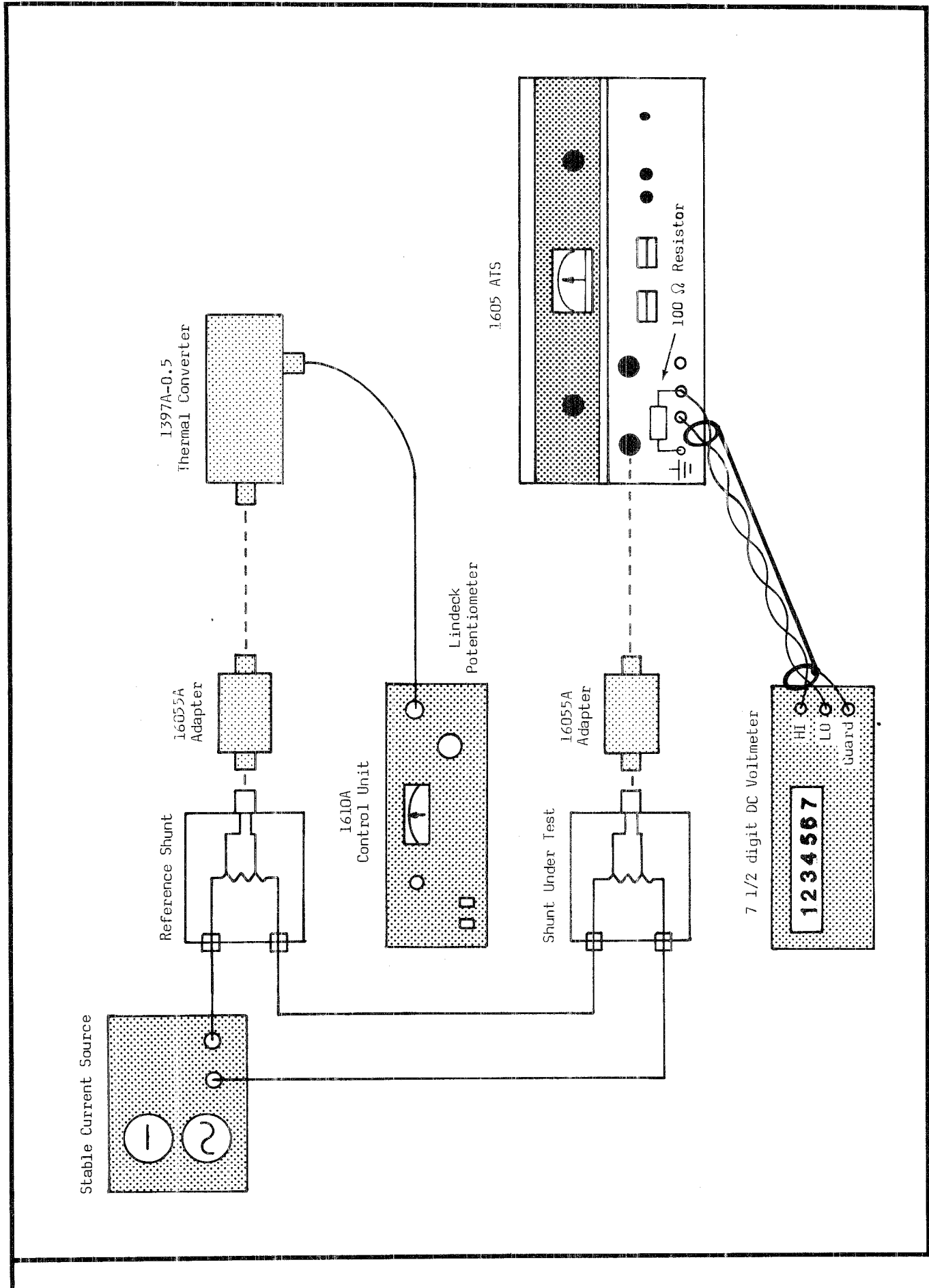

Figure 3-11. Calibrating AC/DC Difference of a Current Shunt

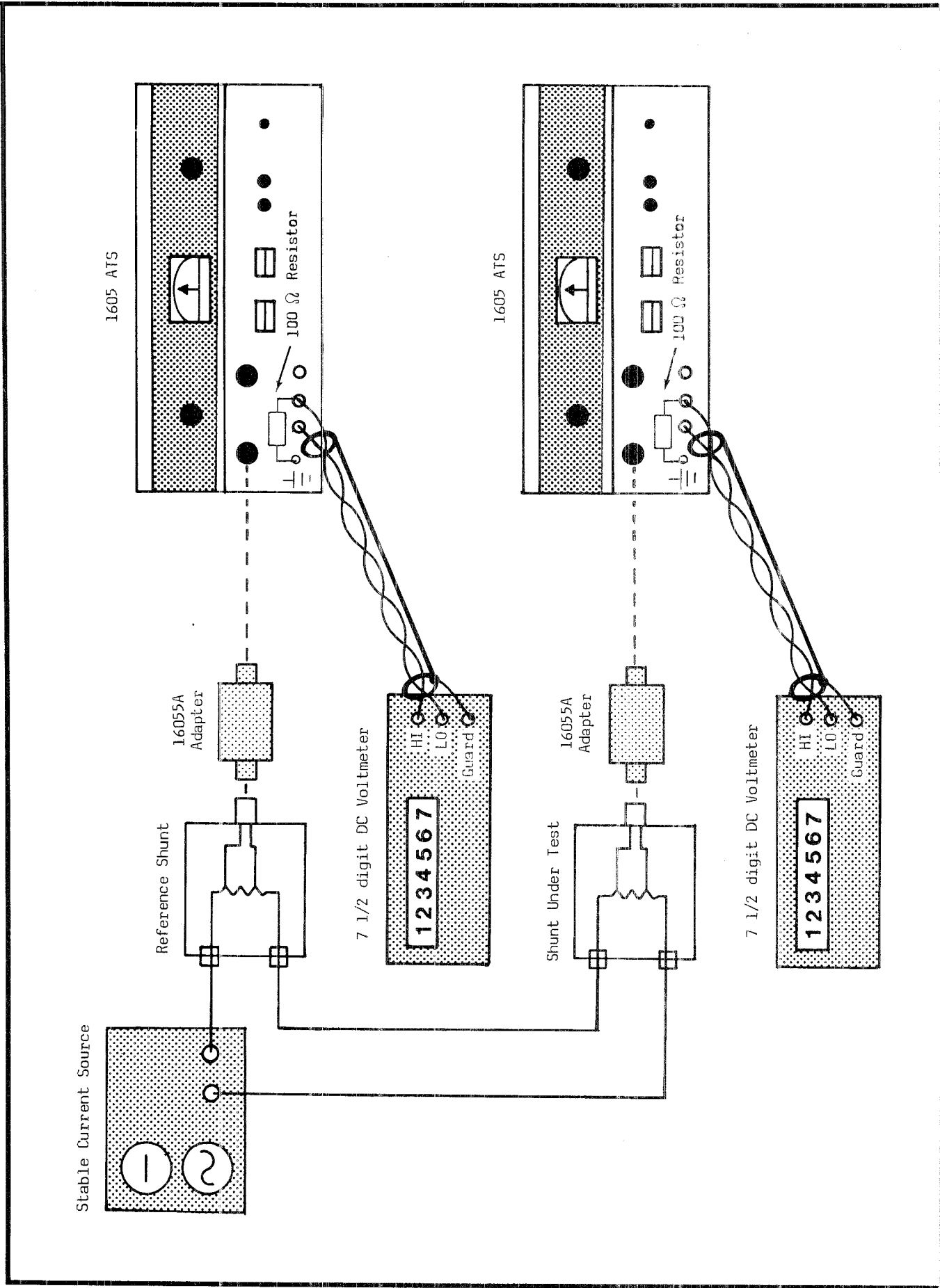

Figure 3-12. Calibrating AC/DC Difference of a Current Shunt (Alternate Method)

h. Adjust the ac current source amplitude until the output of the 1397A reference Thermal Converter conforms with the average value determined in step 11. Verify that the system is fully stable and the output from the Thermal Converter does not drift.

i. Repeat the 1605 transfer measurement performed in steps 4 through 7. Record the reading.

j. Compute the ac/dc difference of the shunt under test using the following procedure. All correction factors are expressed in percent and are obtained from the NBS traceable test report provided by NBS or a certified standards laboratory.

Note that the 1397A Thermal Converter has standardized the rms current. Its ac/dc correction factor is small but may be included in the computation.

Determine the combined correction factor (CFT) of the reference shunt (CFR), the reference thermal converter (CFC), and the 1605 ATS (CFA) by arithmetic addition by:

$$CFT = (CFR) + (CFC) + (CFA)$$

Note that all correction factors are in percent.

Determine the corrected output reading E_A of the 1605 auxiliary dc voltmeter reading (E_M) of step i by applying all corrections at this point.

$$E_A = E_M \times \left(\frac{100}{100 - CFT} \right)$$

Determine the ac/dc difference at the test frequency of the shunt under test (CFS) by the following computation

$$CFS = \frac{E_A - E_{dc\ av}}{E_{dc\ av}}$$

$E_{dc\ av}$ is the value determined in step 12.

k. Repeat steps g through j to determine the ac/dc difference of the shunt under test at different frequencies. Periodically check the dc tests to verify the amplitude stability of the test set-up.

3-63. REMOTE OPERATION USING THE GPIB

3-64. GPIB DESCRIPTION

3-65. It is assumed, in the following paragraphs, that you are knowledgeable about the GPIB.

3-66. 1605 RESPONSE TO BUS MESSAGES

3-67. The following paragraphs deal with the implementation of the GPIB using the 1605. The

instrument's bus capabilities are listed in Table 3-3. The following also explains the 1605's response to Bus Messages, also known as Meta Messages.

TABLE 3-3. INTERFACE FUNCTIONS

MNEMONIC	INTERFACE FUNCTION NAME
SH1	Source Handshake Capability
AH1	Acceptor Handshake Capability
T5	Talker (Basic Talker, Serial Poll, Talk Only Model, Unaddressed to Talk if Addressed to Listen)
L4	Listener (Basic Listener, Unaddressed to Listen if Addressed to Talk)
SR1	Service Request Capability
RL1	Remote/Local Capability
PPØ	No Parallel Poll Capability
DC1	Device Clear Capability
DTØ	No Device Trigger Capability
CØ	No Controller Capability
E1	Open Collector Bus Drivers

3-68. DATA

3-69. The Data Message is used to transfer information between the 1605 and the controller. It is used either to send data or to receive data. A description is as follows:

a. Send Data is the 1605's set up information (set to OPER, etc.). The instrument has to be in REMOTE and LISTEN (a listener) and the controller a Talker.

b. Receive Data is the 1605's output. This includes readings and instrument status. To send the data, the 1605 is the talker and the controller is a listener.

3-70. REMOTE

3-71. The 1605 is in the REMOTE mode when first turned on. A Remote Message allows the 1605 to be controlled over the GPIB. In REMOTE, the front panel controls are disabled (except the LOCAL button) and are then controllable over the GPIB. The instrument's initial set up is determined by the preset conditions in the memory.

3-72. LOCAL

3-73. This message enables the front panel operation. Pressing the front panel LOCAL button then sets the instrument to local, provided the button has not been disabled by the Local Lockout Message (see next paragraph).

3-74. LOCAL LOCKOUT

3-75. This message disables the 1605's Local Front Panel controls, including the LOCAL button. The message is in effect until the message is cleared over the GPIB or power is cycled.

3-76. CLEAR LOCKOUT

3-77. This message clears the Lockout.

3-78. REQUIRE SERVICE (SRQ)

3-79. The Require Service Message (SRQ) is independent of all other GPIB activity and is sent on a single line called the SRQ line. Its state is either true or false, with low being true and high being false. When the Require Service Message is sent and more than one device on the GPIB has the capability to send this message, the user must decide which device is sending the message. This is done by conducting a "Serial Poll" for the device(s) on the Bus. The device polled responds by sending a Status Byte. The Status Byte indicates whether the device has requested service and if so, for what reason. If the device polled shows that it did not send the Require Service Message, the other devices would typically be polled. Paragraph 3-82 describes the 1605's Status Byte.

3-80. When the 1605 sends a Require Service Message the message is cleared when the 1605 is polled. The following are the conditions that can cause a Require Service Message.

- Read Not Valid
- Read Ready
- Illegal Instrument State
- Internal Error
- Syntax Error
- Limits Failure

3-81. The 1605 requires service only if told to do so. It has to be programmed to output the Require Service Message for the previously listed conditions. This is done by setting the Service Request Mask. The mask is set by sending certain program codes to the 1605 and is explained in Table 3-4.

3-82. STATUS BYTE

3-83. The Status Byte Message is output by the 1605 in response to a Serial Poll. Table 3-5 lists the status byte messages which are defined as follows.

NOTE

Remember to set the SRQ mask and turn on the SRQ Switch on the rear panel to output the Require Service Message.

TABLE 3-4. INTERRUPT CONTROL CODES

	CONTROL	CODE																																				
Interrupt	<p>The type of conditions that generate interrupts is specified as follows: Hardware Failure, Read Valid, IEEE Bus Code errors, Functional Status errors. All interrupts may be disabled by the REAR PANEL switch labeled SRQ, Selective control is tabulated as follows:</p> <table border="1"> <thead> <tr> <th>Read Valid</th> <th>IEEE Bus Code</th> <th>Operational</th> <th></th> </tr> </thead> <tbody> <tr> <td>Off</td> <td>Off</td> <td>Off</td> <td>I0</td> </tr> <tr> <td>Off</td> <td>Off</td> <td>On</td> <td>I1</td> </tr> <tr> <td>Off</td> <td>On</td> <td>Off</td> <td>I2</td> </tr> <tr> <td>Off</td> <td>On</td> <td>On</td> <td>I3</td> </tr> <tr> <td>On</td> <td>Off</td> <td>Off</td> <td>I4</td> </tr> <tr> <td>On</td> <td>Off</td> <td>On</td> <td>I5</td> </tr> <tr> <td>On</td> <td>On</td> <td>Off</td> <td>I6</td> </tr> <tr> <td>On</td> <td>On</td> <td>On</td> <td>I7</td> </tr> </tbody> </table>	Read Valid	IEEE Bus Code	Operational		Off	Off	Off	I0	Off	Off	On	I1	Off	On	Off	I2	Off	On	On	I3	On	Off	Off	I4	On	Off	On	I5	On	On	Off	I6	On	On	On	I7	
Read Valid	IEEE Bus Code	Operational																																				
Off	Off	Off	I0																																			
Off	Off	On	I1																																			
Off	On	Off	I2																																			
Off	On	On	I3																																			
On	Off	Off	I4																																			
On	Off	On	I5																																			
On	On	Off	I6																																			
On	On	On	I7																																			
Prompts	To read the current status, send this command and then put the 1605 in the talk state. The string received will be the code set needed to command the 1605 to its current state.	STATUS																																				

TABLE 3-5. INTERRUPT RESPONSE CODES

TABLE 3-5. INTERRUPT RESPONSE CODES

HEX	DEC	TYPE	ENABLE	CAUSE
41	65	Hd	11,3,5,7	Output will not settle in window
42	66	Hd	"	Auto balance error timeout on input
43	67	Hd	"	Hardware error in front panel range switch
44	68	Hd	"	Hardware error in front panel mode switch
45	69	Hd	"	Prom failure
46	70	Hd	"	DC output did not settle within limits
4A	74	Hd	"	Balance error timeout in output state
51	81	Fn	"	Overload has tripped to standby
53	83	Fn	"	Under range limit has been reached
54	84	Fn	"	Over range limit has been reached
61	97	Bu	12,3,6,7	Undefined IEEE Bus command received
62	98	Bu	"	IEEE Buffer overflow (32 character max)
63	99	Bu	"	Improper terminator received
64	100	Bu	"	Requested OUTPUT state not allowed
65	101	Bu	"	Requested AUTO RECYCLE not allowed
66	102	Bu	"	Input not allowed
67	103	Bu	"	AUTO function interrupted
68	104	Bu	"	Delimiter character not allowed
C1	193	Rd	14,5,6,7	Valid to take maximum accuracy readings
C2	194	Rd	"	Timeout of maximum accuracy reading time
C3	195	Rd	"	AC to DC transfer flag

Hd = Hardware failure indicates 1605 needs service
 Bu = IEEE Bus command failure received by the 1605
 Rd = Flags used to indicate validity of DC output from 1605
 Fn = Functional Operation Errors

a. READ READY. A Require Service Message is output when the 1605's measurement cycle is completed (i.e. transfer to OUTPUT and dc settled).

b. READ NOT VALID. This Require Service Message is output when the DC Output State exceeds a maximum accuracy time or when the unit is recycled back to the ac (input) state.

c. ILLEGAL INSTRUMENT/INTERNAL ERROR/-SYNTAX ERROR. This message is output for the following conditions:

1. ILLEGAL INSTRUMENT STATE. An Illegal Instrument State is when the 1605 is, for example, unable to balance due to underrange input.

2. INTERNAL ERROR. An Internal Error occurs when a digital failure occurs in the 1605. If this should happen, refer the instrument to a Service Trained Person.

3. SYNTAX ERROR. A Syntax Error is when invalid program codes are sent to the 1605.

3-84. The Status Byte Message is described below. The higher order bits, except for bit 6, indicates a particular type of Require Service condition. Bit 6 (seventh bit) is the Service Request bit and is true when service is required. The bit lets the controller know that a Require Service condition exists. Remember, set the SRQ mask to output the Require Service Message.

a. One Require Service condition sets bits 0, 6, and 7 true. (Remember, bit 6 is true for any Require Service.) The conditions are caused by Read Data Ready.

b. The Status Byte looks like this:



NOTE

A "1" in this example indicates a true condition.

c. The byte is output in octal code and the corresponding octal number is:

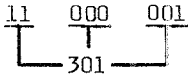

The resultant decimal number of octal 301 is 192.

3-85. STATUS BIT

3-86. The 1605 does not respond to a Parallel Poll.

NOTE

The Status Bit is not part of the Status Byte Message and should not be confused with the bits in the Status Byte Message.

3-87. PASS CONTROL

3-88. The 1605 does not have controller capabilities.

3-89. ABORT (INTERFACE CLEAR)

3-90. All GPIB communication is terminated, including the 1605's Bus communication. Control is returned to the system controller. The Abort Message does not remove the 1605 from remote control.

3-91. 1605 ADDRESSING

3-92. GPIB requires that a device on the Bus needs to be identified as a Listener or a Talker, in order to execute the Bus Messages and commands. Because of this requirement, each device on the GPIB has a unique "listen" and "talk" address to distinguish themselves from each other. The device is then able to receive programming instructions when addressed to listen or send data when addressed to talk.

The 1605's address is set by the address switch located at the instrument's rear panel. The switch is an eight section "DIP" switch with five switches used for address selection, as shown in Table 3-6. The sixth switch is used to enable the SRQ; the seventh switch sets the instrument to generate an EOI on the last character transmitted across the bus; the eighth switch determines the end character as a CR or CR then LF. The 1605's allowable address settings are listed in Table 3-6.

NOTE

Setting the 1605's Address Switch to the Listen Address' corresponding decimal code will also set the Talk Address.

Instrument address commands are usually in this form:

universal unlisten, device talk, device listen.

The universal unlisten command removes all listeners from the GPIB to allow only the addressed listener to receive information. The information is sent by a talker which is designated by the device talk code.

3-93. TALK-ONLY (NO CONTROLLER)

3-94. 1605 GPIB PROGRAMMING

3-95. Now that the basic GPIB operation is known, the next thing is to program and use the 1605 over the Bus. First, determine the instrument operation you want. Then determine the 1605's program codes. The codes are ASCII characters transmitted over the GPIB to the instrument.

Once you have defined the instrument criteria and program codes, next write an algorithm on how to make the measurement. When you have done this, convert the algorithm to controller language. Refer to your controller's operating manual for the language. See Table 3-7.

3-96. ALGORITHM

3-97. The algorithm should show exactly how to set up and use the instrument in a certain function. To simplify the algorithm, use the nine Bus Messages as key words in the algorithm. The messages are repeated here for your reference.

1. MODE
2. RECYCLE
3. MEASUREMENT
4. OPERATION
5. RANGE
6. REMOTE
7. INTERRUPT
8. PROMPTS
9. TIMING

3-98. Here is an example Algorithm for the 1605. Note that only the key words are used, not the codes.

a. In this algorithm, the 1605 is set up to make a DCV measurement, output it over the GPIB and print the reading. The program ends if the 1605 sends a Require Service message. The algorithm is as follows.

1. ABORT all previous operations
2. Set the 1605 to REMOTE
3. CLEAR the 1605
4. LOCAL LOCKOUT the Instrument
5. Send DATA to set up the 1605 to
 - a. Auto Transfer Normal Accuracy
 - b. 8V Range
 - c. Input
 - d. Set the 1605 to OPERATE
 - e. Set SRQ mask to Read Valid

TABLE 3-6. 1605 ADDRESS CODES

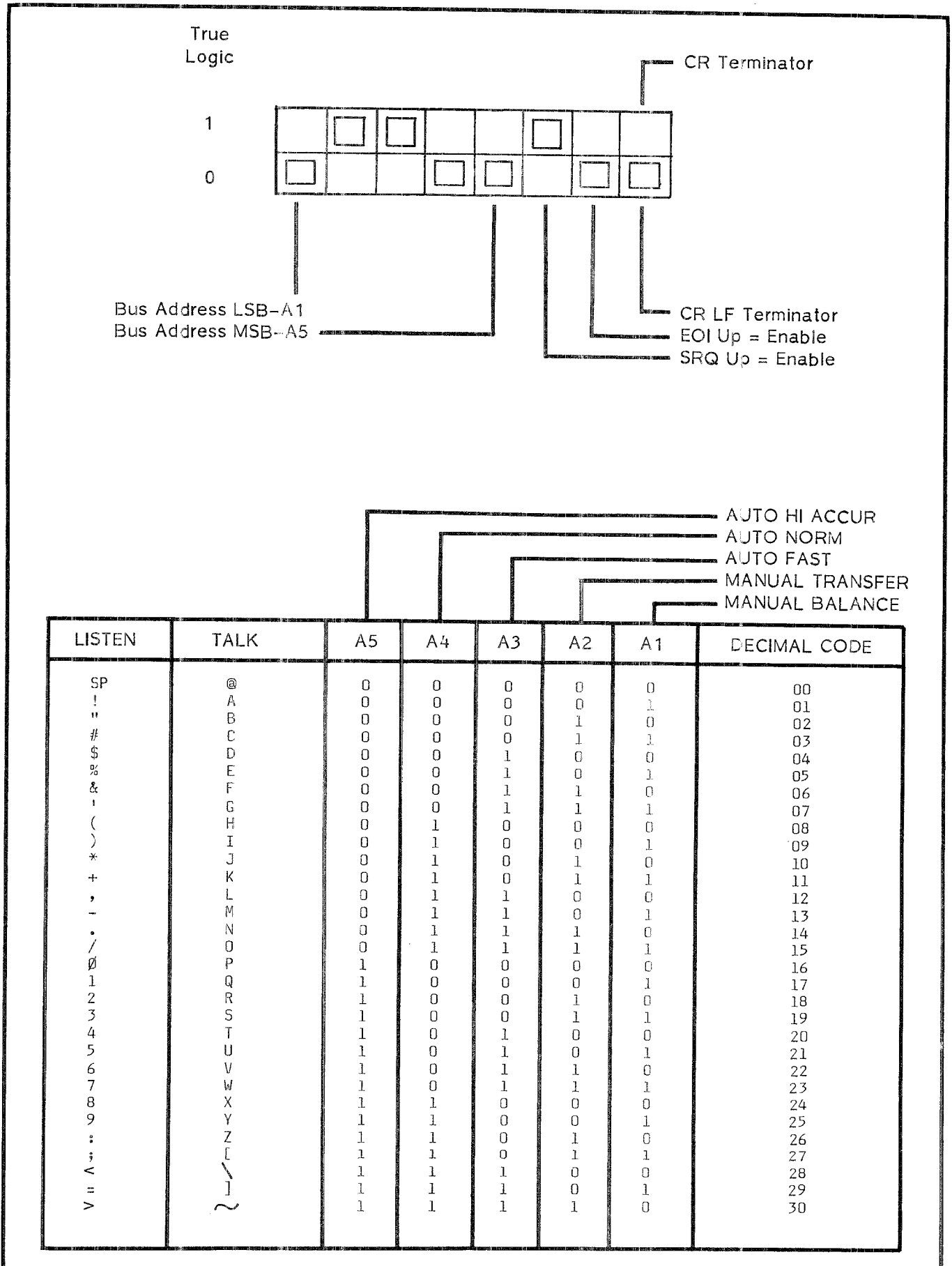

6. Check the 1605 to see if it REQUIRE'S SERVICE
7. If REQUIRE SERVICE, check the STATUS BYTE; otherwise skip the next step
8. If the 1605 sent the STATUS BYTE, it did REQUIRE SERVICE and the program is ended
9. Print out the DATA from the variable
10. CLEAR LOCKOUT AND SET LOCAL
11. End program

3-99. PROGRAMMING THE 1605 OVER THE GPIB

3-100. Programming the 1605 is done by DATA messages. Remember, DATA is sent or received. The DATA received by the 1605 is for instrument set up (function, range, etc.). The DATA sent by the 1605 is output data. Included in the following paragraph are programming examples of the Bus Messages and the algorithm. They are given in the GPIB format, HPL (9825A Controller Language), and Enhanced Basic (9835A/B and 9845B Controller Language).

3-101. PROGRAM CODES (DATA RECEIVED BY THE 1605)

3-102. Program codes are used for the 1605's set up information. A listing of the codes is in Table 3-7. The instrument must be in "REMOTE" and "LISTEN" to receive the codes. An example is as follows.

a. GPIB format:

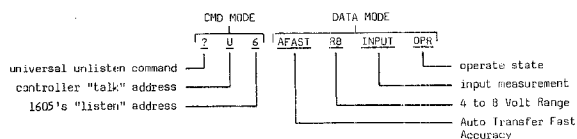

- b. HPL (9825A Controller Language).
wrt 722, "AFAST R8 INPUT OPR"
- c. Enhanced Basic (9835A/B, 9845B Controller Language).
OUTPUT 722; "AFAST R8 INPUT OPR"

NOTE

The "7" in the "722" address code is the 9825A, 9835A/B, and 9845B Controllers I/O Card select code.

NOTE

The spaces between the program codes (AFASTspaceR8, etc.) shown in the example are necessary.

3-103. PROGRAMMING THE SRQ MASK

3-104. Program codes are used to set the SRQ Mask. Use the programming procedure as follows to send the codes. Remember, the 1605 has to be in "LISTEN" to receive the codes. The Status Byte Message is in hexadecimal and the mask is programmed by using Table 3-5.

a. GPIB Format

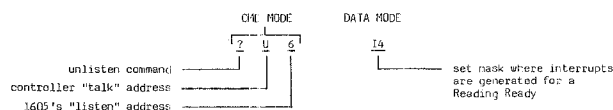

- b. HPL (9825A Controller Language).
wrt 722, "I4"
- c. Enhanced Basic (9835A/B, 9845B Controller Language).
OUTPUT 722; "I4"

3-105. Any, all, or combinations of the Require Service conditions can be set by programming the SRQ mask. All non-hardware failures can be disabled by programming the mask to "I0". Hardware failures may be disabled only by setting switch 6 on the rear panel to the off position.

3-106. ASCII FORMAT

3-107. READING THE 1605'S STATUS

3-108. To interrogate the 1605 for its current operational status, it is necessary to send a command over the bus.

a. GPIB Format

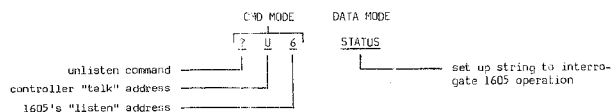

- b. HPL (9825A Controller Language).
wrt 722, "STATUS"
- c. Enhanced Basic (9835A/B, 9845B, Controller Language).
OUTPUT 722; "STATUS"
- d. The 1605 has to be in "REMOTE" and "LISTEN"

TABLE 3--7. 1605 PROGRAM CODES

	CONTROL	CODE																																				
Mode	Selects Automatic Transfer High Accuracy " Automatic Transfer Normal Accuracy " Automatic Transfer Fast Accuracy " Manual Transfer " Manual Balance	AHIAC ANORM AFAST MXFER MBALN																																				
Recycle	Selects Manual Recycle " Automatic Recycle (AUTO MODE) " Recycle Off	RCYMAN RCYAUT RCYOFF																																				
Measurement	Selects Input or AC Operation " Output or DC Operation	INPUT OUTPUT																																				
Operation	Selects Standby " Operate	STY OPR																																				
Range	Selects 0.25 to 0.5 Volt Range " 0.5 to 1 " " " 1 to 2 " " " 2 to 4 " " " 4 to 8 " " " 8 to 16 " " " 16 to 32 " " " 32 to 64 " " " 64 to 125 " " " 125 to 250 " " " 250 to 500 " " " 500 to 1000 " "	R0.5 R1 R2 R4 R8 R16 R32 R64 R125 R250 R500 R1000																																				
Remote	Enable the LOCAL request Switch Disable ALL Local Operation	GTL LLO																																				
Interrupt	The type of conditions that generate interrupts is specified as follows: Hardware Failure, Read Valid, IEEE Bus Code errors, Functional Status errors. All interrupts may be disabled by the REAR PANEL switch labeled SRQ, Selective control is tabulated as follows: <table border="0" style="margin-left: 40px;"> <thead> <tr> <th style="text-align: left;"><u>Read</u> <u>Valid</u></th> <th style="text-align: left;"><u>IEEE</u> <u>Bus</u> <u>Code</u></th> <th style="text-align: left;"><u>Operational</u></th> <th></th> </tr> </thead> <tbody> <tr><td>Off</td><td>Off</td><td>Off</td><td>I0</td></tr> <tr><td>Off</td><td>Off</td><td>On</td><td>I1</td></tr> <tr><td>Off</td><td>On</td><td>Off</td><td>I2</td></tr> <tr><td>Off</td><td>On</td><td>On</td><td>I3</td></tr> <tr><td>On</td><td>Off</td><td>Off</td><td>I4</td></tr> <tr><td>On</td><td>Off</td><td>On</td><td>I5</td></tr> <tr><td>On</td><td>On</td><td>Off</td><td>I6</td></tr> <tr><td>On</td><td>On</td><td>On</td><td>I7</td></tr> </tbody> </table>	<u>Read</u> <u>Valid</u>	<u>IEEE</u> <u>Bus</u> <u>Code</u>	<u>Operational</u>		Off	Off	Off	I0	Off	Off	On	I1	Off	On	Off	I2	Off	On	On	I3	On	Off	Off	I4	On	Off	On	I5	On	On	Off	I6	On	On	On	I7	
<u>Read</u> <u>Valid</u>	<u>IEEE</u> <u>Bus</u> <u>Code</u>	<u>Operational</u>																																				
Off	Off	Off	I0																																			
Off	Off	On	I1																																			
Off	On	Off	I2																																			
Off	On	On	I3																																			
On	Off	Off	I4																																			
On	Off	On	I5																																			
On	On	Off	I6																																			
On	On	On	I7																																			
Prompts	To read the current status, send this command and then put the 1605 in the talk state. The string received will be the code set needed to command the 1605 to its current state.	STATUS																																				
Timing	Changes TIME Required in AC Window Before Transfer Changes TIME from AC/DC TRANSFER to Read Valid. Changes TIME from Read Valid to End of Read Valid. NOTE: These commands are cancelled on a MODE change or Power Up. XXXX is a decimal value in ms. YY is the multiplier.	RDVALXXXXYY LOOPXXXXYY CYCLEXXXXYY																																				

e. GPIB Format

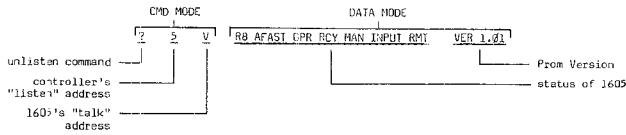

f. HPL (9825A Controller Language).

red 722, A

g. Enhanced Basic (9835A/B, 9845B Controller Language).

ENTER 722; A

3-113. DISABLING THE END OR IDENTIFY (EOI) STATEMENT

3-114. The End or Identify (EOI) statement can be disabled. This is done by placing switch 7 of the address switch to the off (Ø) state.

3-115. COMPLETE PROGRAM EXAMPLE

3-116. After you know how to program the 1605 using the GPIB, the next step is to write a program of the algorithm in Paragraph 3-98. Again, the program is given in GPIB Format, HPL (9825A Controller Language), and Enhanced Basic (9835A/B, 9845B Controller Language).

3-109. DATA OUTPUT

3-110. The 1605 may be interrogated to determine the operational status when an interrupt handler routine cannot be implemented. The Data returned is a two byte code as shown in Table 3-8.

TABLE 3-8. DATA CODE

DATA	CONDITION
00	No Fault
01	Read Valid Time
10	Underrange, Overrange, or Overload Error

3-111. READING THE 1605's OUTPUT DATA

3-112. To output data, the 1605 has to be addressed to "talk" and the device receiving the data is the listener. Here is an example.

a. GPIB Format.

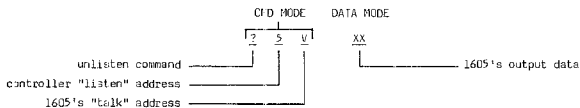

b. HPL (9825A Controller Language).

red 722, A

c. Enhanced Basic (9835A/B, 9845B Controller Language).

ENTER 722; A

NOTE

Although it is not specified in the GPIB Format, the output of the 1605 is normally stored in a variable. This is the reason why variable "A" is used in the controller language examples.

a. GPIB Format

1. Interface Clear ABORT all previous operation
2. ?U6 REMOTE the 1605
3. ?U6 ØØ4 CLEAR the instrument
4. Ø21 LOCAL LOCKOUT the 1605 (including the other devices on the controller's select code)
5. ?U6 Send DATA to set up the instrument to the Auto Normal Accuracy 8 Volt Range, Input, Operate (15 is CR and 12 is LF)
Send the measurement DATA to the controller and store in a variable
6. ?5V Ø3Ø If REQUIRE SERVICE, check the STATUS BYTE; otherwise skip the next step (the Ø3Ø is the Serial Poll enable)
- 7, 8. Ø31 No STATUS BYTE is sent by the 1605 (the Ø31 is the Serial Poll disable)
9. Data Subroutine Print out the DATA in variable A
10. ?U, ØØ1 CLEAR LOCKOUT AND SET LOCAL (in this case, only for the 1605)
11. Controller Language Ends the program

b. HPL (9825A Controller Language).

```
0: cli 7          ABORT
1: rem 722        REMOTE 1605
2: clr 722        CLEAR 1605
3: llo 7          LOCAL LOCKOUT
4: wrt 722,       DATA. Set up in-
  "ANORM INPUT R8 OPR"  strument
5: rds (722) - S  REQUIRE SERVICE?
6: if S=Ø; goto 10  If no STATUS BIT,
                        skip the next
                        line
7: stop          Stop the program
8: data subroutine  Subroutine to
                        read DVM and
                        print DATA
9: lcl 722        CLEAR LOCKOUT AND
                        SET LOCAL (1605)
10: end           Ends the program
```

c. Enhanced Basic (9835A/B, 9845B Controller Language).

```
10 ABORTIO 7      ABORT
20 REMOTE 722     REMOTE 1605
30 CLEAR 722      CLEAR 1605
40 LOCAL LOCKOUT 7  LOCAL LOCKOUT
50 OUTPUT 722;    DATA. set up in-
  "ANORM INPUT R8 OPR"  strument
60 STATUS 722;S   REQUIRE SERVICE?
70 IF S=Ø THEN    If no STATUS BIT,
  GOTO 110        skip the next
                  line
80 STOP          Stop the program
90 USER PRG.     Subroutine to
                  read DVM and
                  print DATA
100 LOCAL 722     CLEAR LOCKOUT AND
                  SET LOCAL
110 END           Ends the program
```

3-117. The information you have received in the preceding paragraphs should give you a good start in programming the 1605 over the GPIB. The following paragraphs explain some more unique remote operations.

3-118. READING READY

3-119. The Reading Ready feature, when enabled, outputs a Require Service Message for a completed measurement cycle. The SRQ mask has to be set before the message is output. Set the mask by sending program codes. When the 1605 is polled the SRQ is cleared (Serial Poll).

3-120. OPERATOR'S CHECK

3-121. WAKE UP STATE

3-122. The 1605 is programmed to do a series of hardware tests then present the current bus address setting on the 5 Mode Display lamps (see Table 3-6). It then goes to the Remote state, 1000V Range, Input, Auto Recycle Off, Standby, Auto Normal Accuracy, and Programmable Interrupts Off. This state is established in order to protect the 1605 on a power interrupt.

3-123. DEVICE CLEAR

3-124. The 1605 returns to the wake up state on receipt of a clear on the IEEE bus device.

APPENDIX 1

Magnitude of AC-DC Correction Factor:

The magnitude of ac-dc difference correction factor is an indication of 1605B uncorrected frequency response. It is typically less than the percentage indicated below.

Expressed as % of output without ac-dc difference correction factors at 23°C ± 5°C.

Range	10 Hz to 20 Hz	20 Hz to 20 kHz	20 kHz to 50 kHz	50 kHz to 100 kHz	100 kHz to 1 MHz	1 MHz to 10 MHz	10 MHz to 30 MHz	30 MHz to 100 MHz
Low Voltage Input								
.25 to .5 V	0.035	0.018	0.015	0.03	0.055	0.5	2.2	7
.5 to 1	0.02	0.009	0.015	0.03	0.055	0.35	1.8	5
1 to 2	0.02	0.008	0.010	0.025	0.055	0.35	1.8	5
2 to 4	0.02	0.007	0.010	0.02	0.055	0.35	1.8	7
4 to 8	0.02	0.007	0.010	0.02	0.055	0.35	1.8	-
8 to 16	0.02	0.005	0.010	0.02	0.055	0.45	2.2	-
16 to 32	0.02	0.003	0.010	0.02	0.065	----	---	-
High Voltage Input								
32 to 64	0.02	0.010	0.015	0.03	0.18	----	---	-
64 to 125	0.02	0.010	0.015	0.03	0.22	----	---	-
125 to 250	0.02	0.010	0.015	0.04	----	----	---	-
250 to 500	0.03	0.015	0.020	0.05	----	----	---	-
500 to 1000	0.03	0.030	0.055	0.065	----	----	---	-

Stability of AC-DC Difference Correction Factors is typically:

- ± 5 ppm for 90 days
- ± 15 ppm for 1 year

Applicable 40 Hz to above 50 kHz at input voltages 1 V to 100 V. The effects of ac-dc difference correction factor stability are included in the accuracies stated in the specifications of Table 1-1.

