

TYPE TR-4654

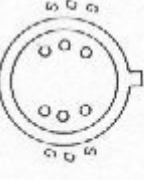

1567

A

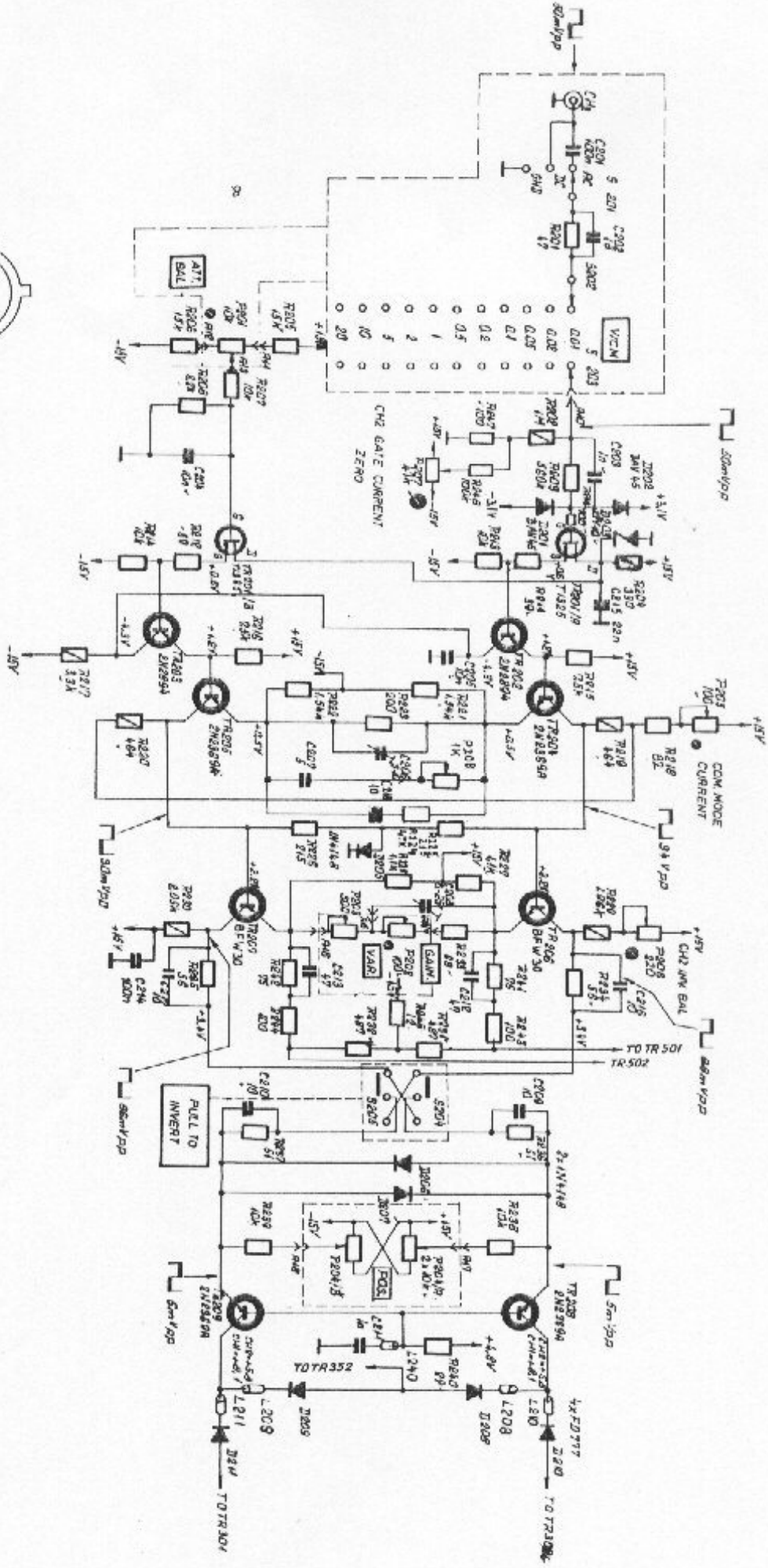

TIS 25
BOTTOM VIEW

CONNECT 1

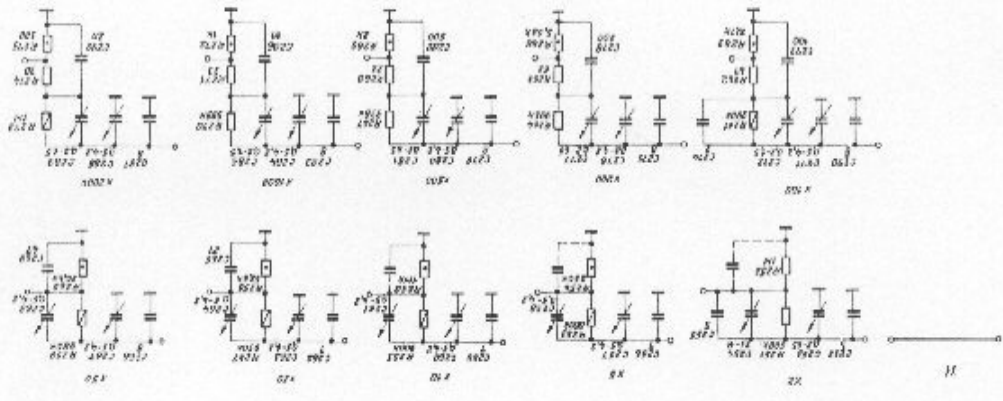

CONNECT 2

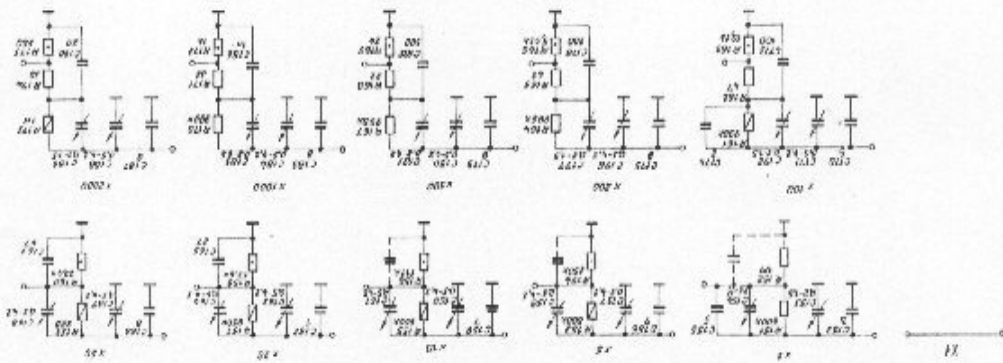

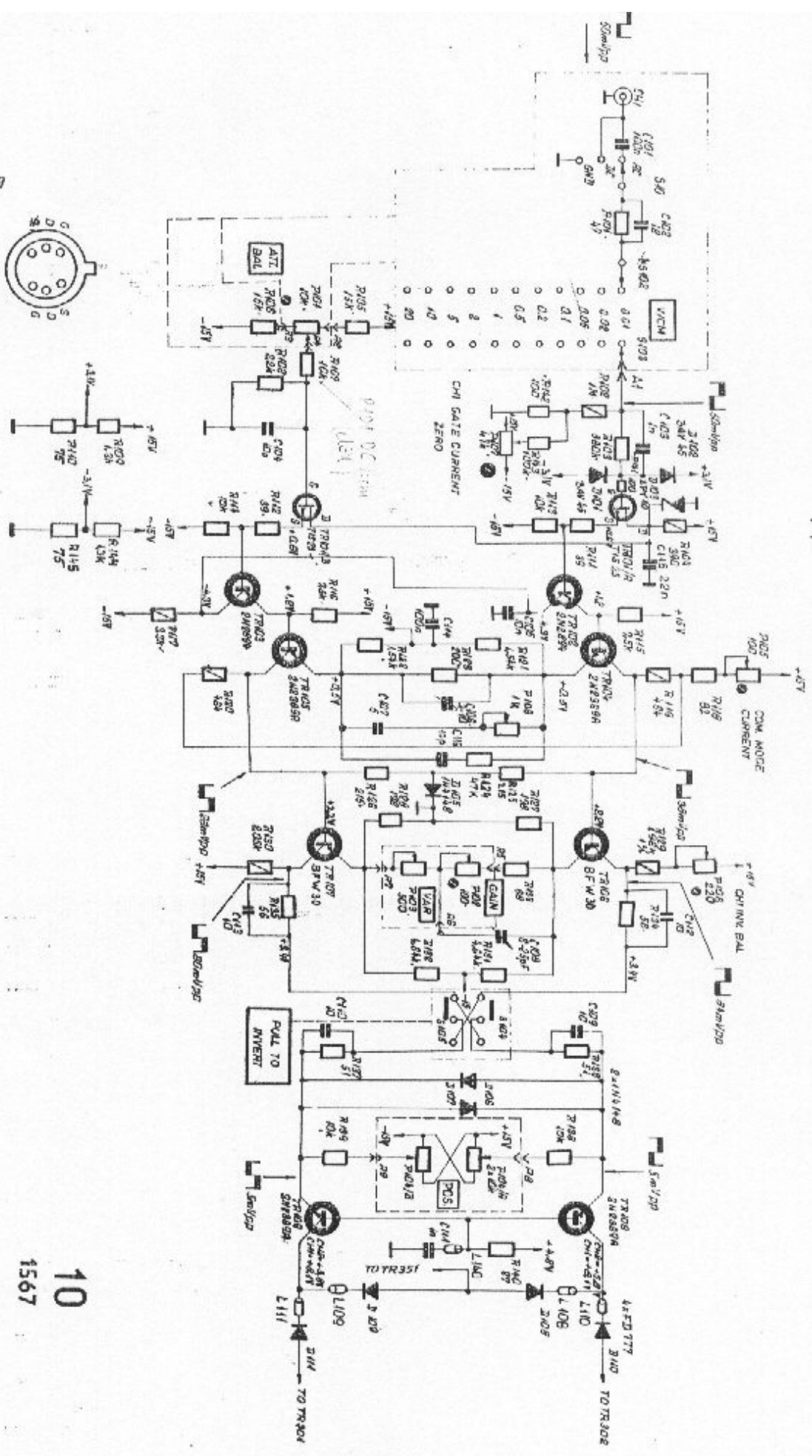

T/S 25
BOTTOM VIEW

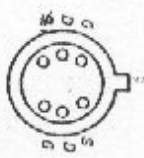

10
1567

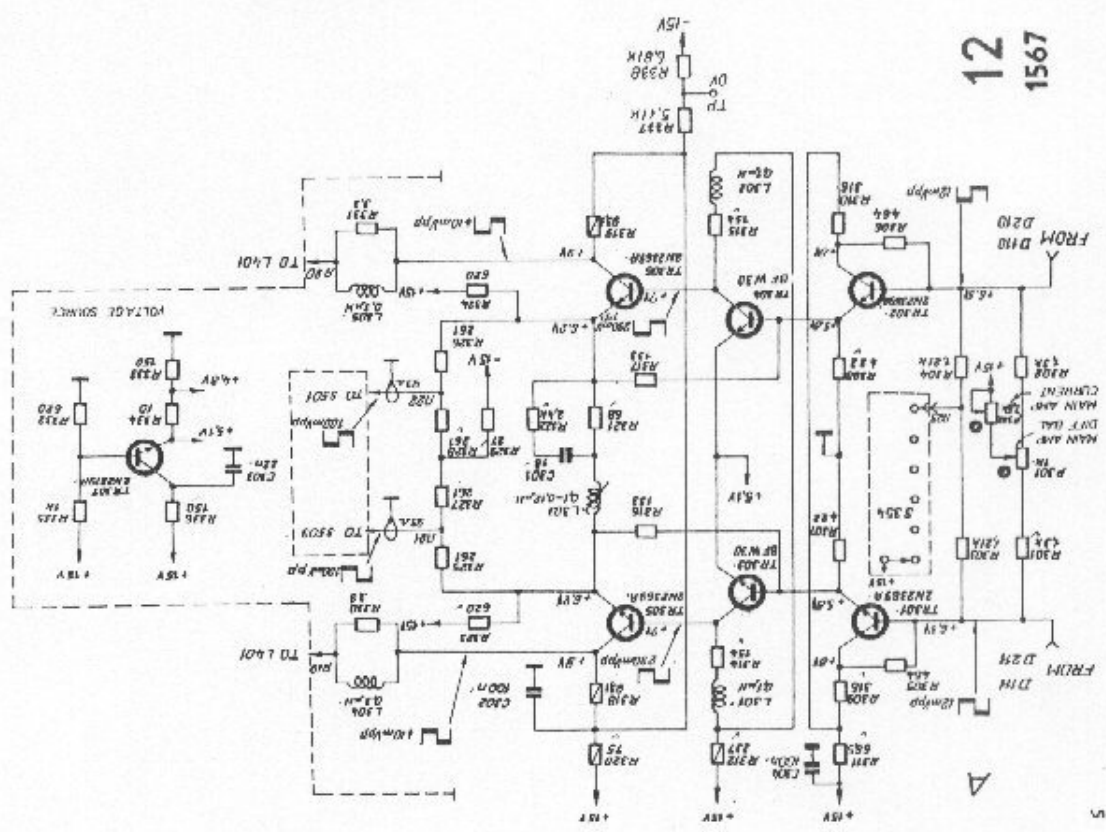
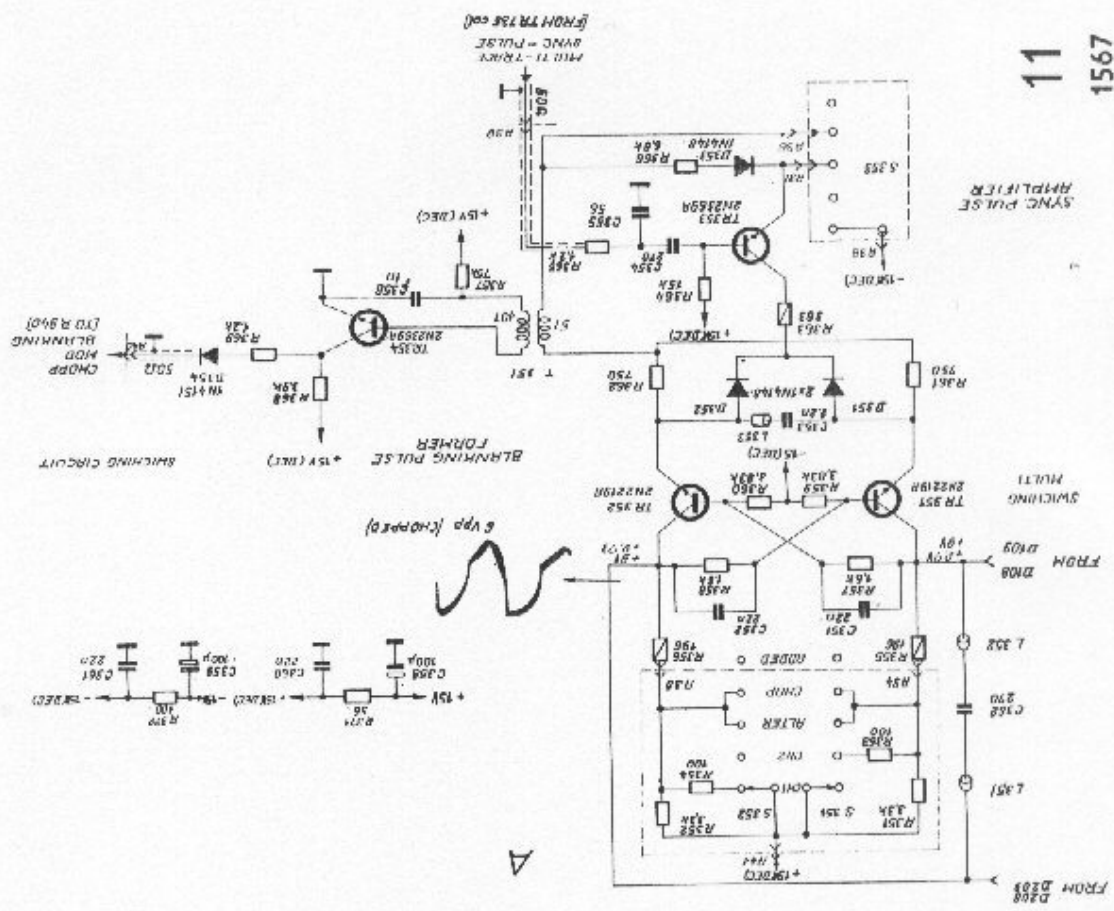

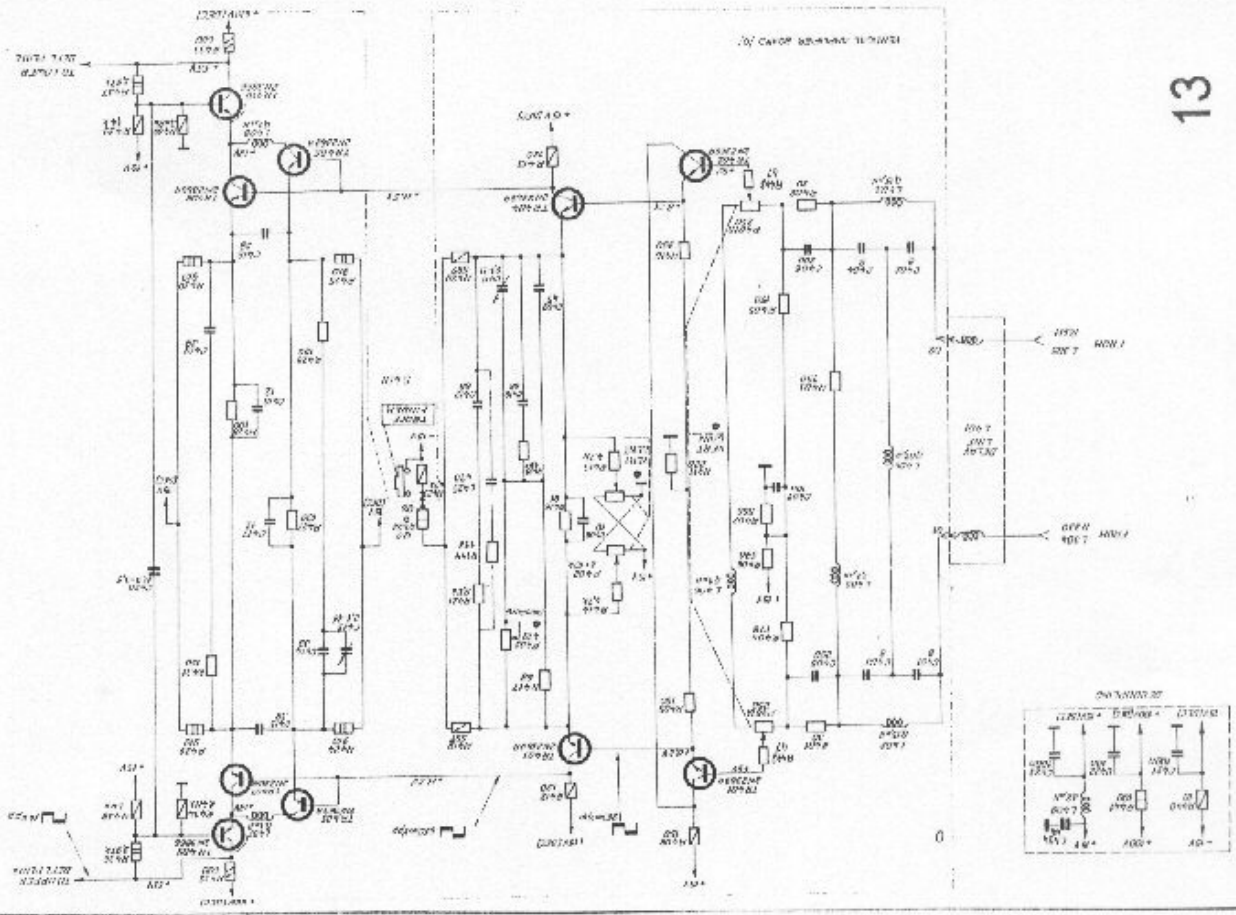

13
1567

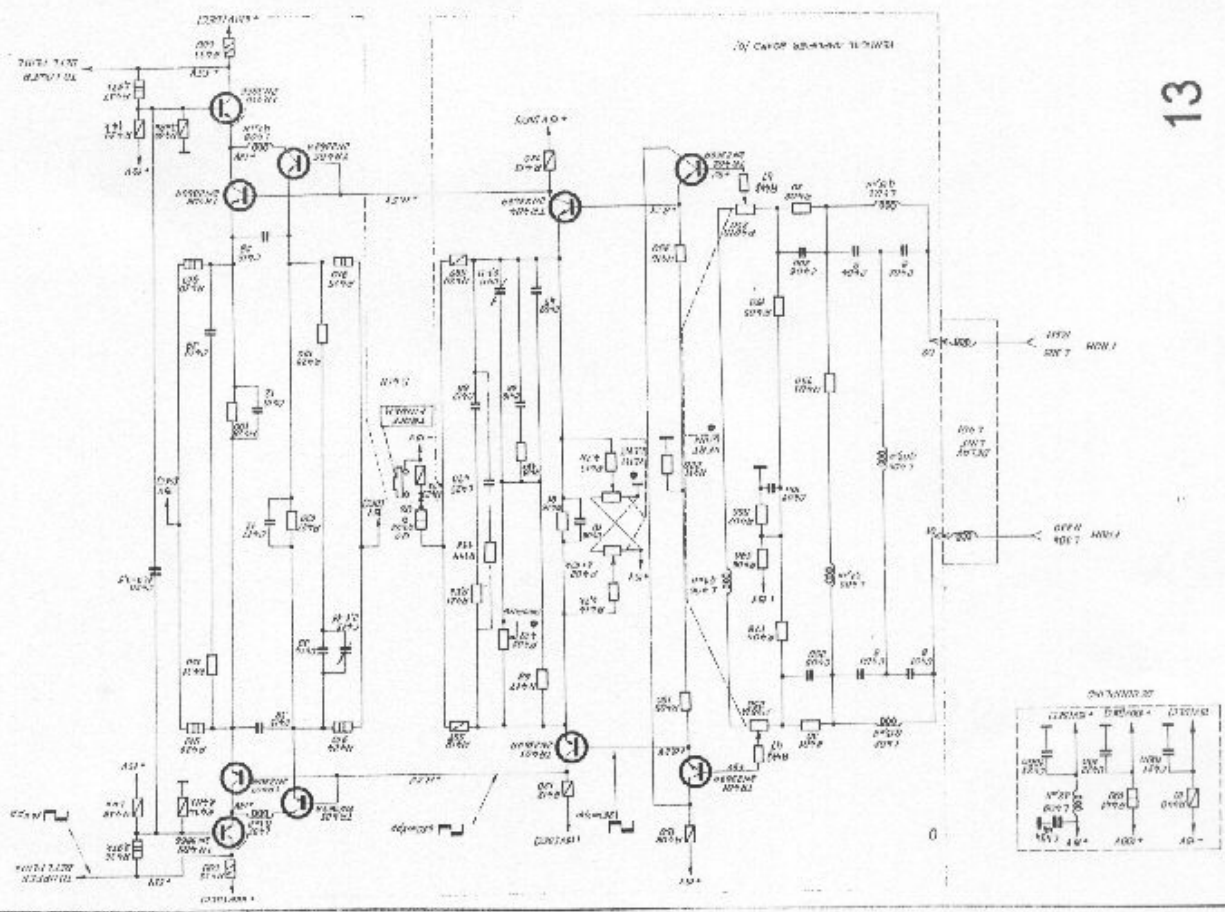

13
1567

A

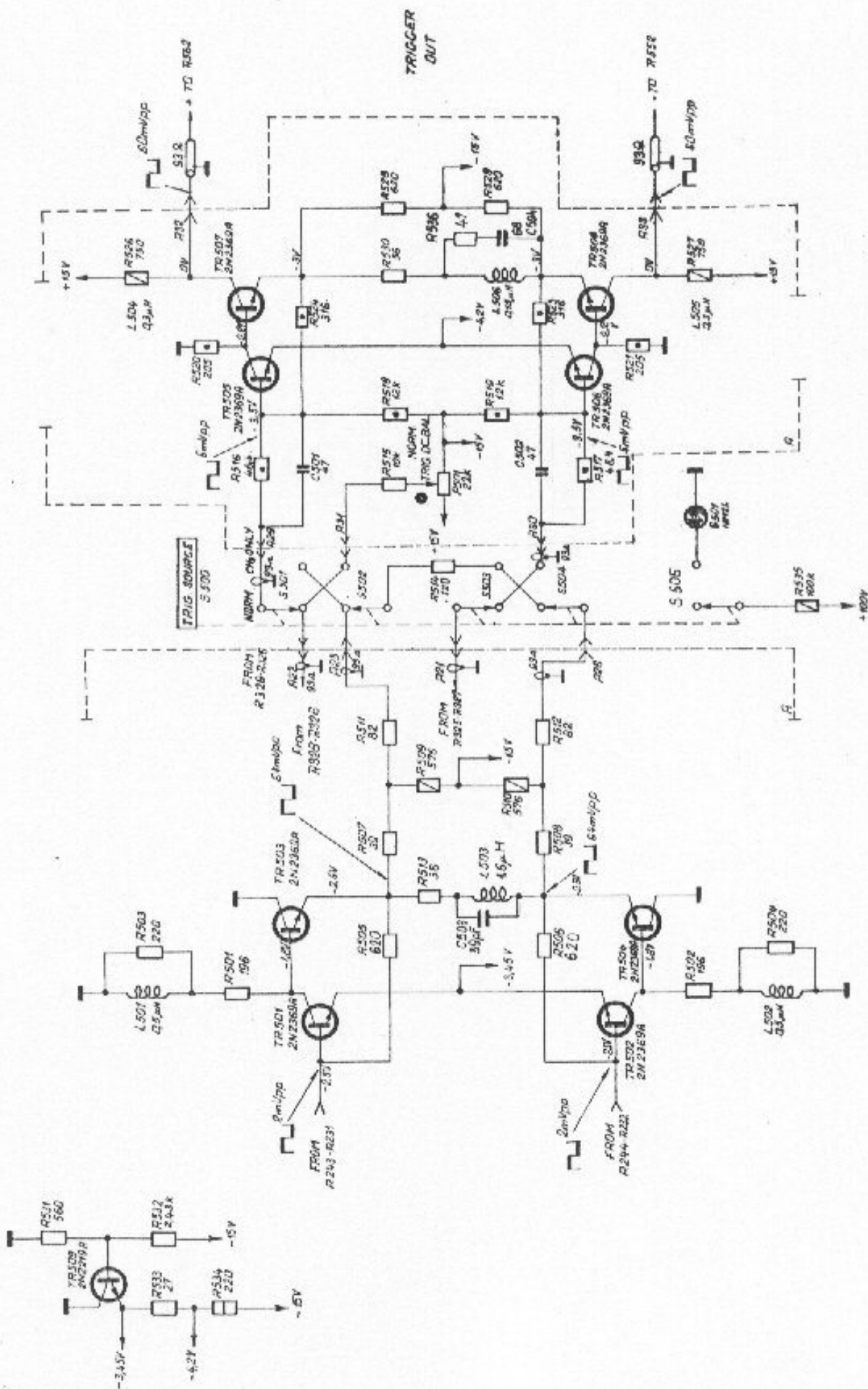

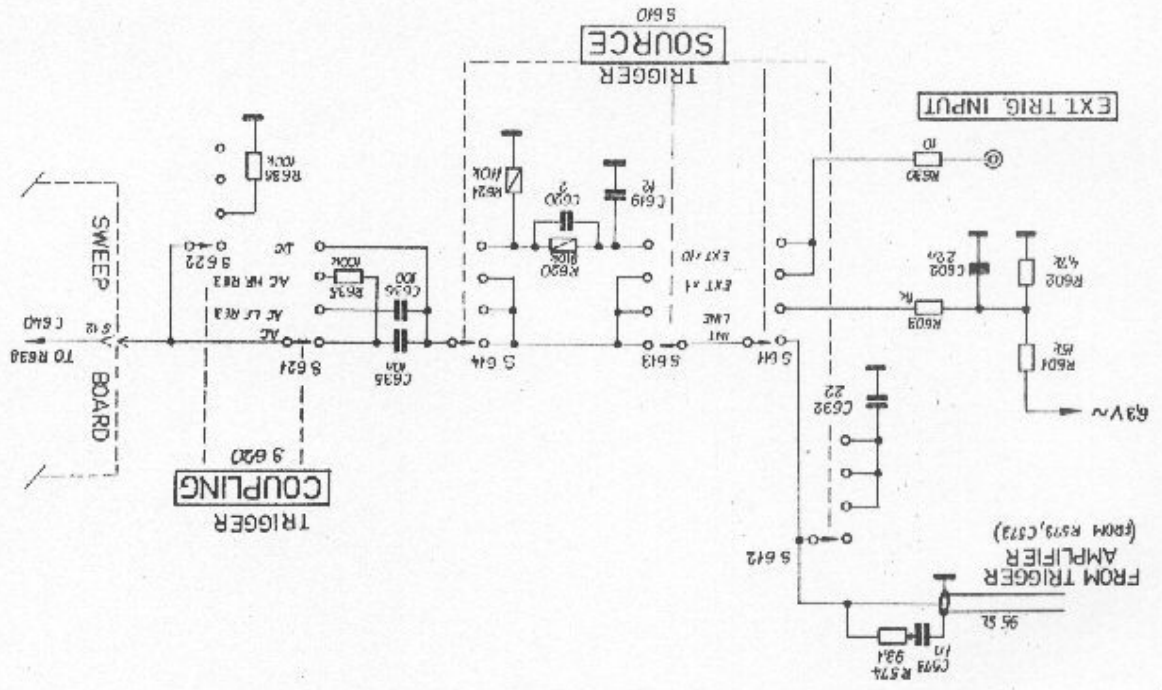
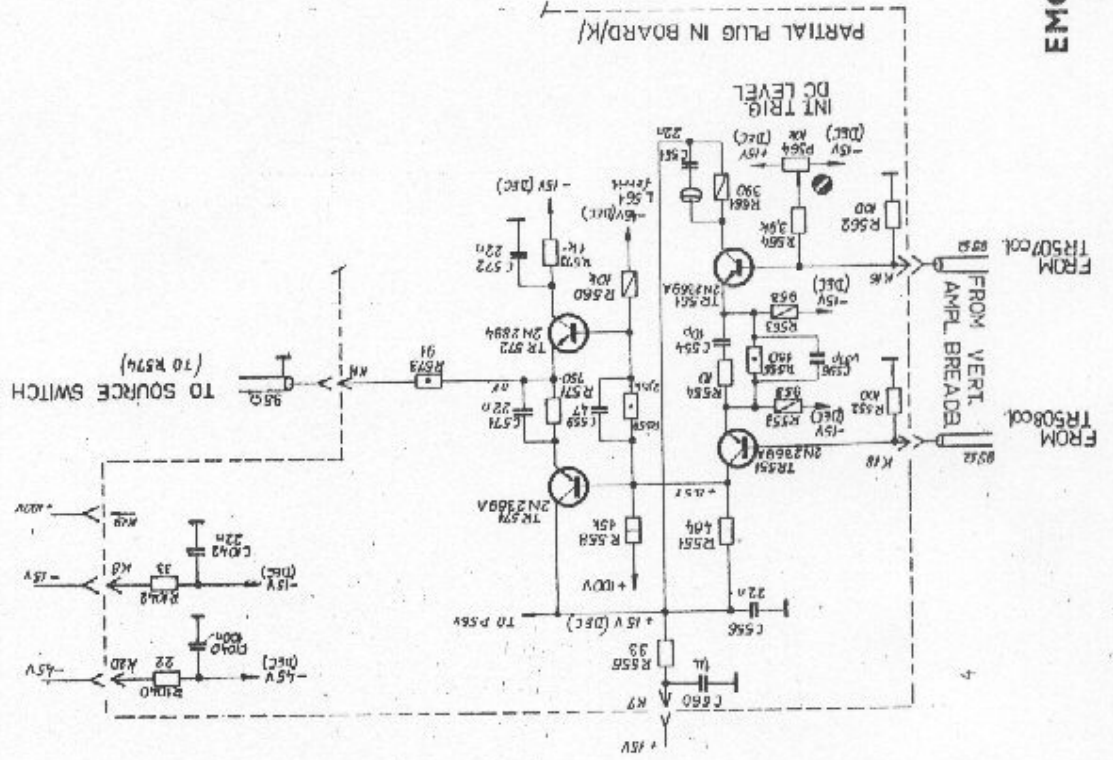

BF 245C

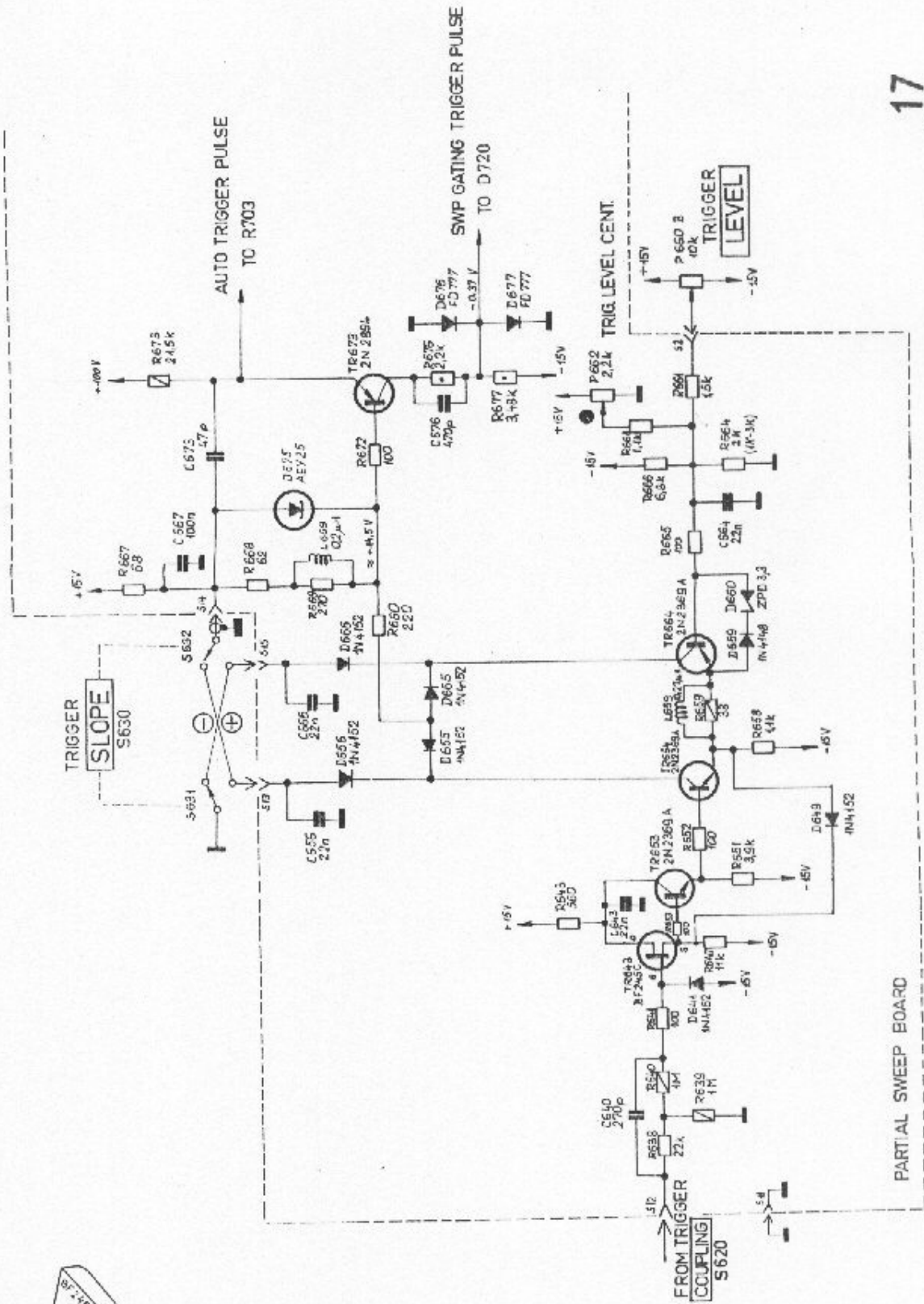
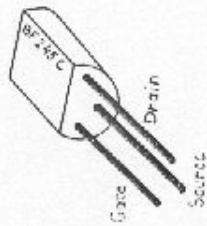

8F 245C

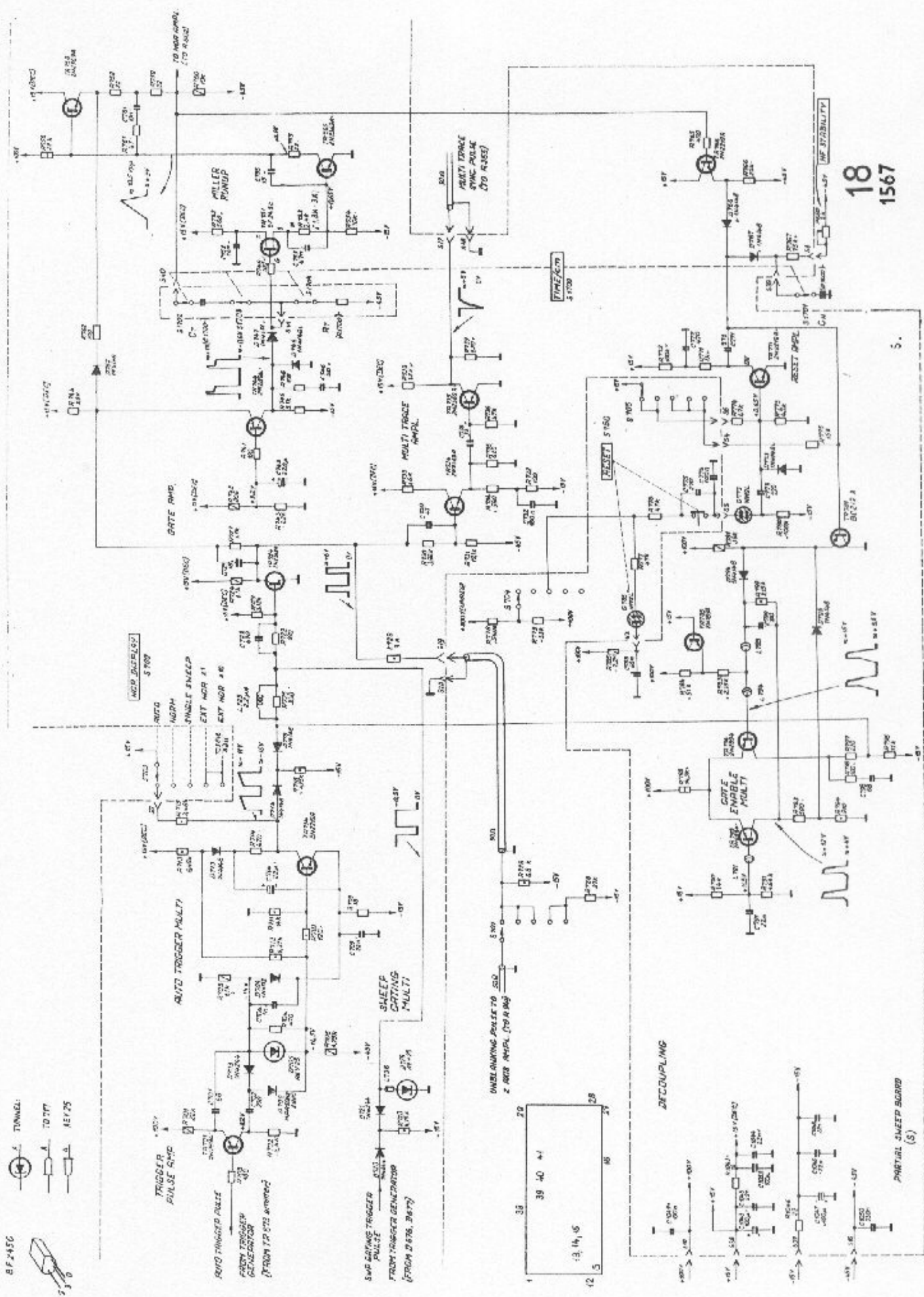

18
1567

5.

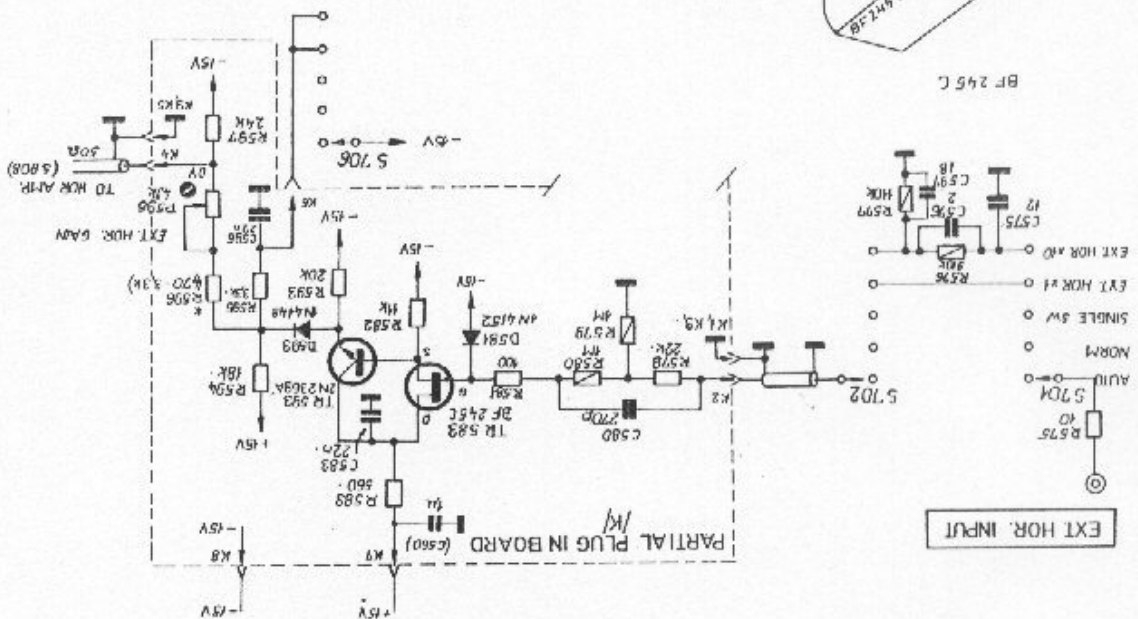
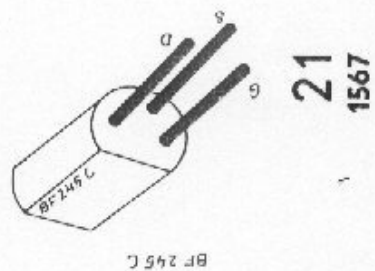
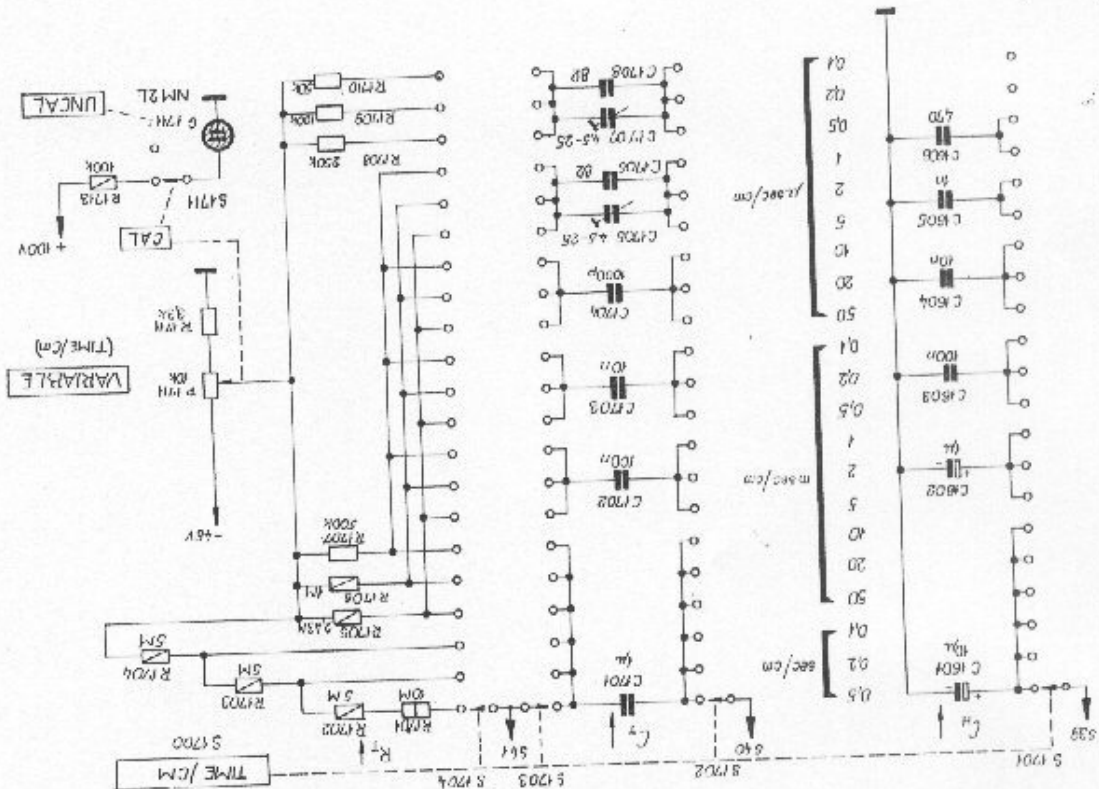

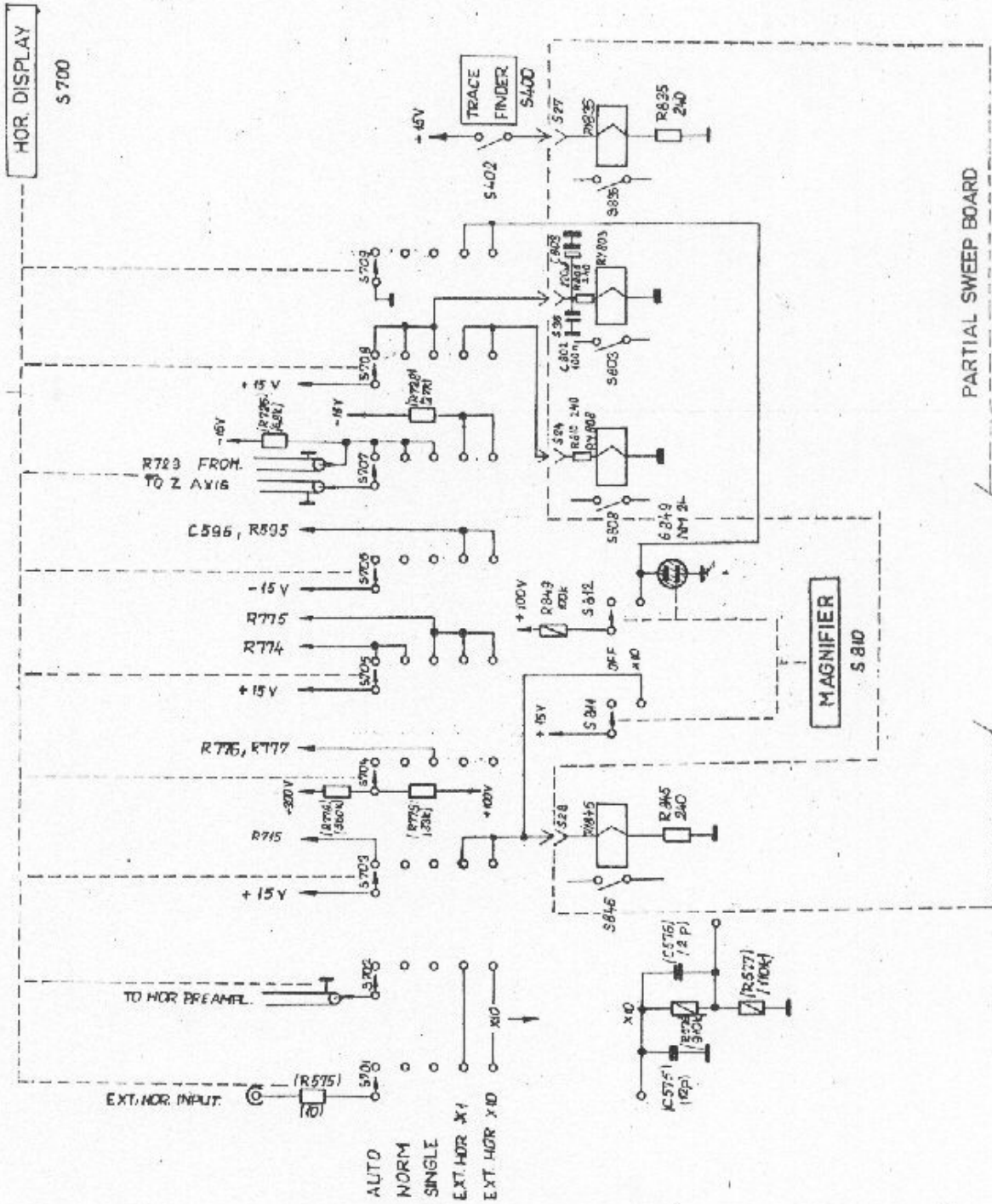

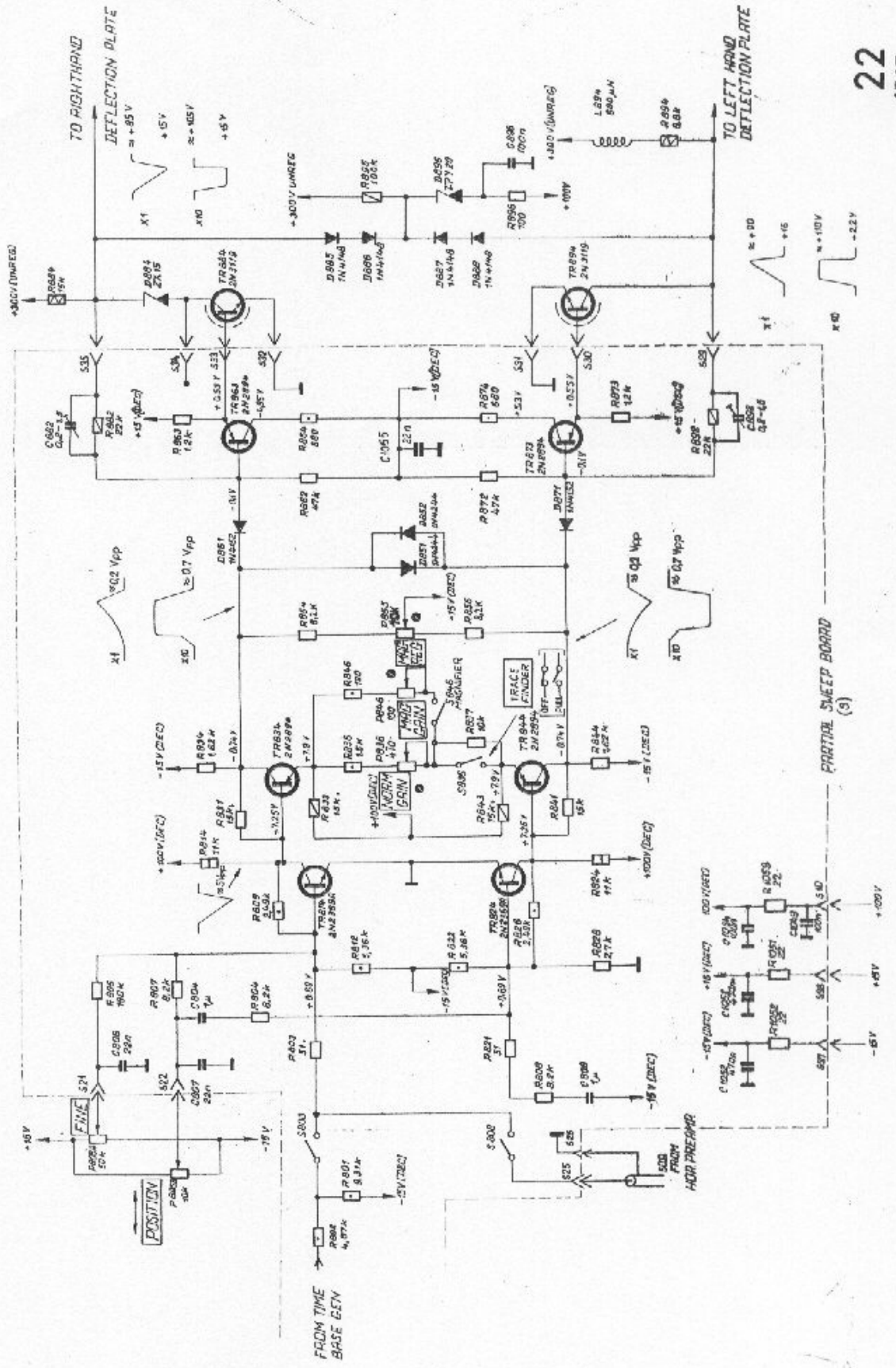

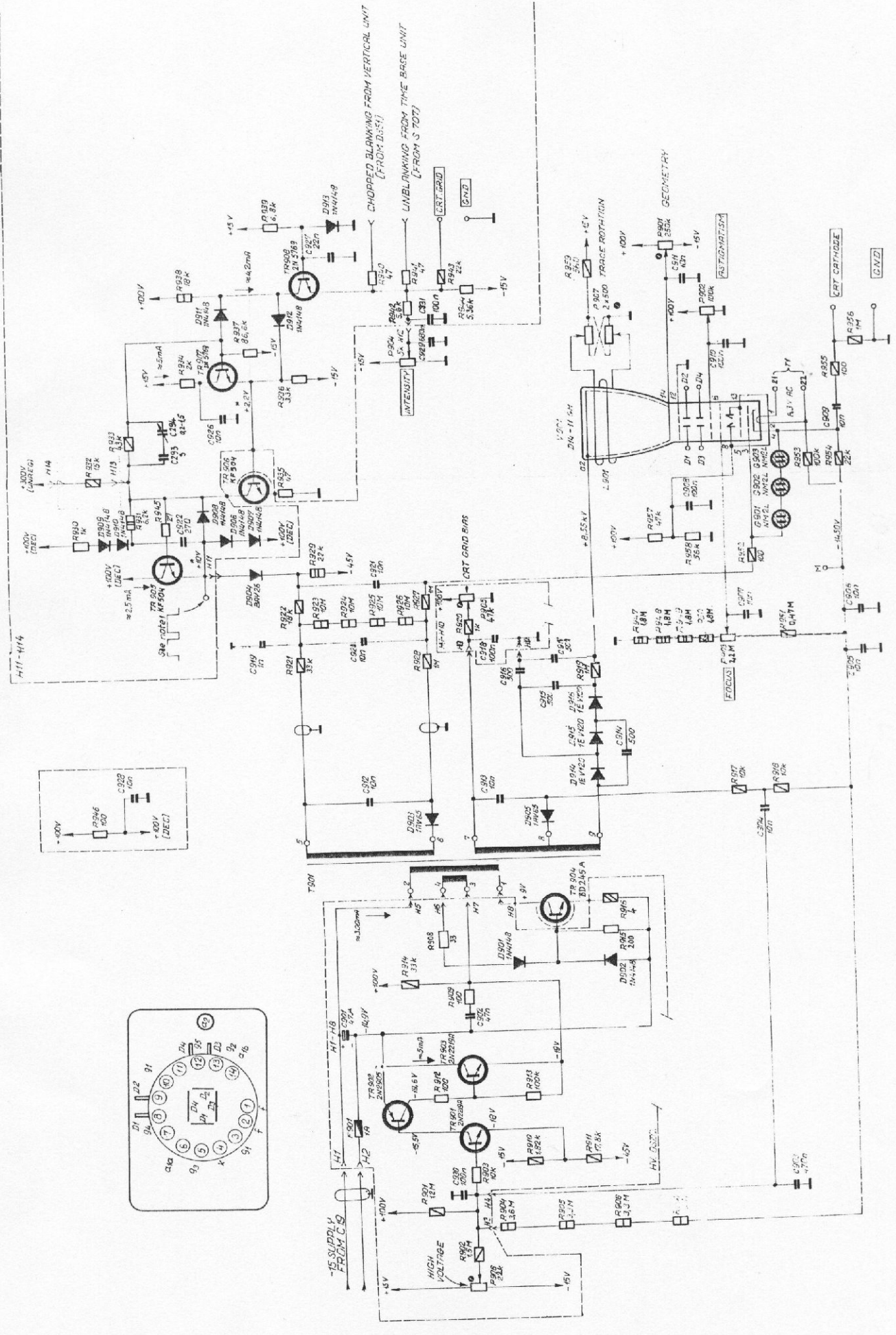

NOTE 1. AMPLITUDE VARIES WITH INTENSITY
SETTING. PEAK LIMITS ARE ABOUT
+10 AND -100 VOLTS.
* INTENSITY FULLY ON.