

For the benefit and convenience of its customers, Fluke Corporation (Fluke) has reproduced this copy of a manual which is no longer in production. This manual has not been edited or updated since the revision date shown on the lower left hand corner of the first page. Fluke will not be liable for any claims, losses or damages of any kind incurred by any user arising from use of this manual.

FLUKE

70 Series

Multimeters

Service Manual

P/N 731034

January 1984 Rev. 1, 5/89

© 1989 John Fluke Mfg. Co., Inc., All rights reserved. Litho in U.S.A.

FLUKE

FLUKE 70 SERIES

LIMITED WARRANTY

John Fluke Mfg. Co., Inc., (Fluke) warrants each instrument it manufactures to be free from defects in material and workmanship under normal use and service for the period of 3 years from date of purchase. This warranty extends only to the original purchaser and shall not apply to batteries, fuses, or any instrument which has been subjected to misuse, neglect, accident or abnormal conditions of operation.

Fluke's obligation under this warranty is limited to repairing or replacing, at Fluke's option, an instrument returned to an authorized Service Center within 3 years of the date of purchase, provided Fluke determines that the product fails to conform to this warranty. If the failure has been caused by misuse, alteration or abnormal condition of operation, repairs will be billed at a nominal cost.

ANY IMPLIED WARRANTIES OF MERCHANTABILITY SHALL BE LIMITED TO A PERIOD OF TWELVE MONTHS FROM THE DATE OF PURCHASE. THE FOREGOING WARRANTY IS EXCLUSIVE AND IN LIEU OF ALL OTHER WARRANTIES, EXPRESS OR IMPLIED, INCLUDING BUT NOT LIMITED TO ANY WARRANTY OF MERCHANTABILITY OR FITNESS FOR ANY PARTICULAR PURPOSE. FLUKE SHALL NOT BE LIABLE FOR ANY SPECIAL, INCIDENTAL OR CONSEQUENTIAL DAMAGES, WHETHER IN CONTRACT, TORT OR OTHERWISE.

NOTE (USA only): Some states do not allow limitations on how long an implied warranty lasts, or the exclusion or limitation of incidental or consequential damages, so the above limitations or exclusion may not apply to you. This warranty gives you specific legal rights, and you may have other rights which vary from state to state.

If a failure occurs, forward the instrument, postage prepaid, to the closest Service Center with a description of the difficulty. Service Center locations are listed in the Operator's Manual. Repairs will be made at the Service Center and the instrument returned, transportation prepaid. The instrument should be shipped in the original packing carton or in a suitable, rigid container. Fluke shall assume NO risk for damage in transit.

Table of Contents

SECTION	TITLE	PAGE
1	INTRODUCTION AND SPECIFICATIONS	1-1
	1-1. INTRODUCTION	1-1
	1-2. SPECIFICATIONS	1-1
2	OPERATING INSTRUCTIONS	2-1
	2-1. INTRODUCTION	2-1
3	THEORY OF OPERATION	3-1
	3-1. INTRODUCTION	3-1
	3-2. OVERVIEW	3-1
	3-3. DETAILED DESCRIPTION	3-1
	3-4. Input Signal Conditioning	3-1
	3-5. Ohms Input Protection	3-1
	3-6. Additional Circuitry	3-1
4	MAINTENANCE	4-1
	4-1. INTRODUCTION	4-1
	4-2. PWB ACCESS AND GENERAL MAINTENANCE	4-1
	4-3. DISPLAY ACCESS	4-2
	4-4. CLEANING	4-2
	4-5. PERFORMANCE TESTS	4-3
	4-6. Initial Procedure	4-3
	4-7. Display Test	4-3
	4-8. AC Voltage Test	4-3
	4-9. DC Voltage Test	4-3
	4-10. Resistance Test	4-3
	4-11. Diode Test	4-4
	4-12. DC mA Test (75 & 77 Only)	4-4
	4-13. DC Amps Test	4-4
	4-14. CALIBRATION	4-5
	4-15. TROUBLESHOOTING	4-5
	4-16. Overall System Check	4-5
	4-17. VDC Signal Tracing	4-5

TABLE OF CONTENTS, *continued*

SECTION	TITLE	PAGE
5	LIST OF REPLACEABLE PARTS	5-1
	5-1. INTRODUCTION	5-1
	5-2. HOW TO OBTAIN PARTS	5-1
6	GENERAL INFORMATION	6-1
	6-1. INTRODUCTION	6-1
7	SCHEMATIC DIAGRAMS	7-1
8	MANUAL CHANGE INFORMATION	8-1

List of Tables

TABLE	TITLE	PAGE
3-1.	S1 Function Codes	3-1
4-1.	Recommended Test Equipment	4-1
4-2.	AC Voltage Test	4-4
4-3.	DC Voltage Test	4-4
4-4.	Resistance Test	4-4
4-5.	DC mA Test	4-5
4-6.	DC Amps Test	4-5
4-7.	Fault Guide	4-6
7-1.	Abbreviations	7-1

List of Illustrations

FIGURE	TITLE	PAGE
3-1.	Overview	3-1
3-2.	Ohms Function	3-1
4-1.	Display Assembly	4-3
4-2.	Display Test	4-3
7-1.	A1 Main PCA	7-2



static awareness



A Message From
John Fluke Mfg. Co., Inc.

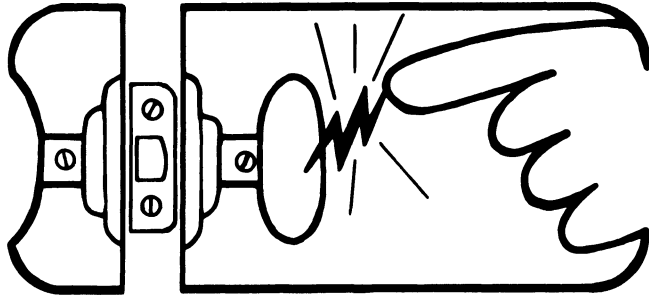

Some semiconductors and custom IC's can be damaged by electrostatic discharge during handling. This notice explains how you can minimize the chances of destroying such devices by:

1. Knowing that there is a problem.
2. Learning the guidelines for handling them.
3. Using the procedures, and packaging and bench techniques that are recommended.

The Static Sensitive (S.S.) devices are identified in the Fluke technical manual parts list with the symbol



The following practices should be followed to minimize damage to S.S. devices.

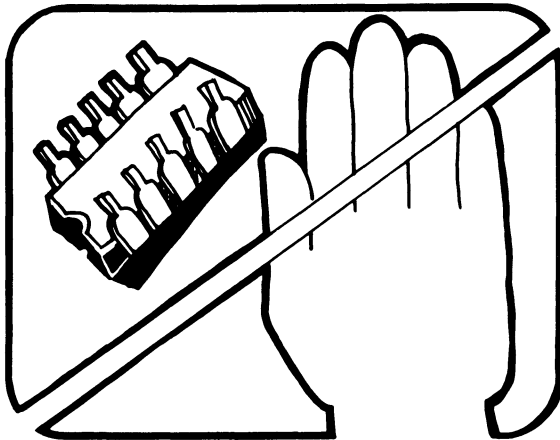

1. MINIMIZE HANDLING

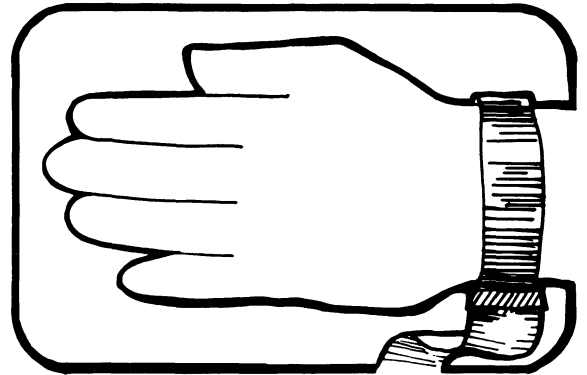

3. DISCHARGE PERSONAL STATIC BEFORE HANDLING DEVICES. USE A HIGH RESISTANCE GROUNDING WRIST STRAP.

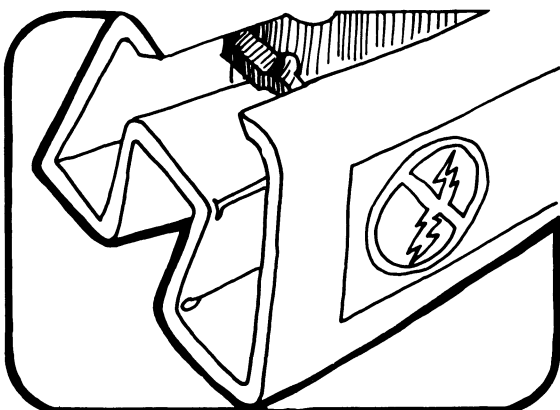

2. KEEP PARTS IN ORIGINAL CONTAINERS UNTIL READY FOR USE.

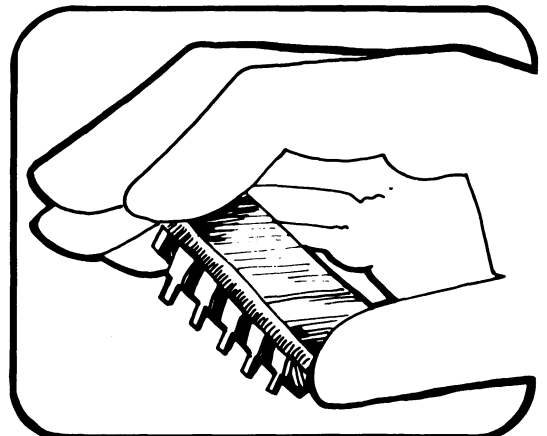

4. HANDLE S.S. DEVICES BY THE BODY

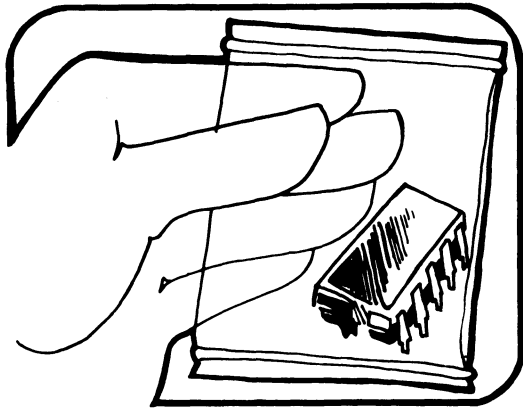

5. USE STATIC SHIELDING CONTAINERS FOR HANDLING AND TRANSPORT

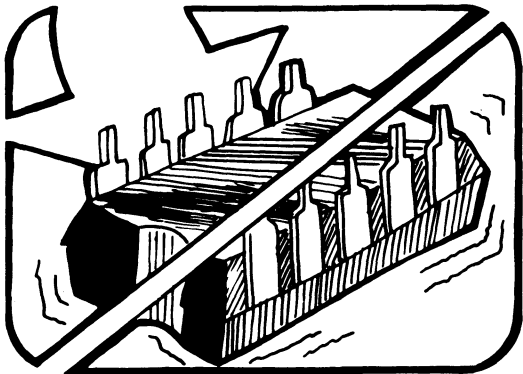

6. DO NOT SLIDE S.S. DEVICES OVER ANY SURFACE

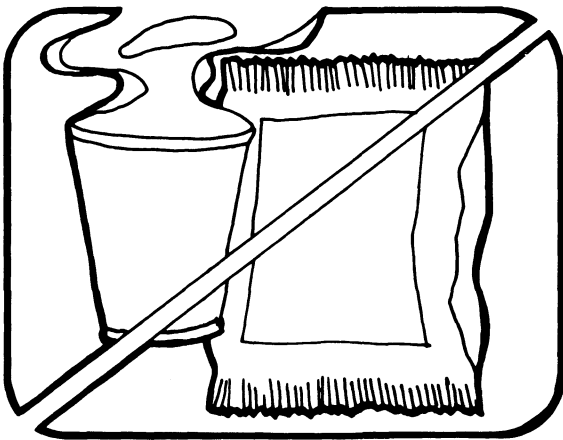

7. AVOID PLASTIC, VINYL AND STYROFOAM® IN WORK AREA

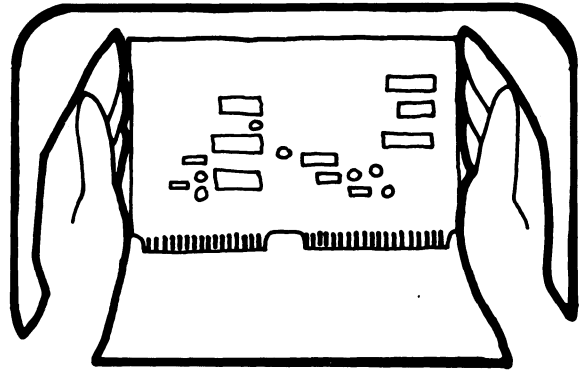

8. WHEN REMOVING PLUG-IN ASSEMBLIES, HANDLE ONLY BY NON-CONDUCTIVE EDGES AND NEVER TOUCH OPEN EDGE CONNECTOR EXCEPT AT STATIC-FREE WORK STATION. PLACING SHORTING STRIPS ON EDGE CONNECTOR HELPS TO PROTECT INSTALLED SS DEVICES.

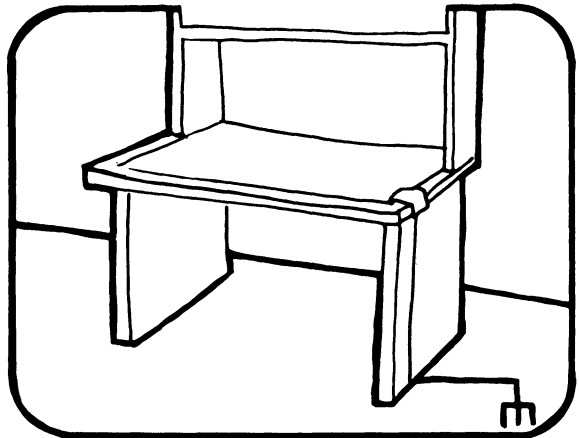

9. HANDLE S.S. DEVICES ONLY AT A STATIC-FREE WORK STATION
10. ONLY ANTI-STATIC TYPE SOLDER-SUCKERS SHOULD BE USED.
11. ONLY GROUNDED TIP SOLDERING IRONS SHOULD BE USED.

A complete line of static shielding bags and accessories is available from Fluke Parts Department, Telephone 800-526-4731 or write to:

JOHN FLUKE MFG. CO., INC.
PARTS DEPT. M/S 86
9028 EVERGREEN WAY
EVERETT, WA 98204

PORTIONS REPRINTED
WITH PERMISSION FROM TEKTRONIX, INC.
AND GENERAL DYNAMICS, POMONA DIV.

Section 1

Introduction and Specifications

1-1. INTRODUCTION

This manual presents service information for the Fluke 73, 75, and 77 Multimeters. Included are a theory of operation, general maintenance procedures, performance tests, calibration procedures, troubleshooting information, a list of replaceable parts, and a schematic diagram.

1-2. SPECIFICATIONS

For instrument specifications, refer to the Operator's Manual provided with the instrument at time of purchase.

Section 2

Operating Instructions

2-1. INTRODUCTION

For operating instructions, refer to the Operator's Manual provided with the instrument at time of purchase.

Section 3

Theory of Operation

3-1. INTRODUCTION

This section contains a brief overview of the 70 Series Multimeters, followed by a more detailed explanation of operation.

3-2. OVERVIEW

The heart of the instrument is made up of a two-chip CMOS system: U1, a primarily analog IC, and U2, a calculator-style microcomputer. (See Figure 3-1.)

The analog chip, U1, contains the A/D converter and additional circuitry for autorange switching and signal conditioning. With most of the analog circuitry on U1, the off-chip signal conditioning is at the simplest possible level. Peripherals to U1 include function switching, voltage reference and the crystal.

The microcomputer, U2, controls the A/D converter function and range switching, reads and formats the A/D samples, and drives the liquid crystal display (LCD).

3-3. DETAILED DESCRIPTION

The following paragraphs describe the 70 Series Multimeters in more detail. While reading this description, refer to the schematic in Section 7. (The schematic covers all three models.)

3-4. Input Signal Conditioning

Since the A/D conversion process is essentially a dual slope method, two input voltages are required to complete a measurement cycle. One is the unknown input and the other is the reference voltage.

Conditioned input signals are routed to the A/D in U1, where they are integrated. The reference voltage, developed by reference supply VR1, R15, R16, and R8, is routed to the A/D in U1, where it is used for the de-integrate portions of the measurement cycle.

Input voltage signal conditioning is accomplished with input divider Z1 and dc blocking capacitor C1, with pin 1 of Z1 as the input, pin 3 as the 3.2V tap, pin 4 as the 32V tap, pin 5 as the 320V tap, and pin 6 as the 1000V tap. Overvoltage protection is supplied by E1, E2, R1, R2, and RJ1. E1 and E2 are spark gaps that fire between 1200 and 1800V, and R1 is a fusible wirewound resistor that will open with excessive inputs.

Current input conditioning is achieved by R6, R7, R5, and R13. R6 and R7 develop the input voltage from the applied current, and R5 and R13 act as an input divider for the 300 mA range. F1 and R20 are for overcurrent protection in the mA ranges. F3 is used for overcurrent protection in the 10A input circuitry.

In the ohms function (Figure 3-2), the unknown resistance at J1 is compared to the reference resistors in Z1. This is accomplished by driving current from the ohms voltage source through the reference resistors and the unknown resistance Rx. The developed voltage drops, V1 and V2, are used for ratiometric ohms conversion within the analog chip U1.

3-5. Ohms Input Protection

(Refer to schematic in Section 7.) Input protection for the ohms ranges consists of Q1, Q2, Q3, R2, R3, R4, and RT1. Q1 and Q2 serve as back-to-back zener diodes which limit the input to between 7 and 9V. RT1 is a thermistor which normally has about 1 k Ω of resistance but increases to very high impedance as it heats up. Also, R2, R3, and R4 limit current, and Q3 clamps pin 29 of U1 to approximately 2.5V.

3-6. Additional Circuitry

(Refer to schematic in Section 7.) The ratio of R17 and R18 determine ac voltage and current accuracy, and C11 is the averaging capacitor for the ac converter portion of U1.

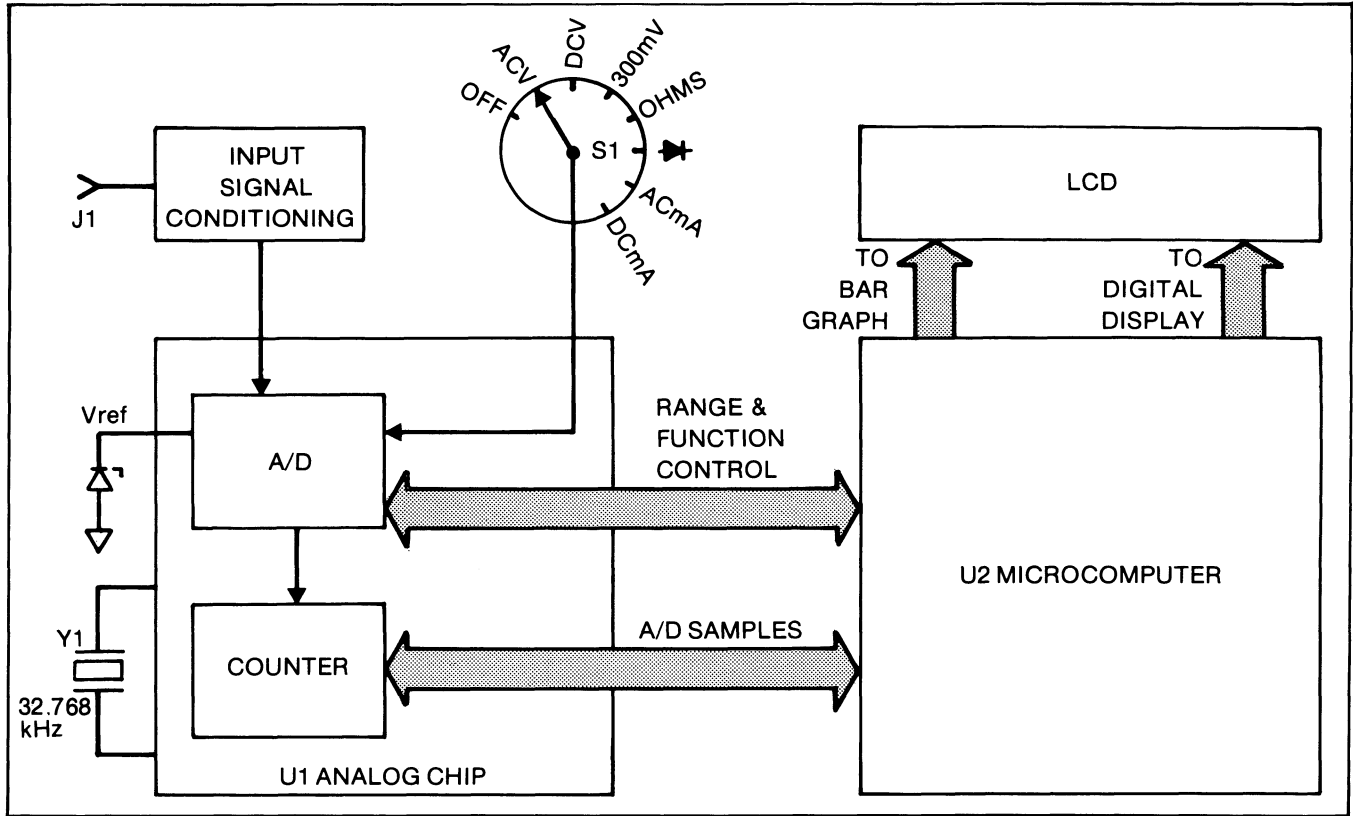

Figure 3-1. Overview

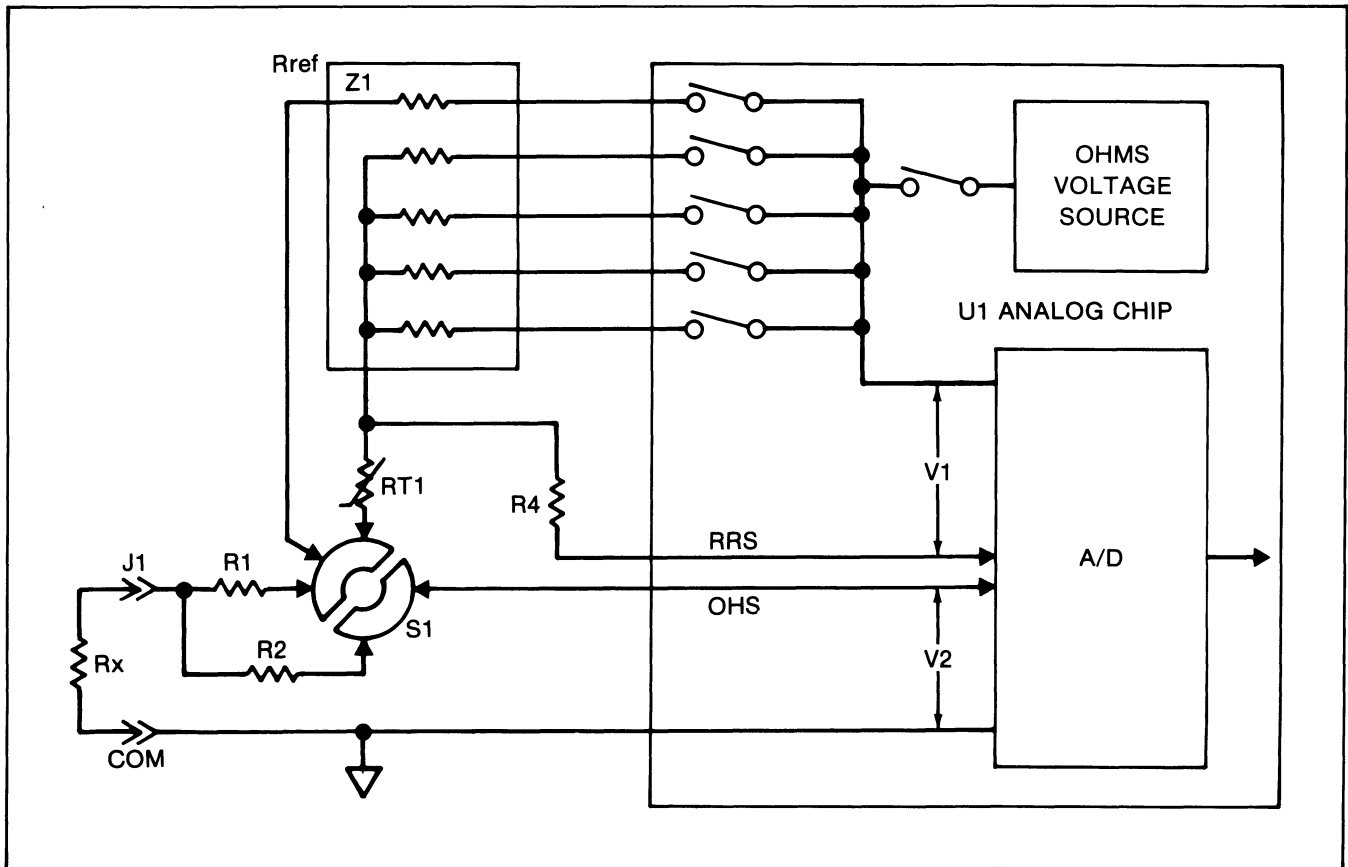

Figure 3-2. Ohms Function

R9, R10, C5 and C6 are part of the active filter located in U1. Conditioned input signals are passed through the active filter in route to the A/D section of U1.

The clock frequency for the digital portion of the circuit is a function of 32.768 kHz crystal Y1. Y1, C12, and amplifiers in U1 make up the oscillator circuit.

C7 stores offsets of the buffer, integrator, and comparator amplifiers of the A/D. The gain of the buffer is determined by the resistors of Z1 between pins 8, 9, and 10. C8 is the integrator capacitor.

Rotary switch S1 FRONT selects and routes the input signals. Function codes for switch S1 REAR are shown in Table 3-1. Range switch S2 signals the microcomputer U2 for the Touch Hold function (77 only) and the Range Hold function (75 and 77 only).

CR1 acts as protection for U1 if the battery is installed backwards. C2 is part of the power-on reset for microcomputer U2.

Table 3-1. S1 Function Codes

FUNCTION	B0	B1	B2
ACV	1	1	1
DCV	0	1	1
300mV	0	0	0
Ohms	0	0	1
▶ ()))	1	0	0
ACA	1	1	0
DCA	0	1	0
1 = VDD 0 = ⏚ (Common)			

Section 4 Maintenance

WARNING

THESE SERVICE INSTRUCTIONS ARE FOR USE BY QUALIFIED PERSONNEL ONLY. TO AVOID ELECTRIC SHOCK, DO NOT PERFORM ANY SERVICING OTHER THAN THAT CONTAINED IN THE OPERATOR'S MANUAL UNLESS YOU ARE QUALIFIED TO DO SO.

4-1. INTRODUCTION

This section contains maintenance information for the Fluke 73, 75 and 77, including performance tests, calibration, general maintenance procedures, and troubleshooting. For operator maintenance and instrument specifications, refer to the Operator's Manual.

The performance tests are recommended as a preventive maintenance tool to verify proper instrument operation. A one year calibration cycle is recommended to maintain the specifications given in the Operator's Manual. Test equipment required for the performance tests and calibration is listed in Table 4-1. If the recommended equipment is not available, instruments with equivalent specifications may be used.

4-2. PCA ACCESS AND GENERAL MAINTENANCE

WARNING

TO AVOID ELECTRICAL SHOCK, REMOVE TEST LEADS BEFORE OPENING CASE, AND CLOSE CASE BEFORE OPERATING METER. TO PREVENT FIRE, INSTALL FUSES WITH RATING SHOWN ON BACK OF METER.

CAUTION

To avoid contaminating the pca with oil from the fingers, handle it by the edges or wear gloves. PCA contamination may not cause immediate instrument failure in controlled environments. Failures typically show up when contaminated units are operated in humid areas.

Use the following procedure for removing the pca (printed circuit assembly) from its case:

1. Set the function switch to OFF and disconnect test leads if installed.
2. Remove the four Phillips screws from the bottom cover.
3. Turn the meter face up, grasp the top cover, and pull the top cover from the meter.
4. Some 70 Series meters have a fuse on the lower portion of the pca. This fuse must be removed to access the screw that holds the pca to the case bottom. **BE CAREFUL NOT TO LOSE THE SPRING LOCATED DIRECTLY UNDER**

THE SCREW ON THE BACK SIDE OF THE PCA.

- The pca may now be removed from the bottom cover.

4-3. DISPLAY ACCESS

CAUTION

Do not handle the conductive edges of the LCD interconnects. If contaminated, clean with isopropyl alcohol.

Refer to Figure 4-1.

- Remove the four Phillips screws from the back side of the pca.
- Remove the LCD mounting bracket.
- Insert a small screwdriver under the edges of the display holding bracket, and gently pry the bracket loose from the snaps.
- Turn the bracket upside down to remove the LCD.
- Before installing a new LCD, make sure that all connector contact points are clean.

4-4. CLEANING

CAUTION

To avoid damaging the meter, do not use aromatic hydrocarbons or chlorinated solvents for cleaning. These solutions will react with the plastics used in the instruments.

Do not allow the liquid crystal display to get wet. Remove the display assembly before washing the pca and do not install until the pca is completely dry.

Do not use detergent of any kind for cleaning the pca.

Do not remove lubricants from the switch when cleaning the pca.

Clean the instrument case with a mild detergent and water.

The pca may be washed with isopropyl alcohol or deionized water and a soft brush. Remove the display assembly and fuses before washing, and avoid washing the switch if possible. Dry with clean dry air at low pressure and then bake at 50°C for 24 hours.

Table 4-1. Recommended Test Equipment

INSTRUMENT TYPE	REQUIRED CHARACTERISTICS	RECOMMENDED MODEL
PREFERRED		
DMM Calibrator	John Fluke 5100B Family	John Fluke Models 5100B, 5101B or 5102B
ALTERNATE		
AC Calibrator	Voltage Range: 0-750V ac ± 0.3% Frequency Range: 40-1000 Hz ± 3%	John Fluke Models 5200A and 5215A
DC Voltage Calibrator	Voltage Range: 0-1000V dc Accuracy: ± .03%	John Fluke Model 343A
DC Current Calibrator	Current Range: 2 mA - 2A Accuracy: ± .15%	John Fluke Model 382A
Decade Resistor	Resistance Values: 100Ω, 1 kΩ, 10 kΩ, 100 kΩ, 1 MΩ, 10 MΩ, Accuracy: ± .1% Power Rating: 1/8 W	ESI Model DB 62

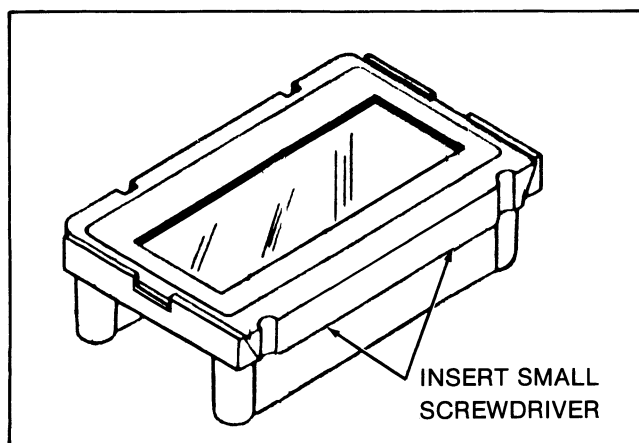

Figure 4-1. Display Assembly

4-5. PERFORMANCE TESTS

Performance tests are recommended for incoming inspection, periodic maintenance, and for verifying the specifications in the Operator's Manual. If the instrument fails any part of the test, calibration and/or repair is indicated.

In the performance tests, the Fluke 70 Series Multimeter is referred to as the unit under test (UUT).

4-6. Initial Procedure

1. Allow the UUT to stabilize to room temperature $23^{\circ}\text{C} \pm 5^{\circ}\text{C}$ ($73^{\circ}\text{F} \pm 9^{\circ}\text{F}$).
2. Check the fuses and battery and replace if necessary.

WARNING

TO PREVENT FIRE, INSTALL FUSES WITH RATING SHOWN ON BACK OF METER.

4-7. Display Test

To test the display, turn the UUT on and check whether all display segments come on as indicated in Figure 4-2.

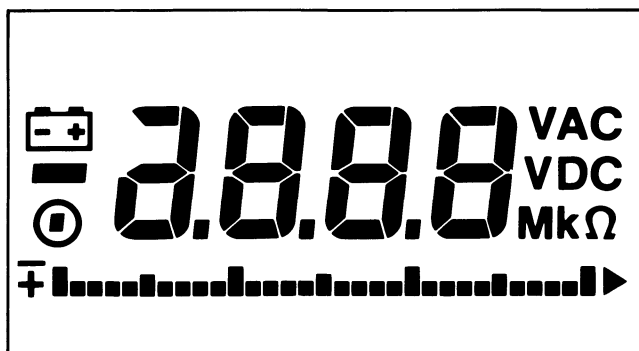

Figure 4-2. Display Test

4-8. AC Voltage Test

WARNING

CONNECT THE GROUND/Common/LOW SIDE OF THE AC CALIBRATOR TO COMMON ON THE UUT.

1. Put the UUT function switch to VAC and connect the AC Calibrator to the V-Ohm and Common input terminals.
2. Set the AC Calibrator for the output given in Table 4-2 and verify that the UUT display reading is within the limits shown.

NOTE

When the input is open in the VAC function, it is normal for the 70 Series Multimeters to read some counts on the display. This is due to ac pickup in the ac amplifier when the ac amplifier is unterminated.

4-9. DC Voltage Test

WARNING

CONNECT THE GROUND/Common/LOW SIDE OF THE DC CALIBRATOR TO COMMON ON THE UUT.

1. Put the UUT function switch to VDC and connect the DC Voltage Calibrator output to the V-Ohm and Common input terminals of the UUT.
2. Referring Table 4-3, set the DC Voltage Calibrator for the output indicated in steps 1 through 4 only. Verify that the UUT display reading is within the limits shown.
3. Set the DC Voltage Calibrator for an output of +300 mV, and switch the UUT to the 300 mV function. Verify that the UUT display reading is within the limits shown in Table 4-3 (step 5).

4-10. Resistance Test

1. Select the ohms function on the UUT.
2. Connect the Fluke 5100B or Decade Resistor to the V-Ohm and Common input terminals of the UUT.

- Referring to Table 4-4, set the Decade Resistor or Fluke 5100B to the resistance value indicated in steps 1 through 6. Verify that the display reading is within the limits shown.

To test the 73 meter, apply an input from the DC Voltage Calibrator of +2V dc to the V-Ohm and Common input terminals of the UUT. Verify that the display reading is between +1.960 and +2.040.

4-11. Diode Test

To test the 75 and 77 meters, perform the following steps:

- Put the UUT in the Diode Test function.

NOTE

On Fluke 5100 series calibrators, activate the 50Ω divider override.

- Apply an input from the DC Voltage Calibrator of +.090V dc to the V-Ohm and Common input terminals of the UUT and verify that the beeper is on.
- Increase the DC Voltage Calibrator output to +.110V dc and verify that the beeper is off.

4-12. DC mA Test (75 & 77 Only)

- Set the output of the DC Current Calibrator to zero and connect it to the 300 mA and Common input terminals of the UUT.
- Set the DC Current Calibrator to the output shown in Table 4-5, and verify that the UUT display reading is within the limits shown.

4-13. DC Amps Test

- Set the DC Current Calibrator for zero output and connect it to the 10A & Common input terminals of the UUT.
- Apply currents as indicated in Table 4-6 and verify the display reading is within the limits shown.

Table 4-2. AC Voltage Test

STEP	INPUT		DISPLAY READING		
	VOLTAGE	FREQ.	73	75	77
1	2.7V	100 Hz	2.617 to 2.783	2.644 to 2.756	2.644 to 2.756
2	2.7V	500 Hz	2.617 to 2.783	2.644 to 2.756	2.644 to 2.756
3	750V	100 Hz	725 to 775	733 to 767	733 to 767
4	750V	1000 Hz	725 to 775	733 to 767	733 to 767

Table 4-3. DC Voltage Test

STEP	DC INPUT VOLTAGE	DISPLAY READING		
		73	75	77
1	+2.7V	2.680 to 2.720	2.685 to 2.715	2.691 to 2.709
2	+27V	26.80 to 27.20	26.85 to 27.15	26.91 to 27.09
3	+270V	268.0 to 272.0	268.5 to 271.5	269.1 to 270.9
4	+1000V	991 to 1009	993 to 1007	995 to 1005
5*	+300 mV	297.8 to 302.2	298.4 to 301.6	299.0 to 301.0

*300mV function only

Table 4-4. Resistance Test

STEP	INPUT RESISTANCE	DISPLAY READING		
		73	75	77
1	100Ω	98.8 to 101.2	99.1 to 100.9	99.3 to 100.7
2	1000Ω	989 to 1011	992 to 1008	994 to 1006
3	10 kΩ	9.89 to 10.11	9.92 to 10.08	9.94 to 10.06
4	100 kΩ	98.9 to 101.1	99.2 to 100.8	99.4 to 100.6
5	1 MΩ	.989 to 1.011	.992 to 1.008	.994 to 1.006
6	10 MΩ	9.69 to 10.31	9.74 to 10.26	9.79 to 10.21

Table 4-5. DC mA Test

STEP	INPUT CURRENT	DISPLAY READING
		75 & 77
1	+27 mA	26.58 to 27.43
2	+200 mA	195.8 to 204.2

Table 4-6. DC Amps Test

STEP	INPUT CURRENT (5100B)	DISPLAY READING	
		73	75 & 77
1	+1.99999A dc	1.94 to 2.06	1.95 to 2.05

4-14. CALIBRATION

1. Set the DC Voltage Calibrator to zero and set the UUT to the VDC function.
2. Connect the DC Voltage Calibrator to the V-Ohm and Common input terminals of the UUT.
3. Set the DC Voltage Calibrator for an output of +3V dc and adjust R8 for a display reading of +3.000V dc \pm .001V.

4-15. TROUBLESHOOTING

A fault guide for the 70 Series Multimeters is given in Table 4-7. This guide can be helpful in isolating troubles to a component area. Also, procedures are given below to help isolate the troubles further. In these procedures, the 70 Series Multimeter is referred to as the unit under test (UUT).

When troubleshooting the 70 Series Multimeters, use the precautions listed on the static awareness sheet to prevent damage from static discharge.

4-16. Overall System Check

Make the following checks in the order listed. All measurements are made with respect to common.

1. Put the UUT function switch in the VDC position.
2. Using a DVM, check +VDD (TP-1) or the positive battery post for 3.1V dc \pm .1V.

Probable failure: BT1, CR1, U1, loose battery connector

3. Connect an oscilloscope or counter to pin 54 of U1 or to the junction of C12 and Y1 crystal. Check for a 32.768 kHz sine wave approximately 600 mV p-p in amplitude. Note

that U2 and the display will not work if the clock circuit is not working.

Probable failure: U1, Y1, or C12

4. Check for a reference voltage of 1.00V dc (adjustable by R8) at pin 14 of U1 or the junction of R15 and R16.

Probable failure: R8, R14, R15, R16, VR1, or CR2

5. Check that VM (V middle) is 1.6V dc \pm .1V at pin 28 of U2 or at the junction of R11 and R12.

Probable failure: R11, R12 or C10

4-17. VDC Signal Tracing

Make the following checks in the order listed. All measurements are made with respect to common.

1. Put the UUT in the VDC function and apply 2V dc to the input.
2. Using a DVM, measure the input at J1 for 2V dc.
3. Measure pin 1 of Z1 input divider for 2V dc.

Probable failure: R1, S1, E1

WARNING

R1 IS A FUSIBLE RESISTOR. TO ENSURE SAFETY, USE EXACT REPLACEMENT ONLY.

NOTE

Measurements in steps 4, 5, and 6 may be affected by loading.

4. Measure Z1 pin 3 for 200 mV dc.

Probable failure: Z1, U1

5. Measure for 200 mV dc at the active filter input (AFI, pin 26 of U1 or R9).

Probable failure: U1

6. Measure for 200 mV at the active filter output (AFO, pin 27 of U1 or R9).

Probable failure: R9, C5 or C6

Table 4-7. Fault Guide

SYMPTOM	ACTION	POSSIBLE COMPONENT
Blank display	Follow overall system check (paragraph 4-16)	BT1, U1, U2, Y1, CR1, C12
Display reads zero in volts function	Trace DC signal (paragraph 4-17)	E1, R1, Z1, R9, U1, S1
Display hangs up in power-up self test (see Figure 4-2)	Follow overall system check (paragraph 4-16)	R14, R8, R15, R16, VR1, C7, C8, Z1, CR2, U1
Display reads OL or zero in 300mA		R13, U1
Display reads zero in 300mA or 10A current ranges		F1, F3, R5, R13, R20
AC volts is not accurate		R17 & R18
Display reads OL in 300mV range		Q3 shorted, U1
AC volts noisy at 50 to 60 Hz		R9, R10, C5, C6
Display has wrong annunciator called	Check Table 3-1 for correct codes	S1 REAR, U1
Volts inaccurate		Check calibration
Ohms inaccurate		Z1, U1
Intermittent display	Clean connectors and connector strips of the LCD and pca	Display assembly
Display reads constant offset in volts		C5, C6, or C7 shorted
Ohms reads low or won't read OL		Q1 or Q2 shorted or leaky, E1, E2
Ohms reads randomly or flashes between on-scale and OL		R1, RT1

Section 5

List of Replaceable Parts

TABLE OF CONTENTS

ASSEMBLY NAME	TABLE		FIGURE	
	NO.	PAGE	NO.	PAGE
73 Final Assembly	5-1	5-3	5-1	5-6
75 Final Assembly	5-2	5-4	5-1	5-6
77 Final Assembly	5-3	5-5	5-1	5-6
73 A1 Main PCA	5-4	5-7	5-2	5-10
75 A1 Main PCA	5-5	5-8	5-2	5-10
77 A1 Main PCA	5-6	5-9	5-2	5-10

5-1. INTRODUCTION

This section contains an illustrated parts breakdown of the 70 Series Multimeters. Both electrical and mechanical parts are listed alphanumerically by reference designator or item number. Each listed component is shown in an accompanying illustration unless otherwise noted.

Parts lists include the following information:

1. Reference designation or item number
2. Description of each part
3. Fluke part number
4. Manufacturer's supply code.
5. Manufacturer's part number.
6. Total quantity of components per assembly.

5-2. HOW TO OBTAIN PARTS

Components may be ordered from John Fluke Mfg. Co., Inc. factory or authorized representative listed in the

Operator's Manual by using the **FLUKE PART NUMBER**. In the event the part your order has been replaced by a new or improved part, the replacement will be accompanied by an explanatory note and installation instructions, if necessary.

To ensure prompt and efficient handling of your order, include the following information:

1. Quantity
2. Fluke part number
3. Description of part
4. The pca part number and revision letter as printed in ink on the board.
5. The reference designation or item number of the part.
6. Instrument model and serial number.



  When servicing, use only specified replacement parts.

Table 5-1. 73 Final Assembly
(See Figure 5-1.)

REF DES ITEM NO	DESCRIPTION	PART NUMBER	MFRS SPLY CODE	MANUFACTURER'S PART NUMBER	QTY
101	Case, Bottom Assembly	828608	89536	835405	1
102	Shield, Bottom	748236	89536	748236	1
111	Spring, Coil, Comp	697227	83553	C0360-026-0500	1
116	Screw, Thd form, 4-24x1/4	519116	COMMERCIAL		1
201	Case, Top Assembly	828624	89536	83537L	1
202	Shield, Top	819300	89536	819300	1
203	Screw, Thd form, 2-14x.375	821140	COMMERCIAL		1
206	Window, LCD	642082	89536	754507	1
207	Bracket, LCD	646653	89536	646653	1
208	Mask, Bracket	642090	89536	642090	1
209	Conn, LCD/PCA, Elastomeric	649632	89536	649632	2
216	Screw, Thd form, 4-14x3/8	448456	COMMERCIAL		4
221	Knob, Switch	661033	89536	661033	1
222	Shaft, Knob	646661	89536	646661	1
223	Spring, Detent	646679	89536	646679	1
226	Shock Absorber	428441	89536	428441	1
241	Screw, Thd form, 5-14x3/4	733410	COMMERCIAL		4
246	Foot, Non-skid	640565	89536	640565	4
301	Decal	828517	89536	828517	1
302	Label, Window - Fluke/Philips	844340	89536	844340	1
U3	LCD, 3.75 digit, Bar Graph	640581	18520	LF-7031G	1
N.S.	Screw, Thd form, 5-14x3/4	733410	COMMEP		4
N.S.	Decal, Warning	828707	89536	828707	1
N.S.	Decal, Warning	828715	89536	828715	1
N.S.	Fluke 73 Operator's Manual	704601	89536	704601	1
N.S.	TL70 Test Leads	642033	89536	642033	1

N.S. = NOT SHOWN

WARNING

FOR SAFETY PURPOSES, CASE TOPS AND CASE BOTTOMS SHOULD NOT BE INTERCHANGED BETWEEN PCA TYPES (i.e., DO NOT USE THE CASE TOP SPECIFIED FOR THE 7X-3001 ON THE 7X-3011, ETC.)

Table 5-2. 75 Final Assembly
(See Figure 5-1.)

REF DES ITEM NO	DESCRIPTION	PART NUMBER	MFRS SPLY CODE	MANUFACTURER'S PART NUMBER	QTY
101	Case, Bottom Assembly	828640	89536	835413	1
102	Shield, Bottom	748236	89536	748236	1
106	AF Transducer, 20mm	642991	72982	7BB-20-6-4	1
107	Contact, Annunciator	642983	89536	642983	1
111	Spring, Coil, Comp	697227	83553	C0360-026-05001	1
116	Screw, Thd form, 4-24x1/4	519116	COMMERCIAL		1
201	Case, Top Assembly	828632	89536	828632	1
202	Shield, Top	819300	89536	819300	1
203	Screw, Thd form, 2-14x.375	821140	COMMERCIAL		1
206	Window, LCD	642108	89536	642108	1
207	Bracket, LCD	646653	89536	646653	1
208	Mask, Bracket	642090	89536	642090	1
209	Conn, LCD/PCA, Elastomeric	649632	89536	649632	2
216	Screw, Thd form, 4-14x3/8	448456	COMMERCIAL		4
221	Knob, Switch	642058	89536	642058	1
222	Shaft, Knob	646661	89536	646661	1
223	Spring, Detent	646679	89536	646679	1
224	Switch, Momentary	643007	89536	643007	1
226	Shock Absorber	428441	89536	428441	1
241	Screw, Thd form, 5-14x3/4	733410	COMMERCIAL		4
246	Foot, Non-skid	640565	89536	640565	4
301	Decal	828509	89536	828509	1
302	Label, Window - Fluke/Philips	844340	89536	844340	1
U3	LCD, 3.75 digit, Bar Graph	640581	18520	LF-7031G	1
N.S.	Screw, Thd form, 5-14x3/4	733410	COMMERCIAL		4
N.S.	Decal, Warning	828707	89536	828707	1
N.S.	Decal, Warning	828715	89536	828715	1
N.S.	Fluke 75/77 Operator's Manual	642025	89536	642025	1
N.S.	TL70 Test Leads	642033	89536	642033	1

N.S. = NOT SHOWN

WARNING

FOR SAFETY PURPOSES, CASE TOPS AND CASE BOTTOMS SHOULD NOT BE INTERCHANGED BETWEEN PCA TYPES (i.e., DO NOT USE THE CASE TOP SPECIFIED FOR THE 7X-3001 ON THE 7X-3011, ETC.)

Table 5-3. 77 Final Assembly
(See Figure 5-1.)

REF DES ITEM NO	DESCRIPTION	PART NUMBER	MFRS SPLY CODE	MANUFACTURER'S PART NUMBER	QTY
101	Case, Bottom Assembly	828640	89536	835413	1
102	Shield, Bottom	748236	89536	748236	1
106	AF Transducer, 20mm	642991	72982	7BB-20-6-4	1
107	Contact, Annunciator	642983	89536	642983	1
111	Spring, Coil, Comp	697227	83553	C0360-02600500	1
116	Screw, Thd form, 4-24x1/4	519116	COMMERCIAL		1
201	Case, Top Assembly	828616	89536	828616	1
202	Shield, Top	819300	89536	819300	1
203	Screw, Thd form, 2-14x.375	821140	COMMERCIAL		1
206	Window, LCD	661314	89536	661314	1
207	Bracket, LCD	646653	89536	646653	1
208	Mask, Bracket	642090	89536	642090	1
209	Conn, LCD/PCA, Elastomeric	649632	89536	649632	2
216	Screw, Thd form, 4-14x3/8	448456	COMMERCIAL		4
221	Knob, Switch	642058	89536	642058	1
222	Shaft, Knob	646661	89536	646661	1
223	Spring, Detent	646679	89536	646679	1
224	Switch, Momentary	680686	89536	680686	1
226	Shock Absorber	428441	89536	428441	1
241	Screw, Thd form, 5-14x3/4	733410	COMMERCIAL		4
246	Foot, Non-skid	640565	89536	640565	4
301	Decal	828525	89536	828525	1
302	Label, Window - Fluke/Philips	844340	89536	844340	1
U3	LCD, 3.75 digit, Bar Graph	640581	18520	LF-7031G	1
N.S.	Screw, Thd form, 5-14x3/4	733410	COMMERCIAL		4
N.S.	Decal, Warning	828707	89536	828707	1
N.S.	Decal, Warning	828715	89536	828715	1
N.S.	Fluke 75/77 Operator's Manual	642025	89536	642025	1
N.S.	C70 Holster	680652	89536	680652	1
N.S.	TL70 Test Leads	642033	89536	89536	1

N.S. = NOT SHOWN

WARNING

FOR SAFETY PURPOSES, CASE TOPS AND CASE BOTTOMS SHOULD NOT BE INTERCHANGED BETWEEN PCA TYPES (i.e., DO NOT USE THE CASE TOP SPECIFIED FOR THE 7X-3001 ON THE 7X-3011, ETC.)

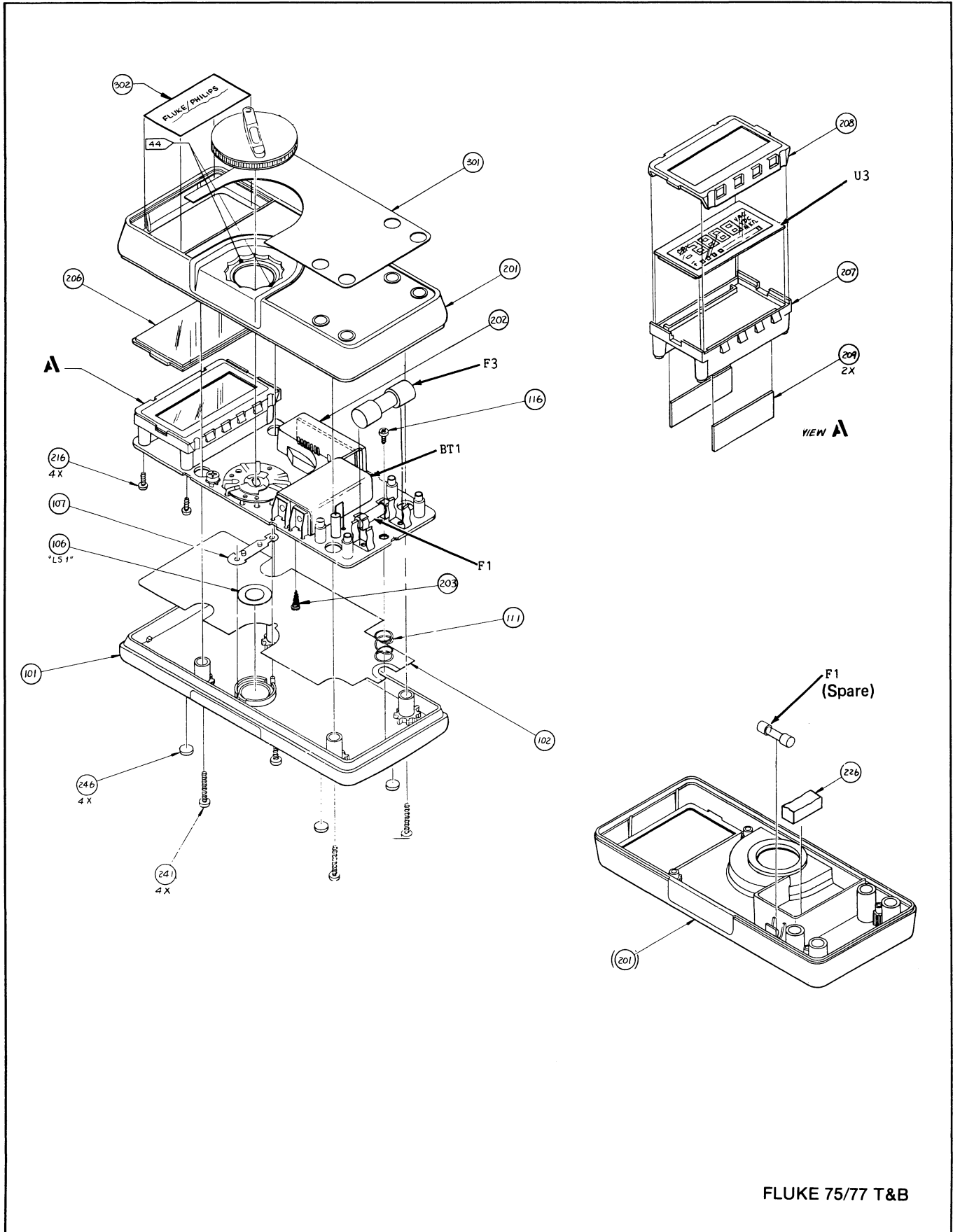

Figure 5-1. Final Assembly

Table 5-4. 73 A1 Main PCA
(See Figure 5-2.)

REF DES ITEM NO	DESCRIPTION	PART NUMBER	MFRS SPLY CODE	MANUFACTURER'S PART NUMBER	QTY
BT1	Battery, Primary, 9V	696534	66571	216	1
C1	Cap, Poly, .022uF, 1000V, 10%	721019	60935	MKT-1.60	1
C2,C10	Cap, Tant, .47uF, 35V, 20	655035	56289	199D474X0035AA1	2
C4	Cap, Alum, 2.2uF, 50V, 20%	650069	62643	SRA50VB225M4X15LL	1
C5,C6	Cap, Polyca, .027uF, 63V, 10%	720979	65964	CMK5273K63L29BULK	2
C7	Cap, Polyes, .47uF, 50V, 10%	697409	60935	185.47K50RBB	1
C8	Cap, Polypr, .033uF, 63V, 10	721050	60935	171.033K63B	1
C9	Cap, Tant, 6.8uF, 10V, 20%	655043	56289	199D685X0010BA1	1
C11	Cap, Tant, 2.2uF, 16V, 20%	706804	56289	199D225X0016AA1	1
C12	Cap, Cer, 47pF, 50V, 20%	706705	72982	RPE113Z5U470M50V	1
C13	Cap, Cer, .22uF, 50V, +80%-20%	733386	72982	RPE122Z5U224Z50V	1
C14,C15	Cap, Cer, 33pF, 50V, 5%	714543	72982	RPE113COG330350V	2
CR1,CR2	Diode, Radial Insert	659516	09214	1N4448	2
E1,E2	Surge Protector, 1500V	655134	91984	100	2
F3	Fuse, Fast, 15A, 600V	820829	71400	KTK-15	1
J1-4	Receptacle, Input	642959	89536	642959	3
Q1,Q3	Xstr, Sm Signal	685404	04713	SPS8763RLRA	2
Q2	Xstr, Sm Signal	698225	04713	2N3904RLRA2	1
R1	* Res, MF, 1K, Fusible, 2%	854687	23237	FA8466	1
R2,R3	Res, Cer, 1M, 1W, 5%	655175	23237	RG1/2-105M-5%	2
R4	Res, CF, 100k, 1/4W, 5%	658963	59124	1-4-5P104K	1
R5	Res, CF, 390k, 1/4W, 5%	706754	59124	CF1-4VT394J, REEL	1
R7	Res, WW, .005, .5W, 1%	740415	05347	RCSO2R0053F	1
R8	Res, Cer, Var, 100k, .3W, 20%	649897	51406	RVS0707V1003104M	1
R9,R19	Res, CF, 1M, 1/4W, 5%	649970	59124	1-4-5P105J	2
R10	Res, CF, 1.5M, 1/4W, 5%	649962	59124	1-4-5P155J	1
R11	Res, MF, 332k, 1/8W, 1%	655217	59124	MFF1-83323F	1
R12	Res, MF, 301k, 1/8W, 1%	655274	59124	MFF1-83013F	1
R14	Res, CF, 62k, 1/4W, 5%	713941	59124	CF1-4VT623J, REEL	1
R15	Res, MF, 56.2k, 1/8W, 1%	706242	59124	MF5OD5622F	1
R16	Res, MF, 205k, 1/8W, 1%	706234	59124	MF5OD5622F	1
R17	Res, MF, 20.5k, 1/8W, .5%	682716	59124	MF5OD2052D	1
R18	Res, MF, 9.20k, 1/8W, .5%	715219	59124	MF5OD9201D	1
RJ1	Varistor, 430V, 1mA, 10%	706838	09214	V264LAX1398	1
RT1	Thermistor, Pos, 1k, 40%, 25C	446849	54583	911P84E102YU13	1
S1	Switch, Rotary	642918	89536	642918	1
U1	8075 A/D Chip Tested	683052	89536	683052	1
U2	IC, CMOS, SM-5A, 4-Bit Micro	659656	18520	LR3676	1
VR1	Bandgap, Taped	729202	89536	729202	1
W3,W4	Res, Jumper, .25W, .02 ohm	682575	09969	FRJ-55	2
W5	Wire Jumper, PVC Insul.	747394	89536	747394	1
Y1	Crystal, 32.768 kHz, 3x8mm, 1%	643031	61429	NC38	1
Z1	Input Divider Network	683789	89536	683789	1
N.S.	Contact, 600V Fuse	707190	89536	707190	2
N.S.	Contact, Battery (Female)	654228	89536	654228	1
N.S.	Contact, Battery (Male)	642967	89536	642967	1

N.S. = NOT SHOWN

* WARNING--Fusible Resistor. To ensure safety, use exact replacement only.

Table 5-5. 75 A1 Main PCA
(See Figure 5-2.)

REF DES ITEM NO	DESCRIPTION	PART NUMBER	MFRS SPLY CODE	MANUFACTURER'S PART NUMBER	QTY
BT1	Battery, Primary, 9V	696534	66571	216	1
C1	Cap, Poly, .022uF, 1000V, 10%	721019	60935	MKT-1.60	1
C2,C10	Cap, Tant, .47uF, 35V, 20	655035	56289	199D474X0035AA1	2
C4	Cap, Alum, 2.2uF, 50V, 20%	650069	62643	SRA50VB225M4X15LL	1
C5,C6	Cap, Polyca, .027uF, 63V, 10%	720979	65964	CMK5273K63L29BULK	2
C7	Cap, Polyes, .47uF, 50V, 10%	697409	60935	185.47K50RBB	1
C8	Cap, Polypr, .033uF, 63V, 10	721050	60935	171.033K63B	1
C9	Cap, Tant, 6.8uF, 10V, 20%	655043	56289	199D685X0010BA1	1
C11	Cap, Tant, 2.2uF, 16V, 20%	706804	56289	199D225X0016AA1	1
C12	Cap, Cer, 47pF, 50V, 20%	706705	72982	RPE113Z5U470M50V	1
C13	Cap, Cer, .22uF, 50V, +80%-20%	733386	72982	RPE122Z5U224Z50V	1
C14,C15	Cap, Cer, 33pF, 50V, 5%	714543	72982	RPE113COG330350V	2
CR1,CR2	Diode, Radial Insert	659516	09214	1N4448	2
E1,E2	Surge Protector, 1500V	655134	91984	100	2
F1	Fuse, 5x20mm, .63A, 250V	740670	71400	GDA-630MA	2
F3	Fuse, Fast, 15A, 600V	820829	71400	KTK-15	1
J1-4	Receptacle, Input	642959	89536	642959	4
Q1,Q3	Xstr, Sm Signal	685404	04713	SPS8763RLRA	2
Q2	Xstr, Sm Signal	698225	04713	2N3904RLRA2	1
R1	* Res, MF, 1K, Fusible, 2%	854687	23237	FA8466	1
R2,R3	Res, Cer, 1M, 1W, 5%	655175	23237	RG1/2-105M-5%	2
R4	Res, CF, 100k, 1/4W, 5%	658963	59124	1-4-5P104K	1
R5	Res, MF, 402k, 1/4W, .25%	706739	57668	CRB14CXE	1
R6	Res, 4.99, 2.5W, 1%	655019	09969	NS-2C4R99F	1
R7	Res, WW, .005, .5W, 1%	740415	05347	RCS02R0053F	1
R8	Res, Cer, Var, 100k, .3W, 20%	649897	51406	RVS0707V1003104M	1
R9,R19	Res, CF, 1M, 1/4W, 5%	649970	59124	1-4-5P105J	2
R10	Res, CF, 1.5M, 1/4W, 5%	649962	59124	1-4-5P155J	1
R11	Res, MF, 332k, 1/8W, 1%	655217	59124	MFF1-83323F	1
R12	Res, MF, 301k, 1/8W, 1%	655274	59124	MFF1-83013F	1
R13	Res, MF, 44.8k, 1/8W, .25%	706747	59124	MF50D4482C	1
R14	Res, CF, 62k, 1/4W, 5%	713941	59124	CF1-4VT623J, REEL	1
R15	Res, MF, 56.2k, 1/8W, 1%	706242	59124	MF50D5622F	1
R16	Res, MF, 205k, 1/8W, 1%	706234	59124	MF50D5622F	1
R17	Res, MF, 20.5k, 1/8W, .5%	682716	59124	MF50D2052D	1
R18	Res, MF, 9.20k, 1/8W, .5%	715219	59124	MF50D9201D	1
R20	* Res, WW, Fusible, .36, 2W	740662	23237	SPF3605	1
RJ1	Varistor, 430V, 1mA, 10%	706838	09214	V264LAX1398	1
RT1	Thermistor, Pos, 1k, 40%, 25C	446849	54583	911P84E102YU13	1
S1	Switch, Rotary	642918	89536	642918	1
U1	8075 A/D Chip Tested	683052	89536	683052	1
U2	IC, CMOS, SM-5A, 4-Bit Micro	659656	18520	LR3676	1
VR1	Bandgap, Taped	729202	89536	729202	1
W1	Res, Jumper, .25W, .02	682575	09969	FRJ-55	1
W5	Wire Jumper, PVC Insul.	747394	89536	747394	1
Y1	Crystal, 32.768 kHz, 3x8mm, 1%	643031	61429	NC38	1
Z1	Input Divider Network	616870	89536	616870	1
N.S.	250V Fuse, Hldr, 5mmx20mm	697086	61857	H-0011-2	2
N.S.	Contact, 600V Fuse	707190	89536	707190	2
N.S.	Contact, Battery (Female)	654228	89536	654228	1
N.S.	Contact, Battery (Male)	642967	89536	642967	1

N.S. = NOT SHOWN

* WARNING--Fusible Resistor. To ensure safety, use exact replacement only.

Table 5-6. 77 A1 Main PCA
(See Figure 5-2.)

REF DES ITEM NO	DESCRIPTION	PART NUMBER	MFRS SPLY CODE	MANUFACTURER'S PART NUMBER	QTY
BT1	Battery, Primary, 9V	696534	66571	216	1
C2,C10	Cap, Tant, .47uF, 35V, 20	655035	56289	199D474X0035AA1	2
C4	Cap, Alum, 2.2uF, 50V, 20%	650069	62643	SRA50VB225M4X15LL	1
C5,C6	Cap, Polyca, .027uF, 63V, 10%	720979	65964	CMK5273K63L29BULK	2
C7	Cap, Polyes, .47uF, 50V, 10%	697409	60935	185.47K50RBB	1
C8	Cap, Polypr, .033uF, 63V, 10	721050	60935	171.033K63B	1
C9	Cap, Tant, 6.8uF, 10V, 20%	655043	56289	199D685X0010BA1	1
C11	Cap, Tant, 2.2uF, 16V, 20%	706804	56289	199D225X0016AA1	1
C12	Cap, Cer, 47pF, 50V, 20%	706705	72982	RPE113Z5U470M50V	1
C13	Cap, Cer, .22uF, 50V, +80%-20%	733386	72982	RPE122Z5U224Z50V	1
C14,C15	Cap, Cer, 33pF, 50V, 5%	714543	72982	RPE113COG330350V	2
CR1,CR2	Diode, Radial Insert	659516	09214	1N4448	2
E1,E2	Surge Protector, 1500V	655134	91984	100	2
F1	Fuse, 5x20mm, .63A, 250V	740670	71400	GDA-630MA	2
F3	Fuse, Fast, 15A, 600V	820829	71400	KTK-15	1
J1-4	Receptacle, Input	642959	89536	642959	4
Q1,Q3	Xstr, Sm Signal	685404	04713	SPS8763RLRA	2
Q2	Xstr, Sm Signal	698225	04713	2N3904RLRA2	1
R1	* Res, MF, 1K, Fusible, 2%	854687	23237	FA8466	1
R2,R3	Res, Cer, 1M, 1W, 5%	655175	23237	RG1/2-105M-5%	2
R4	Res, CF, 100k, 1/4W, 5%	658963	59124	1-4-5P104K	1
R5	Res, MF, 402k, 1/4w, .25%	706739	57668	CRB14CXE	1
R6	Res, 4.99, 2.5W, 1%	655019	09969	NS-2C4R99F	1
R7	Res, WW, .005, .5W, 1%	740415	05347	RCS02R0053F	1
R8	Res, Cer, Var, 100k, .3W, 20%	649897	51406	RVS0707V1003104M	1
R9,R19	Res, CF, 1M, 1/4W, 5%	649970	59124	1-4-5P105J	2
R10	Res, CF, 1.5M, 1/4W, 5%	649962	59124	1-4-5P155J	1
R11	Res, MF, 332k, 1/8W, 1%	655217	59124	MFF1-83323F	1
R12	Res, MF, 301k, 1/8W, 1%	655274	59124	MFF1-83013F	1
R13	Res, MF, 44.8k, 1/8W, .25%	706747	59124	MF50D4482C	1
R14	Res, CF, 62k, 1/4W, 5%	713941	59124	CF1-4VT623J, REEL	1
R15	Res, MF, 56.2k, 1/8W, 1%	706242	59124	MF50D5622F	1
R16	Res, MF, 205k, 1/8W, 1%	706234	59124	MF50D5622F	1
R17	Res, MF, 20.5k, 1/8W, .5%	682716	59124	MF50D2052D	1
R18	Res, MF, 9.20k, 1/8W, .5%	715219	59124	MF50D9201D	1
R20	* Res, WW, Fusible, .36, 2W	740662	23237	SPF3605	1
RJ1	Varistor, 430V, 1mA, 10%	706838	09214	V264LAX1398	1
RT1	Thermistor, Pos, 1k, 40%, 25C	446849	54583	911P84E102YU13	1
S1	Switch, Rotary	642918	89536	642918	1
U1	8075 A/D Chip Tested	683052	89536	683052	1
U2	IC, CMOS, SM-5A, 4-Bit Micro	659656	18520	LR3676	1
VR1	Bandgap, Taped	729202	89536	729202	1
W2	Res, Jumper, .25W, .02	682575	09969	FRJ-55	1
W5	Wire Jumper, PVC Insul.	747394	89536	747394	1
Y1	Crystal, 32.768 kHz, 3x8mm, 1%	643031	61429	NC38	1
Z1	Input Divider Network	683797	89536	683797	1
N.S.	250V Fuse, Hldr, 5mmx20mm	697086	61857	H-0011-2	2
N.S.	Contact, 600V Fuse	707190	89536	707190	2
N.S.	Contact, Battery (Female)	654228	89536	654228	1
N.S.	Contact, Battery (Male)	642967	89536	642967	1

N.S. = NOT SHOWN

* WARNING--Fusible Resistor. To ensure safety, use exact replacement only.

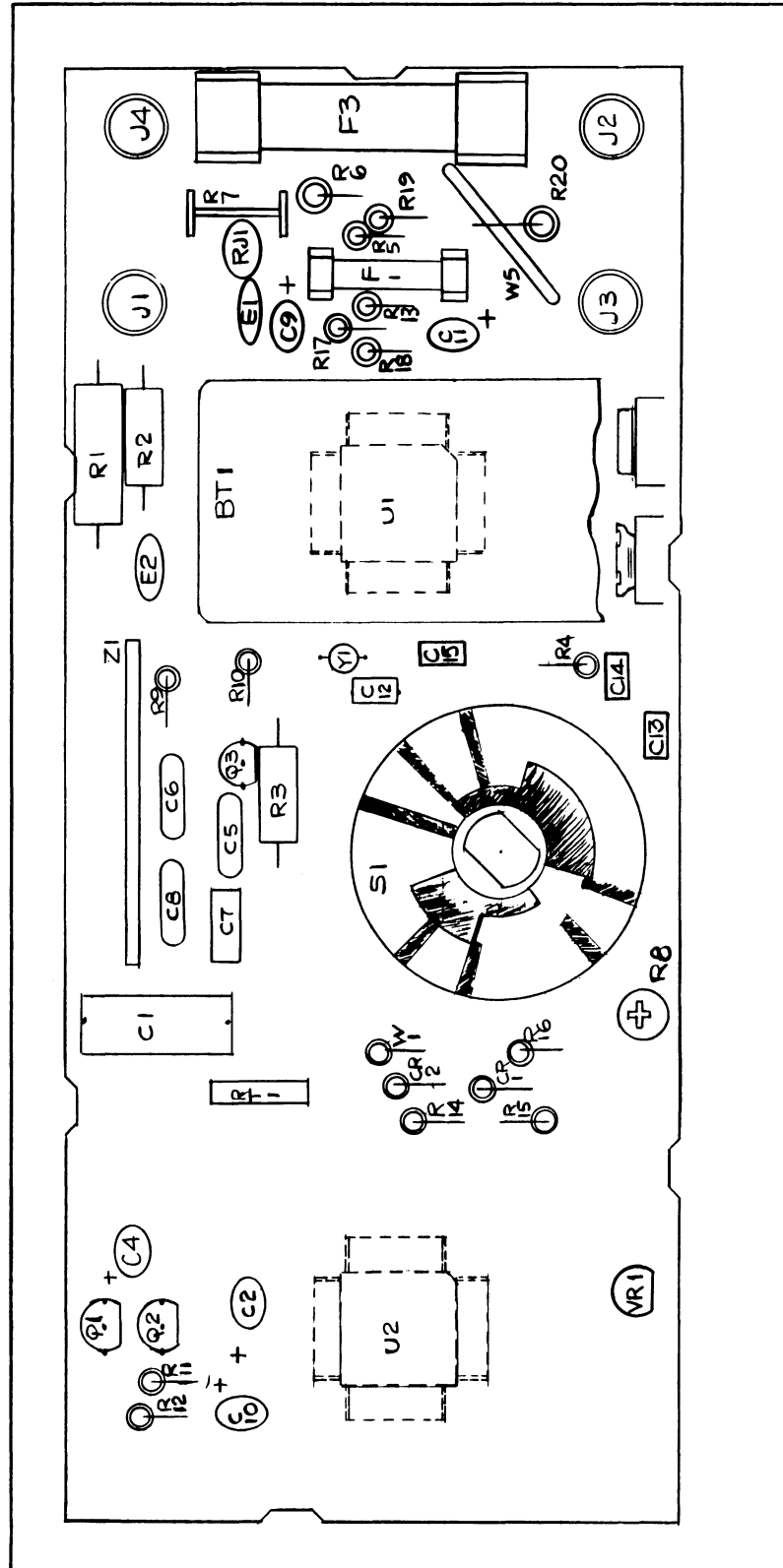

75-1621

Figure 5-2. A1 Main PCA

Section 6

General Information

6-1. INTRODUCTION

This section contains a list of generalized user information as well as supplemental information to the List of Replaceable Parts contained in Section 5. The following information is presented in this section.

Federal Supply Codes for Manufacturers

List of Technical Service Centers

Federal Supply Codes for Manufacturers

04713
Motorola, Inc.
5005 E. McDowell Rd.
Phoenix, AZ 85008-4229

05347
Ultronix, Inc.
461 N. 22nd Street
P.O. Box 1090
Grand Junction, CO 81502

09214
General Electric Co.
W. Genesee Street
Auburn, NY 13021

09969
Dale Electronics Inc.
East Hwy. 50
P.O. Box 180
Yankton, SD 57078

18520
Sharp Electronics Corp.
Sharp Plaza
Mahwah, NJ 07430-2135

11502
International Resistive Co., Inc.
Greenway Road
P.O. Box 1860
Boone, NC 28607-1860

51406
Murata Erie
2200 Lake Park Drive
Smyrna, GA 30080

54583
TDK Electronics Corp.
12 Harbor Park Drive
Port Washington, NY 11550

56289
Sprague Electric, Inc.
61 Spit Brook Road - Suite 305
Nashua, NH 03060

57668
R-OHM Corp.
16931 Milliken Ave.
Irvine CA 92713

59124
KOA-Speer Electronics, Inc.
P.O. Box 547
Bradford, PA 16701

60935
Westlake Capacitor
Indianapolis Road
Greencastle, IN 46135

61429
Fox Electronics
P.O. Box 1078
Cape Coral, FL 33910-1078

61857
SAN-O Industrial Corp.
85 Orville Drive
P.O. Box 511
Bohemia, NY 11716-2501

62643
United Chemicon Inc.
9806 Higgins Street
Rosemont, IL 60018-4792

65964
Evovx Inc.
2345 Waukegan Road
Bannockburn, IL 60015-1503

66571
Eveready Battery Co., Inc.
25225 Detroit Road
Westlake, OH 44145-2536

71400
Bussman Div. of Cooper Ind., Inc.
114 Old State Road
P.O. Box 14460
St. Louis, MO 63178

72982
Erie Specialty Products Inc.
645 West 11th
Erie, PA 16512

91984
Maida Development Co.
20 South Libby
P.O. Box 3529
Hampton, VA 23663

List of Technical Service Centers

U.S. Service Locations

California

Fluke Technical Center
16969 Von Karman Ave., Suite 100
Irvine, CA 92714
Tel: (714) 863-9031

Fluke Technical Center
46610 Landing Parkway
Fremont, CA 94538
Tel: (415) 651-5112

Colorado

Fluke Technical Center
14180 East Evans Ave.
Aurora, CO 80014
Tel: (303) 695-1000

Florida

Fluke Technical Center
940 N. Fern Creek Avenue
Orlando, FL 32803
Tel: (407) 896-4881

Illinois

Fluke Technical Center
1150 W. Euclid Ave.
Palatine, IL 60067
Tel: (312) 705-0500

Maryland

Fluke Technical Center
5640 Fishers Lane
Rockville, MD 20852
Tel: (301) 770-1576

New Jersey

Fluke Technical Center
E. 66 Midland Ave.
Paramus, NJ 07652-0930
Tel: (201) 599-9500

Texas

Fluke Technical Center
1801 Royal Lane, Suite 307
Dallas, TX 75229
Tel: (214) 869-0311

Washington

Fluke Technical Center
1420 75th St SW
Everett, WA 98203
Tel: (206) 356-5560

International

Argentina

Coasin S.A.
Virrey del Pino 4071 DPTO E-65
1430 CAP FED
Buenos Aires, Argentina
Tel: 54 1 522-5248

Australia

Philips Customer Support
Scientific and Industrial
23 Lakeside Drive
Tally Ho Technology Park
East Burwood,
Victoria 3151 Australia

Philips Customer Support

Scientific & Industrial
25-27 Paul St. North
North Ryde N.S.W. 2113
Australia
Tel: 61 02 888 8222

Austria

Oesterreichische Philips Industrie
Unternehmensbereich Prof. Systeme
Triesterstrasse 66
Postfach 217
A-1101 Wein, Austria
Tel: 43 222-60101, x1388

Belgium

Philips & MBLE Associated S.A.
Scientific & Industrial Equip. Div
Service Department.
80 Rue des deux Gares B-1070
Brussels, Belgium
Tel: 32 2 525 6111

Brazil

Hi-Tek Electronica Ltda.
Al. Amazonas 422, Alphaville,
CEP 06400 Barueri,
Sao Paulo, Brazil
Tel: 55 11 421-5477

Canada

Fluke Electronics Canada Inc.
400 Britannia Rd. East, Unit #1
Mississauga, Ontario L4Z 1X9
Canada
Tel: 416-890-7600

Chile

Intronica Chile Ltda.
Casilla 16228
Santiago 9, Chile
Tel: 56 2 2321886, 2324308

China, Peoples Republic of

Fluke International Corp.
P.O. Box 9085
Beijing
People's Republic of China
Tel: 86 01 512-3436

Colombia

Sistemas E Instrumentacion, Ltda.
Carrera 13, No. 37-43, Of. 401
Ap. Aereo 29583
Bogota DE, Colombia
Tel: 57 232-4532

Denmark

Philips A/S
Technical Service I & E
Strandlodsvej 1A
PO Box 1919
DK-2300 - Copenhagen S.
Denmark
Tel: 45 1 572222

Ecuador

Proteco Coasin Cia., Ltda.
P.O. Box 228-A
Ave. 12 de Octubre
2285 y Orellana
Quito, Ecuador
Tel: 593 2 529684

Egypt

Philips Egypt
10, Abdel Rahman el Rafei st.
el. Mohandessin
P.O. Box 242
Dokki Cairo, Egypt
Tel: 20-2-490922

England

Philips Scientific T & M Div.
Colonial Way
Watford
Hertfordshire WD2 4TT, England
Tel: 44 923-40511

Finland

Oy Philips AB
Central Service
Sinikalliontie 1-3
P.O. Box 11
SF-02631 ESPOO, Finland
Tel: 358-0-52572

France

S.A. Philips Industrielle
et Commerciale,
Science et Industry
105 Rue de Paris B.P. 62
93002 Bobigny, Cedex
France
Tel: 33-1-4942-8040

Germany (F.R.G.)

Philips GmbH
Service fuer FLUKE - Produkte
Department VSF
Oskar-Messter-Strasse 18
D-8045 Ismaning/Munich,
West Germany
Tel: 49 089 9605-239

Greece

Philips S.A. Hellenique
15, 25th March Street
177 78 Tavros
10210 Athens, Greece
Tel: 30 1 4894911

Hong Kong

Schmidt & Co (H.K.) Ltd.
18/FL., Great Eagle Centre
23 Harbour Road
Wanchai, Hong Kong
Tel: 852 5 8330222

India

Hinditron Services Pvt. Ltd
1st Floor, 17-B,
Mahal Industrial Estate
Mahakali Road, Andheri East
Bombay 400 093, India
Tel: 91 22 6300043

Hinditron Services Pvt. Inc.
33/44A Raj Mahal Villas Extn.
8th Main Road
Bangalore 560 080, India
Tel: 91 812 363139

Hinditron Services Pvt. Ltd.

Field Service Center
Emerald Complex 1-7-264
5th Floor
114 Sarojini Devi Road
Secunderabad 500 003, India
Tel: 08 42-821117

Hinditron Services Pvt. Ltd.

15 Community Centre
Panchshila Park
New Delhi 110 017, India
Tel: 011-6433675

Indonesia

P.T. Lamda Triguna
P.O. Box 6/JATJG
Jakarta 13001, Indonesia
Tel: (021) 8195365

Israel

R.D.T. Electronics Engineering, Ltd.
P.O. Box 43137
Tel Aviv 61430
Israel
Tel: 972 3 483211

Italy

Philips S.p.A.
Sezione I&E/T&M
Viale Elvezia 2
2005 Monza, Italy
Tel: 39 39 3635342

Japan

John Fluke Mfg. Co., Inc.
Japan Branch
Sumitomo Higashi Shinbashi Bldg.
1-1-11 Hamamatsucho
Minato-ku, Tokyo 105, Japan
Tel: 81 3 434-0188

Korea

Myoung Corporation
Yeo Eui Do P.O. Box 14
Seoul 150, Korea
Tel: 82 2 784-9942

Malaysia

Mecomb Malaysia Sdn. Bhd.
P.O. Box 24
46700 Petaling Jaya
Selangor, Malaysia
Tel: 60 3 774-3422

Mexico

Mexel Servicios en Computacion
Instrumentacion y Perifericos
Blvd. Adolfo Lopez Mateos No. 163
Col. Mixcoac
Mexico D.F., Mexico
Tel: 52-5-563-5411

Netherlands

Philips Nederland
Test & Meetapparaten Div.
5000 AC Tilburg
The Netherlands
Tel: 31-13-352445

List of Technical Service Centers

New Zealand

Philips Customer Support
Scientific & Industrial Division
2 Wagener Place
Mt. Albert
Auckland, New Zealand
Tel: 64 9 894-160

Norway

Morgenstjerne & Co. A/S
Konghellegate 3
P.O. Box 6688, Rodelokka
Oslo 5, Norway
Tel: 47 2 356110

Pakistan

International Operations (PAK) Ltd.
505 Muhammadi House
I.I. Chundrigar Road
P.O. Box 5323
Karachi, Pakistan
Tel: 92 21 221127, 239052

Peru

Importaciones & Representaciones
Electronicas S.A.
Avda. Franklin D. Roosevelt 105
Lima 1, Peru
Tel: 51 14 288650

Philippines

Spark Radio & Electronics Corp.
Greenhills, P.O. Box 610
San Juan, Metro-Manila Zip 3113
Philippines
Tel: 63-2-775192

Portugal

Decada Espectral,
Equipmentos de Elec. e Cientificos
Av. Bomberos Voluntarios
Lote 102B, Miraflores/Alges
1495 Lisboa, Portugal
Tel: 351 1 410-3420

Singapore

Rank O'Connor's Singapore (PTE) Ltd.
98 Pasir Panjang Road
Singapore 0511
Republic of Singapore
Tel: 65 4737944

South Africa

South African Philips (Pty) Ltd.
Service Department
195 Main Rd
Martindale, Johannesburg, 2092
South Africa
Tel: 27 11 470-5255

Spain

Philips Iberica S.A.E.
Depto. Tecnico Instrumentacion
C/Martinez Villergas 2
28027 Madrid, Spain
Tel: 34 1 4042200

Sweden

Philips Kistaindustrier AB
Customer Support
Borgarfjordsgatan 16
S-16493 Kista
Sweden

Switzerland

Philips AG Technischer Kundendienst
Postfach 670
Allmendstrasse 140
CH-8027 Zurich
Switzerland
Tel: 41 1 482211

Taiwan

Schmidt Electronics Corp.
5th Floor, Cathay Min Sheng
Commercial Building
344 Min Sheng East Road
Taipei, Taiwan, R.O.C.
Tel: 886 2501-3468

Thailand

Measuretronix Ltd.
2102/63 Ramkamhaeng Rd.
Bangkok 10240, Thailand
Tel: 66 2 374-2516, 374-1632

Turkey

Turk Philips Ticaret A.S.
Inonu Caddesi 78/80
Posta Kutusu 504-Beyoglu
Istanbul, Turkey
Tel: 90 1 1435891

Uruguay

Coasin Uruguay S.A
Casilla de Correo 1400
Libertad 2529
Montevideo, Uruguay
Tel: 598-2-789015

Venezuela

Coasin C.A.
Calle 9 Con Calle 4,
Edif. Edinurbi
Apartado de Correos
Nr-70 136 Los Ruices
Caracas 1070-A, Venezuela
Tel: 58 2 241-0309, 241-1248

Section 7 Schematic Diagram

7-1. INTRODUCTION

This section presents a schematic diagram for the Fluke 73, 75, and 77 Multimeters. Differences between the models are noted.

Table 7-1 contains a list of definitions for abbreviations used in the schematic drawing.

Table 7-1. Abbreviations

ABBREVIATION	DEFINITION
ACA	AC Converter Feedback
ACHI	AC Converter High
ACL	All Clear, Reset
ACLO	AC Converter Low
AFI	Active Filter Input
AFO	Active Filter Output
AMO	Amps Input
AM1	Amps Divide by 10
AZ	Auto Zero Point
BPR	Beeper Driver
BT	Battery
CLK	Clock Output
COM	Common
DCS	DC Sense

Table 7-1. Abbreviations (cont)

ABBREVIATION	DEFINITION
EC	Reference Voltage
FAO	Active Filter Amp Output
FA(-)	Active Filter Amp Feedback
INT	Integrator Output
K0	Buffer Divide By 1 Output
K1	Buffer Divide by 3 Output
LS	Loud Speaker
LO	Low
OHS	Ohms Sense
RNG	Range
RRS	Reference Resistor Sense
RT	Thermistor
VSS	Negative Supply Voltage
VDD	Positive Supply Voltage
VM	Volts Middle
WW	Wirewound
XTL	Crystal Oscillator Inputs
Z	Impedance

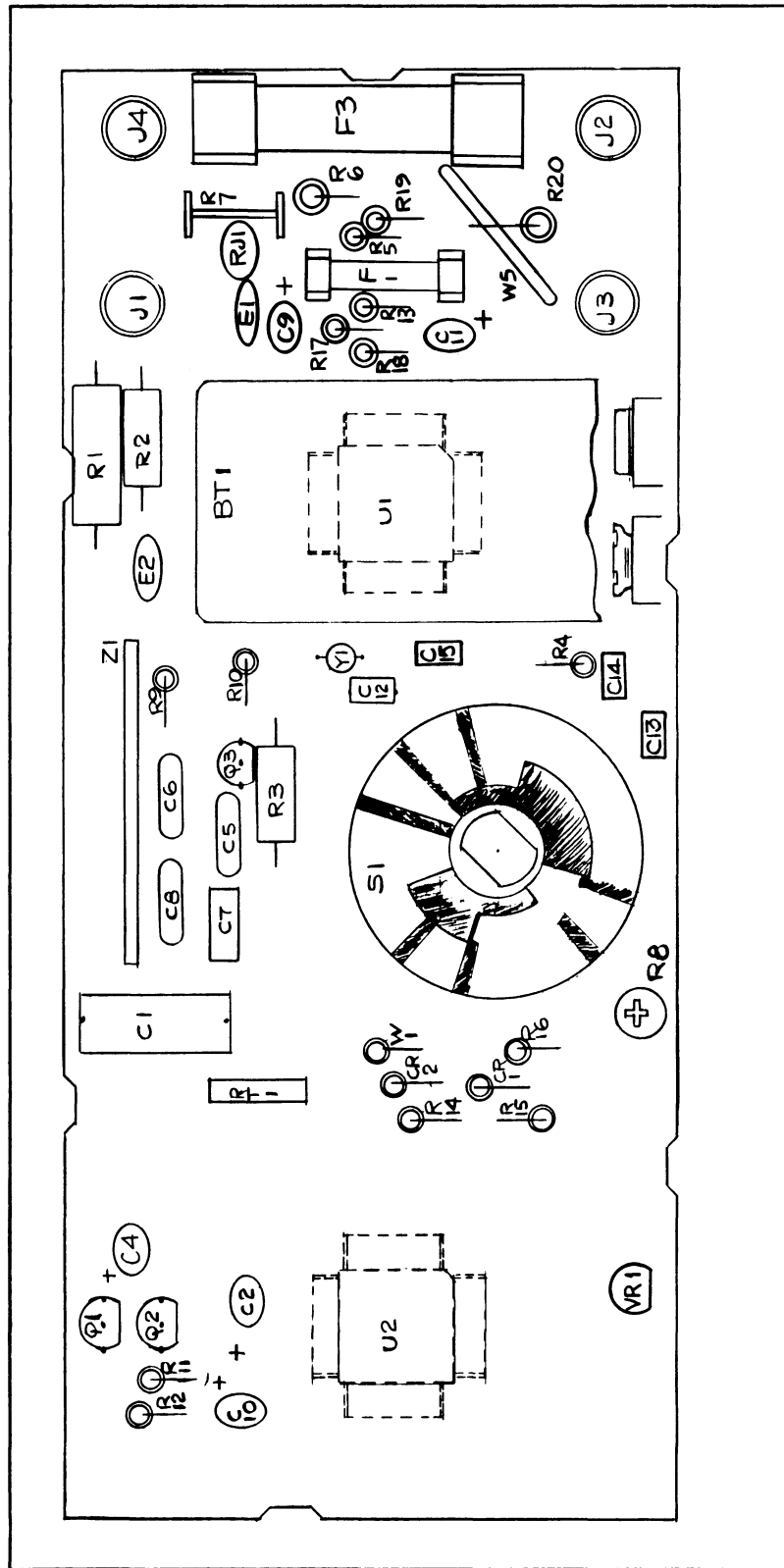

75-1621

Figure 7-1. A1 Main PCA

WARNING

R1 AND R20 ARE FUSIBLE RESISTORS. TO ENSURE SAFETY, USE EXACT REPLACEMENT ONLY.

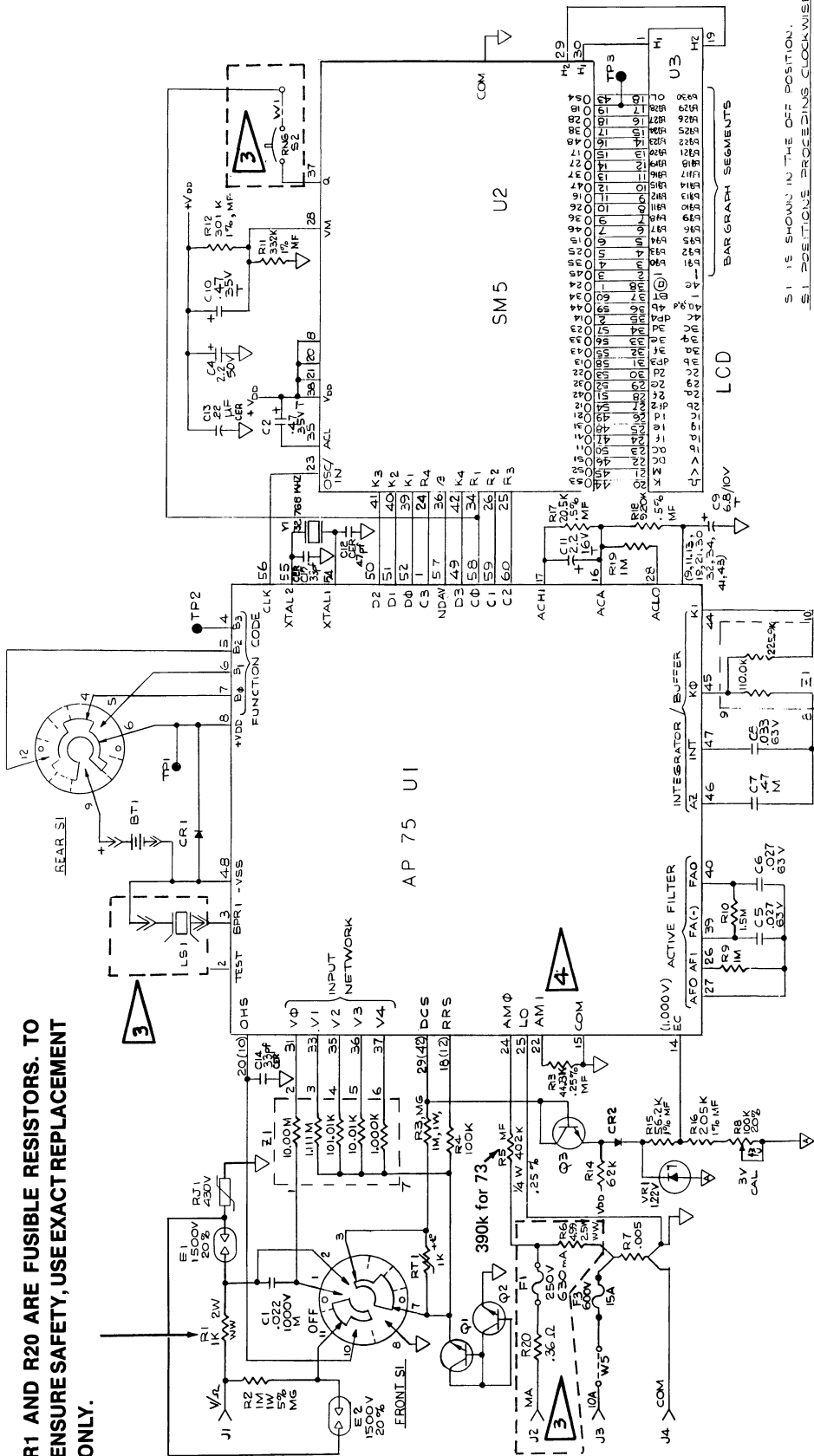

- SI 15 SHOW IN THE OFF POSITION.
 S1 POSITIONS PROCEEDS CLOCKWISE:
- 1 OFF VOLTS
 - 2 AC VOLTS
 - 3 DC VOLTS
 - 4 OHMS
 - 5 OHMS
 - 6 DIODE TEST/CONTINUITY
 - 7 AC CURRENT
 - 8 DC CURRENT

REFERENCE	DESIGNATION	HIGHEST	NOT USED
U	1	3	
C	15	15	C3
Z	Q	3	
RT	1	2	
CR	3	2	
Y	1	1	
ET	1	1	
LS	1	1	
S	1	1	
W	1	1	2,3,4

- NOTES: UNLESS OTHERWISE SPECIFIED:
1. ALL CAPACITANCE IS IN MICROFARADS, POLY PROPYLENE FILM.
 2. ALL RESISTANCE IS IN OHMS. 1/4W, 5% ARE FILM. 1% AND 0.5% RESISTORS ARE 1/8W.
- 3** Models 75 and 77 only.
4 For Model 73, R13 is replaced by W4.

Figure 7-1. A1 Main PCA (cont)

Section 8

Manual Change Information

The A1 Main PCA in your 70 Series Multimeter may be one of the following types: 7X-3021, 7X-3011, or 7X-3001. This manual currently documents all 70 Series instruments that have the 7X-3021 A1 Main PCA. Make the changes to your manual as described in the following pages if the A1 Main PCA in your instrument is either a 7X-3011 or a 7X-3001. The pca type is located under the battery on the top side of the pca.

WARNING

FOR SAFETY PURPOSES, CASE TOPS AND CASE BOTTOMS SHOULD NOT BE INTERCHANGED BETWEEN PCA TYPES (i.e., DO NOT USE THE CASE TOP SPECIFIED FOR THE 7X-3001 ON THE 7X-3011, ETC.)

CHANGE #1 (7X-3011)

Make the following changes to your manual to reflect the 7X-3011 type of A1 Main PCA:

Change the appropriate parts lists as follows:

DELETE:	202	Shield, Top	819300
	203	Screw, Thd form, 2-14x.375	821140
	F3	Fuse, Fast, 15A 600V	820829

Change the Case Top Assembly and Case Bottom Assembly part numbers:

	CASE TOP ASSEMBLY			CASE BOTTOM ASSEMBLY		
	73	75	77	73	75	77
FROM:	828624	828632	828616	828608	828640	828640
TO:	656116	651752	652552	661009	785238	785238

Replace the 7X-1621 reference designator drawing with the 7X-1611.

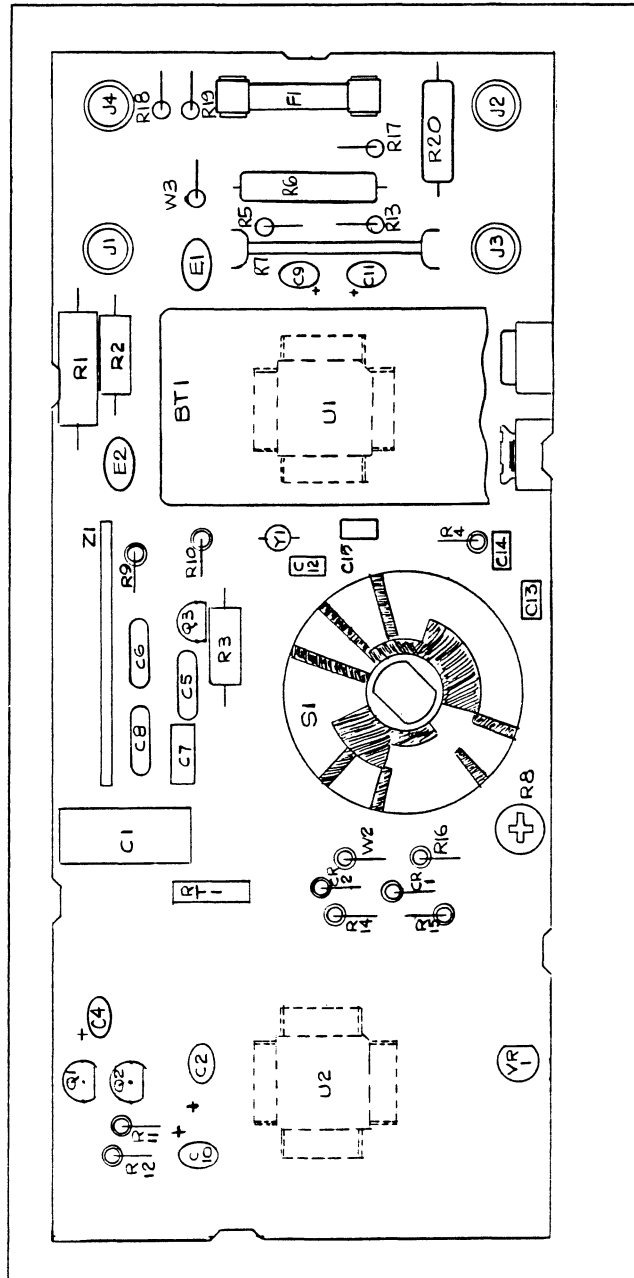

7X-1611

Replace the 7X-1221 schematic with the 7X-1211:

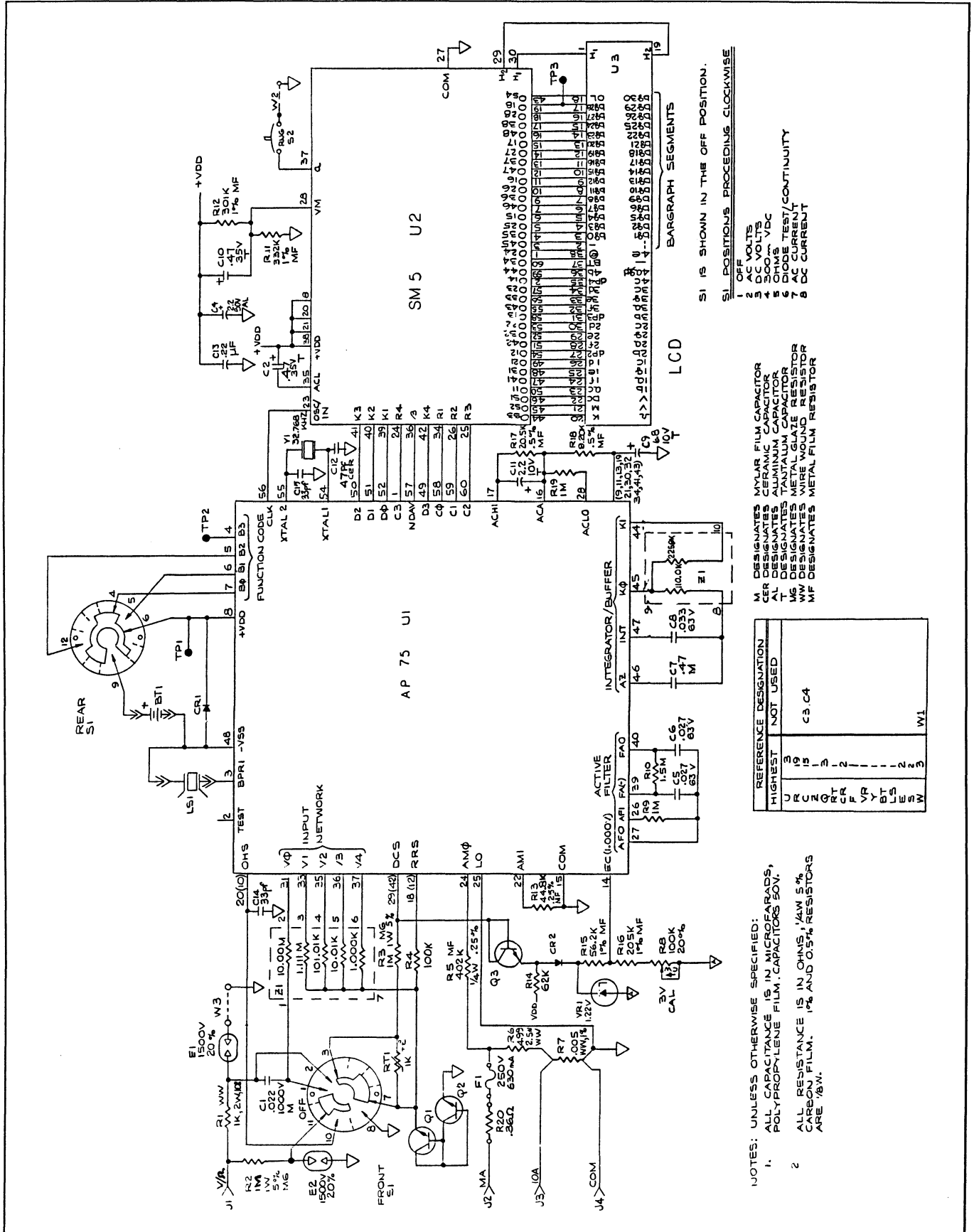

7X-1211

CHANGE #2 (7X-3001)

Make the following changes to your manual to reflect the 7X-3001 version A1 Main PCA:

Change the appropriate parts lists as follows:

DELETE:	202	Shield, Top	819300
	203	Screw, Thd form, 2-14x.375	821140
	F3	Fuse, Fast, 15A 600V	820829
	R20	Res, WW, Fusible, .36, 2W	740662
	RJ1	Varistor, 430V, 1 mA, 10%	706838
ADD:	F2	Fuse, Fiber, 3A, 600V	475004

Change the Case Top Assembly and Case Bottom Assembly part numbers:

	CASE TOP ASSEMBLY			CASE BOTTOM ASSEMBLY		
	73	75	77	73	75	77
FROM:	828624	828632	828616	828608	828640	828640
TO:	656116	651752	652552	661009	654095	654075

Replace the 7X-1621 reference designator drawing with the 7X-1601:

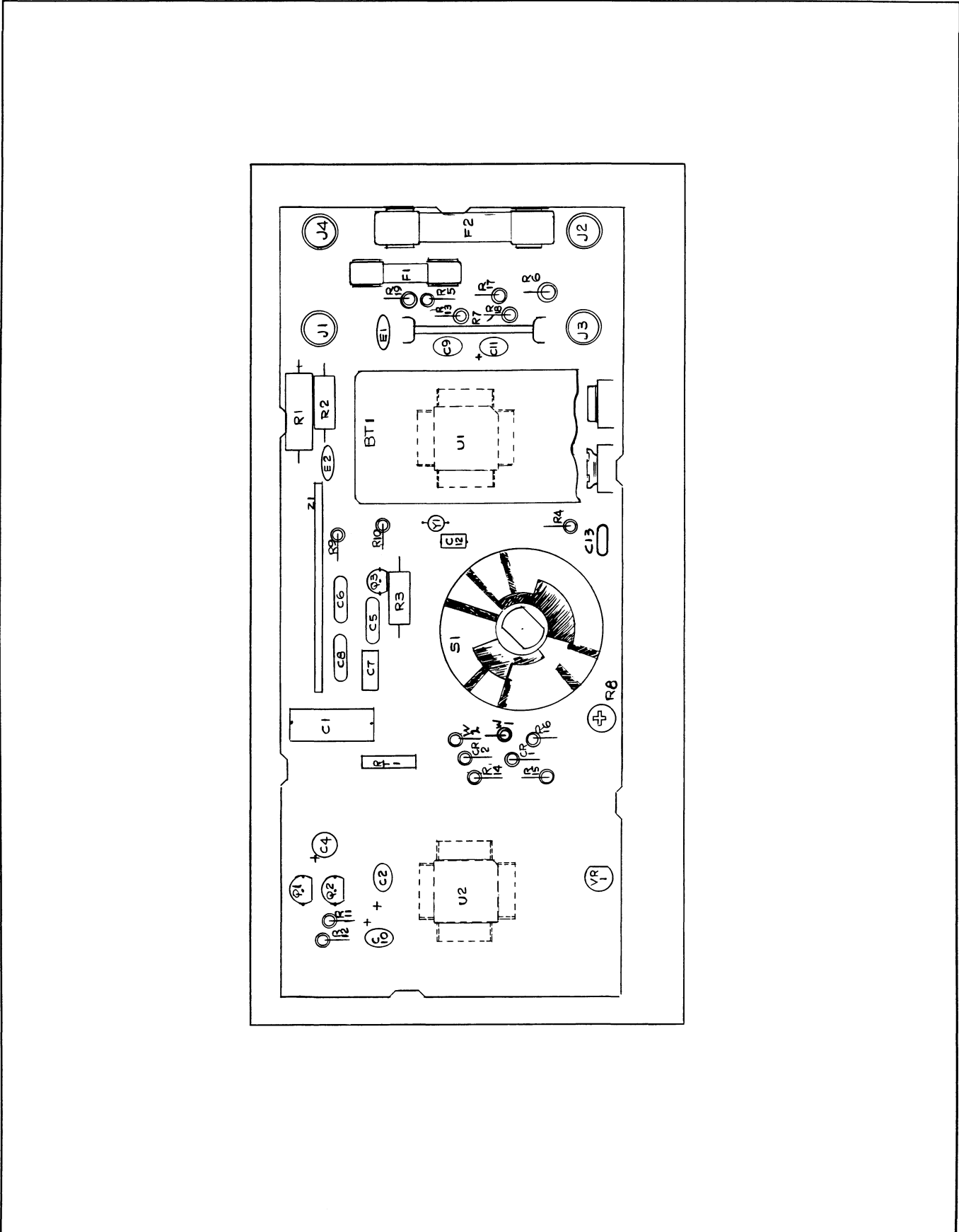

7X-1601

Replace the 7X-1221 schematic with the 7X-1201:

WARNING: R1 IS A FUSIBLE RESISTOR. TO ENSURE SAFETY, USE EXACT REPLACEMENT ONLY.

- NOTES: UNLESS OTHERWISE SPECIFIED:
1. ALL CAPACITANCE IS IN MICROFARADS.
 2. ALL RESISTANCE IS IN OHMS, $\frac{1}{4}W$ 5%.
1% AND 0.5% RESISTORS ARE $\frac{1}{8}W$.
- 5 MODELS 75 & 77 ONLY
 - 6 FOR MODEL 73, R13 IS REPLACED BY W4
 - 7 C13 REV K PWB ONLY

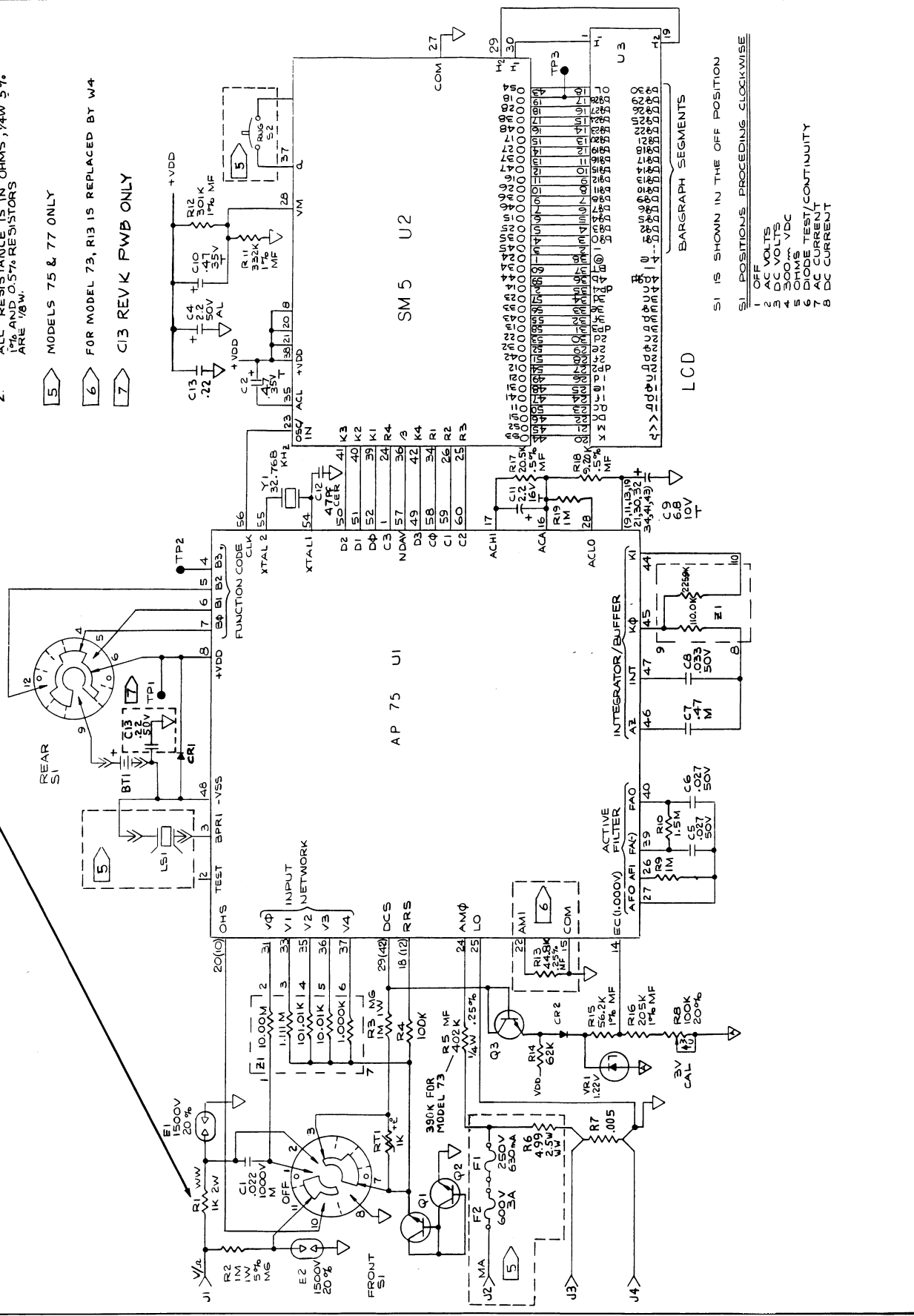

- SI IS SHOWN IN THE OFF POSITION
- SI POSITIONS PRECEDING CLOCKWISE
- 1 OFF
 - 2 AC VOLTS
 - 3 DC VOLTS
 - 4 300mVDC
 - 5 OHMS
 - 6 DIODE TEST/CONTINUITY
 - 7 AC CURRENT
 - 8 DC CURRENT

7X-1201