

FLUKE®

867B/863

Graphical Multimeter

Users Manual

4822 872 00894

November 1997 , Rev. 3, 10/98

© 1997, 1998 Fluke Corporation. All rights reserved. Printed in the Netherlands.

All product names are trademarks of their respective companies.

Table of Contents

Chapter	Title	Page
1	A Quick Tour	1-1
	Your Graphical Multimeter	1-1
	About This Manual	1-8
	Combo Mode	1-9
	Meter Mode	1-9
	View Mode	1-9
	Trend Mode	1-9
	Auto Diode Test Mode	1-10
	Logic Test Mode	1-10
	Component Test Mode	1-10
	Sleep Mode	1-10
2	Making Measurements	2-1
	Introduction	2-1
	Measuring AC Volts	2-4

	Measuring DC Volts	2-6
	Measuring DC Millivolts.....	2-8
	Measuring Ohms, Continuity, and Conductance.....	2-9
	Testing Diodes and Measuring Capacitance	2-11
	Measuring AC and DC Amps	2-13
	Measuring AC and DC Milliamps and Microamps.....	2-15
	Using Component Test	2-17
	Testing for Logic Activity	2-20
	Measuring Frequency	2-22
3	Some General Descriptions	3-1
	Introduction	3-1
	Battery Considerations.....	3-1
	Display Blanking (Sleep Mode)	3-1
	Using the	3-2
	Backlight (Model 867B)	3-2
	Adjusting Contrast.....	3-2
	General Features	3-2
	Understanding Display Features	3-7
	Measurement Connections	3-10
4	Using the Hardkeys.....	4-1
	Introduction	4-1
	Using Display Mode Softkeys	4-1
	Using Frequency Softkeys	4-2
	Save/Print Softkeys.....	4-3

	Min Max Softkeys	4-4
	Range Softkeys	4-5
	Touch Hold	4-6
5	Using View and Trend Display Modes.....	5-1
	Introduction	5-1
	View Display Mode Basics	5-1
	Using View Mode Softkeys.....	5-2
	Setting Up the Time Base.....	5-3
	Setting Up the Trigger	5-4
	Choosing the Acquisition Type	5-7
	Trend Display Mode Basics.....	5-10
	Using Trend Mode Softkeys	5-10
6	Using Save, Recall, Print, and Set Up.....	6-1
	Introduction	6-1
	Using the Save/Print Softkeys	6-1
	Saving Screen and Configuration	6-3
	Recalling Screen or Configuration	6-4
	Previewing Screen or Configuration.....	6-4
	Saving the Present Configuration	6-5
	Printing.....	6-6
	Changing the Configuration	6-8
7	User Maintenance.....	7-1
	Introduction	7-1

	Cleaning	7-1
	Testing the Fuses.....	7-1
	Replacing the Batteries	7-2
	Replacing the 440 mA Fuses	7-2
	Replacing the 11A (High Energy) Fuse.....	7-2
	Reassembly	7-3
	Operational Test.....	7-5
	Self Test	7-5
	If Your GMM Does Not Work	7-8
8	Specifications	8-1
	General Specifications	8-1

List of Tables

Table	Title	Page
1-1.	Introducing Your Graphical Multimeter	1-2
1-2.	A Practice Session.....	1-6
1-3.	Functions and Display Modes.....	1-11
2-1.	Common Combo/Meter Mode Softkeys.....	2-2
2-2.	Component Testing (Capacitance)	2-18
3-1.	General Features	3-4
3-2.	Upper Status Line	3-9
6-1.	Set Up Selections	6-9

List of Figures

Figure	Title	Page
1-1.	Graphical Multimeter Features.....	1-1
1-2.	RS232 and AC Power Connections.....	1-1
1-3.	Test Leads and Measurement Connections	1-4
1-4.	Using the Battery Eliminator	1-5
1-5.	Volts and Amps Measurement Map.....	1-12
1-6.	Ohms, Conductance, Diode Test, Capacitance Map.....	1-13
1-7.	Logic Test, Component Test, and Set Up.....	1-14
1-8.	Hz Min Max, and Range Map	1-14
2-1.	AC Volts Measurements	2-4
2-2.	DC Volts Measurements	2-6
2-3.	Millivolt Measurements	2-8
2-4.	Ohms, Continuity, and Conductance Measurements	2-9
2-5.	Diode Test and Capacitance Measurements.....	2-11
2-6.	Amps Measurements.....	2-13

2-7.	Milliamp and Microamp Measurements.....	2-15
2-8.	Component Testing	2-17
2-9.	Component Test Patterns.....	2-19
2-10.	LOGIC Testing.....	2-20
2-11.	Frequency Measurements.....	2-22
3-1.	General Features.....	3-3
3-2.	Input Connections Screen	3-7
3-3.	Display Features.....	3-8
3-4.	General Measurement Connections.....	3-10
3-5.	Amps Measurement Connections	3-10
3-6.	Milliamp and Microamp Connections.....	3-11
3-7.	LOGIC Testing Connections.....	3-11
5-1.	Time Base Selection.....	5-3
5-2.	Trigger Icons.....	5-5
5-3.	Setting Up the Trigger	5-6
5-4.	Viewable Time Divisions (Single Shot and Glitch Capture).....	5-9
6-1.	Freeze (Print/Save) Softkey Map	6-2
6-2.	PC and Printer Connections	6-7
7-1.	Replacing the 11A (High Energy) Fuse	7-4
7-2.	Replacing the Batteries	7-6
7-3.	Replacing the 440 mA Fuse	7-7

Safety

In this manual, the word “WARNING” identifies conditions and actions that pose hazard(s) to the user. The word “CAUTION” refers to conditions and/or actions that can damage the instrument. Use of the instrument in a manner not specified may impair safety. Read the following safety information carefully before attempting to operate or service the instrument.

- Avoid working alone.
- Disconnect the power and discharge high-voltage capacitors before testing in Ohms Continuity, Diode, Capacitance, and COMPONENT Test.
- Inspect the test leads for damaged insulation or exposed metal. Check test lead continuity. Damaged leads should be replaced.
- Do not use the GMM if it looks damaged.
- Select the proper function and range for your measurement.
- Use caution when working above 60V dc or 30V ac rms. Such voltages pose a shock hazard.
- When using the probes, keep your fingers away from probe contacts. Keep your fingers behind the finger guards on the probes.
- Place test leads in proper input terminals.
- Disconnect the live test lead before disconnecting the common test lead.
- When measuring current, turn the power off to the circuit being tested before connecting the GMM test tool in that circuit.
- Check GMM test tool fuses before measuring current transformer secondary or motor winding current. (See Testing the Fuses in the User Maintenance chapter.) An open fuse may allow high voltage buildup, which is potentially hazardous.
- Use clamp-on probes (current clamps) when measuring currents exceeding 10A.



Hazardous voltages are present on the External Trigger input terminal and any attached probe when the GMM is measuring voltages greater than 30V rms or 60V dc.

Replacing Fuses

The following fuses should be used:

- F 440 mA, 1000V, Minimum Interrupt Rating 10,000A.
- F 11A, 1000V, Minimum Interrupt Rating 17,000A.

Warning

Use of fuses with voltage ratings below 1000V reduces protection. Do not replace the 440 mA 1000V fuse with a 4/10A 600V fuse.



WARNING risk of electric shock.



CAUTION see explanation in manual.



Equipment protected throughout by DOUBLE INSULATION or REINFORCED INSULATION.



Overload Protection

Voltage or Current Input: 1000V

Surge Protection: 8 kV

Maximum Voltage Isolation to Ground: 1000V

Protection Levels: per IEC 1010-1; 1000V CAT III (fixed distribution-level installations which can experience peak voltage transients up to 8000V.)

Protection Class: II 

Chapter 1 A Quick Tour

Note

The NiCd battery pack must be fully charged before using the 867B. See Chapter 3.

Your Graphical Multimeter

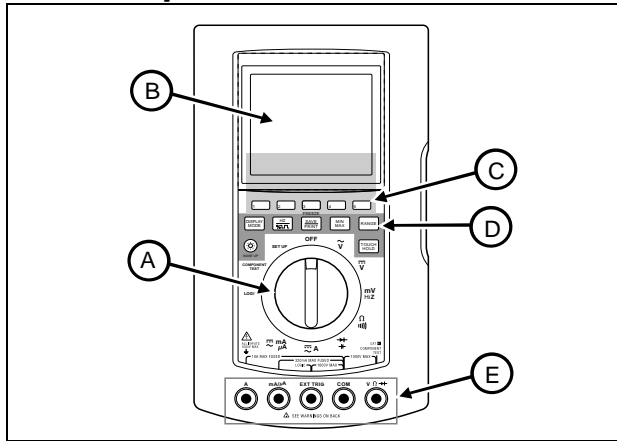

rita0091.eps

Figure 1-1. Graphical Multimeter Features

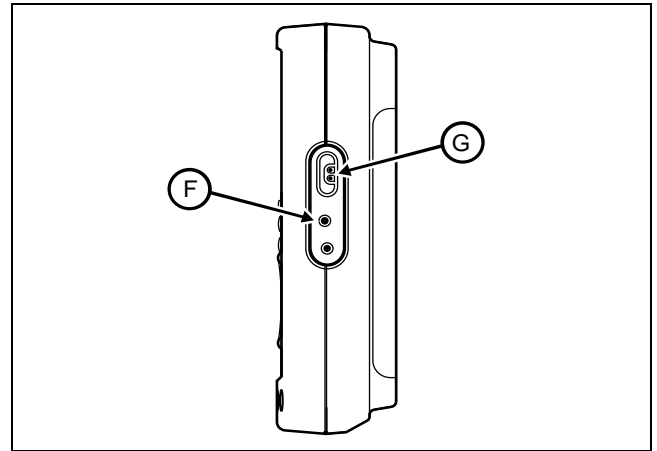

rita0092.eps

Figure 1-2. RS232 and AC Power Connections

Table 1-1. Introducing Your Graphical Multimeter















ITEM	SYMBOL	DESCRIPTION
A	 	<p>TURN THE GMM ON BY ROTATING THE SELECTOR TO ANY FUNCTION. Turn the rotary selector to the AC Volts (V) position. The input connections screen appears for a few seconds, then the screen sets up for this function, and you are ready to begin. You can toggle the backlight power level (Model 867B only) by pressing . Also note that the screen goes dark if you do not change any controls for about 20 minutes and the GMM is on battery power; pressing  wakes up the screen (all models.)</p>
B	Combo Meter View Trend	<p>THE SCREEN. In AC Volts, the initial screen presents a primary display of large digits, a secondary display of smaller digits, and a graphical window showing either a waveform or an analog NeedleGraph™ representation of the primary display. In addition, the upper screen line displays status information. The bottom screen line (immediately above the softkey labels) shows the display mode, range, and other information. For example, “Combo” appears on this line if a waveform appears in the graphical window: the GMM is in Combo Mode.</p>
C	    	<p>THE SOFTKEYS. Most control settings (selector change or key press) change the softkey labels along the bottom of the screen. These labels define the present uses for the five blue keys that are positioned immediately below the screen. Together, the labels and the keys form a set of Softkeys. These changing softkey definitions allow direct access to a wealth of GMM capabilities. Refer to Figures 1-6, 1-7, and 1-8 at the end of this chapter for a roadmap to softkey use.</p>

Table 1-1. Introducing Your Graphical Multimeter (cont)

ITEM	SYMBOL	DESCRIPTION
D		<p>THE HARDKEYS. Hardkeys appear immediately below the softkeys. Hardkeys perform the same operations in all functions. Pressing  wakes up the screen from Sleep Mode (all models) and toggles the backlight power level on Model 867B. Although hardkeys can generally be pressed at any time, certain feature combinations are not allowed. The GMM test tool rejects any hardkey press that is not allowed; a long beep sounds. Chapter 4 explains each hardkey in detail.</p>
E	<p>VΩ </p> <p>COM</p> <p>EXT TRIG</p> <p>A</p> <p>mA/μA</p>	<p>MEASUREMENT CONNECTIONS. Review the input connection scheme now only for familiarization: no actual connections are necessary during the Quick Tour. Volts, Ohms, Continuity, Conductance, Diode Test, Capacitance, and Component Test measurements use VΩ  for the Red lead. Amps measurements use A for the Red lead. mAμA measurements use mA/μA for the Red lead. LOGIC Test measurements use EXT TRIG for the Red lead. All functions use COM for the Black lead. Refer to Figure 1-3 for TL70A test lead connection views.</p>
F		<p>LINE POWER OR BATTERY POWER. You can power the GMM with batteries or from ac line power through the Battery Eliminator. New alkaline (AA) cells provide a minimum of 4 hours operation. A fully charged BP7217 NiCd battery pack typically provides a minimum of 8 hours operation. The battery eliminator recharges the NiCd battery pack on Model 867B. Refer to Figure 1-4.</p>
G	RS232	<p>SERIAL PC OR PRINTER CONNECTION. Your GMM can use an optional optical serial interface cable to communicate with a PC or printer. Refer to Chapter 6.</p>

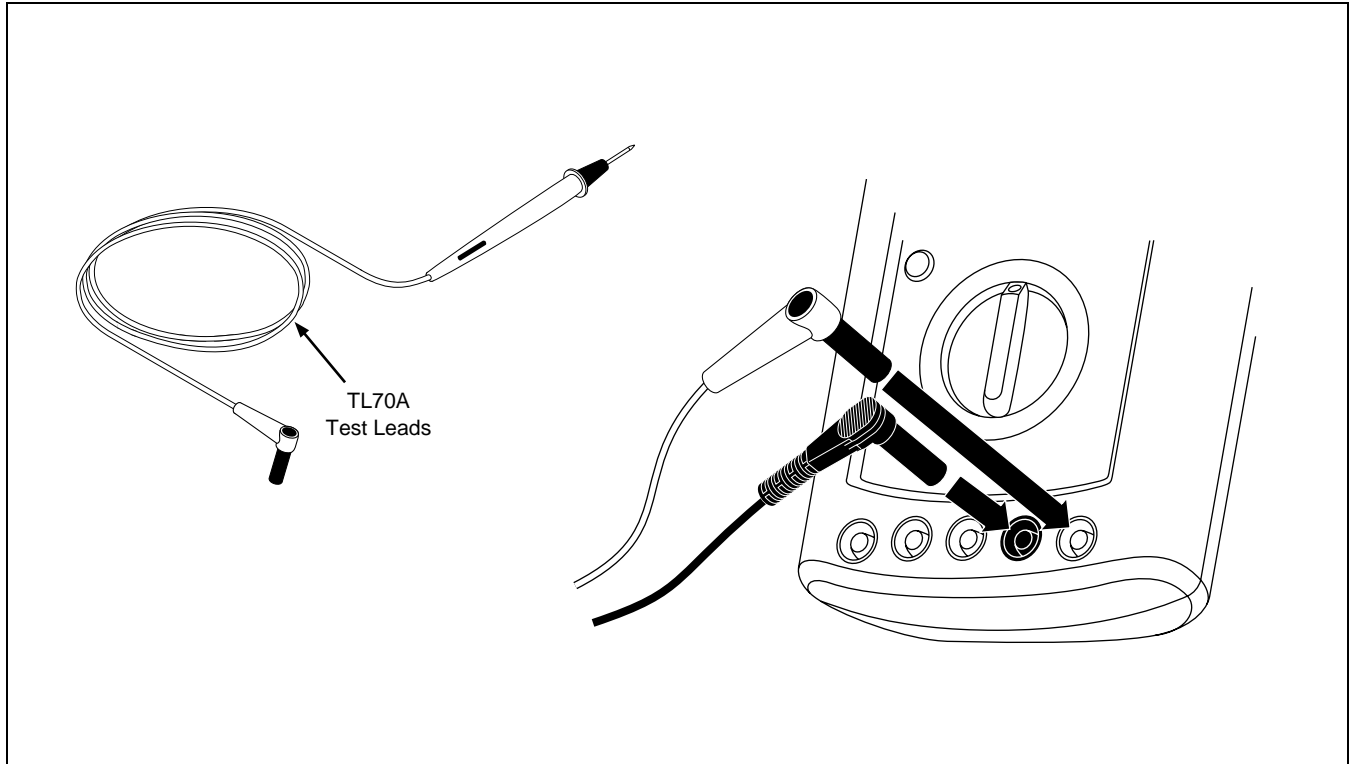

rita0740.eps

Figure 1-3. Test Leads and Measurement Connections

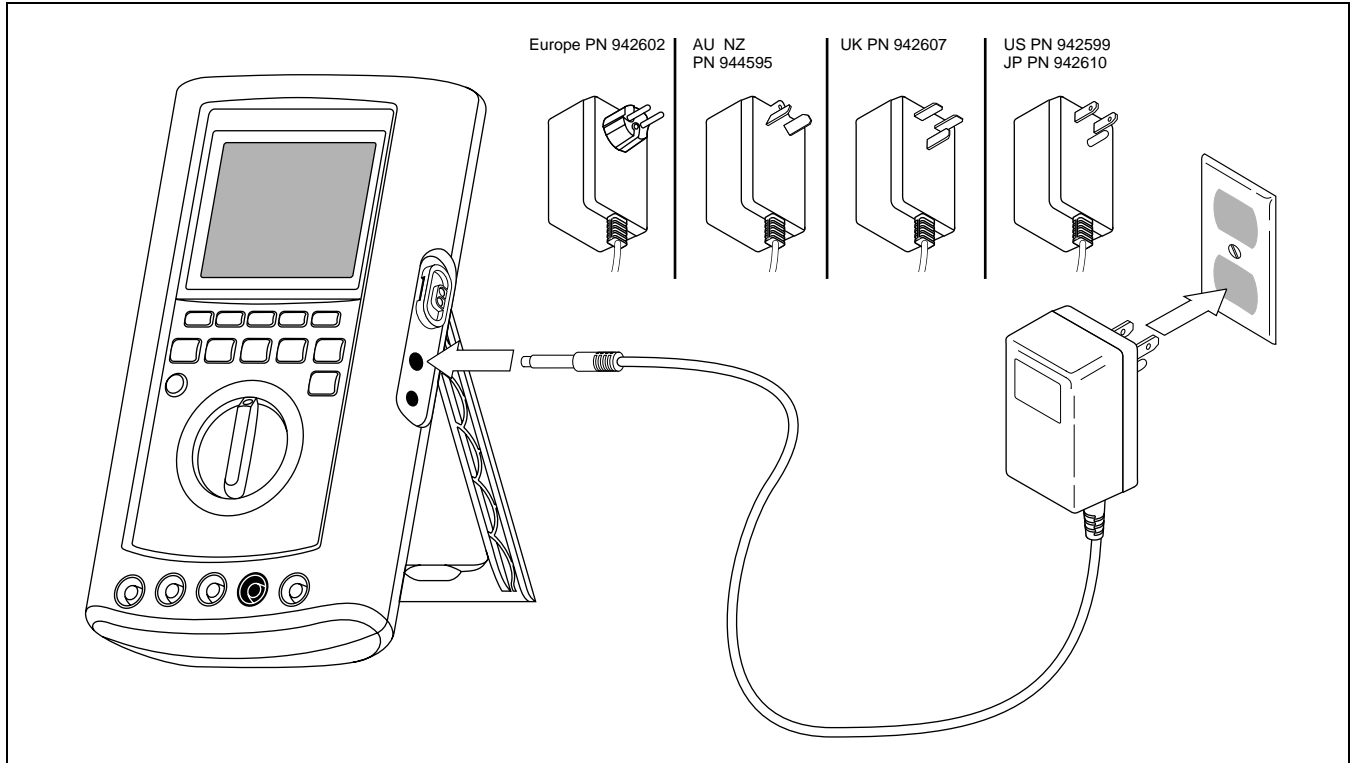

Figure 1-4. Using the Battery Eliminator

rita0770.eps

Table 1-2. A Practice Session







STEP	ACTION	DESCRIPTION
1		<p>CHANGE THE DISPLAY MODE</p> <p>With the GMM still in AC Volts, press first , then  to change the display mode. The screen changes to the View Mode, where the entire screen is used for displaying a waveform. You can repeat this procedure to select any of the display modes available in AC Volts (Combo, Meter, View, and Trend.) Refer to Table 1-3 for an overview of display modes available in each function. Examples of all display modes (Combo, Meter, View, Trend, Logic Test, Auto Diode Test, Component Test, and Sleep) follow this table. Along with the flexibility provided by multiple softkey definitions, display modes increase the versatility of your GMM considerably.</p> <p>Many operations activated in one display mode are retained when you select a new mode. For example, “Rel”, “dB”, Min Max, range, and frequency measurement type are retained.</p>
2		<p>CHANGE THE FUNCTION</p> <p>Rotate the selector to DC Volts (\bar{v}). Observe that the display shifts back to Combo Display Mode. (This is the default mode, as established on the screen you see when you turn the selector to SET UP.)</p>
3		<p>USE THE SOFTKEYS</p> <p>With DC Volts and Combo Mode still active, you can use the DC Volts Softkeys. For example, press  to activate “Rel”: difference readings only are now displayed. Press  again to deactivate “Rel”. Explore all five softkeys in this fashion. Press a key first to activate a selection (label highlighted) and second to disable the selection.</p>

Table 1-2. A Practice Session (cont)



























STEP	ACTION	DESCRIPTION
4		<p>CHANGE THE MEASUREMENT RANGE</p> <p>Press  to access the Range Softkeys, then press  to select a higher range (and activate “Manual” ranging.) Press  to switch back to “Auto” ranging, then press  to return to the DC Volts Softkeys.</p>
5		<p>ENABLE MIN MAX READINGS</p> <p>Press  to start displaying the maximum (“Max”), average (“Avg”), and minimum (“Min”) readings. Press  again to deactivate Min Max.</p>
6		<p>ENABLE TOUCH HOLD</p> <p>Press  to begin holding the last valid reading in the display, even if the test leads are withdrawn from the measurement point.  appears in the upper status line. Press  again to stop Touch Hold</p>
7		<p>CHANGE THE TYPE OF FREQUENCY DISPLAY</p> <p>Press  to access the Frequency Softkeys.</p> <p>The frequency reading (which was in the secondary display) and DC Volts reading (which was in the primary display) are swapped.</p> <p>The softkeys allow you to select different types of frequency measurements (Hz, Duty Cycle, Pulse Width, or Period). Press  to select “Period”, then press  again to return to the DC Volts Softkeys. Primary and secondary displays swap again, and the change to “Period” frequency measurement continues in the secondary display.</p>

Table 1-2. A Practice Session (cont)

STEP	ACTION	DESCRIPTION
8		LOOK AT THE SAVE/PRINT SOFTKEYS Press  to access the Save/Print Softkeys. You can now use the softkeys to exercise various save, recall, and print features. Refer to Chapter 6 for more information. (Waveform save/recall is not available on Model 863.)
9		TURN THE GMM OFF

About This Manual

This Quick Tour has introduced you to all the features necessary to use your GMM. If you are comfortable with this level of information, continue on to Chapter 2 for specific information keyed to each type of measurement. If you want more information about any of the features, refer to Chapters 3 through 8, as follows:

- **Chapter 3:** General descriptions of the GMM controls, screen, and input connections.
- **Chapter 4:** Complete instructions for using the hardkeys (     ).
- **Chapter 5:** View Mode and Trend Mode, in detail.
- **Chapter 6:** Save, Recall, and Print using  and Configuration Changes using SET UP.
- **Chapter 7:** User Maintenance (battery and fuse replacement, etc.)
- **Chapter 8:** Specifications
- **Index**

Combo Mode

Combo	Meter	View	Trend	Exit
--------------	-------	------	-------	------

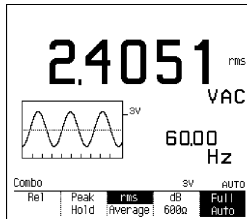

Combo Mode presents both digital and graphical views of the measurement and can be used in VAC, VDC, mV DC, Amps, and mA μ A functions. Combo is the default mode in these functions.

Meter Mode

Combo	Meter	View	Trend	Exit
-------	--------------	------	-------	------

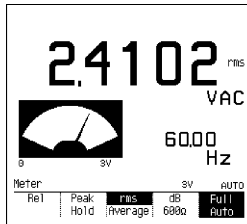

Meter Mode presents both a digital reading and an analog position indication of the measurement. You can select Meter in VAC, VDC, mV DC, Ohms, Amps, and mA μ A functions; you can also set Meter on the SET UP screen as the default mode in these functions.

Meter is the only mode available in Diode and Capacitance Test.

View Mode

Combo	Meter	View	Trend	Exit
-------	-------	-------------	-------	------

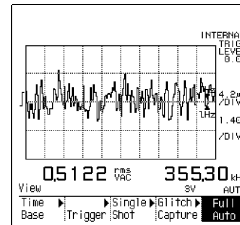

View Mode displays a full-screen waveform. It is available in VAC, VDC, mV DC, Amps, and mA μ A functions.

Trend Mode

Combo	Meter	View	Trend	Exit,
-------	-------	------	--------------	-------

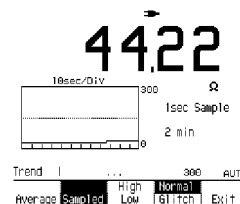

Trend Mode presents a digital reading of the measurement and plots that reading over time. It is available in VAC, VDC, mV DC, Ohms, Amps, and mA μ A functions.

Auto Diode Test Mode

	Meter			Exit
--	-------	--	--	------

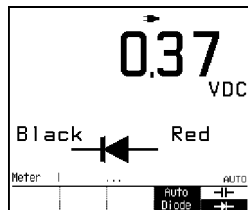

Auto Diode Test presents a DC voltage reading and a symbol representing the state of the diode (forward, reverse, open, short, unknown.)

Logic Test Mode

Logic				Exit
-------	--	--	--	------



Logic Test shows icons representing high and/or low logic state along with frequency and voltage readings of logic activity.

Component Test Mode

Comp. Test				Exit
------------	--	--	--	------

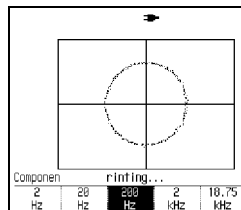

Component Test displays a unique pattern representing the characteristics of the in-circuit component being tested. This signature can resemble a straight line for purely resistive components or an ellipsoid for frequency-sensitive components.







Sleep Mode



 restores the screen.

Sleep Mode comes on automatically during battery operation if you do not press a key or turn the selector for approximately 20 minutes.

Table 1-3. Functions and Display Modes

FUNCTION									
								LOGIC	COMPONENT TEST
Combo	•	•	•			•	•		
Meter	•	•	•	•	•	•	•		
View	•	•	•			•	•		
Trend	•	•	•	•		•	•		
Auto Diode					•				
Logic								•	
Comp.Test									•

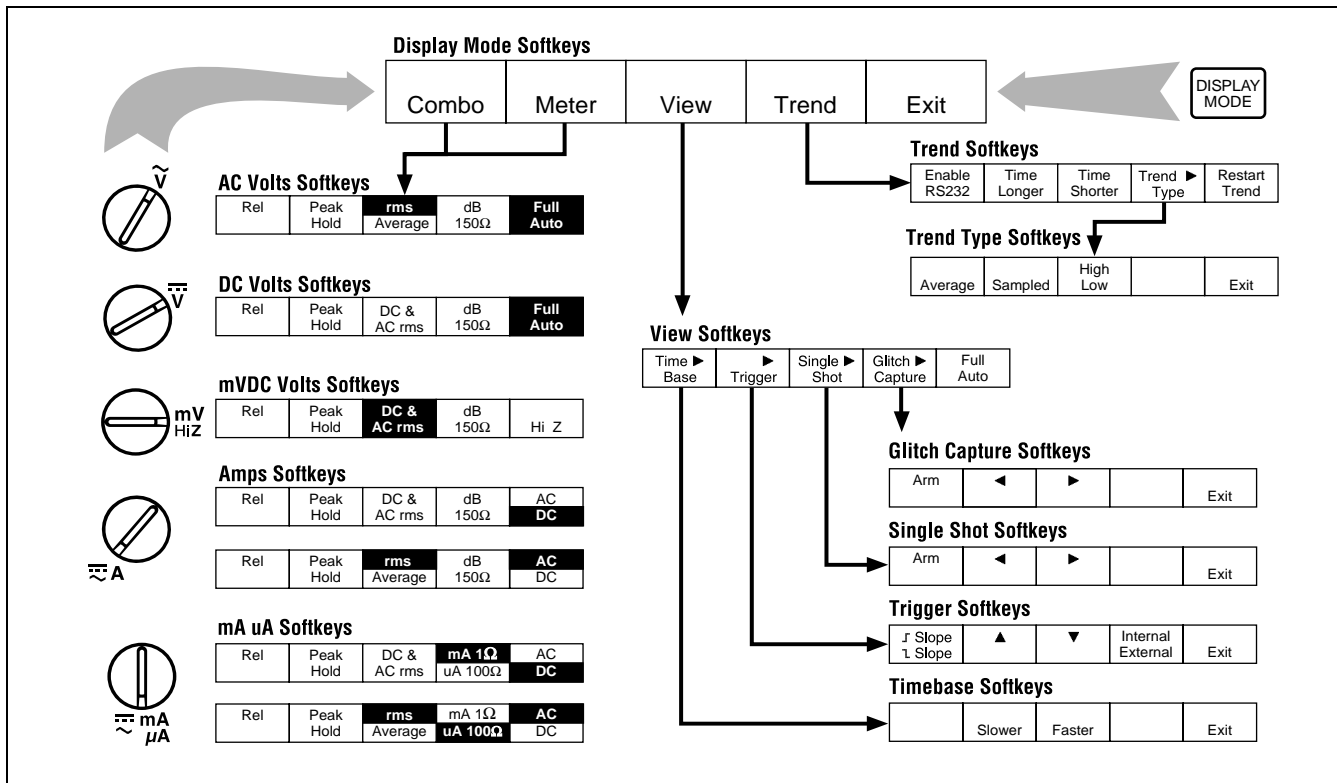

rita0330.eps

Figure 1-5. Volts and Amps Measurement Map

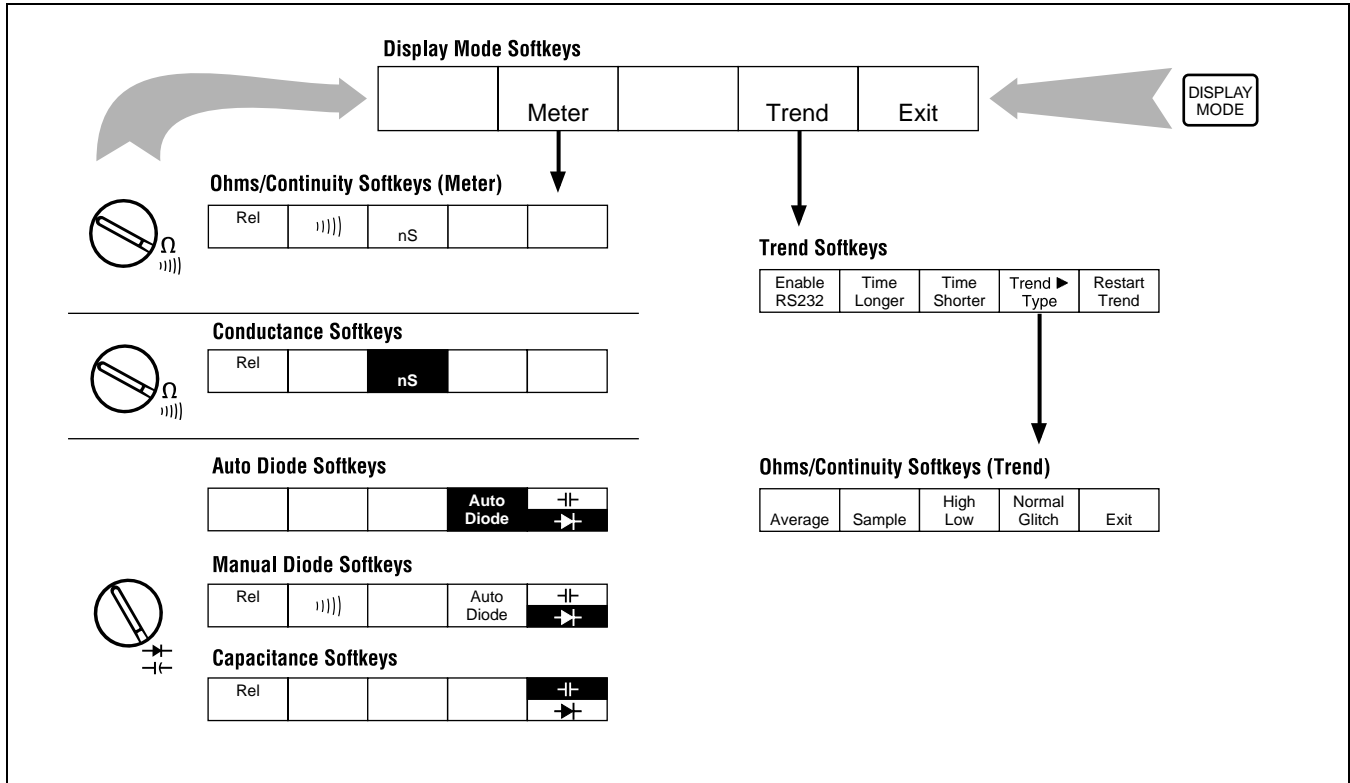

Figure 1-6. Ohms, Conductance, Diode Test, Capacitance Map

rita0340.eps

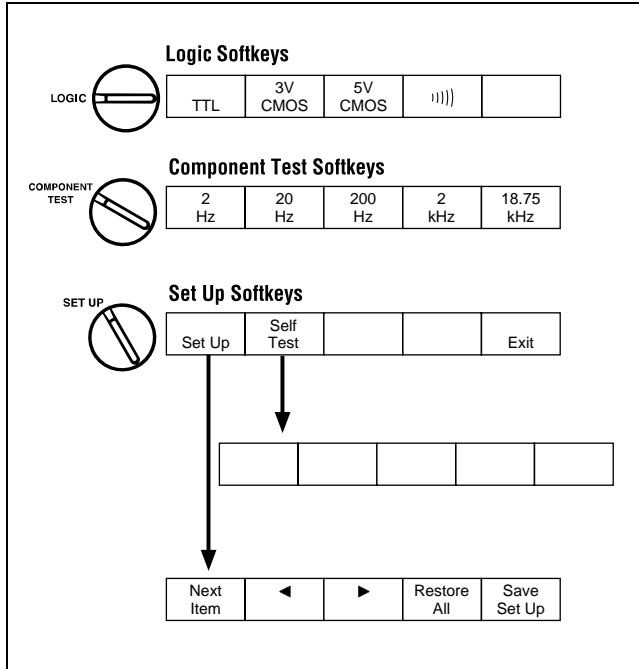

Figure 1-7. LOGIC Test, Component Test, Set Up rita0350.eps

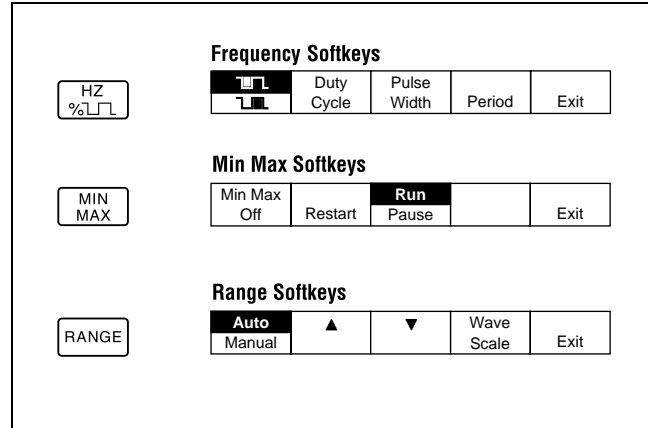

Figure 1-8. Hz Min Max, and Range Map rita0360.eps

Chapter 2

Making Measurements

Note

Recharge the NiCd battery pack before using the 867B. See *Battery Considerations* in Chapter 3.

Introduction

This chapter shows overall procedures for making measurements in any of the rotary selector positions. Necessary input connections are shown. Softkeys used with each of the display modes available for the selected function are also shown.

Using the Selector

To begin using the GMM™, turn the selector to any of the indicated functions. Softkey labels momentarily identify the display modes available for this function, then proceed to list the softkeys available with this function.

Softkeys

Any selector setting or hardkey press provides you with a unique set of softkey labels along the bottom

of the display. These labels define the present uses for the five blue keys that are positioned immediately below the display.

In Combo and Meter display modes, some labels are used with several different selector positions; see Table 2-1 for descriptions of these common labels. Other labels are unique for the selector position; these labels are defined in this chapter as needed.

View and TrendGraph™ softkey labels are common for all functions that can use these modes; refer to Chapter 5 for a full discussion.

Hardkeys

Although hardkeys can generally be pressed at any time, certain feature combinations are not allowed.

The GMM rejects any hardkey press that is not allowed and tells you so with a long beep.

Table 2-1. Common Combo/Meter Mode Softkeys

KEY	FUNCTION	DESCRIPTION
<input type="text" value="1"/>	Rel	Start relative readings in the primary display (REL is displayed). The relative reference (stored when "Rel" is selected) appears with the softkey.
<input type="text" value="2"/>	Peak Hold	Peak Hold displays the highest and lowest peak values encountered in the present measurement function. These values replace either the secondary reading in Meter Mode or the graphical display in Combo Mode.
<input type="text" value="3"/>	rms Average	Toggle between true "rms" ("rms" annunciator on in display) and "Average" (average responding, rms indicating - no annunciator) readings in any ac function. The rms/Average selection remains in effect until you change the selector position. The rms/Average settings made in one display mode are automatically made for other display modes in the same selector position. "Average" or "rms" can be set as the standard selection on the SET UP display.
<input type="text" value="3"/>	DC & AC rms	In VDC or mV DC, use the full display to show the numerical "DC" and "AC rms" values. Press <input type="text" value="3"/> again to return to the original display.
<input type="text" value="4"/>	dB	Show dBm values in the primary display. The "dB" value shown above this softkey identifies the resistance used in computing dBm; 600Ω is the standard value. You can change this value from the SET UP display. (Rotate the selector to SET UP, change the reference selection, then rotate the selector back to the original ac function.)

Table 2-1. Common Combo/Meter Mode Softkeys (cont)

KEY	FUNCTION	DESCRIPTION
5	Full Auto	The GMM automatically selects range, trigger level, and time base (in VAC and VDC for an optimum display. If “Manual” is selected for Range in the SET UP screen, “Full Auto” does not come on. Selecting “Manual” from the Range Softkeys deselects “Full Auto”.
5	Hi Z	Enter the high input impedance mode in mV DC. “Hi-Z” appears at the top of the display. Press again to return to “mV”. Activating “DC & AC rms” automatically cancels “Hi-Z”. You cannot use Peak Hold with HiZ.
5	AC DC	Toggle between “DC” and “AC” amps or mA μ A measurements. “DC” is the standard configuration.
4)))	Activate the beeper for continuity or Manual Diode testing; a beep then sounds each time the voltage drop passes below 0.7V (Continuity) or the logic activity indicator flashes (LOGIC Testing). A short circuit results in a continuous tone. If the reading goes above 30 volts, a possibly dangerous voltage exists on the inputs but is not displayed. Therefore, the safety indicator (⚡) lights.

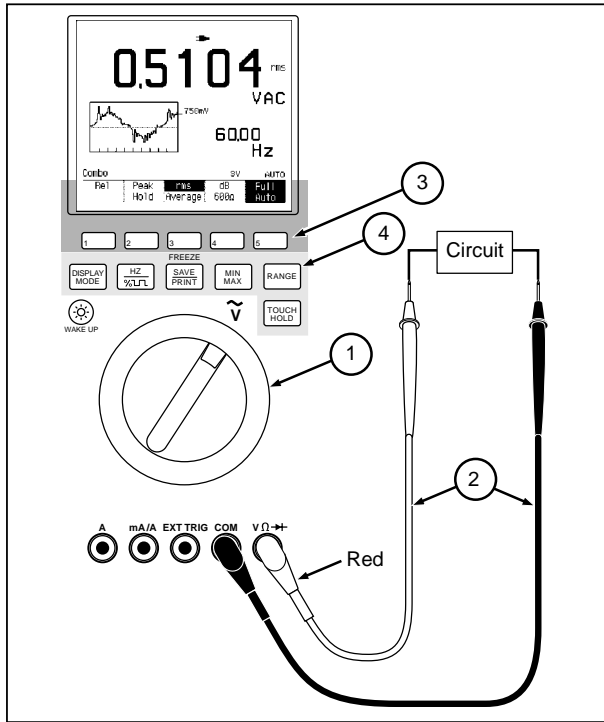

rita0550.eps

Figure 2-1. AC Volts Measurements

Measuring AC Volts

- ① Turn the Selector to Volts AC. Display mode softkeys appear momentarily; press a softkey to select a new mode, or wait briefly to accept the presently highlighted selection.
- ② Connect the test leads as shown.
- ③ Use the AC Volts Softkeys as discussed below.
- ④ All hardkeys are available in Volts AC.

At any time, press **DISPLAY MODE** and one of the softkeys (Combo, Meter, View, or Trend) to show the measurement in a different display mode.

Using the AC Volts Softkeys

Combo or Meter Mode: refer to Table 2-1.

Rel	Peak Hold	rms Average	dB 600Ω	Full Auto
-----	--------------	----------------	------------	--------------

View Mode: refer to Chapter 5.

Time ► Base	► Trigger	Single ► Shot	Glitch ► Capture	Full Auto
----------------	--------------	------------------	---------------------	--------------

Trend Mode: refer to Chapter 5.

Enable RS232	Time Longer	Time Shorter	Trend ► Type	Restart Trend
-----------------	----------------	-----------------	-----------------	------------------

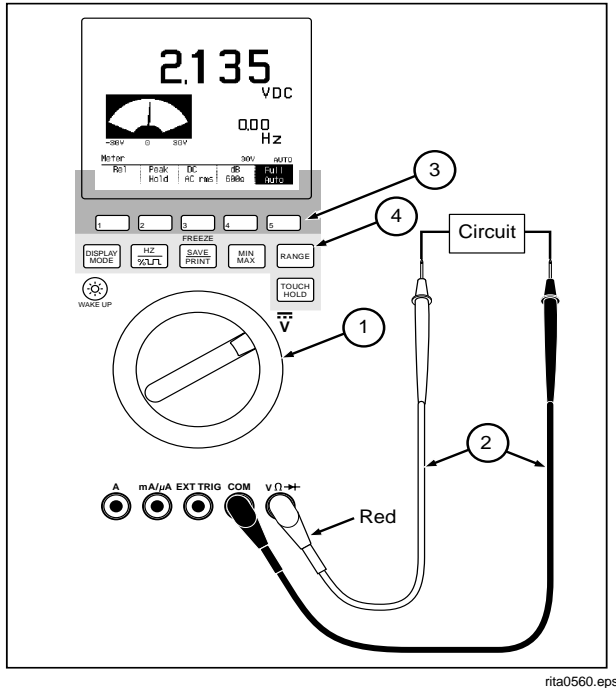

rita0560.eps

Figure 2-2. DC Volts Measurements

Measuring DC Volts

- ① Turn the Selector to Volts DC. Display mode softkeys appear momentarily; press a softkey to select a new mode, or wait briefly to accept the presently highlighted selection.
- ② Connect the test leads as shown.
- ③ Use the DC Volts Softkeys as discussed below.
- ④ All hardkeys are available in Volts DC.

At any time, press **DISPLAY MODE** and one of the softkeys (Combo, Meter, View, or Trend) to show the measurement in a different display mode.

Using the DC Volts or mV DC Softkeys

Combo or Meter Mode: refer to Table 2-1.

Rel	Peak Hold	DC & AC rms	dB 600 Ω	Full Auto
-----	--------------	----------------	-------------	--------------

View Mode: refer to Chapter 5.

Time ▶ Base	▶ Trigger	Single ▶ Shot	Glitch ▶ Capture	Full Auto
----------------	--------------	------------------	---------------------	--------------

Trend Mode: refer to Chapter 5.

Enable RS232	Time Longer	Time Shorter	Trend ▶ Type	Restart Trend
-----------------	----------------	-----------------	-----------------	------------------

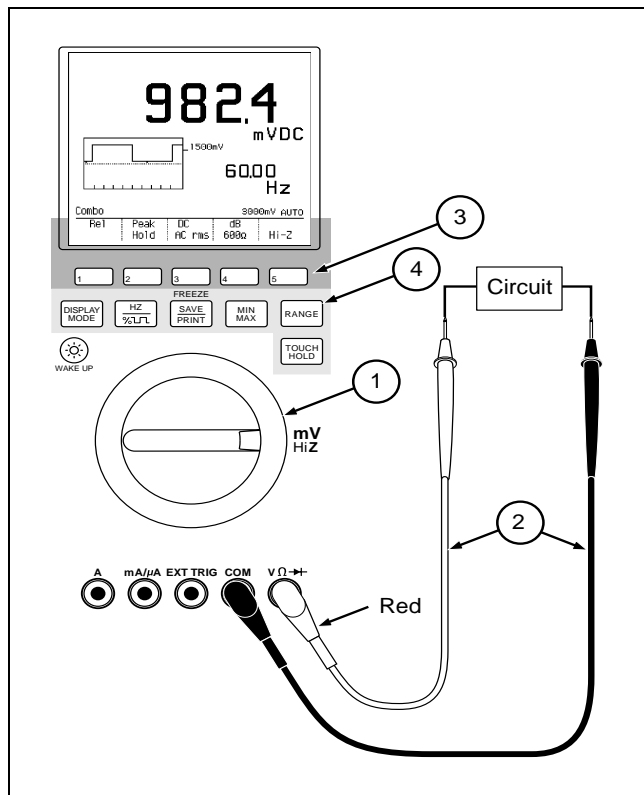

rita0570.eps

Figure 2-3. DC Millivolt Measurements

Measuring DC Millivolts

- ① Turn the Selector to mV DC. Display mode softkeys appear momentarily; press a softkey to select a new mode, or wait briefly to accept the presently highlighted selection.
- ② Connect the test leads as shown.
- ③ Use the mV DC Softkeys as discussed above.
- ④ All hardkeys are available in millivolts DC.

At any time, press **DISPLAY MODE** and one of the softkeys (Combo, Meter, View, or Trend) to show the measurement in a different display mode.

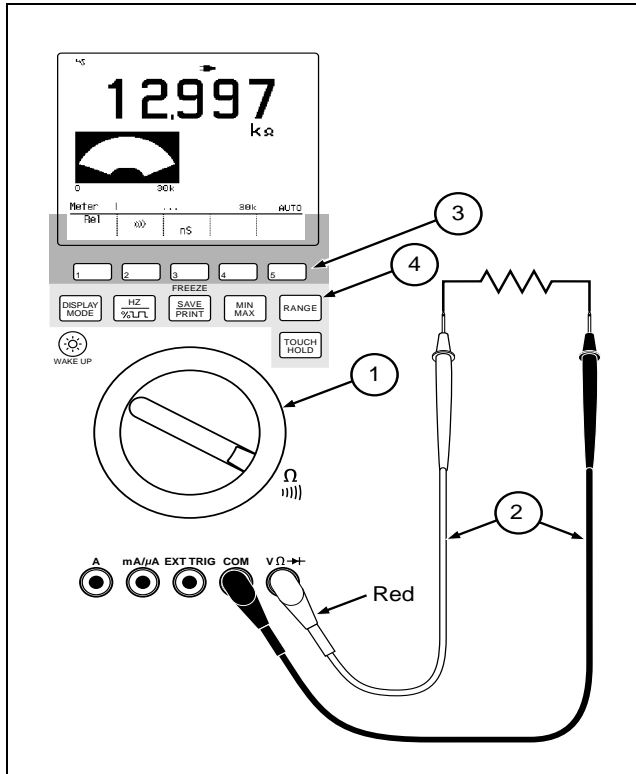

Figure 2-4. Ohms, Continuity, and Conductance Measurements

Measuring Ohms, Continuity, and Conductance

- ① Turn the Selector to Ohms. Softkeys for Meter and Trend Modes appear momentarily. Wait briefly to accept Meter Mode, or press **4** to select Trend Mode.
- ② Connect the test leads as shown.
- ③ Use the Ohms (Meter or Trend Mode) Softkeys as discussed below.
- ④ **Hz** is not available in Ohms; all other hardkeys can be used.

At any time, press **DISPLAY MODE** and one of the softkeys (Combo, Meter, View, or Trend) to show the measurement in a different display mode.

Using the Ohms Meter Mode Softkeys

Rel	()	nS		
-----	--------	----	--	--

(2) (||||) enables the Continuity beeper. The GMM beeps each time a low resistance continuity measurement is encountered. For example, beginning in the 300 Ω range, the beeper goes on when the resistance passes below 32 Ω and off when the resistance rises above 132 Ω . You can select a different range after activating the Continuity beeper; each range uses different beeper on and off points. For a list of these on and off points, see Continuity Specifications in Chapter 8 of this manual.

(3) (nS) begins conductance (nanosiemens “nS”) readings in the primary display. Measurement ranges are 300 nS and 3000 nS. (Megohm-only readings continue in the secondary display.) Press (3) again to return to ohms (Ω) primary readings (all ranges). Selecting conductance (nS) automatically cancels active Min Max, “Peak Hold”, Touch Hold, Continuity, and “Rel, and resets the Trend plot. Frequency readings are not available in conductance or ohms.

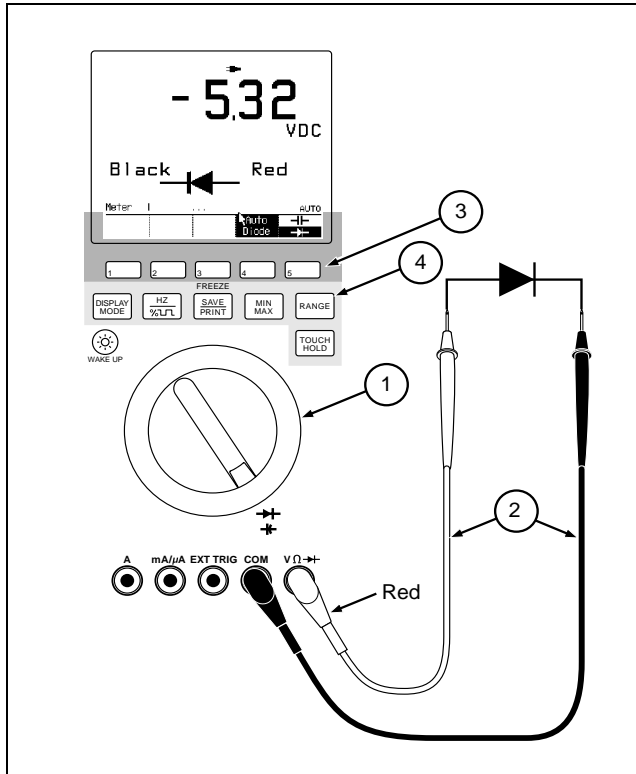

nita0590.eps

Figure 2-5. Diode Test and Capacitance Measurements

Testing Diodes and Measuring Capacitance

- ① Turn the Selector to Diode/Capacitance. The GMM assumes Meter Mode.
- ② Connect the test leads as shown.
- ③ Use the Diode/Capacitance Softkeys as discussed below. “Rel” and “|)|)|)” (Continuity) are not available in Auto Diode.
- ④ **TOUCH HOLD** and **HZ %LFL** are not allowed in Diode Test.

Pressing **RANGE** is not allowed in Diode Test; a long beep sounds. **RANGE** is allowed in Capacitance.

Using the Auto Diode Softkeys

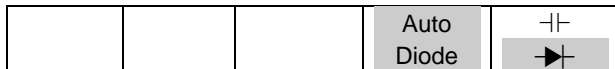

4 toggles between AutoDiode and Manual Diode. When selected, Auto Diode is highlighted and one of the following icons is displayed:

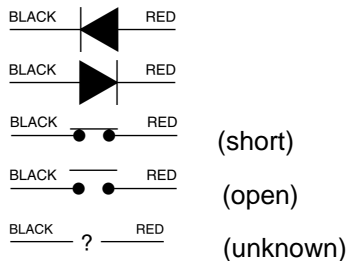

5 () is highlighted for Diode Testing. Pressing this key toggles to Capacitance () and disables Diode Testing.

“Rel” and “” (Continuity) are not available in Auto Diode.

Using the Manual Diode Softkeys

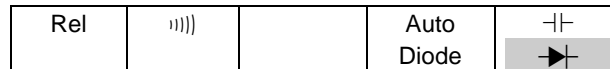

4 selects Manual Diode testing (Auto Diode not highlighted). Selecting Manual Diode initially sets “Rel” and “” (Continuity) off.

In Manual Diode test, voltage is developed across the component(s) by a test current (approximately 1 mA with the test leads shorted) from the meter. Voltage is read on a 0 to +3.000V range that can measure up to five silicon diode or transistor junctions in series. For a silicon diode, the typical forward voltage is about 0.6V. Voltages greater than 3.00V or open test leads produce an overload (OL) reading. If the digital reading is the same in both directions, the diode junction is probably shorted. If the display reads OL in both directions, the diode junction is probably open. To protect sensitive devices the open test lead voltage will not exceed 3.1V. Negative inputs (from an external power source) are not suppressed.

Using the Capacitance Softkeys



5 (⇄) toggles between Capacitance Measurement and Diode Testing.

Measuring AC and DC Amps

- ① Turn the Selector to Amps. Display mode softkeys appear momentarily; press a softkey to select a new mode, or wait briefly to accept the presently highlighted selection.
- ② Connect the test leads as shown.
- ③ Use the Amps Softkeys as discussed below.
- ④ All hardkeys are available in Amps.

At any time, press **DISPLAY MODE** and one of the softkeys (Combo, Meter, View, or Trend) to show the measurement in a different display mode.

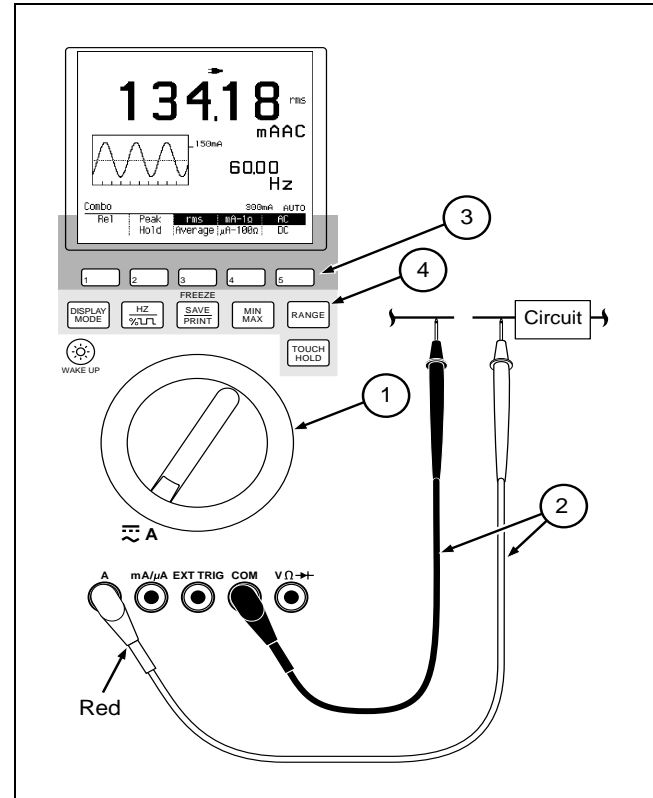

Figure 2-6. Amps Measurements

rita0600.eps

Using the Amps Softkeys

AC Amps (Combo/Meter Mode): refer to Table 2-1.

Rel	Peak Hold	rms Average	dB 600 Ω	AC DC
-----	--------------	----------------	--------------------	----------

DC Amps (Combo/Meter Mode): refer to Table 2-1.

Rel	Peak Hold	DC & AC rms	dB 600 Ω	AC DC
-----	--------------	----------------	--------------------	----------

View Mode (AC or DC Amps): refer to Chapter 5.

Time ► Base	► Trigger	Single ► Shot	Glitch ► Capture	Full Auto
----------------	--------------	------------------	---------------------	--------------

Trend Mode (AC or DC Amps): refer to Chapter 5.

Enable RS232	Time Longer	Time Shorter	Trend ► Type	Restart Trend
-----------------	----------------	-----------------	-----------------	------------------

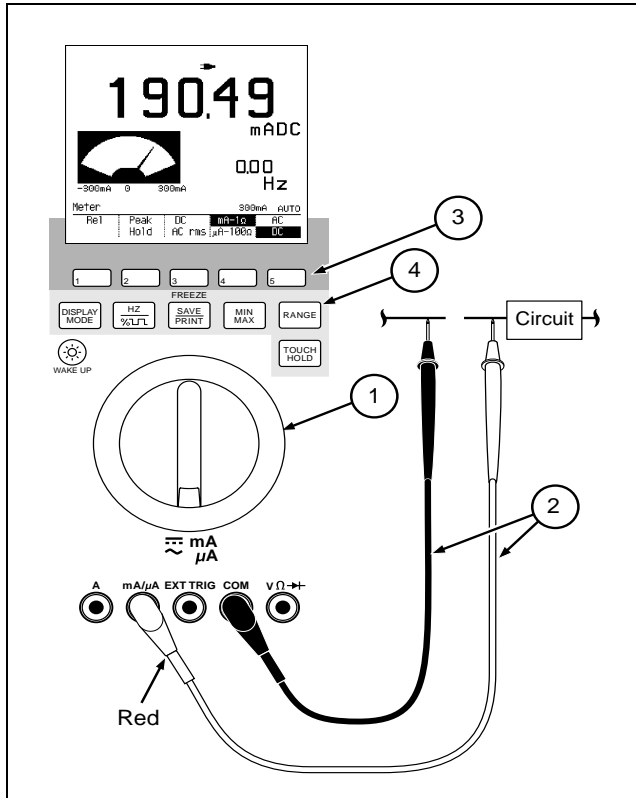

rita0610.eps

Figure 2-7. Milliamp and Microamp Measurements

Measuring AC and DC Milliamps and Microamps

- ① Turn the Selector to mA μ A. Display mode softkeys appear momentarily; press a softkey to select a new mode, or wait briefly to accept the presently highlighted selection.
- ② Connect the test leads as shown.
- ③ Use the mA μ A Softkeys as discussed below.
- ④ All hardkeys are available in mA μ A.

At any time, press **DISPLAY MODE** and one of the softkeys (Combo, Meter, View, or Trend) to show the measurement in a different display mode.

Using the mA μ A Softkeys

AC mA μ A (Combo/Meter Mode): refer to Table 2-1.

Rel	Peak Hold	rms Average	mA 1 Ω μ A 100 Ω	AC DC
-----	--------------	----------------	---------------------------------------	----------

DC mA μ A (Combo/Meter Mode): refer to Table 2-1.

Rel	Peak Hold	DC & AC rms	mA 1 Ω μ A 100 Ω	AC DC
-----	--------------	----------------	---------------------------------------	----------

View Mode (AC or DC mA μ A): refer to Chapter 5.

Time \blacktriangleright Base	\blacktriangleright Trigger	Single \blacktriangleright Shot	Glitch \blacktriangleright Capture	Full Auto
------------------------------------	----------------------------------	--------------------------------------	---	--------------

Trend Mode (AC or DC mA μ A): refer to Chapter 5.

Enable RS232	Time Longer	Time Shorter	Trend \blacktriangleright Type	Restart Trend
-----------------	----------------	-----------------	-------------------------------------	------------------

 (mA 1 Ω ; μ A 100 Ω) In Combo or Meter Mode, this softkey toggles between “mA” and “ μ A” measurements. (“mA” is the standard configuration.) Each toggle cancels Min Max, Touch Hold, “Peak Hold”, and Rel and resets the Trend plot. “1 Ω ” and “100 Ω ” represent the shunt resistances used for mA and μ A, respectively.

NOTE

If measuring <3 mA, using 3000.0 μ A range will give you better resolution.

The GMM autoranges in “mA” or “ μ A” (two ranges are available for each selection) but does not autorange between “mA” and “ μ A”. If manual range is selected, “mA” assumes the 30 mA range, and “ μ A” assumes the 300 μ A range. The μ A ranges are not available on Model 863.

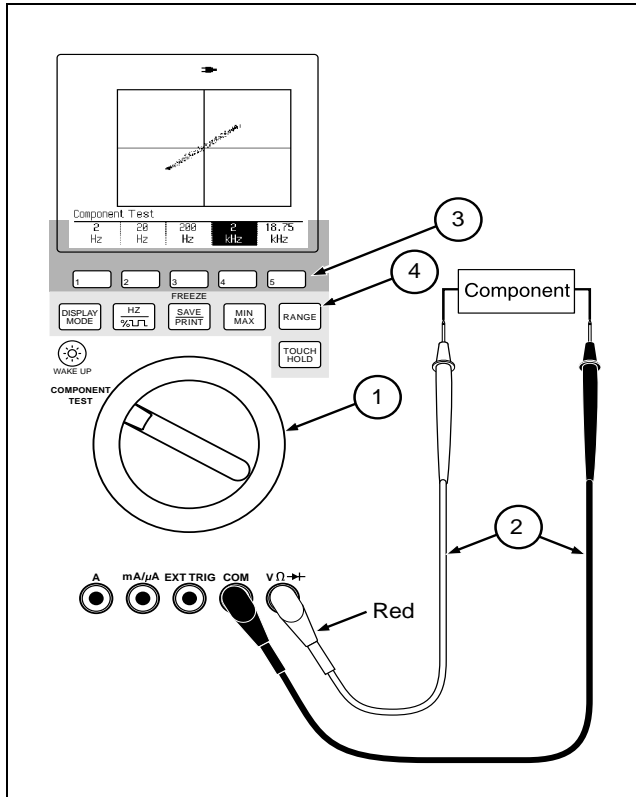

 swaps the mA or μ A in the primary display with the frequency reading in the secondary display. Subsequent changing between mA and μ A or DC and AC swaps the primary and secondary displays back.



rita0630.eps

Figure 2-8. Component Test

Using Component Test

- ① Turn the Selector to COMPONENT TEST.
- ② Connect the test leads as shown.
- ③ Use the COMPONENT TEST Softkeys as discussed below.
- ④ Since COMPONENT TEST uses its own display mode, only , , and  operate normally.

Caution

To avoid damage to the circuit, Component Test should be used only on unpowered circuits.

Using COMPONENT TEST Softkeys

2 Hz	20 Hz	200 Hz	2 kHz	18.75 kHz
---------	----------	-----------	----------	--------------

Use COMPONENT TEST to measure the characteristics of a passive component (in or out of circuit, no power applied). When you use the General Measurement Connection, the GMM provides an ac stimulus signal to the component and plots the voltage drop against the current measurement. The resulting pattern provides information about passive circuit conditions.

Generally, resistors exhibit some form of straight or angled line. Diodes or transistors appear as straight lines with right-angle ends. Frequency-sensitive components (inductors, capacitors) portray some form of an ellipsoid pattern based on the current-voltage phase shift dictated by the stimulus frequency and the inductance or capacitance. Combinations of these components exhibit hybrid patterns. Although the number of such COMPONENT TEST signatures can be limitless, you will become familiar with a few characteristic signature patterns that will greatly aid in component

and circuit diagnosis. Some sample signature patterns are shown on the following page.

Press one of the softkeys to select the frequency of the stimulus signal. For components that do not change impedance with frequency (resistors, diodes, and transistors), the frequency selection is not critical for a meaningful display. For components that do change impedance with frequency (inductors and capacitors), an appropriate COMPONENT TEST frequency selection is necessary. Inductance greater than 8.5 mH can be displayed. Capacitance can be displayed according to the guidelines in Table 2-2.

Table 2-2. Component Test (Capacitance)

Frequency	Capacitance
2 Hz	0.72 μ F to 72 μ F
20 Hz	0.072 μ F to 7.2 μ F
200 Hz	7200 pF to 0.72 μ F
2 kHz	720 pF to 0.072 μ F
18.75 kHz	77 pF to 7700 pF

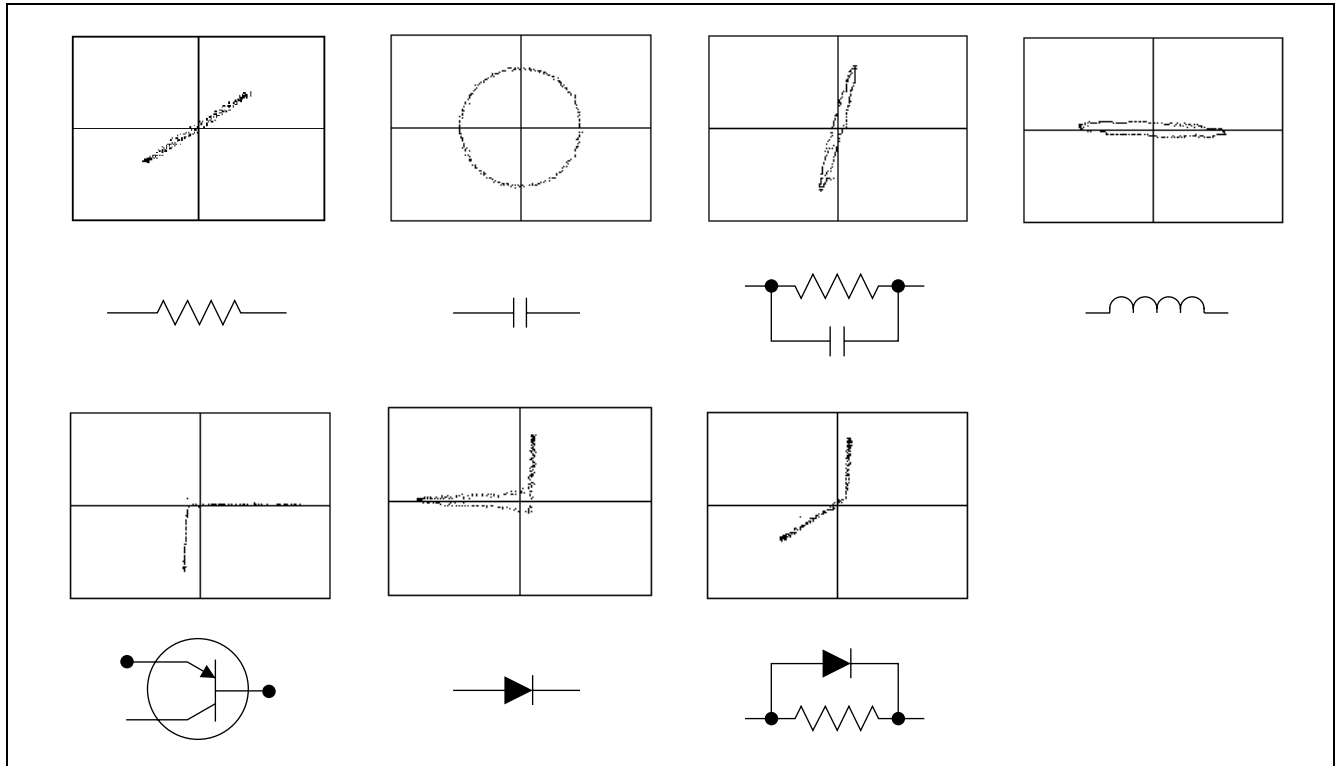

Figure 2-9. Component Test Patterns

rita0800.eps

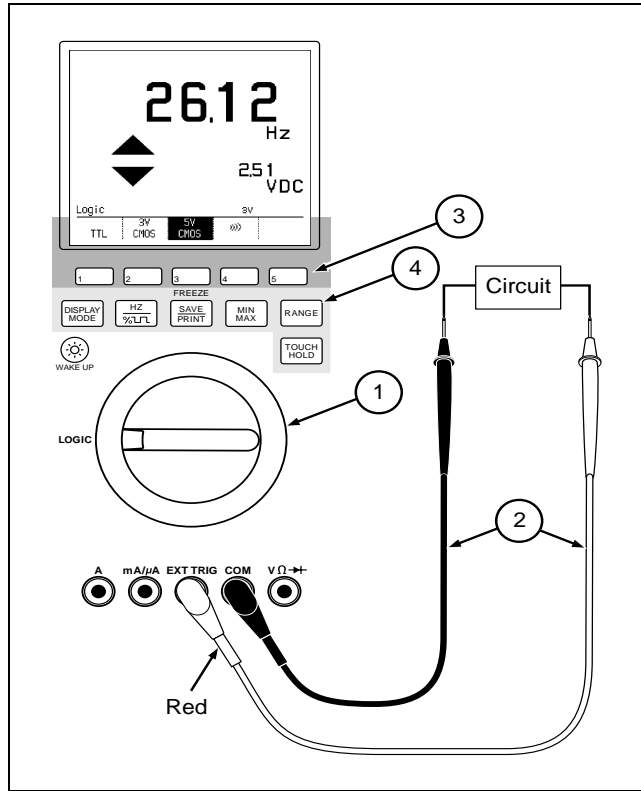

Figure 2-10. LOGIC Testing

rita0620.eps

Testing for Logic Activity

(not available on Model 863)

- ① Turn the Selector to LOGIC.
- ② Connect the test leads as shown.
- ③ Use the LOGIC Testing Softkeys as shown.
- ④ The following hardkeys can be used:



For the logic activity indicator, ▲ represents a logic high, and ▼ represents a logic low. A horizontal bar represents an indeterminate condition (no high or low detected since the previous reading.) The logic indicator flashes at a 10 Hz rate for activity faster than 10 Hz or at the actual rate if activity is slower than 10 Hz.

The actual logic frequency is shown in the primary display. Frequencies to 10 MHz and higher can be measured. DC Volts levels are shown in the secondary display.

Using the Logic Test Softkeys

TTL	3 V CMOS	5 V CMOS	()	
-----	-------------	-------------	--------	--

and select the trigger point for the logic activity indicator and frequency reading. “5V CMOS” is the standard configuration. A new selection cancels the old selection. See Chapter 8 for threshold values.

(||||) activates the beeper; a beep then sounds to indicate logic activity. The beeper is off in the standard configuration. If the reading goes above 30 volts, the safety indicator (⚡) lights.

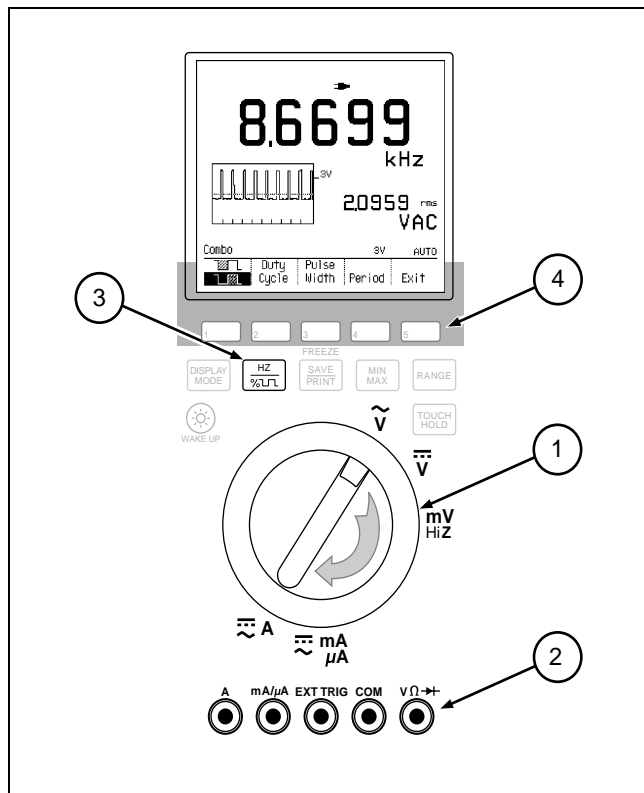

rita0640.eps

Figure 2-11. Frequency Measurements

Measuring Frequency



You can measure low frequency signals (2 Hz to 2 MHz) with the procedure shown below. For higher frequency signals (to 10 MHz and above), use the Logic Test function.



- ① Turn the Selector to any of the indicated positions. (Frequency can be measured in VAC, VDC, mV DC, A, and mA μ A.)
- ② Connect the test leads as required for the selected measurement position.
- ③ Press **Hz**.
- ④ Use the Frequency Softkeys as discussed below.

The frequency counter trigger levels are set to predetermined levels while the GMM is in the single trigger mode. In dual trigger mode, the frequency counter trigger levels are set initially (full auto) based on a percentage of the input signal. You can change both levels with the Trigger Softkeys in the view mode. Manually setting these levels may cause the frequency counter to be unstable or not count at all.

Either press the Full Auto softkey or manually adjust the trigger levels in view mode to obtain a stable frequency reading.

Using the Frequency Softkeys

	Duty Cycle	Pulse Width	Period	Exit
				

selects low side  or high side  pulse for frequency, period, duty cycle, and pulse-width measurements. Positive is the standard selection.

(Duty Cycle) selects duty cycle measurements for the pulse (negative going or positive going) selected with .

(Pulse Width) selects pulse-width measurements for the pulse (negative going or positive going) selected with .

(Period) selects period measurements of the full signal (negative going or positive going).

(Exit) returns to the Display Mode Softkeys.



Frequency Operation

The frequency measurement type (Hz, duty cycle, pulse width, or period) normally appears in the secondary display.  swaps primary and secondary display readings and accesses the Frequency Softkeys. You can then select a new frequency type.

Press  a second time to restore the selector function to the primary display and move the frequency reading back to the secondary display.

Press  at any time to swap primary and secondary readings.

Frequency Considerations

 interacts with other features in several ways. Generally, features that are active in the selector function are retained when you press . For example, active features in VAC, such as “Peak Hold”, “rms” or “Average”, or “dB” would stay activated.

If you press any other key while the Frequency Softkeys are active, the Frequency Softkeys are deactivated and the frequency type is retained.



 cancels Min Max, Touch Hold, “Rel”, and the Continuity functions and resets the plot in Trend Display Mode.



Turning the selector to another position resets the frequency measurement display to “Hz” in the secondary display. Duty cycle, pulse width, and period selections are not retained.





If you press  while the selector is set to Ohms, Conductance, Diode Test, COMPONENT TEST, LOGIC, or SET UP, the GMM emits a long beep and ignores the key press.

The frequency measurement type (Hz, duty cycle, pulse width, period) does not change when you change display mode; the type remains in the primary or secondary display as last selected.

In Amps functions, moving between “AC” and “DC” or “mA” and “ μ A” swaps the frequency reading back to the secondary display.

Pressing  cancels Touch Hold. While  is active, you can press  to activate Touch Hold, which then works normally with the frequency type shown in the primary display.

Pressing  cancels Min Max. Pressing  when  is active accesses the Min Max Softkeys but retains frequency as the primary function.

If you press  when  is active, the GMM beeps and ignores the key press. While  is active, pressing  accesses the Print/Save Softkeys, retaining the frequency primary display selection.

Chapter 3

Some General Descriptions

Introduction

This chapter adds some details about GMM operation and measurement connections.

Battery Considerations

New alkaline (AA) cells provide a minimum of 4 hours operation. A fully charged NiCd battery pack (BP7217) typically provides 8 hours operation. Connect the battery eliminator to recharge the NiCd battery pack for the 867B. Fully charge the battery pack before using the 867B. External charging (use Battery Charger BC-7210 - not provided) must be used to charge a NiCd battery pack for Model 863. Refer to Chapter 7 (User Maintenance). Model 867B uses an internal two-state charger. The initial charge state is at approximately 170 mA (± 30 mA) to allow for full overnight charging (16 hours minimum). The

second charge state is at approximately 40 mA (± 15 mA) to allow for battery charge maintenance without full charging from a discharged condition.

Display Blanking (Sleep Mode)

During battery operation the display will blank after about 20 minutes if no controls have been changed. Press the wake up key once to restore the display.

If the battery eliminator is connected, these battery saving features are not used. If a time-dependent measurement (Min Max, Trend, etc.) is in progress during battery operation, the backlight will go off after 20 minutes, but the Model 863 display will not blank until a low battery condition is reached. When the display blanks, no measurements are taken.

Using the Backlight (Model 867B)

If the display is already on, pressing  toggles the backlight power level.



NOTE

If the display is blank and cannot be recovered, contrast may be off the scale. Restore contrast to mid-scale with the following shortcut: turn the selector to SET UP and avoid touching any key until the display reappears (about 15 seconds). Press  to store this setting, then turn the selector to the desired function.

Adjusting Contrast

Adjust contrast as follows:

1. Rotate the selector to SET UP.

2. With “LCD Contrast” highlighted, press  or  to change the contrast. This setting becomes effective immediately.
3. If you want to make this setting part of the power-up defaults, press . The GMM then assumes this contrast setting each time you turn it on.
4. Rotate the selector to the desired measurement or test function.

When the GMM is left idle in Setup mode for 12 seconds, the contrast will return to the LCD’s default setting.

General Features

Refer to Figure 3-1 and Table 3-1 for an overall description of the controls, displays, and connections.

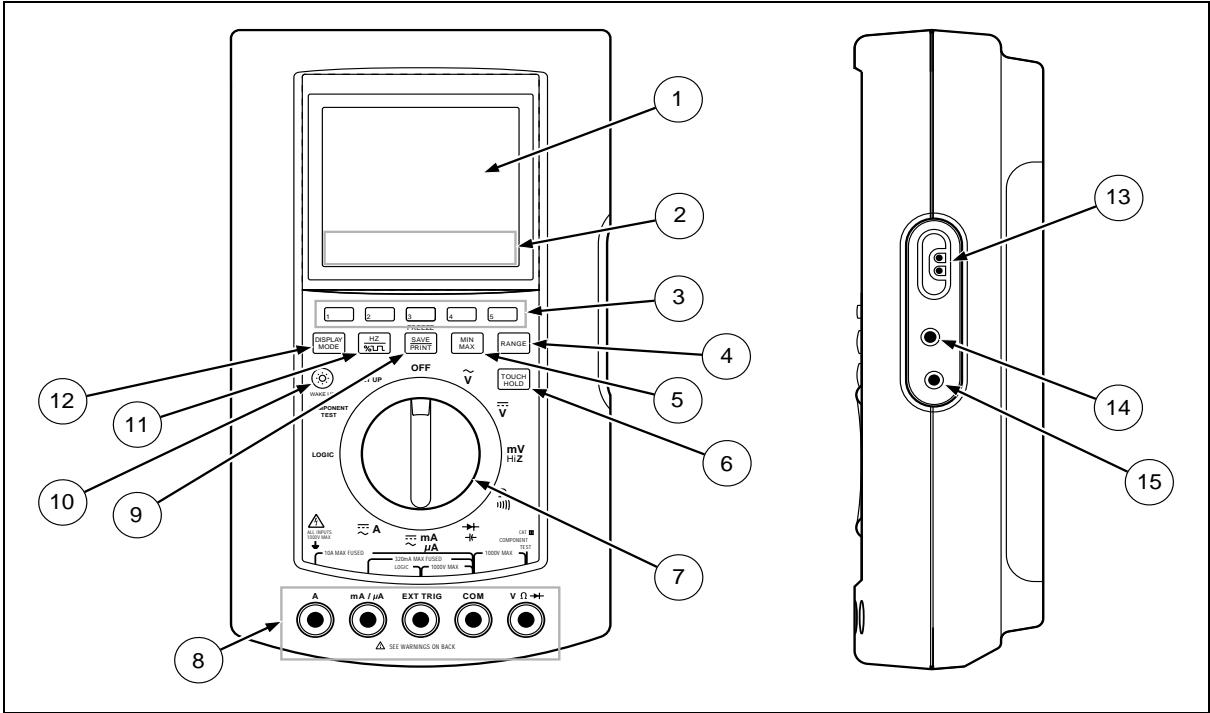

Figure 3-1. General Features

Table 3-1. General Features



Number	Example	Name	Description
1	Combo Meter View Trend	Display	Combo, Meter, View, and Trend are the standard measurement display modes for most functions. Auto Diode Test, LOGIC Test, and COMPONENT Test use unique display modes. Refer to Figure 3-3 for descriptions of display features.
2	Rel	Softkey Labels	Labels define present uses for associated softkeys. A highlighted label means that item is presently selected. Labels change with rotary selector positions and key presses. If a small ► symbol appears with a softkey label, you can access an additional set of softkey labels (a submenu) by pressing this softkey.
3		Softkeys	The five blue softkeys serve different functions, depending on the rotary selector position and other keys in effect.
4		Range Key	Press at any time to change the range of a meter reading or the amplitude of a waveform. Select "Auto" (the standard selection) for an optimal display or "Manual" for selection of a specific range. Present range information is shown in the lower right corner of the display. Refer to Range Softkeys in Chapter 4.
5		Min Max Key	Press once to enable a display showing minimum, average, and maximum values. Refer to Min Max Softkeys in Chapter 4.

Table 3-1. General Features (cont)









Number	Example	Name	Description
6		Touch Hold Key	Press once to enable Touch Hold. The GMM test tool beeps and automatically updates the display each time a change in the reading is detected. If the input connections are withdrawn, the last reading (or waveform) is held in the display. Toggles Touch Hold on and off.
7		Rotary Selector	Rotate the selector to any of the measurement or test positions. The input connections screen appears briefly, when first turned on or when selecting a function requiring an input connection change, then softkey labels specific to the selector position appear.
8		Input Connections	Use $V\Omega\rightarrow+$ and COM for most measurements and tests (volts, ohms, conductance, diode test, capacitance, COMPONENT TEST). Use A (or mA μ A) and COM for amps measurements. Use EXT TRIG and COM for LOGIC Test or as an external trigger for waveform display.
9		Save/Print Key	Freeze the present reading (reverse contrast). You can then save or recall measurement values and configurations or print measurement information. In Model 867B, you can also save or recall waveforms and configurations. Refer to Chapter 6.
10		Wake Up Key	Press to restore a blanked display; the display blanks after 20 minutes if no controls are changed. The display will not blank if the battery eliminator is connected. For Model 867B, this key toggles the backlight power level when the GMM test tool is already awake.

Table 3-1. General Features (cont)

Number	Example	Name	Description
11		Frequency Key	Swaps primary and secondary displays. The frequency measurement type (usually Hz) now occupies the primary display and the Frequency Softkeys are active. You can now select a different frequency type with the softkeys. Press  again to swap the primary and secondary displays back, retaining the most recent frequency type.
12		Display Mode Key	Press to access the Display Mode Softkeys at any time. For volts and amps functions, you can now select Combo, Meter, View, or Trend. Ohms offers Meter or Trend. Other selector functions offer only Meter, while LOGIC, COMPONENT Test, and SET UP use their own unique display modes.
13		RS-232 Optical Port	Connect the RS-232 serial interface cable here for communications with a PC or printer.
14		Battery Eliminator Connection	Connect the battery eliminator for ac operation. A NiCd battery pack installed in Model 867B charges whenever the battery eliminator is connected.
15		Calibration Seal	Do not open this protective seal. Refer to the Service Manual.

Understanding Display Features

Figure 3-3 illustrates typical display features. You will encounter Primary and Secondary Displays and the Graphical Window in Combo, Meter, and Trend Display Modes. Other display features will appear in all display modes.

Input Connections Screen

When you select a new function, the Input Connections Screen (Figure 3-2) appears momentarily to identify measurement connections to use, and displays modes that are available. (You can press “Exit” during this 3-second pause to proceed immediately to the function display.) See Table 3-1 under Input Connections.

Primary Display

Large digits represent the measurement or test based on the selector position. This display always appears in Meter, Combo, and Trend modes. The frequency reading (usually Hz) can be swapped into the primary display. When selected, “Rel” or “dB” automatically occupy the primary display.

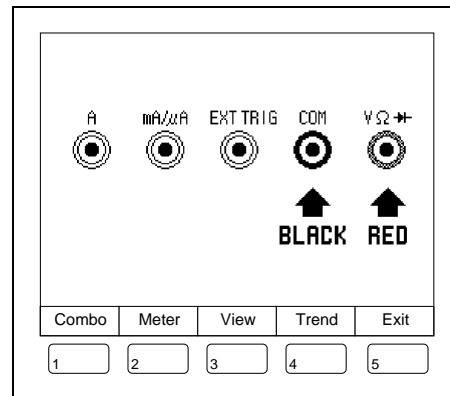

rita0601.eps

Figure 3-2. Input Connections Screen

Secondary Display

Smaller digits show the type of frequency reading (usually Hz) selected with the Frequency Softkeys. The primary reading can also be swapped into this display.

Graphical Window

This window shows a waveform in Combo Mode, an analog display in Meter Mode, or a plot in TrendGraph™ Mode.

Softkey Labels

The present uses for the five softkeys appear immediately below the display.

Upper Status Line

The top display line identifies active operations as shown in Table 3-2.

Lower Status Line

The bottom display line (immediately above the softkey labels) identifies the display mode, function, and range. The ⚡ safety indicator also appears here if dangerous voltage is detected at the input terminals when the actual reading is not displayed.

Message Boxes

Message boxes appear in the lower display when the GMM test tool is performing an operation that you may not want to interrupt ("Saving" or "Printing").

Overload Indication (OL)



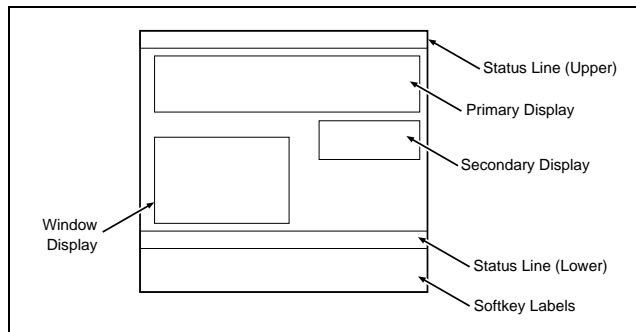

"OL" or "-OL" appears in the primary and secondary displays when an input has exceeded the present range (in Manual) or has exceeded the highest range available in this function (in Auto). A clipped waveform can appear in Combo or View mode (DC Volts, mV DC, DC Amps, DC mA μ A functions only) if a large ac signal is riding on an overloaded dc signal.



rita0390.eps

Figure 3-3. Display Features

Table 3-2. Display Status Information

SYMBOL	DESCRIPTION
	Touch Hold is active.
REL	“Rel” (relative reading) is active (reference minus actual reading.)
Min Max	Min Max is active. This is the only indication if Min Max is running in the background.
RS232	The serial interface port is enabled.
Hi-Z	Hi input impedance selected.
	Battery is low.
	Line power operation.
Uncal	GMM not calibrated. Contact a Fluke Service Center.
Internal	Internal trigger (or External.)
	Dangerous voltage is present at the input terminals when the actual reading is not displayed.

Measurement Connections



Warning

Never attempt a voltage measurement if a test lead is in the amp (A) or milliamp microamp (mA μ A) input terminal. You might be injured or the GMM TEST TOOL might be damaged.

General Measurement Connections

Volts, Ohms, Continuity, Conductance, Diode Test and Capacitance connections are illustrated in Figure 3-4.

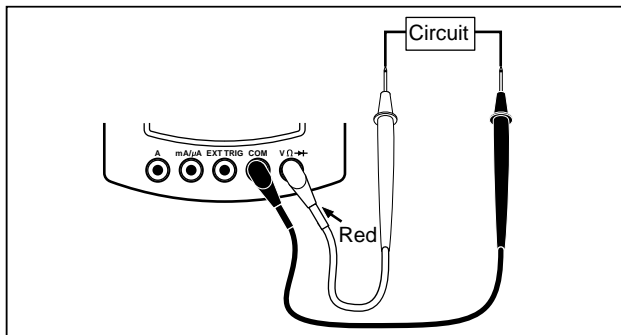

Figure 3-4. General Measurement Connections

Amps and mA μ A Measurement Connections

Amps DC and AC and mA μ A connections are illustrated in Figures 3-5 and 3-6.

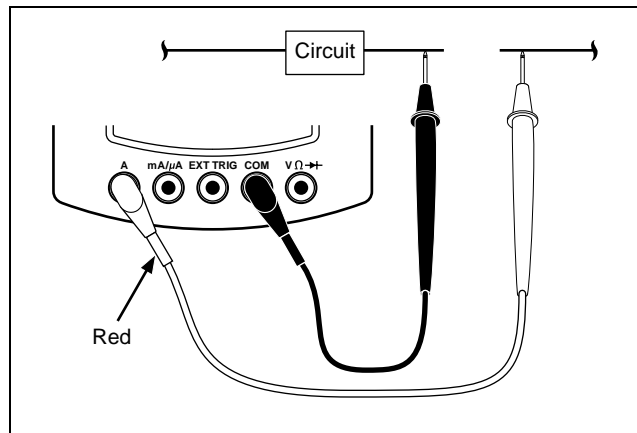
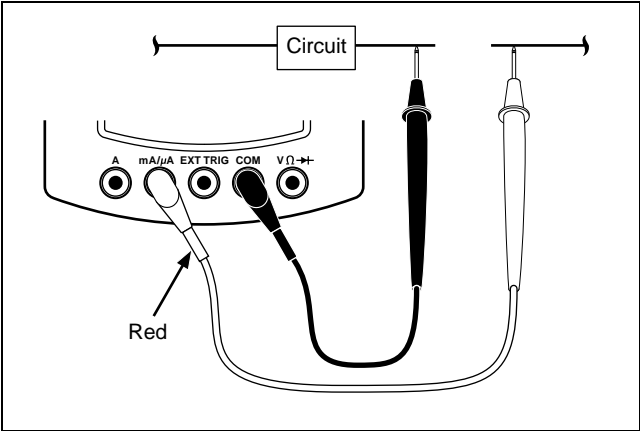

Figure 3-5. Amps Measurement Connections



rita0381.eps

Figure 3-6. Milliamper and Microamp Connections.

Logic Test Connections

LOGIC Test connections are illustrated in Figure 3-7.

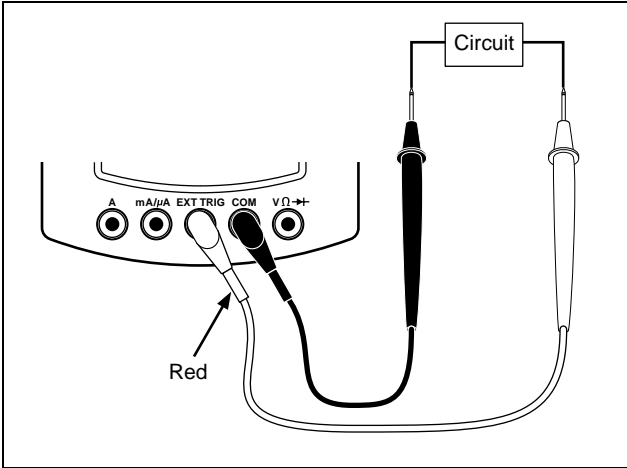

rita0383.eps

Figure 3-7. LOGIC Testing Connections

Frequency Measurement Connections

You can measure frequency from 2 Hz to 2 MHz in AC Volts, DC Volts, mV DC, Amps, and mAμA functions. For higher frequency readings (to > 10 MHz), use the Logic Test function.

Chapter 4

Using the Hardkeys

Introduction



Hardkeys can be used in many function and display mode combinations. Although hardkeys are mentioned throughout this manual, this chapter provides a single source of detailed descriptions for using hardkeys and their accompanying softkeys.

Using Display Mode Softkeys

Press  at any time. The Display Mode Softkeys appear, showing the modes available with the present measurement function. Modes available with VAC, VDC, mV DC, A, and mA μ A are shown.

Combo	Meter	View	Trend	Exit
-------	-------	------	-------	------

The GMM test tool now highlights the present selection and allows you to do the following:

- Change display mode. Softkeys for the new display mode now appear.
- Return without changing the display mode. Press  again, or press the softkey for the selected display mode, or press  to exit.



Combo (the default mode set at the factory) appears automatically when the selector is set to VAC, VDC, mV DC, Amps, or mA μ A. You can also select Meter as the default for these functions on the SET UP screen. Meter is the only mode available for Diode and Capacitance Test. Meter and Trend are the



choices for Ohms and Conductance. LOGIC TEST, COMPONENT TEST, and SET UP each use a single, unique mode.



The Display Mode Softkeys also appear briefly when you rotate the selector to a new function. If you make no mode selection within 2 seconds, the softkeys shift automatically to the appropriate function labels.



Using Frequency Softkeys

Softkeys accessed by pressing  are:

	Duty	Pulse		
	Cycle	Width	Period	Exit

 selects the low side  or high side  pulse for frequency, period, duty cycle, and pulse width measurements. Positive is the standard selection.

 (Duty Cycle) selects duty cycle measurements for the pulse (negative going or positive going) selected with .

 (Pulse Width) selects pulse-width measurements for the pulse (negative going or positive going) selected with .

 (Period) selects period measurements of the full signal (negative going or positive going).

 (Exit) returns to the Display Mode Softkeys.

Frequency Operation

The frequency measurement type (Hz, duty cycle, pulse width, or period) normally appears in the secondary display.  swaps primary and secondary displays and accesses the Frequency Softkeys, which you can use to select a new frequency type.

Press  a second time to swap primary and secondary displays back. The secondary reading then continues to display the frequency measurement type selected with the Frequency Softkeys. The Frequency Softkeys remain active, and you can change the frequency type shown in the secondary display while these keys remain displayed.

Press  at any time to swap primary and secondary readings.



Save/Print Softkeys

Softkeys accessed by pressing  are:



Save ► Screen	► Recall	Print	Save ► Config.	Exit
------------------	-------------	-------	-------------------	------

 (Save Screen) accesses the Save Screen softkeys, which allow you to save the present display to a memory location. (Model 867B only.)

 (Recall) accesses the Recall softkeys, which allow you to display the contents of a memory location.

 (Print) prints the display. “Freeze” changes to “Printing”, then reverts to “Freeze” when printing is complete. You can stop printing by pressing  (Stop Print) or  (Exit); all other key presses are ignored.

 (Save Config.) accesses the Save Config softkeys.

 (Exit) returns to the original display. You can also press  again to return to the original display. You must press one of these two keys to

return; other keys do not operate during the Freeze display.

Press  to stop waveform and numerical value updates. Display contrast is reversed, the “Freeze” message appears, and the Save/Print Softkeys are accessed. You can now Print display information or Save and Recall display and configuration information.

“Enable RS232” in TrendGraph™ Mode is canceled. Touch Hold, Min Max, Trend, and “Peak Hold” continue to update in the background (beeps continue).

Refer to Chapter 6 for a full description of saving and recalling operations available with Freeze.

Min Max Softkeys

Softkeys accessed by pressing  are:

Min Max Off	Restart	Run Pause		Exit
----------------	---------	--------------	--	------

Minimum, maximum, and average measurements are displayed (with timer information) in the graphical display (Combo and Trend) or meter display (Meter).

In the View mode, Min Max is enabled and the MIN - MAX icon appears in the upper status line. However, Min Max measurement readings and timer information cannot be viewed on the waveform screen.

 (Min Max Off) turns the Min Max feature off. The GMM test tool returns to its normal display mode. Measurement values and timer information cannot be recovered at this point.

 (Restart) resets all values/timers and begins with new values and timers. Previous measurement values and timer information cannot be recovered at this point.

 (Run Pause) toggles between the normal “Run” state and a temporary “Pause” condition. Changing display modes when Min Max is active does not change the “Run” or “Pause” state.

In Combo, Meter, and Trend modes, “Pause” turns the “Min Max” icon at the top of the display dark, and displayed values stop updating (although the elapsed time continues counting.) In View Mode, “Run” and “Pause” operate normally, but measurement readings and timer information cannot be viewed.

 (Exit) returns the softkeys to the functions for the selected measurement mode while the remainder of the display remains unchanged. You must use the Display mode key to return the window and secondary displays to the Combo, Meter, or Trend display. Min Max will remain enabled in the background mode.

You can use Min Max with LOGIC to keep track of the range of logic levels being encountered. Use the following procedure:

1. With the selector turned to LOGIC, select logic type by pressing , , or .
2. Press . The full Min Max display of levels and times now appears.
3. Place the Min Max display in the background by pressing . The LOGIC activity display reappears, and the Min Max icon indicates that Min Max recording is continuing in the background.
4. Check the Min Max values at any time by repeating steps 2 and 3.

Cancel Min Max by reselecting or changing the logic type. (Press , , or from the LOGIC Softkeys.)

Range Softkeys



Softkeys accessed by pressing are:

Auto	▲	▼	Wave	Exit
Manual			Scale	

(Auto Manual) toggles between Auto and Manual ranging. In Auto, the GMM test tool automatically selects the range presenting the highest resolution. Auto is the standard configuration; Manual can be selected as the power-up configuration when the selector is in the SET UP position. The GMM test tool resets to Autoranging when you select “Full Auto” (by pressing from the VAC, VDC, or mV DC softkeys.)

and select the next higher (lower) range (if available). If Auto ranging is active, ▲ or ▼ selects Manual ranging and the next higher (lower) range.



 (Wave Scale - active in the View Display Mode) enters manual ranging and cycles through “units/Div” scaling factors of 1, 2, and 4 for the vertical axis, effectively zooming in and out on the waveform display. The scaling factors divide the units/Div for the present range. “Wave Scale” is not available in Meter Mode.

 (Exit) returns to the softkeys previously in effect. (You can also press  to return to the previous softkeys.)



Entering Range cancels “Peak Hold”.



Touch Hold

This key allows you to hold a known good reading on the display. (No special softkeys accompany Touch Hold.) Use the following procedure:

1. Press  ( appears at top of the display.)

2. Apply measurement connections until you hear a beep. This sound signifies that a stable reading has been made. The display continues to update with valid readings (and beeps) as long as you maintain the measurement connections.
3. In Meter, Combo, and Trend display modes, the last valid primary numeric reading is held; the waveform in Combo and Trend is not held. In View Mode and COMPONENT Test, the last valid waveform is held.

Press  again to exit Touch Hold ( disappears.)

Touch Hold and “Peak Hold” are mutually exclusive: activating one cancels the other. Touch Hold cannot be activated when Frequency, SET UP, or LOGIC is selected. Pressing  or  cancels Touch Hold. Selecting “rms”, “Average”, or “Full Auto” cancels Touch Hold.  stops Touch Hold display updates; Touch Hold then continues to run in the background. In view mode, selecting Touch Hold cancels “Glitch Capture” and “Single Shot”.

Chapter 5

Using View and Trend Display Modes

Introduction

This chapter describes how to display a waveform in View Display Mode and how to plot and interpret measurement data over time in TrendGraph™ Display Mode.

View Display Mode Basics

The GMM must know when to begin displaying (trigger) a waveform. Triggering requires that a valid signal level is specified, a direction for that signal (positive going or negative going) is selected, and the trigger signal source (internal or external) is set.

Setting the range for the vertical divisions and the timebase for the horizontal divisions directly

influences the proportions and legibility of the triggered waveform.

The type of waveform acquisition may also be important. A continuous, internal trigger enables an ongoing display of the input signal whenever you turn the selector to a new function.

Using Full Auto

“Full Auto” allows the GMM to automatically select the Trigger Level, Trigger Slope, Trigger Source, Range, and Time Base necessary for an optimum display of the input signal. If a good input is present, you will see a waveform that nearly fills the screen.

“Full Auto” () is enabled (highlighted) initially when View Display Mode is activated if “Auto” is selected in the SET UP screen and no manual settings have been introduced.

“Full Auto” may not be automatically selected when the GMM enters View Mode. If “Manual” is set as the power-up default for Range on the SET UP screen, “Full Auto” is not selected. Further, if you then change to “Full Auto” by pressing from the View Mode Softkeys, “Manual” remains selected on the SET UP screen and will be reapplied when you change functions.

NOTE

Disabling any of the auto features turns the “Full Auto” softkey label off (not highlighted.) Other auto features then remain active. Pressing from the View Mode Softkeys turns all auto features off at once.

Changing the Amplitude Range

You can use the softkeys accessed with to select a preset (Manual) amplitude range.

Using View Mode Softkeys

Time ► Base	► Trigger	Single ► Shot	Glitch ► Capture	Full Auto
----------------	--------------	------------------	---------------------	--------------

(Time Base) accesses the Time Base Softkeys, which allow you to zoom in or out on the waveform by changing the horizontal (time) axis of the View display.

(Trigger) accesses the Trigger Softkeys, allowing you to control the trigger slope, level, and source.

(Single Shot) accesses the Single Shot Softkeys, which allow you to capture and examine a single waveform that has met your trigger criteria. The GMM test tool displays continuously updating waveforms if this key is not pressed.

(Glitch Capture) accesses the Glitch Capture Softkeys, allowing you to capture and examine a waveform that has met a predetermined trigger criteria with a briefly occurring spike. See Choosing the Acquisition Type later in this manual for further information on Trigger criteria for Glitch Capture.

(Full Auto) selects the range, trigger level, and time base automatically to produce an optimum display of the waveform.

Setting Up the Time Base

Time ► Base	►	Single ► Shot	Glitch ► Capture	Full Auto
----------------	---	------------------	---------------------	--------------

Select "Time Base" () from the View Mode Softkeys, then use the Time Base Softkeys as follows:

<input type="text" value="1"/>	Slower	Faster	<input type="text" value="3"/>	Exit
--------------------------------	--------	--------	--------------------------------	------

(Slower) selects the next longer time per division. More waveform activity then appears in one time division, effectively zooming out on the waveform.

(Faster) selects the next shorter time per division. Less waveform activity then appears in one time division, effectively zooming in on the waveform.

(Exit) returns to the View display.

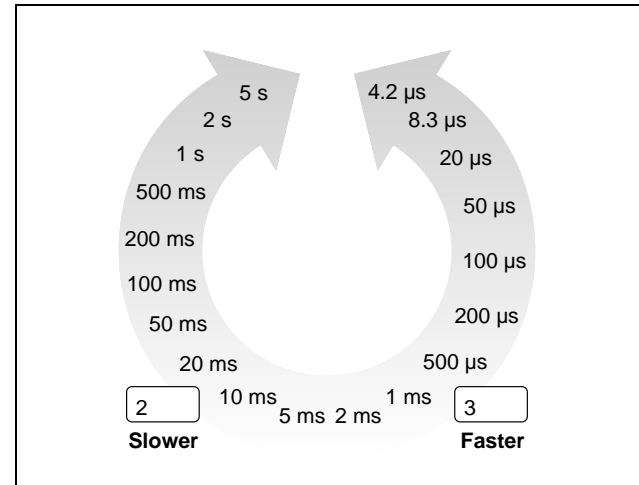

Figure 5-1. Time Base Selection

rita0710.eps

Setting Up the Trigger

Time ► Base	► Trigger	Single ► Shot	Glitch ► Capture	Full Auto
----------------	--------------	------------------	---------------------	--------------

Select “Trigger” () from the View Mode Softkeys, then use the Trigger Softkeys as shown in the following paragraphs.

Selecting the Trigger Slope

┌ Slope └ Slope	▲	▼	Internal External	Exit
--------------------	---	---	----------------------	------

(Slope) sets the waveform trigger to trip either on the rising or falling edge of the signal for single triggering. The counter triggering still use two (dual) triggers for its operation and are set automatically based on the input signal amplitude. In dual triggering, selects between the rising and falling slope trigger points to allow their levels to be set individually. The waveform trigger icon will switch between two trigger points in the display as selects each trigger. The rising slope setting will always have a more positive setting than the falling slope setting. However, whichever slope is left selected will be the last criteria to be met before a

trigger occurs, e.g., if the rising slope selection is left highlighted, the input signal must pass through the falling slope first and then through the rising slope to trigger the GMM. In single trigger, Full Auto will always set the trigger slope to rising.

The GMM trigger circuitry controls both the waveform and counter displays. The counter always uses a dual trigger setting while the waveform display can be controlled by single or dual triggering. The waveform trigger setting(s) are indicated in the display with an icon in the left margin along the vertical axis of the display grid (Figure 5-2). The counter trigger settings are indicated by the two icons along the right vertical axis and are marked with “Hz”. The counter and waveform trigger settings are the same when in Dual trigger operation. This is the only condition where the counter trigger levels are manually set.

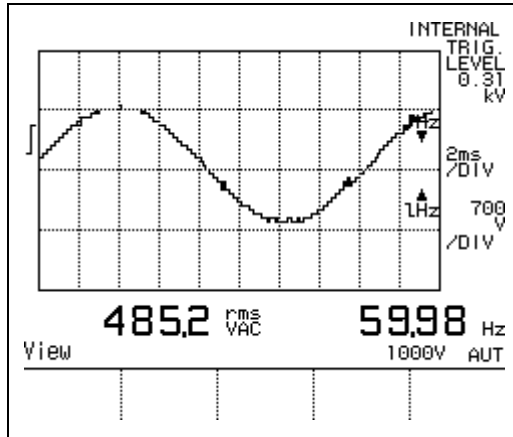

86xsc011.tif

Figure 5-2. Trigger Icons

Changing the Trigger Level

┌ Slope	▲	▼	Internal	
└ Slope			External	Exit

2 and 3 (▲ and ▼) change the trigger level the waveform must pass through to trigger the GMM. For Internal triggering, the waveform trigger icon identifies the level and moves as you make the level adjustment. The actual trigger level is displayed in the upper right corner of the display. For Dual triggering, you must first select which trigger point you want to adjust with the 1 Slope selection. The waveform icon will move from one point to the other in the display as the slope selection is changed. The counter trigger levels are linked with the waveform trigger levels in dual triggering and are the only time they can be manually set. For external triggering, a single trigger level is set with the (▲ and ▼) softkeys and is indicated in the special trigger level indicator in the upper right corner of the display. There are 21 different preset trigger levels available for external triggering.

If “Full Auto” is selected, the trigger levels are set on percentages of the input signal.

Selecting the Trigger Source

↑ Slope	▲	▼	Internal	
↓ Slope			External	Exit

4 (Internal External) selects Internal or External trigger source. When “Internal” is selected, the trigger circuit uses the measured input signal for triggering. When “External” is selected, the trigger circuit uses the signal placed on the EXT TRIG jack for triggering. The waveform and counter trigger icons are removed from the display and a special trigger level indicator replaces the trigger level readings in the upper right corner of the display (Figure 5-3). There are 21 external trigger level steps. You can provide a trigger from an external source to synchronize the GMM display to some other event. Refer to Specifications for External trigger input levels.

5 (Exit) returns to the View Softkeys.

Selecting Single or Dual Trigger

To accommodate various trigger situations, the waveform can be triggered by one (single) or two (dual) trigger settings. “Single” or “Dual” are trigger selections you can be make from the SET UP

screen. When using external triggering, only one trigger level may be set regardless of the set up selection.

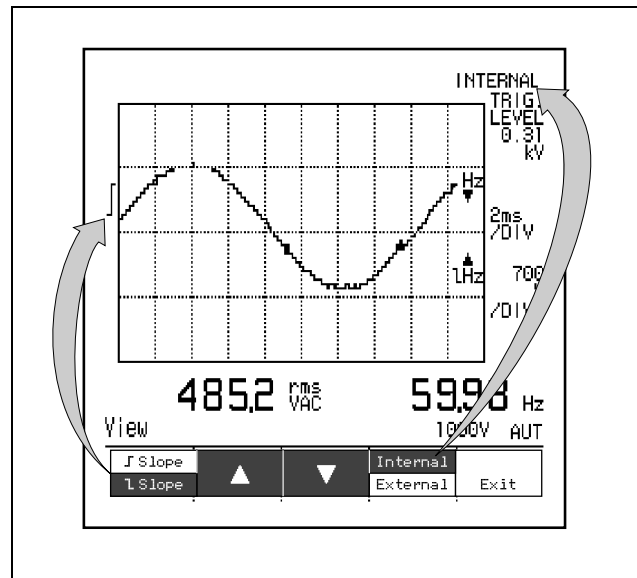

rita0392.eps

Figure 5-3. Setting Up the Trigger

Single triggering establishes a fixed trigger point for the waveform display. The input signal only needs to cross the trigger amplitude set by the trigger level and in the direction set by the slope setting. While in single trigger mode, the frequency counter trigger circuit sets two predetermined levels that are not adjustable. This ensures a stable frequency reading while triggering the waveform with a single trigger.

Dual triggering (the default setting) requires that the signal pass through both upper and lower trigger points to trigger the waveform and frequency counter. These points are initially set based on percentages of the input signal amplitude. You can change both levels with the Trigger Softkeys. Dual triggering provides a more stable waveform display in noisy environments.

Choosing the Acquisition Type

Time ► Base	► Trigger	Single ► Shot	Glitch ► Capture	Full Auto
----------------	--------------	------------------	---------------------	--------------

Instead of using the continuous internal trigger, you can instruct the GMM to update the screen only once, yielding a retained, snapshot view (“Single Shot”) of an input signal meeting the trigger requirements. Press from the View Mode Softkeys.

Yet another selection allows you to display and monitor only randomly-occurring or fast transient events or glitches (“Glitch Capture”). Trigger levels are preset and are not adjustable. The “Glitch” must have a change rate higher than 1 kHz and an amplitude > 20% of the selected GMM range.

“Single Shot” and “Glitch Capture” use the same submenu of softkeys as described in the following paragraphs.

Using Single Shot and Glitch Capture Softkeys



1 (Arm) resets the trigger circuit and readies the GMM test tool to capture another single shot waveform or glitch capture transient. “Arm” is selected (highlighted) initially. When the entire waveform is captured, “Arm” reverts to normal contrast.

The display shows elapsed time (hh:mm) since arming or, if a trigger subsequently occurred, time between arm and trigger. The time cycles from 00:00 through 99:59 continuously until a trigger is received.

2 and **3** (◀ and ▶) move the waveform left or right for viewing (available once the waveform is completely captured). If you press **1** again, the arm cycle starts over, ◀ and ▶ disappear, and the arm-to-trigger time begins at 00:00. Waveform position accomplished with ◀ and ▶ is retained across arm cycles. Six time base divisions prior to the trigger and 19 time base divisions after the trigger can be viewed using ◀ and ▶, respectively. Refer to Figure 5-4 for an overview of time divisions (on and off screen) that can be examined.

5 (Exit) returns to the View Softkeys.

Free Run operation and autoranging are not available during “Single Shot” and “Glitch Capture”. Selecting Touch Hold cancels “Single Shot” and “Glitch Capture”.

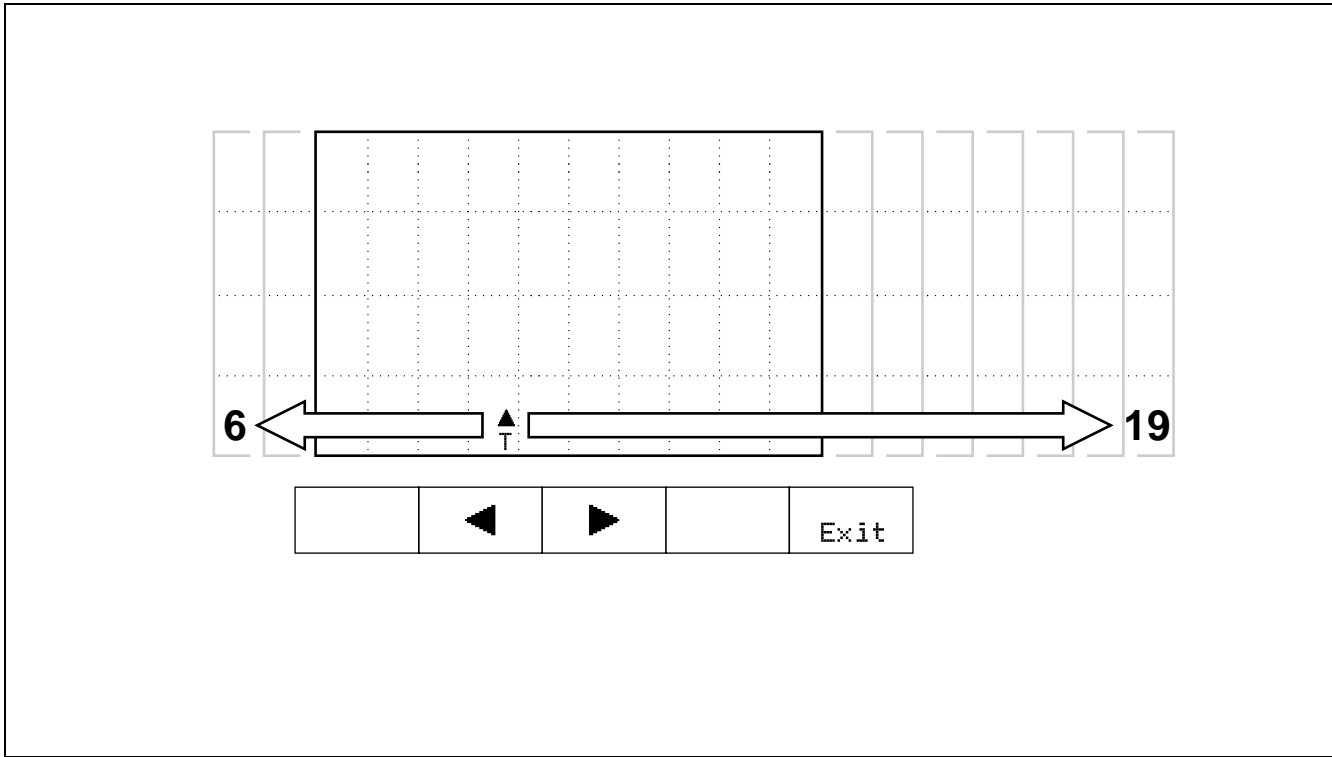

rita0780.eps

Figure 5-4. Viewable Time Divisions (Single Shot and Glitch Capture)

Trend Display Mode Basics

Trend can be used in VAC, VDC, mV DC, Ohms, Amps, and mA μ A functions. This mode uses the graphical window to plot 120 data points over a selectable time ranging from 1 second to 15 minutes. Each data point can represent an actual reading, an average of readings, or a pair of high and low readings. You can also enable serial output of the data points as they occur.

Using Trend Mode Softkeys

Enable RS232	Time Longer	Time Shorter	Trend ► Type	Restart Trend
-----------------	----------------	-----------------	-----------------	------------------

(Enable RS232) starts transmitting readings (with time stamps) with the first press and stops transmitting with the second press. (You can also press to stop transmission.) The time stamp (hours:min:sec) resets each time RS232 is enabled. The time rolls over at 24 hours. Refer to Chapter 6 for serial output connection descriptions.

or (Time Longer, Time Shorter) selects the interval to use on the horizontal scale as data

points are plotted on the trend graph. (Seconds: 1, 2, 5, 10, 15, 30, 45; Minutes: 1, 2, 5, 10, 15)

For “Sampled” and “Average” Trend Type selections, the GMM plots the most recent 120 data points. For “High Low” Trend Type, 120 data point pairs are plotted. Earlier data points are not stored.

(Trend Type) accesses the Trend Type softkeys, allowing you to plot average, sampled, or high/low excursions of the measurement value.

(Restart Trend) starts plotting a new trend graph as new samples are acquired. Primary readings are displayed and plotted; there are no secondary readings in Trend Mode.

Trend Mode Considerations

Only the value being trended is shown in the primary display. For example, a “dB” or “Rel” value that normally occupied the primary display in DC Volts function will be replaced with a VDC reading. Frequency values do remain in the primary display during Trend.

The vertical scale in the Trend display depends on the range setting and the type of measurement. A

unipolar arrangement (0 to full scale) is used for VAC, AAC, and frequency. Bipolar readings (negative to zero to positive) are used for VDC and Ohms.

RS232 Trend Output Format

Trend data for each data point is sent out as it is measured. ASCII format is used, as follows:

- For “Sampled” or “Average” Trend Type:
[Value] [Units] [Time Stamp] <cr> <lf>
- For “High Low” Trend Type:
[Value High] [Units] [Time Stamp] <cr> <lf>
[Value Low] [Units] [Time Stamp] <cr> <lf>
- For “Glitch” Trend Type (Ohms only), the following line is added at the end of each “Sampled” or “Average” line or pair of lines:
[Glitch State] [Time Stamp] <cr> <lf>

[Time Stamp] is in hh:mm:ss format, representing time since the Trend start. Time rolls over at 24 hours.

Selecting the Trend Type

Average	Sampled	High Low	Normal Glitch	Exit
---------	---------	-------------	------------------	------

(Average) plots the average of all samples taken by the GMM during the plot interval.

(Sampled) plots the last sample taken by the GMM at the time the data point is plotted.

(High Low) plots the maximum and minimum sample value taken during the time interval. A vertical bar where the bottom end represents the lowest sample and the top end represents the highest sample is placed on the plot.

(Normal Glitch) selects “Normal” or “Glitch” in Ohms function only. Glitch setting display and highlight fast-occurring discontinuities on the trend line. Markers along the bottom of the display identify discontinuities as they appear on the Trend Plot. A discontinuity is recorded when the measured resistance rapidly passes (decreasing or increasing) through a low resistance continuity point. Each range uses a different continuity point (See Continuity Beeper Values in Chapter 8 of this manual). Note: When Glitch is first enabled, the GMM sets manual

867B/863

Users Manual

ranging and sets the range to 300Ω. It may be necessary to manually change the range for an on-scale reading.

(Exit) returns to the Trend Softkeys.

Chapter 6

Using Save, Recall, Print, and Set Up

Introduction

This chapter contains instructions for using the Save/Print key to save, recall, and print GMM test tool display information and the SET UP selector position to change the GMM test tool power-up configuration.

Refer to Figure 6-1 for an overview of operations accessible through the Save/Print key.

For Model 867B, refer to Figure 6-2 for instructions on connecting a printer or PC to the GMM test tool.

Using the Save/Print Softkeys

Pressing  stops waveform and numerical value updates, freezing the screen. Display contrast is reversed, the “Freeze” message appears, and the Save/Print Softkeys are accessed. You can now Print display information or save and recall display and configuration information.

If on, the “Enable RS232” feature (used in Trend Mode) is canceled. Otherwise, active Touch Hold, Min Max, Trend, and “Peak Hold” features continue to update in the background (beeps continue).

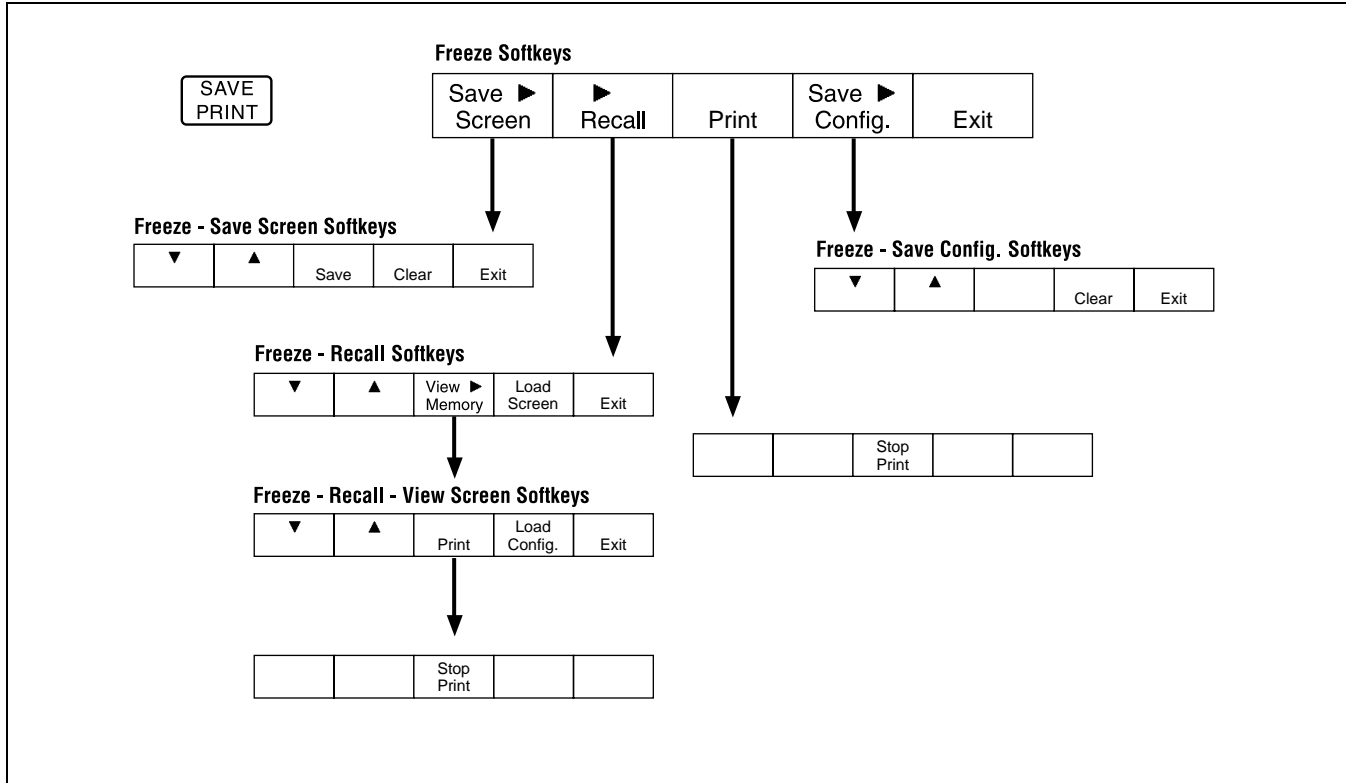

rita0370.eps

Figure 6-1. Freeze (Print/Save) Softkey Map



(Save Screen) accesses the Save Screen softkeys, which allow you to save the present display to a memory location. (Model 867B only.)

(Recall) accesses the Recall softkeys, which allow display of a memory location.

(Print) prints the display. “Freeze” changes to “Printing”, then reverts to “Freeze” when printing is complete. You can stop printing by pressing (Stop Print) or (Exit); other keys are ignored.

(Save Config.) accesses the Save Config. softkeys.

(Exit) (or pressing again) returns to the original display. You must press one of these two keys to return; other keys do not operate during the Freeze display.

Saving Screen and Configuration

(Model 867B only)

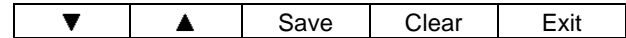
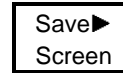

and (▲ and ▼) select the Memory location. Basic information (a reading, etc.) is displayed with the title for each memory location.

(Save) saves the displayed information and supporting configuration (message appears), then returns to the Save/Print display.

(Clear) erases this memory location. (“Clear” appears only if something is saved in this memory location.)

(Exit) (or pressing again) returns to the Save/Print display.

Recalling Screen or Configuration

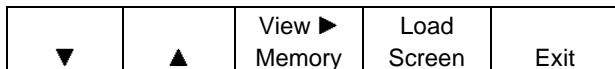
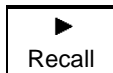

and cycle through memory locations (seven configuration memories for all models and three display memories on Model 867B only).

(View Memory) previews the selected memory and accesses the View Memory softkeys. “View Memory” does not appear if memory is empty. Previewed memory always appears in reverse video.

(Load Screen or Load Config) directly replaces the active display with the selected display from memory. The selector function must match that of the presently selected memory list item, and the selected memory location must be occupied.

(Exit) returns to the Print/Save softkeys (display frozen).

Previewing Screen or Configuration

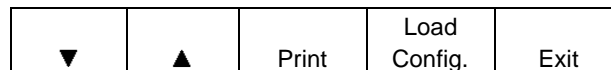
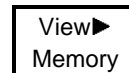

and scroll through memory locations for previewing (reverse video).

(Print) begins printing the display. “Printing ...” appears on the display and “Stop Print” defines the softkey. Press again to stop printing, or wait until “Print” becomes the softkey label again.

(Load Config. or Load Screen) can be used if the selected memory matches the present selector function configuration and the selected memory location is occupied.

“Load Config” appears when you select one of the seven configurations. The GMM loads the selected configuration and returns to the active display.

“Load Screen” appears when you select one of the three screens. Press to display the stored waveform along with the active waveform. The GMM assumes the time base and amplitude settings of the stored waveform. With the recalled and active waveforms both displayed, you can press to access the following three softkeys: “Print” to the two-waveform display; “Clear Exit” to clear the recalled waveform and return to the active waveform display; “Exit” to return to the two-waveform display.

If you press any other key, the recalled waveform clears and the display returns to the active waveform.

In View Mode, the stored waveform must have been saved while the GMM was in View Mode. The loaded screen appears as solid lines. In COMPONENT TEST, the stored memory must have been saved while the GMM was in COMPONENT TEST.

(Exit) returns to the Print/Save softkeys (display frozen).

Saving the Present Configuration

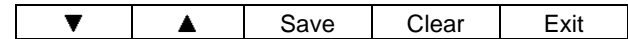
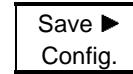

and select the Memory location.

(Save) stores present configuration and numerical data sufficient to recreate this display. A message appears while the configuration is being saved. The GMM test tool then returns to the Save/Print display.

(Clear) clears this memory location. (“Clear” appears only if something has been saved in this memory location.)

(Exit) returns to the Save/Print display.

Printing

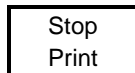
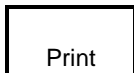

NOTE

Do not print if the GMM is presently controlled by FlukeView 860 application software.

Use the following procedure for printing:

1. Verify appropriate "Printer Type", "Baud Rate", and "Parity". These selections appear as the last

three items on the SET UP screen (selector turned to SET UP.)

2. Connect the GMM to a printer as shown in Figure 6-2. Or, download the screen to FlukeView 860 Application Software running on a PC. Then print from FlukeView 860.
3. Set the GMM to display the screen you want to print. The screen can be the active display or one of the recalled screens.
4. Press (Print) to begin printing.
5. You can now press (Stop Print) at any time to cancel the screen printing.

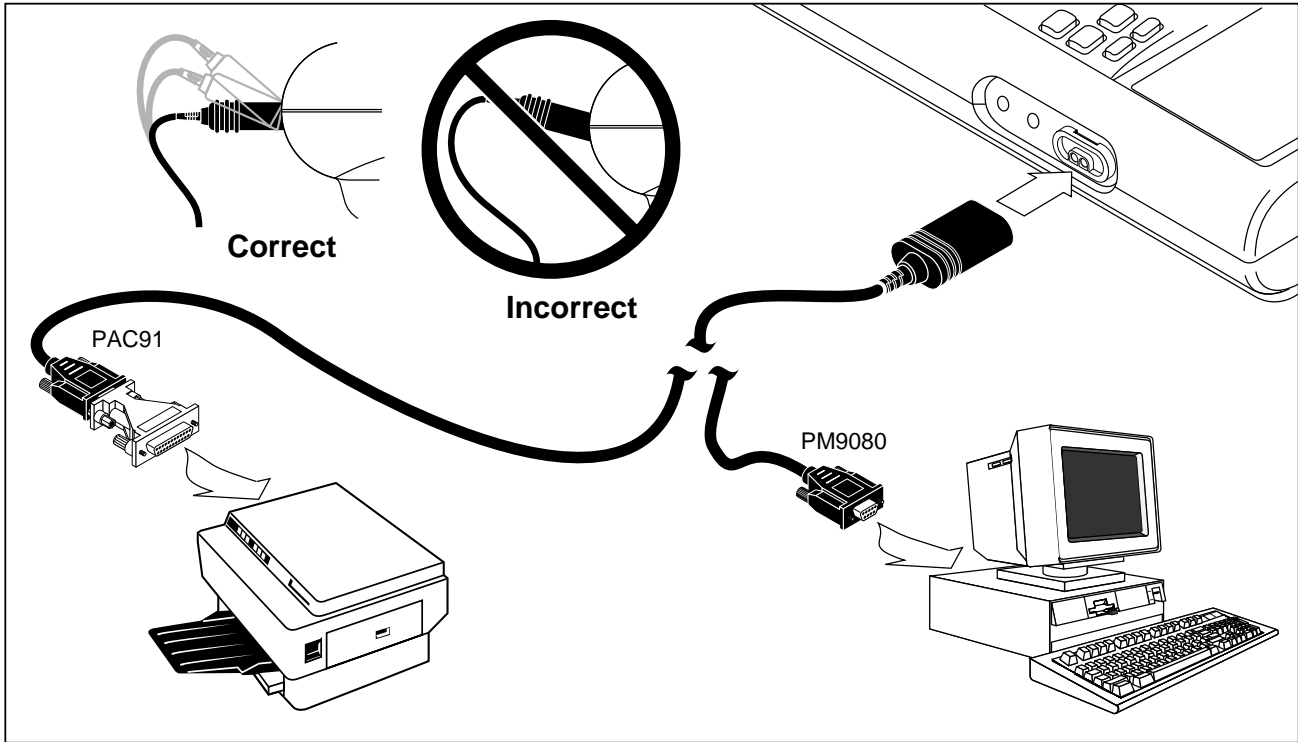

rita0270.eps

Figure 6-2. PC and Printer Connections

Changing the Configuration



Set up	Self Test			Exit
--------	-----------	--	--	------

(wait 2 seconds)

Next Item	◀	▶	Restore All	Save Set up
-----------	---	---	-------------	-------------

NOTE

If no keys are pressed for 15 seconds after the selector is turned to SET UP display contrast returns to the default mid-scale setting.

1. Beginning at the first line (LCD Contrast), press to step through the other lines in this

display. Continue pressing to wrap back to the top line.

At each configuration line, press or to make your selection. Then press to move to the next line.

2. Press to restore all lines on this configuration display to their standard settings. You have two choices at this point. First, you can press now to save the displayed information as the power-up configuration. Second, you can use the retrieved standard configuration as a starting point, change some of the settings as described above, and then store your customized settings as the new power-up configuration.
3. Press to save all configuration settings presently shown on the display into nonvolatile memory. These settings become effective immediately and are reestablished each time the GMM test tool is powered on.

If you make SET UP changes and do not press (Save Set up), the changes remain in effect only until you turn the GMM off.

Table 6-1. Configuration Selections (SET UP)

SET UP ITEM	SELECTIONS AVAILABLE	DEFAULT
LCD Contrast	Press ◀ or ▶ to adjust display contrast.	(mid-range)
AC Converter	“rms” or “Average”. This setting controls “rms” or “Average” softkey selection in ac volts or amps functions.	True rms
Display Mode	“Combo” or “Meter”.	Combo
dB Reference	dB ohms reference values: 2 4 8 16 50 75 93 110 125 135 150 300 600 900 1000 1200. Continue pressing ▶ to select “Auto”, “Manual”, or “Disabled”.	600 Ω
Range	“Auto” or “Manual”.	Auto
Beeper	“Enabled” or “Disabled”.	Enabled
Sleep Mode	“Enabled” or “Disabled”.	Enabled
Trigger Mode	“Dual” or “Single”.	Dual
Printer Type	“Epson”, “HP Graphics”, or “Text.”	Epson
Baud Rate	1200, 2400, 9600, or 19200.	1200
Parity	“no”, “even”, or “odd”. (Number of Bits is always 8; number of Stop Bits is always 1.)	none

Chapter 7

User Maintenance

Introduction

This chapter covers basic maintenance procedures that can be performed by the user. For complete service, disassembly, repair, and calibration information, refer to the 867B/863 Service Manual (PN 689312).

Cleaning

Clean your GMM test tool with a damp cloth and a mild detergent. Do not use abrasives, solvents, or alcohol.



Warning

To avoid ELECTRICAL shock, remove the test leads and any input signals before opening the case.

Testing the Fuses

Test the fuses with the following procedure:

1. Turn the selector to Ohms (Ω).
2. Connect a test lead between the $V\Omega$ and $m\mu A$ input terminals. Check that the display reads less than 5Ω . This tests the 440 mA fuse. If this reading is "OL", refer to the following fuse replacement information.
3. Move the test lead from the $m\mu A$ terminal to the A terminal. Check that the display reads less than 5Ω . This tests the high energy (11A) fuse. If this reading is OL, refer to the following fuse replacement information.
4. If either reading is outside the range shown, have the GMM test tool serviced.

Replacing the Batteries

The GMM test tool uses 6 AA alkaline batteries (included with Model 863) or a nickel-cadmium battery pack (BP 7217 - included with Model 867B). Internal charging for the battery pack is provided with Model 867B. The NiCd battery pack must be fully charged before using the GMM. External charging (using BC7210) is necessary if the battery pack is used with Model 863 (instructions are included with BC7210.) Refer to Figure 7-2 for battery replacement instructions. Replace the NiCd battery pack when it no longer holds a charge for the rated interval. Order replacement Model BP7217 Nickel-Cadmium Battery Pack. In the USA and Canada, call Fluke Service Parts at (800) 526-4731. Elsewhere, call +1 425-356-5500 for instructions.



Note

If the Tester is dropped, it may not turn on. Check the batteries to see if they are damaged and need to be replaced.

Do not mix spent Nickel-Cadmium batteries with the solid waste stream. Spent batteries should be

disposed of by a qualified recycler or hazardous materials handler. Contact your authorized Fluke Service Center for recycling information.

Replacing the 440 mA Fuses



Refer to SAFETY in the front of this manual prior to replacing any fuse.

Refer to Figure 7-3 to locate and replace the 440 mA fuse (PN 934121). Note that the battery compartment must be accessed first; refer to Figure 7-2 for these initial access procedures.

Replacing the 11A (High Energy) Fuse

You must disassemble the GMM case to replace a blown high energy (1000V, 11A) fuse (PN 943118). The GMM's safety design places this fuse inside the case to protect the user and to encourage inspection of the circuit board for damage if very high energies have been encountered. Proceed as follows:

1. Set the GMM selector to OFF. Be sure to leave the selector in this position throughout the disassembly and reassembly procedure.

2. Remove the six screws attaching the case halves. Detach the case halves.
3. Remove the two screws securing the shield as shown in Figure 7-1. Then pry the shield loose from two stanchions at the top of the circuit board.
4. Gently pull up on the shield tab and rotate the entire shield away from the circuit board.
5. Remove the three screws securing the circuit board to the front half of the GMM.
6. Dislodge the circuit board by pushing in on the Volts-Ohms input connector from the lower right front of the GMM. (See Figure 7-1, Detail A).
7. Lift the entire circuit board up approximately one inch, dislodging the slotted Battery Eliminator connection. (See Figure 7-1, Detail B).
8. Rotate the circuit board 180 degrees.
9. Remove the fuse.

Note

For a more detailed drawing, see the Service Manual (PN 689312).

Reassembly

Generally, reassembly reverses the disassembly procedure. Specifically, do the following:

1. Verify that the selector switch still points to OFF.
2. Place the case top face down on a non-marring surface.

Note

At all times, avoid stressing the ribbon cable.

3. Grasp the board at the top and bottom so that it can be smoothly lowered into position in the case top.
4. As you begin lowering the board into position, make sure the battery eliminator connection (Detail B in Figure 7-1) slips into its slot snug against the top case wall.
5. Gently press the board into position at the top and bottom
6. Replace the three screws securing the board.
7. Rotate the shield back into place on the circuit board.
8. Replace the case bottom. Tighten the six screws (middle screws first) securing the case bottom.

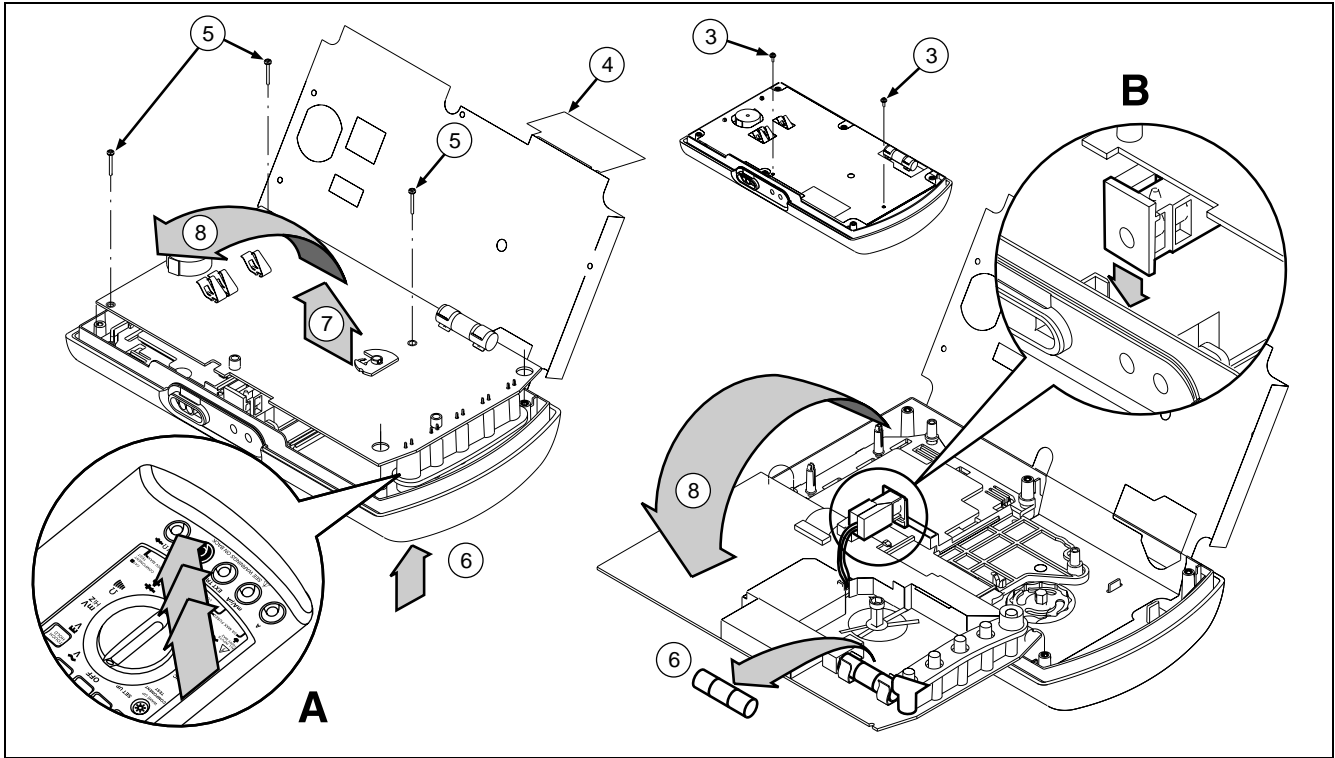

Figure 7-1. Replacing the 11A (High Energy) Fuse

17-1.eps

Operational Test

Use the following procedure to test the basic operability of your GMM test tool:

1. With no inputs connected, turn the GMM test tool on by rotating the selector to VAC (\tilde{v}). Combo or Meter display mode should appear, with a random display in the mV range.
2. Rotate the selector to VDC (\bar{v}). Observe a similar primary display in the mV range.
3. Rotate the selector to Ohms ($\frac{\Omega}{|||||}$). Observe a display of "OL".
4. Connect the test leads to **V Ω - \rightarrow +** and **COM**.
5. Short the test lead tips and observe a display of approximately 0.250 ohms.
6. Press ($|||||$), short the test leads again, and listen for a beep.

For a complete performance test of GMM test tool functions and specifications, refer to the 863/867B Service Manual (PN 689312).

Self Test

Begin an internal diagnostic routine by selecting SET UP, wait two seconds, press . The display now presents the following information:

1. A test pattern.
2. An error message (if a problem is encountered during the test). The GMM test tool Model and serial numbers.
3. The calibration status.

Generally, you cannot use the GMM test tool keys during Self Test. (You can press to exit the diagnostic routine and return to the SET UP Softkeys.)

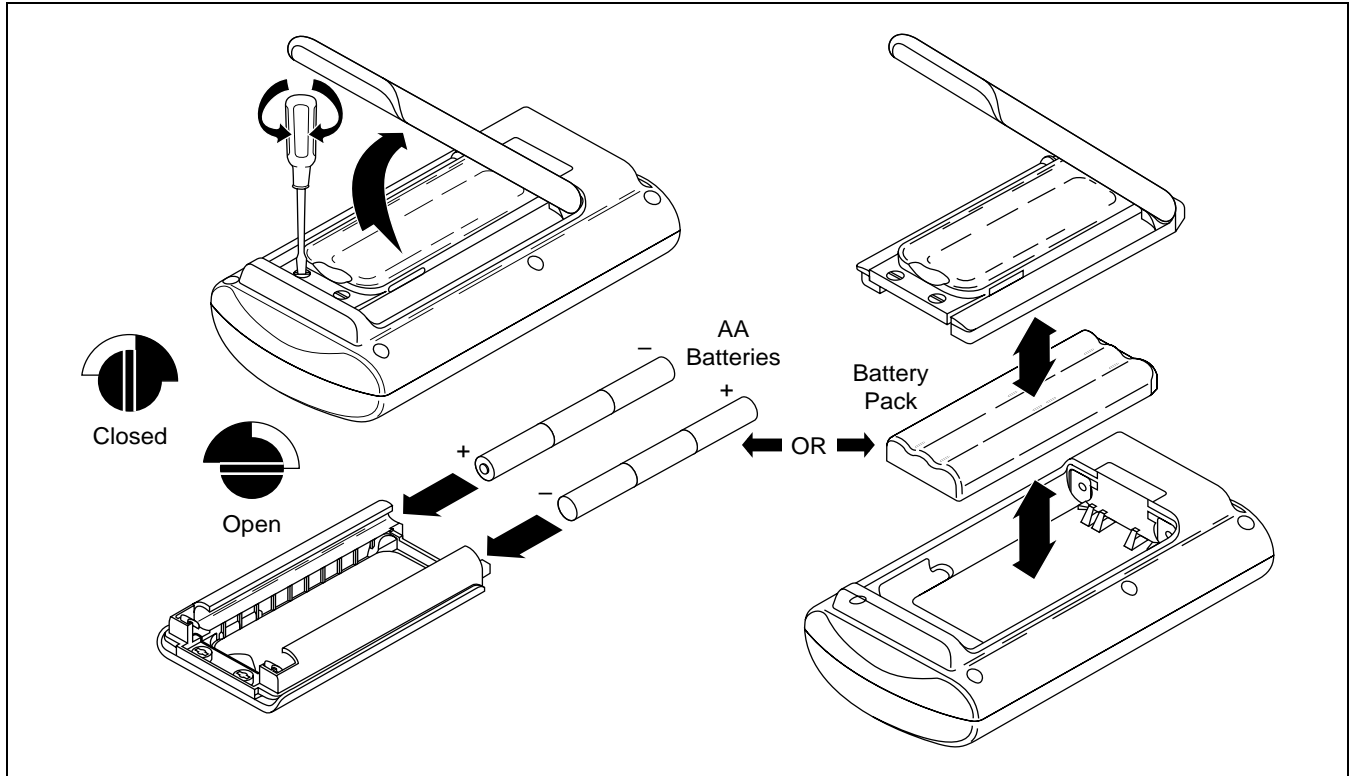

Figure 7-2. Replacing the Batteries

rita0535.eps

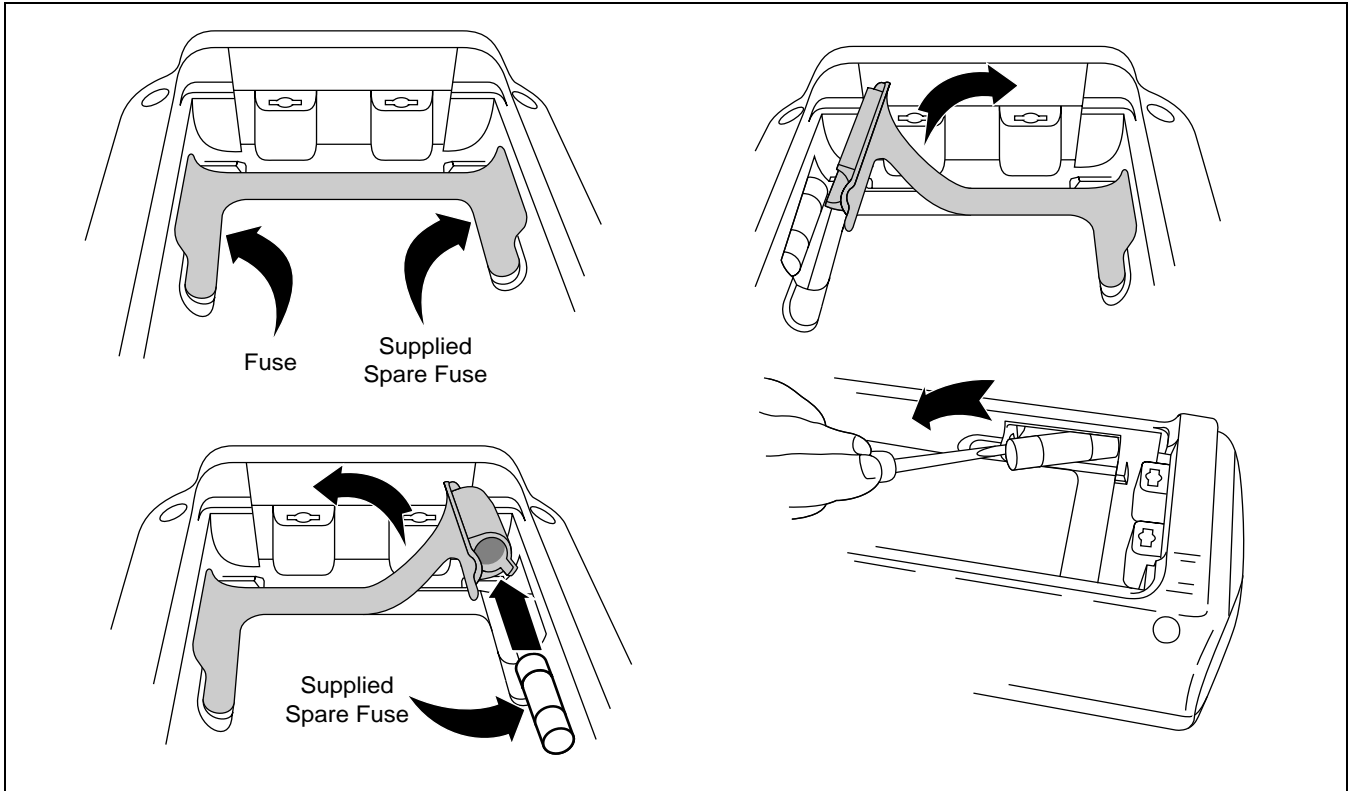



Figure 7-3. Replacing the 440 mA Fuse

rita0674.eps

If Your GMM Does Not Work

NOTE

If the display remains blank after pressing , contrast may be off the scale. Restore contrast to mid-scale with the following shortcut: set the selector to SET UP and avoid touching any key until the display reappears (about 15 seconds). Press  to store this setting, then turn the selector to the desired function.

Examine the case for physical damage. If damage is detected, contact a Fluke Service Center. Check and replace (as needed) the battery, fuses, and test leads. Review this manual to verify correct operation.

If the GMM still does not work, pack it securely and forward it, postage paid, to the nearest service center. Include a description of the problem. Fluke assumes no responsibility for damage in transit.

A GMM under warranty will be repaired or replaced (at Fluke's option) and returned at no charge. See the registration card for warranty terms. If the warranty has lapsed, the GMM test tool will be repaired and returned for a fixed fee. Contact the nearest service center for information and prices.

If "Uncal" appears in the Upper Status Line, the GMM is no longer calibrated; contact a Fluke Service Center.

To locate an authorized service center, visit us on the World Wide Web: www.fluke.com or call using any of the phone numbers listed below:

USA and Canada:

1-800-44-FLUKE (1-800-443-5853)

Europe: +31 402-678-200

Japan: +81-3-3434-0181

Singapore: +65-★-276-6196

Anywhere in the world: +1-425-356-5500

Chapter 8 Specifications

General Specifications

Display: LCD - Dot Matrix, 240 X 200 pixels

Fluke 867B: Transmissive, Backlit

Fluke 863: Reflective

Temperature Operating: 0°C to 50°C (See Chart)

Storage: -20°C to 60°C (Batteries Removed)

Charging: 0 to 45°C

Temperature Coefficient: (0.1 X % Accuracy) per °C
(0°C to 18°C and 28°C to 59°C)

Relative Humidity: 0% to 90% non-condensing

Altitude Operating/Non-operating: 6,562 ft. (2,000 meters)/ 40,000 ft. (12,200 meters)

Input Impedance: 10 MΩ

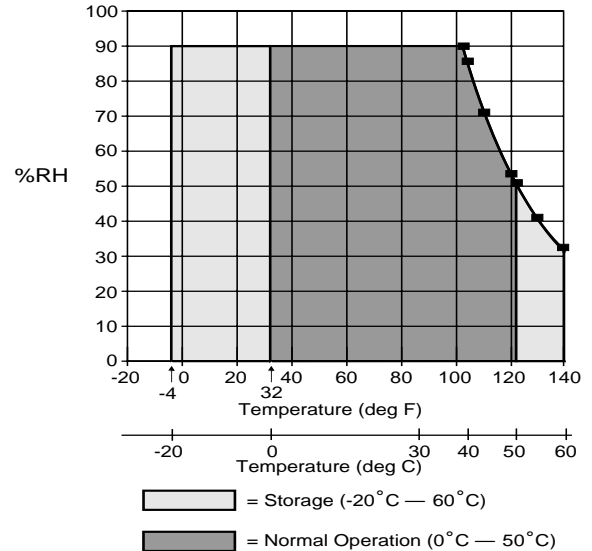

f34.eps

867B/863

Users Manual

Shock and Vibration: per MIL-T-28800, class 3, sinusoidal, non-operating

Dimensions: 5.4 x 9.7 x 2.7 in. (137 x 246 x 68 mm)

Weight: 3 lbs (1.35 kg)

Battery Operating Time (backlight off)

Alkaline: 6 hours typical

NiCd: 10 hours typical

Battery Recharge Time: 16 hours minimum from full discharge

Drip Proof Case: per IEC 529; IP 52, Drip Proof

Power:

Safety: Designed to meet IEC 1010-1 Category III, UL3111, CSA-C22.2. 1010-1-92, CE and TUV requirements

Certification: P



Electromagnetic Interference

RF Emissions EN-50081-1 Commercial Limits
VFG 243-1991

FCC Part 15 Class B,

RF Susceptibility: EN 50082-1 Industrial Limits

	Fluke 867B	Fluke 863
Battery Eliminator/Charger	Yes	Optional Eliminator only
NiCd Battery Pack	Yes	Optional BP7217 Battery Pack Optional BC7210 Ext. Charger
Alkaline Batteries 6 AA Cells	Optional Customer Supplied	Yes
Battery Life: NiCad	≥8 hrs (supplied)	≥10 hrs (optional)
Alkaline	≥4 hrs (optional)	≥6 hrs (supplied)

Specifications: The following specifications apply within 1 year of calibration when operating in a temperature range of 18°C (64°F) to 28°C (82°F).

AC Volts (True RMS, AC-Coupled) [\pm (percent of reading + counts)]

Range	Frequency					
	20-50 Hz	50-100 Hz	1 kHz-30 kHz	30 kHz-100 kHz	100kHz-200kHz	200 kHz-300 kHz
300.00 mV	1.5% + 10 0.19 dB	0.5% + 10 0.10 dB	0.5% + 10 0.10 dB	4% + 200 1.39 dB	8% + 200 1.68 dB	10%+ 200 1.82 dB
3.0000V	1.5% + 10 0.19 dB	0.5% + 10 0.10 dB	0.5% + 10 0.10 dB	4% + 200 1.39 dB	8% + 200 1.68 dB	10%+ 200 1.82 dB
30.000V	1.5% + 10 0.19 dB	0.5% + 10 0.10 dB	0.5% + 10 0.10 dB	4% + 200 1.39 dB	8% + 200 1.68 dB	10%+ 200 1.82 dB
300.00V	1.5% + 10 0.19 dB	0.5% + 10 0.10 dB	0.5% + 10 0.10 dB	4% + 200 1.39 dB	8% + 200 1.68 dB	10%+ 200 1.82 dB
1000.0V	1.5% + 10 0.19 dB	1.5% + 10 0.19 dB	NA	NA	NA	NA

Crest Factor: 300 mV - 300V ranges $\geq 3:1$, 1000V range $\geq 3:1$ decreasing to $\geq 1.41:1$ as input voltage increases to 1000V (peak voltage not to exceed 1414V).

Measurement Range: 300 mV range from 10% to 100% of range.
 3V - 1000V ranges from 5% to 100% of range.
 For frequencies > 100 kHz 30% to 100% of range (all ranges).

AC Volts - Average Responding AC Coupled [\pm (percent of reading + counts)]

Range	Frequency			
	20 - 50 Hz	50 - 100 Hz	1 kHz - 30 kHz	30 kHz - 50 kHz
300.0 mV	1.5% + 4 0.25 dB	0.5% + 4 0.16 dB	0.5% + 4 0.16 dB	2% + 4 0.25 dB
3.000V	1.5% + 4 0.25 dB	0.5% + 4 0.16 dB	0.5% + 4 0.16 dB	2% + 4 0.25 dB
30.00V	1.5% + 4 0.25 dB	0.5% + 4 0.16 dB	0.5% + 4 0.16 dB	2% + 4 0.25 dB
300.0V	1.5% + 4 0.25 dB	0.5% + 4 0.16 dB	0.5% + 4 0.16 dB	2% + 4 0.25 dB
1000V	1.5% + 4 0.25 dB	1.5% + 4 0.25 dB	NA	NA

Input Impedance: 1.11 M Ω \pm 1% in series with 0.1 μ F
Volts-Hertz Product: 2 x 10⁷
Common Mode Rejection: >60 dB at 50 Hz and 60 Hz (1 k Ω unbalance)
Common Mode Volts-Hertz Product: 1 x 10⁷
dBm Reference: 2, 4, 8, 16, 50, 75, 93, 110, 125, 135, 150, 300, 600, 900, 1000, and 1200 Ω
Overload Protection: 1000V rms

DC Volts [\pm (percent of reading + counts)]

Function	Range	Fluke 867B	Fluke 863
mV DC	300.00 mV	0.025% + 2	0.04% + 2
	3000.0 mV	0.025% + 2	0.04% + 2
V DC	30.000V	0.025% + 2	0.04% + 2
	300.00V	0.025% + 2	0.04% + 2
	1000.0V	0.025% + 2	0.04% + 2

Input Impedance: V DC-10 M Ω , mV DC-10 M Ω , mV DC Hi-Z ->1000 M Ω
Normal Mode Rejection: >60 dB at 50 Hz or 60 Hz
Common Mode Rejection: >120 dB a dc, >90 dB at 50 Hz and 60 Hz (1 k Ω unbalance)
Overload Protection: 1000 V rms
Maximum Allowable Peak AC + DC Voltage (without causing a reading error)
 300 mV, 3000 mV ranges: 15V
 30V range: 1000V; 300V, 1000V ranges: 1414V

Diode Test (Manual)

Range: 3V

Resolution: 0.0001V

Accuracy: \pm 0.05% of reading + 2 digits

Open Circuit Voltage: 3.1V

Diode Test (Auto)

Accuracy: 20%

Current Ranges

Ranges for True RMS AC Current and DC Current	True RMS Measurement Range (% Range to % Full Scale)	Ranges for Average Responding AC Current	Maximum Burden Voltage	Fuse Protection
300.00 μA^1	5% - 100%	300.0 μA	0.03V	440 mA @ 1000V
3000.0 μA^1	5% - 100%	3000 μA	0.3V	440 mA @ 1000V
30.000 mA	5% - 100%	30.00 mA	0.03V	440 mA @ 1000V
300.00 mA	5% - 100%	300.0 mA	0.3V	440 mA @ 1000V
3.0000A	5% - 100%	3.000A	0.1V	11A @ 1000V
10.000A	5% - 100%	10.00A	0.3V	11A @ 1000V

1. DC ranges available on the Fluke 867B only.

Current Accuracy [\pm (percent of reading + counts)]

Range	DC Current Accuracy	True RMS AC Current Accuracy (Average AC counts ³)			
		20 Hz to 50 Hz	50 Hz to 3 kHz	3 kHz to 10 kHz	10 kHz to 30 kHz
300 μA^1	0.1% + 15	1% + 10 (4)	0.75% + 10 (4)	2% + 20 (4)	2% + 40 (4)
3000 μA^1	0.1% + 2	1% + 10 (4)	0.75% + 10 (4)	2% + 20 (4)	2% + 40 (4)
30 mA ²	0.05% + 15	1% + 10 (4)	0.75% + 10 (4)	2% + 20 (4)	2% + 40 (4)
300 mA	0.1% + 2	1% + 10 (4)	0.75% + 10 (4)	2% + 20 (4)	NA
3A	0.2% + 15	1% + 10 (4)	0.75% + 10 (4)	NA	NA
10A	0.2% + 2	1% + 10 (4)	0.75% + 10 (4)	NA	NA

1. Ranges available on the Fluke 867B only.

2. Fluke 863 30 mA DC range accuracy 0.1% + 15.

3. Replace counts with Average AC counts for Average Responding AC measurements. In 300 μA range, floor count increases to 20 with battery eliminator.

Conductance [\pm (percent of reading + counts)]

Range	Accuracy	Open Circuit Voltage
3000.0 nS	0.5% + 20	3.2V
300.00 nS	0.5% + 20	3.2V
Overload Protection: 1000V rms		

Capacitance [\pm (percent of reading + counts)]

Range	Accuracy
10000 pF ¹	1.9% + 20
.1000 μ F	1.9% + 2
1.000 μ F	1.9% + 2
10.00 μ F	1.9% + 2
100.0 μ F	1.9% + 2
1000 μ F	1.9% + 2
10000 μ F ^{2,3}	10% + 900
Overload Protection: 1000V rms	
1. 10,000 pF range last digit reads zero.	
2. 10,000 μ F range last two digits read zero.	
3. Using REL to zero internal offset.	

Continuity Beeper Values

Range	Beeper On	Beeper Off
300 Ω	32 Ω	136 Ω
3 k Ω	212 Ω	725 Ω
30 k Ω	1586 Ω	4799 Ω
300 k Ω	15.3 k Ω	45.5 k Ω
3 M Ω	152.7 k Ω	459.1 k Ω
30 M Ω	66 k Ω	194 k Ω

Resistance [\pm (percent of reading + counts)]

Range	Accuracy	Maximum Current	Open Circuit Voltage
300.00 Ω	0.07% + 10	1 mA	3.2V
3.0000 k Ω	0.07% + 2	120 μ A	1.5V
30.000 k Ω	0.07% + 2	14 μ A	1.5V
300.00 k Ω	0.07% + 2	1.5 μ A	1.5V
3.0000 M Ω	0.15% + 2	150 nA	1.5V
30.000 M Ω	0.2% + 3	320 nA	3.2V

Frequency

AC Sensitivity

AC Volts		AC Current		
Frequency	Sine Wave Level	Frequency	Ranges	Sine Wave Level
2 Hz - 500 kHz	60 mV rms	5 Hz - 30 kHz	300 μ A - 300 mA	20% of range
500 kHz - 1 MHz	100 mV rms	5 Hz - 2 kHz	3A	300 mA
1 MHz - 2 MHz*	1V rms	5 Hz - 2 kHz	10A	3A

* Use single trigger mode for inputs above 1 MHz.

Sensitivity using DC Meter Functions

DC Volts		DC Current	
Range	Trigger Level	Ranges	Trigger Level
3V	1.5V	All ranges	10% of range
All other ranges	10% of range		

Accuracy [\pm (percent of reading + counts)]

Range	Accuracy
1000.00 Hz	0.05% + 2
10.0000 kHz	0.05% + 1
100.000 kHz	0.05% + 1
1.00000 MHz	0.05% + 1
2.0000 MHz	0.05% + 1

Duty Cycle

Range: 0.1% to 99.9%

Accuracy: $\pm(5.2\%$ divided by the pulse width in microseconds + 2 counts) (1 ms = 1000 microseconds).

Period

Ranges: 999.99 μ s, 9.999 ms, 99.99 ms, and 999 ms

Accuracy: $\pm(0.05\%$ of reading + 2 counts)

Pulse Width

Ranges: 999.99 μ s, 9.999 ms, 99.99 ms, and 999 ms

Accuracy: $\pm(5.2\%$ divided by the pulse width in microseconds + 2 counts) (1 ms = 1000 microseconds).

Logic (Fluke 867B Only)

Trigger Levels¹		
Logic Family	Low	High
3V CMOS	1.4V	1.7V
5V CMOS	2.6V	2.8V
TTL	1.7V	1.9V

1. Frequency measurements will trigger on the logic family high levels. All measurements are made using the Logic/Ext. Trig. input jack.
2. For frequency > 1 MHz use full logic level.

Frequency Measurements	
Frequency	Accuracy
1000.00 Hz	0.05% + 2
10.0000 kHz	0.05% + 1
100.000 kHz	0.05% + 1
1.00000 MHz	0.05% + 1
2.0000 MHz	0.05% + 1
10.0000 MHz	0.05% + 1

Peak Hold

Captures peak minimums and maximums of signals $\geq 10 \mu\text{s}$.

Accuracy: $\pm(5\%$ of reading + 30 counts)

MIN/MAX/AVG

Accuracy: add 8 counts to the number of counts in the accuracy table of the selected function.

View Mode Specifications

Horizontal Specifications

Sample Rate: 4.8 Megasamples per second

Sample per Division: 20 per horizontal division

Samples Captured: 512 in Single Shot and Glitch Capture; 256 all other modes

Update Rate: 4 times per second

Vertical Specifications

to be determined by Dave P.

Time Base

Modes: Single Shot and Recurrent

Ranges: From $4.2 \mu\text{s}$ per division to 5 seconds per division

Trigger

Types: Internal and External

Coupling: AC, DC and Glitch Capture

External Trigger Impedance: 1 M Ω in parallel with $\leq 75 \text{ pF}$

External Trigger Input: Logic/External Trigger Terminal

External Trigger Level: $\pm 5\text{V}$ adjustable in ± 10 steps

Amplitude Specifications

Amplitude Resolution: 8 bits

Frequency Response (-3 dB)

Volts DC Coupled: DC to 1 Mhz

Volts AC Coupled: 3 Hz to 1 MHz

Input Impedance

Refer to the meter mode specifications

Glitch Capture

Glitch Trigger Level:

20% of range 300 mV - 300V

6% of range 1000V

Minimum Glitch Time: 1 μs

Index

 , x

 , ix, x

 , 2-21, 3-8, 3-9

 , 1-3, 3-6, 3-9

 , 2-12

 , 2-3, 2-12, 2-21

 , 2-12, 2-13

 , 3-9, 4-6

 , 2-23, 4-2

 , 2-23, 4-2

—A—

AC Converter, 6-9

ac line power, 1-3, 3-9

AC Volts Softkeys, 2-4

amplitude, 3-4, 5-2, 6-5

Amps Softkeys, 2-13

Arm, 5-8

arm cycles, 5-8

arm-to-trigger time, 5-8

Auto, 3-4, 3-8, 6-9

Auto Diode, 1-10, 1-11, 2-12, 3-4

autorange, 1-7, 2-16, 4-5

Average, 2-2, 4-4, 5-10, 5-11

Avg, 1-7

—B—

background, 3-9, 4-3, 4-5, 6-1

backlight, 3-2

battery, 1-10, 3-1, 3-9

Battery Charger BC-7210, 3-1

Battery Eliminator, 1-3, 3-6

Baud Rate, 6-6, 6-9

beep, 3-5, 4-6

beep, long, 1-3, 2-1, 2-11

beeper, 2-3, 2-10, 6-9

Bipolar, 5-11

—C—

Combo Mode, 1-9
Capacitance, ix, 2-11, 2-12, 2-13, 2-18, 3-10
Clear, 6-3, 6-5
Combo Mode, 1-2, 1-11, 2-1, 2-2, 3-4, 3-6, 3-7, 4-1, 4-6, 6-9
Component Test, ix, 1-3, 1-10, 2-17, 2-18, 3-4, 3-6, 4-6
COMPONENT TEST Softkeys, 2-17
Conductance, 2-9, 2-10, 3-10
configuration, 4-3, 6-3
configuration memories, 6-4
Continuity, ix, 2-3, 2-9, 2-10, 2-12, 3-10
contrast, 3-2, 6-8, 7-8

—D—

data points, 5-10
dB, 2-2, 3-7, 6-9
dB Reference, 6-9
DC Volts Softkeys, 1-6, 2-6

Diode/Capacitance Softkeys, 2-11
display memories, 6-4
Display Mode, 4-1, 6-9
Display Mode Softkeys, 3-6
display modes, 1-6
Dual, 6-9
Duty Cycle, 1-7, 2-23, 4-2

—E—

Enable RS232, 5-10
Epson, 6-9
Exit, 4-3, 4-4, 4-6, 5-3, 5-6, 5-8, 5-12, 6-3, 6-4, 6-5
External, 3-9, 5-6, 7-2
external charging, 3-1
external trigger, 3-5

—F—

Faster, 5-3
FlukeView 860, 6-6
Free Run, 5-8
Freeze, 3-5, 4-3
Freeze message, 4-3, 6-1

Frequency Softkeys, 1-7, 2-22, 4-2
Full Auto, 2-3, 4-5, 5-1, 5-3, 5-5
Fuses, 7-2

—G—

glitch, 5-7, 5-11
Glitch Capture, 5-2, 5-7
graphical window, 1-2, 3-7, 5-10

—H—

Hardkeys, 1-3, 2-1, 4-1
High Low, 5-11
Hi-Z, 2-3, 3-9
HP Graphics, 6-9
Hz, 1-7, 2-23, 3-6, 4-2

—I—

Inductance, 2-18
Input Connection Screen, 3-7
Internal, 3-9, 5-6, 7-2
internal trigger, 5-1

—L—

LCD Contrast, 6-8, 6-9
Load Config, 6-4
Load Screen, 6-4
LOGIC Test, 3-11
logic activity indicator, 2-3, 2-20
LOGIC Test, 1-3, 1-10, 1-11, 2-3, 2-20, 3-4, 3-6, 4-5
lower status line, 1-2, 3-8

—M—

mA μ A, 1-3, 2-3, 2-15, 3-10
mA μ A Softkeys, 2-15
Manual Diode, 2-3, 2-12
manual range, 1-7, 2-16, 4-5, 4-6
Max, 1-7
Meter Mode, 1-9, 1-11, 2-1, 2-2, 3-4, 3-6, 3-7, 4-6, 6-9
Min, 1-7
Min Max, 1-7, 3-1, 3-4, 3-9, 4-5, 6-1
Min Max Off, 4-4
Min Max Softkeys, 2-24
mV DC, 2-8

—N—

nanosiemens nS, 2-10
NiCd Battery Pack BP7217, 1-3, 3-1, 7-2
Normal, 5-11

—O—

Ohms Softkeys, 2-9
OL, 3-8

—P—

Parity, 6-6, 6-9
Pause, 4-4
PC, 1-3, 6-1
Peak Hold, 2-2, 4-6, 6-1
Period, 1-7, 2-23, 4-2
power-up configuration, 4-5, 6-1, 6-8
primary display, 1-2, 1-7
Print, 4-3, 6-3, 6-4
Printer Type, 6-6, 6-9
printing, 1-3, 1-8, 3-5, 3-8, 4-3, 6-1, 6-3, 6-4
Pulse Width, 1-7, 2-23, 4-2

—R—

range, 2-3, 3-4, 5-1, 5-2, 6-9
Range Softkeys, 1-7, 2-3
recall, 1-8, 3-5, 4-3, 6-1, 6-3
Rel, 1-6, 2-2, 3-4, 3-7, 3-9
Restart Trend, 5-10
restore, 1-10, 3-5
Restore All, 6-8
Restore contrast, 3-2
reverse contrast, 3-5
rms, ix, 2-2
rms/Average, 2-2
RS232, 1-3, 3-9
Run, 4-4

—S—

safety indicator, 2-3, 2-21, 3-8
Sampled, 5-10, 5-11
save, 1-8, 4-3, 6-3, 6-5
Save Config, 4-3, 6-3
Save Screen, 4-3, 6-3
Save/Print Key, 3-5, 6-1
Save/Print Softkeys, 1-8, 4-3, 6-1
scaling factors, 4-6

secondary display, 1-2, 1-7
selector, 1-2, 2-1, 3-5
serial interface, 1-3, 3-9
Set Up, 3-6, 4-5, 5-2, 6-1, 6-6,
6-8
Single, 6-9
Single Shot, 5-2, 5-7
Single Triggering, 5-7
Sleep Mode, 1-3, 1-10, 6-9
Slope, 5-4
Slower, 5-3
softkey labels, 1-2, 2-1, 3-4
Softkeys, 1-2, 1-6, 3-4
standard configuration, 2-3, 2-
16, 2-21, 4-5, 6-8
Stop Print, 4-3, 6-3, 6-4, 6-6

—T—

Text, 6-9
time base, 2-3, 5-2, 5-3, 6-5
Time Longer, 5-10
Time Shorter, 5-10
Touch Hold, 1-7, 3-5, 3-9, 4-6,
6-1
Trend data, 5-11
Trend Mode, 1-9, 1-11, 3-1, 3-4,
3-6, 3-7, 4-6, 5-1
Trend Type, 5-10
Trigger, 5-2
trigger level,, 2-3
Trigger Mode, 6-9
Trigger Softkeys, 5-4
trigger source, 5-6

—U—

Uncal, 3-9, 7-8
unipolar, 5-11
upper status line, 1-2, 3-8, 7-8

—V—

View Memory, 6-4
View Mode, 1-9, 1-11, 2-1, 3-4,
3-6, 4-6, 5-1

—W—

wake up key, 1-2, 3-1
Wave Scale, 4-6

Instrument Security Procedures

Models:

Fluke 867, 863, 867B

Product Name:

Graphical Multimeter

Instrument Description:

High performance 5-1/2 digit multimeter.

Memory Description:

Fluke 860 Series have six devices that contain memory:

- 1) U23, Serial EEPROM, Microchip 93CL86, 1k by 16 bits, non-volatile memory used to store meter configurations and screens and calibration constants,
- 2 & 3) U21 and U20, SRAM, Cypress CY62256V. 32k by 8 bits, volatile memory, used to store display data and program RAM,
- 4 & 5) U11 and U19, OTP (one time programmable) EPROM, Atmel 27LV010A, 128k by 8 bits, used for program memory,
- 6) U24, gate array, NEC UPD65654GF, contains 512 by 8 bits RAM, used for signal processing.

Memory Cleaning Instructions:

The user controlled storage operation other than calibration constants is the storage of Min Max, Average, meter configurations and screens. Min Max and Average is cleared when the function switched is changed. The meter configurations and screens are cleared through a process outlined in the manual.

To clear the screens: Push the SAVE/PRINT button, Push the SAVE SCREEN (blue button #1), select the screen to clear using the up and down arrows (blue buttons #1 and #2), push the CLEAR button (blue button #4), repeat until all three screens positions are blank.

To clear the meter configurations: Push the SAVE/PRINT button, push the SAVE CONFIG button (blue button #4), select the configuration using the up and down arrows (blue buttons #1 and #2), push the CLEAR button, repeat until all seven positions are blank.