

Getting Started

*A New User's Guide to the
1722A Instrument Controller*



CONTENTS OF THE NEW USER'S GUIDE

START WITH THIS BOOK if this is your first experience with the Fluke Model 1722A. It contains all of the information you will need to ensure a successful first encounter. After you feel comfortable with the 1722A, continue on to the description of "The Manual Set". It will help you select the book you need next.

Enjoy your 1722A!

P/N 716613
JULY 1983
REV 1 10/83

©1983 John Fluke Mfg. Co., Inc.,
all rights reserved. Litho in U.S.A.

Meet the 1722A Instrument Controller	1
The Keyboard and Front Panel	2
The Rear Panel	4
Disks	5
Turning the 1722A On	6
The Getting Started Program	8
Writing a BASIC Program	10
Saving Your Program	12
Looking On The Disk	13
Retrieving Your Program	14
Using the Basic Editor	15
Writing a Program	16
The "Getting Started Environment"	17
Everybody Makes Mistakes	18
The 1722A As an Instrument Controller	19
The Manual Set	20
How to Use These Manuals	21

MEET THE 1722A INSTRUMENT CONTROLLER

Your 1722A Instrument Controller is a versatile, high-speed computing and controlling tool. Its unique Touch-Sensitive Display allows you to design a friendly-to-use system that gives predictable results. Here are just a few of the many performance capabilities:

- An extensive easy-to-use BASIC interpreter with a program editor that checks for syntax errors as lines are entered.
- A consistent file structure that manages system software, program files, and data files in the same way.
- A complete set of BASIC and system commands that allow you to prepare disks and organize your files easily.
- A touch-sensitive graphics and character display that allows you to plot data results and serves as the primary system user interface.

The 1722A includes versatile software tools designed for the task of programming and configuring an automated system. This manual will help you become familiar with 1722A system capabilities and with basic programming practices so that you can quickly begin to see results.

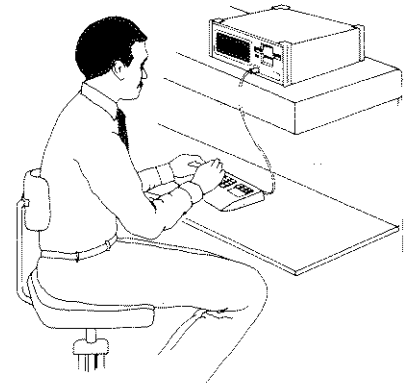

THE KEYBOARD AND FRONT PANEL

Locate the following items:

THE TOUCH-SENSITIVE DISPLAY Touch-sensitive high-resolution graphics and character display.

FRONT PANEL CONTROLS RESTART reloads system software and performs your defined startup sequence leaving any programs and data files stored on E-Disk (Electronic Disk) intact. ABORT stops a program while it's running. Press RESTART and ABORT together to clear memory and perform a self test followed by a normal RESTART.

DISK DRIVE 5-1/4 inch 400K byte removable disk stores programs and data files.

KEYBOARD

- The Keyboard connects to the 1722A Front Panel.
- It is used for program generation or keyboard control of the 1722A.
- It generates the full ASCII (American Standard Code for Information Interchange) character set and has a keypad for text editor functions.

THE KEYBOARD AND FRONT PANEL

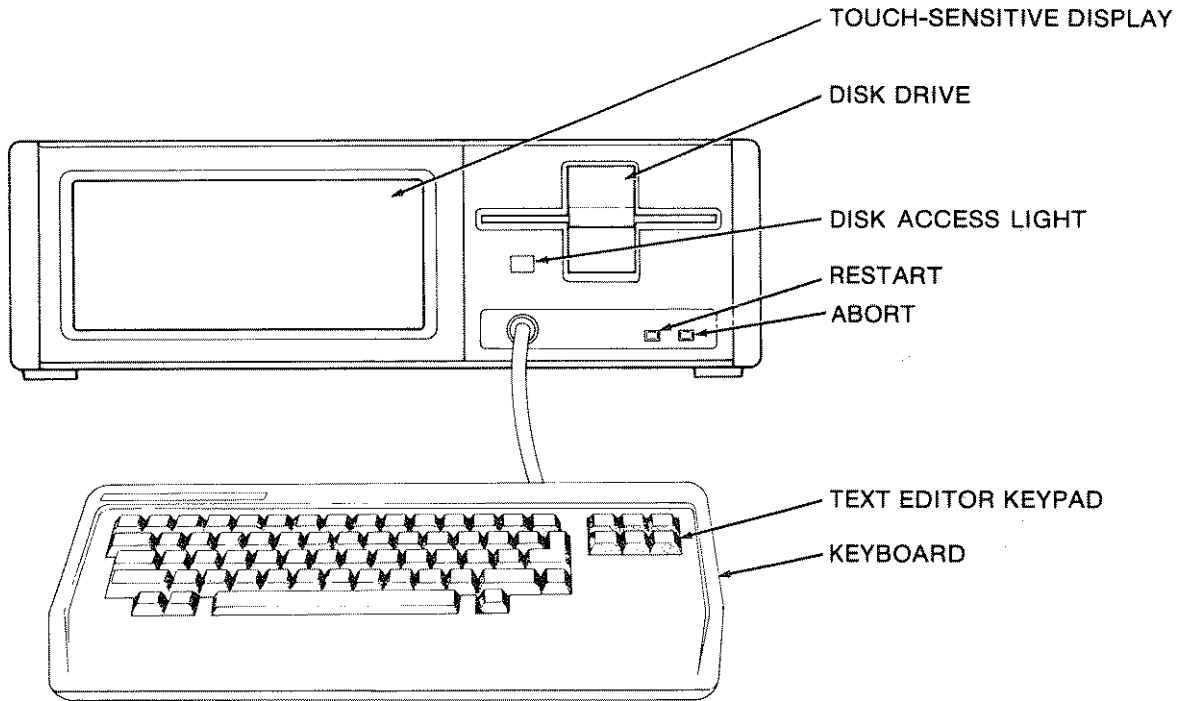

THE REAR PANEL

- | | |
|--------------------------------|---|
| POWER INFORMATION LABEL | Contains power information. Check for compatibility with local line power. |
| LINE POWER CORD | Connects the 1722A to a line power outlet. |
| POWER SWITCH | Turns the 1722A on or off. |
| AIR FILTER | Filters dust out of the incoming cooling air. Allow clearance behind the 1722A for cooling. |
| ADDITIONAL MODULE SLOTS | Options are factory installed only if requested in your order. The options are not required for the exercises in this book. |

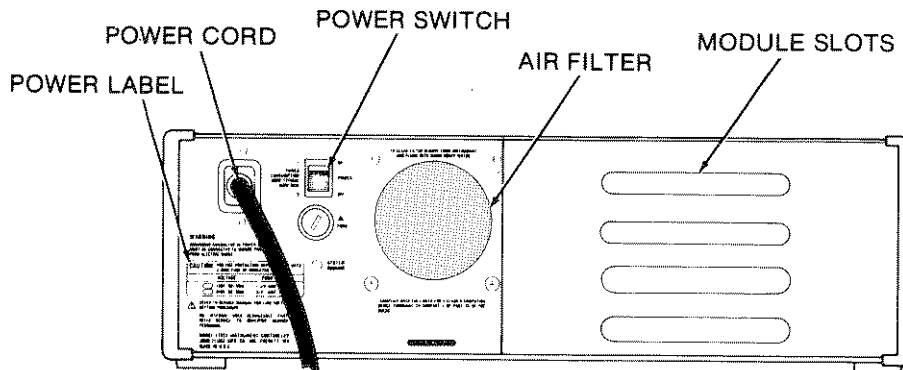

DISKS

Disks are removable storage media for programs and data files.

During insertion and removal, hold the disk as shown in the illustration.

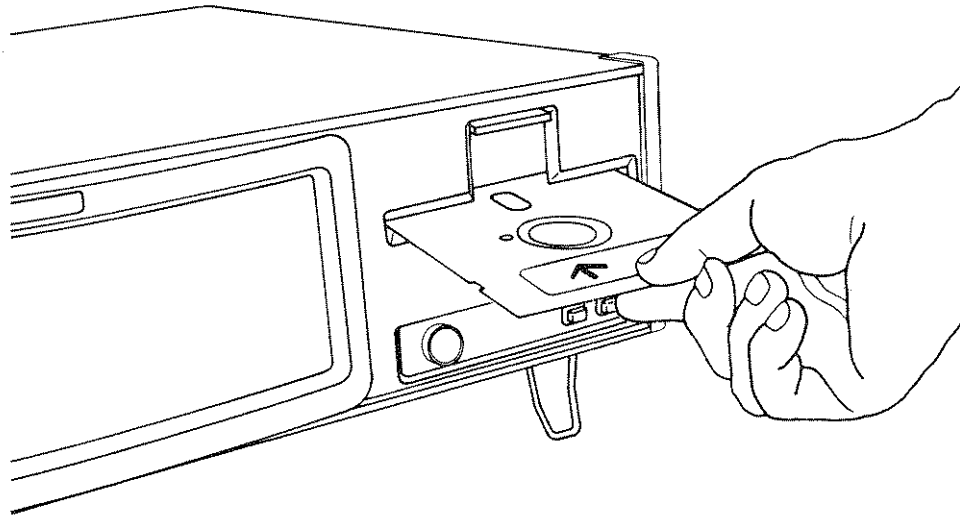

**NEVER
TOUCH THE
DISK'S
SURFACE**



**KEEP THE
DISK AWAY
FROM
MAGNETIC
FIELDS**



**NEVER
BEND
THE
DISK**

TURNING THE 1722A ON

REMOVE DRIVE PROTECTOR

Open the Disk Drive latch and remove the cardboard shipping protector.

Check that the Power Switch is OFF.

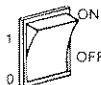

CONNECT TO A POWER SOURCE

Connect the Keyboard to the Front Panel. Connect the Power Cord to the Rear Panel, then to a power outlet. Refer to the 1722A System Guide if you need more detailed information on power requirements.

TURN THE 1722A ON

Set the Power Switch to the ON position.

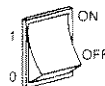

DISPLAY MESSAGES

After power is applied, a series of system messages is displayed while the display warms up. You may not see each message unless the 1722A is already warm:

HELLO

The 1722A has initiated its internal start sequence.

SELF TEST IN PROGRESS

The 1722A is performing a test of major components.

NOTE

Refer to Section 3 of the 1722A System Guide if any error messages are displayed.

TURNING THE 1722A ON

As shown earlier, gently insert the Getting Started Disk, label side up, into the Disk Drive until it is fully seated. Be careful not to touch the disk surface, and do not force the disk into place. Close the Disk Drive door.

If the message “?DISK not ready...” is displayed, the disk was not in place when the 1722A attempted to load the system program. If this happens, check the disk to ensure that it is properly inserted and touch the display.

1722A System Software is being read into memory from the disk.

The start-up sequence stored on the Getting Started disk is now being performed. The last step in this sequence starts the Getting Started program.

**INSERT THE GETTING
STARTED DISK**

TOUCH THE DISPLAY

LOADING

**Startup Command File
execution in progress
please standby...**

THE GETTING STARTED PROGRAM

DEMO PROGRAM

PLOT OUR
DATA

The Getting Started program provides a demonstration of a typical plot on the 1722A display, and offers you an opportunity to change and replot the data using the Touch-Sensitive Display. You will not need to use the Keyboard.

Touch the display block labeled PLOT OUR DATA. The 1722A will clear the display and plot the data stored on the Getting Started disk. When the 1722A is done, touch the display again to return to the menu.

ENTER
NEW DATA

Touch the display block labeled ENTER NEW DATA. The 1722A will clear the display and present you with a keypad for entering new data. After you have entered 10 values, the 1722A will automatically return to the menu.

PLOT YOUR
DATA

Touch the display block labeled PLOT YOUR DATA. The 1722A will clear the display and plot the data you have just entered. When the 1722A is done, touch the display again to return to the menu.

ABORT



Press the ABORT switch on the 1722A Front Panel to stop the program. If you have not plugged in the Keyboard, do it now. Then type: RUN "MENU" and press RETURN. The 1722A will return to the menu display. You can do this any time you wish to return to the menu.

THE GETTING STARTED PROGRAM

Press the RESTART switch on the 1722A Front Panel. The System Software will be reloaded into memory from the Getting Started disk, and the start-up sequence will be performed again. Touch PLOT YOUR DATA, and you will see that your data is still intact because it was stored on the disk. Touch the display again to return to the menu.



Touch the display block labeled OTHER PROGRAMS. The 1722A will clear the display and show a different menu of additional programs. Use the Touch-Sensitive Display and the Keyboard to try out the programs. Feel free to use any keys or switches. You will not affect any of the recorded programs. Press RESTART any time you wish to start over.



WRITING A BASIC PROGRAM

GETTING READY

If you have not done so, connect the Keyboard to the Front Panel.

Press RESTART to return to the menu.

Press ABORT on the Front Panel. This will stop the program.

Type <CTRL>/T (hold down CTRL then press T). This will clear the display.

WHAT'S IN MEMORY

Type LIST, then press RETURN. You will see the MENU program scrolling quickly by. Press PAGE MODE to stop the scrolling. Then press NEXT PAGE, and you will get 15 more lines as the bottom line scrolls to the top.

Press PAGE MODE again. This turns the page mode indicator off and allows the program to scroll to the end.

CLEAR MEMORY

Type DELETE ALL, then press RETURN. This erases the MENU program from main memory. A copy of it is still saved for you on the Getting Started disk.

Type LIST, then press RETURN. The screen will now clear and display READY. You now have a clean workspace in which to write a program.

A SHORT BASIC PROGRAM

Type in the following BASIC program without the comments which are shown in parentheses. You must press RETURN at the end of each line:

```
10 WAIT FOR KEY      (Wait for a touch sense)
20 K = KEY           (Read the touch sense)
30 PRINT K           (Display the touch sense)
40 GOTO 10           (Wait for another touch sense)
50 END
```

WRITING A BASIC PROGRAM

If you make a mistake, press DELETE to back up. Then correct the error. If you have already entered the line and have pressed RETURN, just retype the line with the same line number to replace it.

Type RUN, then press RETURN.

If your program contains any errors, it will stop and tell you which line was in error. For example, if you had entered line 10 as

```
10 WAIT FOR KAY
```

you will get the error message "ISyntax error nn at line 10" (nn is an error code number). Just retype the line, and the program will replace the line containing the error with the corrected line.

If you do not get any error messages, touch the display. The program will tell you what touch number was sensed. As you touch around the screen, you will see that-touch sense numbers start with #1 in the upper left and continue through #60 in the lower right.

Your program easily finds out where the screen was touched!

MAKING CORRECTIONS

RUN YOUR PROGRAM

ERROR DETECTION

USING YOUR PROGRAM

SAVING YOUR PROGRAM

STOP YOUR PROGRAM

Press ABORT (on the front panel). This will stop your program.

LIST IT

Type LIST, then press RETURN. You will see a copy of your program taken from main memory. If you were to clear memory again (DELETE ALL), or turn the 1722A off, you would lose your program until you retype it.

SAVE IT

Type SAVE "TSENSE", then press RETURN. The disk access light indicates that your program is being saved on the disk.

LOOKING ON THE DISK

Type QDIR (short for Quick DIRectory), then press RETURN. You will see a list of the files on the Getting Started disk. At the end of the list you will see TSENSE.BAS. That is the program that you just saved. The 1722A added the ".BAS" to indicate that it is a BASIC program.

THE FILE DIRECTORY

Take a look at the list of files. Notice that the 1722A uses three-letter suffixes to identify different types of files. Files may contain system software, utility programs (such as editors), data arrays, text, and programs in a variety of programming languages. As you become familiar with 1722A file-handling tools, you will find that files are all treated the same except where the file type makes a difference. The 1722A System Guide contains complete descriptions of the file name suffixes used by the 1722A to identify the file type.

FILE TYPES

Type <CTRL>/R (hold down CTRL then press R). Notice that the QDIR command you just entered is displayed again. If you had typed it incorrectly, you could use the left and right arrow keys to back in and fix it. In fact the DEL CHAR and DEL LINE keys also work for this.

FIXING TYPING ERRORS

The 1722A saves the commands that you enter in case you want to recall them and use them again. When you use this recall feature, it activates the editing keypad so you can make changes. You will find this convenience saves typing.

RETRIEVING YOUR PROGRAM

- RUN IT** Type RUN, press RETURN. Touch the display and you will see that your program is still intact in memory and runs just fine.
- Press ABORT to stop your program.
- DELETE IT** Type DELETE ALL, then press RETURN to clear memory.
- Type RUN, then press RETURN. The 1722A displays READY to indicate that there was no program to run.
- RETRIEVE IT** Type RUN "TSENSE", then press RETURN. The 1722A now turns on the disk, finds your program, and begins running it. Try touching the display to make sure that your program is running.
- DELETE IT AGAIN** Press ABORT to stop the program. Type DELETE ALL, then press Return.
- Type LIST, then press RETURN. The 1722A displays READY to indicate that there is no program in memory to list.
- RETRIEVE IT AGAIN** Type OLD "TSENSE", then press RETURN. The 1722A turns on the disk, finds your program, reads it into memory, and displays READY.
- LIST IT** Type LIST, then press RETURN. Your program is in memory again.
- Type RUN, then press RETURN. Your program begins running again.
- As you can see, the command RUN "program" finds your program on the disk, reads it into memory, and starts running it. OLD "program" finds your program on the disk and reads it into memory without running it.

USING THE BASIC EDITOR

Press **ABORT** to stop your program.

Type **EDIT**, then press **RETURN**. Your program will be displayed with the cursor at the beginning of the first line.

Experiment with the arrow keys to move the cursor around in your program.

Try **BACK SPACE**. It moves the cursor to the beginning of the line.

Try **LINE FEED**. It moves the cursor to the end of the line.

Try **DELETE**. It removes a character to the left of the cursor each time it is pressed. Don't worry about correcting your changes for now.

Use the left arrow key to back up to the middle of a line. Try **DEL CHAR**. It removes a character at the cursor position each time it is pressed.

Try **DEL LINE**. It removes everything from the cursor to the end of the line. If the cursor is at the beginning of the line, the entire line is deleted.

Press **RETURN**. Notice that a blank line is inserted when **RETURN** is pressed at the end of a line. If the cursor is in the middle of a line, the line is split into two lines.

Type **TEST**. Notice that each character appears at the cursor position.

Press the up arrow key. The blinking message "linenumber missing" indicates that you must add a line number to the beginning of the line before you leave the line.

THE EDITOR KEYS

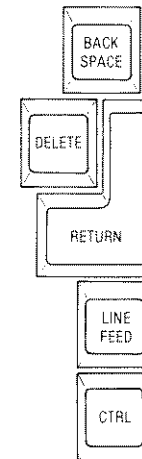
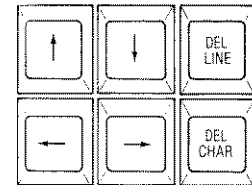

WRITING A PROGRAM

THE WRITING WORKSPACE

Enough practice. Let's use the editor to write a new program.

Type `<CTRL>/C` (hold down CTRL then press C). This leaves the EDIT mode.

Type `DELETE ALL`, then press `RETURN`. This clears memory workspace.

Type `EDIT`, then press `RETURN`. You are back in the editor with a clean workspace.

A SAMPLE PROGRAM

Type in the program that follows. Use the editor to correct any errors you may make:

```
10 WAIT FOR KEY
20 K = KEY
30 IF K <= 30 THEN PRINT "TOP"
40 IF K >= 31 THEN PRINT "BOTTOM"
50 GOTO 10
60 END
```

When you are done, type `<CTRL>/C` to exit the edit mode. If you pressed `RETURN` after line 60, the editor will display the blinking error message:
Empty line You can ignore this message.

RUN THE PROGRAM

Type `RUN`, then press `RETURN`.

Try touching the display in several places. Your program easily tells the difference between touching the top and bottom halves of the display!

HOW TO USE THESE MANUALS

ARE YOU EVALUATING THE 1722A?

The 1722A System Guide includes a specification summary and configuration information. With the help of your local Fluke Sales Office, this information will help you determine if the 1722A is appropriate for your task. Also, since selecting an instrument controller or industrial microcomputer is too complex to be done on the basis of specifications alone, each Fluke District Sales Office also has one or more System Engineers available to help you.

The 1722A is focused more on specific industrial needs than general purpose or personal computers that are often adapted for this purpose. This focus is a result of Fluke's 35 years experience building quality industrial instrumentation. You will find it in the multi-level customer support available, the capable flexibility of 1722A system software, and the quality of its manuals. These have a major impact on the magnitude of the task required to design and develop your system.

THE 1722A USER GROUP AND SOFTWARE LIBRARY

Fluke encourages users of Fluke instrument controllers to sign up for the User Group. A periodic newsletter is used as an informal information exchange to create a dialog with interested users. The software library includes a large and growing list of programs that have been contributed from both inside and outside the Fluke organization. Ask your local Fluke Sales office for details.

HOW TO USE THESE MANUALS

The answers to most of your questions about the 1722A are in the manual set. The manual set is structured to support both learning and reference access. The following paragraphs are intended to provide you with some direction, depending on your objectives.

Each manual includes tutorial information followed by reference material. Examples are included to allow you hands-on familiarization. We suggest that you do the exercises in this Getting Started Guide first. Then you should work through the 1722A System Guide, skipping the reference material. The system familiarity you gain will prove valuable as you begin programming the 1722A. Then you should work through the BASIC Programming Manual, even if you will be using a different language. Many of the examples and system information are applicable to any language, and you will find that most of your simpler tasks are easier to accomplish in BASIC.

Before heading straight for the center of the programming manual, do take a few minutes to look through the 1722A System Guide. The table of contents will give you a quick summary of the kind of system information provided. The consistent internal format and the index make it easy to find information when you need it. The 1722A includes some unique capabilities that you will need to understand before you can use them effectively. And, you will not want to miss any convenience features such as the recall buffer mentioned on page 13.

ARE YOU NEW TO THIS?

ARE YOU AN EXPERIENCED PROGRAMMER?

THE MANUAL SET

The 1722A manual set is organized in reference form with multiple access routes to information. These include tab dividers, indexes, section headers on each page, and a consistent readable format. This is supplemented with tutorial introductions and numerous examples to give you hands-on experience and some problem-solving software tools. The following short description of the manuals gives you an idea of what each contains.

- 1722A GETTING STARTED GUIDE** This short tutorial guide helps the new user get started using and programming the 1722A. It includes a companion disk with an assortment of programs that you will find useful elsewhere.
- 1722A SYSTEM GUIDE** A complete reference with supplemental tutorial information on the software and hardware system resources available to the 1722A programmer. It includes a section divider for storing this GETTING STARTED GUIDE after you have completed it.
- BASIC PROGRAMMING MANUAL** A complete reference with supplemental tutorial information and examples on the standard programming language of the 1722A.
- OPTIONS** Optional programming languages, such as FORTRAN, are supplied with a separate manual or set of manuals that rely on the 1722A System Guide. Hardware options are supplied with either a separate manual or an insert for the System Guide, depending on the amount of information.

THE 1722A AS AN INSTRUMENT CONTROLLER

One of the tasks the 1722A does well is to serve as the instrument controller for an automated test equipment system using programmable instrumentation. The rack-mountable package uses a minimum of rack space while providing considerable computing power. The Touch-Sensitive Display provides a friendly operator interface that is easy for you to program, and neatly solves the problem of what to do with the keyboard.

An industry standard IEEE-488 interface is included with your 1722A for interconnecting with other instrumentation. If you are not familiar with the IEEE-488 standard, a useful analogy is to think of the controller as directing a meeting. The controller can designate one talker at a time and any number of listeners. The controller can also pass control to other controllers.

A talker is any device that sends data. An IEEE-488 compatible voltmeter could be a talker.

A listener is any device that receives data. An IEEE-488 compatible printer could be a listener.

A controller is a device that can designate talkers and listeners. It does this by asserting control over the interface bus (command mode) and then sending commands to other devices at preset addresses. Nothing in the IEEE-488 standard requires a controller to have computing power like the 1722A. The 1722A, however, can also act as a talker or listener (data mode) collecting and sending large amounts of data. The data can be quickly processed for meaningful display or storage, or it can be used as the basis for system command decisions.

SYSTEM CONTROL

WHO DIRECTS?

WHO TALKS?

WHO LISTENS?

THE 1722A INSTRUMENT CONTROLLER

EVERYBODY MAKES MISTEAKS

ERROR DESCRIPTIONS

1722A System Software includes numerous checks at many different levels to detect and identify errors. The 1722A System Guide describes system level errors. The manuals for each programming language describe errors such as program syntax errors which are detected and identified by each language processor.

ERROR MESSAGES

Below are a few common errors that you may encounter while using this Getting Started Guide:

`?No system on device`

The 1722A attempted to load system software from the disk following a RESTART, and could not find any. Make sure the Getting Started disk or a System Disk is in place.

`?Disk not ready`

This message is normally the result of a disk access when there was no disk in the drive. It can also occur when the door was left open during a disk access.

HELP IS AVAILABLE

If you encounter any other problems, consult the 1722A System Guide for more information. Also feel free to call your local Fluke office for assistance.

THE “GETTING STARTED ENVIRONMENT”

The software provided on this Getting Started disk has been set up to make it easy for you to become familiar with the 1722A Instrument Controller. 1722A System Software, however, is similar in many ways to traditional minicomputer structure. It includes utility programs for such things as merging, copying, and deleting files, and for setting serial port parameters and the time of day for its internal clock. These capabilities are described in the 1722A System Guide.

SYSTEM SOFTWARE

Included on the Getting Started disk is a file of 1722A system start-up commands that automatically select BASIC as the programming language and start the first program running. In addition, the start-up command file defines the “home state” of the system to be the BASIC interpreter so that all utility program exits will return to BASIC.

AT HOME WITH BASIC

As you become more familiar with the 1722A, you may want to look over the files on this disk. They contain some useful tools. Although many of the files on this disk are not documented in this Getting Started booklet, they may prove useful in your applications. Here are just a few examples:

SOME BASIC TOOLS

TTIME is a BASIC program that allows the system operator to set the time and date on the Touch-Sensitive Display without using the Keyboard.

FORMAT is a utility command file that may be used from within a BASIC program. It allows the system operator to format blank data disks, using only the Touch-Sensitive Display.

MASTER is a general-purpose touch sense menu program that you can use to select and run any number of other programs.