

FLUKE®

54200

TV Signal Generator

Users Manual

4822 872 10182

November 1996, Rev. 4 4/98

© 1996 Fluke Corporation, All rights reserved. Printed in the Netherlands.

All product names are trademarks of their respective companies.

Limited Warranty & Limitation of Liability

Each Fluke product is warranted to be free from defects in material and workmanship under normal use and service. The warranty period is one year and begins on the date of shipment. Parts, product repairs and services are warranted for 90 days. This warranty extends only to the original buyer or end-user customer of a Fluke authorized reseller, and does not apply to fuses, disposable batteries or to any product which, in Fluke's opinion, has been misused, altered, neglected or damaged by accident or abnormal conditions of operation or handling. Fluke warrants that software will operate substantially in accordance with its functional specifications for 90 days and that it has been properly recorded on non-defective media. Fluke does not warrant that software will be error free or operate without interruption.

Fluke authorized resellers shall extend this warranty on new and unused products to end-user customers only but have no authority to extend a greater or different warranty on behalf of Fluke. Warranty support is available if product is purchased through a Fluke authorized sales outlet or Buyer has paid the applicable international price. Fluke reserves the right to invoice Buyer for importation costs of repair/replacement parts when product purchased in one country is submitted for repair in another country.

Fluke's warranty obligation is limited, at Fluke's opinion, to refund of the purchase price, free of charge repair, or replacement of a defective product which is returned to an Fluke authorized service center within the warranty period.

To obtain warranty service, contact your nearest Fluke authorized service center or send the product, with a description of the difficulty, postage and insurance prepaid (FOB Destination), to the nearest Fluke authorized service center. Fluke assumes no risk for damage in transit. Following warranty repair, the product will be returned to Buyer, transportation prepaid (FOB Destination). If Fluke determines that the failure was caused by misuse, alteration, accident or abnormal condition of operation or handling, Fluke will provide an estimate of repair costs and obtain authorization before commencing the work. Following repair, the product will be returned to the Buyer transportation prepaid and the Buyer will be billed for the repair and return transportation charges (FOB Shipping Point).

THIS WARRANTY IS BUYER'S SOLE AND EXCLUSIVE REMEDY AND IS IN LIEU OF ALL OTHER WARRANTIES, EXPRESS OR IMPLIED, INCLUDING BUT NOT LIMITED TO ANY IMPLIED WARRANTY OF MERCHANTABILITY OR FITNESS FOR A PARTICULAR PURPOSE. FLUKE SHALL NOT BE LIABLE FOR ANY SPECIAL, INDIRECT, INCIDENTAL OR CONSEQUENTIAL DAMAGES OR LOSSES, INCLUDING LOSS OF DATA, WHETHER ARISING FROM BREACH OF WARRANTY OR BASED ON CONTRACT, TORT, RELIANCE OR ANY OTHER THEORY.

Since some countries or states do not allow limitation of the term of an implied warranty, or exclusion or limitation of incidental or consequential damages, the limitations and exclusions of this warranty may not apply to every buyer. If any provision of this Warranty is held invalid or unenforceable by a court of competent jurisdiction, such holding will not affect the validity or enforceability of any other provision.

Fluke Corporation
P.O. Box 9090
Everett, WA
98206-9090
USA

Fluke Industrial B.V.
P.O. Box 90
7600 AB Almelo
The Netherlands

Service Centers

To locate an authorized service center, visit us on the World Wide Web:

<http://www.fluke.com>

or call Fluke using any of the phone numbers listed below:

+1-888-993-5853 in U.S.A. and Canada

+31-402-675-200 in Europe

+1-425-446-5500 from other countries

FLUKE®

DECLARATION OF CONFORMITY

for

**Fluke
TV Signal Generator
54200**

Manufacturer

Fluke Industrial B.V.
P.O. Box 90
7600 AB
Almelo
The Netherlands

Statement of Conformity

Based on test results using appropriate standards, the product is in conformity with
Electromagnetic Compatibility Directive 89/336/EEC
Low Voltage Directive 73/23/EEC

Sample tests

Standards used:

EN 55011 (1992)

Radio Frequency Product-Family Emission Standard

EN 50082-1 (1992)

Electromagnetic Compatibility; Generic Immunity Standard:

IEC 801-2 (1984), IEC 801-3 (1984), IEC 801-4 (1988)

EN61000-4-2 (1995), EN61000-4-8(1993), ENV50140(1993)

EN 61010-1 (1994)+ A2 (1995)

Safety Requirements for Electrical Equipment for Measurement Use

The tests have been performed in a typical configuration.

This Conformity is indicated by the symbol **CE**, i.e. "Conformité européenne".

Table of Contents

Chapter	Title	Page
1	Installation and Safety Instructions	1-1
	Shipment Note	1-5
	Initial Inspection.....	1-5
	Available built-in options Fluke 54200.....	1-5
	Introduction.....	1-9
	Safety Instructions.....	1-9
	Maintenance and Repair	1-9
	Grounding (Earthing)	1-9
	Power Cable, Line Voltage Range, and Fuses.....	1-10
	Operating Position of the Instrument	1-11
	Radio Interference Suppression	1-11
	Isolation Transformer	1-11
	Instrucciones de instalación y de seguridad.....	1-13
	Instrucciones de seguridad.....	1-13
	Mantenimiento y reparación	1-13
	Puesta a tierra.....	1-13
	Cable de conducción eléctrica, rango de tensiones de la línea y fusibles	1-14
	Posición de uso del instrumento	1-15
	Supresión de radiointerferencias	1-15
	Transformador de aislamiento.....	1-15
	Istruzioni di installazione e di sicurezza.....	1-17
	Istruzioni di sicurezza.....	1-17
	Manutenzione e riparazione.....	1-17
	Messa a terra	1-17
	Cavo elettrico, zona della tensione di rete et fusibili	1-18
	Posizione di uso dell'apparecchio	1-19
	Schermatura contro i radiodisturbi.....	1-20
	Trasformatore di separazione	1-20
	Opstellings- en veiligheidsinstructies.....	1-21
	Veiligheidsinstructies	1-21
	Onderhoud en reparatie	1-21

	Aarding.....	1-21
	Stroomkabel, netspanningsgebied en zekeringen	1-22
	Bedrijfsstand van het toestel	1-23
	Ontstoring radio-interferentie.....	1-24
	Scheidingstransformator	1-24
	Inledande anvisningar och säkerhetsanvisningar	1-25
	Säkerhetsanvisningar	1-25
	Underhåll och reparation	1-25
	Jordning	1-25
	Nätkabel, nätspanningsområde och säkringar.....	1-26
	Instrumentets driftsläge	1-27
	Radio-avstörning	1-27
	Skiljetransformator.....	1-27
2	Main Features.....	2-1
	Introduction.....	2-3
	Main Features.....	2-3
3	Getting Started.....	3-1
	Introduction.....	3-3
	Getting Started	3-3
	General Information	3-3
	Turning the Instrument on	3-3
	Self-test Routine.....	3-3
	Brief Checking Procedure.....	3-4
	Test Equipment:.....	3-4
	Instrument Settings and Checks.....	3-4
	Operation and Application.....	3-13
	Control Elements, Display and Connectors.....	3-13
	Front Panel	3-13
	Rear Panel.....	3-17
4	How to Use the Instrument.....	4-1
	Introduction.....	4-3
	Operating via Keyboard.....	4-3
	General Information	4-3
	Display	4-3
	Keyboard	4-6
	Instrument Settings	4-7
	TV Standard.....	4-7
	Video Settings.....	4-10
	Sound Settings.....	4-12
	Teletext, VPS, PDC, CC, and WSS.....	4-14
	Vision Carrier Frequency Settings (RF Carrier).....	4-15
	Vision Carrier Level Setting (RF Level).....	4-18
	Video Amplitude Setting.....	4-22
	Chroma Amplitude Setting.....	4-26
	Test Patterns	4-30
	Storing and Recalling of Settings	4-35
	Storing of Instrument Settings.....	4-35
	Recalling of Instrument Settings	4-37
	Digital Data and Text.....	4-39

Description and Applications of the Test Patterns	4-40
Circle	4-42
Center Cross with Border Castellations	4-43
Dots	4-45
Crosshatch	4-46
Checkerboard	4-47
White Pattern	4-48
Multiburst	4-48
Greyscale	4-49
DEM Pattern	4-49
DEM 1 (PAL)	4-49
DEM 1 (NTSC).....	4-51
DEM 1 (SECAM).....	4-52
DEM 2 (PAL).....	4-53
DEM 2 (NTSC).....	4-53
DEM 2 (SECAM).....	4-54
Purity	4-55
PLUGE	4-56
Color Bar	4-57
Full Field Color Bar.....	4-57
Split Field Color Bar.....	4-58
SMPTE Color Bar.....	4-59
Horizontal Color Bar.....	4-60
Color Temperature Adjustment	4-60
VCR Test	4-62
VCR 1	4-62
VCR 2	4-63
Standard Resolution Test	4-64
High Resolution Test	4-64
Writing Current Adjustment.....	4-64
Digital Scan Test.....	4-64
ADC Check 1.....	4-65
ADC Check 2.....	4-66
Moving Block.....	4-67
Progressive Scan Check 1	4-67
Progressive Scan Check 2	4-68
Progressive Scan Check 3	4-68
DIVERSE	4-69
EHT Test	4-69
IRS17	4-70
Combined Test Patterns.....	4-71
CIRCLE.....	4-71
Twofold Combinations of Patterns	4-71
Threefold Combinations of Patterns	4-73
Fourfold Combinations of Patterns.....	4-73
Insertion-Reference Signal (IRS).....	4-74
5 Function Reference	5-1
TELETEXT.....	5-3
General	5-3
UK-Teletext.....	5-3
TOP (Table of Pages).....	5-3
FLOF (Full Level-One Features) / FASTEXT	5-5
VPT (Video Recorder Programming by Teletext).....	5-5

Video Recorder Programming by Teletext with PSF	5-7
Contents of Teletext Pages TOP/FLOF	5-9
DIDON ANTIOPE Teletext	5-10
Contents of DIDON ANTIOPE Text Pages	5-10
Operating	5-12
Checking and Adjusting	5-13
Wide Screen Signalling (WSS).....	5-14
General	5-14
Operating	5-15
WSS Auto Mode.....	5-16
WSS Manual Mode.....	5-17
Status Bits Transmission Scheme for Wide Screen Signalling	5-18
Programming the Real Time Clock.....	5-20
PDC and VPS.....	5-22
General	5-22
PDC Description	5-22
Operating	5-23
VPS Description.....	5-26
Operating	5-27
Data Format of Programme Delivery Data in the TV Line 16	5-30
CLOSED CAPTION (CC)	5-32
General	5-32
Operating	5-34
Memory Contents	5-35
Analog Mono Sound	5-38
General	5-38
Operating	5-38
Analog Stereo/Dual Sound	5-39
General	5-39
Operating	5-40
NICAM Sound.....	5-42
The NICAM-728 Transmission Mode	5-42
Operating	5-44
Applications.....	5-46
Test functions	5-46
BTSC Sound	5-48
General	5-48
Definitions	5-50
Operating	5-50
Explanations of BTSC Test Modes	5-53
Applications.....	5-54
Recommendations.....	5-55
Sound Operating Modes	5-56
External Modulation.....	5-60
External Video Modulation	5-60
Operating	5-61
External Sound Modulation.....	5-61
Operating	5-63
Synchronization Outputs and Triggering	5-64
Operating Hints, Out of Range and Error Messages	5-65
Operating Hints.....	5-65
Out of Range Messages	5-65
Error Messages.....	5-66
Remote Control Specific Error Messages	5-66

6	Remote Control.....	6-1
	Introduction.....	6-3
	IEEE-488 Interface.....	6-3
	Instrument Address.....	6-3
	Interface Functions.....	6-6
	RS-232 Interface.....	6-7
	Instrument Configuration.....	6-7
	Interface Functions and Wiring.....	6-11
	Interface Functions.....	6-12
	Remote Control Commands.....	6-13
	Program Message Syntax.....	6-13
	Message Terminator.....	6-13
	Service Request (SRQ) and Status Registers.....	6-14
	54200 'Standard Event Status Register'.....	6-15
	Common Commands and Queries (IEEE-488.2).....	6-16
	System Data.....	6-16
	Internal Operations.....	6-17
	Synchronization.....	6-19
	Status and Event.....	6-20
	Save and Recall Instrument Settings.....	6-21
	Device Specific Messages.....	6-21
	Vision Carrier.....	6-22
	TV-System.....	6-23
	Video.....	6-25
	Sound.....	6-31
	Digital Services.....	6-35
	Miscellaneous commands.....	6-39
	Device Setting Queries.....	6-40
	Programming Examples.....	6-43
	Example for the IEEE-488 Interface.....	6-43
	Example for the RS-232 Interface.....	6-46
	Error Messages.....	6-50
	Conversion Table for the PM 5415/18 Command Set to 54200 Commands.....	6-51
7	Specifications.....	7-1
	Safety and EMC Requirements.....	7-3
	Performance Characteristics and Specifications.....	7-3
	Video and RF.....	7-4
	Outputs.....	7-4
	CVBS Video.....	7-4
	CVBS SYNC, LINE SYNC and FIELD Synchronization.....	7-4
	EURO AV Control Voltages.....	7-4
	Terrestrial RF Carrier.....	7-5
	Video Modulation.....	7-6
	Inputs.....	7-6
	Video IN.....	7-6
	Video.....	7-7
	Synchronization.....	7-7
	Luminance.....	7-7
	Chrominance.....	7-7
	Patterns.....	7-8
	Sound.....	7-10
	Outputs.....	7-10
	Sound Carrier.....	7-10

Audio and Euro AV	7-10
BTSC MPX and FM Stereo Pilot	7-10
NICAM Data and NICAM Clock	7-11
Inputs	7-11
Audio, Euro AV and MTS Multiplex	7-11
Mono	7-11
Sound Carrier.....	7-11
Modulation	7-12
Stereo /Dual	7-12
Sound Carrier 1	7-12
Sound Carrier 2.....	7-12
Modulation	7-13
Identification/Subcarrier.....	7-13
NICAM Stereo.....	7-13
Sound Carrier 1	7-13
Sound Carrier 2.....	7-14
Modulation	7-14
BTSC Stereo.....	7-14
Sound Carrier.....	7-14
Modulation	7-15
Identification.....	7-15
Digital Services	7-16
Wide Screen Signalling (WSS).....	7-16
Teletext DIDON ANTIOPE (CCIR System A).....	7-16
Teletext UK (CCIR System B).....	7-17
PDC	7-17
VPS	7-17
Closed Caption.....	7-18
RGB, YC (S-VHS/Hi-8), YCrCb Outputs	7-19
RGB Outputs	7-19
YC Outputs.....	7-19
YCrCb Outputs	7-19
Feedthrough Connection	7-20
IEEE-488 and RS-232 Interface.....	7-20
IEEE-488 Interface.....	7-20
RS-232 Interface	7-20
General Specifications	7-21
Environmental Conditions.....	7-21
Power Requirements	7-22
Dimensions and Weight	7-22
Accessories	7-23
Standard.....	7-23
Optional.....	7-24
8	
Brief Functional Test	8-1
Brief Functional Test.....	8-3
Introduction.....	8-3
Recommended Test Equipment.....	8-3
Self-Test Routine	8-4
Function Verification.....	8-5
TV Standard PAL.....	8-5
Video Part, using RF Connection	8-5
Video Part, using Y/C Connection (S-VHS, Hi-8).....	8-7
Sound Part	8-8

Teletext, VPS, PDC, and WSS (Digital Services).....	8-12
Wide Screen Signalling Bits (WSS)	8-14
TV Standard NTSC.....	8-15
Video Part, using RF Connection	8-15
Video Part, using Y/C Connection (S-VHS, Hi-8).....	8-17
Sound Part	8-18
Closed Caption (Digital Service CC).....	8-21
TV Standard SECAM.....	8-23
Video Part, using RF Connection	8-23
Video Part, using Y/C Connection (S-VHS, Hi-8).....	8-25
Sound Part	8-26
Teletext, VPS, PDC, and WSS (Digital Services).....	8-29

Appendices

A	TV Systems Used in Various Countries	A-1
B	VHF/UHF-Channel Frequencies for Different TV Systems	B-1
C	Default Settings for Countries	C-1
D	Spectras of TV Audio Systems.....	D-1
E	Nomenclature of Color Bar Signals.....	E-1
F	Menu Trees.....	F-1
G	Pattern Popup Menus	G-1

Index

List of Tables

Table	Title	Page
1-1.	Display Indication of built-in Options.....	1-8
1-2.	Delivered Power Cable	1-10
1-3.	Cable suministrado	1-14
1-4.	Cavo di alimentazione fornito in dotazione.....	1-18
1-5.	Meegelverde netkabel	1-22
1-6.	Medleverera nätkabel.....	1-26
3-1.	EURO AV IN.....	3-19
3-2.	EURO AV OUT	3-19
3-3.	Y/C OUT.....	3-19
4-1.	Circle	4-42
4-2.	Center Cross.....	4-44
4-3.	Dots.....	4-45
4-4.	Crosshatch.....	4-47
4-5.	PLUGE	4-56
4-6.	Full Field Color Bar	4-57
4-7.	Color Temperature Adjustment.....	4-60
4-7.	Color Temperature Adjustment.....	4-61
4-8.	VCR 1	4-62
5-1.	TOP Teletext Remote Control	5-4
5-2.	PDC/VPT Teletext Page 300, Transport Method A.....	5-6
5-3.	PDC/VPT Teletext Page 300, Transport Method B	5-7
5-4.	DIDON ANTIOPE Text Pages	5-10
5-5.	Teletext Systems and Modes.....	5-12
5-6.	WSS Auto Mode	5-16
5-7.	WSS Status Bits Transmission Scheme	5-18
5-8.	VPS Information	5-26
5-9.	Data Format of Programme Delivery Data in the TV Line 16	5-30
5-9.	Data Format of Programme Delivery Data in the TV Line 16 (cont)	5-31
5-10.	Closed Caption Field Packets	5-33
5-11.	Analog Stereo/Dual Audio Signals, Systems B/G and D/K.....	5-39
5-12.	Analog Stereo/Dual Audio Signals, System Mk (Korean Stereo)	5-40
5-13.	54200 Analog Stereo/Dual Sound Systems	5-40
5-14.	NICAM-728 Transmission, 54200 NICAM Systems	5-42
5-15.	BTSC Sound Carrier Modulation Standards.....	5-49
5-16.	54200 BTSC Sound Systems.....	5-50

5-17.	Sound Operating Modes	5-56
5-18.	Sound Operating Modes (cont)	5-57
5-18.	Sound Operating Modes (cont)	5-58
5-18.	Sound Operating Modes (cont)	5-59
5-18.	External Video Modulation Modes	5-60
5-19.	External Sound Mode	5-62
6-1.	Fluke 54200 'Status Byte Register'	6-14
6-2.	Instrument Default Settings after Reset (*RST)	6-17
6-3.	Telephone Country Code	6-23
6-4.	Conversion Table	6-51

Chapter 1

Installation and Safety Instructions

Title	Page
Shipment Note	1-5
Initial Inspection.....	1-5
Available built-in options Fluke 54200.....	1-5
Introduction.....	1-9
Safety Instructions.....	1-9
Maintenance and Repair	1-9
Grounding (Earthing)	1-9
Power Cable, Line Voltage Range and Fuses.....	1-10
Operating Position of the Instrument	1-11
Radio Interference Suppression	1-11
Isolation Transformer	1-11
Instrucciones de instalación y de seguridad.....	1-13
Instrucciones de seguridad.....	1-13
Mantenimiento y reparación	1-13
Puesta a tierra.....	1-13
Cable de conducción eléctrica, rango de tensiones de la línea y fusibles	1-14
Posición de uso del instrumento	1-15
Supresión de radiointerferencias	1-15
Transformador de aislamiento.....	1-15
Istruzioni di installazione e di sicurezza.....	1-17
Istruzioni di sicurezza.....	1-17
Manutenzione e riparazione.....	1-17
Messa a terra	1-17
Cavo elettrico, zona della tensione di rete et fusibili	1-18
Posizione di uso dell'apparecchio	1-19
Schermatura contro i radiodisturbi.....	1-20
Trasformatore di separazione.....	1-20

Opstellings- en veiligheidsinstructies	1-21
Veiligheidsinstructies.....	1-21
Onderhoud en reparatie.....	1-21
Aarding	1-21
Stroomkabel, netspanningsgebied en zekeringen.....	1-22
Bedrijfsstand van het toestel	1-23
Otnstoring radio-interferentie.....	1-24
Scheidingstransformator	1-24
Inledande anvisningar och säkerhetsanvisningar.....	1-25
Säkerhetsanvisningar	1-25
Underhåll och reparation.....	1-25
Jordning	1-25
Nätkabel, nätspänningsområde och säkringar	1-26
Instrumentets driftsläge.....	1-27
Radio-avstörning	1-27
Skiljetransformator	1-27

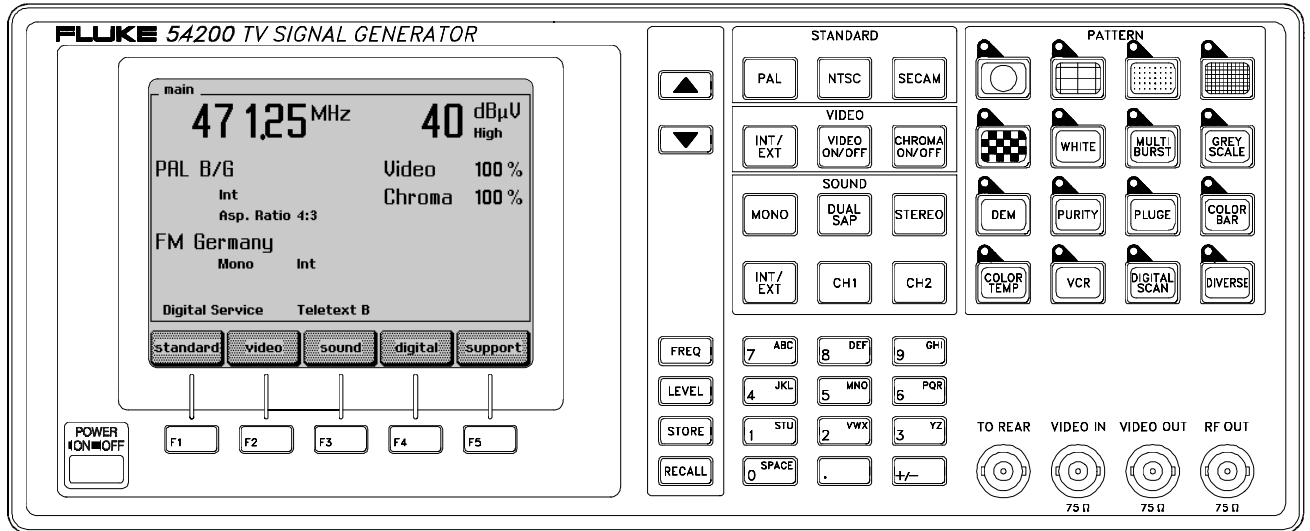

Figure 1-1. Front Panel

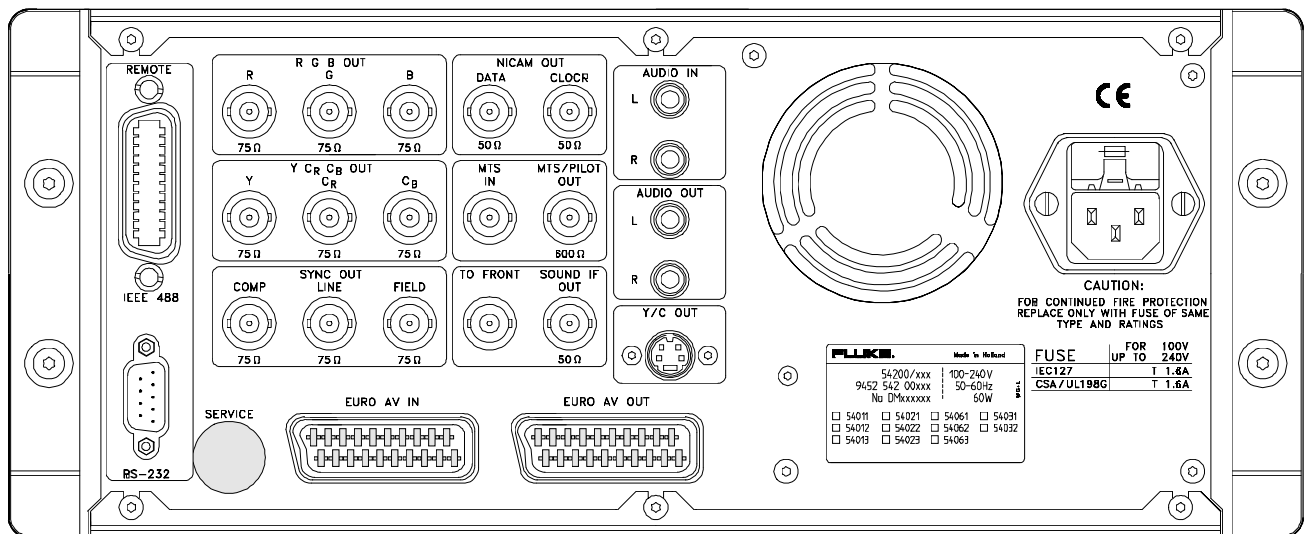

Figure 1-2. Rear Panel

Shipment Note

The following parts should be included in the shipment:

- 1 TV Signal Generator 54200
- 1 Users Manual (standard)
- 1 Power Cable (standard)

- 1 RF Cable BNC – IEC 169-2 male connector
- 1 IEC 162-2 male - F-male adapter
- 1 SCART - SCART cable
- 1 SCART – 3 x Cinch cable
- 1 Y/C cable (only with RGB option)

Initial Inspection

Check that the shipment is complete and note whether any damage has occurred during transport. If the contents are incomplete or there is damage, file a claim with the carrier immediately, and notify the Fluke Sales and Service organization to facilitate the repair or replacement of the instrument.

The functions of the instrument can be checked by using the Brief Functional Test in Chapter 8 of this manual.

Available built-in options Fluke 54200

In addition the instruments shows the built-in options in a submenu on the display. You can select this submenu via softkeys when the **main** screen is displayed.

If the display shows a different screen, press the **enter** softkey (F5) so often until the main screen appears or switch the instrument off, wait five seconds, and switch it on again.

The built-in options are marked on the type plate on the rear of the instrument.

FLUKE.		Made in Holland					
	54200/xxx	100-240 V		1-5 B			
	9452 542 00xxx	50-60Hz					
	No DMxxxxxx	60W					
<input type="checkbox"/>	54011	<input type="checkbox"/>	54021	<input type="checkbox"/>	54061	<input type="checkbox"/>	54031
<input type="checkbox"/>	54012	<input type="checkbox"/>	54022	<input type="checkbox"/>	54062	<input type="checkbox"/>	54032
<input type="checkbox"/>	54013	<input type="checkbox"/>	54023	<input type="checkbox"/>	54063		

The instrument shows the **main** screen with the current settings:

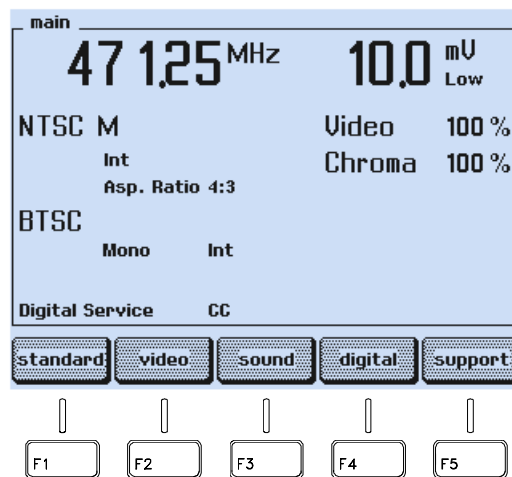

Figure 1-3. Main Screen

- Press the **support** softkey (F5).
- The display shows the **support** submenu.

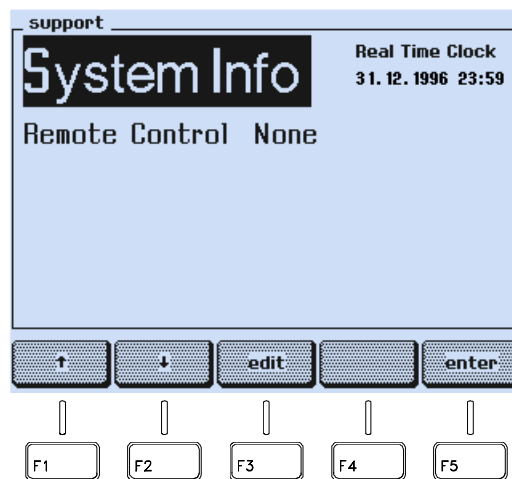

Figure 1-4. Support Submenu

- Press the **edit** softkey (F3).
- The display shows the **support system info** screen.

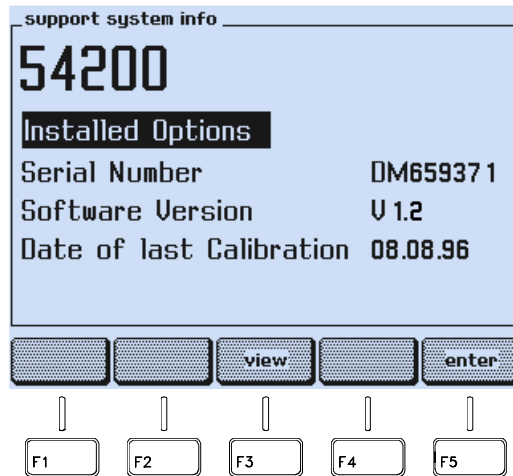

Figure 1-5. Support System Info Submenu

- Press the **view** softkey (F3).
- A popup menu appears, showing the options.

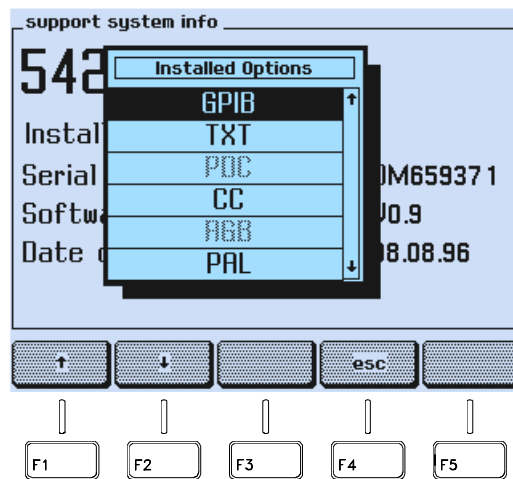

Figure 1-6. Popup Menu showing installed Options

- Use the **↑** or the **↓** softkey (F1 or F2) to scroll through the table.

Installed option are displayed in **black letters**, **not installed** options are display **in grey letters**.

The meanings of the shortcuts are the following:

Table 1-1. Display Indication of built-in Options

54200 Display Indication	Description	Options Type numbers
PAL	PAL Standard	54011
NTSC	NTSC Standard	54012
SECAM	SECAM Standard	54013
TXT	Teletext and Widescreen Signalling Bits	54021
PDC	PDC / VPS (only in combination with option 54021)	54022
CC	Closed Caption	54023
RGB	RGB + YCrCb + YC	54031
GPIB	IEEE / RS-232 Interface	54032
STEREO	Mono Sound + Analog Stereo	54061
NICAM	Mono Sound + NICAM Sound	54062
BTSC	Mono Sound + BTSC Sound	54063

- Press the **esc** softkey (F4) to return to the **support system info** submenu.
- Press the **enter** softkey (F5) to return to the **support** submenu.
- Press the **enter** softkey (F5) again to return to the **main** screen.

If you want additional options that are not built-in in your instrument at the moment, please contact you local Fluke Sales Organization.

Introduction

This chapter should be read before unpacking, installing, and operating the instrument. It describes grounding, power cables, and fuses.

It also contains the Installation and Safety Instructions in the following languages: Spanish, Italian, Dutch and Swedish.

Safety Instructions

Upon delivery from the factory the instrument complies with the required safety regulations, see Chapter 7. To maintain this condition and to ensure safe operation, carefully follow the instructions below.

Maintenance and Repair

Failure and excessive stress:

If the instrument is suspected of being unsafe, remove it from operation immediately and secure it against any unintended operation. The instrument is considered to be unsafe when any of the following conditions exist:

- It shows physical damage.
- It does not function.
- It is stressed beyond the tolerable limits (e.g., during storage and transportation).

Disassembling the Instrument:

Warning

Calibration, maintenance, and repair of the instrument must be performed only by trained personnel who are aware of the hazards involved. To avoid electric shock, do not remove the cover unless you are qualified to do so.

Before removing the cover, disconnect the instrument from all power sources. The capacitors in the instrument may remain charged for several seconds after all power has been disconnected.

Grounding (Earthing)

Before any other connection is made, the instrument shall be connected to a protective earth conductor using the three-wire power cable.

The power plug shall be inserted only into a grounded outlet. Do not defeat the protective action by using of an extension cord without a grounded conductor.

Warning

Any interruption of the protective ground conductor inside or outside the instrument or disconnection of the protective ground terminal will make the instrument dangerous. Do not intentionally interrupt the protective ground conductor.

The circuit ground potential is applied to the external contacts of the BNC connectors and is connected to the instrument case. The external contacts of the BNC connectors must not be used to connect a protective conductor.

Power Cable, Line Voltage Range, and Fuses

Different power cables are available for the local line connectors. On delivery from the factory the instrument is supplied with the ordered power cable:

Table 1-2. Delivered Power Cable

Type No.	Delivered Power Cable
54200/XX1	Universal Europe
54200/XX3	North America
54200/XX4	England (UK)
54200/XX5	Switzerland
54200/XX8	Australia

Before plugging in the power cable, make sure that the instrument is suitable for the correct line voltage.

Note

When the mains plug has to be adapted to the local situation, such adaptation should be done by a qualified technician only.

The instrument has a switched-mode mains power supply that covers most nominal voltage ranges in use: ac voltages from 100 to 240 V (r.m.s.). This obviates the need to adapt to the local line voltage. The nominal line frequency is 50 to 60 Hz.



Warning

The instrument shall be disconnected from all voltage sources when a fuse is to be renewed.

The fuses are located in a fuse holder of the input power module at the rear panel. When the line fuses need replacing, proceed as follows:

- disconnect the power cable from the power module.
- press the clip of the fuseholder and pull out the holder, see illustration.
- fit new fuses of the correct rating (according to IEC127 T1.6A or CSA/UL 198G T1.6A) and refit the fuseholder.



Warning

To avoid fire hazards, make sure the instrument fuses are of the type and current rating specified. Do not use repaired fuses and/or short-circuited fuseholders. Do not defeat this important safety feature.

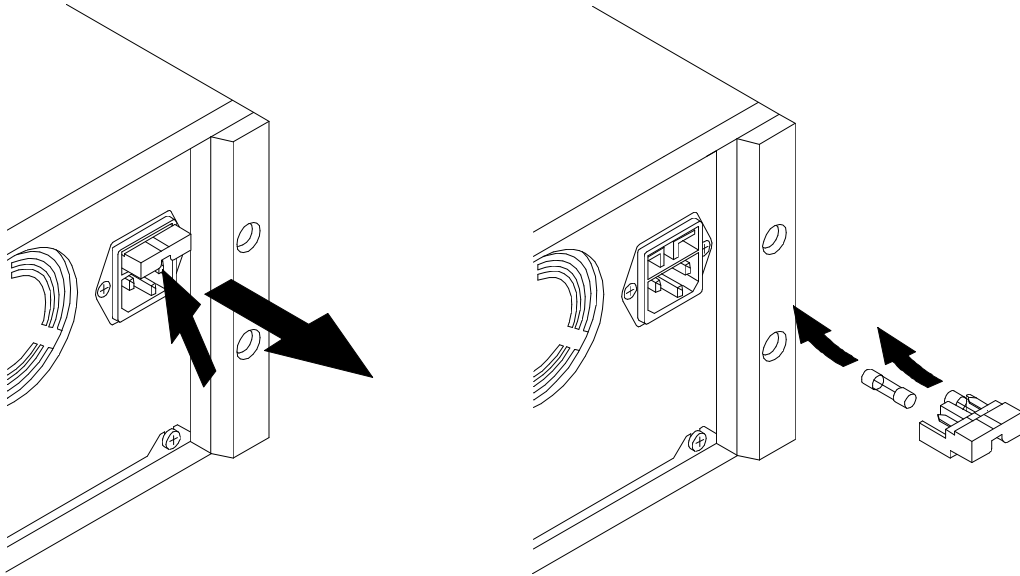

Operating Position of the Instrument

The instrument can be operated on a horizontal surface in a flat position or in a sloping position with the tilting feet folded down. Ensure that the ventilation holes are free of obstruction. Do not position the instrument in direct sunlight or on any surface that produces or radiates heat.

Radio Interference Suppression

Radio interference of the instrument is suppressed and checked carefully. If radio frequency interferences occur in connection with other poorly suppressed instruments, further suppression actions may be required.

Isolation Transformer

Because most MTV and CTV receivers are constructed with the chassis potentially 'live', it is sensible precaution to power the receiver under test using a suitable isolating transformer.

This permits direct connection of the television chassis to the earth terminals of any test instrument thus providing a common signal path and reducing the risk of electric shock.

Instrucciones de instalación y de seguridad

Instrucciones de seguridad

El aparato sale de fábrica, técnicamente, en perfectas condiciones de seguridad (ver cap. 7). Para que se conserven estas condiciones, y para evitar riesgos en el uso, hay que seguir cuidadosamente las indicaciones siguientes.

Mantenimiento y reparación

Defectos y esfuerzos extraordinarios:

Si se piensa que el aparato ya no puede funcionar sin riesgo, hay que apagarlo y asegurarse de que no se ponga en funcionamiento inadvertidamente. Este es el caso:

- cuando el aparato presenta daños visibles,
- cuando el aparato no funciona,
- luego de haber sido sometido a esfuerzos excesivos de cualquier tipo (p.e. en el almacenaje o el transporte) que sobrepasan los límites permitidos.

Abrir el aparato:



Al abrir algunas tapas o al desmontar piezas con herramientas pueden quedar al descubierto partes bajo tensión eléctrica. También puede haber tensión en los puntos de conexión. Antes de abrir el aparato hay que desconectarlo de todas las fuentes de alimentación.

Si es inevitable realizar un calibrado, mantenimiento o reparación con el aparato abierto que se encuentra bajo tensión, sólo debe hacerlo un técnico cualificado que conozca los riesgos que existen. Los condensadores del aparato pueden seguir estando cargados aún cuando esté haya sido desconectado de todas las fuentes de alimentación.

Puesta a tierra

Antes de hacer alguna conexión hay que conectar el aparato a un contactor protección mediante el cable de alimentación de tres conductores.

El enchufe de la red debe ser insertado sólo en tomacorrientes con contacto de seguridad de tierra.

No se deben anular estas medidas de seguridad, p.e. usando un cable de extensión sin contactor de protección.



Toda interrupción del contactor de protección dentro o fuera del aparato, o la separación de la conexión de la puesta protectora peligrosa. Se prohíbe hacer la interrupción expresamente.

Los contactos exteriores de los casquillos BNC tienen el potencial del neutro y están conectados a la carcasa. La puesta a tierra a través de los contactos exteriores de los casquillos BNC es inadecuada.

Cable de conducción eléctrica, rango de tensiones de la línea y fusibles

Existen diferentes cables de conducción eléctrica para los terminales de la conexión a la red. El instrumento se suministra desde fábrica con el cable de conducción eléctrica pedido.

Table 1-3. Cable suministrado

Tipo de aparato	Cable suministrado
54200/XX1	Europa
54200/XX3	Norteamérica
54200/XX4	Inglaterra (U.K.)
54200/XX5	Suiza
54200/XX8	Australia

Antes de enchufar el cable de conducción eléctrica asegurarse que el instrumento esté ajustado a la tensión correcta de la red.

Nota

Para evitar daños o peligros de muerte, toda modificación en los cables de conducción eléctrica para adaptarlos a la corriente local deberá ejecutarse por personal cualificado que tiene conocimientos suficientes de los peligros existentes.

El instrumento tiene una conexión a la red conmutable que abarca los rangos de voltajes nominales más usuales: tensiones alternas desde desde 100 hasta 240 (valor efectivo). Con esto ya no es necesario adaptar la tensión de la red local. La frecuencia nominal de la red es de 50 a 60 Hz.

Advertencia

Cuando se vaya a cambiar un fusible se ha de desconectar el instrumento de toda fuente de voltaje.

Los fusibles están colocados en el portafusibles del módulo de potencia de entrada del panel posterior. Para cambiar los fusibles del circuito proceder del siguiente modo:

- desconectar el cable de corriente del módulo de potencia,
- presionar la sujeción de apriete del portafusibles y sacar el portafusibles, ver la figura,
- colocar los nuevos fusibles con la potencia correcta (conforme a IEC127 T1,6A o CSA/UL 198G T1,6A) y montar otra vez el portafusibles.

Advertencia

Asegúrese que el nuevo fusible sea del tipo y de la potencia especificada. El uso de fusibles reparados y/o el cortocircuito de portafusibles está prohibido. No pase por alto esta indicación de seguridad importante.

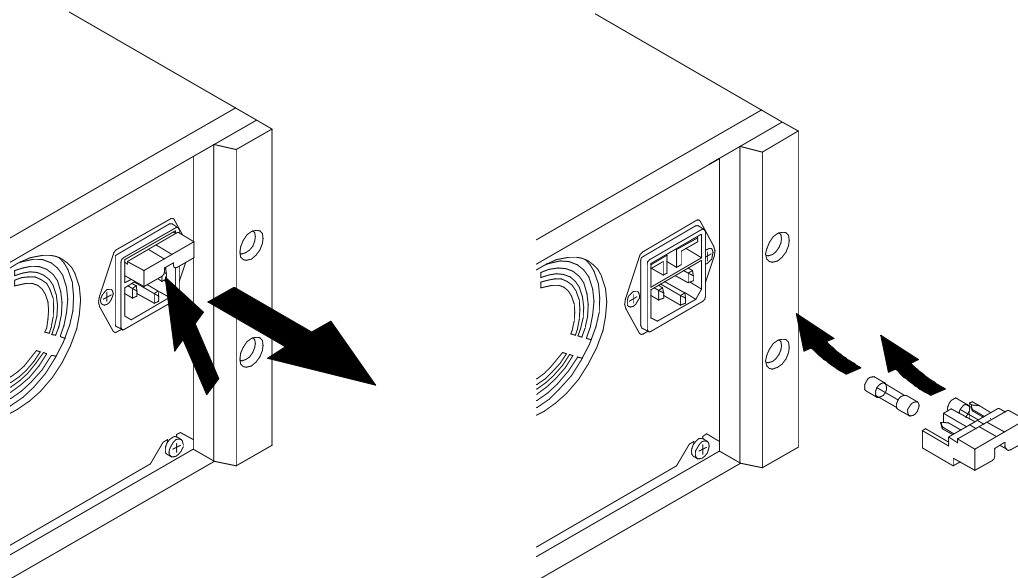

Posición de uso del instrumento

El instrumento se puede usar sobre una superficie plana en posición horizontal o inclinada con el pie inclinable plegado hacia abajo. Si se cierra las patas de soporte el aparato puede utilizarse en posición inclinada. Los datos técnicos del capítulo 7 se refieren a las posiciones indicadas. El aparato no se debe colocar nunca sobre una superficie que produzca o irradie calor ni exponerlo a los rayos directos del sol.

Supresión de radiointerferencias

En el aparato se han suprimido cuidadosamente todas las interferencias, habiéndose sometido éste también a prueba. Al conectarlo a unidades básicas y a otras unidades periféricas cuyas interferencias no se han suprimido correctamente, pueden generarse interferencias que en algunos casos exigirán medidas adicionales para suprimirlas.

Transformador de aislamiento

Debido a que el chasis de muchos televisores se encuentra bajo tensión, por motivos de seguridad es necesario utilizar el receptor a probar a través de un transformador de seccionamiento adecuado. Esto permite establecer un acoplamiento directo del chasis de los televisores con la conexión al contactor de protección de algún aparato de prueba, con lo que se reduce el riesgo de una descarga eléctrica.

Istruzioni di installazione e di sicurezza

Istruzioni di sicurezza

L'apparecchio viene fornito dalla fabbrica perfettamente sicuro e funzionante dal punto di vista tecnico (vedi Cap. 7). Per preservarlo in condizioni ottimali e garantirne un corretto funzionamento, attenersi scrupolosamente alle seguenti istruzioni.

Manutenzione e riparazione

Funzionamento anomalo a sollecitazioni eccessive:

Qualora il funzionamento non risultasse regolare, spegnere subito l'apparecchio e prevenirne ogni accensione accidentale. Le precauzioni di cui sopra vanno adottate nei seguenti casi:

- se l'apparecchio mostra dei danni visibili,
- se l'apparecchio non funziona più,
- se l'apparecchio è stato sottoposto a sollecitazioni (ad esempio durante il magazzinaggio, il trasporto, ecc.) oltre i limiti di tolleranza ammessi.

Apertura dell'apparecchio:



Avvertimento

Se i coperchi o alcune parti dell'apparecchio vengono rimossi con appositi attrezzi, può darsi che risultino esposti dei componenti interni sotto tensione. Anche i punti di connessione possono essere sotto tensione. Prima di aprire l'apparecchio occorre quindi disinnestarlo dalle relative prese di corrente.

Se fosse necessario eseguire interventi di calibrazione, manutenzione o riparazione con l'apparecchio aperto e sotto tensione, rivolgersi a personale specializzato che conosca bene i probabili rischi nelle procedure da adottare. Potrebbe darsi che i condensatori dentro all'apparecchio siano ancora carichi anche se l'apparecchio è stato disinnestato dalle relative prese di corrente.

Messa a terra

Prima di eseguire un qualsiasi collegamento, mediante il cavo di alimentazione tripolare l'apparecchio deve essere allacciato ad un conduttore di protezione.

La spina del cavo di alimentazione deve essere inserita soltanto in una presa munita di contatto di messa a terra.

Questa norma resta comunque valida, anche se si utilizza un cavo di prolunga senza conduttore di protezione.

 **Avvertimento**

E' estremamente pericoloso interrompere il conduttore di protezione interno o esterno all'apparecchio o i contatti di messa a terra. Evitare quindi di farlo intenzionalmente.

I contatti esterni delle prese BNC trasferiscono il potenziale del punto neutro del circuito e sono collegate all'incvolucro dell'apparecchio. E' vietata la messa a terra di sicurezza tramite i contatti esterni delle prese BNC.

Cavo elettrico, zona della tensione di rete et fusibili

Per i morsetti di allacciamento alla rete locale esistono differenti tipi di cavi. Se la fornitura avviene dalla fabbrica, l'apparecchio viene già fornito con il cavo elettrico ordinato.

Table 1-4. Cavo di alimentazione fornito in dotazione

Tipo de apparecchio	Cavo di alimentazione fornito in dotazione
54200/XX1	Europa
54200/XX3	Nord America
54200/XX4	Inghilterra (U.K.)
54200/XX5	Svizzera
54200/XX8	Australia

Prima di inserire il cavo elettrico, assicuratevi che l'apparecchio sia adatto alla tensione corretta della rete.

Indicazione

Onde evitare il pericolo di ferimenti o di morte, la modifica al cavo elettrico per l'adattamento del cavo alla corrente locale deve essere eseguita solamente da personale del Service qualificato, poichè questo conosce esattamente gli eventuali pericolo.

L'apparecchio è dotato di un allacciamento alla rete commutabile che comprende le zone della tensione di rete più usuali: tensioni alternate da 100 a 240 V (valore effettivo). Per questo motivo, non è necessario adattare la tensione della rete locale. La frequenza di rete nominale è da 50 a 60 Hz.

 **Avvertimento**

Quando si sostituisce un fusibile, l'apparecchio deve essere disinserito da ogni fonte di energia.

I fusibili si trovano nel portafusibili sul quadro posteriore del modulo della potenza di entrata. Per sostituire i fusibili del circuito, procedere come segue:

- staccare il cordone di alimentazione dal modulo di potenza;
- premere il serraggio a morsetto del portafusibili ed estrarre il portafusibili, vedi figura;
- inserire nuovi fusibili badando che la potenza sia giusta (conformi a IEC127 T1,6A oppure CSA/UL 198G T1,6A), e rimontare il portafusibili.

 **Avvertimento**

Assicuratevi che i nuovi fusibili siano del tipo e della potenza specificata. È vietato l'uso di fusibili riparati e/o il cortocircuitare del portafusibili. Rispettate queste importanti misure di sicurezza.

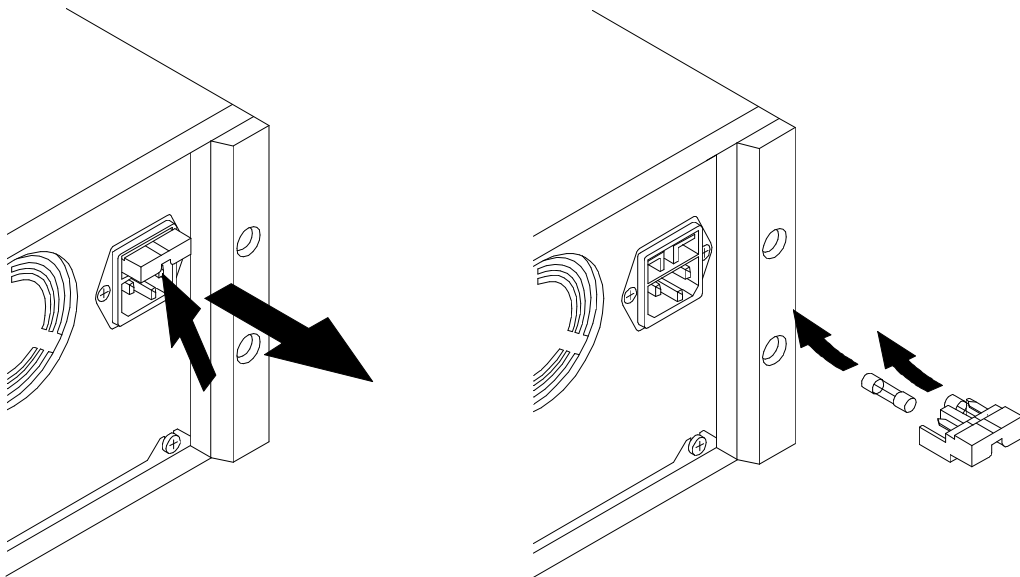

Posizione di uso dell'apparecchio

L'apparecchio può essere usato su una superficie orizzontale ed in posizione piana o in posizione inclinata con il piede ribaltabile abbassato. Abbassando il piede di supporto, si può utilizzare l'apparecchio in posizione inclinata. I dati tecnici riportati nel Capitolo 7 valgono per le posizioni indicate. L'apparecchio non deve essere mai collocato su una superficie surriscaldabile o che produca irradiazioni, né essere esposto ai raggi diretti del sole.

Schermatura contro i radiodisturbi

L'apparecchio è stato realizzato per garantire un funzionamento esente da interferenze. Se viene utilizzato congiuntamente a unità base e unità periferiche non dotate delle stesse protezioni, ne possono derivare interferenze che richiederanno ulteriori interventi.

Trasformatore di separazione

Poiché il chassis di molti televisori è sottotensione, per motivi di sicurezza è necessario utilizzare il ricevitore da testare tramite un trasformatore di separazione adatto. Ciò permette di stabilire un collegamento diretto del chassis del televisore con la connessione di conduttore di protezione di un apparecchio di prova, in modo che venga ridotto il rischio di una scossa elettrica.

Opstellings- en veiligheidsinstructies

Veiligheidsinstructies

Het apparaat heeft de fabriek in een onberispelijke veiligheidstechnische toestand verlaten (zie hoofdstuk 7). Voor het behoud van deze toestand en het risicoloze gebruik dienen de onderstaande instructies nauwkeurig te worden opgevolgd.

Onderhoud en reparatie

Storingen en uitzonderlijke omstandigheden

Wanneer verondersteld moet worden dat een risicoloos gebruik niet meer mogelijk is, dient het apparaat buiten gebruik gesteld en tegen een ongewenst gebruik beveiligd te worden. Deze situatie doet zich voor

- wanneer het apparaat zichtbare beschadigingen vertoont,
- wanneer het apparaat niet meer functioneert,
- na blootstelling aan excessieve omstandigheden van welke aard dan ook (bij voorbeeld bij opslag, transport) die de toelaatbare grenzen overschrijden.

Openen van het apparaat:

Waarschuwing

Bij het openen van afdekkingen of bij het met behulp van gereedschap verwijderen van onderdelen, kan het risico van contact met spanningvoerende delen ontstaan. Ook kan er spanning op aansluitpunten aanwezig zijn. Het apparaat mag pas geopend worden nadat het van alle spanningsbronnen losgenomen is.

Wanneer ijk-, onderhouds- of herstelwerkzaamheden aan een open en onder spanning staand apparaat onvermijdelijk zijn, mogen deze slechts worden uitgevoerd door een vakman die weet met welke gevaren dit gepaard gaat. In het apparaat aanwezige condensators kunnen nog geladen zijn, ook wanneer het apparaat van alle spanningsbronnen is losgenomen.

Aarding

Alvorens men een verbinding tot stand brengt, dient men het apparaat met behulp van een drieadrige kabel met een veiligheidsaarddraad te verbinden. De netstekker mag slechts op een stopcontact met randaarde worden aangesloten. Deze veiligheidsmaatregel mag niet onwerkzaam gemaakt worden, bij voorbeeld door het gebruik van een verlengsnoer dat niet van een veiligheidsaarddraad voorzien is.

 **Waarschuwing**

Elke onderbreking van de beschermende aardleiding, hetzij binnen of buiten het apparaat, of de scheiding ten opzichte van de aardleiding zijn gevaarlijk. Een opzettelijke onderbreking is verboden.

Op de externe contacten van de BNC-bussen is het schakelnulpunt-potentiaal aanwezig. Deze contacten zijn met het huis verbonden. Een veiligheidsaarding via de externe contacten van de BNC-bussen is niet toegestaan.

Stroomkabel, netspanningsgebied en zekeringen

Voor reeds aanwezige net-aansluitklemmen zijn verschillende stroomkabels beschikbaar. In geval van levering af fabriek wordt het toestel afgeleverd met de door de klant bestelde stroomkabel.

Table 1-5. Meegelerde netkabel

Type apparaat	Meegelerde netkabel
54200/XX1	Europa
54200/XX3	Noord-America
54200/XX4	Engeland (U.K.)
54200/XX5	Zwitserland
54200/XX8	Australië

Alvorens de stroomkabel in te pluggen, dient u te controleren, of het toestel voor de gebruikte netspanning geschikt is.

Opmerking

Ter vermindering van letsel en dodelijke ongevallen mogen adapties aan de stroomkabel ter aanpassing aan het plaatselijk stroomnet alleen door gekwalificeerd service-personeel worden uitgevoerd, dat volledig op de hoogte is van de hieraan verbonden gevaren.

Het toestel heeft een geschakelde netvoeding, die de meest gangbare netspanningen afdekt: d.w.z. wisselspanningen van 100 tot 240 V (effectieve waarde). Hierdoor is aanpassing van de plaatselijke netspanning overbodig. De nominale netfrequentie bedraagt 50 tot 60 Hz.

Waarschuwing

Wanneer een zekering vervangen moet worden, dient het toestel van alle spanningsbronnen te worden losgekoppeld.

De zekeringen zitten in de zekeringshouder op het achterpaneel van het ingangsstroommoduul. Bij het vervangen van de kabelzekeringen als volgt te werk gaan:

- stroomkabel van vermogensmoduul loskoppelen,
- klembevestiging van de zekeringshouder indrukken en de houder uitnemen, zie afbeelding,
- nieuwe zekeringen met juiste sterkte (overeenkomstig IEC127 T1,6A o CSA/UL 198G T1,6A) plaatsen en de zekeringshouder weer monteren.

Waarschuwing

U dient ervoor te zorgen, dat de gebruikte reserve-zekeringen van het voorgeschreven type zijn en berekend op de voorgeschreven stroomsterkte. Het gebruik van gerepareerde zekeringen en/of kortsluiten van smeltpatronen is verboden. Verontachtzaam deze belangrijke veiligheidsinstructie in geen geval!

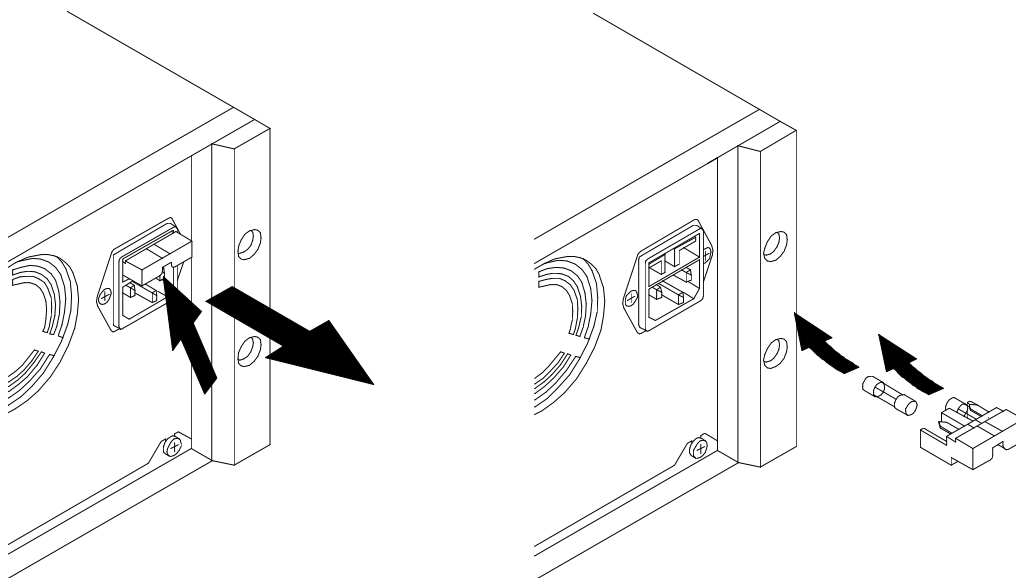

Bedrijfsstand van het toestel

Het toestel kan op een horizontaal oppervlak in platte of schuine stand met neergeklapte voet worden gebruikt. Wanneer de klapvoeten naar beneden geklapt zijn, kan het apparaat in een schuingeplaatste positie gebruikt worden. De technische specificatie in hoofdstuk 7 is van toepassing op de gespecificeerde gebruikspozities. Het apparaat nooit installeren op een oppervlak dat warmte genereert of uitstraalt, en het evenmin aan rechtstreekse zonnestraling blootstellen.

Ontstoring radio-interferentie

Wat radio-ontstoring betreft is het apparaat zorgvuldig ontstoord en gecontroleerd. Bij het schakelen in combinatie met basisunits die niet correct onstoord zijn en met andere perifere apparatuur, kan radiostoring optreden. In de desbetreffende gevallen maakt dit aanvullende maatregelen op radio-ontstoringsgebied noodzakelijk.

Scheidingstransformator

Omdat het chassis van vele TV-apparaten direct aan een kant van de netspanning aangesloten is, is het noodzakelijk bij metingen een scheidingstransformator te gebruiken. Dit moet uit het oogpunt van veiligheid. Deze transformator is aan te sluiten tussen de netvoeding en het TV-toestel, en maakt het mogelijk het TV-chassis te aarden, en met de aarde van een meetapparaat te verbinden, om ook daarmee een gevaarlijke situatie te verhinderen.

Inledande anvisningar och säkerhetsanvisningar

Säkerhetsanvisningar

Instrumentet har lämnat tillverkningen när det innehållsmässigt var i ett säkerhetstekniskt gott skick (Se kap. 7). För att bibehålla detta skick och en riskfri drift måste man följa nedanstående anvisningar noggrant.

Underhåll och reparation

Fel och ovanliga förhållanden:

När det ser ut som om säkerhetsskyddet blivit nedsatt måste instrumentet sättas ur funktion och säkerställas mot varje oavsiktlig handling. Detta uppstår när:

- instrumentet visar en synlig skada,
- instrumentet inte längre fungerar,
- efter olika slags exceptionella förhållanden (under t.ex. lagring och transport) som överskridit tillåtna gränser.

Instrumentets öppnande:



Varning

Vid öppnandet av instrumentet eller avlägsnande av delar med verktyg kan strömförande delar friläggas och kopplingsbitar kan vara strömförande. Före öppnandet måste instrumentet avskiljas från alla strömkällor.

När kalibrering, underhåll eller reparation på ett öppnat instrument som är strömförande inte går att undvika får det bara utföras av kvalificerad personal som känner till faror och säkerhetsåtgärder. Instrumentets kondensatorer kan vara strömförande t.o.m. när instrumentet lösgjorts från alla strömkällor.

Jordning

Innan du gjort någon koppling med de ingående förbindelserna, skall instrumentet förbindas med en skyddande jordning genom den trekärniga huvudkabeln; huvudstickkontakten får bara stickas in i en koppling som är försedd med en skyddande jordning. Denna åtgärd får inte upphävas genom användning av en kopplingsladd som inte har denna skyddande jordledning.



Varning

Varje avbrott av den skyddande jordledningen såväl utanför som invändigt i instrumentet gör förmodligen instrumentet farligt. Medvetet avbrott är förbjudet.

Omkopplingsnollpunktspotentialen finns på den externa kontakten till BNC-uttaget. Dessa kontakter är förbundna med höljet. En säkerhetsjordning via de externa kontakterna till BNC-uttaget är inte tillåtet.

Nätkabel, nätspänningsområde och säkringar

Det finns nätkablar anpassade till olika länders nätuttag. Instrumentet kan beställas för leverans med en av nedanstående kabeltyper.

Table 1-6. Medleverera nätkabel

Instrumenttyp	Medleverera nätkabel
54200/XX1	Europa
54200/XX3	Nordamerika
54200/XX4	Storbritannien (U.K.)
54200/XX5	Schweiz
54200/XX8	Australien

Kontrollera att den lokala nätspänningen är lämpad för instrumentet, före anslutning av nätkabeln.

Obs

För eventuellt utbyte av kontaktdon på den medlevererade sladden, anlita endast en kvalificerad tekniker.

Apparaten kan anslutas till nätspänningar från 100 till 240 Veff, och frekvenser från 50 till 60 Hz, utan inställning av spänningsområde.

Varning

Vid byte av säkring ska instrumentet först kopplas bort från nätspänningen.

Säkringarna finns i säkringshållaren vid nätspänningsintaget på instrumentets baksida. Om säkringen behöver bytas, gör på följande sätt:

- ta bort nätkabeln
- tryck in klacken på säkringshållaren och dra ut hållaren, se bilden.
- sätt i ny säkring (av rätt typ enligt IEC127 T1,6A eller CSA/UL 198G T1,6A) i säkringshållaren och sätt tillbaka säkringshållaren.

Varning

Använd endast reservsäkringar av den specificerade typen och strömstyrkan. Reparerade eller kortslutna säkringar får ej användas. Ignorera inte dessa viktiga säkerhetsåtgärder.

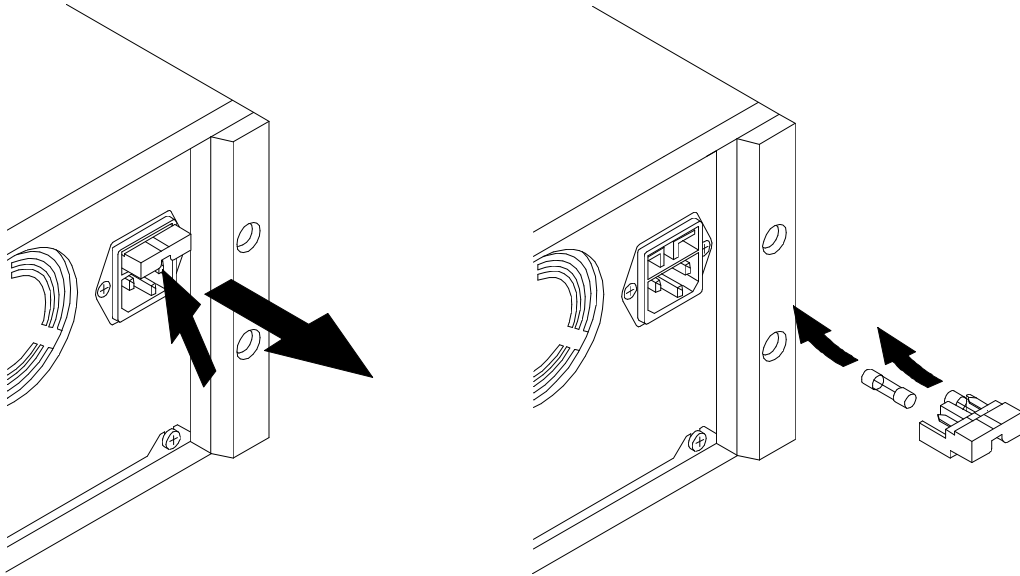

Instrumentets driftsläge

Instrumentet kan användas horisontalt eller, med fötterna utfällda, i en luttande position. När de nedfällbara fötterna fällts nedåt kan instrumentet användas i ett snedplacerat läge. Den tekniska specifikationen i kapitel 7 är tillämplig för de specificerade användningslägena. Instrumenter får aldrig installeras på en yta som alstrar eller utstrålar värme och inte heller utsättas för direkt solsken.

Radio-avstörning

När det gäller radio-avstörning är instrumentet omsorgsfullt avstört och kontrollerat. Vid koppling i kombination med basisenheter som inte är riktigt avstörda och med annan kring-utrustning kan det uppstå radiostörningar. Vid sådana fall är extra åtgärder för radio-avstörning nödvändiga.

Skiljetransformator

Eftersom många tv-apparaters chassi befinner sig i samma fas, är det av säkerhetsskäl absolut nödvändigt att köra den mottagare som skall testas över en lämplig skiljetransformator. På så sätt är det möjligt att åstadkomma en direkt förbindelse mellan tv-apparatens chassi och skyddsledaranstutningen till någon som helst testapparat, varigenom risken för elektrisk stöt minskas avsevärt.

Chapter 2

Main Features

Title	Page
Introduction.....	2-3
Main Features.....	2-3

Introduction

This chapter describes the main features of the instrument, its functions, operating modes and options.

Main Features

This chapter describes the **Fluke 54200 TV Signal Generator** with all options built in. Depending on the ordered instrument different features may not be implemented.

This TV Signal Generator matches any dedicated set of requirements, whether it is in R&D, manufacturing, quality assurance, installation, service, and training.

The generator covers nearly all world-wide standards including PAL, NTSC, and SECAM with their subsystems as well as sound standards and data transmission standards.

The Fluke 54200 with its menu-driven control makes it easy for you to work with the instrument and allows a large choice and configuration of the provided test signals. The instrument offers the complete RF range from 32 MHz to 900 MHz, so covering the IF-, VHF I-, VHF III-, S-, Hyper- and UHF-Band.

The test patterns are selected using the PATTERN keypad or additional soft keys. Some test patterns are offered in different versions or for different TV standards, for example, the Color Bar, PLUGE, DEM (Demodulator) or VCR test. Some patterns are offered with selectable 'white' or primary color signal levels. Up to fourfold test pattern combinations are selectable. All test patterns are offered in the 16:9 and 4:3 picture format.

Up to 99 complete instrument settings can be stored and recalled for fast and convenient setup. A step function allows to move swiftly through the sequence of stored information.

Furthermore, you have the advantage to recall TV system depending instrument settings for 20 different countries including sound systems, color standard, residual carrier, group delay correction, and Teletext.

An **Insertion-Reference Signal** (IRS) is generated for PAL 625 line systems in the field-blanking interval in the TV line 17. The IRS is according to CCIR Rec. 473-5 and serves to detect and correct distortion in TV signals.

The composite video signal of nominal 1 V (pp) at the VIDEO OUTPUT can be set from 0 to 1.5 V.

The level of the chrominance signal is selectable from 0% to 150%.

The maximum RF output signal of 10 mV or 100 mV can be attenuated by more than 60 or 80 dB.

On the rear panel the instrument offers different video outputs with **RGB, YCrCb, and Y/C signals**.

For synchronization purpose, three outputs are available: Composite, Line, and Field Sync.

The instrument offers the following sound systems:

- Mono sound
- Analog stereo sound
- NICAM sound
- BTSC/MTS sound

Mono sound is available for all TV subsystems. Different internal audio frequencies are selectable.

Different analog Stereo sound systems are optional available, for example, for the countries Germany (FM BG), Korea (FM Mk), and Czech Republic (FM DK).

NICAM and BTSC sound are options. NICAM is a digital sound system mainly used for PAL B/G, PAL I, PAL D, and SECAM L. Three special test signals are available to check NICAM equipment.

The BTSC/MTS sound system is selectable for NTSC M and PAL M. BTSC is mainly used in the United States and Taiwan. Several specific test signals are included.

External sound modulation is possible for all sound systems except NICAM and BTSC sound. For BTSC, an external MTS signal can be applied; so the instrument operates as RF modulator.

The modulated sound carrier is available at the RF Output and Sound IF Output. The NICAM signal is applied to the NICAM Output and the BTSC baseband spectrum to the MTS Output at the rear.

Teletext and Wide Screen Signalling bits (WSS) are available with both the PAL and SECAM standard. The Teletext system is according to the WST Teletext standard and includes both TOP and FLOF or Antiope. Automatically generated Wide Screen Signalling bits in TV line 23 are bits to identify some transmission information, for example, Aspect Ratio or Subtitling. Additionally the WSS bits are programmable.

Closed Captioning (CC) is a subtitling system which is transmitted using either field of line 21. In the Fluke 54200 Closed Caption and Text Service (T1 to T4) are available for the TV systems NTSC, PAL 625 and 525 line systems, and SECAM.

The **VPS (Video Programming System)** and **PDC (Programme Delivery Control)** systems are used to synchronize a VCR recording with the actual broadcast transmission (start and stop time). VPS is mainly used in Germany, Austria, and Switzerland, whereas PDC is used in many other European countries.

VPS uses TV line 16 of the PAL transmission standard. The PDC data are transmitted with the Teletext signal.

Remote control is done either using the IEEE-488 or RS-232C Interface. The option provides both methods, however, only one can be used at a time.

Chapter 3

Getting Started

Title	Page
Introduction.....	3-3
Getting Started	3-3
General Information	3-3
Turning the Instrument on	3-3
Self-test Routine.....	3-3
Brief Checking Procedure.....	3-4
Test Equipment	3-4
Instrument Settings and Checks.....	3-4
Operation and Application.....	3-13
Control Elements, Display and Connectors.....	3-13
Front Panel	3-13
Rear Panel.....	3-16

Introduction

This chapter starts with the general procedures and precautions necessary for operation followed by a brief checking procedure. It contains a summary of controls and connectors on the front and rear panels and the display.

Getting Started

General Information

This section outlines the procedure and precautions necessary for operation. It identifies and briefly describes the functions of the front and rear panel controls and the display.

Turning the Instrument on



Before turning the instrument on, ensure that it has been installed in accordance with the instructions in Chapter 1.

After the instrument has been connected to the line voltage in accordance with Chapter 1, it can be turned on by setting the **POWER** switch on the front panel to **ON**.

The specifications given in Chapter 7 of this manual are valid when the instrument is installed in accordance with the instructions in Chapter 1 of this manual and after a warm-up period of 30 minutes.

After turning the power off, wait at least 5 seconds before turning it on again. This allows all power to completely discharge and the instrument to reset.

Self-test Routine

After power on, the instrument performs a self-test routine of the PROM, processor RAM, stored instrument settings, calibration data, and available digital modules. After approximately 2 seconds the generator automatically recalls its instrument state before power off.

If a fault is found during the self-test this fault is indicated as follows,

for example:

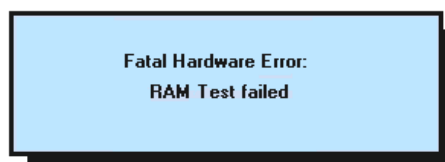

For detailed information, see the end of Chapter 5 'Operating Hints, Out of Range and Error Messages'.

Brief Checking Procedure

This procedure checks the instrument functions with a minimum of steps. It is assumed that the operator doing the test is familiar with the instrument and its specifications.

After POWER ON, the instrument is automatically set to the operating mode to which it was set before POWER OFF.

Test Equipment

- Multi-system TV

Instrument Settings and Checks

The display shows the last instrument settings before power off, for example:

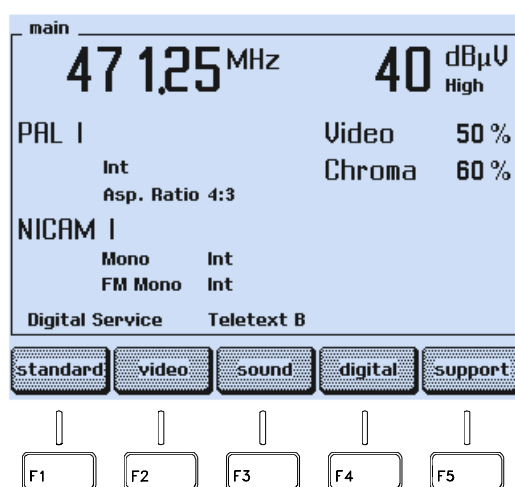

Figure 3-1. Main Menu with Current Instrument Settings

- Press the **standard** softkey (F1).

- A submenu with the selected country and its default settings appears, in this example, United Kingdom.

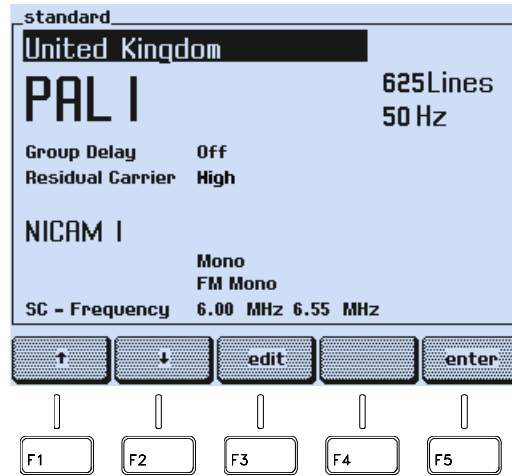

Figure 3-2. Current Country with Video Standard and Sound System

- Press the **edit** softkey (F3).
- A popup menu with a pre-defined country list appears.
- Select with the **↑** or **↓** softkey (F1 or F2) your country, for example, Germany. If your country is not listed, select a country that uses your or a similar video standard and sound system.



Figure 3-3. Popup Menu with the Pre-defined Country List

- Press the **enter** softkey (F5) to confirm your selection.

- The display shows the video standard and the sound system according to the selected country.



Figure 3-4. Selected Country with Video Standard and Sound System

- If your TV equipment does not support the TV system, select the required video standard or sound system with the **↑** or **↓** softkey (F1 or F2), for example, **FM Germany**.
- Press the **edit** softkey (F3).
- Select the required standard or system with the **↑** or **↓** softkey (F1 or F2), for example, **FM Mono**.
- Press the **enter** softkey (F5) to confirm your settings.
- Press the **enter** softkey (F5) again to return to the **main** menu.

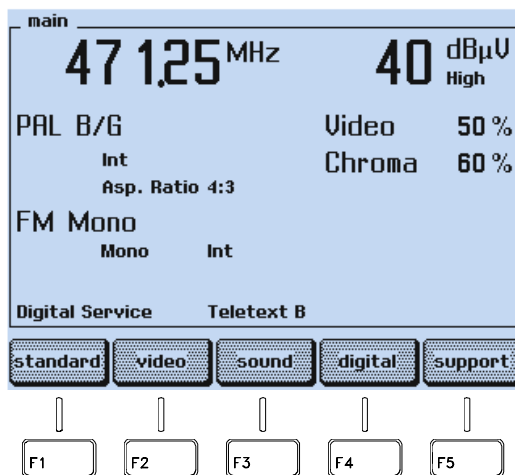

Figure 3-5. Main Menu with Selected Settings

- Check if the video and chroma amplitudes are set to 100%.
- If not, press the **video** softkey (F2).

The display shows the **video** submenu with the complete current settings:

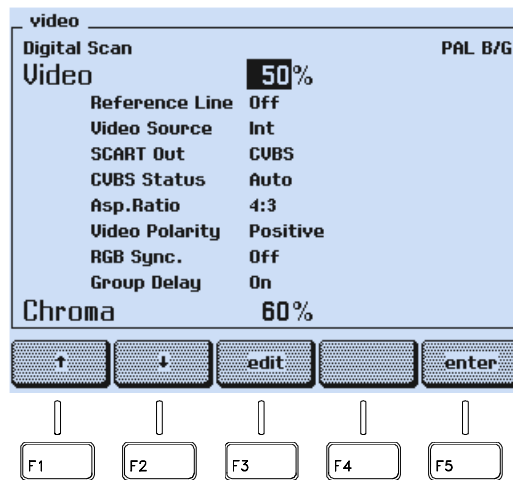

Figure 3-6. Video Submenu with Current Setting

- Press the **edit** softkey (F3).
- A popup menu for numerical entries appears.

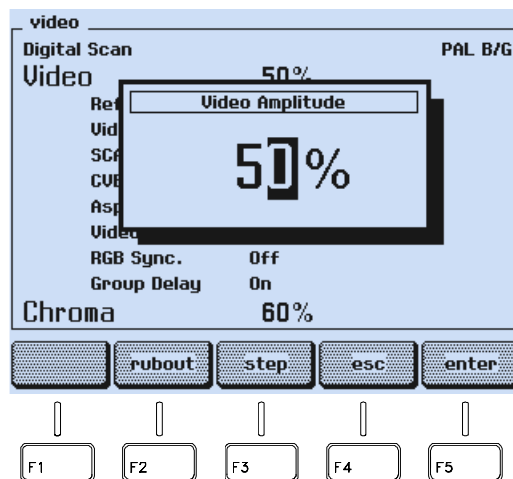

Figure 3-7. Video Amplitude Setting

- Key in **1 0 0** using numerical keypad.
- Press the **enter** softkey (F5) to confirm your entry.
- Press the **↑** softkey (F2) to select **Chroma**.
- Key in **1 0 0** using numerical keypad.
- Press the **enter** softkey (F5) to confirm your entry.
- Press the **enter** softkey (F5) again to return to the **main** menu.

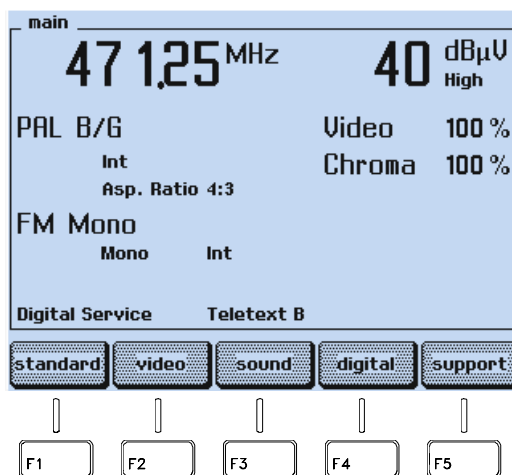

Figure 3-8. Main Menu with changed Settings

- Press the **FREQ** key on the right of the display to select an appropriate RF carrier frequency, for example, 203.25 MHz.
- A popup menu for numerical inputs appears:

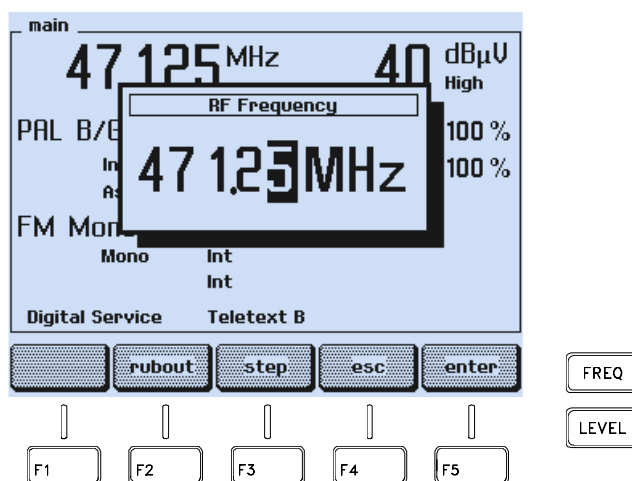

Figure 3-9. Carrier Frequency Setting

- Key in **203.25** using numerical keypad.
- Press the **enter** softkey (F5) to confirm your entry.

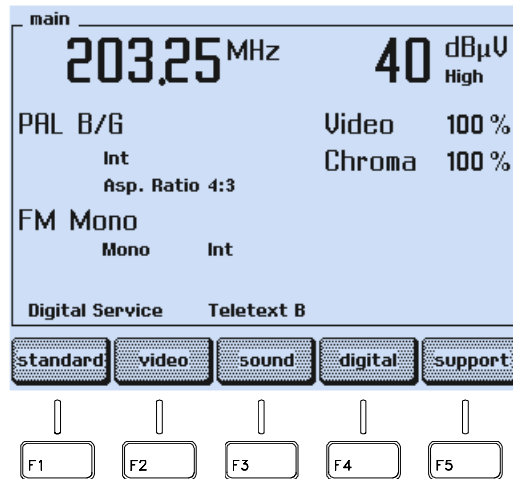

Figure 3-10. Selected Carrier Frequency

- Set your TV to the same frequency or to the corresponding TV channel, in this example channel 9. For the relationship between carrier frequency and TV channel number, see Appendix B.
- Press the **LEVEL** key on the right of the display to select an appropriate level for the vision carrier.

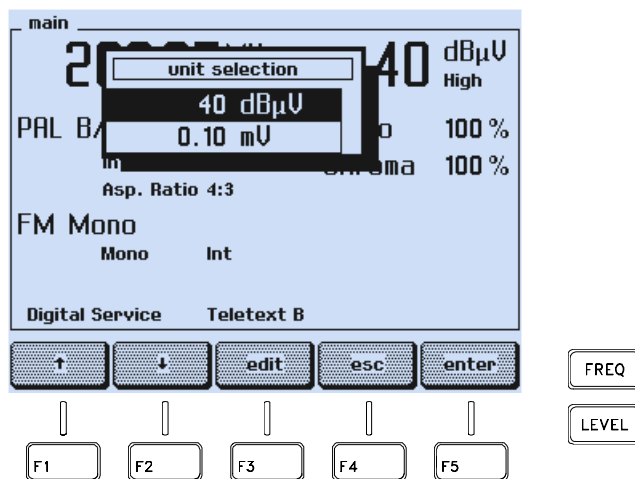

Figure 3-11. Carrier Level Setting

- Select the unit **dBµV** or **mV** with the **↑** or **↓** softkey (F1 or F2).
- Press the **edit** softkey (F3).
- Key in **80** for dBµV or **10** for mV using numerical keypad.
- Press the **enter** softkey (F5) to confirm your entry.

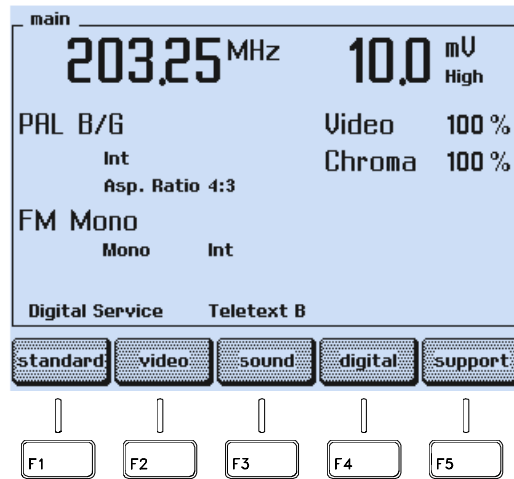

Figure 3-12. Final Settings

- Press the **sound** softkey (F3) to check the sound settings.
- The **sound** submenu appears:

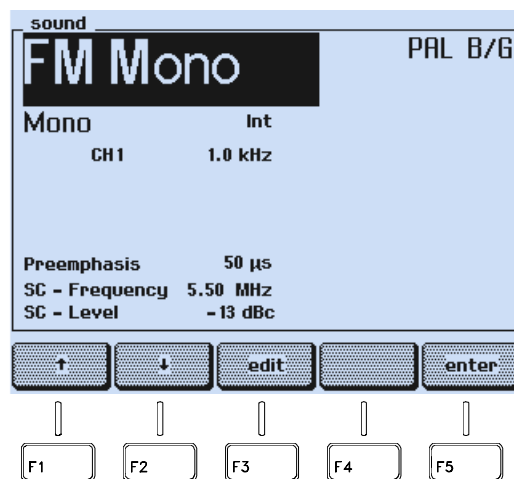

Figure 3-13. Sound Parameter Settings

Check if the sound modulation is set to internal (**Int**) and if an appropriate modulation frequency is selected, for example, **CH 1 1.0 kHz**. If not:

- Select the **CH 1** parameter with the **↓** softkey (F2).
- Press the **edit** softkey (F3).

The popup menu with the selectable modulation frequencies appears:

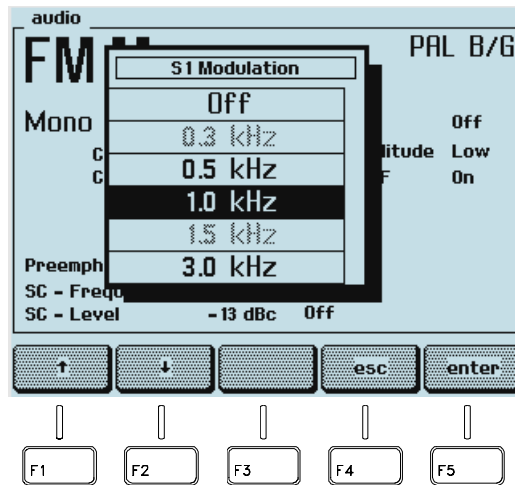

Figure 3-14. Modulation Frequency Setting

- Select an appropriate frequency with the **↑** or **↓** softkey (F1 or F2).
- Press the **enter** softkey (F5) to confirm your selection.
- Press the **enter** softkey (F5) again to return to the **main** menu.
- Press the **COLOR BAR** key in the **PATTERN** keypad for 1 second.
- The popup menu for the Color Bar parameter appears.

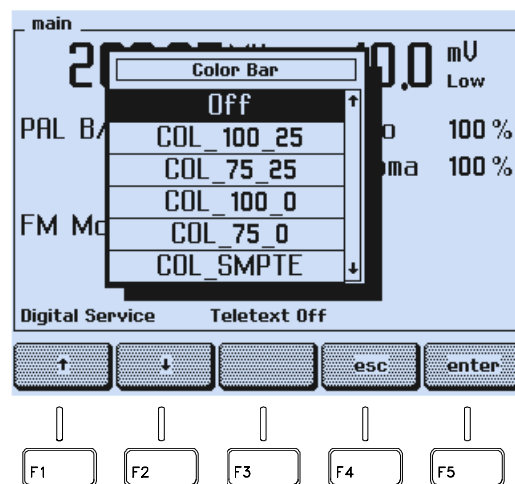

Figure 3-15. Pattern Parameter

- Select **COL_100_25** or **COL_75_25** with the **↑** or **↓** softkey (F1 or F2).
- Press the **enter** softkey (F5) to confirm your settings.
- Press the **GREYSCALE**, **MULTIBURST**, and **CIRCLE** keys in the **PATTERN** keypad.

- Connect the **RF OUTPUT** on the front panel of the 54200 to the antenna input of your TV. Use an appropriate RF connection cable, for example, the attached RF cable BNC to TV.
- Check the correct video and sound reproduction on the TV.

In this example, you get the following combined test pattern and a mono sound with 1 kHz modulation.

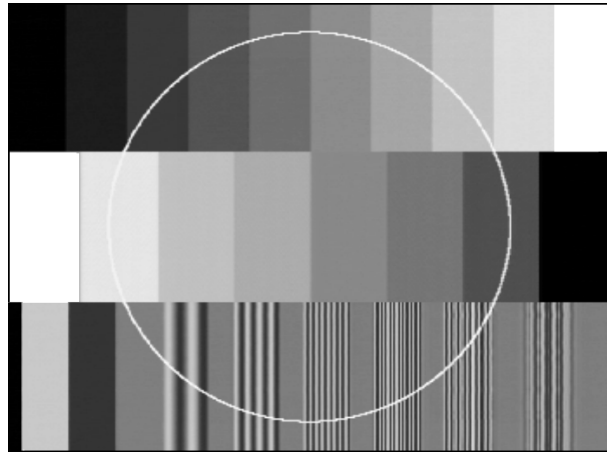

Figure 3-16. Combined Test Pattern

- Select different test patterns using the **PATTERN** keypad.





For more details about the operating principle and the applications of the test patterns, see Chapter 4, How to Use the Instrument.

Operation and Application

Control Elements, Display and Connectors

The controls and connectors are listed according to their functional sections, and a brief description of each is given.

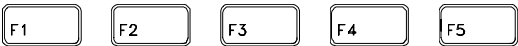
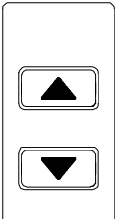
Front Panel

Control/connector	Function
	Power switch  ON  OFF
	Five softkeys used to change or select functions or parameters. Depending on the mode of the instrument the functionality changes. The current function of the keys is shown on the display above the keypad.
	Step keys up and down for changing parameter settings incrementally. A step key indicator in the display points to the current parameter which can be changed.
	FREQ: Key used to display the RF frequency. The pop-up window serves to select: - RF carrier frequency (vision carrier) - Stepping function LEVEL: Key used to display the RF level. The popup window serves to select: - RF level setting - Level units mV or dB μ V - Level range low (10 mV) or high (100 mV) - Stepping function STORE: Key used to store instrument settings (99 memory registers). RECALL: Key used to recall stored instrument settings (99 memory registers and 1 default setting).

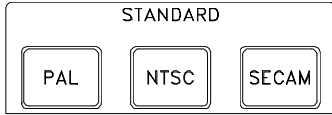

Keys used to select:
TV systems PAL, NTSC, or SECAM.

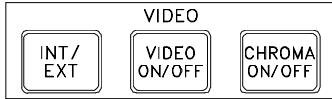

Keys used to select:
- Internal or external video modulation
- Video signal ON/OFF
- Chroma signal ON/OFF

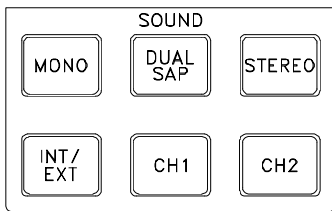

Keys used to select:
- Sound modes
MONO, DUAL or SAP, STEREO
(SAP = Second Audio Program for BTSC Sound).
- Internal or external sound modulation
- Sound channel 1 and 2 resp. left/right ON/OFF.
Press long to popup audio frequencies:
CH1 calls up the S1 or S3 Modulation menu,
CH2 calls up the S2 Modulation menu.

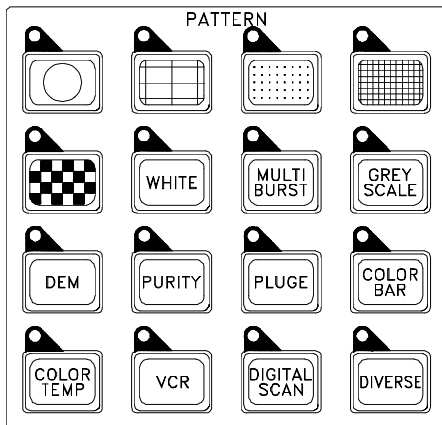

16 keys used to select single or combined video test patterns.
LEDs above the keys indicate the current on/off status.
Some keys: press long to popup parameters or versions of patterns.

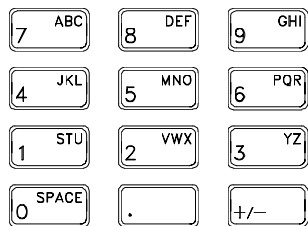

Keys used to input:
- Digits for frequency, levels, etc.
- Characters in text mode, for example, VPS or PDC program titles.

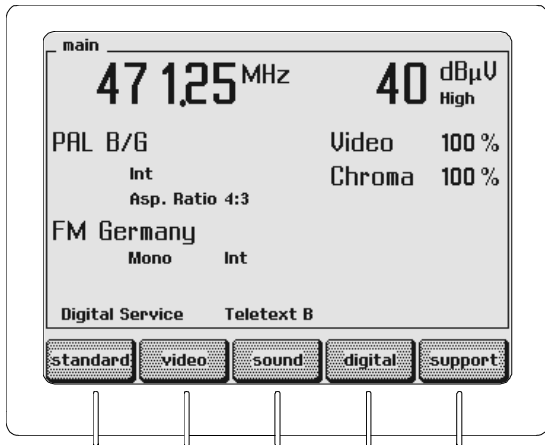

Full graphic display with backlight, 1/4 VGA.

TO REAR



Feed through capability from or to the TO FRONT BNC connector at the rear panel.

VIDEO IN

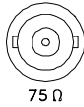

Video input for external CVBS (75 Ω), BNC connector.

VIDEO OUT

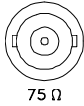

Video output of CVBS (75 Ω), BNC connector.

RF OUT

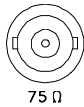

Radio Frequency output (75 Ω), BNC connector.

Rear Panel

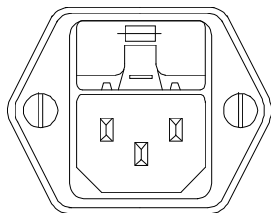

Input power module with fuses.

For details, see Chapter 1,
Power Cable, Line Voltage Range, and Fuses.

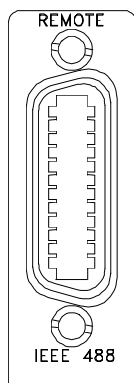

IEEE-488 bus connector for remote control.

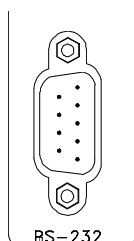

RS-232 connector for remote control.

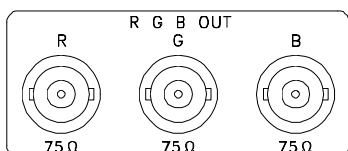

R G B output (75 Ω), 3 BNC connectors:
Red, Green, and Blue signals.

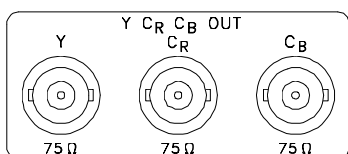

Video component output Y/C_R/C_B (75 Ω),
3 BNC connectors:
- Y = Y components including Teletext
- C ≙ R-Y components
- C_B ≙ B-Y components

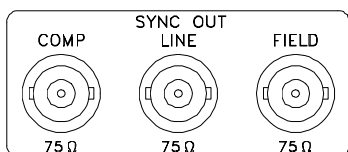

Synchronization outputs (75 Ω),
3 BNC connectors:
- COMP = Composite sync
- LINE = Line sync
- FIELD = Field sync

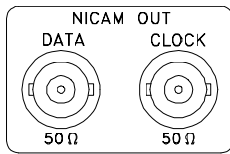

Output of NICAM sound (50 Ω),
 2 BNC connectors:
 - DATA = NICAM Data
 - CLOCK = NICAM Clock

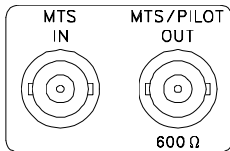

MTS IN:
 MTS multiplex input for the BTSC baseband
 signal (0.1 MΩ), BNC connector.

MTS/PILOT OUT:
 Output of BTSC baseband signal and output of
 FM Stereo pilot signal (600 Ω),
 BNC connector.

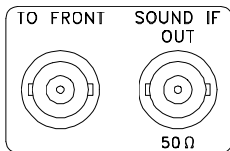

SOUND IF OUT:
 Output of modulated IF sound carrier signal
 (50 Ω), BNC connector.

TO FRONT:
 Feedthrough capability from or to the
 TO REAR BNC connector at the front panel.

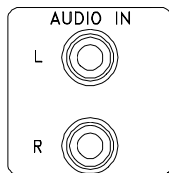

Audio input for external audio signals
 (0.1 MΩ), 2 Cinch connectors:
 - Left = audio channel 1
 - Right = audio channel 2

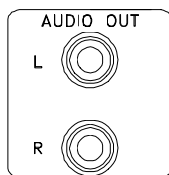

Audio output of internal generated or external
 supplied audio signals (600 Ω),
 2 Cinch connectors:
 - Left = audio channel 1
 - Right = audio channel 2

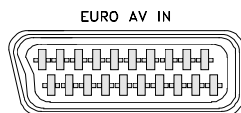

Audio/Video input, SCART/Euro-AV connector, standard connection for TV and video systems.

Table 3-1. EURO AV IN

Pin	Signal
2	Audio channel 2, right
6	Audio channel 1, left
20	CVBS input
4, 18, 21	Ground

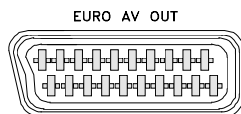

Audio/Video output, SCART/Euro-AV connector, standard connection for TV and video systems.

Table 3-2. EURO AV OUT

Pin	Signal
1	Audio channel 2, right, S2/S3
3	Audio channel 1, left, S1/S3
7	RGB output, blue component
8	CVBS status
11	RGB output, green component
15*	RGB output, red component
	Y/C output ON:
	C signal (chroma part of CVBS)
16	RGB status
19*	CVBS output:
	RGB ON: CVBS for sync
	Y/C ON:
	Y signal (luma part of CVBS)
4,5,9,13	Ground
17,18,21	Ground

*outputs are selectable between RGB or Y/C mode

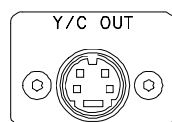

Y/C output (75 Ω), S-connector 4 pins.

Table 3-3. Y/C OUT

Pin	Signal
1	Y ground
2	C ground
3	Y signal, luma
4	C signal, chroma

Chapter 4

How to Use the Instrument

Title	Page
Introduction.....	4-3
Operating via Keyboard.....	4-3
General Information	4-3
Display	4-3
Keyboard	4-6
Instrument Settings	4-7
TV Standard.....	4-7
Video Settings.....	4-10
Sound Settings	4-12
Teletext, VPS, PDC, CC, and WSS.....	4-14
Vision Carrier Frequency Settings (RF Carrier).....	4-15
Vision Carrier Level Setting (RF Level).....	4-18
Video Amplitude Setting.....	4-22
Chroma Amplitude Setting.....	4-26
Test Patterns	4-30
Storing and Recalling of Settings	4-35
Storing of Instrument Settings.....	4-35
Recalling of Instrument Settings	4-37
Digital Data and Text	4-39
Description and Applications of the Test Patterns	4-40
Circle	4-42
Center Cross with Border Castellations	4-43
Dots	4-45
Crosshatch	4-46
Checkerboard.....	4-47
White Pattern	4-48
Multiburst	4-48
Greyscale	4-49
DEM Pattern	4-49

DEM 1 (PAL)	4-49
DEM 1 (NTSC).....	4-51
DEM 1 (SECAM)	4-52
DEM 2 (PAL)	4-53
DEM 2 (NTSC).....	4-53
DEM 2 (SECAM)	4-54
Purity	4-55
PLUGE	4-56
Color Bar.....	4-57
Full Field Color Bar	4-57
Split Field Color Bar	4-58
SMPTE Color Bar.....	4-59
Horizontal Color Bar	4-60
Color Temperature Adjustment.....	4-60
VCR Test	4-62
VCR 1	4-62
VCR 2	4-63
Standard Resolution Test.....	4-64
High Resolution Test.....	4-64
Writing Current Adjustment	4-64
Digital Scan Test	4-64
ADC Check 1	4-65
ADC Check 2.....	4-66
Moving Block	4-67
Progressive Scan Check 1.....	4-67
Progressive Scan Check 2.....	4-68
Progressive Scan Check 3.....	4-68
DIVERSE.....	4-69
EHT Test.....	4-69
IRS17	4-70
Combined Test Patterns.....	4-71
CIRCLE.....	4-71
Twofold Combinations of Patterns	4-71
Threefold Combinations of Patterns.....	4-73
Fourfold Combinations of Patterns	4-73
Insertion-Reference Signal (IRS)	4-74

Introduction

Chapter 4 explains the TV Signal Generator and describes the different test patterns and application examples for test patterns.

Operating via Keyboard

General Information

This section describes the principle of the user interface and the submenus. It explains, by means of examples, how to use the keys and popup menus to select parameters and settings. For detailed technical information about TV systems, sound systems, test patterns, and parameters see Chapter 7, Specifications. A description and examples for the application of the test patterns are given in this chapter under the topic 'Description and Application of the Test Patterns.'

Display

The **main** menu shows a summary of the most important current settings. The displayed information depends on the selected TV and sound system. For a complete overview of the selectable parameter and displayed information, see the Menu Tree in the Appendix F.

For example:

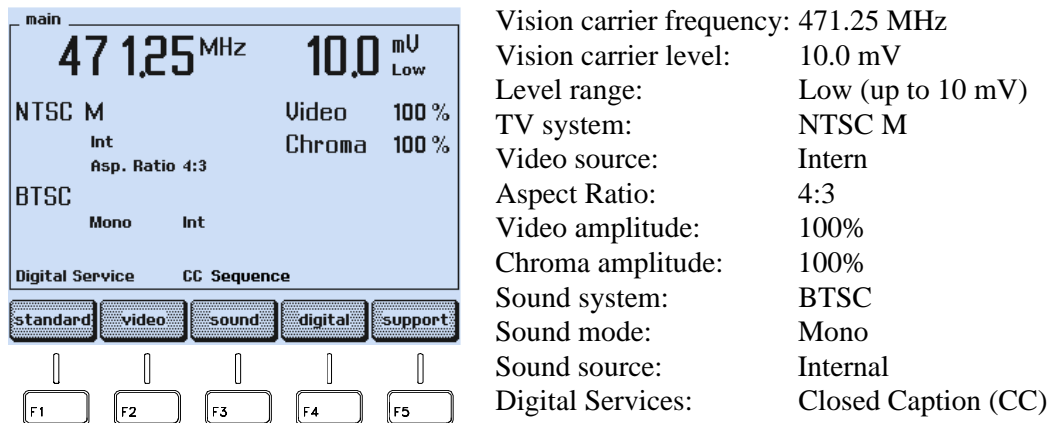
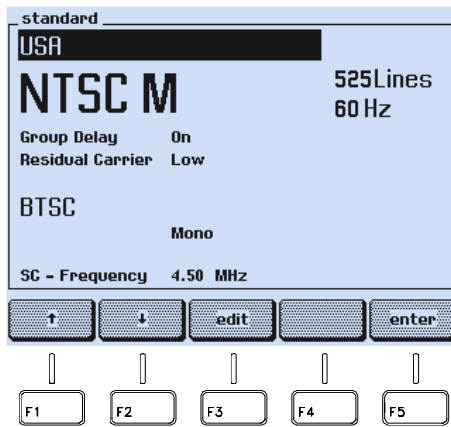

Figure 4-1. Main Screen

The labels in the lowest row of the display show the current functions of the assigned softkeys F1 to F5. From the **main** screen, you can call up five submenus using the softkeys to select different settings:

TV Standard Submenu



Country with standard settings: USA *
 TV system: NTSC M *
 TV lines per frame: 525
 Field frequency: 60 Hz
 Group delay: On *
 Residual carrier: Low *
 Sound system: BTSC *
 Sound mode: Mono
 Sound carrier frequency: 4.50 MHz
 * Parameter can be changed in this submenu.

Figure 4-2. TV Standard Submenu

- Press the **↑** or **↓** softkey (F1 or F2) to select the parameter you want to change. The selected parameter is indicated reverse video.
- Press the **edit** softkey (F3). A popup menu with the selectable settings appears.
- Press the **↑** or **↓** softkey (F1 or F2) to select the required setting. Settings shown in grey are not accessible due to the selected TV system.
- Press the **enter** softkey (F5) to confirm your setting.
- Press the **enter** softkey (F5) again to return to the **main** menu.

Video Submenu

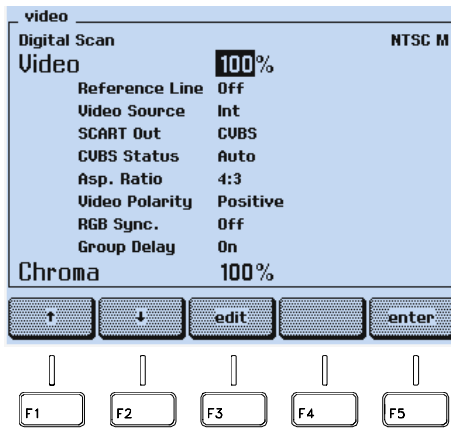

Test pattern: Digital Scan
 TV system: NTSC M
 Video amplitude: 100% *
 Insertion Reference Signal
 IRS17 (Reference Line): Off *
 Video source: Internal *
 Scart output signal: CVBS *
 CVBS status: Auto *
 Aspect Ratio: 4:3 *
 Video polarity: Positive *
 Sync in RGB signal: Off *
 Group delay: On *
 Chroma amplitude: 100% *
 * Parameter can be changed in this submenu.

Figure 4-3. Video Submenu

- Press the **↑** or **↓** softkey (F1 or F2) to select the parameter you want to change.
- Press the **edit** softkey (F3). A popup menu with the selectable settings appears.
- Press the **↑** or **↓** softkey (F1 or F2) to select the required setting.
- For the Video and Chroma amplitude, key in the value using the numerical keypad.
- Press the **enter** softkey (F5) to confirm your setting.
- Press the **enter** softkey (F5) again to return to the **main** menu.

Sound Submenu

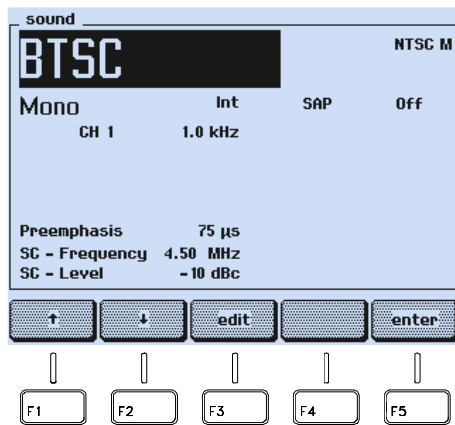

Sound system: BTSC *
 TV system: NTSC M
 Sound mode: Mono *
 Sound source: Internal *
 Second Audio Program (SAP): Off *
 Audio frequency for channel 1: 1.0 kHz *
 Pre-emphasis: 75 μs *
 Sound carrier frequency: 4.5 MHz
 Sound carrier level: -10 dBc *
 * Parameter can be changed in this submenu.

Figure 4-4. Sound Submenu

- Press the **↑** or **↓** softkey (F1 or F2) to select the parameter you want to change.
- Press the **edit** softkey (F3). A popup menu with the selectable settings appears.
- Press the **↑** or **↓** softkey (F1 or F2) to select the required setting.
- Press the **enter** softkey (F5) to confirm your setting.
- Press the **enter** softkey (F5) again to return to the **main** menu.

Submenu for Digital Services

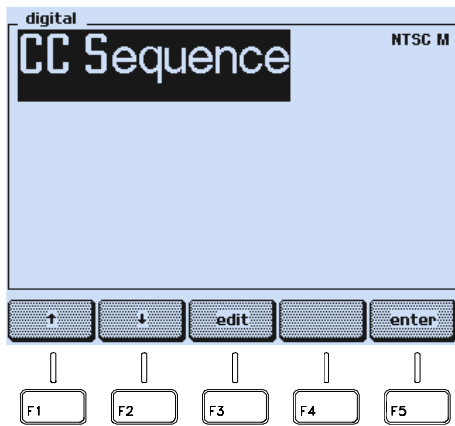

Digital Service: CC (Closed Caption) *
 TV system: NTSC M

* Parameter can be changed in this submenu.

In the external video modulation mode the digital services are not available. The display only shows the selected TV system.

Figure 4-5. Submenu for Digital Services

- Press the **edit** softkey (F3). A popup menu with the selectable settings appears.
- Press the **↑** or **↓** softkey (F1 or F2) to select the required setting.
- Press the **enter** softkey (F5) to confirm your setting.
- If you select the **CC** mode, an additional popup menu appears to select the memory number or the sequence.
- Press the **enter** softkey (F5) to confirm your setting.
- Press the **enter** softkey (F5) again to return to the **main** menu.

Support Submenu

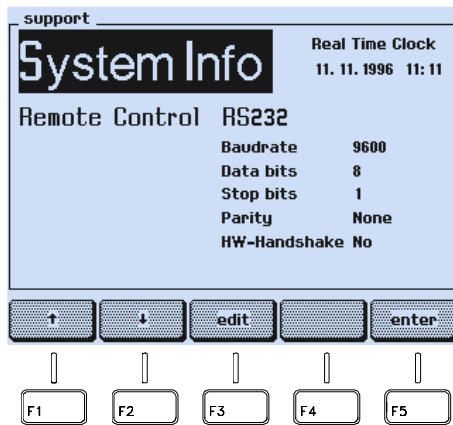

Figure 4-6. Support Menu

- Press the **↑** or **↓** softkey (F1 or F2) to select the parameter you want to change.
- Press the **edit** softkey (F3). A popup menu with the selectable settings appears.
- Press the **↑** or **↓** softkey (F1 or F2) to select the required setting.
- Press the **enter** softkey (F5) to confirm your setting.
- Press the **enter** softkey (F5) again to return to the **main** screen.

System information: **
Real time clock: Date * and time *
Remote control interface: RS232 *
Baud rate: 9600 *
Data bits: 8 *
Stop bits: 1 *
Parity: None *
Hardware handshake: No *

* Parameter can be changed in this submenu.

** If you select **System Info**, an popup menu appears, showing the installed options, instrument type, serial number, software version, and the date of last calibration.

Keyboard

The keyboard of the instrument has four kinds of key functions.

- Keys that have a direct effect on the output signal for often used functions:
 - All keys in the **PATTERN** field. Some **PATTERN** keys call up a popup menu in the display for parameter selection when pressed longer than one second. You can select the parameter with the **↑** or **↓** softkey (F1 or F2). Press the **enter** softkey (F5) to confirm your selection.
 - The keys in the **STANDARD** field change between the last selected PAL, NTSC, or SECAM system.
 - The keys in the **VIDEO** field. The **INT/EXT** key additionally calls up a popup menu when pressed longer than one second. In this menu, you can select the external video source.
 - The keys in the **SOUND** field. The **CH1**, **CH2**, and the **INT/EXT** keys additionally call up a popup menu for modulation frequency or external sound source setting when pressed longer than one second.
 - The **▲** and **▼** keys, if the step function is selected.

- Keys that prepare the instrument for numerical inputs using popup menus on the display:
 - The **FREQ** key
 - The **LEVEL** key
 - The **STORE** key
 - The **RECALL** key
- Keys to enter digits or characters:
 - The keys in the numerical keypad
- Keys with different functions, depending on the selected operating mode and submenu:
 - The softkeys **F1** to **F5**. The current function of the keys is shown in the assigned fields in the display.

Instrument Settings

TV Standard

You can select the required TV system using the **edit** function and the **↑** or **↓** softkey (F1 or F2) in the **standard** submenu. To ease the TV system selection, the instrument offers a pre-defined country list with the standard settings for each listed country. With this list you can nearly cover the TV systems used worldwide. You can call up the list in the **standard** submenu.

Pre-defined Country List

If the instrument shows a different screen than the **main** screen, press the **enter** softkey (F5) until the **main** screen appears.

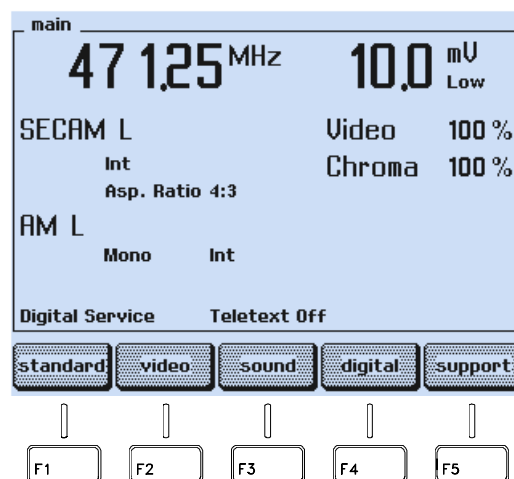

Figure 4-7. Submenu Selection

- Press the **standard** softkey (F1).
- Press the **edit** softkey (F3).
- A popup menu with twenty countries appears.



Figure 4-8. Country List

- Press the **↑** or **↓** softkey (F1 or F2) to select the required country, in this example Germany.
- Press the **enter** softkey (F5) to confirm your selection.
- The display shows the name of the selected country and the main default settings. Further default settings, for example, the Teletext system, are shown in the assigned submenus. For details, see Appendix C, 'Default Settings for Countries'.

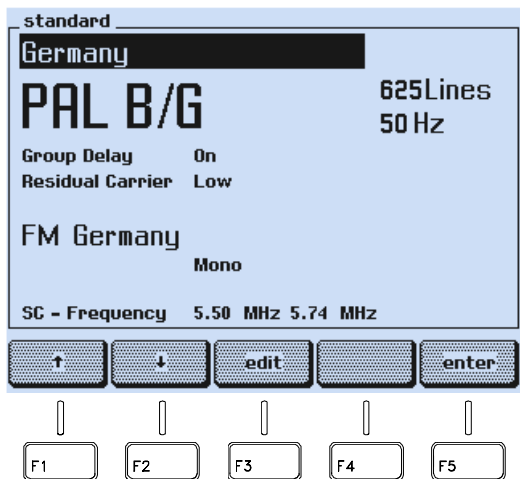

Figure 4-9. Country with Default Settings

If the settings do not match your requirements, you can select different settings in this submenu as described in the following section.

Additional Manual Settings

- Select the **standard** submenu.
- Press the **↑** or **↓** softkey (F1 or F2) in the **standard** submenu to select the setting you want to change, for example, the TV system.



Figure 4-10. Manual System Setting

- Press the **edit** softkey (F3).
- The display shows a popup menu with the selectable TV systems.

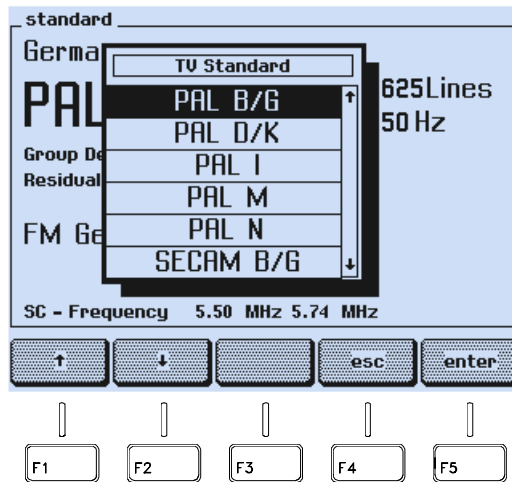

Figure 4-11. TV System Setting

- Press the **↑** or **↓** softkey (F1 or F2) to select the required TV system, for example, **NTSC M**.
- Press the **enter** softkey (F5) to confirm your selection.

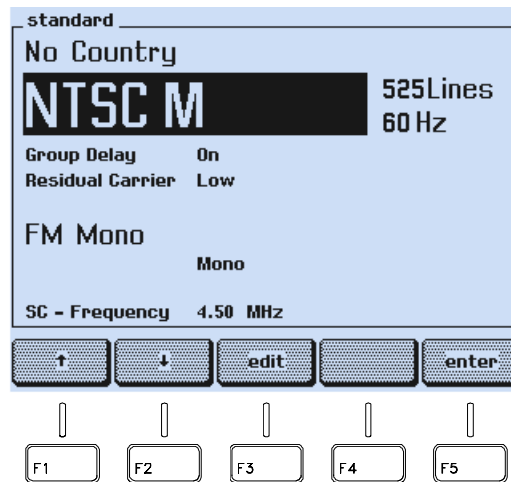

Figure 4-12. Selected TV System

The display shows the selected TV system and the main default settings. Further default settings, for example, the pre-emphasis, are shown in the assigned submenus. For details, see Appendix C, 'Default Settings for Countries'.

You can also select the TV system directly with the **STANDARD** keys **PAL**, **NTSC**, and **SECAM**. Pressing one of these keys calls up the TV standard with the last selected TV system, for example, PAL B/G, NTSC M, or SECAM L.

Video Settings

- Select the **video** submenu.
- Press the **↑** or **↓** softkey (F1 or F2) in the **video** submenu to select the setting you want to change, for example, the **Video Source**.

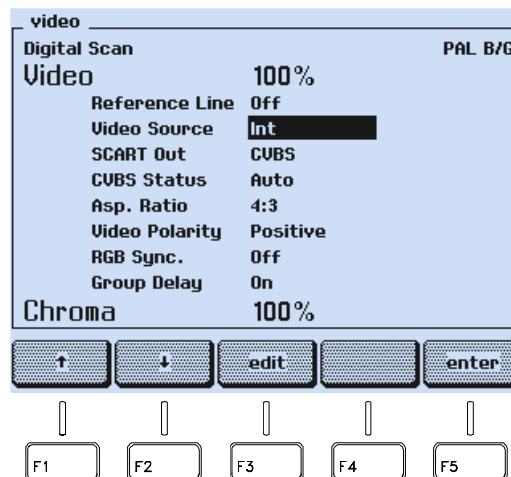

Figure 4-13. Video Settings

- Press the **edit** softkey (F3).

- A popup menu appears.

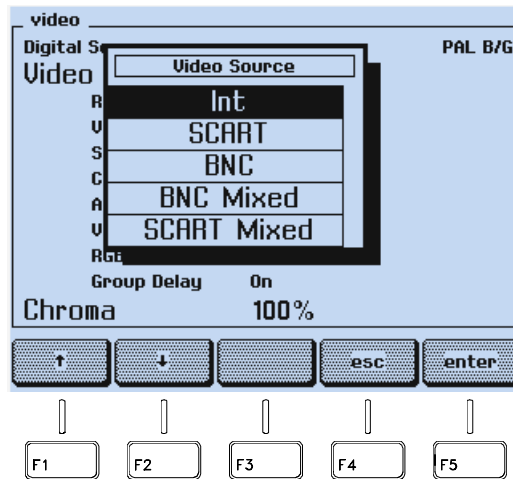

Figure 4-14. Video Source Settings

- Press the **↑** or **↓** softkey (F1 or F2) to select the required video source, for example, **SCART**.
- Press the **enter** softkey (F5) to confirm your selection.

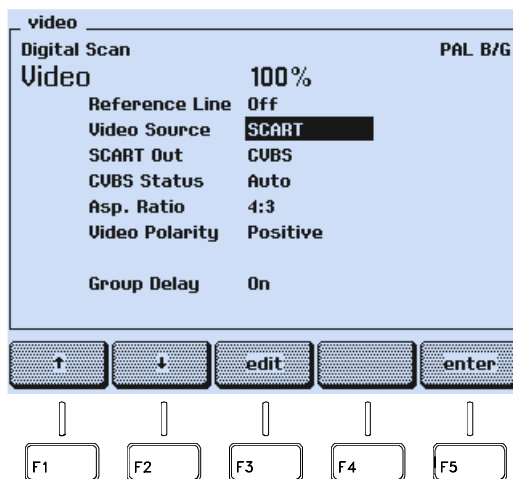

Figure 4-15. Selected Video Source

You can also select the video source directly with the **VIDEO** key **INT/EXT**. Pressing this key briefly toggles to the internal video source if an external was selected. Pressing this key briefly if the internal video source is selected the instrument toggles to the last selected external source, for example, BNC. Pressing this key longer than one second calls up the popup menu for the video source selection. For details about external video sources, see Chapter 5, Section ‘External Video Modulation.’

The **VIDEO** key **VIDEO ON/OFF** switches the video amplitude on or off.

The **VIDEO** key **CHROMA ON/OFF** switches the chroma amplitude on or off (only if the internal video source is selected).

How to set the values for the video and chroma amplitudes is described in this chapter under the topics ‘Video Amplitude Setting’ and ‘Chroma Amplitude Setting’.

Sound Settings

- Select the **sound** submenu.
- Press the **↑** or **↓** softkey (F1 or F2) in the **sound** submenu to select the setting you want to change, for example, the sound mode **Mono**.



Figure 4-16. Sound Settings

- Press the **edit** softkey (F3).
- The display shows a popup menu with the selectable modes in black characters. Modes that are not selectable are shown in grey characters.

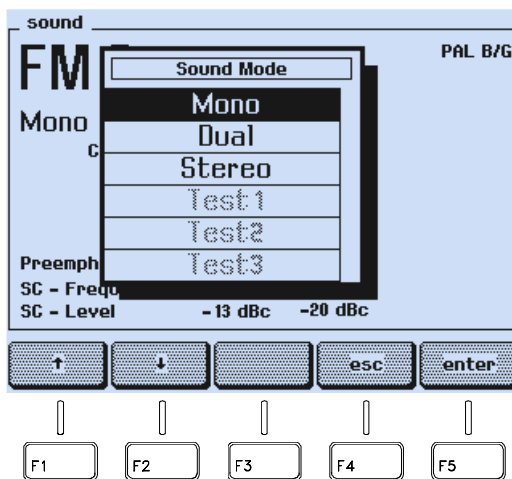

Figure 4-17. Sound Mode Settings

- Press the **↑** or **↓** softkey (F1 or F2) to select the required sound mode.
- Press the **enter** softkey (F5) to confirm your selection.

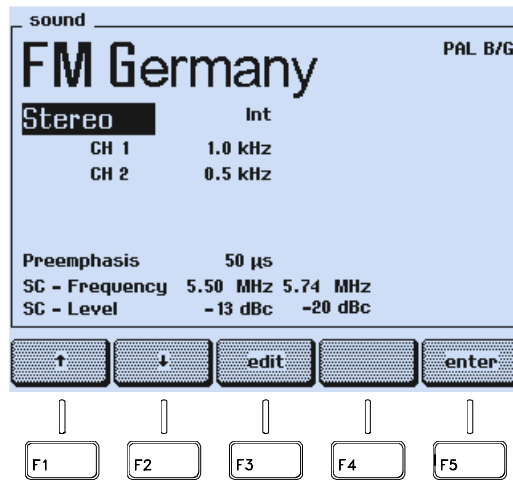

Figure 4-18. Selected Sound Mode

- Use the **↑** or **↓** softkey (F1 or F2) and the **edit** softkey (F3) to select the sound parameters like modulation frequency (**CH1** and **CH2**), the pre-emphasis, and the sound carrier level (**SC-Level**).
- Press the **enter** softkey (F5) to confirm your selection.

You can also select the sound mode directly with the **SOUND** keys **MONO**, **DUAL/SAP**, and **STEREO**.

Pressing the **INT/EXT** key briefly, toggles to the internal modulation frequency source, if an external source was selected. Pressing this key briefly if the internal modulation frequency source is selected, toggles to the last selected external source, for example, SCART. Pressing this key longer than one second, calls up the popup menu for the modulation frequency source selection.

For details about external sound sources, see Chapter 5, 'External Sound Modulation'.

Pressing the **CH1** and **CH2** keys briefly, switches the modulation frequency of the left and right sound channels on or off. Pressing these keys longer than one second, calls up the popup menu for the sound modulation frequency selection.

For details about sound parameter settings, see the table in Chapter 5, 'Sound Operating Modes.'

Teletext, VPS, PDC, CC, and WSS (Digital Services)

Select the **digital** menu.

Press the **↑** or **↓** softkey (F1 or F2) in the **digital** submenu to select the setting you want to change, for example, the field **Teletext Auto**.

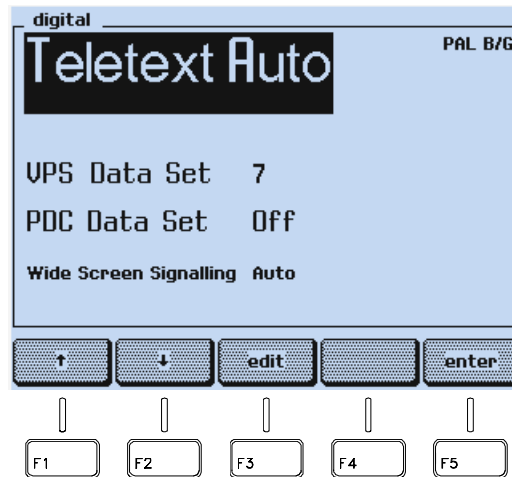

Figure 4-19. Digital Services

- Press the **edit** softkey (F3).
- Press the **↑** or **↓** softkey (F1 or F2) to select, for example, **Teletext B Top 1**.
- Press the **enter** softkey (F5).
- An additional popup menu appears.

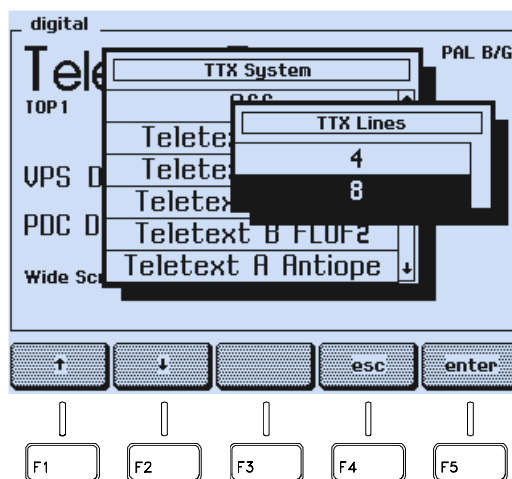

Figure 4-20. Teletext Line Selection

- Press the **↑** softkey (F1) to select, for example, four lines per frame mode.
- Press the **enter** softkey (F5) to confirm your selection.

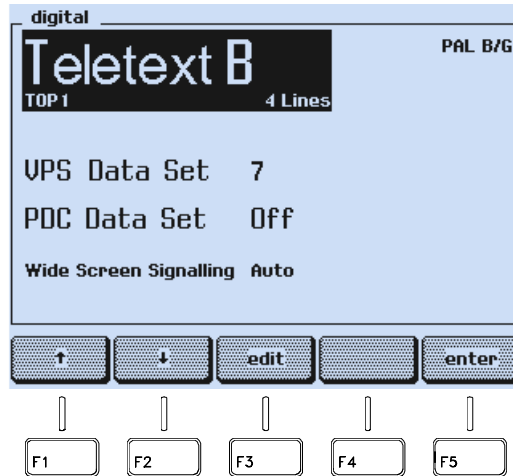

Figure 4-21. Selected Digital Services

How to program the VPS and PDC Data Sets, see Chapter 5, ‘PDC’ and ‘VPS.’

Vision Carrier Frequency Settings (RF Carrier)

You can directly key in a certain value for the carrier frequency using the numerical keypad or you can change the frequency with ▲ and ▼ step keys, if the step function is selected for the frequency, see Section ‘Step Function.’

Numerical Input

- Press the **FREQ** key.
- A popup menu for numerical input appears, showing the current frequency.

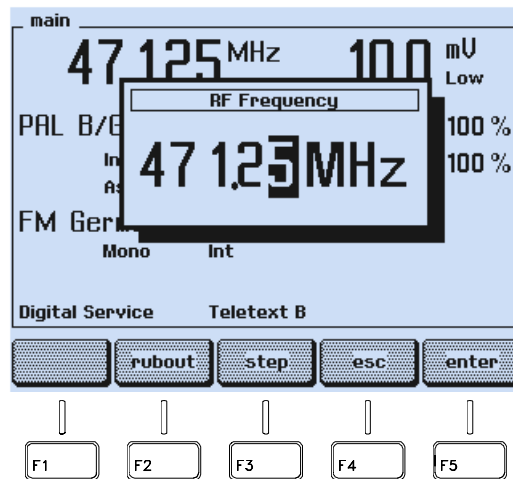

Figure 4-22. Carrier Frequency Input

- Key in the requested value using numerical keypad, for example, **2 0 3 2 5**. For frequencies <100 MHz, use the decimal point key "**.**", for example, **8 9 . 2 5**.
- Keyed in digits can be erased with the **rubout** softkey (F2).

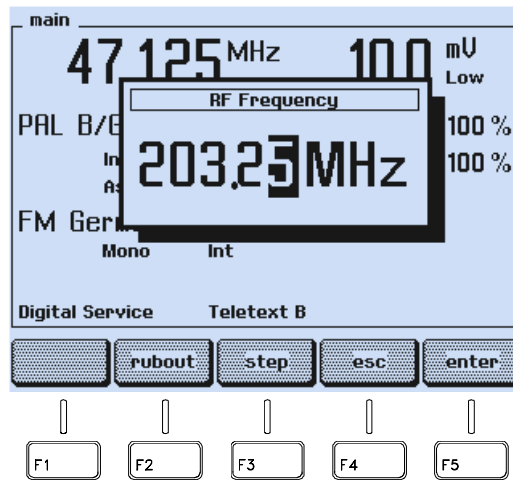

Figure 4-23. Value Input for the Carrier Frequency

- If you want to skip the input, press the **esc** softkey (F4).
- Press the **enter** softkey (F5) to confirm your input.

If you key in values <32 MHz or > 900.00 MHz, the display shows the message:

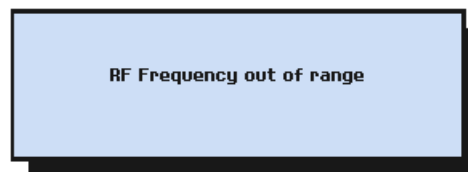

Figure 4-24. Frequency Out of Range Message

- Press the **enter** softkey (F5) for acknowledgment. The instrument returns to the last setting.
- Press the **FREQ** key.
- Key in a value within the allowed setting range using the numerical keypad.
- Press the **enter** softkey (F5) to confirm your input.

Step Function

- Press the **FREQ** key.
- A popup menu for numerical input appears, showing the current frequency.

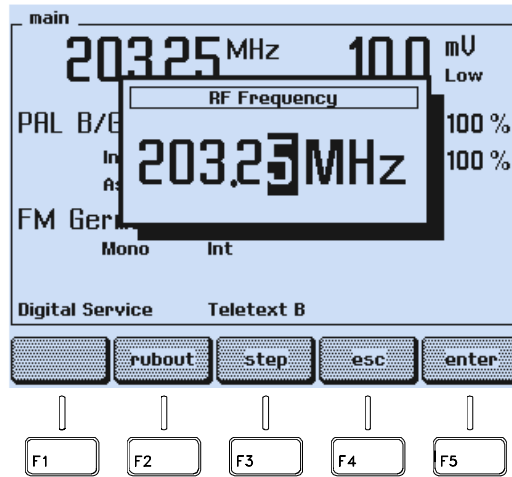

Figure 4-25. Carrier Frequency

- Press the **step** softkey (F3).
- The symbol for the stepping function appears in front of the **RF Frequency** label.

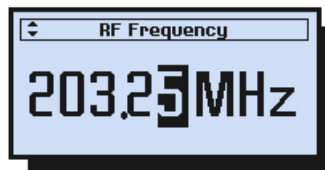

Figure 4-26. Stepping Function Indicator

- Press the **enter** softkey (F5) to confirm and to return to the **main** screen.
- Press the **▲** or **▼** key to increase or decrease the frequency in units of 50 kHz steps. Keeping a key pressed effects continuous stepping with increasing stepwidth.

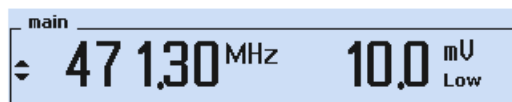

Figure 4-27. Frequency Stepping

The stepping function indicator next to the frequency value shows that the stepping function is selected for the vision carrier frequency.

You can select the stepping function for the:

- Vision carrier frequency
- Vision carrier level / amplitude
- Video amplitude
- Chroma amplitude

You cannot select more than one parameter for the stepping function at the same time.

Vision Carrier Level Setting (RF Level)

You can directly key in a certain value for the carrier level in dB μ V or in mV for the amplitude using the numerical keypad or you can change the value stepwise with the ▲ and ▼ step keys, if the step function is selected for the level or amplitude, see Section 'Step Function.'

Numerical Input

- Press the **LEVEL** key.
- A popup menu for the **unit selection** mV or dB μ V appears, showing the current unit and the value.

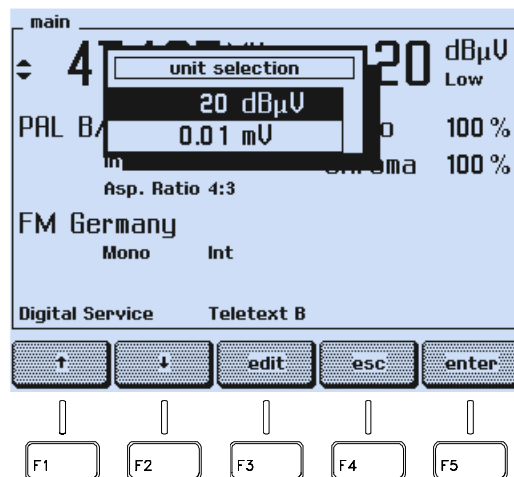

Figure 4-28. Unit Selection

- Press the ▲ or ▼ softkey (F1 or F2) to select: mV for amplitude or dB μ V for level inputs.

- Key in directly the requested value using the numerical keypad for the parameter indicated in inverse video, for example **0 . 0 2** for 0.02 mV.
- Keyed in digits can be erased with the **rubout** softkey (F2).

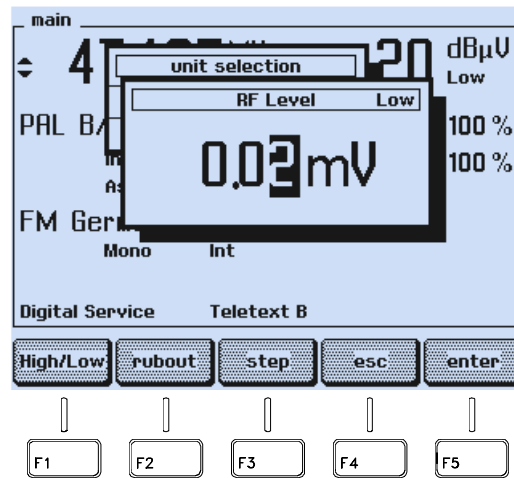

Figure 4-29. Value Input for the Carrier Amplitude

- If you want to skip the input, press the **esc** softkey (F4).
- Press the **enter** softkey (F5) to confirm your input.

If you key in a value >10 mV or >80 dB μ V and the **Low** range is selected (indication in the **main** screen below the unit), the display shows the message:

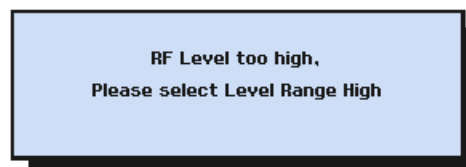

Figure 4-30. Range Exceeding Message

- Press the **enter** softkey (F5) for acknowledgment. The instrument returns to the last setting.
- Press the **LEVEL** key.
- Key in an appropriate value using the numerical keypad or press the **edit** softkey (F3) and the **High/Low** softkey (F1) to select the **High** range and key in the requested higher value.
- Press the **enter** softkey (F5) to confirm.

The **Low** range limit of 10 mV or 80 dB μ V prevents unintended inputs that are too high. You should select the **Low** range if you are testing, for example, receivers with inputs sensitive to overvoltages.

If you key in a value >100.0 mV or >100 dB μ V, or <0.01 mV or <20 dB μ V, the display shows the message:

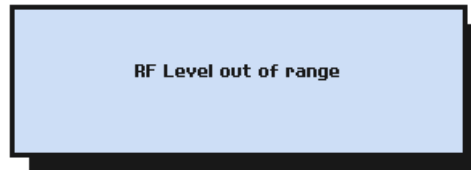

Figure 4-31. Level Out of Range Message

- Press the **enter** softkey (F5) for acknowledgment. The instrument returns to the last setting.
- Press the **LEVEL** key.
- Key in a value within the allowed setting range using the numerical keypad.
- Press the **enter** softkey (F5) to confirm your input.

Step Function

- Press the **LEVEL** key.
- The popup menu for the **unit selection** appears, showing the current unit and the value.

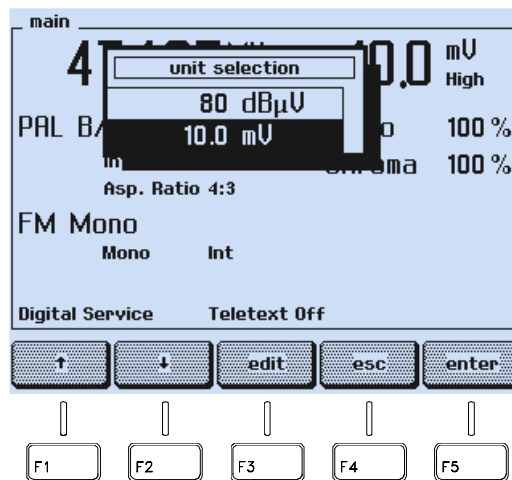

Figure 4-32. Vision Carrier Unit

- Press the **edit** softkey (F3).
- The popup menu for numerical input appears.

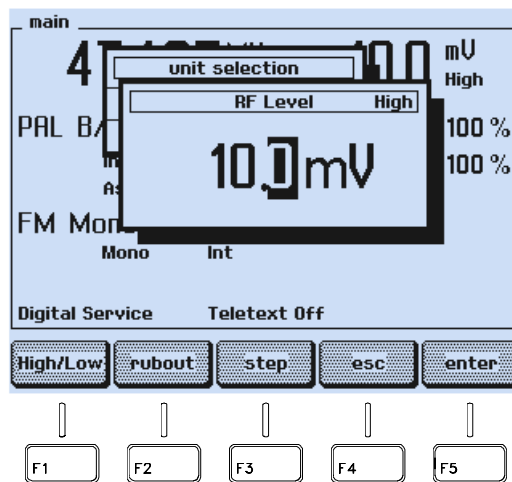

Figure 4-33. Vision Carrier Level / Amplitude

- Press the **step** softkey (F3).
- The symbol for the stepping function appears in front of the **RF Level** label.

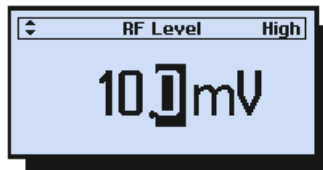

Figure 4-34. Level Stepping Function Indicator

- Press the **enter** softkey (F5) to confirm and to return to the **main** screen.
- Press the **▲** or **▼** key to increase or decrease the carrier level stepwise.
 Stepwidth for the amplitude: 0.01 mV up to 10 mV,
 0.1 mV from 10 mV onwards.
 Stepwidth for the level: 1 dB
 Keeping a key pressed, effects continuous stepping with increasing stepwidth.

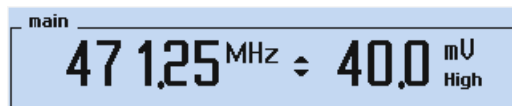

Figure 4-35. Carrier Amplitude Stepping

The stepping function indicator left next to the amplitude value shows that the stepping function is selected for the vision carrier amplitude.

You can select the stepping function for the:

- Vision carrier frequency
- Vision carrier level / amplitude
- Video amplitude
- Chroma amplitude

You cannot select more than one parameter for the stepping function at the same time.

Video Amplitude Setting

You can directly key in a certain value for the video amplitude using the numerical keypad or you can change the amplitude stepwise with ▲ and ▼ step keys, if the step function is selected for the video amplitude, see Section ‘Step Function.’

Numerical Input

- Select the **video** submenu from the **main** screen.

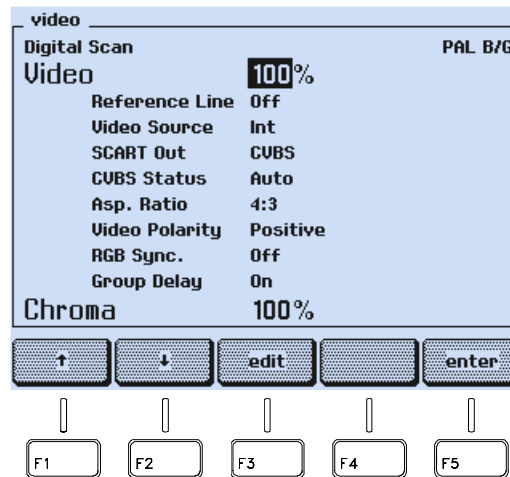

Figure 4-36. Video Amplitude Setting

- Press the **edit** softkey (F3).
- A popup menu for numerical input appears.
- Key in the requested value, for example, **1 2 0** using the numerical keypad. You can also directly key in the value without pressing the **edit** softkey (F3).
- Keyed in digits can be erased with the **rubout** softkey (F2).

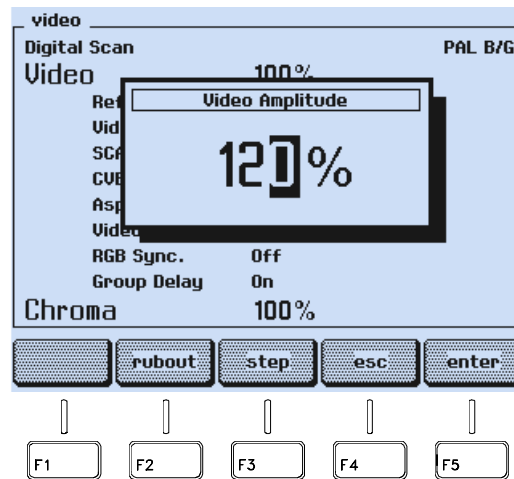

Figure 4-37. Value Input for the Video Amplitude

- If you want to skip your input, press the **esc** softkey (F4).
- Press the **enter** softkey (F5) to confirm your input.

If you key in a value >150%, the display shows the message:

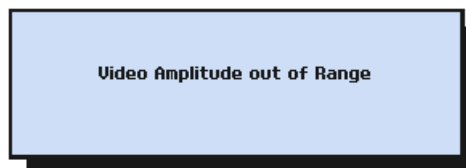

Figure 4-38. Video Amplitude Out of Range Message

- Press the **enter** softkey (F5) for acknowledgment. The instrument returns to the last setting.
- Press the **edit** softkey (F3).
- Key in a value <150 using the numerical keypad.
- Press the **enter** softkey (F5) to confirm your input.

- Press the **enter** softkey (F5) again to return to the **main** screen.

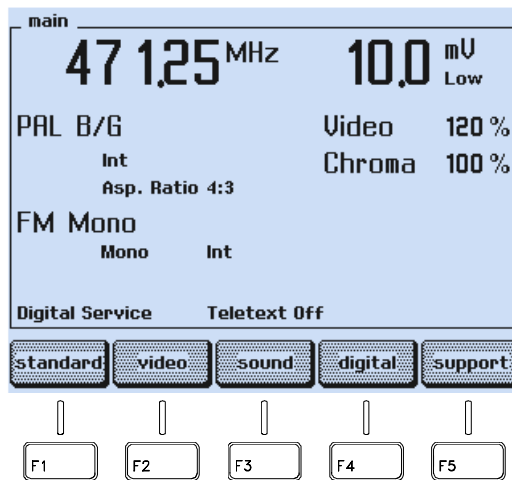

Figure 4-39. Changed Video Amplitude

Step Function

- Select the **video** submenu from the **main** screen.
- Press the **edit** softkey (F3).
- A popup menu for numerical input appears.

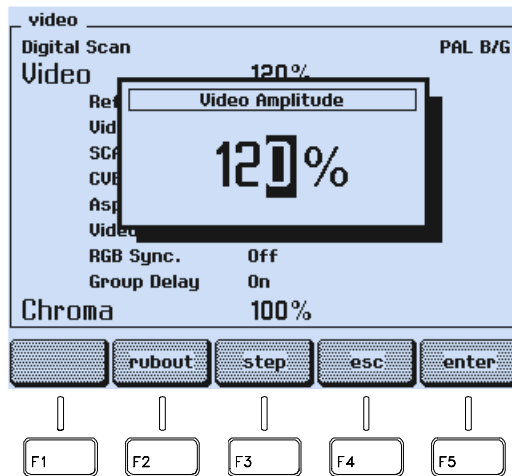

Figure 4-40. Video Amplitude Stepping

- Press the **step** softkey (F3).
- The symbol for the stepping function appears in front of the **Video Amplitude** label.

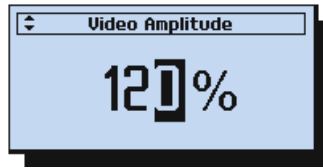

Figure 4-41. Video Amplitude Stepping Function Indicator

- Press the **enter** softkey (F5) to confirm and to return to the **main** screen.
- Press the **▲** or **▼** key to increase or decrease the amplitude in 1% increments. Keeping a key pressed, effects continuous stepping with increasing stepwidth.



Figure 4-42. Video Amplitude Stepping

The stepping function indicator to the right of **Video** shows that the stepping function is selected for the video amplitude.

You can select the stepping function for the:

- Vision carrier frequency
- Vision carrier level / amplitude
- Video amplitude
- Chroma amplitude

You cannot select more than one parameter for the stepping function at the same time.

Chroma Amplitude Setting

You can directly key in a certain value for the chroma amplitude using the numerical keypad or you can change the amplitude stepwise with ▲ and ▼ step keys, if the step function is selected for the chroma amplitude, see Section 'Step Function.'

Numerical Input

- Select the **video** submenu from the **main** screen.

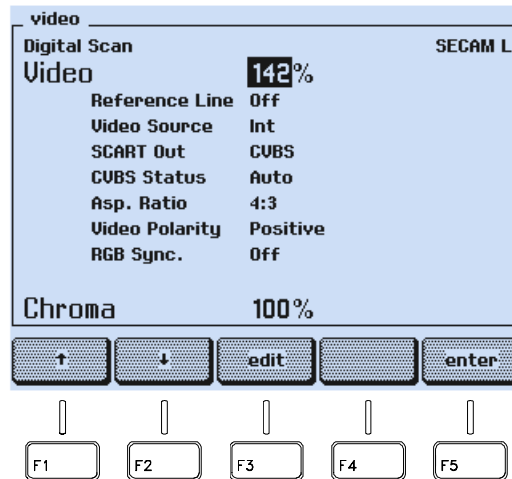

Figure 4-43. Chroma Amplitude Setting

- Press the ▲ or ▼ softkey (F1 or F2) to select the **Chroma** amplitude.
- Press the **edit** softkey (F3).

- A popup menu for numerical input appears.
- Key in the requested value, for example, **1 1 0**. You can also directly key in the value without pressing the **edit** softkey (F3).
- Keyed in digits can be erased with the **rubout** softkey (F2).

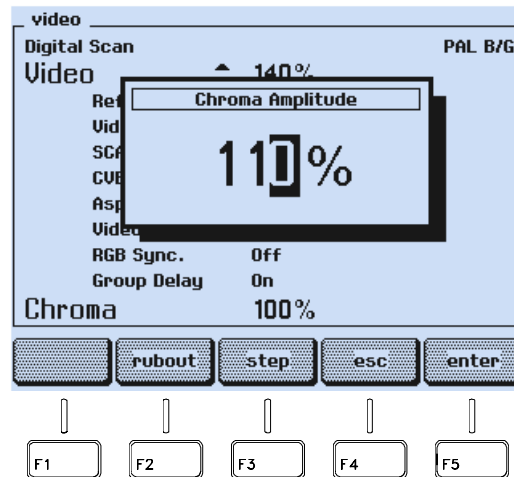

Figure 4-44. Value Input for the Chroma Amplitude

- If you want to skip your input, press the **esc** softkey (F4).
- Press the **enter** softkey (F5) to confirm your input.

If you key in a value >150%, the display shows the message:

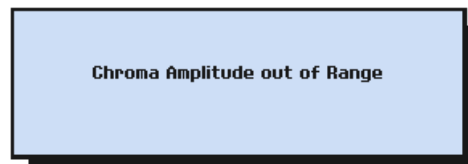

Figure 4-45. Chroma Amplitude Out of Range Message

- Press the **enter** softkey (F5) for acknowledgment. The instrument returns to the last setting.
- Press the **edit** softkey (F3).
- Key in a value <150 using the numerical keypad.
- Press the **enter** softkey (F5) to confirm your input.

- Press the **enter** softkey (F5) again to return to the **main** screen.

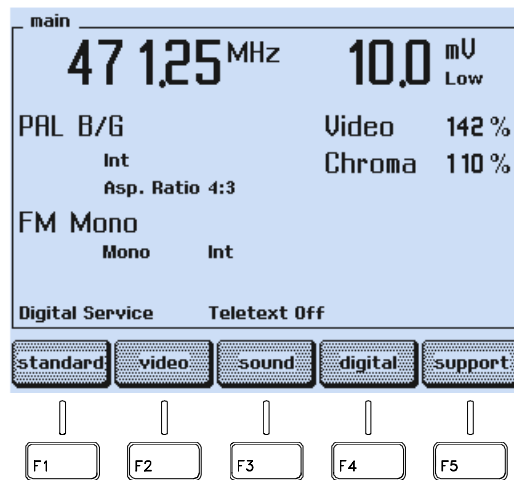

Figure 4-46. Changed Chroma Amplitude

Step Function

- Select the **video** submenu from the **main** screen.
- Press the **↑** or **↓** softkey (F1 or F2) to select the **Chroma** amplitude.
- Press the **edit** softkey (F3).
- A popup menu for numerical input appears.

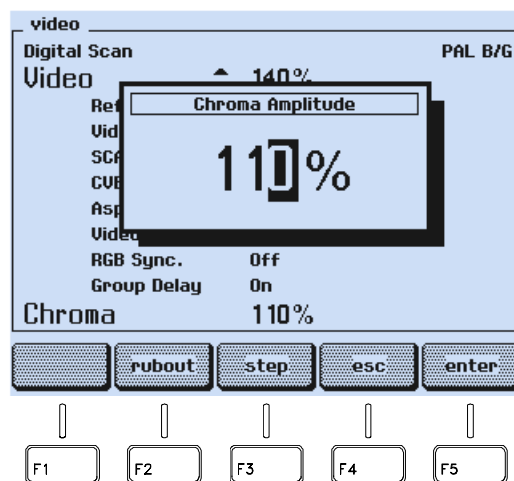

Figure 4-47. Chroma Amplitude Stepping

- Press the **step** softkey (F3).

- The symbol for the stepping function appears in front of the **Chroma Amplitude** label.

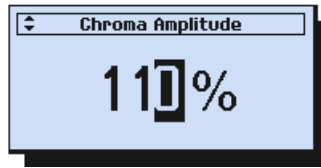

Figure 4-48. Chroma Amplitude Stepping Function Indicator

- Press the **enter** softkey (F5) to confirm and to return to the **main** screen.
- Press the **▲** or **▼** key to increase or decrease the amplitude in 1% increments. Keeping a key pressed, effects continuous stepping with increasing stepwidth.

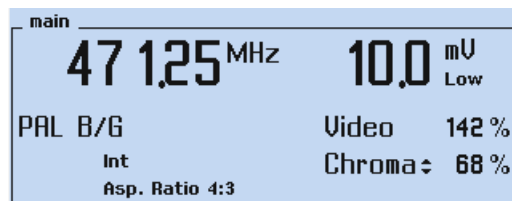

Figure 4-49. Chroma Amplitude Stepping

The stepping function indicator right next to the **Chroma** sign shows that the stepping function is selected for the chroma amplitude.

You can select the stepping function for the:

- Vision carrier frequency
- Vision carrier level / amplitude
- Video amplitude
- Chroma amplitude

You cannot select more than one parameter for the stepping function at the same time.

Test Patterns

You can switch a test pattern on or off by briefly pressing the assigned key in the **PATTERN** field of the keyboard. The LED above the key indicates that the pattern is switched on. Pressing a key longer than one second calls up a popup menu for parameter or additional pattern selection.

The keys **CIRCLE**, **CHECKERBOARD**, **MULTIBURST**, **GREYSCALE**, and **PLUGE** do not call up a popup menu; these patterns can only be switched on or off. You can combine up to four different single patterns. For details, see the topic 'Combined Test Patterns' later in this chapter.

Pattern Selection

- Select the appropriate TV standard and TV system for your TV set.
- Connect the generator to the TV either using video or using RF.
- If you connect using RF, select the same frequency for the TV and the generator. Set the vision carrier level to approximately 60 dB μ V respectively 1 mV. If your TV requests a sound carrier to identify the TV system, set the generator to the corresponding sound system.
- If you connect using video, set the generator to the corresponding video output, for example, Scart.
- Check that the video and chroma amplitudes are set to a sufficient value, for example, 100%.
- Press the requested **PATTERN** key, for example, the **CHECKERBOARD** key.
- The LED above the key lights up and the TV shows the pattern on the screen.

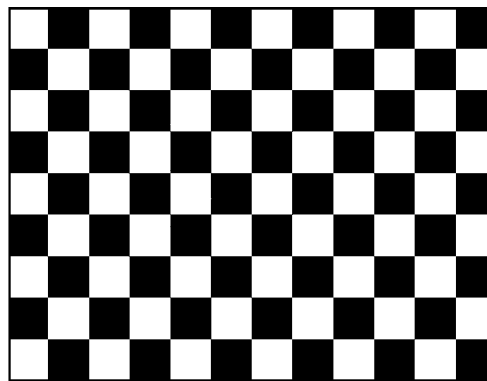

Figure 4-50. Checkerboard Test Pattern

The selected pattern is also indicated in the upper left corner of the **video** submenu display.

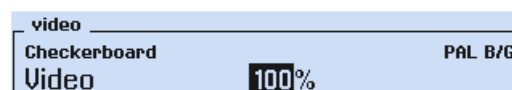

Figure 4-51. Test Pattern Indication

Pattern Combinations

- Select the first pattern, for example the **CHECKERBOARD**, as described before.
- Press the **CIRCLE** key to select the second pattern.
- The LED above the **CIRCLE** key lights up.
- The TV shows the checkerboard and in addition the circle.

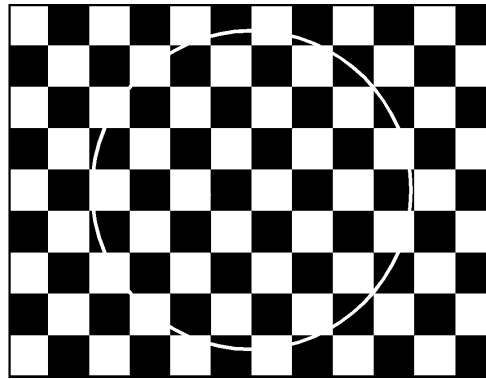

Figure 4-52. Combined Test Pattern

- Press the **CIRCLE** key to switch the circle pattern off.
- Press the **CHECKERBOARD** key to switch the checkerboard pattern off.

For possible combinations, see Section ‘Combined Test Patterns’ in this chapter.

Pattern Parameter Selection

- Press a **PATTERN** key (except the keys **CIRCLE**, **CHECKERBOARD**, **MULTIBURST**, **GREYSCALE**, or **PLUGE**) longer than one second, for example, the **PURITY** key.
- A popup with the selectable purities appears.

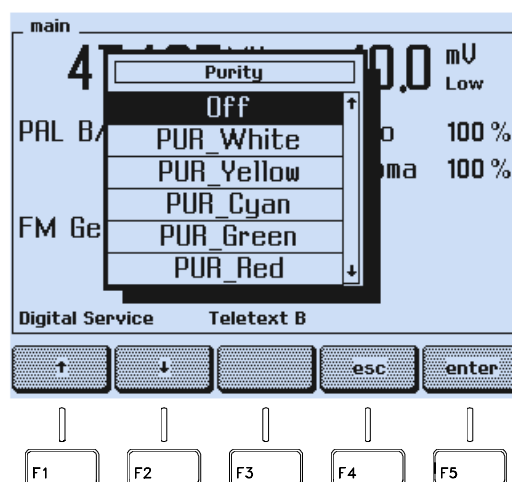

Figure 4-53. Purity Selection

- Press the **↑** or **↓** softkey (F1 or F2) to select the purity, for example, **PUR_Cyan**.
- Press the **enter** softkey (F5) to confirm your selection.

This setting is stored for the purity key function until you select a different purity using the popup menu. Pressing the **PURITY** key briefly toggles between purity off and the selected purity cyan.

This operating principle applies to all keys which can call up a popup menu:

- **CENTER CROSS**
- **DOTS**
- **CROSSHATCH**
- **WHITE**
- **DEM**
- **PURITY**
- **COLOR BAR**
- **COLOR TEMP**
- **VCR**
- **DIGITAL SCAN**
- **DIVERSE**

For details about the parameters and patterns you can select using popup menus, see Appendix G.

Pressing the **COLOR TEMP** key calls up a popup menu which enables access to three other popup menus:

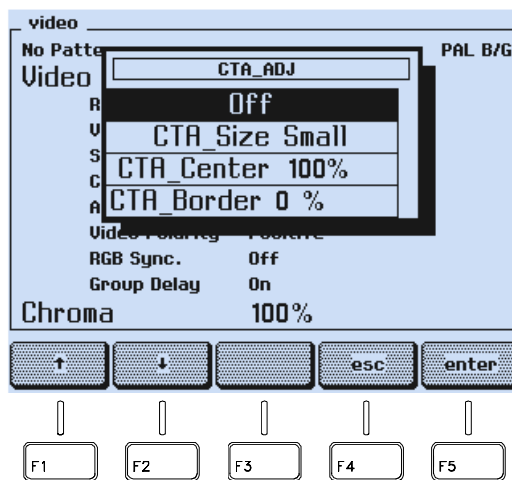

Figure 4-54. Color Temperature Pattern Parameter

- Press the **↑** or **↓** softkey (F1 or F2) to select, for example, **CTA_Size Small**.
- Press the **enter** softkey (F5) to confirm your selection.

- An additional popup menu appears to select the center size for the pattern.

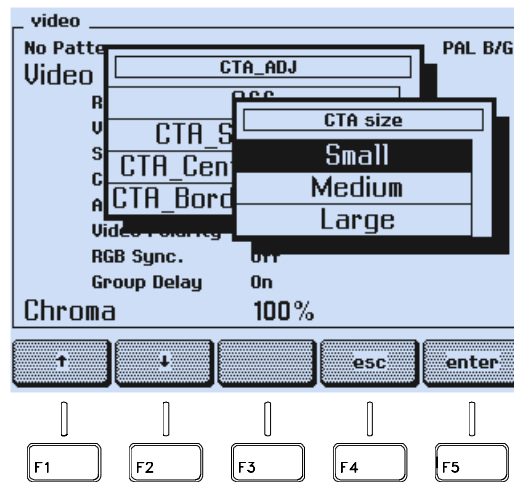

Figure 4-55. Center Size Selection

- Press the **↑** or **↓** softkey (F1 or F2) to select the size, for example, **Medium**.
- Press the **enter** softkey (F5) to confirm your selection.

The instrument returns to previous selected submenu.

- Press the **COLOR TEMP** key again longer than one second.
- The **CTA_ADJ** popup menu appears again.
- Press the **↑** or **↓** softkey (F1 or F2) to select the next parameter you want to change, for example, the luminance for the center, **CTA_Center 100%**.
- Press the **enter** softkey (F5) to confirm your selection.
- An additional popup menu appears to select the luminance level for the center of the pattern.

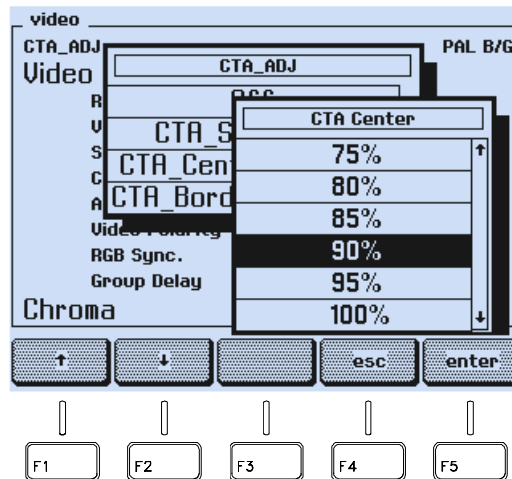

Figure 4-56. Luminance Level Selection

- Press the **↑** or **↓** softkey (F1 or F2) to select the luminance value, for example, 90%.
- Press the **enter** softkey (F5) to confirm your selection.
- Repeat the steps for the third parameter, the luminance level for the border.

For details about all selectable parameters for this pattern, see Appendix G.

Storing and Recalling of Settings

Ninety-nine complete instrument settings can be stored in the non-volatile memory registers 1 to 99.

When you switch off the instrument, the current settings are automatically saved separately.

After power on, the instrument runs through its start routine, and then goes to the mode that was last set.

Storing of Instrument Settings

To store your preferred settings, set the instrument to the mode you want to save, for example:

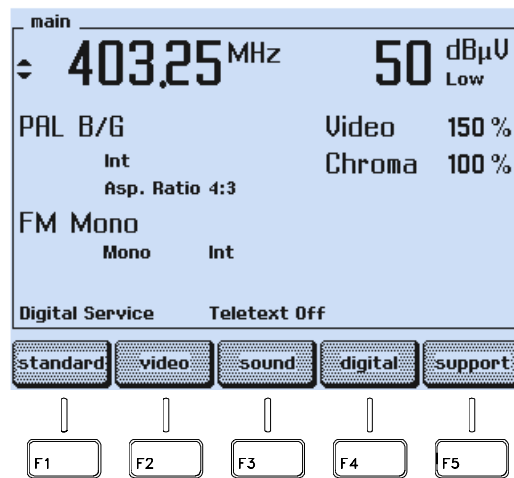

Figure 4-57. Settings to be Stored

- Press the **STORE** key.
- A popup menu appears, showing the last used memory register.

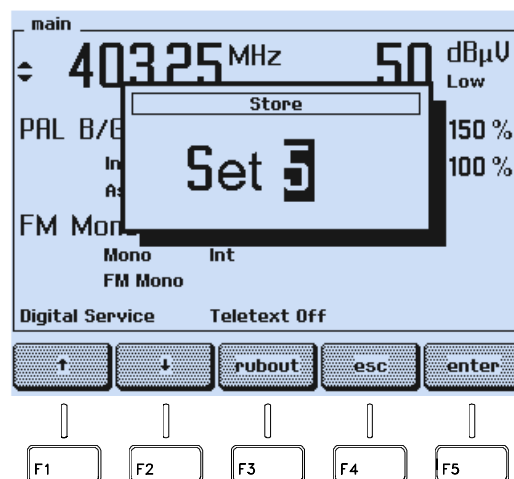

Figure 4-58. Last used Memory Register

- Key in the register number using the numerical keypad you want to store your settings. You can also use the **↑** or **↓** softkey (F1 or F2) to select the register number. Note that the current memory contents will be overwritten.
- Keyed in digits can be erased with the **rubout** softkey (F3).

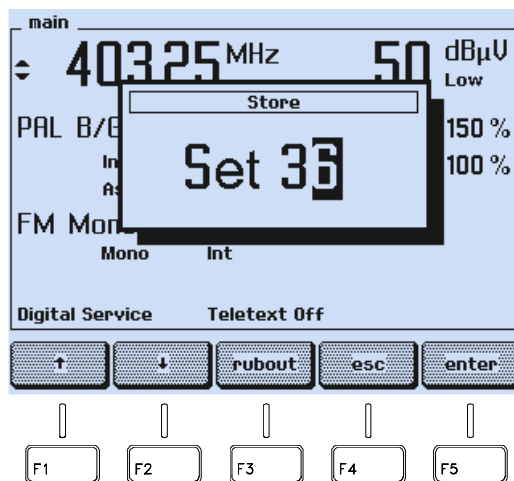

Figure 4-59. Input of Memory Register Number

Remark: Already stored data in the register will be overwritten.

- If you want to skip your input, press the **esc** softkey (F4).
- Press the **enter** softkey (F5) to confirm your input.

The instrument settings are now stored under the selected register number.

Recalling of Instrument Settings

- To recall stored settings, press the **RECALL** key.
- A popup menu appears, showing the last used register.

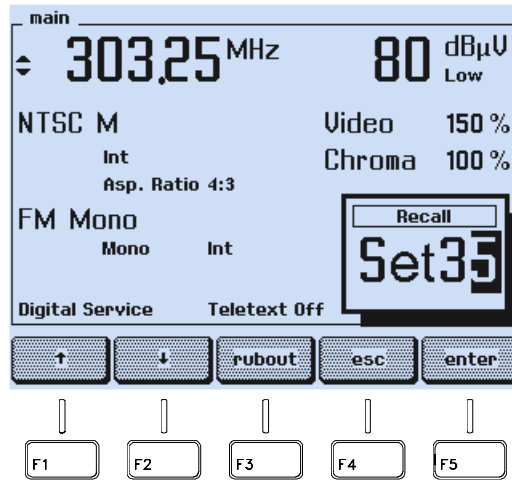

Figure 4-60. Memory Register of Stored Settings

- Use the **↑** or **↓** softkey (F1 or F2) to scroll through the register numbers. The instrument shows the stored settings in the selected register on the display.

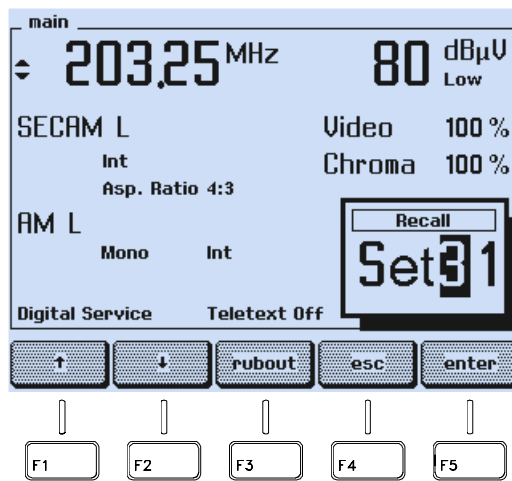

Figure 4-61. Memory Contents Scrolling

- You can also key in the requested memory location number using the numerical keypad, for example, **34**.
- Keyed in digits can be erased with the **rubout** softkey (F3).

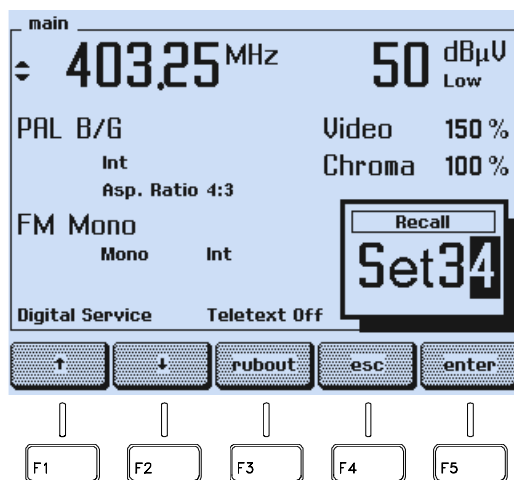

Figure 4-62. Numerical Input of Memory Register Number

- If you want to skip your input, press the **esc** softkey (F4).
- Press the **enter** softkey (F5) to confirm your input.

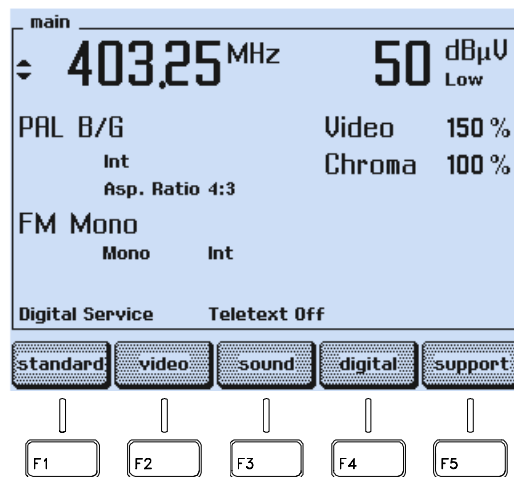

Figure 4-63. Recalled Instrument Settings

The instrument executes the displayed recalled settings.

In addition to the 99 settings individually stored, you can call up register number 0. Register 0 contains default settings, listed in Chapter 6, Section '*RST Reset Command'.

Digital Data and Text

Programmed data and text for PDC, VPS, and WSS are stored in separate memories, see Chapter 5.

If you store the instrument settings, **you automatically store the selected mode into the memory register** for the instrument settings, for example, **PDC Data Set 4 on, not the data itself.**

If you recall a setting, you also recall the stored PDC, VPS, or WSS mode. The instrument calls up, for example, **PDC Data Set 4 on.** For the PDC data set contents, the instrument uses the last stored data in the separate PDC memory.

That means, if you program a certain contents for **PDC Data Set 4**, store the instrument settings in register 30, program a different contents for **PDC Data Set 4**, store the instrument settings in register 35, you will get the same PDC data set 4 contents (the last stored) when calling up memory register 30 or register 35.

Description and Applications of the Test Patterns

The Fluke 54200 TV Signal Generator provides 16 basic test patterns. Most of these are provided in different versions. It is also possible to combine several test patterns. The test patterns are used for checking and alignment of monochrome and color television sets, VCRs, and video equipment. Colored and B/W patterns are available. Every test pattern is available in 16:9 and 4:3 aspect ratio format. The following description and suggestions show how the test patterns can be applied to full advantage.

Where primary color signal levels for the test patterns are mentioned, for example 100/0/75/0, these levels are according to ITU Rec. 471-1/1994. For further information, see Appendix E, 'Nomenclature of Color Bar Signals.'

Overview of Test Patterns

For pattern abbreviations shown in the pattern popup menus, see Appendix G.

Single Test Patterns

- **Circle**

- **Center Cross**
Black Center Cross with 2% overscan indications, white background
Black Center Cross with 3% overscan indications, white background

- **Dots**
White Dots on black background
Black Dots on white background

- **Crosshatch**
White Crosshatch on black background
Black Crosshatch on white background
Top Left (TL) indication and color burst ON/OFF

- **Checkerboard**

- **White**
Selectable white level

- **Multiburst**

- **Greyscale**

- **DEM (Demodulator Test)**
DEM 1, different patterns for TV systems PAL, NTSC, and SECAM
DEM 2, different patterns for TV systems PAL, NTSC, and SECAM

- **Purity**
Eight patterns with colors: Red, Green, Blue, Magenta, Yellow, Cyan, Black, and White.

- **PLUGE**

- **Color Bar**
Full Field Color Bar, different primary color signal levels
Split Field Color Bar, 75% or 100% white
SMPTE Color Bar
Horizontal Color Bar

- **Color Temperature**
3 different windows with selectable luminance level for center and border

- **VCR Test**
VCR 1
VCR 2
Standard Resolution Test
High Resolution Test
Writing Current Adjustment

- **Digital Scan Test**
ADC Check 1 and 2
Moving Block
Progressive Scan Check 1 to 3

- **Diverse**
EHT Test
IRS17

Combined Test Patterns:

- **Combined with Circle**
- **Twofold Combinations**
- **Threefold Combinations**
- **Fourfold Combinations**

Insertion-Reference Signal (IRS)

Circle

Description:
White Circle on a black background in the screen center.
In the 16:9 format small circles are shown in the corners.
The white circle changes automatically to black when used with the white pattern. The circle can be added with all patterns and combined patterns except Progressive Scan Check 3.

Table 4-1. Circle

	Aspect Ratio			
	4 : 3		16 : 9	
	Line System		Line System	
	625	525	625	525
Level Y				
• White	100%	100 IRE	100%	100 IRE
• Black	0%	7.5 IRE	0%	7.5 IRE
Diameter of central circle				
• Horizontal	34.23 μ s	34.52 μ s	25.33 μ s	25.63 μ s
• Vertical, field 1/ field 2	line 42/355 to line 291/603	line 34/297* to line 249/511*	line 42/355 to line 291/603	line 34/297* to line 249/511*
Position of center of circle				
• Horizontal, after start of line sync	36.52 μ s	35.63 μ s	36.52 μ s	35.63 μ s
• Vertical, field 1/ field 2	line 167/479	line 142/404*	line 167/479	line 142/404*
Diameter of corner circles				
• Horizontal			6.15 μ s	6.15 μ s
• Vertical, field 1/ field 2: Upper circles	-	-	line 42/354 to line 102/415	line 35/297 to line 86/349
Lower circles			line 231/543 to line 291/604	line 197/459 to line 248/511
Position of center of corner circles				
• Horizontal, after start of line sync, left circles	-	-	16.10 μ s	15.26 μ s
• Horizontal, after start of line sync, right circles			56.90 μ s	56.07 μ s
Vertical, upper circles, field 1/ field 2			line 72/385	line 61/323*
Vertical, lower circles, field 1/ field 2			line 261/574	line 223/485*

*subtract 3 lines for PAL M

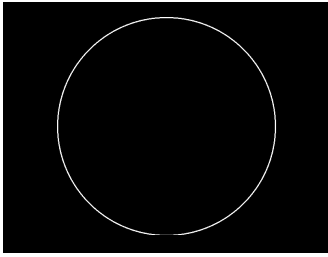

Figure 4-64. Circle, Aspect Ratio 4:3

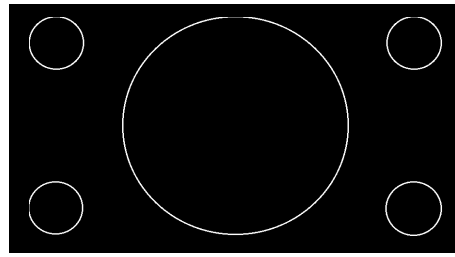

Figure 4-65. Circle, Aspect Ratio 16:9

Applications:

Circle on a black background is suited for checking the overall linearity and geometry of the screen of a monitor or TV. The white circle on black is useful for checking reflections. In 16:9 Aspect ratio format small circles are present in the corners of the screen to check and adjust the geometric distortion of the complete 16:9 screen.

Center Cross with Border Castellations

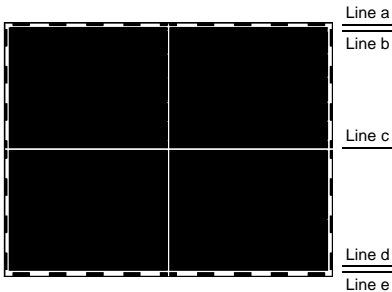

Figure 4-66. Center Cross, Aspect Ratio 4:3

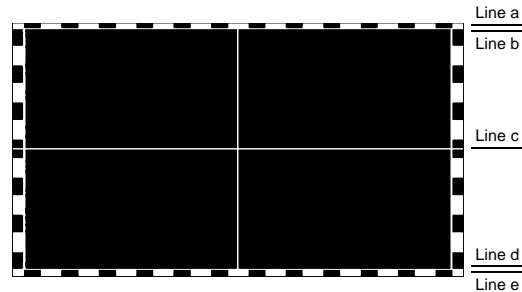

Figure 4-67. Center Cross, Aspect Ratio 16:9

Description:

This B/W pattern with color burst offers a white or black center cross with black/white or white/black (respectively) border castellations on a selectable background. The center cross is black on a white background but changes to white when a different background color is selected, for example, combination with purity. 2% or 3% overscan indications are selectable. The primary color signal levels are 100/0/75/0 for 625 line systems and 100/7.7/75/7.5 for 525 line systems. Further details and timing of the pattern are shown below.

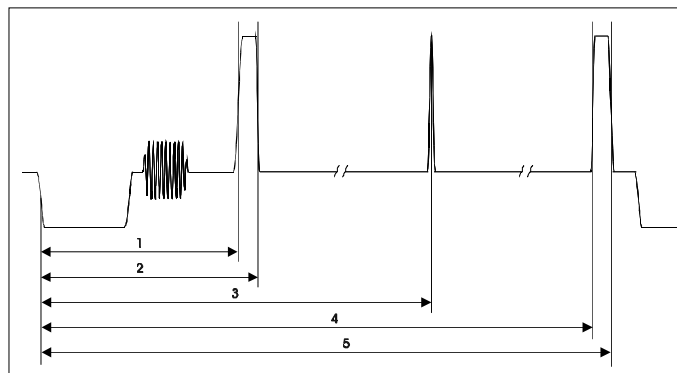

Figure 4-68. Center Cross, Timing

Table 4-2. Center Cross

	Aspect Ratio			
	4 : 3		16 : 9	
	Line System		Line System	
	625	525	625	525
Overscan indication	alternating black / white border			
• Horizontal/vertical direction				
Position of border castellations				
• Horizontal direction	2% / 3%	2% / 3%	2% / 3%	2% / 3%
	of active line	of active line	of active line	of active line
Border castellations 2% / 3%:				
Parameter 1	10.5/ 10.5 μs	9.2/ 9.2 μs	10.5/ 10.5 μs	9.2/ 9.2 μs
Parameter 2	11.6/ 12.1 μs	10.2/ 10.7 μs	11.6/ 12.1 μs	10.2/ 10.7 μs
Parameter 4	61.5/ 61.0 μs	61.0/ 60.5 μs	61.5/ 61.0 μs	61.0/ 60.5 μs
Parameter 5	62.5/ 62.5 μs	62.1/ 62.1 μs	62.5/ 62.5 μs	62.1/ 62.1 μs
• Vertical direction	2% / 3%	2% / 3%	2% / 3%	2% / 3%
	of active field	of active field	of active field	of active field
Border castellations 2%:				
Line a: 1. field / 2. field	line 23/ 336	line 21/ 283*	line 23/ 336	line 21/ 283*
Line b, 1. field / 2. field	line 28/ 341	line 25/ 287*	line 28/ 341	line 25/ 287*
Line d, 1. field / 2. field	line 305/ 618	line 259/ 521*	line 305/ 618	line 259/ 521*
Line e, 1. field / 2. field	line 310/ 623	line 263/ 525*	line 310/ 623	line 263/ 525*
Border castellations 3%:				
Line a: 1. field / 2. field	line 23/ 336	line 21/ 283*	line 23/ 336	line 21/ 283*
Line b, 1. field / 2. field	line 31/ 343	line 27/ 290*	line 31/ 343	line 27/ 290*
Line d, 1. field / 2. field	line 303/ 615	line 256/ 519*	line 303/ 615	line 256/ 519*
Line e, 1. field / 2. field	line 310/ 623	line 263/ 525*	line 310/ 623	line 263/ 525*
Position of center cross				
• Horizontal line, line c, 1. field / 2. field	line 167/ 479	line 142/ 404*	line 167/ 479	line 142/ 404*
• Vertical line, Parameter 3	36.52 μs	35.63 μs	36.52 μs	35.63 μs

*subtract 3 lines for PAL M

Applications:

Center Cross is ideal to center TV monitors and TV screens and alignment of picture height/picture width. Furthermore, it is used to check the deflection linearity and the pin-cushion correction. Overcan indications allow precise adjustment of the wanted picture size. Blurred shown vertical lines point to a bad frequency response and multiple lines may be the result of reflections.

Dots

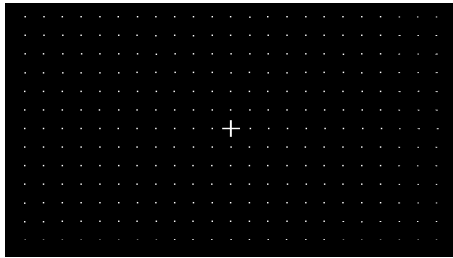

Figure 4-69. Dots, Aspect Ratio 16:9

Description:

Dots is a full field B/W pattern with white dots on a black background with additional center indication. For further details, see table below. The pattern can be switched over to black dots on a white background by selecting **Dots_Black** in the Dots popup menu.

Applications:

This pattern is used for checking and adjusting the static convergence. The screen should contain pure white dots. The presence of colored dots points to faults in focusing and convergence. For checking reflections select this pattern with a white background.

Table 4-3. Dots

	Aspect Ratio			
	4 : 3		16 : 9	
	Line System		Line System	
	625	525	625	525
Level Y				
• White	100%	100 IRE	100%	100 IRE
• Black	0%	7.5 IRE	0%	7.5 IRE
Position of center indication				
• Vertical direction	1. field	line 167	line 167	line 142*
	2. field	line 479	line 479	line 404*
• Horizontal direction, after start of line sync pulse		36.52 μs	35.63 μs	35.63 μs

* subtract 3 lines for PAL M

Crosshatch

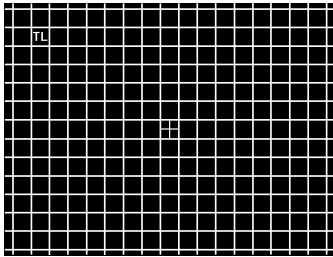

Figure 4-70. Crosshatch, Aspect Ratio 4:3

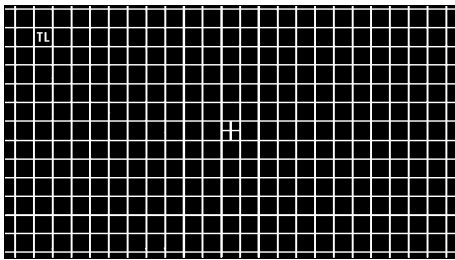

Figure 4-71. Crosshatch, Aspect Ratio 16:9

Description:

Crosshatch is a full field B/W pattern with either 18 (4:3) or 24 (16:9) vertical and 14 horizontal lines. The pattern has a center indication and a selectable top-left (TL) indication. The color burst can be switched off. The background can be changed to white with black crosshatch by selecting **CH_Black** in the Crosshatch popup menu.

Applications:

This pattern is mainly used for checking and aligning dynamic and corner convergence of TVs or monitors. In case of convergence faults the lines are not shown in white but breaking up in the three primary colors RGB. If pincushion correction is needed E/W and N/S adjustments have to be made. Geometric distortions are visible on the screen if the squares of the crosshatch do not have the same size over the whole screen and are not quadratic (linearity). Furthermore the stability of the EHT voltage of a TV can be checked. For details, see Pattern EHT Test, Figures 4-104 and 4-105.

The Crosshatch pattern can be used for the following picture geometry adjustments or settings:

- Horizontal and vertical picture centering
- Horizontal and vertical linearity (S correction)
- Barrel distortion
- Trapezium distortion (keystone distortion)
- Pincushion distortion

Blurred vertical lines point to a bad frequency response. Multiple lines may be the result of reflections or undue tendency to oscillate.

Differences in the brightness of the vertical and horizontal lines point to amplitude faults in the Y channel of a TV. In case mains hum interference in the synchronization occurs this test pattern reveals it.

Table 4-4. Crosshatch

	Aspect Ratio			
	4 : 3		16 : 9	
	Line System		Line System	
	625	525	625	525
Level Y				
• White	100%	100 IRE	100%	100 IRE
• Black	0%	7.5 IRE	0%	7.5 IRE
Position of crosshatch lines				
• Horizontal lines: First horizontal line, field1 / field 2. Distance between horizontal lines	30/342 21	24/287* 18	30/342 21	24/287* 18
• Vertical lines: First vertical line, after start of line sync pulse Distance between vertical lines	12.0 μs 2.89 μs	11.11 μs 2.89 μs	11.85 μs 2.15 μs	10.96 μs 2.15 μs

* subtract 3 lines for PAL M

Checkerboard

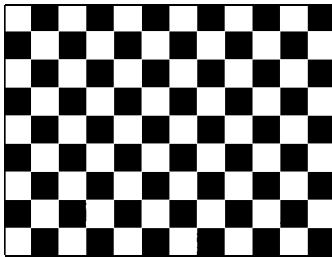

Figure 4-72. Checkerboard, Aspect Ratio 4:3

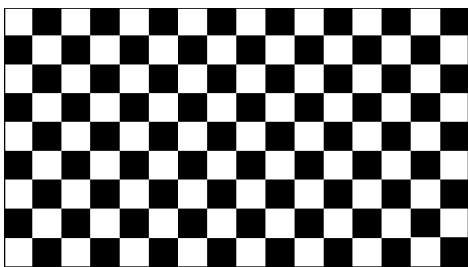

Figure 4-73. Checkerboard, Aspect Ratio 16:9

Description:

Checkerboard is a full field B/W pattern with color burst and comprises nine times twelve (4:3) or nine times sixteen (16:9) squares.

	625 Line Systems	525 Line Systems
Level Y		
• White	100%	100 IRE
• Black	0%	7.5 IRE

Applications:

The checkerboard pattern provides a visual standard for basic picture tube alignments and gives a clear impression of B/W performance of TV or CTV. Any fault, for example, in horizontal or vertical synchronization, deflection or linearity will show up immediately. Bandwidth can be checked by observing the vertical transitions. Transitions from black to white should be sharp. Furthermore, this pattern indicates mains hum interference in the synchronization and no picture interference (Moiré) should occur (sound eventually to be switched off).

White Pattern

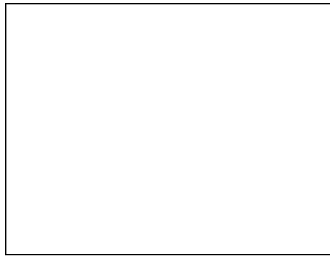

Figure 4-74. White Pattern

Description:

White is a fullfield pattern with color burst.

In 625 line systems the white level is selectable:

Y = 0%, 5%, 15% to 100% in 5% steps.

In 525 line systems:

Y = 7.5 IRE, 15 IRE to 100 IRE in 5 IRE steps.

Applications:

White pattern is designed for a proper white setting and for an overall check of purity. It is also useful for adjustment of the maximum beam current of the picture tube. In addition, the brightness control circuitry test can be carried out.

For videocassette recorders the luminance play back level, the AGC level, and the E-E level (feedthrough signal electronic to electronic) are checked or adjusted by means of the 100% white signal. Furthermore the 'white/dark clip' and the 'white frequency' of the FM modulator are adjusted by this pattern.

For SVHS recorders the white pattern is additionally used as CVBS or Y/C signal to adjust phase corrections (Y and chroma skew levels) or the red and green levels of the RGB decoder.

Multiburst

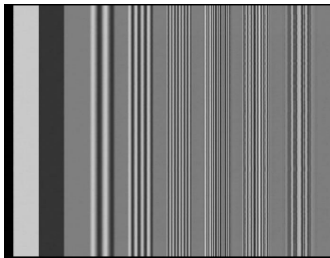

Figure 4-75. Multiburst

Description:

Multiburst contains a reference bar followed by six full screen vertical frequency bursts according CCIR Rec. 473-5. These frequencies are 0.5, 1.0, 2.0, 4.0, 4.8, and 5.8 MHz for 625 line systems. Because of a lower bandwidth for the 525 line systems the upper three frequencies are 3.0, 3.58, and 4.2 MHz.

Applications:

This pattern checks the bandwidth of the video or luminance amplifier in B/W or CTVs as well as the resolution of monitors and video recorders. It can also be used to check or measure the frequency amplitude response. Furthermore, the luminance suppression of the Y/C separator of a SVHS recorder is adjusted by this pattern.

Greyscale

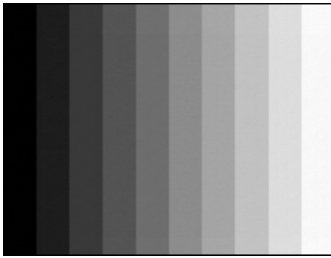

Figure 4-76. Greyscale

Description:

Greyscale with color burst is a full screen linear staircase signal with ten vertical steps from black to white, $Y = 0\%$ to 100% (7.5 IRE to 100 IRE).

Applications:

The Greyscale pattern is used to locate faulty linearity of the video amplifier or greyscale setting. Nonlinearities mainly result in a compression of the white level.

A color receiver should show no color in any of the ten bars. Color here means that the guns of the picture tube are incorrectly adjusted. This pattern is also used when checking the contrast and brightness control.

DEM Pattern

DEM offers two different test patterns: DEM 1 and DEM 2. The signal contents of the DEM patterns depend on the TV system that is selected.

DEM 1 (PAL)

The DEM 1 pattern for PAL has different V and U levels for 625 or 525 line systems and contains four horizontal bars. The luminance is set to 50% for 625 and to 53.8% for 525 line systems. For details, see Figures 4-77 and 4-78.

- The first bar consists of two rectangles. The left part contains V and U color-difference signals and G-Y is zero. The right part is a reference bar with no color information, only 50% luminance (Y signal).
- The second bar consists of four colored squares with color information that is PAL coded. This bar indicates a proper functioning of the color demodulator part.
- The third bar consists of four squares that are color coded (anti-PAL) but should not show any color at a well aligned color television or monitor: The burst signal is PAL coded and checks the operation of the PAL switch in a color receiver. The first and second square contain only V- signals ($U = 0$) while the third and fourth square contain only U- signals ($V = 0$). All four squares should be grey on the screen.
- The fourth bar shows a grey reference bar: $Y = 50\%$ (53.8%) with no color information.

G - Y = 0		Y = 50 %	
Δ V=+0.247	Δ V=-0.247	\square U=+0.247	\square U=-0.247
Δ V=±0.247	Δ V=∓0.247	\square U=±0.247	\square U=∓0.247
Reference Y = 50 %			

Δ U = 0 \square V = 0

- 2 rectangles: colored / grey
- 4 colored squares (PAL coded)
- 4 colorless squares (anti-PAL coded)
- 1 grey square

Figure 4-77. DEM 1 (PAL, 625 Line System)

G - Y = 0		Y = 53.8 %	
Δ V=+0.228	Δ V=-0.228	\square U=+0.228	\square U=-0.228
Δ V=±0.228	Δ V=∓0.228	\square U=±0.228	\square U=∓0.228
Reference Y = 53.8 %			

Δ U = 0 \square V = 0

- 2 rectangles: colored / grey
- 4 colored squares (PAL coded)
- 4 colorless squares (anti-PAL coded)
- 1 grey square

Figure 4-78. DEM 1 (PAL, 525 Line System)

Delay Line Check:

The third bar of this pattern is designed for alignment of the 64 μs chrominance delay in amplitude and phase. 'Venetian blinds' appear when adjustment is needed. It is possible to distinguish between amplitude and phase faults by noting in which square these blinds appear. Since the V signal in square one and two are anti-PAL coded, the delay line and PAL switch should eliminate all R-Y information since this information in successive lines of the first two squares is subtracted.

When an amplitude error exists between direct and delayed signals, the subtractor output of the delay line will produce R-Y information in square one and two. The action of the PAL switch will cause the information to be inverted on alternate lines to give the venetian blind effect.

When a phase error exists between direct and delayed signals, venetian blinds will show up in squares three and four. Additionally, they also will appear in the yellowish horizontal bar (G-Y = 0) of the upper left section of this test pattern.

Demodulator Check:

This pattern can also be used to pick up faults in other important parts of the color TV, the demodulators. The subcarrier frequency should be applied to the R-Y and B-Y demodulators in the correct phase; otherwise, all four squares in the third bar will contain color.

When the phase of the subcarrier fed to a demodulator is correct, the R-Y demodulator will only demodulate R-Y information, and the B-Y unit will only demodulate B-Y information.

When the subcarrier frequency has a phase difference, this results in R-Y information passing the B-Y demodulator in squares three and four. Similarly, the R-Y demodulator could receive B-Y information. Then this will be seen as color information in squares one and two. So a phase error in the subcarrier at both demodulators (that is, a general phase fault) causes both to pass incorrect information. The fault shows up as a color in all four squares.

A phase fault only related to the 90° phase-shifted subcarrier will only cause one demodulator to pass incorrect information. This fault will cause color either in the first two or last two squares, depending on the type of receiver.

DEM 1 (NTSC)

White, Y = 75 IRE	Yellow	Cyan	Green	Magenta	Red	Blue
I = -0.228 Q = 0		Q = +0.228 I = 0				
Y = 53.8 IRE		Y = 53.8 IRE				
White Y = 100 IRE		Black Y = 7.5 IRE				

Figure 4-79. DEM 1 (NTSC)

DEM 1 pattern for NTSC is a B/W and color pattern comprising three horizontal bars:

- Bar 1 consists of a standard color bar with seven colors: White, Yellow, Cyan, Green, Magenta, Red, and Blue. The primary color signal levels are 75/7.5/75/7.5 which equals the first part of the SMPTE color bar.

Bar 2 of this pattern comprises two rectangles. The left-hand side contains I = -0.228 information and where the information on the Q-axis is equal to zero. On the right-hand side Q = +0.228 information is present where the I-axis is equal to zero. With these two areas basically the Q- and I-demodulators of NTSC equipment can be checked.

- Bar 3 contains white level (Y = 100 IRE) and black level (Y = 7.5 IRE). This bar can be used to adjust contrast (difference between white level and black level) and brightness (black level) of the picture.

DEM 1 (SECAM)

Y = 50 % Color Subcarrier (pp) = 161 mV									
W	Y	C	G	M	R	B	Bk	30 / 0 / 30 / 0	
W	Y	C	G	M	R	B	Bk	75 / 0 / 75 / 0	
M	White								75 / 0 / 75 / 0
White Y = 100 %									

W = White, Y = Yellow, C = Cyan, G = Green
M = Magenta, R = Red, B = Blue, Bk = Black

Figure 4-80. DEM 1 (SECAM)

DEM 1 for SECAM is a test pattern divided into six horizontal bars.

- Bar 1 contains a 161 mV chrominance signal with the bell-filter center frequency 4.286 MHz.
- Bar 2 shows a color bar pattern with reduced primary color signal levels 30/0/30/0: White, Yellow, Cyan, Green, Magenta, Red, Blue, and Black.
- Bar 3 and 4 show similar color bars with standard primary color signal levels 75/0/75/0. Bar 3 starts with White, Bar 4 with Magenta.
- Bar 5 shows magenta followed by a 75% reference white.
- Bar 6 shows a 100% reference white.

Applications:

This pattern is sufficient to check and adjust SECAM demodulators, bell filters, and the burst keying.

- Bar 1 is used for bell filter adjustment and checking the demodulator.
- Bar 2 to 4 serves for color representation.
- Bar 5 is used to check the burst keying. When the burst keying is wrong the white area will have color errors.
- Bar 6 serves as standard white pattern.

DEM 2 (PAL)

DEM 2 for PAL is a fullfield pattern and shows four colorless vertical bars that are 'anti-PAL' coded. The V and U levels are different for 625 or 525 line systems. The luminance is set to 50% for 625 and to 53.8% for 525 line systems. For details, see Figures 4-81 and 4-82.

Applications:

This pattern is used for checks and adjustments of the PAL decoding and should not show any color at a well aligned color television or monitor: all four squares should be grey. For further details how to check the delay line or demodulator, see pattern DEM 1 (PAL).

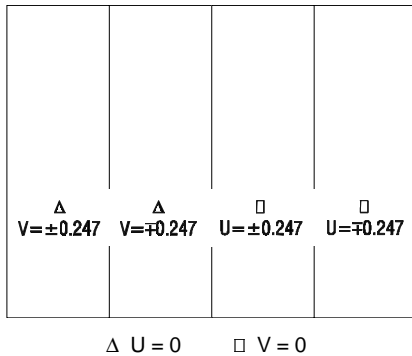

Figure 4-81. DEM 2 (PAL, 625 Line System)

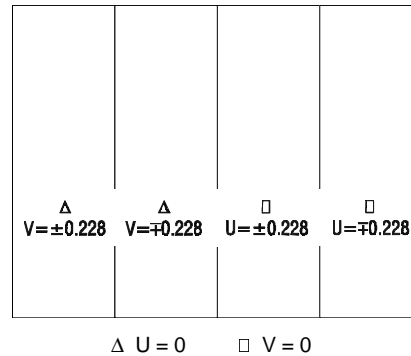

Figure 4-82. DEM 2 (PAL, 525 Line System)

DEM 2 (NTSC)

DEM 2 for NTSC is a color pattern and comprises two horizontal bars:

- Bar 1: +V, -V, +U, and -U vectors, Y = 53.8%
- Bar 2: +I, -I, +Q, and -Q vectors, Y = 53.8%

For further details, see Figure 4-83.

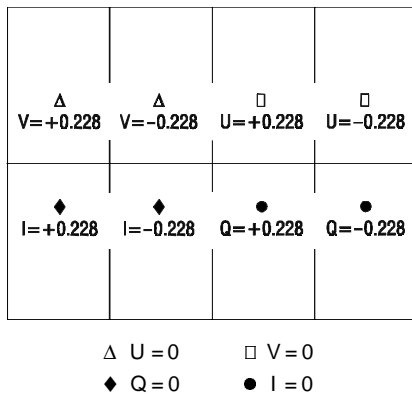

Figure 4-83. DEM 2 (NTSC)

Applications: see DEM 1 (NTSC)

DEM 2 (SECAM)

DEM 2 for SECAM is a full field pattern with a horizontal frequency sweep with 'bell frequency' as center frequency. The luminance is 50% and the chrominance is according to the bell filter shape.

Chrominance subcarrier:

Start frequency 4.033 MHz

Center frequency 4.286 MHz

Stop frequency 4.56 MHz

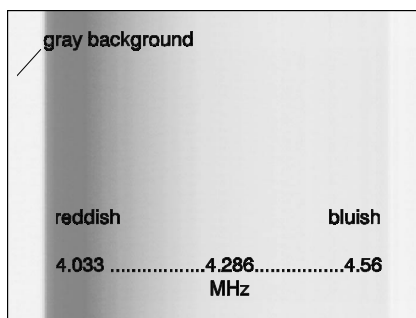

Figure 4-84. DEM 2 (SECAM)

Applications:

Checks and adjustment of SECAM decoders, especially video de-emphasis and bell filters (cloche).

In the receiver, after the antibell filter, the chrominance signal should have the same amplitude in the active video part.

Purity



Figure 4-85. Purity Pattern

Description:

Purity offers eight different full field patterns:

- Primary colors: Red, Green, Blue
- Complementary colors: Magenta, Yellow, Cyan
- Black, White

The primary color signal levels are 100/0/75/0* for 625 line systems respectively 100/7.5/75/7.5* for 525 line systems.

* For details, see Appendix E.

Applications:

The red and green patterns are most frequently used for checking color purity. In a correctly adjusted receiver, each electron beam will strike only one set of color dots or stripes on the screen. If the red pattern is selected only this color should be visible; the presence of any other color is an indication that color purity needs adjustment.

The green pattern provides a purity check for three in-line tubes. In addition the pattern serves as a reference to locate any geometrical distortions in these picture tubes. In the in-line tubes, the guns are in a horizontal position and the green gun is located in the center.

Blue as well as the complementary colors are often used to check the color performance.

These patterns (mainly RED) are used to ensure that there is no interference between the sound and chroma carrier.

The RED pattern with a 75% saturation setting serves for adjustment of the chrominance writing current of VCRs. Often the adjustment of the luminance and chrominance writing current must be carried out together. Furthermore the red pattern is used to adjust the longplay delay level to minimum flicker. Also, comb filters can be adjusted for chrominance subcarrier suppression, for example, 627 kHz for the VHS system.

In addition to the primary and complementary colors 100% white can be selected as well as black pattern with color burst to check, for example, the front and back porch of the synchronization pulses.

Furthermore purity patterns are used for measuring unwanted amplitude and phase modulation of the subcarrier, AM and PM noise as it occurs with VCRs.

PLUGE

Figure 4-86. PLUGE

Description:

The PLUGE signal (Picture Line-Up Generating Equipment) is an international standardized B/W test pattern with color burst according to CCIR Rep. 1221 and comprises three vertical bars on a black background.

Table 4-5. PLUGE

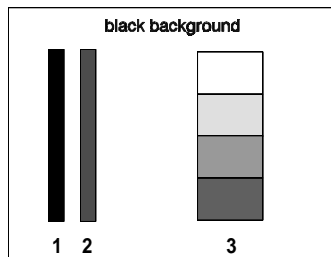
	625 Line System	525 Line System
Background	Y = 0%	Y = 7.5 IRE
Bar 1: ultra black	Y = -1.6%	Y = 4.8 IRE
Bar 2: dark grey	Y = +1.6%	Y = 10.7 IRE
Bar 3: 4 squares:		
white	Y = 100%	Y = 100 IRE
1st grey	Y = 64.3%	Y = 67 IRE
2nd grey	Y = 28.6%	Y = 33.9 IRE
3rd grey	Y = 15.7%	Y = 22 IRE

Applications:

PLUGE is used to perform accurate and consistent line-up of picture monitors. The usual procedure is to adjust the brightness control of a monitor so that bar 1 is invisible on the background while bar 2 can be still distinguished. The white level luminance is mainly adjusted by the contrast control to $70 \pm 10 \text{ cd/m}^2$ by means of the upper 100% white area of the vertical greyscale.

Color Bar

Color Bar offers four different test patterns:

- Full Field Color Bar
- Split Field Color Bar
- SMPTE Color Bar
- Horizontal Color Bar

Full Field Color Bar

The full field Color Bar shows from left to right eight vertical bars for the 625 line systems: White, Yellow, Cyan, Green, Magenta, Red, Blue, and Black. For 625 line systems this pattern offers four selectable primary color signal levels. For further details, see table below.
For 525 line systems the first seven vertical bars are shown; the black bar is not present. Two primary color signal levels are selectable.

Table 4-6. Full Field Color Bar

Display indication	625 Line System	525 Line System
• Level		
COL_75_0	75 / 0 / 75 / 0*	75 / 7.5 / 75 / 7.5*
COL_100_0	100 / 0 / 75 / 0*	100 / 7.5 / 75 / 7.5*
COL_75_25	75 / 0 / 100 / 25*	-
COL_100_25	100 / 0 / 100 / 25*	-

*according to ITU Rec. 471-1/ 1994;
for details, see Appendix E.

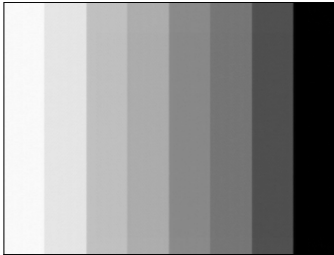

Figure 4-87. Color Bar, 625 Line Systems

Applications:

The color bar pattern in fact provides sufficient information for a good overall check on color performance. This includes the checks on burst keying, subcarrier regeneration, RGB amplifiers, the delay chrominance/luminance and saturation check.

For VCRs this pattern is mainly used for checking the delay chrominance to luminance, saturation, or to adjust the AFC and balance of the chrominance.

For S-VHS recorders the color bar pattern signal is required as CVBS, RGB, or Y/C signal. Checks and adjustments of the RGB encoder or decoder, luminance suppression, and cross luminance suppression of the Y/C separator are realized by this pattern.

Split Field Color Bar

This pattern comprises 2/3 field of the color bar signal and 1/3 field purity pattern. 75% or 100% White Level (WL) is selectable. Amplitudes of the remaining bars are WL/0/75/0 for 625 line systems respectively WL/7.5/75/7.5 for 525 line systems. Any color of the color bar signal is selectable in the lower third part of the screen. The level of the purity part is identical to the color bar part. Select the purity-color first followed by the Split Field Color Bar.

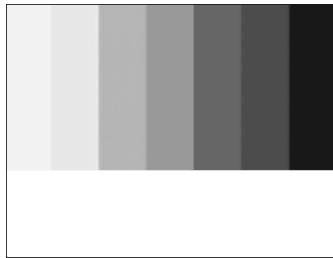

**Figure 4-88. Split Field Color Bar,
525 Line Systems**



**Figure 4-89. Split Field Color Bar,
625 Line Systems**

Applications:

The white bar, for example, is used as reference to adjust the amplitude of the color difference signals with respect to the luminance signal on the picture tube. This signal can be used for aligning the signal amplitude of the demodulators and matrix circuitry, as the output can be compared with the reference bar. For example, the blue and green guns (path) can be switched off to allow the amplitude of the R-Y signal to be adjusted. This is done by ensuring that no difference in brightness is observed between the vertical bars five and six of the color bar and the horizontal reference bar. In a similar fashion, the amplitude of the B-Y demodulator can be determined. After this test, the matrix circuit can be checked with only the green gun switched on. For further applications, see 'Full Field Color Bar' earlier in this chapter.

SMPTE Color Bar

The SMPTE Color Baris according to SMPTE EG 1-1990.
Three horizontal bars comprises:

Bar 1:
Color bar, from left to right:
Grey, Yellow, Cyan, Green, Magenta, Red, Blue.

Bar 2:
Chroma set signal, from left to right:
Blue, Black, Magenta, Black, Cyan, Black, Grey.

Bar 3:
Black set signal.

For further details, see Figure 4-90.

The primary color signal levels are 75/7.5/75/7.5 for 525 line systems respectively
75/0/75/0 for 625 line systems.

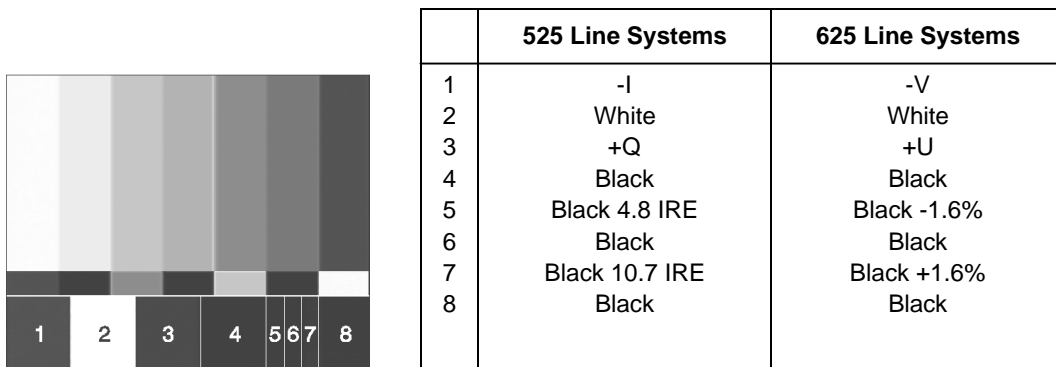

Figure 4-90. SMPTE Color Bar

Applications:

This pattern is intended to standardize the adjustment of chroma gain, chroma phase, and black level monitor controls. The chroma set bar is arranged such below the regular color bars that the blue channel is at full amplitude in both signals at the same time. For correct adjustment of the color reproduction on a monitor, the red and green channels are switched off. The monitor chroma gain is adjusted by matching the brightness of the outer left or right main blue bar with the chroma set bar just below. In a similar way, the chroma phase is adjusted by matching the brightness of either center main blue bar with the chroma set bar just below. The lower PLUGE part of the signal permits adjusting the monitor brightness and contrast. The monitor brightness control is adjusted in a way so that the 'whiter-than-black bar' (7) is visible with respect to the black surround but the 'blacker-than-black bar' (5) is not visible. The color reference signals -I and +Q can be used for phase relationship adjustment by a vectorscope.

Horizontal Color Bar

This pattern shows eight horizontal bars of the color bar signal with primary color signal levels 75/0/75/0 for 625 line systems and 75/7.5/75/7.5 for 525 line systems, (respectively). Beginning from the top:

White, Yellow, Cyan, Green, Magenta, Red, Blue, and Black.



Figure 4-91. Horizontal Color Bar

Applications:

This pattern serves for a quick check of color monitors.

For further applications, see ‘Full Field Color Bar’ earlier in this chapter.

Color Temperature Adjustment

Color Temperature Adjustment is a full field B/W pattern and has a white window with black borders. Three different windows are selectable to meet the size of the tube for the color sensor used in the measuring equipment. Window size **Small** covers 21% of the active picture area while windows **Medium** and **Large** cover 17% with different dimensions. The luminance level of the window and the black border are selectable. For further details, see table below and next page.

Table 4-7. Color Temperature Adjustment

Color Temperature Adjustment	625 Line System	525 Line System
Luminance level • Border part Default setting	$Y_b = 0\%$ $Y_b = 50\%$ $Y_b = 100\%$ $Y_b = 0\%$	$Y_b = 7.5 \text{ IRE}$ $Y_b = 53.75 \text{ IRE}$ $Y_b = 100 \text{ IRE}$ $Y_b = 7.5 \text{ IRE}$
• Center part Default setting	$Y_c = 0\%, 5\%$, $Y_c = 15\%$ to 100% in 5% steps $Y_c = 100\%$	$Y_c = 7.5 \text{ IRE}$, $Y_c = 15 \text{ IRE}$ to 100 IRE in 5 IRE steps $Y_c = 100 \text{ IRE}$
CTA_Size Small (for 14" picture tubes) • Width • Height per frame	21% of active picture area 20.74 μs 304 lines	21% of active picture area 21.04 μs 258 lines

Table 4-7. Color Temperature Adjustment (continuous)

Color Temperature Adjustment	625 Line System	525 Line System
CTA_Size Medium (for 28" picture tubes) <ul style="list-style-type: none"> • Width • Height per frame 	17% of active picture area 32.44 μ s 156 lines	17% of active picture area 33.04 μ s 132 lines
CTA_Size Large (for 36" picture tubes) <ul style="list-style-type: none"> • Width • Height per frame 	17% of active picture area 42.37 μ s 120 lines	17% of active picture area 42.82 μ s 102 lines

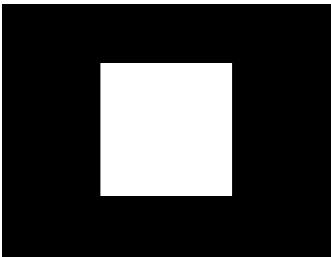

Figure 4-92. Color Temperature Adjustment

Applications:

This pattern is used for checks and adjustments of the standard white of CRTs. Most television systems have standardized on 'Color White D6500 Kelvin' or '3200 Kelvin' as the correct white reference necessary for a natural color reproduction. Three white windows with a different size are selectable to adapt the measurement equipment for picture tubes in the 14" through 36" range.

VCR Test

The VCR test offers five different test patterns which are specially designed to check the bandwidth, linearity, sensitivity, and AGC of the chroma amplifiers in color video recorders. These test patterns are:

- VCR 1
- VCR 2
- Standard Resolution Test
- High Resolution Test
- Writing Current Adjustment
- Parameters are matched to 625 or 525 line systems.

VCR 1

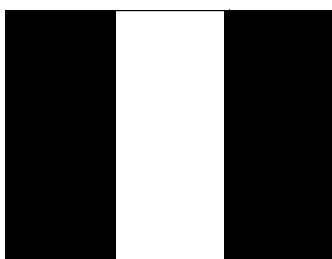

Figure 4-93. VCR 1

VCR 1 is a full field B/W pattern of three vertical bars with color burst and a luminance of 0% respectively 100% (7.5/100 IRE).

Table 4-8. VCR 1

	625 Line System	525 Line System
Position, horiz. direction relative to sync: start/width		
• Bar 1	10.5 / 13.0 μ s	9.2 / 13.2 μ s
• Bar 2	23.6 / 19.5 μ s	22.4 / 19.9 μ s
• Bar 3	43.0 / 19.5 μ s	42.2 / 19.9 μ s

Applications:

This pattern is used for a reflection check or for adjusting the VCR video demodulator to a symmetrical black-and-white jump or opposite.

VCR 2



Figure 4-94. VCR 2

VCR 2 is a combined test pattern and is divided into the following four horizontal bars:

- Horizontal 100% white bar (100 IRE) covering 1/6 field for exact level adjustment.
- A bar covering 1/3 field starting with a reference bar followed by six vertical frequency bursts. For details, see 'Multiburst' pattern earlier in this chapter. This part is used to align the high-pass filter for a maximum resolution in the VCR bandwidth.
- The next part of the pattern contains eight steps of decreasing linear saturation steps of the R-Y signal.
For 625 line systems $U = 0$ and V decreases from 0.44 to 0.
For 525 line systems $Q = 0$ and I decreases from 0.45 to 0.
This part is used to check the chroma amplifier linearity and color AGC circuitry. For example, if the chroma writing current is too high, color will be visible in the last bar where no color should be seen normally.
- The bottom section consists of a black horizontal bar with a white square moving smoothly from left to right to check moving pictures or slow motion function on video recorders. The speed of the moving bar is 4.7 s for one cycle in 625 line systems and 4.0 s in 525 line systems.

Standard Resolution Test

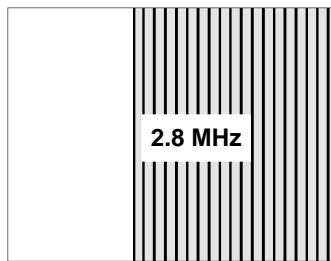

Figure 4-95. Standard Resolution Test

Standard Resolution Test is a full field B/W pattern of two vertical bars with color burst,. The first bar is 100% white followed by the second bar which contains a 2.8 MHz frequency burst.

Applications:

This pattern can be used for VHS recorders to check the resolution of the complete instrument, indicating that the tape deck, and the recording and playback path are proper adjusted.

High Resolution Test

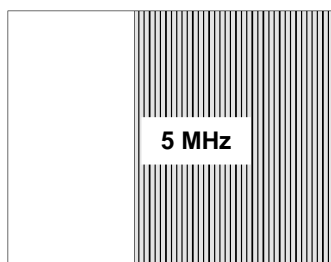

Figure 4-96. High Resolution Test

High Resolution Test is a full field B/W pattern of two vertical bars with color burst, the first bar is 100% white, the second contains a 5 MHz frequency burst.

Applications:

This pattern can be used for SVHS and Hi8 recorders to check the resolution of the instrument, indicating that the tape deck, and the recording and playback path are proper adjusted.

Writing Current Adjustment

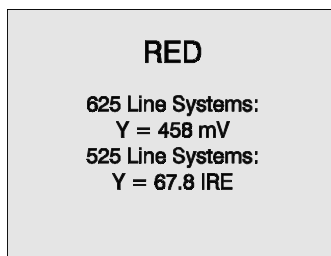

Figure4-97. Writing Current Adjustment

Writing Current Adjustment is a full field red pattern with a special luminance amplitude of $Y = 65.4\%$ ($Y = 458 \text{ mV}$) for 625 line systems and 67.8 IRE ($Y = 485 \text{ mV}$) for 525 line systems and $R = 1; G = B = 0.505$.

Applications:

This pattern is specially designed for the adjustment of the luminance writing current of VCRs.

Digital Scan Test

Digital Scan Test offers six different test patterns:

- ADC Check 1 and 2
- Moving Block
- Progressive Scan Check 1 to 3.

ADC Check 1

ADC Check 1 is a combined B/W and color pattern with eight horizontal bars. The color contents are matched to 625 or 525 line systems.

- Bar 1: Luminance ramp from black to white
- Bar 2: as bar 1 but with swapped MSB/LSB
- Bar 3:

625 Line System	525 Line System
V ramp, U = 0, R - Y = -0.887 to +0.887, Y = 50%	I ramp, Q = 0, I = -0.734 to +0.734 Y = 53.8%

Note: Color Green exceeds the nominal range

- Bar 4:

625 Line System	525 Line System
U ramp, V = 0, B - Y = -0.701 to +0.701, Y = 50%	Q ramp, I = 0 Q = -0.520 to +0.520 Y = 53.8%

Note: Color Green exceeds the nominal range

- Bar 5: Luminance ramp from black to white
- Bar 6: Red ramp, primary color signal level 0% to 100%
- Bar 7: Green ramp, primary color signal level 0% to 100%
- Bar 8: Blue ramp, primary color signal level 0% to 100%

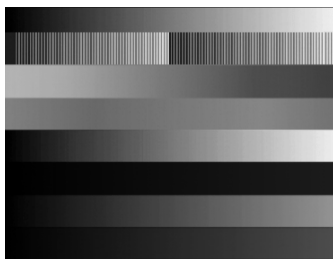

Figure 4-98. ADC Check 1

Applications:

This test pattern is used to check the correct converting of luminance and chrominance signals in the AD converters in modern TV equipment.

ADC Check 2

ADC Check 2 is a combined B/W and color pattern with 15 horizontal bars on a black background. The color contents are matched to 625 or 525 line systems.

- Background: Black
- Bar 1, 4, 7, 10, 13: Luminance ramp
- Bar 2, 5, 8, 11, 14:

625 Line Systems	525 Line Systems
V ramp, U = 0, R - Y = -0.887 to +0.887, Y = 50%	I ramp, Q = 0, I = -0.734 to +0.734 Y = 53.8%

Note: Color Green exceeds the nominal range

- Bar 3, 6, 9, 12, 15:

625 Line Systems	525 Line Systems
U ramp, V = 0, B - Y = -0.701 to +0.701, Y = 50%	Q ramp, I = 0 Q = -0.520 to +0.520 Y = 53.8%

Note: Color Green exceeds the nominal range

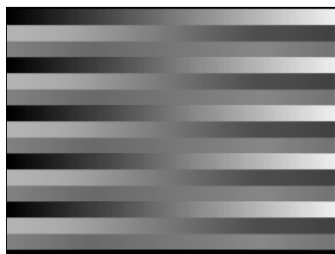

Figure 4-99. ADC Check 2

Applications:

This test pattern is used to check the correct converting of luminance and chrominance signals in the AD converters in modern TV equipment.

Moving Block

Moving Block is a full field B/W pattern with color burst. A vertical white block with $Y = 100\%$ (100 IRE) moves smoothly from left to right on a black background. Duration of one moving cycle is 4.7 s for 625 line systems and 4.0 s for 525 line systems.

This test pattern can be used to check the correct digital video processing, especially AD conversion of modern TV equipment. Moving pictures or slow motion function can be checked on VCRs by the pattern.

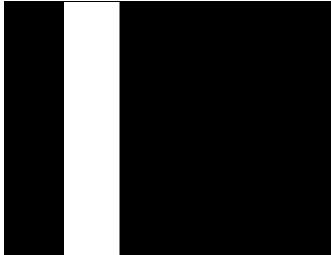
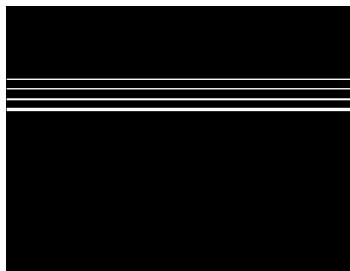

Figure 4-100. Moving Block

Progressive Scan Check 1

This B/W pattern with color burst offers four horizontal white lines on a black background moving in vertical direction from top to bottom. The motion can be switched off at any position of the screen by selecting the **DIGI_SCAN1_S** test pattern. The pattern contains 50 Hz and 25 Hz test signals for 625 line systems respectively 60 and 30 Hz signals for 525 line systems.

The first white line is only present in the first or second field. This will result in a 25 Hz/ 30 Hz test signal. The second horizontal line is composed of a line in the first and second field producing a normal interlaced 50 Hz/ 60 Hz signal. The third and fourth white lines, comprising two TV lines, are combinations of the first two lines.



- A. 1 TV line (one field only)
- B. 1 TV line (1. and 2. field)
- C. 2 TV lines (1 TV line as A and 1 line as B)
- D. 2 TV lines (2 TV lines as B)

Figure 4-101. Progressive Scan Check 1

Applications:

Progressive Scan Check is a special test pattern to test modern Enhanced Definition TV equipment that is commonly used for bigger picture tubes. In these TVs the 50 Hz/ 60 Hz transmitted images are stored, processed and read out with double picture tube scan rate. This process doubles the field frequency and avoids typical 50 Hz/ 60 Hz picture disturbances like image flicker.

For reduction of the line flicker, different video processing techniques, for example Digital Scan, are used in such TV.

This test pattern will be shown differently on a normal or a double scan rate TV receiver. In general, the double scan rate TV will display a stable picture on the screen when using this test signal, while a normal TV set will show a very unstable picture with line and image flicker. Depending on the processing technique of the double scan rate TV receiver the result may differ a little.

Progressive Scan Check 2

This B/W pattern with color burst offers four vertical white lines on a black background moving in horizontal direction from left to right. The motion can be switched off at any position of the screen by selecting the **DIGI_SCAN2_S** test pattern. This pattern contains 50 Hz and 25 Hz test signals for 625 line systems and 60 and 30 Hz signals for 525 line systems.

The first white line of 200 ns is only present in one field. This will result in a 25 Hz or 30 Hz test signal. The second 200 ns vertical line is visible in the first and second field producing a normal 50 Hz/ 60 Hz signal. The third line has a width of 370 ns in one field and 200 ns in the next field. The fourth 370 ns vertical line is identical in both fields.

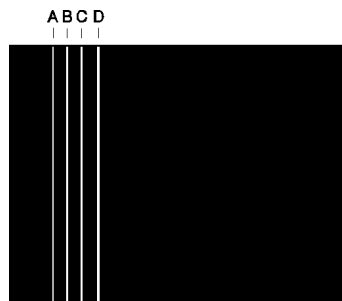

- A. 0.2 μ s, one field only
- B. 0.2 μ s, both fields
- C. 0.37 μ s one field, 0.2 μ s next field
- D. 0.37 μ s both fields

2 μ s distance between each vertical line A to D

Figure 4-102. Progressive Scan Check 2

Applications: See Progressive Scan Check 1.

Progressive Scan Check 3

This B/W pattern with color burst offers five groups of four white lines on a black background alternating in $+45^\circ/-45^\circ$ orientation. The pattern moves in horizontal direction from left to right. The motion can be switched off at any position on the screen by selecting the **DIGI_SCAN3_S** test pattern.

The contents of the four white lines are identical to pattern Progressive Scan Check 2.

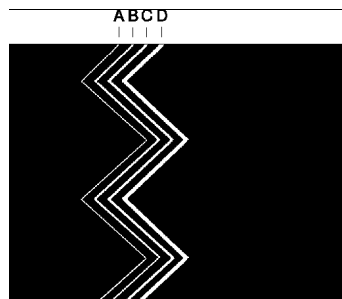

- A. 0.2 μ s, one field only
- B. 0.2 μ s, both fields
- C. 0.37 μ s one field, 0.2 μ s next field
- D. 0.37 μ s both fields

2 μ s distance between each vertical line A to D

Figure 4-103. Progressive Scan Check 3

Applications: See Progressive Scan Check 1.

DIVERSE

The **DIVERSE** key offers two different test patterns:

EHT Test
IRS17

EHT Test

EHT Test is a B/W pattern with white border lines ($Y = 95\%$ or 95 IRE) forming a rectangle with a white window ($Y = 100\%$ or 100 IRE) in the center of the screen on a black background. The window is automatically switched off and on at a frequency of about 4 Hz (625 line systems) or 5 Hz (525 Hz line systems).

Press the **DIVERSE** key to select the **EHT TEST** in the **Diverse** popup menu.



Figure 4-104. EHT Test, Window OFF

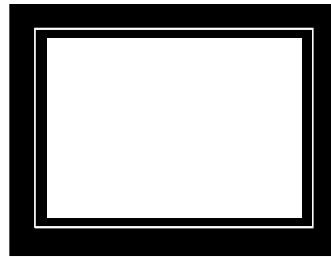

Figure 4-105. EHT Test, Window ON

Applications:

This pattern is specially designed for testing of the EHT (Extremely-High Tension) stabilization in TV receivers and monitors. The outer rectangle should remain the same shape and size when the middle part changes from black to white and vice versa. If this rectangle changes, the EHT is not stable.

IRS17

Description:

The IRS17 test pattern (Insertion-Reference Signal) is generated only for PAL 625 line systems in the visible part of the TV lines. The IRS17 signal is according to EBU Rec. R26-1981 (1995 edition) and serves to detect, measure, and correct distortion in TV signals.

Details IRS17:

- a luminance bar (reference white), amplitude 0.7 V.
- a 2T sine-squared pulse, Half Amplitude Duration (HAD) 200 ns.
- a modulated 20T pulse, HAD 2 μ s.
- a 5 step staircase luminance signal, 140 mV per step.

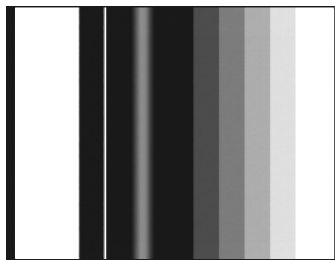

Figure 4-106. IRS17 Test Pattern

The line contents of the IRS17 pattern are identical to the IRS Line 17 signal, see Figure 4-113.

The IRS17 test pattern can be switched on only for all PAL 625 line systems. Press the **DIVERSE** key to select in the **Diverse** popup menu **IRS17**.

Remark:

If you select the Crosshatch pattern without color burst the chroma signal in the IRS17 is also switched off.

Applications:

This signal combination is mainly used as test lines for automatic measurement and monitoring of TV signals. The luminance bar also serves as amplitude reference for automatic level control.

The following distortions can be measured using the IRS17 signal:

- Luminance bar:
distortion, level error, line time waveform, overshoot and rounding.
- 2T pulse:
group delay, amplitude error, pulse distortion, and reflections.
- 20T pulse:
amplitude and delay difference between luminance and chrominance.
- Staircase luminance signal:
static nonlinearity, amplitude nonlinearity.

Combined Test Patterns

You can combine different test patterns to twofold, threefold, or fourfold patterns. Pattern combinations are directly accessible using the pattern keys.

CIRCLE

The white circle can be added to all patterns and pattern combinations except Progressive Scan Check 3. The pattern changes to Black Circle when Purity White or the White pattern is switched on.

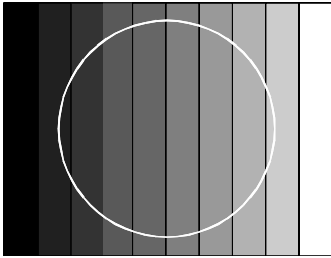

Figure 4-107. Greyscale / Circle

Twofold Combinations of Patterns

CENTER CROSS with border castellations can be combined with:

- CROSSHATCH as standard Crosshatch, but with border castellations
- DOTS as standard Dots, but with additional Center Cross with border castellations.
- PURITY for details, see Center Cross with border castellations

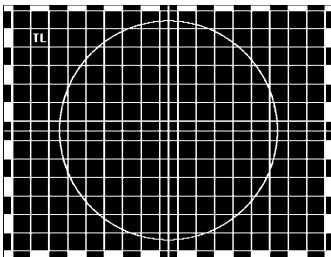

Figure 4-108. Crosshatch / Center Indication / Circle

CROSSHATCH can be combined with:

- DOTS

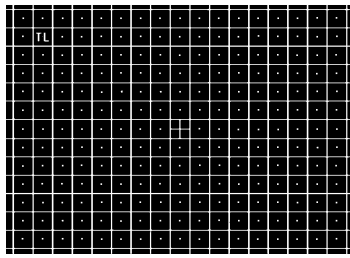

Figure 4-109. Crosshatch / Dots

as standard dots but additionally with Crosshatch

GREYSCALE can be combined with:

- WHITE
- MULTIBURST
- COLOR BAR, vertical full field

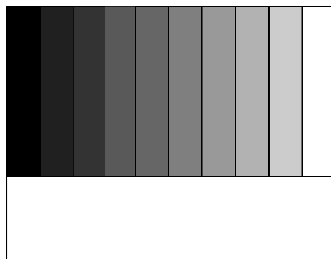

Figure 4-110. Greyscale / White Pattern

4/6 field Greyscale
2/6 field White
3/6 field Greyscale
3/6 field Multiburst
3/6 field Greyscale
3/6 field Color Bar

MULTIBURST can be combined with:

- COLOR BAR, vertical full field

3/6 field Color Bar
3/6 field Multiburst

Threefold Combinations of Patterns

- CIRCLE with all twofold combinations
- GREYSCALE 2/6 field Greyscale
+ COLOR BAR, vertical full field 2/6 field Color Bar
+ MULTIBURST 2/6 field Multiburst
- CENTER CROSS as standard Center Cross,
+ CROSSHATCH but with additional Crosshatch + Dots
+ DOTS

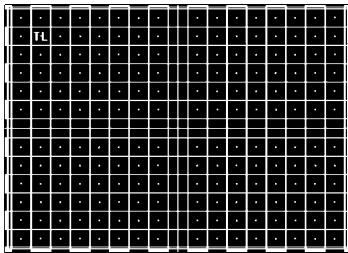

Figure 4-111. Center Cross / Crosshatch / Dots

Fourfold Combinations of Patterns

- CIRCLE combinable with all threefold combinations

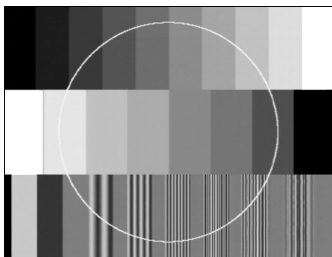

Figure 4-112. Greyscale / Color Bar / Multiburst / Circle

Applications of combined patterns:
 Combined test patterns have the advantage of more complex video information. So the user has a quick overview reference. These patterns are of special interest for applications in production environments or CATVs where the generator is used as a central video signal source. Combined patterns are used for checks, measurements, and adjustments at the same time, for example, the fourfold pattern combination:
 Greyscale + Color Bar + Multiburst + Circle.

For details, see applications of the single test patterns.

Insertion-Reference Signal (IRS)

Description:

The Insertion-Reference Signal (IRS) is available for PAL 625 line systems in the field-blanking interval in the TV line 17 and additionally line 330. The IRS is according to EBU Rec. R26-1981 (1995 edition) and serves to detect and correct distortion in TV signals, so that the program signal may be restored to virtually its original form. This signal is mainly used in television production installations.

Details IRS Line 17:

- a luminance bar (reference white), amplitude 0.7 V.
- a 2T sine-squared pulse, Half Amplitude Duration (HAD) 200 ns.
- a modulated 20T pulse, HAD 2 μ s.
- a 5 step staircase luminance signal, 140 mV per step.

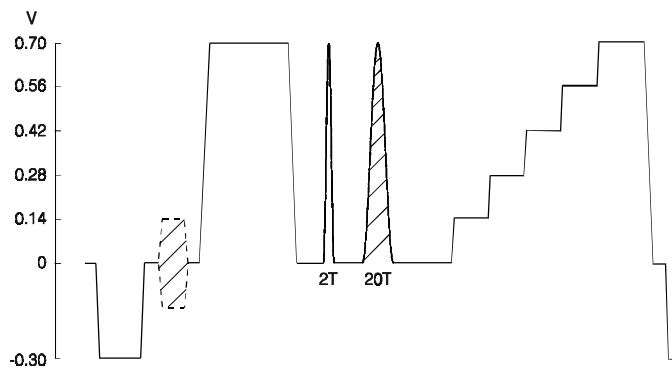

Figure 4-113. IRS Line 17 (PAL 625 Line System)

Operating:

The IRS Line 17 signal can be switched on for all PAL 625 line systems independent of the selected test patterns. The IRS signal, transmitted in the field-blanking interval, is not visible on the TV screen. Select the IRS17 test pattern if the signal should be visible on TV screen.

Switching on IRS Line 17:

- Select the **video** menu.
- Select **Reference Line Off** by the \uparrow or \downarrow softkey (F1, F2).
- Press the **edit** softkey (F3).
The **Reference Line** popup menu appears.
- Select **On** by the \uparrow or \downarrow softkey (F1, F2).
- Press the **enter** softkey (F5).

The IRS signal in TV lines 17 and 330 is switched on. The **video** menu shows **Reference Line On**.

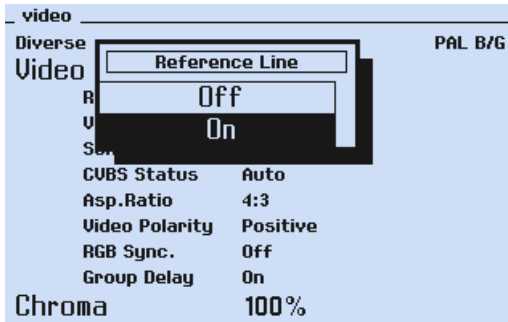

Figure 4-114. Video Menu with Reference Line Popup

Switching off IRS:

- Call up the **Reference Line** popup menu, as described above.
- Select **Off** by the **↑** or **↓** softkey (F1, F2)
- Press the **enter** softkey (F5).

The IRS signal in TV lines 17 and 330 is switched off. The **video** menu shows **Reference Line Off**.

Applications:

This signal combination is mainly used as a test line for automatic measurement and monitoring of TV signals. The luminance bar also serves as amplitude reference for automatic level control.

The following distortions can be measured using the IRS signal:

- Luminance bar: distortion, level error, line time waveform, overshoot and rounding.
- 2T pulse: group delay, amplitude error, pulse distortion, and reflections.
- 20T pulse: amplitude and delay difference between luminance and chrominance. For details, see Figures below.
- Staircase luminance signal: static nonlinearity, amplitude nonlinearity.

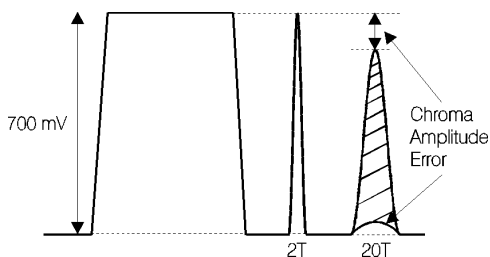

Figure 4-115. IRS 20T Pulse, Chroma Amplitude Error

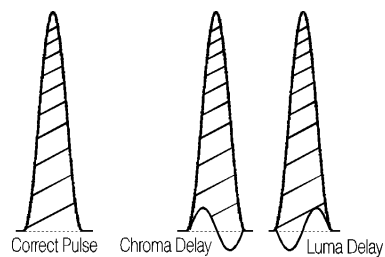

Figure 4-116. IRS 20T Pulse, Delay Error

Chapter 5

Function Reference

Title	Page
TELETEXT.....	5-3
General	5-3
UK-Teletext	5-3
TOP (Table of Pages).....	5-3
FLOF (Full Level-One Features) / FASTEXT	5-5
VPT (Video Recorder Programming by Teletext).....	5-5
Video Recorder Programming by Teletext with PSF	5-7
Contents of Teletext Pages TOP/FLOF	5-9
DIDON ANTIOPE Teletext	5-10
Contents of DIDON ANTIOPE Text Pages	5-10
Operating	5-12
Checking and Adjusting	5-13
Wide Screen Signalling (WSS).....	5-14
General	5-14
Operating	5-15
WSS Auto Mode.....	5-16
WSS Manual Mode.....	5-17
Status Bits Transmission Scheme for Wide Screen Signalling	5-18
Programming the Real Time Clock.....	5-20
PDC and VPS.....	5-22
General	5-22
PDC Description	5-22
Operating	5-23
VPS Description.....	5-26
Operating	5-27
Data Format of Programme Delivery Data in the TV Line 16	5-30
CLOSED CAPTION (CC)	5-32
General	5-32
Operating.....	5-34

Memory Contents.....	5-35
Analog Mono Sound.....	5-38
General	5-38
Operating	5-38
Analog Stereo/Dual Sound.....	5-39
General	5-39
Operating	5-40
NICAM Sound	5-42
The NICAM-728 Transmission Mode	5-42
Operating	5-44
Applications	5-46
Test functions.....	5-46
BTSC Sound	5-48
General	5-48
Definitions	5-50
Operating	5-50
Explanations of BTSC Test Modes.....	5-53
Applications	5-54
Recommendations	5-55
Sound Operating Modes	5-56
External Modulation	5-60
External Video Modulation.....	5-60
Operating	5-61
External Sound Modulation	5-61
Operating	5-63
Synchronization Outputs and Triggering.....	5-64
Operating Hints, Out of Range and Error Messages	5-65
Operating Hints	5-65
Out of Range Messages	5-65
Error Messages.....	5-66
Remote Control Specific Error Messages.....	5-66

TELETEXT

General

Instruments with the Teletext and Wide Screen Signalling (WSS) option offer Teletext B (UK-Teletext, CCIR system B) and Teletext A (France, CCIR system A). Teletext B includes the FLOF/FASTTEXT (Full Level One Feature), TOP (Table Of Pages), and VPT (Video Recorder Programming by Teletext) or PSF (PDC Preselection Function). Teletext A offers the DIDON Antiope Teletext system.

Teletext is an additional information service being offered by many TV broadcasters using the normal TV channels. During distinct lines in the vertical blanking period, the teletext data are serially transmitted and are invisible in the normal picture. The data are stored in the memory of the teletext decoder of the TV or the VCR and can be called up by page number or subject using the remote control. Operation and memory capacity for instruments with teletext have been improved and extended in the last few years.

UK-Teletext

A teletext page consists of a maximum of 24 rows, each of which can contain 40 characters. The first text row, the page header, may contain information such as page number, time, and date. The data transmitted in a TV line correspond to the text row of a page. For transmitting teletext data, 8-bit words are used, consisting of seven information bits and one parity bit.

Teletext information can be transmitted in lines 7 to 22 for the first field, and in lines 320 to 335 for the second field. Fluke 54200 generates the Teletext B in lines 13, 14, 20, 21 and 326, 327, 333, 334 (8 line mode) but can be changed to lines 20, 21, 333, and 334. In the Antiope system the text data are generated only in lines 20, 21, 333, and 334 (4 line mode). For further information about position and levels of a teletext data line, see Figure 5-1.

For TOP and FLOF/FASTTEXT, another menu line, text line 25 at the lower border of the TV screen, is transmitted. For older TVs with teletext but without the TOP/FLOF function, this additional information is ignored.

TOP (Table of Pages)

TOP teletext is an extended teletext service that can be received using a TOP teletext decoder. TOP improves the speed and ease of access to teletext. In Germany most broadcasters transmit the TOP teletext.

The teletext pages are grouped according to subjects. The menu line at the bottom of the screen contains additional information that is selected using the colored keys of the remote control. In some teletext decoders, these teletext pages are stored in memory; so they are immediately available. The special colored keys on the remote control provide the following functions:

Table 5-1. TOP Teletext Remote Control

Key color	Remarks
White (i) = Index page (INDEX)	Survey of pages
Red = -	Leads back to the previous page
Green = e.g. subject block	Leads to the next block
Yellow = e.g. subject group	Leads to the first page of the next group
Blue = +	Leads to the next page

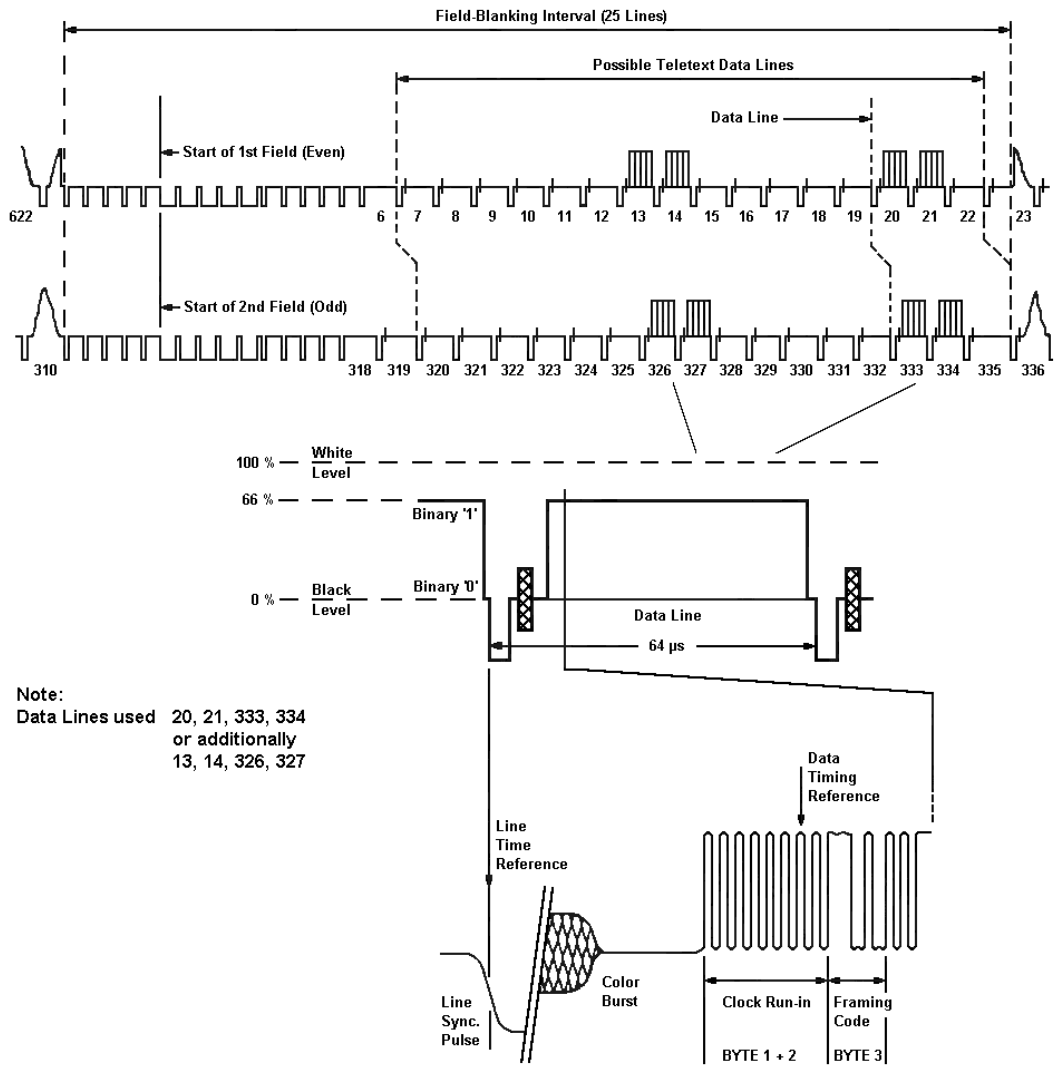

Figure 5-1. Position and Level of Teletext Data Lines

FLOF (Full Level-One Features) / FASTEXT

FLOF/FASTEXT is an extended teletext service that can be received using a FLOF teletext decoder. At the present time, it is transmitted by the British broadcaster BBC and will be introduced in several Western European countries. FLOF/FASTEXT improves the speed and ease of access to teletext.

The teletext pages are grouped according to subject. The menu line at the bottom of the screen contains four additional prompts that can be selected using corresponding colored keys on the TV remote control.

For this the colored keys red, green, yellow, and blue, from left to right, are used. The white key 'i' selects the assigned index page.

In some teletext decoders these teletext pages, shown by the prompts, are stored in memory, so they are immediately available.

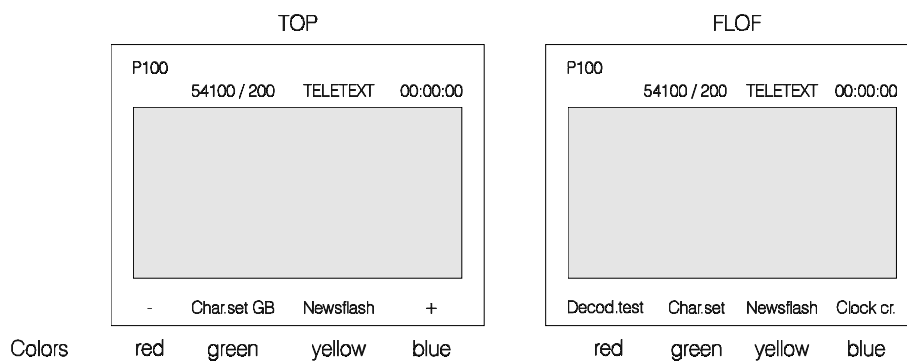

Figure 5-2. Presentation of a TOP or FLOF Teletext Page

VPT (Video Recorder Programming by Teletext)

VPT improves the speed and ease of VCR operation and programming. For this your VCR must be equipped with a Teletext-VPT decoder. For preprogrammed recording, the VCR needs the following data, which must be stored in a TIMER block:

- Date for recording
- Program number of the transmission
- Start/stop time for recording

These data can be copied directly to the VCR from the corresponding program survey of the teletext service.

Fluke 54200 offers in the Teletext B TOP1 and FLOF1 mode a **VPT test facility** on teletext Page 300. This is indicated on Page 300 by **Transport method A**. The page shows the following nine VPT data sets (default setting):

Table 5-2. PDC/VPT Teletext Page 300, Transport Method A

Data Set	Contents/Remarks
1 ... 4	Data sets show scheduled transmission date and time in white and yellow. The concealed VPS data are shown in magenta when the REVEAL key (†) on the TV remote control has been pressed.
5	Special function: No specific PIL value (PIL = Progr. Identification Level)
6	Special function: Timer control code
7	Special function: Recording inhibit
8	Special function: Interruption code
9	Special function: Continuation code

Fluke 54200 without the VPS/PDC option contains fixed VPT data, time, and date on Teletext Page 300, see Figure below.

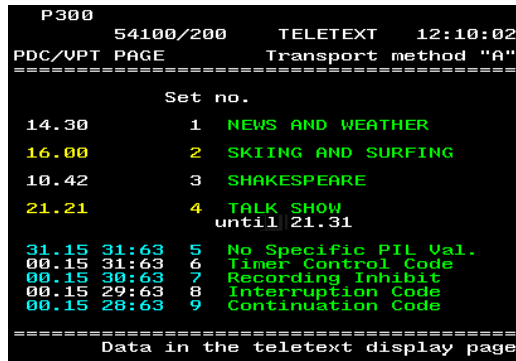

Figure 5-3. Teletext Page 300 with VPT/VPS

Additional for Fluke 54200 with VPS/PDC Option:

The displayed VPT data, time, and date on Page 300 are identical to the contents of the same VPS memory locations 1 to 9. When you have programmed the VPS memory locations 1 to 4 automatically the timer data are changed on Teletext Page 300 if the instrument is in the Teletext TOP1 or FLOF1 mode. The locations 5 to 9 contain fixed data.

For programming VPS, see Page 5-29.

The VCR operating instructions show you how to program the VCR using VPT.

Video Recorder Programming by Teletext with PSF

PSF (PDC Preselection Function) improves the speed and ease of VCR operation and programming. For this your VCR must be equipped with a PDC-teletext decoder. For preprogrammed recording, the VCR needs the following data, which must be stored in a TIMER block:

- Date for recording
- Program number of the transmission
- Start/stop time for recording

These data can be copied directly to the VCR from the corresponding program survey of the teletext service. The PDC Preselection data transmitted using Teletext (not visible in extension packet X/26) automatically enable correct recording of the required program.

Fluke 54200 offers in the Teletext B FLOF2 or TOP2 mode a **PDC test facility** on Teletext Page 300 to check the Preselection Function of a VCR. This is indicated on Page 300 by **Transport method B**.

Page 300 shows the following nine PDC data sets (default setting):

Table 5-3. PDC/VPT Teletext Page 300, Transport Method B

Data Set	Contents/Remarks
1 ... 4	Data sets show scheduled transmission date and time in white and yellow. Preselection data can not be made visible on TV screen because of transmission in the extension packet X/26.
5 ... 9	Special transmission data in white and red with following contents:
5	Special function: No Specific PIL value (PIL = Progr. Identification Level)
6	Special function: Timer Control Code
7	Special function: Recording Inhibit
8	Special function: Interruption Code
9	Special function: Continuation Code

Fluke 54200 without the VPS/PDC option contains fixed PDC data, time, and date on teletext Page 300, see Figure below.

```

P300          54100/200    TELETEXT    12:15:41
PDC/VPT PAGE          Transport method "B"
=====
DD-MM HH:MM    Set
24-12 14:30    1  NEWS AND WEATHER
24-12 16:00    2  SKIING AND SURFING
28-08 14:45    3  SHAKESPEARE
10-10 21:21    4  TALK SHOW
=====
DD-MM HH:MM    Set Special Function
31-15 31:63    5  No Specific PIL Val.
00-15 31:63    6  Timer Control Code
00-15 30:63    7  Recording Inhibit
00-15 29:63    8  Interruption Code
00-15 28:63    9  Continuation Code
=====
Preselection data in packets X/26

```

Figure 5-4. Teletext Page 300 with PSF/PDC

Additional for Fluke 54200 with VPS/PDC Option:

The displayed PDC test data, date, and time on Page 300, are identical to the contents of the same PDC memory locations 1 to 9. When you have programmed the PDC memory locations 1 to 4, automatically the timer data are changed on Teletext Page 300 if the instrument is in the Teletext TOP2 or FLOF2 mode. The locations 5 to 9 contain fixed data, see Table 5-3.

For programming PDC, see Page 5-25.

The operating instructions of your VCR shows you how to program the VCR using PDC.

For PDC it is required to have a real time clock which is offered by 54200. In the Teletext TOP2 and FLOF2 mode the real time clock of the instrument is used for generating the Universal Date and Time (UDT) code in Data Packet 8/30 format 1. Please refer to Page 5-20 how to program the real time clock.

Contents of Teletext Pages TOP/FLOF

The instrument offers different teletext pages with the following contents:

Page	Contents	Remarks/Application
100	Index page	Notice for the selected mode TOP or FLOF
101	Clock cracker	Special bit pattern for checks and adjustments, page update
102	Testpage	Character set, mosaic graphics, color bar, white/black background, reveal function
111	Newsflash	Window in the video picture
150	Subtitle	Window in the video picture
200	Character set GB (U. Kingdom)	Page 200 to 205:
201	Character set D (Germany)	Character set*, graphics, background,
202	Character set S/SF (Sweden)	notes in local language;
203	Character set F (France)	used for checking the different character
204	Character set I (Italy)	sets
205	Character set E (Spain)	
300	TV program page with PDC/VPT** test data	Page 300 serves for easy programming of VCR's using PDC/VPT teletext. TOP1 / FLOF1 = transport method A (VPT) TOP2 / FLOF2 = transport method B (PSF)
400	White picture	Decoder adjustment, RGB signal
401	Color bar	Decoder adjustment, RGB signal
402	Pattern 1	Decoder check, memory test
403	Pattern 2	Decoder check, memory test
555	VIDEOTEXT (written characters)	Presentation
560	COLORS (special color bars)	Decoder adjustment, RGB signal

* The character sets are shown correctly for the indicated languages only if the teletext decoder of the TV offers the West European languages. If the TV has a different decoder, for example, Eastern Europe, the characters generated by 54200 are shown in the corresponding language. The different languages are controlled by the Page Header Control Bits (C12 to C14) of the teletext data. For example, the generated character set of Page 200 is shown by a decoder for Western Europe in British and will be shown in Polish with a decoder for Eastern Europe.

** PDC/VPT test data are only programmable if the instrument has the PDC/VPS option.

DIDON ANTIOPE Teletext

The French teletext system Didon Antiope (Teletext system A) is mainly transmitted in France in the SECAM L system.

As for teletext, the Antiope data are serially transmitted in the vertical blanking period in lines that are not visible on the TV.

While coding of the transmitted text data in the teletext system B is closely related to the structure of the TV signal (one text line is always sent during a TV line), this close connection is not valid for the Antiope system. Start and stop of text pages and text lines are controlled by additional paging and movement codes. Each page consists of 24 rows of 40 characters each (maximum). An additional page header (En-tête de page) may contain information such as page number, time, and date.

The Antiope information can be transmitted in lines 6 to 22 for the first field, and in lines 319 to 335 for the second field.

Fluke 54200 generates the Antiope signal in the lines 20, 21, and 333, 334. For further information about position and levels of a Didon Antiope data line, see Figure 5-5.

Contents of DIDON ANTIOPE Text Pages

Table 5-4. DIDON ANTIOPE Text Pages

Magazine	Page	Contents/Remarks
0	1	Title page (Page de garde), Contents of magazines
96	10	Subtitle, MODE DE SOUS-TITRAGE COMPATIBLE
100	1	Title page (Page de garde), Contents
	250	Character set
	251	Special bit pattern 'Clock cracker'
	252	Pages 252, 253: Special test patterns, for example, double character height, flashing
	253	(FLASH) - corresponds to the Antiope specifications TDF 1984
500	100	ANTIOPE in capital letters (Page de garde)

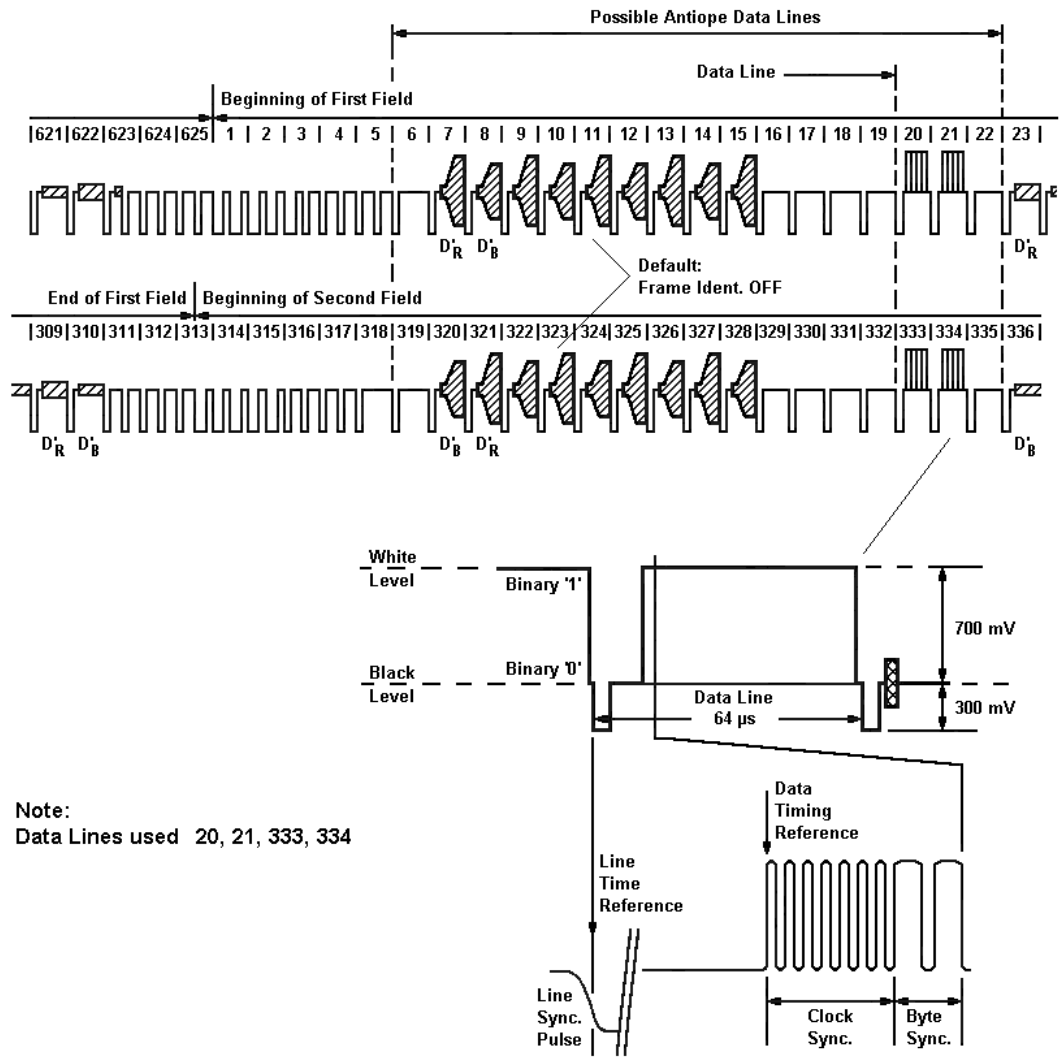

Figure 5-5. Position and Level of Antiope Data Lines

Operating

Different Teletext systems are selectable for 625 line systems.

- Select the wanted Teletext system using the **digital** menu.
- Press the **edit** softkey (F3).
The **TTX System** popup menu appears showing the Teletext systems and modes:

Table 5-5. Teletext Systems and Modes

Teletext System / Modes	Remarks
Teletext B TOP 1	TOP teletext with VPT data on Page 300
Teletext B TOP 2	TOP teletext with PSF data on Page 300
Teletext B FLOF 1	FLOF teletext with VPT data on Page 300
Teletext B FLOF 2	FLOF teletext with PSF data on Page 300
Teletext A ANTIOPE	Teletext used in France
Teletext Auto	Operating mode. For details, see below
CC (Closed Caption)	See Section Closed Caption (CC)
Off	Teletext or CC switched off

- Select the wanted Teletext system by the **↑** or **↓** softkeys (F1 or F2).
- Press the **enter** softkey (F5).
The **TTX Lines** popup menu appears.
- Select **4** or **8** for the wanted number of TV lines in which Teletext data are transmitted. In the ANTIOPE system and for SECAM only 4 lines are selectable.
- Press the **enter** softkey (F5) to confirm your settings.

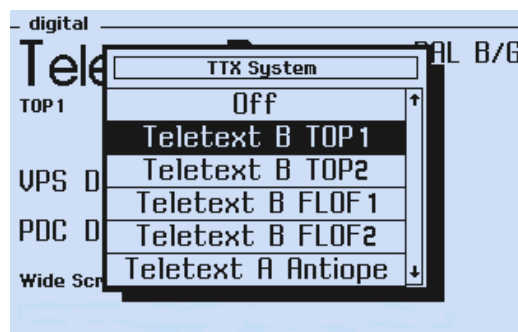

Figure 5-6. Digital Menu, Teletext System Popup

In the **Teletext Auto** mode 54200 automatically selects the correct teletext system to the wanted TV system or country. If the user selects a SECAM system or France the instrument generates the ANTIOPE teletext.

- Select the Teletext mode on your TV. Use a suitable TV with teletext facilities.
The TV will show the Index Page 100, see Figure 5-7.
Further teletext pages are called up by teletext page numbers using the TV remote control, for example, Page 200.



Figure 5-7. Teletext Page 100



Figure 5-8. Teletext Page 200

Checking and Adjusting

The teletext data signal consists of high speed pulses and transients which are sensitive to amplitude and delay distortions, noise, and spurious pulses. The success of a TV receiver to decode the digital data without error depends on the amount of distortions in the total signal path. Teletext data and the analog TV signal are affected in different ways.

Many teletext lines of the 54200 are especially generated for checks and adjustments. Adjustments of teletext decoders depend on the applied components, especially on the built-in integrated circuits. For detailed adjustment procedures of teletext decoders, refer to the appropriate Service Manuals.

Character sets of a teletext decoder can be checked by the teletext pages 200 to 205 (Teletext B). Characters are shown correctly for the indicated languages only if the teletext decoder of the TV offers the West European languages. If the TV has a different decoder the characters generated by 54200 are shown in the corresponding language. Eight different languages are controllable by Page Header Control Bits (C12 to C14) of the teletext data. For example, the character set of Page 200 is shown by a decoder for Western Europe in British and will be shown in Polish with a decoder for Eastern Europe.

Details of character data input decoding for different countries and languages in teletext decoders are shown in data sheets of the supplier, for example, Philips SAA5246A.

Wide Screen Signalling (WSS)

General

The WSS information is transmitted in the first half of line 23 for 625 line systems. The WSS bits are in accordance to the standards ETSI ETS 300294, Rec. ITU-R BT.1119, and EACEM, Technical Committee Working Party Report 3.2. The WSS bits are actually transmitted by all PALplus broadcasters in Europe.

The WSS bits contain information on:

- Aspect ratio range of transmitted signal and its position,
- Position of subtitles,
- Camera or film mode,
- Surround sound,
- Some bits are reserved for future Enhanced Definition TV (EDTV) signalling, for example, PALplus as well as for future use.

The WSS information signal is transmitted as a data burst in Bi-phase modulation coding in the first half of line 23. The preamble contains a run-in and a start code followed by 14 data bits. The data bits are grouped in 4 data groups. For further details, see Figure below and Table 5-7 'WSS Status Bits Transmission Scheme'.

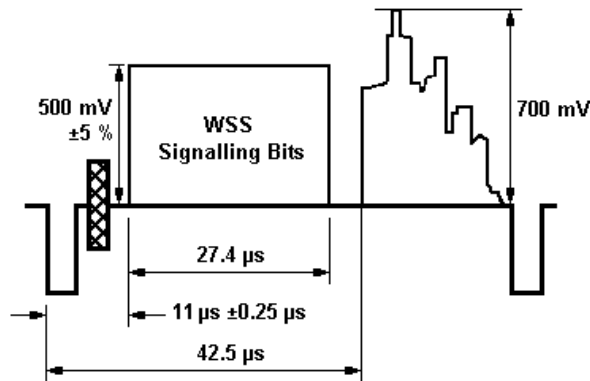

Figure 5-9. Position WSS Signal TV Line 23, 625 Line Systems PAL

Operating

Fluke 54200 with the WSS option transmits the WSS signal in PAL and SECAM 625 line systems. The WSS operating modes are:

Off

Auto

Manual

- Select the wanted WSS mode using the **digital** menu.
- Select **Wide Screen Signalling** by the **↑** or **↓** softkeys (F1 or F2).
- Press the **edit** softkey (F3).
The **Wide Screen Signalling** popup menu appears.
- Select the wanted WSS mode **Auto**, **Manual**, or **Off** by the **↑** or **↓** softkeys (F1 or F2).
- Press the **enter** softkey (F5) to confirm your setting.

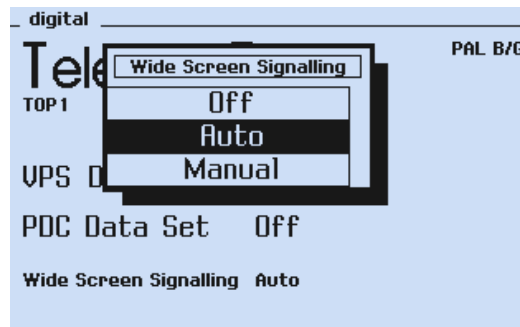

Figure 5-10. WSS Popup Menu

The WSS signal is transmitted in TV line 23 and is not visible on the TV screen.

If **Manual** is selected a popup menu appears. In this menu it is possible to change the WSS bits independently. For details, see Section 'WSS Manual Mode.'

WSS Auto Mode

The WSS information corresponds with the actual instrument settings. For details, see table below. WSS data bits of the WSS Auto mode are not displayed by the instrument.

Table 5-6. WSS Auto Mode

Data Group	WSS Bits	Instrument settings
Group 1,	Bit No.	
Aspect Ratio	0 1 2 3	
Full format 4:3	0 0 0 1	with all 4:3 patterns
Full format 16:9 (anamorphic)	1 1 1 0	with all 16:9 patterns
Group 2,	Bit No.	
Enhanced Services	4 5 6 7	
Camera Mode	bit 4 = 0	with following patterns: Moving Block Progressive Scan Check 1 to 3
Film Mode	bit 4 = 1	with all non-camera mode patterns
Standard PAL / SECAM	bit 5 = 0	always
No Helper	bit 6 = 0	always
Reserved bit	bit 7 = 0	always
Group 3,	Bit No.	
Subtitles	8 9 10	
No subtitles within teletext	bit 8 = 0	no teletext signal is generated
Subtitles within teletext	bit 8 = 1	teletext signals are generated
No subtitles in active image area	bit 9/ 10 = 0	no OSD function is used
Group 4,	Bit No.	
Reserved	11 12 13	
Surround sound signalling bit:		
No surround information	bit 11 = 0	no Stereo signal is generated
Surround mode	bit 11 = 1	Stereo signals are generated
Reserved bits	bit 12 = 0 bit 13 = 0	always always

WSS Manual Mode

In the **WSS Manual** mode the user has the advantage to set the single WSS bits.

- Select the **Wide Screen Signalling** popup menu.
- Select the **WSS Manual** mode
- Press the **enter** softkey (F5).
The **WSS Editor** popup menu appears.
- Toggle the wanted WSS bits by using the **←**, **→**, and **Toggle** softkeys (F1, F2, F3).
- Press the **enter** softkey (F5) to confirm your settings.

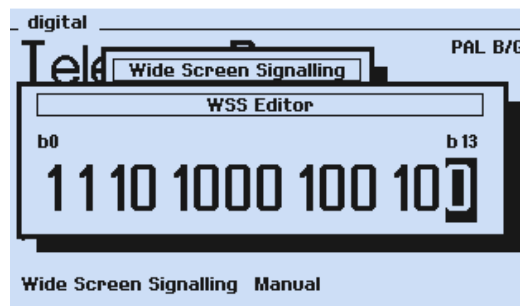

Figure 5-11. WSS Bits Manual Mode

The display shows the 14 bits of the WSS data group 1 to 4, beginning with bit 0 on the left. Each bit can be set to 0 or 1. For detailed programming the WSS bits, see Table 5-7, WSS Status Bits Transmission Scheme.

Figure 5-11 shows an example with the following WSS settings:

Group 1	1110	16:9 pattern
Group 2	1000	Non-camera mode pattern
Group 3	100	Teletext on
Group 4	100	Stereo on

Remark:

The instrument does not check the consistency of the user programmed WSS data.

Status Bits Transmission Scheme for Wide Screen Signalling

Table 5-7. WSS Status Bits Transmission Scheme

Status Bits Transmission			
Insertion: First Half of Line 23		Coding: Bi-phase Modulation Coding	Clock: 5 MHz (T _S = 200 ns)
Run-in	Start Code	Group 1 Aspect Ratio	
29 Elements based on 5 MHz	24 Elements based on 5 MHz	24 Elements based on 5 MHz	
		Bit Numbering 0 1 2 3 LSB MSB per Info Bit ¹⁾ "0" = 000 111 "1" = 111 000	
MSB transmitted first	MSB transmitted first	LSB transmitted first	
0 x 1F1C 71C7 1 1111 0001 1100 0111 0001 1100 0111 MSB LSB	0 x 1E 3C1F 0001 1110 0011 1100 0001 1111 MSB LSB	Bit Number: 0123 0001 Full Format 4:3 1000 Box 14:9 Center 0100 Box 14:9 Top 1101 Box 16:9 Center 0010 Box 16:9 Top 1011 Box > 16:9 Center 0111 Full Format 4:3, Center shoot and protect 14:9 1110 Full Format 16:9, anamorphic b3 = Odd Parity Bit	

Table 5-7. WSS Status Bits Transmission Scheme (cont)

Status Bits Transmission		
Insertion: First Half of Line 23	Coding: Bi-phase Modulation Coding	Clock: 5 MHz ($T_s = 200$ ns)
Group 2 Enhanced Services	Group 3 Subtitles	Group 4 Reserved
24 Elements based on 5 MHz	18 Elements based on 5 MHz	18 Elements based on 5 MHz
Bit Numbering 4 5 6 7 LSB MSB per Info Bit ¹⁾ "0" = 000 111 "1" = 111 000	Bit Numbering 8 9 10 LSB MSB per Info Bit ¹⁾ "0" = 000 111 "1" = 111 000	Bit Numbering 11 12 13 LSB MSB per Info Bit ¹⁾ "0" = 000 111 "1" = 111 000
LSB transmitted first	LSB transmitted first	LSB transmitted first
Bit Number 4: 0 Camera Mode 1 Film Mode Bit Number 5: 0 Standard PAL (SECAM) 1 Motion Adaptive Color Plus (MACP) Bit Number 6: 0 no Helper 1 modulated Helper Bit Number 7: Reserved, should be set to "0"	Bit Number 8: 0 no Subtitles within Teletext 1 Subtitles within Teletext Bit Number: 9 10 0 0 no open Subtitles 1 0 Subtitles in Active Image Area 0 1 Subtitles out of Active Image Area 1 1 Reserved	Bit Number 11: 0 no Surround Sound 1 Surround Mode Bit Numbers 12, 13: Reserved, should all be set to "0"

¹⁾ 1 Info Bit consists of 6 Elements based on 5 MHz Clock. Data Bit Period $T_d = 6T_s$

Programming the Real Time Clock

54200 offers a real time clock which is used for the Teletext B system and PDC (Programme Delivery Control).

- Select the **support** submenu to program the real-time clock.
- Select the Date of the Real Time Clock by the ↓ softkey (F2).
- Press the **edit** softkey (F3).
The **Date** popup menu for numerical input appears.

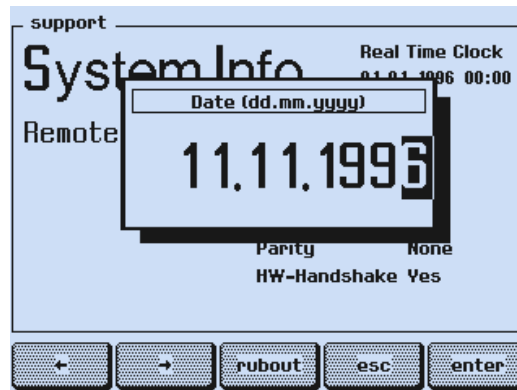

Figure 5-12. Timer Setting with Date

- Key in day (dd), month (mm), and year (yyyy) using numerical keypad.
- Press the **enter** softkey (F5) to confirm.
- Select the Time of the Real Time Clock by the ↓ softkey (F2).
- Press the **edit** softkey (F3).
The **Time** popup menu for numerical input appears.

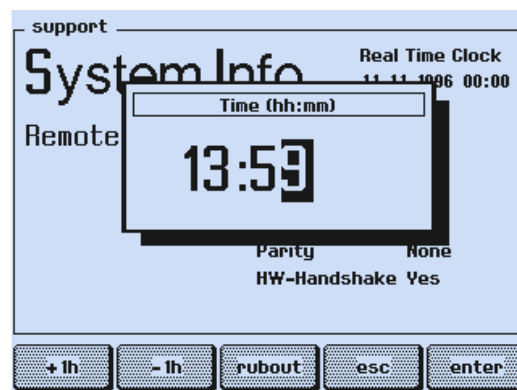

Figure 5-13. Timer Setting with Time

- Key in the actual or wanted time (hh:mm) using numerical keypad.
If you want to change the time for 1 hour (winter/summer time) preferable use the **+1h** or **-1h** softkeys (F1 or F2).

- Press the **enter** softkey (F5) to confirm your setting of the real time clock.

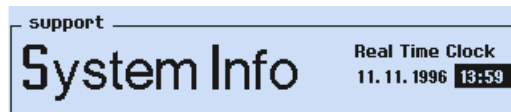

Figure 5-14. Real Time Clock Setting

54200 including the Teletext option:

The modified time is automatically displayed in the TOP or FLOF teletext pages. In the Teletext TOP2 and FLOF2 mode the real time clock is additionally used for generating the Universal Date and Time (UDT) code in Data Packet 8/30 format 1 for PDC (Programme Delivery Control).

Remark:

The actual time shown in the **support** submenu is only updated if this submenu is called up again.

PDC and VPS

General

This section covers operating information for the Programme Delivery Control (PDC) and Video Programming System (VPS).

Fluke 54200 with the PDC and VPS option generates PDC and VPS signals for 625 line systems.

Nine different data sets are selectable using the menu. In PDC as well as VPS, four of these data sets can be programmed by the user. Furthermore PDC offers a 'Multi Labeling' function in the packet 8/30 format 2.

A comprehensive check can be made of all PDC and VPS functions of instruments in development, production, and service.

Since 1985 VPS signals have been transmitted by the German broadcasting stations ARD and ZDF. VPS has also been introduced in Switzerland and Austria.

PDC was introduced into the United Kingdom in 1992. In 1993 it was introduced into the Netherlands. It is planned to introduce PDC into several European countries, including the countries into which VPS has been introduced.

PDC Description

Exact information on the design and contents of PDC can be obtained from the 'EBU specification of the domestic video Programme Delivery Control system (PDC)', EBU SPB 459 Rev. 2.

A general overview is given below:

The PDC data is transmitted in CCIR system B Teletext extension data packets of type 8/30 format 2. For details, see Figure below.

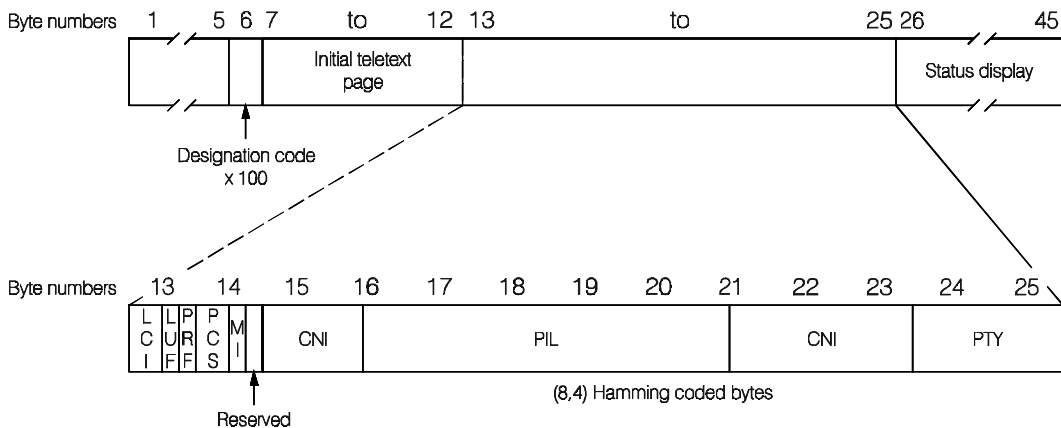

Figure 5-15. Structure of the Teletext Data Packet 8/30 Format 2

PDC is made up of two distinct service components, defined as **Preselection Function (PSF)** and the **Recording Control Function (RCF)**.

The **Preselection Function** for recording control loads the controller memory of the recorder with the information about all programs required to be recorded. The viewer chooses the required programs from television program guides, then enters the relevant information into the recorder. PSF is always active when teletext is selected and is independent from PDC.

The **Recording Control Function (RCF)** allows remote control, from a source of transmission, of a recording made by a receiving equipment capable of preselecting the program to be recorded. Such a function depends on the broadcaster sending a program label in coded form together with the program.

In 54200 the RCF is active as soon as the user selects a PDC data set 1 to 9 in the Teletext B system.

The contents of PDC data sets 1 to 4 can be changed by the user. Data sets 5 to 9 have fixed data and are not programmable.

The instrument offers a special PDC service, the Multi Labelling. In this mode the contents of PDC data sets 1 to 4 is transmitted in four parallel data channels. This is realized by the Label Channel Identifier (LCI) part of the data packet 8/30 format 2.

Operating

Switching on PDC Signal

The PDC signal or data can be switched on or changed only in the Teletext B mode.

- Select the **digital** menu
- Select **PDC Data Set** using the **↑** or **↓** softkeys (F2 or F1).
- Press the **edit** softkey (F3).
The complete PDC data sets 1 to 9 are shown. For details, see Figure 5-17.
- Select the wanted PDC data set by the **↓** softkey (F2), for example, Data Set 7.
- Press the **enter** softkey (F5).

PDC Data Set 7 is switched on. The instrument returns to the **digital** menu.

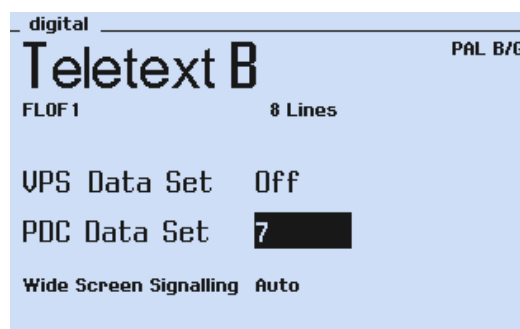

Figure 5-16. Digital Menu, PDC Selection

digital PDC							
	PIL		CNI		PTY	PCS	L L P
Off	dd.mm	hh:mm	cnty.	net		res.	U C R
							F I F
1	24-12	14:30	045	193	255	0	0 0 0
2	24-12	16:00	045	193	255	0	0 0 0
3	21-05	10:42	010	170	170	0	0 0 0
4	10-10	21:21	021	085	85	0	0 0 0
5	31-15	31:63	045	193	255	0	0 0 0
6	00-15	31:63	045	193	255	0	0 0 0
<7>	00-15	30:63	045	193	255	0	0 0 0
8	00-15	29:63	045	193	255	0	0 0 0
9	00-15	28:63	045	193	255	0	0 0 0
Multi							

Figure 5-17. PDC Data Sets 1 to 9, Default Setting

Abbreviations:

- PIL = Programme Identification Label
- CNI = Country and Network Identification
- PTY = Programme Type
- PCS = Programme Control Status (reserved)
- LUF = Label Update Flag
- LCI = Label Channel Identifier
- PRF = Prepare-to-Record Flag
- Net = Network

Showing PDC Program Title

Press the **Page** softkey (F1) to display the PDC Program Title. The default setting is shown in Figure 5-18.

Press the **Page** key again to return to the PDC data.

digital PDC	
PDC program title	
Off	
1	NEWS AND WEATHER
2	SKIING AND SURFING
3	SHAKESPEARE
4	TALK SHOW
5	No Specific PIL Val.
6	Timer Control Code
7	Recording Inhibit
8	Interruption Code
9	Continuation Code
Multi	

Figure 5-18. PDC Program Title, Default Setting

Switching off PDC Signal

The PDC signal generated in the Teletext B mode is switched off by:

- Select the **digital** menu.
- Select **PDC Data Set** using the **↑** or **↓** softkey (F2 or F1).
- Press the **edit** softkey (F3).
- Select **PDC Data Set Off** by the **↓** softkey (upper position in the **digital PDC** menu).
- Press the **enter** softkey (F5).

The instrument returns to the **digital** menu and indicates **PDC Data Set Off**.

If you select a 525 line system the PDC information is automatically switched off.

Changing PDC Data

You can program new PDC data sets 1 to 4. You should have specific knowledge of the relationships and construction of PDC data and Teletext Data Packet 8/30 format 2. The instrument does not check the consistency and correctness of allowed PDC data input. The size of the numerical values for the various parameters is limited by the number of bits provided for this in the PDC code, so that random numbers cannot be entered. The maximum PDC data input values respectively bits are shown in Figure 5-19 in the Data Set 1.

Furthermore you can change the text of the PDC Program Titles for data sets 1 to 4.

The displayed PDC data, date, and time on Teletext Page 300, are identical to the contents of the PDC data sets 1 to 9 if the instrument is set to the **Teletext B FLOF1** or **Teletext FLOF 2** mode. When you have programmed the PDC data sets 1 to 4, the timer data, date, and time are automatically changed.

An example of user programmed PDC data (data set 1) is shown in Figures 5-19 and 5-20.

digital PDC									
Off	PIL		CNI		PTY	PCS	L	L	P
	dd.mm	hh:mm	cnty.	net		res.	U	C	R
							F	I	F
<1>	31-15	31:63	255	255	255	3	1	3	1
2	24-12	16:00	045	193	255	0	0	0	0
3	21-05	10:42	010	170	170	0	0	0	0
4	10-10	21:21	021	085	085	0	0	0	0
5	31-15	31:63	045	193	255	0	0	0	0

Figure 5-19. PDC Data Set 1, User Programmed Data

digital PDC	
PDC program title	
Off	
1	TEST EXAMPLE
2	SKIING AND SURFING
3	SHAKESPEARE
4	IN LOVE WITH HELGA

Figure 5-20. PDC Data Set 1, User Programmed Title

Remark:

PDC data sets 5 to 9 have fixed data and are not programmable by the user.

VPS Description

Exact information on the design and contents of VPS can be obtained from the ARD/ZDF Technical Guideline No. 8R2 'Video-Programm-System (VPS)'.

A general overview is given below:

VPS is similar to PDC. The main difference is that VPS is transmitted in the vertical blanking interval in a dedicated television line (line 16). For details, see Figure 5-21. Transmission is done in biphase code, and the data contains 15 data words of each 8 bit. The transmission rate is 2.5 Mbits.

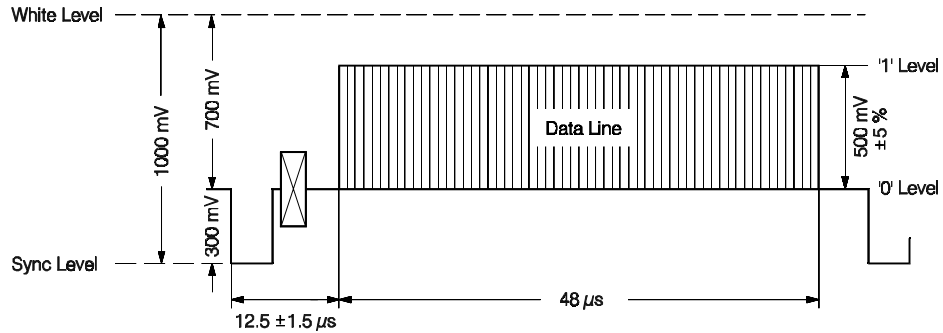

Figure 5-21. VPS Data Line, Line 16 (625 Line Systems)

The first two of the 15 data words are for synchronization of the receiver and for identification of the data line. Words 3 and 4 contain a source identification, which is not relevant for VPS.

Word 5 contains a sound identification (Mono / Dual / Stereo) in 2 bits. The remaining bits are reserved.

Word 6 displays a program-related signal content identification; as is the case for words 7 to 10, it is not relevant for VPS.

Words 11 to 15 with their 40 bits contain the actual VPS information.

Individually the bits signify:

Table 5-8. VPS Information

Bits	Information
0 - 1	Network 2 MSBs
2 - 6	Transmission day
7 - 10	Transmission month
11 - 15	Programme start (hour)
16 - 21	Programme start (minute)
22 - 25	Country
26 - 31	Network remaining 6 bits
32 - 40	Programme Type

In place of the start of a program (date and time), several special codes may also be transmitted.

At present the following codes are available:

- Recording inhibit code:
indicates program not worth recording (for example test pattern).
- Interruption code:
marks desired and undesired program interruptions.
- Timer control code:
indicates that in spite of available data line no valid Programme Labels are transmitted.

Details and Data Format of the VPS Data Line is shown in Table 5-9.

The contents of VPS data sets 1 to 4 can be changed by the user. VPS data sets 5 to 9 have fixed data and are not programmable.

Operating

Switching on the VPS Signal

The VPS signal generated in TV line 16 is available with 625 line systems.

- Select the **digital** menu.
- Press the **edit** key (F3 softkey).
The complete VPS data sets are shown.
- Select the wanted VPS data set by the **↓** key (F2 softkey), for example, **Data Set 7**.
- Press the **enter** key (F5 softkey).

VPS Data Set 7 is switched on. The instrument returns to the **digital** menu.

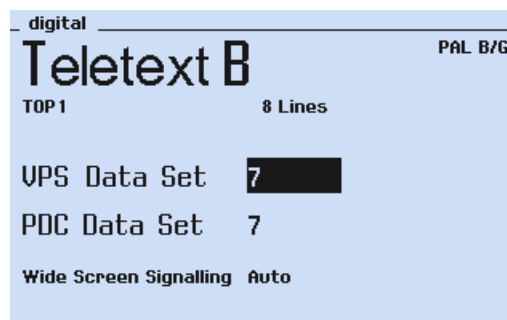

Figure 5-22. Digital Menu, VPS Selection

digital VPS							
	PIL		CNI		PTY	PCS	
Off	dd.mm	hh:mm	cnty.	net		res.	bits
1	24.12	14:30	045	193	255	0	
2	24.12	16:00	045	193	255	0	
3	21.05	10:42	010	170	170	0	
4	10.10	21:21	021	085	85	0	
5	31.15	31:63	045	193	255	0	
6	00.15	31:63	045	193	255	0	
<7>	00.15	30:63	045	193	255	0	
8	00.15	29:63	045	193	255	0	
9	00.15	28:63	045	193	255	0	

Figure 5-23. VPS Data Sets 1 to 9, Default Setting

Abbreviations:

- PIL = Programme Identification Label
- CNI = Country and Network Identification
- PTY = Programme Type
- PCS = Programme Control Status (reserved)
- Net = Network

Showing VPS Program Title

- Press the **Page** key (F1 softkey) to display the VPS Program Title. The default setting is shown in Figure 5-24.
- Press the **Page** key again to return to the VPS data.

digital VPS	
VPS program title	
Off	
1	NEWS AND WEATHER
2	SKIING AND SURFING
3	SHAKESPEARE
4	TALK SHOW
5	No Specific PIL Val.
6	Timer Control Code
<7>	Recording Inhibit
8	Interruption Code
9	Continuation Code

Figure 5-24. VPS Program Title, Default Setting

Switching off the VPS Signal

The VPS signal generated in the TV line 16 is switched off by:

- Select the **digital** menu.
- Select **VPS Data Set** using the **↑** or **↓** softkeys (F2 or F1).
- Press the **edit** softkey (F3).
- Select the VPS Data set **Off** by the **↓** softkey (upper position in the **digital VPS** menu).
- Press the **enter** softkey (F5).

The instrument returns to the **digital** menu and indicates **VPS Data Set Off**.

If you select a 525 line system the VPS signal is automatically switched off by the instrument.

Changing VPS Data

You can program new VPS data sets 1 to 4. You should have specific knowledge of the relationships and construction of VPS data. For details, see Table 5-9. The instrument does not check the consistency and correctness of allowed VPS data input. The size of the numerical values for the various parameters is limited by the number of bits provided for this in the VPS code, so that random numbers cannot be entered. The maximum VPS data input values respectively bits are shown in Figure 5-25 in the Data Set 1. Furthermore you can change the text of the VPS Program Titles for VPS data sets 1 to 4.

The displayed VPS data, date, and time on Teletext Page 300, are identical to the contents of the VPS data sets 1 to 9. When you have programmed the VPS data sets 1 to 4, the timer data, date, and time are automatically changed.

An example of user programmed VPS data (data set 1) is shown in Figures 5-25 and 5-26.

digital VPS						
	PIL		CNI		PTY	PCS
Off	dd.mm	hh:mm	cnty.	net	res. bits	
1	31.15	31:63	255	255	255	3
2	24.12	16:00	045	193	255	0
3	21.05	10:42	010	170	170	0
4	10.10	21:21	021	085	085	0
5	31.15	31:63	045	193	255	0

Figure 5-25. VPS Data Set 1, User Programmed Data

digital VPS	
VPS program title	
Off	
1	UPS TEST
2	SKIING AND SURFING
3	SHAKESPEARE
4	IN LOVE WITH HELGA

Figure 5-26. VPS Data Set 1, User Programmed Title

Remark:

VPS Data Sets 5 to 9 have fixed data and are not programmable by the user.

Data Format of Programme Delivery Data in the TV Line 16

Table 5-9. Data Format of Programme Delivery Data in the TV Line 16

												Time →														
Parameter →					PCS				CNI				CNI				PIL →									
	1	2	3, 4	5							6 to 10				11					12 →						
Byte No. →				1	2	3	4	1	2	3	4					9	10	1	2	3	4	5	6	7	8	9
Parameter Bits b _i , i = →				1	2	3	4	1	2	3	4					0	1	2	3	4	5	6	7	0	1	2
Transmission Bit No. →								M	L							M		L			M	L				
Content →	Clock Run-in	Start Code	Not relevant to PDC	Bits b ₁ and b ₂ : 00 Don't know 01 Mono 10 Stereo 11 Dual Sound Bits b ₃ and b ₄ are reserved				Country Binary				Reserved for enhancement of VPS	Network or Programme Provider Binary	Day Binary					Month Binary							
Reserved Code Values for Receiver Control (Service Codes)	Timer Control Code			N	.	.	N					N	N	0	0	0	0	0	0	0	0	1	1	1	1	
	Record Inhibit/Term.			N	.	.	N					N	N	0	0	0	0	0	0	0	0	1	1	1	1	
	Interruption Code			N	.	.	N					N	N	0	0	0	0	0	0	0	0	1	1	1	1	
	Continuation Code			N	.	.	N					N	N	0	0	0	0	0	0	0	0	1	1	1	1	
	Unenhanced VPS			1	1	1	1					N	N	P.....											
	PTY not in Use			N	.	.	N					N	N	P.....											

Abbreviations: CNI - Country and Network Identification
 PCS - Programme Control Status
 PIL - Programme Identification Label
 PTY - Programme Type

M - Most - Significant Bit
 L - Least - Significant Bit

Table 5-9. Data Format of Programme Delivery Data in the TV Line 16 (cont)

Time →																												
← PIL										CNI						PTY												
← 12					13					14						15												
10	11	12	13	14	15	16	17	18	19	20	5	6	7	8	11	12	13	14	15	16	1	2	3	4	5	6	7	8
3	4	5	6	7	0	1	2	3	4	5	6	7	0	1	2	3	4	5	6	7	0	1	2	3	4	5	6	7
M L					M L					M L			M L			M L												
Hour Binary					Minute Binary					Country Binary			Network or Programme Provider Binary			Programme Type Binary												
1	1	1	1	1	1	1	1	1	1	1	N	N	A	A	A	A	A	A	A
1	1	1	1	0	1	1	1	1	1	1	N	N	A	A	A	A	A	A	A
1	1	1	0	1	1	1	1	1	1	1	N	N	A	A	A	A	A	A	A
1	1	1	0	0	1	1	1	1	1	1	N	N	A	A	A	A	A	A	A
										P			N			A												
										P			N			1 1 1 1 1 1 1 1												

A - Bit Value is that of the current PTY Code
 N - Bit Value is that of the current CNI Code
 P - Bit Value is that of the current PIL Code

CLOSED CAPTION (CC)

General

Fluke 54200 with the Closed Caption option offers Closed Caption (CC) and Text Service (T). Closed Caption is part of the 'Line 21 Data Services'. Exact information on the design and contents of this Data Service can be obtained from the Draft EIA-608 standard 'LINE 21 DATA SERVICES FOR NTSC', the FCC 47 CFR Part 15, and Report No. E-7709-C. The data channel may contain specific types of data packets as Closed Caption, Text Service, and Extended Data Service (XDS). XDS is not supported by the Fluke 54200.

Effective July 1, 1993, all TV broadcast receivers with picture screens 13 inches or larger in diameter shipped in interstate commerce, manufactured, assembled or imported from any foreign country into the United States shall comply with the provisions for Closed Caption.

Captions are program-related data which are transmitted using either field of line 21 of the vertical blanking interval of the television signal. For details, see Figure below.

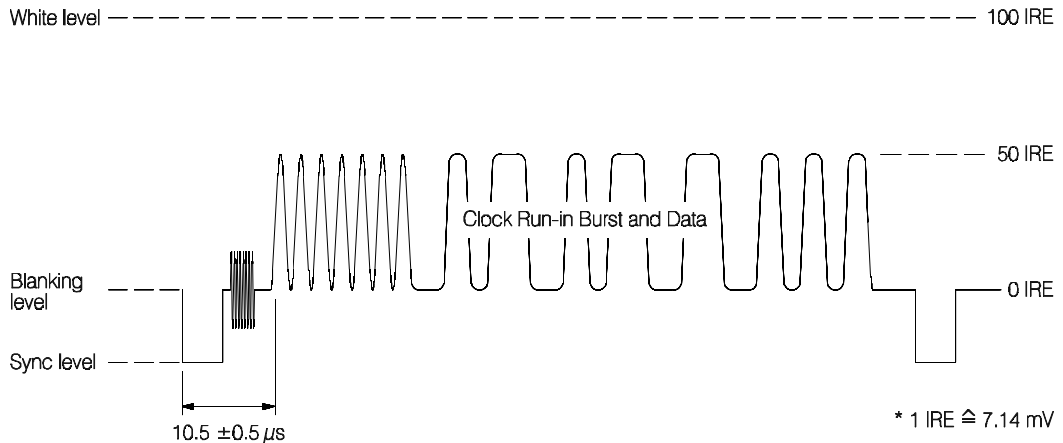

Figure 5-27. Line 21 Data Services, 525 Line Systems

Captions are a visual depiction of the soundtrack of the video program, and as such are timed to correspond to the sound track. Caption data have priority over other data which may be carried on line 21. The CC1 Service offers the primary language while CC3 is used for second language captions. For further details, see Table 5-10.

Text Mode is a data service, generally not program related, which is also transmitted on TV lines 21. The text service should use the channels T1 and T2 if possible but only T3/T4 if T1/T2 is not sufficient. Text data are displayed as soon as they are received.

Table 5-10. Closed Caption Field Packets

Field 1 Packets		Field 2 Packets	
CC1	Primary Synchronous Caption Service	CC3	Secondary Synchronous Caption Service
CC2	Special Non-synchronous Use Captions	CC4	Special Non-synchronous Use Captions
T1	First Text Service	T3	First Text Service
T2	Second Text Service	T4	Second Text Service
		XDS	Extended Data Service (not supported by Fluke 54200)

The television receiver must decode CC1 to CC4 captioning, and must display the captioning for whichever channel the user selects. The TV Mode of operation allows the video to be viewed in its original form. The Caption and Text Modes define one or more areas (boxes) in the screen within which Caption or Text characters are displayed. In Text Mode the information is scrolled upwards through the window if it has been filled.

Caption mode possibilities are as follows:

- Roll-up: 2, 3 or 4 continuous rows,
- Pop-on: maximum of 4 rows, not necessarily continuously, displayed anywhere on the screen. This data will be displayed after receipt of an End of Caption command,
- Paint-on: subsequent data are addressed immediately without the need of an End of Caption command.

In the Fluke 54200 Closed Caption and Text Service are available for the following TV systems:

NTSC, NTSC 4.43, PAL 625 and PAL 525 line systems, and SECAM.

The Caption and Text Data cannot be changed. All memory locations are pre-programmed.

CC Sequence is an automatically continuous sequence of memory locations 1 to 8.

Remark:

During the Closed Caption mode (Line 21 Data Service) Teletext, Wide Screen Signaling (WSS), Programme Delivery Control (PDC), and Video-Programm-System (VPS) are automatically switched off.

Operating

Closed Caption and Text Service are available for the following TV systems:

NTSC, NTSC 4 (subcarrier 4.43 MHz), PAL 625 and PAL 525 line systems, and SECAM.

- Select the **digital** menu.
- Press the **edit** softkey (F3).
The **TTX System** popup menu appears.
- Select **CC Number** respective **CC Sequence** by the **↑** or **↓** softkeys (F1 or F2).
- Press the **enter** softkey (F5).
The **TTX CC Number** popup menu appears.
- Select the requested Closed Caption setup (**CC Number 1 to 8** or **Sequence**).
- Press the **enter** softkey (F5) to confirm your selection.
Closed Caption data are generated in TV line 21.
- Switch on the Closed Caption function of your TV to get it visible on screen.

Select the **TTX System** popup menu to switch off Closed Caption.

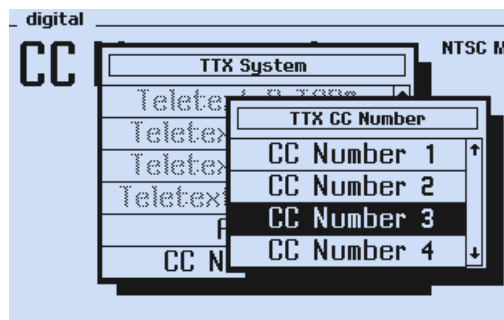

Figure 5-28. Digital Menu with Closed Caption

Memory Contents

CC Number 1: CC1 Service

Description: standard character set; transmitted in field 1; data channel 1; roll-up style.

Characters	Description, Remarks
ABCDEFGHIJKLMNOPQRSTUVWXYZ	Background Blue, Opaque; Text Color Cyan
abcdefghijklmnopqrstuvwxyz	Background Blue, Semi-transparent; Text Color White; Character Type Italics
! , . ; : ' " # % & @ / () [] + - = < > ? \$ % £	Background White, Opaque; Text Color Blue; Character Type Underlined
á â ã ç è é ê ë ì í î ï ñ ò ó ú ® º ™ ½ ¸ , music note, standard space, transparent space, ■	Background White, Semi-transparent; Text Color Red
0123456789	Background Red, Opaque; Text Color Magenta/Black*1 Character Double Size

*1 Black if the optional caption features are supported by the TV-set

CC Number 2: CC2 Service

Description: extended character set; transmitted in field 1; data channel 2; paint-on style.

Characters	Description, Remarks
Spanish: Á É Ó Ú Ü ü ` ` ; * . _ © ™ • ° ~	Background Black, Opaque; Text Color Yellow
French: Â Ã Ç È Ê Ë Ì Í Î Ï Ô Ù Û Ü « »	Background Black, Opaque; Text Color Green
Portuguese: Ã Ä Å Æ Ç È É Ê Ë Ì Í Î Ï Ñ Ò Ó Ô Õ Ö Ø Ù Ú Û Ü Ý Þ à	Background Black, Opaque; Text Color Blue
German: Ä ä Ö ö Æ æ Ç ç È é Ê ê Ë ë Ì í Î î Ï ï Ñ Ò ó Ô õ Ö ö Ø ø Ù ú Ú û Û ü Ý þ à	Background Black, Opaque; Text Color Red
Danish: Å å Ø ø []	Background Black, Opaque; Text Color White

CC Number 3: CC3 Service

Description: a few characters indicating CC3 mode; transmitted in field 2; data channel 1; pop-on style.

Characters	Description, Remarks
Closed Caption CC3 Mode.	Background Green, Opaque; Text Color Cyan;

CC Number 4: CC4 Service

Description: a few characters indicating CC4 mode; transmitted in field 2; data channel 2; paint-on style.

Characters	Description, Remarks
Closed Caption CC4 Mode.	Background Green, Semi-transparent; Text Color Red/Black *1;

*1 Black if the optional caption features are supported by the TV-set

CC Number 5: T1 Service

Description: primary text mode service; transmitted in field 1, data channel 1.

Characters	Description, Remarks
Primary Text Mode Service A Text Mode may be used that consists of data formatted to fill a box which in height is not less than 7 rows and not more than 15 rows (all of which should be continuous), and in width is not less than 32 columns. Text should be displayed over a solid background to isolate it from the unrelated program video.	Background Black; Title Color Yellow, Text Color White

CC Number 6: T2 Service

Description: text mode service; transmitted in field 1, data channel 2.

Characters	Description, Remarks
Text Mode, Service #2 Each row of text contains a maximum of 32 characters. If the solid background does not extend the full width of the screen, at least one solid space equal to a single column width may be placed before the first character and after the last character of each row to enhance legibility.	Background Black; Title Color Yellow, Text Color White

CC Number 7: T3 Service

Description: text mode service; transmitted in field 2, data channel 1.

Characters	Description, Remarks
Text Mode, Service #3 Line 3 Line 4 Line 5 Line 6 Line 7	Background Black; Title Color Yellow, Text Color White

CC Number 8: T4 Service

Description: text mode service; transmitted in field 2, data channel 2.

Characters	Description, Remarks
Text Mode, Service #4 Line 3 Line 4 Line 5 Line 6 Line 7	Background Black; Title Color Yellow, Text Color White

At the start of every data string, commands are present to clear the memory of the CC decoder in the television. The data string is cyclic; at the end of the data string, a clear screen command is present.

The Optional Extended Characters are mostly accented characters. If the receiver does not support these characters, the appropriate character is shown without accent.

Analog Mono Sound

General

The audio signal is FM modulated on the sound carrier signal except for SECAM L, where the sound is AM modulated.

The sound carrier frequency is 4.5, 5.5, 6.0, or 6.5 MHz and depends on the TV system. Broadcasters transmit the sound carrier above the vision carrier except for SECAM L in VHF band I. In this case the sound carrier is transmitted 6.5 MHz below the vision carrier.

The transmitted sound carrier level is 10 to 13 dB below the vision carrier level depending on the TV system (54200 default setting). A pre-emphasis is used for the FM modulation of the audio signal. The frequency spectrum for analog FM-Mono Sound (PAL B/G) is shown in Appendix D.

Operating

Fluke 54200 generates the analog mono sound for all available TV systems. Sound parameters are automatically matched to the selected TV system.

Main features:

- Sound frequencies for all TV systems except system M:
0.5 kHz, 1.0 kHz, 3 kHz.
TV system M:
0.3 kHz, 1.0 kHz, 3 kHz.
- Sound carrier level setting from -5 dBc to -15 dBc.
- Pre-emphasis On or Off (not for SECAM L).

The different sound modes for Analog Mono Sound are shown in Table 5-17. For operating the Mono Sound, see Chapter 4, Section Sound Settings.

The instrument allows external modulation from a sound source with 54200 as the RF modulator.

Audio and Sound Outputs

The internal generated audio signal is available at the **AUDIO OUT** and the **EURO AV OUT** connectors. For details, see Chapter 3, Pages 3-17 and 3-18.

The modulated sound carrier signal is available at the **SOUND IF OUT** connector (rear side).

Analog Stereo/Dual Sound

General

The **Analog Stereo Sound or Dual Sound** is a **two-carrier system** which is used in various countries with different sound carrier frequencies. The first sound carrier transmits the mono sound, respectively channel 1 information. The second sound channel is transmitted using an additional sound carrier.

Depending on different TV systems the two sound carriers are modulated by the following audio signals:

Table 5-11. Analog Stereo/Dual Audio Signals, Systems B/G and D/K

TV Systems	Sound Modes	Channel 1 (S1)	Channel 2 (S2)
PAL B/G	Mono	Mono	Mono
and	Stereo	$(L + R)/2 = M$	R (right)
PAL/SECAM D/K (FM A2)	Dual	Mono	Mono (2nd language)

Germany, Switzerland, and the Netherlands have used the analog Stereo/Dual sound in the PAL B/G system for many years. According to the transmission standard, the first sound carrier frequency is 5.5 MHz. The second sound carrier frequency is approximately 242 kHz above the first sound carrier, 5.742 MHz. The audio signals are FM modulated on the sound carriers.

To distinguish between Stereo- and Dual-sound transmission, an additional pilot signal of 54.68 kHz is present on the second sound carrier. This pilot signal is AM modulated with identification frequencies, 117.5 Hz for Stereo or 274.1 Hz for Dual Sound. The pilot carrier and the identification frequencies are coupled with the line frequency fH . The pre-emphasis for both sound carriers is 50 μs . The minimum LF bandwidth is 40 Hz to 15 kHz.

For frequency spectrum of Analog Stereo Sound B/G, see Appendix D.

Eastern European Countries as Poland, Lithuania, and Czech Republic are prepared to introduce or use the analog Stereo/Dual sound for TV systems PAL/SECAM D/K (FM A2). The first sound carrier frequency is 6.5 MHz. The second sound carrier frequency is 6.258 MHz. The audio signals are FM modulated on the sound carriers. The pilot carrier and identification frequencies are identical to the PAL B/G system.

Korea has introduced the sound system Mk for the analog Stereo sound (TV system NTSC M). The first sound carrier frequency is 4.5 MHz and the second is 4.724 MHz.

The pilot carrier is 3.5 x fH. Identification frequencies are fH/105 for Stereo and fH/57 for Dual. The audio signals are FM modulated on the sound carriers. The pre-emphasis for both sound carriers is 75 µs.

Table 5-12. Analog Stereo/Dual Audio Signals, System Mk (Korean Stereo)

TV Systems	Sound Modes	Channel 1 (S1)	Channel 2 (S2)
NTSC M	Mono	Mono	Mono
	Stereo	L + R	L – R
	Dual	Mono	Mono (2nd language)

Operating

Fluke 54200 offers three different Analog Stereo/Dual Sound systems, furthermore in combination with NTSC 4.433 MHz subcarrier systems. For details, see table below.

Table 5-13. 54200 Analog Stereo/Dual Sound Systems

Menu Indication	Sound Modes	TV / Sound System	Sound Carrier Frequency	
			SC 1	SC 2
FM Germany	Mono/Stereo/Dual	PAL B/G	5.5 MHz	5.742 MHz
		NTSC 4.433 B/G	5.5 MHz	5.742 MHz
FM Korea	Mono/Stereo/Dual	NTSC M (System Mk)	4.5 MHz	4.724 MHz
FM A2	Mono/Stereo/Dual	PAL/SECAM D/K (System A2)	6.5 MHz	6.258 MHz
		NTSC 4.433 D/K (System A2)	6.5 MHz	6.258 MHz

Main features:

- Channel 1 and 2 sound frequencies for TV systems B/G and D/K:
0.5 kHz, 1.0 kHz, 3 kHz.
Channel 1 and 2 sound frequencies for system Mk (Korean Stereo):
0.3 kHz, 1.0 kHz, 3 kHz.
- Sound carrier 1 level setting from -5 dBc to -15 dBc.
- Sound carrier 2 level setting -20 dBc, -25 dBc, or -27 dBc.
- Pre-emphasis On or Off.

The Analog Stereo/Dual Sound for the different TV systems is selected:

- using the **Sound System** popup menu.
- for pre-defined countries:
using the **Country** popup menu.

The different 54200 operating modes for the Analog Stereo/Dual Sound are shown in Table 5-17.

For operating Analog Stereo Sound, see Chapter 4, Section Sound Settings.

The instrument allows external modulation from a stereo tuner/amplifier or a tape or cassette recorder with 54200 as the RF modulator.

Audio and Sound Outputs

The internal generated audio signals are available at the **AUDIO OUT** and the **EURO AV OUT** connectors (rear side).

The audio signals are applied to:

- **AUDIO OUT L** for channel 1 (S1 left).
- **AUDIO OUT R** for channel 2 (S2 right).

For details of the EURO AV OUT connector, see Chapter 3, Table 3-2.

The FM modulated sound carrier signal is available at the **SOUND IF OUT** connector (rear side).

NICAM Sound

Fluke 54200 with the NICAM Option offers the NICAM-728 system for different terrestrial TV systems, see table below. Exact information on the contents of the NICAM-728 system can be obtained from the ETSI Standard ETS 300 163 and Rec. ITU-R BS.707-1.

The NICAM-728 Transmission Mode

Two sound carriers are used for the NICAM-728 transmission mode, similar to the analog FM Stereo/Dual sound mode. For NICAM, for reasons of compatibility, the first sound carrier is still transmitting the analog information assigned to the picture contents. The second sound carrier comprises the total digital two-channel audio information.

For different TV systems, the following NICAM systems and sound carrier frequencies are used:

Table 5-14. NICAM-728 Transmission, 54200 NICAM Systems

54200 TV Systems	54200 NICAM Systems	NICAM Sound Carrier Frequency (2. Sound Carrier)
PAL B/G	NICAM B/G	5.850 MHz
PAL D/K	NICAM DK (Europe, China)	5.850 MHz
PAL I	NICAM I (related to bit-rate clock)	6.552 MHz
SECAM L	NICAM L	5.850 MHz
SECAM D/K/K1	NICAM DK (as system B/G)	5.850 MHz
Combined TV systems NTSC 4.433 MHz subcarrier	all NICAM systems except NICAM L, see above	frequencies, see above

For NICAM, the analog sound signal is converted into 14-bit amplitude values at a sampling rate of 32 kHz. These values are compressed to 10 bits. A further parity bit serves for an error message.

The 728 bit frames are made up as follows:

- 8-bit Frame Alignment Word (FAW) is used for synchronizing.
- 5 bits are used for control information (C0 to C4).
- 11 bits are reserved for future applications.
- 704 bits are sound, parity or data bits.

The control information bits CO to C4 have the following functions:

- CO Frame Flag Bit.
- C1, C2, C3 Application Control Bits (transmission mode).
- C4 Reserve Sound Switching Flag (RSSF).
It is set to high (1), if the FM/AM channel transmits the same program as the NICAM channel; otherwise, it is set to LOW (0).

The frame structure of the NICAM-728 data signal is shown in Figure 5-29.

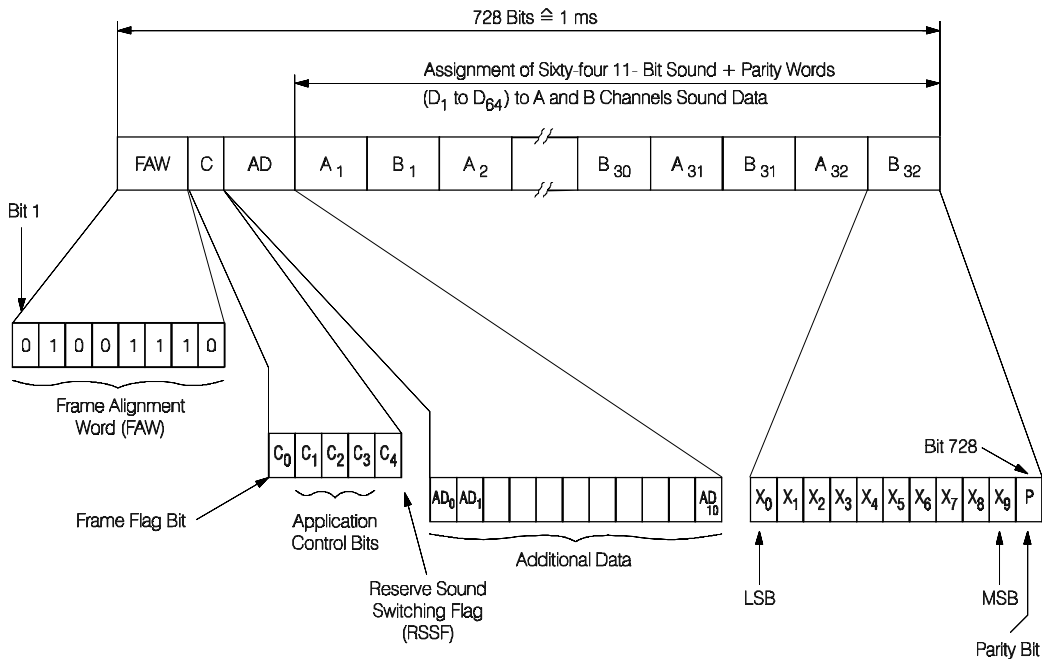

Figure 5-29. Structure of a 728-bit Frame with a Stereo Sound Signal (before interleaving)

The sound data are split into blocks of 704 bits each and afterwards interleaved according to the system; a set of 24 control bits is added. A scrambling without Frame Alignment Word (FAW) serves for equal energy dispersal. This data stream serves for phase shift keying of the unmodulated carrier (4QPSK modulation).

A spectrum shaping (cosine roll-off) of 100% is used for the sound data in the NICAM I system; all other NICAM systems have 40% cosine roll-off.

The RF frequency spectrum for NICAM B/G and NICAM I is shown in the Appendix D.

Operating

Main features:

- NICAM Channel 1 sound frequencies (S1, left):
0.5 kHz, 1 kHz, 1,5 kHz, 3 kHz.
- NICAM Channel 2 sound frequencies (S2, right):
1 kHz, 1,5 kHz, 3 kHz, 12 kHz.
- Sound carrier 1 analog mono sound frequencies (S3):
0.5 kHz, 1 kHz, 3 kHz, **as NICAM.**
as NICAM means:
sound carrier 1 is modulated with the audio signals which are selected for NICAM channels S1/S2:

Mono	S1 Modulation
Stereo	(S1+S2)/2 Modulation
Dual	S1 Modulation.
- RSSF bit On or Off.
- 3 NICAM test signals.
- Sound carrier 1 level setting from -5 dBc to -15 dBc.
- Sound carrier 1 pre-emphasis On or Off.
- Sound carrier 2 level setting -20 dBc, -25 dBc, or -27 dBc.

In the NICAM mode 54200 sets the residual carrier level for the video modulation generally to 20% (High).

Different NICAM sound systems are selectable for the available TV systems; for details, see Table 5-17.

- Select the different sound parameters using the **sound** submenu.
- Select the different NICAM sound systems:
NICAM B/G, NICAM DK, NICAM DC, NICAM I, or NICAM L
using the **Sound System** popup.

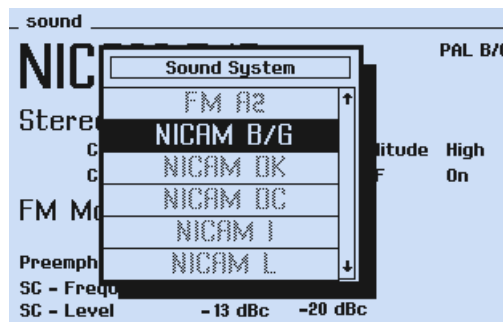

Figure 5-30. NICAM Sound Systems

- Select the sound modes Mono, Dual, Stereo and TEST 1 to 3 using the **Sound Mode** popup.
- Select the internal sound frequencies for:
 - NICAM channel 1 (left) using the **S1 Modulation** popup.
 - NICAM channel 2 (right) using the **S2 Modulation** popup.
- Select the internal sound frequencies for the analog FM/AM sound carrier using the **S3 Modulation** popup (this is the conventional sound carrier).
- Select **Low** or **High** amplitude of the NICAM audio signal using the **NICAM Amplitude** popup.
- Set the RSSF bit to **On** or **Off** using the **RSSF** popup. 54200 allows the user to set the RSSF bit to **On** or **Off** without influence to the S1, S2, or S3 modulation.

Remark:

The RSSF bit is foreseen to indicate the receiver that in case of a failure in the digital signal a switching back to the conventional FM/AM sound is acceptable.

- Select the sound carrier 1 level using the **SC1 Level** popup.
- Select the sound carrier 2 level using the **SC2 Level** popup.
- Press the **enter** softkey (F5) to confirm your settings.

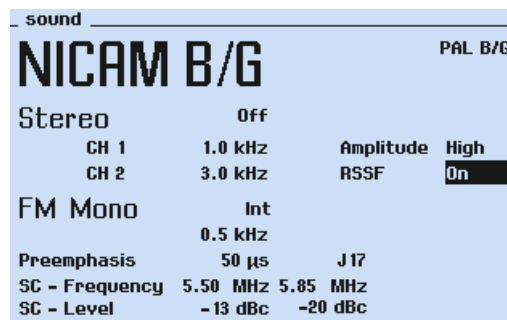

Figure 5-31. NICAM B/G Sound Menu

Remark:

The NICAM sound carrier cannot be externally modulated. This is only possible for the sound carrier 1 (analog FM/AM sound).

NICAM systems with 5.85 MHz second sound carrier are interfered if the Multiburst pattern (0.5 to 5.8 MHz) has been switched on. 54200 has the advantage to offer the full video bandwidth in the RF modulation path. So the Multiburst should be switched off in the NICAM B/G, D/K, and L systems.

Audio and Sound Outputs

At the **AUDIO OUT** and the **EURO AV OUT** connectors (rear side) always the sound information of the analog FM/AM sound carrier is available. If you select **Off**, **0.5 kHz**, **1 kHz**, or **3 kHz** in the **S3 Modulation** popup menu the respective signals are available at the audio outputs, which means L = R.

If you select **as NICAM** in the **S3 Modulation** popup the audio output signals correspond to the NICAM modulation frequencies according to the S1 or S2 Modulation selection.

For details of the EURO AV OUT connector, see Chapter 3, Table 3-2.

Test 1 to Test 3 do not generate audio signals at the rear.

The digital NICAM signal is available at the **NICAM OUT** connectors **DATA** and **CLOCK**.

Applications

The 54200 including NICAM sound makes it possible to check conventional TV sets with analog sound facilities in the mono modes; furthermore, the NICAM-728 signal allows you to check the complete digital sound channel in Mono, Dual, and Stereo Sound.

By selecting different NICAM amplitudes (Low or High) you can check the expander of the NICAM decoder. In this part the scale factors are recovered and an expansion of the audio data from 10 to 14 bits is realized.

For checking the de-emphasis of the NICAM receiver select the 0.5 / 1 / 1.5 / 3 / 12 kHz sound frequencies. It is possible to select the RSSF bit for all NICAM modes. By doing this, switching from NICAM to analog sound can be checked in the receiver.

Test functions

The test signals are ideally suited for checking single functions or circuitries in the sound part of NICAM receivers, see Figure 5-32.

You can select three different special NICAM TEST signals which do not comprise real NICAM data. They contain bit patterns to check the NICAM modules.

NICAM TEST signals:

- TEST 1 NICAM demodulator test
- TEST 2 NICAM decoder test
- TEST 3 unmodulated carrier

TEST 1 is used for checking the 4QPSK demodulator. By this method a triggerable signal at the data output of the NICAM demodulator circuit TDA 8732 can be displayed on the screen of an oscilloscope. The subsequent circuit SAA 7280 (Terrestrial Digital Sound Decoder) in this case sends an error message (error flag) and thus indicates faulty NICAM data.

Similar circuit design is also used by other manufacturers, for example the demodulator circuit from Toshiba TA 8662N or the decoder circuit CF 70123 from Texas Instrument.

TEST 2 checks NICAM decoders, for example, it sends a continuous 32 kHz square wave signal at the I²S bus output of the SAA 7280, which can easily be displayed on the screen of an oscilloscope.

TEST 3 generates an unmodulated NICAM sound carrier signal that is suited for adjustment and level measurements.

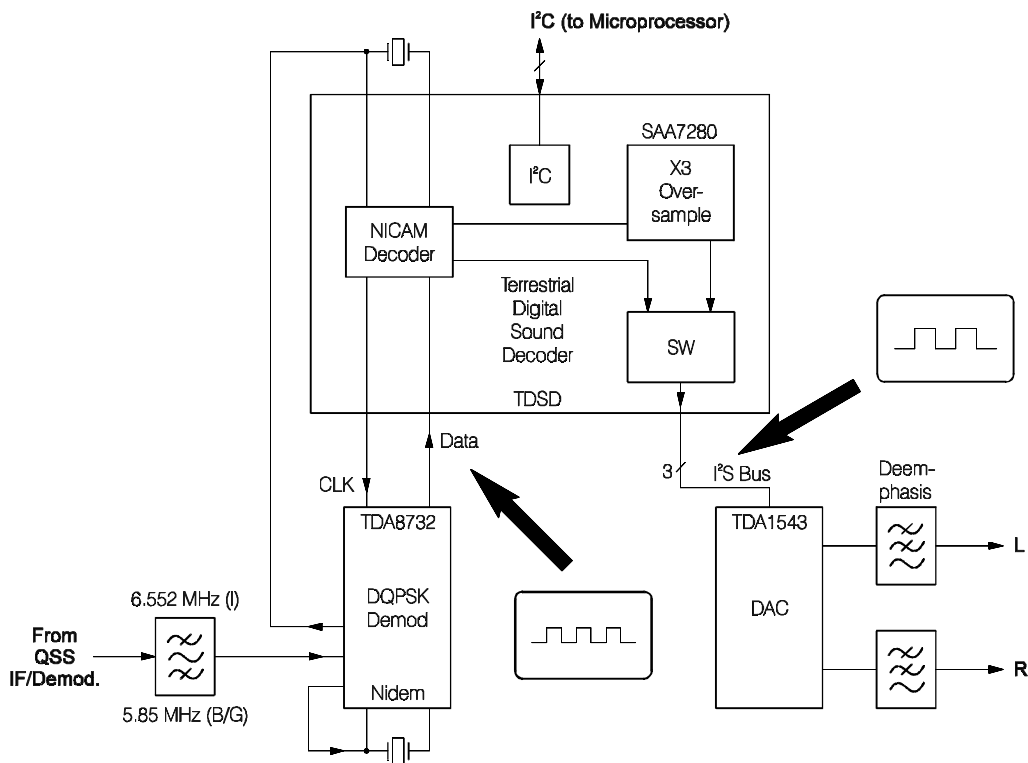

Figure 5-32. NICAM Receiver for TV Sets (Philips)

BTSC Sound

General

The BTSC (Broadcast Television System Committee) Sound system is a Multichannel-Television Sound (MTS) standard that uses only one sound carrier to transmit a stereophonic as well as a second audio program. The BTSC standard was first introduced in the USA and later on in Canada and Taiwan. The BTSC sound system is mostly transmitted in combination with NTSC M but also can be found in combination with PAL M, for example, Brazil.

The four components of the BTSC composite signal are described below and shown in Figure 5-33.

- Main channel, a monophonic L+R signal with a 75 μ s pre-emphasis.
- Pilot carrier, locked to the line frequency f_H (15.734 kHz).
- Stereo subchannel, L-R signal, amplitude modulated on a suppressed $2f_H$ subcarrier, compressed by the dynamic noise reduction system according to the BTSC specification.
- SAP (Second Audio Program) channel, frequency modulated on a $5f_H$ subcarrier (78.670 kHz), compressed by the dynamic noise reduction system according to the BTSC specification.

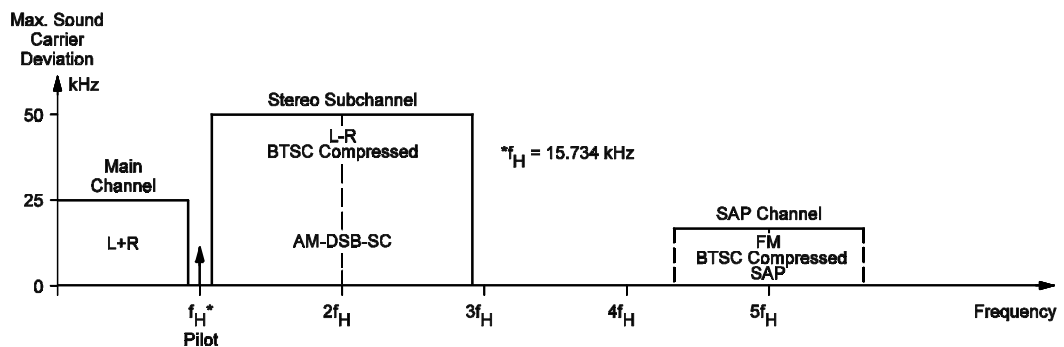

Figure 5-33. BTSC Baseband Spectrum

The broadband baseband spectrum is transmitted using frequency modulation on the sound carrier (4.5 MHz). Due to the parabolic noise characteristic, which is typical for FM transmission systems, the noise level increases for higher frequencies. To improve the Signal-to-Noise Ratio of the L - R signal and the SAP signal, both channels are encoded by the BTSC Compressor; see Figure 5-34.

The compressor on the transmitter side is level and frequency dependent and the expander on the receiver side has to respond exactly in the opposite way to guarantee proper signal processing, mainly determined by stereo channel separation and frequency response. Therefore, it is important that the audio signal levels are well defined, which is mostly done by giving the corresponding peak deviation of the sound carrier.

Figure 5-34 shows a simplified diagram of a BTSC transmitter system. The BTSC modulation standards and the maximum allowed peak deviations are shown in Table 5-15.

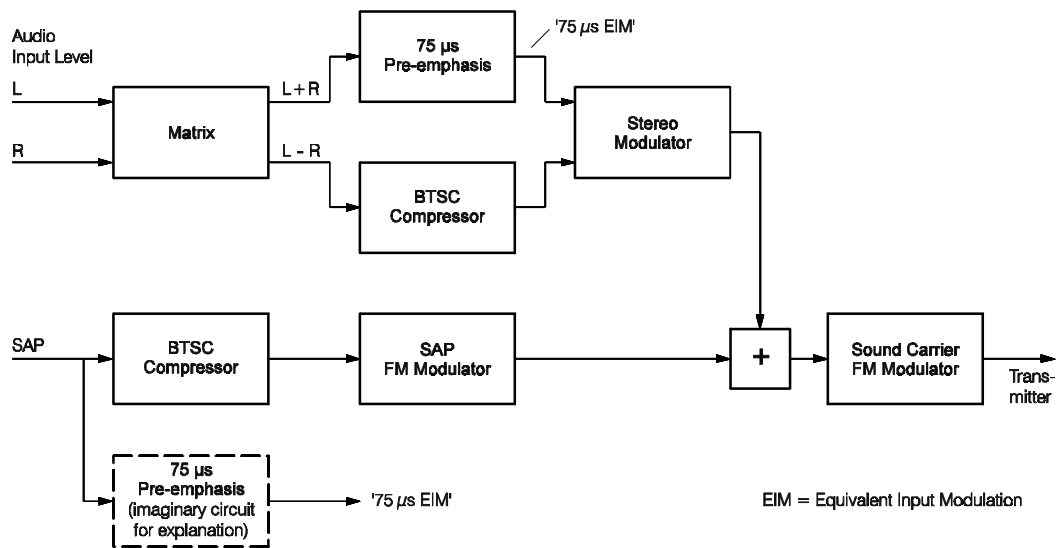

Figure 5-34. Simplified Diagram of a BTSC Transmitter System

Table 5-15. BTSC Sound Carrier Modulation Standards

Service or Signal	Modulating Signal	Modulating Frequency Range kHz	Audio Processing or Pre-Emphasis	Subcarrier Frequency *	Subcarrier Modulation Type	Subcarrier Deviation kHz	Sound Carrier Peak Deviation kHz
Mono Sound	L + R	.05 - 15	75 μs	–			25 •
Pilot Subcarrier	–			fH			5
Stereo Sound	L - R	.05 - 15	BTSC Compression	2 x fH	AM-DSB SC		50 •
SAP Second Progr.	–	.05 - 10	BTSC Compression	5 x fH	FM	10	15

* fH = 15.734 kHz

• Sum does not exceed 50 kHz

Definitions

The following explanations will help to define the level specifications of the various BTSC signals that are delivered by the 54200.

- 100% modulation of the L+R signal corresponds to a peak deviation of the sound carrier of $\Delta f_{\max} = 25$ kHz. 100% modulation of the SAP signal corresponds to a peak deviation of the SAP carrier of $\Delta f = 10$ kHz.
- The maximum allowed audio input level of 100% modulation ($100\% \hat{=} 0$ dB) is frequency dependent due to the $75 \mu\text{s}$ pre-emphasis; see Figure 5-34.

Example:

For a signal component of 15 kHz, the maximum allowed input level is 14%, about -17 dB, for L (if R = 0) or R (if L = 0). Due to the $75 \mu\text{s}$ pre-emphasis this leads to the maximum allowed peak deviation of $\Delta f = 25$ kHz for L+R.

On the other hand, at 300 Hz the maximum allowed input level is approximately 100% neglecting the small gain factor of the pre-emphasis at 300 Hz.

- Another often used level definition is called '75 μs EIM' of a certain value in percentage, for example 100%.

This is used as a reference and determines the modulation level that would occur for the equivalent Mono signal processed using a $75 \mu\text{s}$ pre-emphasis, see Figure 5-34.

Example:

An audio input level of 14% at 15 kHz leads to '75 μs EIM*' of 100%. At 300 Hz the same input level leads about to '75 μs EIM' of 14.1%.

* EIM = Equivalent Input Modulation

Operating

Fluke 54200 offers different BTSC sound modes for TV systems NTSC M and PAL M. For details, see table below.

Table 5-16. 54200 BTSC Sound Systems

Menu Indication	Sound Modes	TV / Sound System	Sound Carrier Frequency
BTSC	Mono/Stereo/SAP	NTSC M	4.5 MHz
BTSC	Mono/Stereo/SAP	PAL M	4.5 MHz

Main features:

- Channel 1 and mono sound frequencies (S1/left):
0.3 kHz, 1.0 kHz, 3 kHz.
- Channel 2 sound frequencies (S2/right):
1.0 kHz, 3 kHz.
- Sound carrier 1 level setting from -5 dBc to -15 dBc.
- Pre-emphasis 75 µs (fixed).
- Second Audio Program (SAP) with 5 kHz sound, unmodulated, or Off.
- 3 BTSC test signals.

The BTSC Sound system is selected:

- using the **Country** popup menu selecting **USA** or,
- using the **TV Standard** popup menu selecting **NTSC M** or **PAL M** followed by the **Sound System** popup selecting **BTSC**.

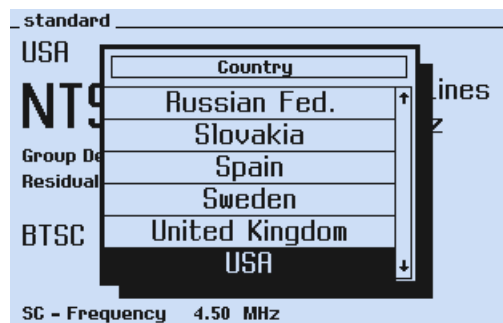

Figure 5-35. BTSC Sound using Country List

The different BTSC sound modes are selected:

- using the **Sound Mode** popup menu selecting **Mono**, **Stereo**, or **Test 1** to **Test 3**.

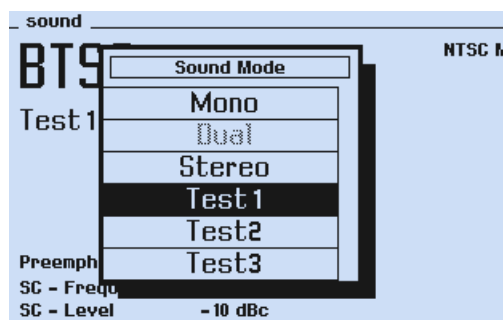

Figure 5-36. BTSC Sound Modes

The different BTSC sound parameters are selected or changed:

- using the **sound** submenu, followed by popups.

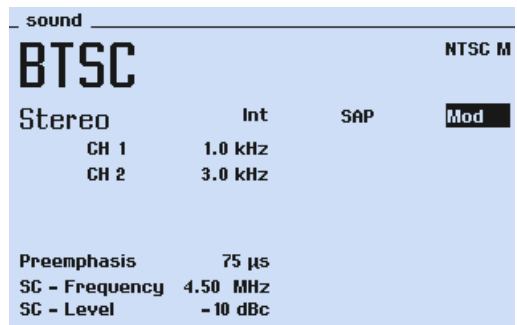

Figure 5-37. BTSC Sound Parameters

- Select the **SAP** popup menu to switch off, modulate internal with 5 kHz or to get an unmodulated Second Audio Program.

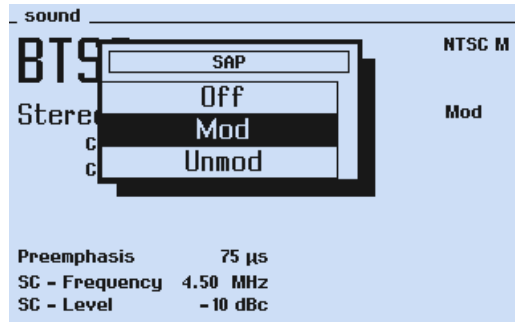

Figure 5-38. BTSC Sound with SAP Popup

- Press the **enter** softkey (F5) to confirm your settings.

The different 54200 operating modes for the BTSC Sound are shown in Table 5-17.

The instrument allows external modulation with a BTSC composite signal which is applied to the MTS input on the rear so Fluke 54200 is used as an RF modulator.

Audio and Sound Outputs

The internal generated audio signals of channel 1 and 2 are available at the **AUDIO OUT** and the **EURO AV OUT** connectors (rear side).

The audio signals are applied to:

- **AUDIO OUT L** for channel 1 (S1 left).
- **AUDIO OUT R** for channel 2 (S2 right).

These signals are also applied to the **EURO AV OUT** pin 3 (channel 1) and pin 1 (channel 2). For the Test modes 1 to 3 no audio signals are available at the rear.

The BTSC composite signal including the Second Audio Program is available at the **MTS/PILOT OUT** connector.

The FM modulated sound carrier signal (4.5 MHz) is available at the **SOUND IF OUT** connector.

Explanations of BTSC Test Modes

Test 1

Stereo: L = 300 Hz, R = 3.1 kHz

Each component has a level of -23 dB below the 100% audio input level. The sum L+R leads to a level of approximately -17 dB (14.1%) below the maximum audio input level. This signal combination is useful for adjusting the Stereo Channel Separation of BTSC-decoders, for example, Philips TDA 9854, TDA 9855, or TDA 3833.

SAP: fmod = 1 kHz, with 70% Audio Input Level (AIL)

This signal is useful for making THD measurements of the SAP processing on the receiver side.

Test 2

Stereo: L = 300 Hz, R = 8 kHz

Each component has a level of '75 μ s EIM of 10%'.

The signal combination is useful for measurements of channel separation on the receiver side especially at a higher frequency.

SAP: fmod = 300 Hz

The level is 27% of the maximum audio input level, which corresponds approximately to '75 μ s EIM of 28%'. The level of this signal is the same as used for the standard SAP modulation fmod = 5 kHz.

On the receiver side both signals, fmod = 5 kHz and 300 Hz (Test 2) should lead to the same audio output level.

Test 3

Mono: L = R = 300 Hz

With a level of '75 μ s EIM of 100%' which corresponds to 99% audio input level. The L+R signal modulates the sound carrier with the maximum allowed peak deviation ($\Delta f_{max} = 25$ kHz for L+ R).

SAP: fmod = 300 Hz

With a level of '75 μ s EIM of 100%'. The SAP carrier is now modulated with the maximum allowed peak deviation ($\Delta f_{max} = 10$ kHz).

Both signals, the Mono- and the SAP signal are useful to adjust a BTSC-decoder to its approximately maximum output level or to compare the Mono signal level with a corresponding SAP signal.

Applications

The 54200 with BTSC makes it possible to check TV sets with analog sound facilities in Mono and BTSC. The BTSC facilities allow performance measurements and alignment of TV receivers and VCRs in regard to the BTSC Stereo and SAP processing.

For baseband processing the composite signal is available at the MTS/PILOT Output. The output level of the MTS Output is about 930 mV rms (open circuit) for the maximum L+R signal. This maximum level for L+R is available using Test 3 and corresponds to a peak deviation of $\Delta f = 25$ kHz of the sound carrier. For nominal L+R level ($\Delta f = 13.5$ kHz) the MTS output level is 500 mV rms (open circuit).

By connecting the MTS Output directly to a BTSC decoder, you have to change the output level to the specified input level of the used decoder.

The MTS Input is available to apply an external BTSC composite signal so the 54200 is used as an RF modulator.

Areas of application:

- Alignment of the composite input level.
Alignment of FM-sound-demodulator-output level,
(for instance using Test 3).
- Alignment of Stereo channel separation of BTSC decoders.

Settings of 54200 for BTSC Stereo separation:

TV system:	NTSC M or PAL M
Video modulation:	OFF (Video Extern), or black pattern (black-burst signal), all patterns turned off
Sound carrier:	ON

Select among:

1. Single tone mode
Stereo ON, L = 0.3 kHz, 1 kHz, or 3 kHz, R = 0
 2. Double tone mode
Stereo ON, for example, L = 3 kHz, R = 1 kHz
 3. Double tone mode (L = 300 Hz, R = 3.1 kHz) using Test 1,
which is especially useful for Philips BTSC Decoder circuit TDA 9855 but may be
useful also for other decoders.
- SAP level adjustment of BTSC decoders.
To adapt the SAP output level of a BTSC decoder to the corresponding level of the
Mono signal (volume), Test 3 generates L+R and SAP with 100%.
 - Further performance measurements concerning harmonic distortion, frequency
response, and bandwidth are possible.

Recommendations

Because the BTSC receiver is sensitive to the signal level and to interfering frequency components, there are several sources of decreasing performance. Any of the following can cause loss in stereo channel separation.

- Bandwidth reduction within the IF or intercarrier filters of receivers or excessive group delay ripple.
- Frequency response of FM demodulators.
- Interfering components from the video modulation, mainly $n \times f_H$.

To reduce problems during alignments or measurements of BTSC sound, it is recommended that you turn off the video modulation of the 54200 with BTSC sound (Video Extern mode).

For stereo separation alignments, it is also helpful to select a stereo signal with a lower and a higher frequency component. As long as the stereo signals are high enough this leads to a masking of interfering components.

For example:

L = 3 kHz and R = 1 kHz, or Test 1, or Test 2.

Sound Operating Modes

Table 5-17. Sound Operating Modes

TV System 54200	Sound System 54200	Sound Mode	FM Sound		Internal Modulation Frequencies Mono S1/S3 Mod. *1				Internal Modulation Frequencies Stereo/Dual Left/CH1 S1 Modulation						
			50 μ s Pre- emph. On/Off	75 μ s Pre- emph. On/Off	/Off				/Off						
			NICAM	BTSC	kHz				kHz						
			J17	75 μ s	0.3	0.5	1.0	3.0	0.3	0.5	1.0	1.5	3.0		
PAL B/G	FM Mono	Mono	x			x	x	x							
PAL B/G	FM Germany	Mono, Dual, Stereo	x			x	x	x		x	x				x
PAL B/G	NICAM B/G	Mono, Dual, Stereo, Test *2	x			x	x	x		x	x	x	x		x
PAL D/K	FM Mono	Mono	x			x	x	x							
PAL D/K	FM A2	Mono, Dual, Stereo	x			x	x	x		x	x				x
PAL D/K	NICAM DK	Mono, Dual, Stereo, Test *2	x			x	x	x		x	x	x	x		x
PAL D/K	NICAM DC	Mono, Dual, Stereo, Test *2	x			x	x	x		x	x	x	x		x
PAL I	FM Mono	Mono	x			x	x	x							
PAL I	NICAM I	Mono, Dual, Stereo, Test *2	x			x	x	x		x	x	x	x		x
PAL M	FM Mono	Mono		x	x		x	x							
PAL M	BTSC	Mono, Stereo, Test *4		x	x		x	x	x		x				x
PAL N	FM Mono	Mono		x	x		x	x							
SECAM B/G	FM Mono	Mono	x			x	x	x							
SECAM B/G	FM Germany	Mono, Dual, Stereo	x			x	x	x		x	x				x
SECAM B/G	NICAM B/G	Mono, Dual, Stereo, Test *2	x			x	x	x		x	x	x	x		x
SECAM D/K/K1	FM Mono	Mono	x			x	x	x							
SECAM D/K/K1	FM A2	Mono, Dual, Stereo	x			x	x	x		x	x				x
SECAM D/K/K1	NICAM DK	Mono, Dual, Stereo, Test *2	x			x	x	x		x	x	x	x		x
SECAM D/K/K1	NICAM DC	Mono, Dual, Stereo, Test *2	x			x	x	x		x	x	x	x		x

*1 S3 Modulation only in NICAM mode: sound source of sound carrier 1.

*2 Test 1 to 3: Special NICAM parameters; for details, see Page 5-46.

*3 External modulation only possible for analog sound carrier 1.

Table 5-17. Sound Operating Modes (cont)

TV System 54200	Internal Modulation Frequencies Stereo/Dual Right/CH2 S2 Modulation /Off kHz						SAP Sec. Audio Program Off/Mod/ Unmod	Ext. Mod. Mono	Ext. Mod. Stereo/ Dual	1. Sound Carrier -5 dBc to -15 dBc Level /Off	2. Sound Carrier -20 dBc -25 dBc -27 dBc Level /Off	Remarks
	0.3	0.5	1.0	1.5	3.0	12						
	PAL B/G											
PAL B/G		x	x		x		x	x	x	x		
PAL B/G			x	x	x	x	x ^{*3}		x	x		
PAL D/K							x		x			
PAL D/K		x	x		x		x	x	x	x		
PAL D/K			x	x	x	x	x ^{*3}		x	x	used in Europe, China	
PAL I							x		x			
PAL I			x	x	x	x	x ^{*3}		x	x		
PAL M							x		x			
PAL M			x		x		x	x ^{*5}	x			
PAL N							x		x			
SECAM B/G							x		x			
SECAM B/G		x	x		x		x	x	x	x		
SECAM B/G			x	x	x	x	x ^{*3}		x	x		
SECAM D/K/K1							x		x			
SECAM D/K/K1		x	x		x		x	x	x	x		
SECAM D/K/K1			x	x	x	x	x ^{*3}		x	x		
SECAM D/K/K1			x	x	x	x	x ^{*3}		x	x		

*4 Test 1 to 3: Special BTSC parameters; for details, see Page 5-53.

*5 Apply external MTS signal to MTS Input.

Table 5-17. Sound Operating Modes (cont)

TV System 54200	Sound System 54200	Sound Mode	FM Sound		Internal Modulation Frequencies Mono S1/S3 Mod. *1				Internal Modulation Frequencies Stereo/Dual Left/CH1 S1 Modulation					
			50 μ s Pre- emph. On/Off	75 μ s Pre- emph. On/Off	/Off				/Off					
			NICAM	BTSC	kHz				kHz					
			J17	75 μ s	0.3	0.5	1.0	3.0	0.3	0.5	1.0	1.5	3.0	
SECAM L	AM L	Mono	-	-	x	x	x							
SECAM L	NICAM L	Mono, Dual, Stereo, Test *2	-/J17		x	x	x		x	x	x	x		
NTSC M	FM Mono	Mono		x	x		x	x						
NTSC M	FM Korea	Mono, Dual, Stereo		x	x		x	x	x		x			x
NTSC M	BTSC	Mono, Stereo, Test *4		x	x		x	x	x		x			x
NTSC 4 B/G	FM Mono	Mono	x			x	x	x						
NTSC 4 B/G	FM Germany	Mono, Dual, Stereo	x			x	x	x		x	x			x
NTSC 4 B/G	NICAM B/G	Mono, Dual, Stereo, Test *2	x			x	x	x		x	x	x	x	
NTSC 4 D/K	FM Mono	Mono	x			x	x	x						
NTSC 4 D/K	FM A2	Mono, Dual, Stereo	x			x	x	x		x	x			x
NTSC 4 D/K	NICAM DK	Mono, Dual, Stereo, Test *2	x			x	x	x		x	x	x	x	
NTSC 4 D/K	NICAM DK	Mono, Dual, Stereo, Test *2	x			x	x	x		x	x	x	x	
NTSC 4 I	FM Mono	Mono	x			x	x	x						
NTSC 4 I	NICAM I	Mono, Dual, Stereo, Test *2	x			x	x	x		x	x	x	x	

*1 S3 Modulation only in NICAM mode: sound source of sound carrier 1.

*2 Test 1 to 3: Special NICAM parameters; for details, see Page 5-46.

*3 External modulation only possible for analog sound carrier 1.

Table 5-17. Sound Operating Modes (cont)

TV System 54200	Internal						SAP Sec. Audio Program Off/Mod/ Unmod	Ext. Mod. Mono	Ext. Mod. Stereo/ Dual	1. Sound Carrier -5 dBc to -15 dBc Level /Off	2. Sound Carrier -20 dBc -25 dBc -27 dBc Level /Off	Remarks
	Modulation Frequencies Stereo/Dual Right/CH2 S2 Modulation /Off kHz											
	0.3	0.5	1.0	1.5	3.0	12						
SECAM L								x		x		
SECAM L			x	x	x	x		x ^{*3}		x	x	
NTSC M								x		x		
NTSC M	x		x		x			x	x	x	x	
NTSC M	x		x		x				x ^{*5}	x		
NTSC 4 B/G								x		x		
NTSC 4 B/G		x	x		x			x	x	x	x	NTSC with sub-carrier 4.433 MHz
NTSC 4 B/G			x	x	x	x		x ^{*3}		x	x	
NTSC 4 D/K								x		x		
NTSC 4 D/K		x	x		x			x	x	x	x	NTSC with sub-carrier 4.433 MHz
NTSC 4 D/K			x	x	x	x		x ^{*3}		x	x	
NTSC 4 D/K			x	x	x	x		x ^{*3}		x	x	
NTSC 4 I								x		x		NTSC with sub-carrier 4.433 MHz
NTSC 4 I			x	x	x	x		x ^{*3}		x	x	

*4 Test 1 to 3: Special BTSC parameters; for details, see Page 5-53.

*5 Apply external MTS signal to MTS Input.

External Modulation

54200 allows external video and sound modulation by an external CVBS signal respectively sound signal so the instrument is used as an RF modulator.

External Video Modulation

In the External Video mode the vision carrier can be modulated by an external video signal (VBS or CVBS), whereby the nominal amplitude should be 1 V pp with a positive going polarity. The maximum permissible input voltage is ± 5 V (peak-peak + dc).

Table 5- 18. External Video Modulation Modes

54200 Display Indication	Input Connector	Remarks/ Function
SCART	EURO AV IN (rear)	Source for video outputs is the SCART connector. Source for video modulation of the vision carrier is the SCART connector (Pin 20, CVBS).
BNC	VIDEO IN (front)	Source for video outputs is the selected video input. Source for video modulation of the vision carrier is the VIDEO IN connector.
SCART Mixed	EURO AV IN (rear)	Source for video outputs is the internal video signal. Source for video modulation of the vision carrier is the SCART connector (Pin 20, CVBS).
BNC Mixed	VIDEO IN (front)	Source for video outputs is the internal video signal. Source for video modulation of the vision carrier is the VIDEO IN connector.

For the internal video modes the external applied video signal must not be switched off or removed.

Operating

Selecting external video modulation:

- Select the **video** submenu.
- Select **Video Source** by the **↑** or **↓** softkeys (F1 or F2).
- Press the **edit** softkey (F3).
The **Video Source** popup appears.
- Select the wanted video source by the **↑** or **↓** softkeys (F1 or F2), e.g., **SCART**.
- Apply the external video signal to the **EURO AV IN** connector.
For connector pins, see Chapter 3, Table 3-1.
- Press the **enter** softkey (F5) to confirm your selection.

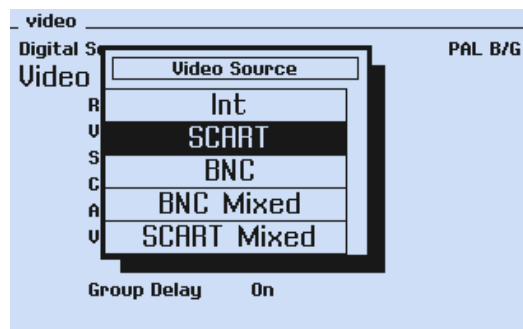

Figure 5-39. Video Source Selection

External Sound Modulation

In the External Sound mode the sound carrier or both carriers can be modulated by external audio signals. Applied audio signals have to be matched to the selected sound system and sound mode. Different audio inputs are selectable at the rear panel. For NICAM sound only the sound carrier 1, the analog FM/AM sound, can be modulated.

For BTSC sound the external BTSC composite signal is applied to the **MTS IN** connector.

For further details, see Table 5-19 on the next page.

Table 5-19. External Sound Mode

Sound System	Display Indication	Sound Mode	Sound Inputs	Remarks/Function
Analog Mono FM/AM	FM Mono, AM L	Mono	AUDIO IN L/R, EURO AV IN	From external applied audio signals at L and R inputs: $(L+R)/2$ is generated. An external level of $R = L = 0.5 \text{ V rms}$ leads to about 54% modulation (without pre-emphasis) which corresponds to the internal modulation level. Frequency bandwidth of external audio inputs >40 Hz to 15 kHz.
Analog Stereo/Dual	FM Germany, FM A2, FM Korea	Mono, Dual, Stereo	AUDIO IN L/R, EURO AV IN	An external audio input level at R and L of 0.5 V rms leads to about 54% modulation (without pre-emphasis) which corresponds to the internal modulation level. Frequency bandwidth of ext. audio inputs >40 Hz to 15 kHz.
BTSC	BTSC	BTSC	MTS IN	Apply external MTS composite signal at MTS IN. Adjust the MTS input level acc. BTSC requirements. An MTS input level of 0.5 V rms for L+R without pre-emphasis leads to 54% modulation ($\Delta f = 13.5 \text{ kHz}$ for L+R). Frequency bandwidth of MTS IN: >40 Hz to 100 kHz.
NICAM	NICAM B/G, NICAM DC, NICAM I, NICAM L, NICAM DK	Mono, Dual, Stereo	AUDIO IN L/R, EURO AV IN	Only ext. modulation of sound carrier 1: from external applied audio signals at L and R inputs $(L+R)/2$ is generated. An external level of $R = L = 0.5 \text{ V rms}$ leads to about 54% modulation (without pre-emphasis) which corresponds to the internal modulation level. Frequency bandwidth of ext. audio inputs >40 Hz to 15 kHz. External modulation of sound carrier 2 is not possible.

Operating

Selecting external sound modulation:

- Select the **sound** submenu.
- Select sound source **Int** by the **↑** or **↓** softkeys (F1 or F2).
- Press the **edit** softkey (F3).
The **Sound Source** popup appears.
- Select the wanted sound input connector **SCART** or **CINCH** by the **↑** or **↓** softkeys (F1 or F2), for example, **SCART**. The MTS input is only selectable for BTSC sound.

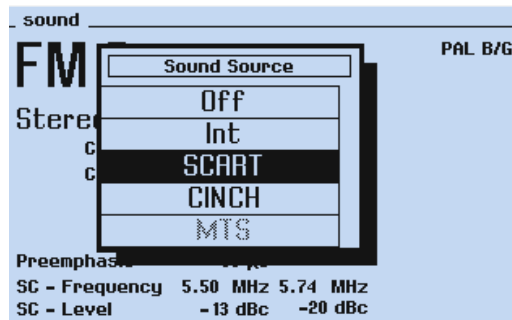

Figure 5-40. Sound Source Selection

- Apply the external audio signal to the **EURO AV IN (SCART)** connector. For connector pins, see Chapter 3, Table 3-1.
- Press the **enter** softkey (F5) to confirm your selection.

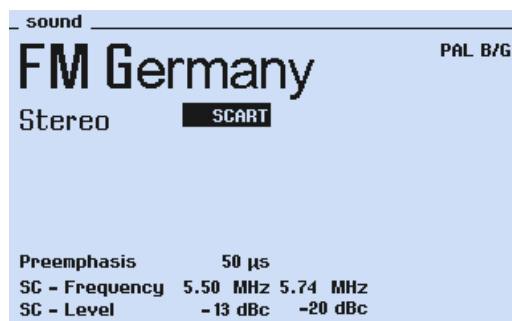

Figure 5-41. External Sound Modulation

Synchronization Outputs and Triggering

For synchronization of TV equipment or triggering purpose, for example, the time base of oscilloscopes or waveform monitors 54200 offers different synchronization signals at the rear:

- Composite sync output COMP, 2 V pp into 75 Ω
- Line sync output LINE, 2 V pp into 75 Ω
- Field sync output FIELD, 2 V pp into 75 Ω

The timing of the synchronization signals are automatically matched to 625 or 525 line systems.

An **RGB sync** is selectable for the single **RGB OUT** connectors at the rear or can be switched off. Select the RGB sync in the **RGB Sync.** popup menu.

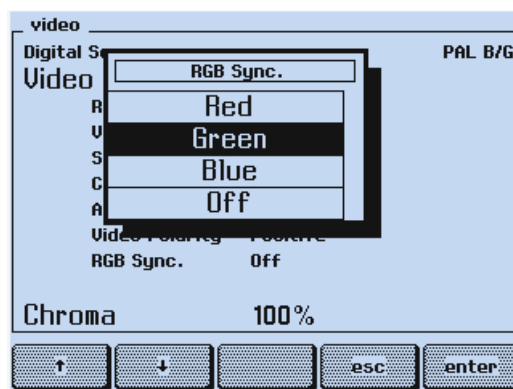

Figure 5-42. RGB Sync Selection

Operating Hints, Out of Range and Error Messages

Operating Hints

The instrument automatically offers only settings in accordance with the installed options and the selected TV and sound systems. Not selectable settings are shown in the popup menus in grey letters. For example, if the TV system PAL B/G has been selected, the popup menu for the sound systems shows:



Figure 5-43. Non Selectable Settings

Using remote control the instrument generates messages in clear text. For example, if you have selected TV system PAL B/G and you send the command for the sound system BTSC the instrument generates the message:

ERR 0004455; "Sound System not available for PAL B/G"

or if you send the command for Teletext, if NTSC has been selected:

ERR 000447C; "Only Closed Caption available for NTSC or PAL M"

For allowed combinations and inconsistencies, see Appendix C, 'Default Settings for Countries' and Table 5-17, Sound Operating Modes.

Out of Range Messages

The instrument automatically checks numerical inputs for range exceeding and shows a message in the display, if the value is out of range, for example:

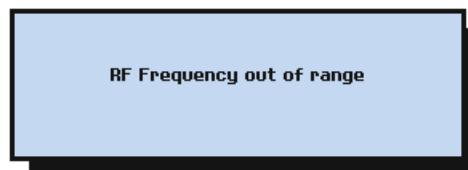

Figure 5-44. Out of Range Message

Press the **enter** softkey to confirm the message and select a value within the allowed range.

Using remote control the instrument generates messages in clear text, if you send values outside the allowed ranges, for example:

ERR 0004432; "RF Frequency out of Range"

ERR 0004473; "RF Level too high, Please select Level Range High"

For allowed ranges see Chapter 7, Specifications
Chapter 4, How to use the Instrument
Chapter 5, Function Reference

Error Messages

After power on the instrument checks the internal configuration, the RAMs, and the PROMs. During operation it checks if the PLLs of the oscillators are locked and it detects internal communication errors.

If an error is detected the display shows, for example:

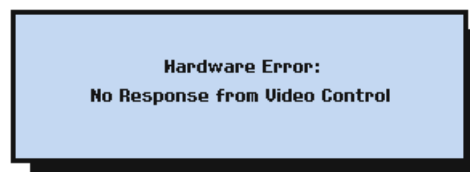

Figure 5-45. Error Message

If the instrument displays one of the following messages repair and/or adjustment is necessary, please contact your local Service Organization.

Fatal Error: followed by clear text
Hardware Error: followed by clear text
Internal Error: followed by a digit from 1 to 14

Remote Control Specific Error Messages

In addition to the Range Exceeding Messages and the Operating Hints, the instrument generates error messages using remote control, if you send commands with a wrong syntax, invalid header, data element, or suffix, wrong separators, or too many commands in a string.

These messages are listed in Chapter 6, Remote Control.

Chapter 6

Remote Control

Title	Page
Introduction.....	6-3
IEEE-488 Interface.....	6-3
Instrument Address	6-3
Interface Functions.....	6-6
RS-232 Interface	6-7
Instrument Configuration	6-7
Interface Functions and Wiring.....	6-11
Interface Functions.....	6-12
Remote Control Commands	6-13
Program Message Syntax	6-13
Message Terminator	6-13
Service Request (SRQ) and Status Registers.....	6-14
54200 'Standard Event Status Register'	6-15
Common Commands and Queries (IEEE-488.2).....	6-16
System Data.....	6-16
Internal Operations.....	6-17
Synchronization	6-19
Status and Event	6-20
Save and Recall Instrument Settings.....	6-21
Device Specific Messages	6-21
Vision Carrier	6-22
TV-System.....	6-23
Video	6-25
Sound	6-31
Digital Services.....	6-35
Miscellaneous commands.....	6-39
Device Setting Queries.....	6-40

Programming Examples.....	6-43
Example for the IEEE-488 Interface	6-43
Example for the RS-232 Interface	6-46
Error Messages	6-50
Conversion Table for the PM 5415/18 Command Set to 54200 Commands	6-51

Introduction

This chapter contains information about how to control Fluke 54200 by a Personal Computer or Controller using the IEEE-488 or RS-232 Interface.

All instrument functions can be controlled using the IEEE-488 or RS-232 Interface. You can connect the RS-232 cable and additional the IEEE-488 cable to the instrument, but you cannot control the instrument using RS-232 and IEEE-488 at the same time.

Before learning the remote interface command set, first get acquainted with the functions of the instrument, parameters, settings, and limits. A detailed description with examples is in the Chapters 2 to 5 of this manual.

If you already use a program for the PM5415/18 Color TV Signal Generator, you can find a conversion table for the commands at the end of this chapter.

IEEE-488 Interface

Instrument Address

The following sections describe the functions of the IEEE-488 bus interface.

For commands, queries, syntax, and terminators, see Section "Remote Control Commands" in this Chapter.

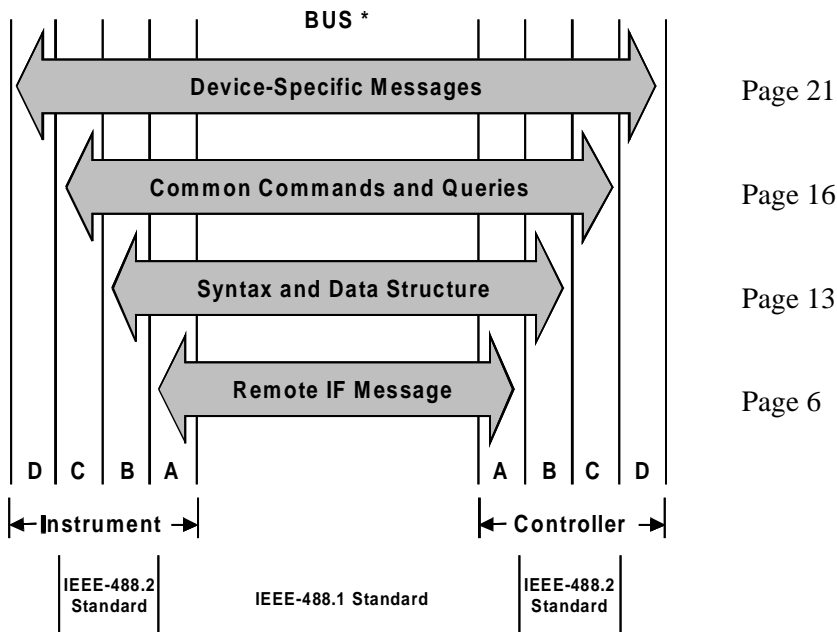

- A = Interface functions
- B = Message communication functions
- C = Common system functions
- D = Device functions

* This figure is in accordance with 'IEEE-488 Standard Codes, Formats, Protocols and Common Commands' (ANSI/IEEE-488 Std 488.2-1987).

Remote control of the instrument requires the instrument address to be known. On delivery from the factory the address is set to 21. You can display the set address and select a different address in the **support** submenu (F5 softkey).

- Set the instrument to the **main** screen.

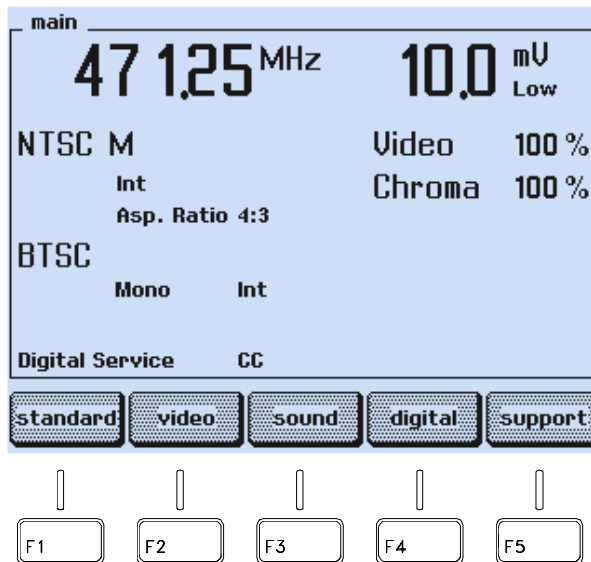

Figure 6-1. Main Screen

- Press the **support** softkey (F5).
- The **support** submenu appears:

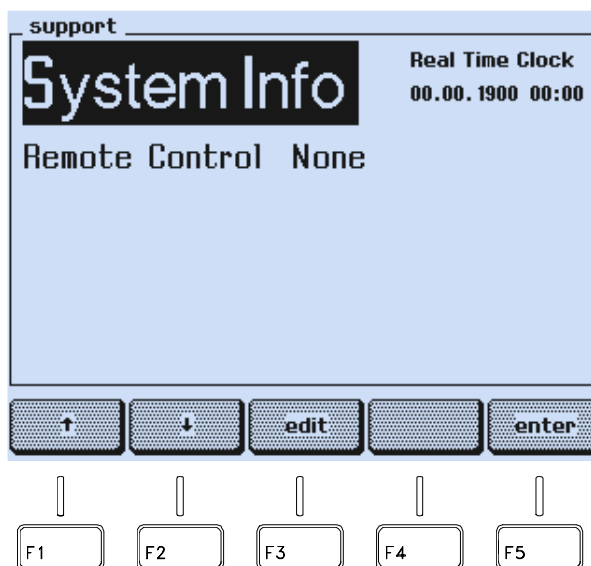

Figure 6-2. Support Submenu

- Press the **↓** softkey (F2) to select the **Remote Control** indication, in this example: **None**.
- Press the **edit** softkey (F3).

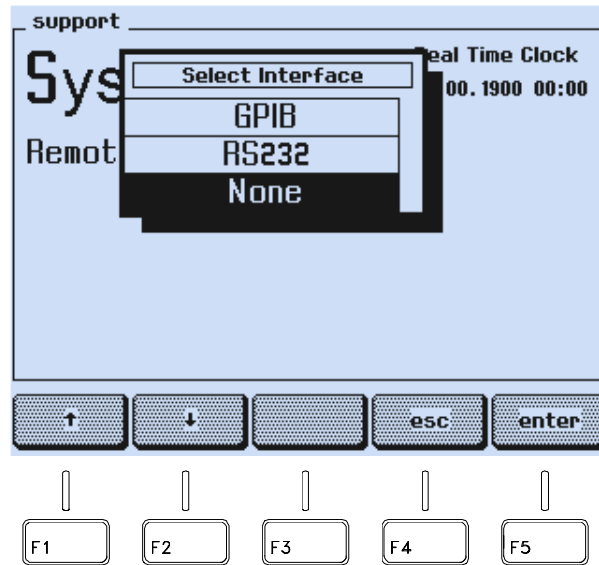

Figure 6-3. GPIB/IEEE-Interface Selection

- Press the **↑** or **↓** softkey (F1 or F2) to select **GPIB**.
- Press the **enter** softkey (F5) to confirm your selection.
- Press the **↓** softkey (F2) to select the address number.
- Press the **edit** softkey (F3).
- A popup menu for the numerical input of the instrument address appears:

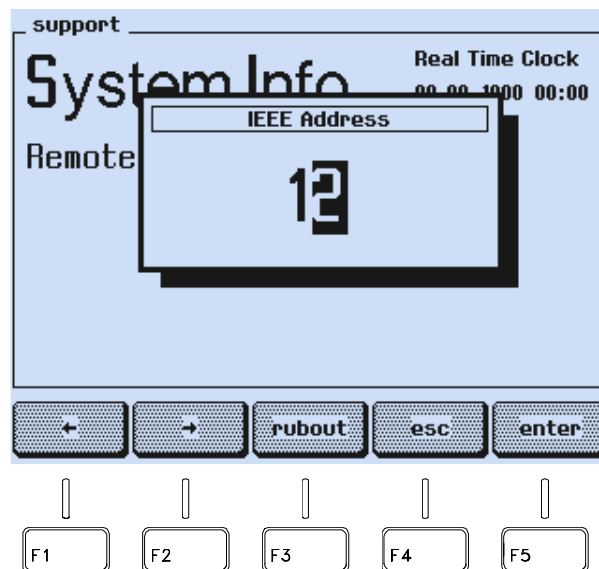

Figure 6-4. IEEE Address Popup Menu

- Key in the required instrument address, for example, **25** using numerical keypad.

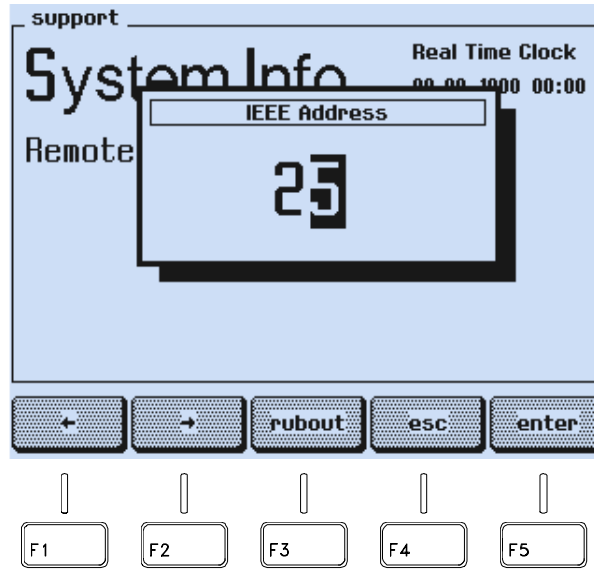

Figure 6-5. Input of the IEEE Instrument Address

- Press the **enter** softkey (F5) to confirm your entry .
- Press the **enter** softkey (F5) to return to the **main** screen.

The instrument address is stored in a memory and is retained even after power off of the instrument.

On power up the instrument is in 'local' mode (input using keyboard). When addressed as listener by a controller, the text **REMOTE** appears in the display field. All keys except the **local** softkey are locked and you can now operate the instrument in remote control. To return to local operation, use the addressed command GTL (go to local) or press the **local** softkey. To avoid unintended local control, you can disable the **local** softkey by using the universal command LLO (local lock out).

Interface Functions

The following interface functions are implemented:

AH1: acceptor handshake	SR1: service request SRQ
SH1: source handshake	DC1: device clear function
L4: listener function	DT0: no device trigger function
T6: talker function	PP0: no parallel poll
RL1: local/remote with local lock out	C0: no controller function
	E2: tri-state drivers

Hardware, connections, and the handshake procedure are in accordance with IEEE-488.1.

RS-232 Interface

Instrument Configuration

The following sections describe the functions of the RS-232 Interface. The Sections 'Remote Control Commands' contains information about commands, queries, syntax, and terminators.

Remote control of the instrument requires an interface communication configuration that matches that of your PC. Select the appropriate settings using the **support** submenu (F5 softkey).

- Set the instrument to the **main** screen.

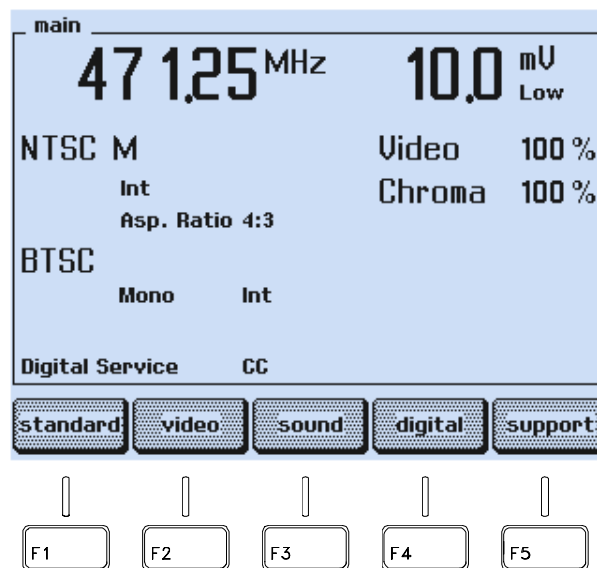

Figure 6-6. Main Screen

- Press the **support** softkey (F5).

- The **support** submenu appears:

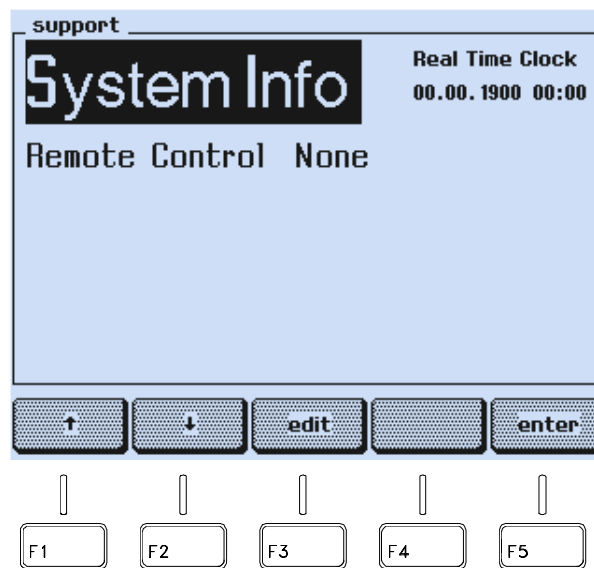

Figure 6-7. Support Submenu

- Press the **↓** softkey (F2) to select the **Remote Control** indication, in this example: **None**
- Press the **edit** softkey (F3).
- A popup menu with the interface selection appears:

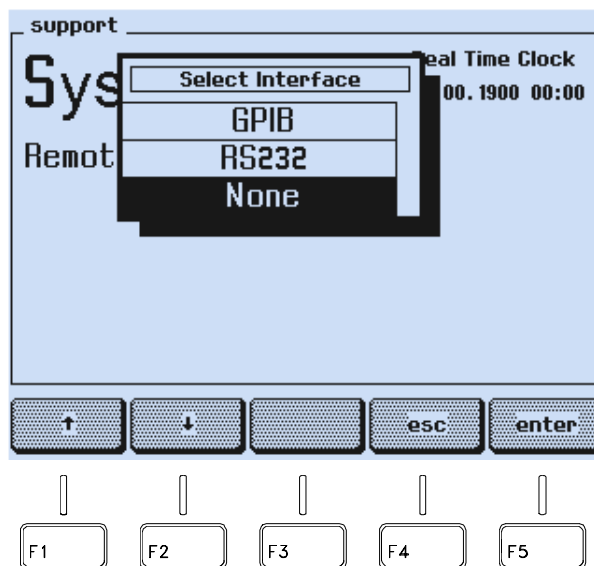

Figure 6-8. RS-232 Interface Selection

- Press the **↑** or **↓** softkey (F1 or F2) to select **RS232**.
- Press the **enter** softkey (F5) to confirm your selection.

- The screen shows the current interface configuration:

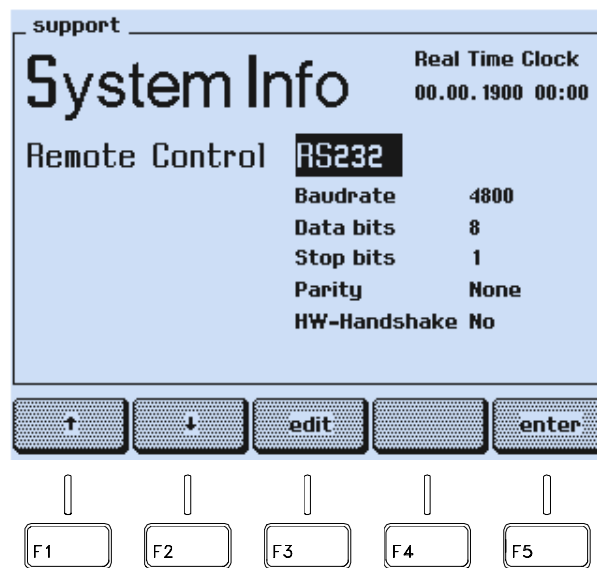

Figure 6-9. RS-232 Configuration

- Press the **↓** softkey (F2) to select the parameter for the baud rate.
- Press the **edit** softkey (F3).
- A popup menu appears:

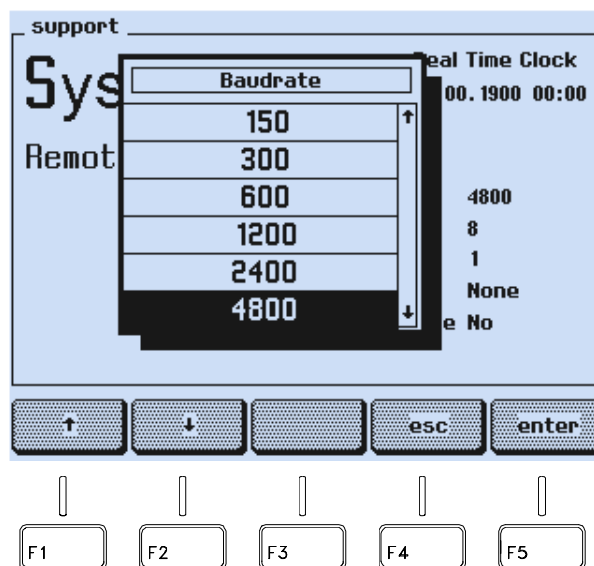

Figure 6-10. Baud Rate

- Press the **↑** or **↓** softkey (F1 or F2) to select the appropriate baud rate.
- Press the **enter** softkey (F5) to confirm your selection.

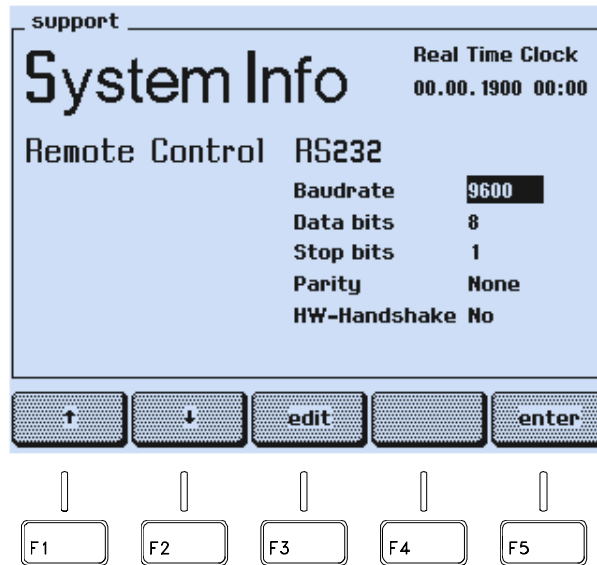

Figure 6-11. RS-232 Configuration Setting

- Press the **↓** softkey (F2) to select the next parameter.
- Press the **edit** softkey (F3).
- Select the required settings with the **↑** or **↓** softkeys (F1 or F2).
- Press the **enter** softkey (F5) to confirm your selection.
- Repeat the steps for each parameter you want to change.
- Press the **enter** softkey (F5) to return to the **main** screen.

The settings are stored in a memory and are retained even after power off of the instrument.

On power up, the instrument is in 'local' mode (input using keyboard). When you set the instrument to listener mode by sending the command **ESC2** using the PC, the text **REMOTE** appears on the display. All keys except the **local** softkey are locked and you can now operate the instrument in remote control. To return to local operation send the command **ESC1**, or press the **local** softkey. To avoid unintended local control, you can disable the **local** softkey by using the command **ESC5**.

Interface Functions and Wiring

Operating modes:	Communication mode
Baud rates:	110, 150, 300, 600, 1200, 2400, 4800, 9600, 19200
Data bits:	7 or 8
Stop bits:	1 (2 for 110 baud only)
Parity:	Odd Even None (with 8 data bits)
Hardware handshake:	ON or OFF DSR/DTR and CTS/RTS
Hardware connection:	3 wires, no hardware handshake 7 wires, with hardware handshake
Connector:	9-pin D-connector (male)

Because the PC and the Fluke 54200 are DTE (Data Terminal Equipment) you should use the following pin configuration for the RS-232 connection cable. In general it is recommended that you use a well shielded cable for adequate radio interference suppression.

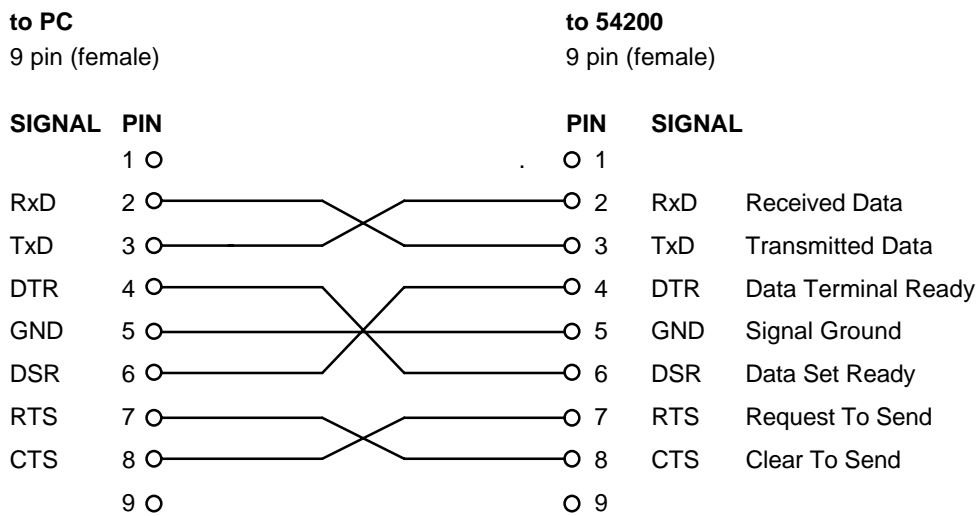

This cable can be purchased from your local Fluke organization, order number PM 9536/041.

If you use a 3-wire connection, set the 54200 to software handshake (**HW Handshake No**).

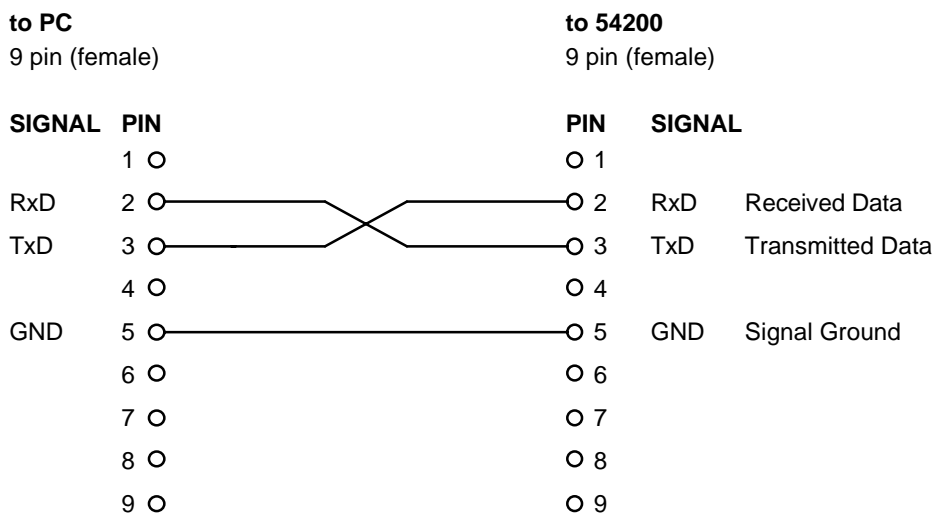

Interface Functions

For communication with the RS-232 Interface, use the following commands (similar to the addressed and unaddressed interface commands for IEEE-488):

RS-232	Function	Similar to IEEE-488
ESC 1	go to local	GTL
ESC 2	go to remote control	GTR
ESC 3	local lock out disabled	----
ESC 4	device clear	DCL
ESC 5	local lock out	LLO
ESC 7	asks for status byte	*STB?

These commands should be implemented in an application program, so they can be sent to the instrument by a PC.

Remote Control Commands

In this section the commands are described as they relate to the instrument functions and front panel keys. If not stated otherwise, following commands are used for IEEE-488 as well as for RS-232.

Program Message Syntax

You can combine several commands in a message and send them to the instrument, using the semicolon ";" as a separator between the commands. The length of a message is limited to 2000 characters.

Header and data element must be separated by a space. The end of a message must be terminated by NL (new line), ^END or both for the IEEE-488 Interface. For the RS-232 Interface the message must be terminated by NL.

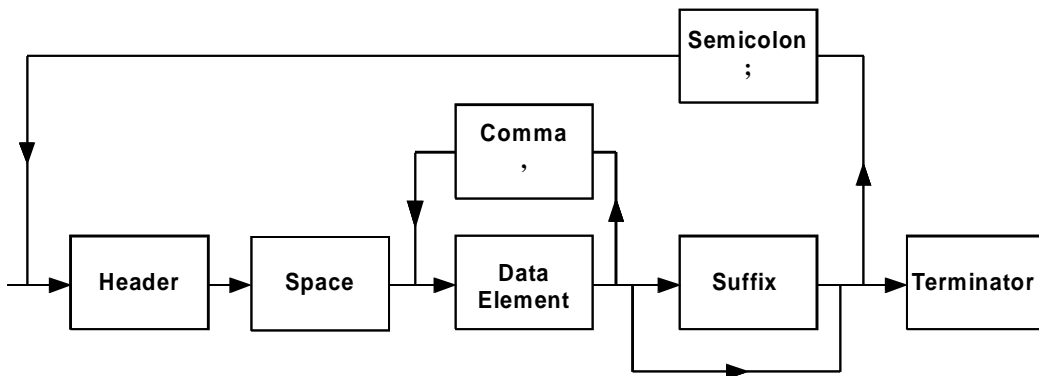

Message Terminator

The instrument accepts ^END or NL (ASCII 10 dec.) or both as the terminator for a program message using the IEEE-488 Interface.

The instrument also sets ^END and NL as the terminator for a response message.

Programming via the RS-232 Interface uses only NL as the terminator.

Service Request (SRQ) and Status Registers

A Service Request will be generated if one or more bits of the 'Status Byte Register' are set to 1 and if the corresponding bits are enabled by the 'Service Request Enable Register' (IEEE-488 Interface only). The controller asks the contents of the 'Status Byte Register' in 'Serial Poll Mode.'

Table 6-1. Fluke 54200 'Status Byte Register'

Bit	Function	Decimal Value
0	not used	1
1		2
2		4
3		8
4	message available (MAV)	16
5	bit of the 'Standard Event Status Register' high	32
6	request for service (RSQ)	64
7	not used	128

To get the information using Service Request that bits of the 'Standard Event Status Register' are set, those bits must have been enabled by *ESE, **and** bit 5 of the 'Status Byte Register' must have been enabled by *SRE.

Direct readout without Service Request is possible for the IEEE-488 as well as for the RS-232 Interface by using the *ESR? query for the 'Standard Event Status Register' and by the *STB? query for the 'Status Byte Register.'

54200 'Standard Event Status Register'

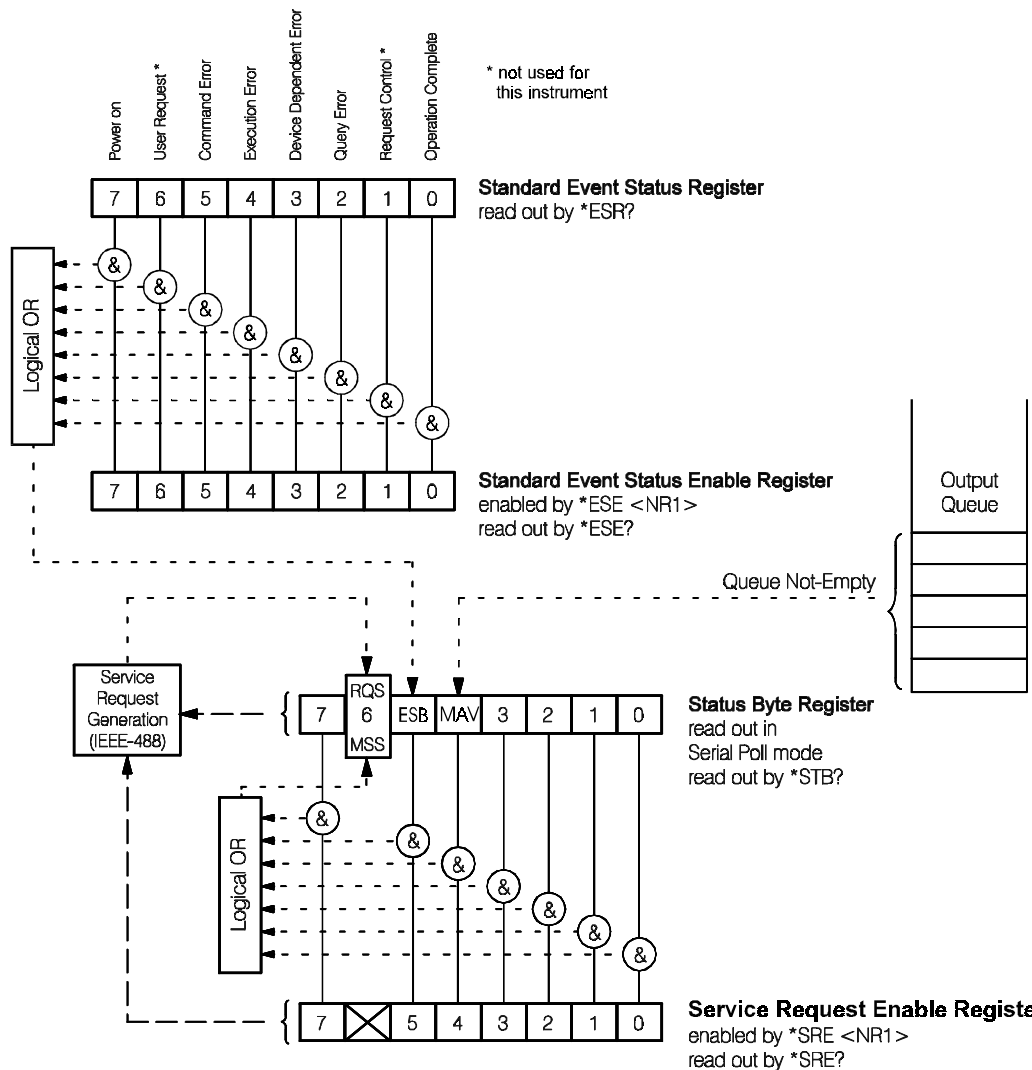

<NR1> represents a decimal value. The binary pattern of the decimal value sets the corresponding bits of the 'Enable Registers' to 1, which enables the bits of the 'Status Registers'.

All bits of the 'Standard Event Status Enable Register' and the 'Service Request Enable Register' are automatically set to 0 when powering up the instrument. Therefore, in a user program it is necessary that the required bits are set to 1 after power-on, if Service Request is required.

Common Commands and Queries (IEEE-488.2)

System Data

*IDN? Identification Query

After receipt of this query, the instrument generates the following response message:

FLUKE,54200,DMyyyyyy,Vx.x

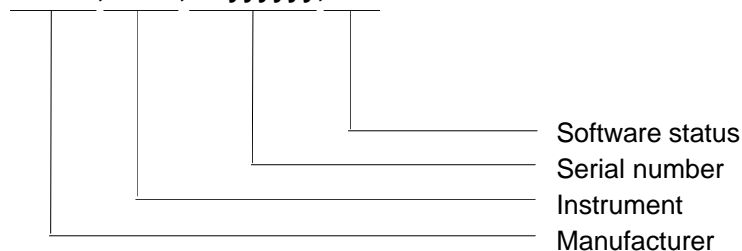

*LRN? Learn Device Setup Query

After receipt of the query the instrument generates a response message which comprises the complete actual instrument setups except the data of VPS, PDC, CC, WSS, and TXT. This message can be read in by a controller, stored in a program, and re-sent as a program command message to the instrument later on. By this method, manual keyboard inputs can be read into a program.

*OPT? Option Identification Query

After receipt of this query, the instrument generates a response message about the installed options, for example:

54200;PAL,NTSC,SECAM,TXT,PDC,CC,RGB,GPIB,STEREO,NICAM,BTSC

Internal Operations

***RST Reset Command**

This command performs a reset, which sets the instrument to a default status:

Table 6-2. Instrument Default Settings after Reset (*RST)

For instruments with PAL with or without NTSC and/or SECAM:

Country	None	Pattern	DIGI_ADC2
TV Standard	PAL B/G	Aspect Ratio	4:3
Vision Carrier	471.25 MHz	Sound System	FM mono
RF Level	10.0 mV	Sound Mode	Mono
Residual Carrier	LOW (10%)	Sound Carrier 1	5.5 MHz
Group Delay	ON	Sound Carrier 1 Level	-13 dBc
Video Amplitude	100%	Preemphasis	ON (50 μ s)
Chroma Amplitude	100%	Sound Mod. Frequency	1 kHz
Video Source	Intern	Teletext	Auto
Video Output	CVBS	Text Lines	8
Video Sync	OFF	WSS	Auto
Video Polarity	Positive	VPS/PDC	Set 7 / Set 7

Different settings for instruments with NTSC, without PAL, with or without SECAM:

TV Standard	NTSC M	Preemphasis	ON (75 μ s)
Sound Carrier 1	4.5 MHz	Closed Caption	CC Number 1
Sound Carrier 1 Level	-10 dBc	Teletext	OFF

Different settings for instruments with SECAM, without PAL and without NTSC:

TV Standard	SECAM L	Frame Indication	OFF
Group Delay	OFF	Teletext A	OFF
Sound System	AM L	Text Lines	4
Sound Carrier 1	6.5 MHz	WSS	Auto
Sound Carrier 1 Level	-10 dBc	VPS	OFF
Preemphasis	None		

All parameters not mentioned are set according to PAL B/G and the sound system FM Mono.

The reset does not affect the internal memories, for instrument settings, the PDC and VPS data sets, the enable registers, and the status registers of the interface.

***TST? Self-test Query**

The instrument automatically checks the RAM, the I²C-bus communication to the RF units, and the communication to the module for Teletext, VPS, PDC, CC, and WSS. The contents of the register will not be destroyed, and instrument settings remain unchanged. The test lasts approximately 1 second.

A zero in the response indicates that the self-test has completed without errors detected.

In case of an error, one of the following digits is displayed:

10758	=	Hardware Error: No Response from the RF Control
10759	=	Hardware Error: No Response from RF Calibration EEPROM
10760	=	Hardware Error: Invalid Calibration Data for RF Control
10769	=	Hardware Error: No Response from RF Level Calibration EEPROM
10771	=	Hardware Error: Invalid Calibration Data for RF Level Control
10817	=	Hardware Error: No Response from Teletext Control
10851	=	Hardware Error: RAM Test failed

Synchronization

***OPC Operating Complete Command**

Sending a command using the IEEE-488 bus, followed by the command *OPC in the same string, sets bit 0 (operation complete) of the 'Standard Event Status Register' to 1 when the function is finished. This bit activates bit 5 of the 'Status Byte Register' (Event Status Bit), which generates a Service Request. This alerts the controller that the function is finished. See Page 6-15 to enable the Service Request.

***OPC? Operation Complete Query**

Sending the query *OPC? to the generator during a running function causes the instrument to wait until the function is finished, and then set a 1 in the output queue. The register can be read out by the controller without a Service Request. When a 1 is returned, your user program can then continue.

Data in the output queue activate bit 4 of the 'Status Byte Register' (MAV, message available), which may generate a Service Request. To avoid generating an SRQ, disable bit 4 (set it to 0). Bit 0 (operation complete) of the 'Standard Event Status Register' is not affected by *OPC?

Contrary to *OPC, the query *OPC? is more convenient for the RS-232 Interface because the 1 is directly sent; a separate read-out is not necessary as it would be for the IEEE-488 Interface.

If *OPC? is sent when the operation is already finished, bit 0 is not set to 1.

***WAI Wait-to-Continue Command**

This command sent to the instrument in a message string with other commands causes the generator to execute the command following *WAI only when the previous command is completed.

Example: `FREQ 500M;*SAV 10;*WAI;FREQ 400M`

The command *WAI in this string causes the instrument to change the frequency setting to 400 MHz after the previous setting of 500 MHz has been stored.

Status and Event

***CLS Clear Status Command**

Sets bits of the 'Standard Event Status Register' and of the 'Status Byte Register' to zero. Sending *CLS as a single command or as the first command of a string also clears the contents of the Output Queue.

***ESE Standard Event Status Enable Command**

*ESE, followed by a decimal value, sets the bits of the 'Standard Event Status Enable Register.' This enables the assigned bits of the 'Standard Event Status Register,' see Page 6-15.

***ESE? Standard Event Status Enable Query**

This query asks the instrument for the contents of the 'Standard Event Status Enable Register.' The response is a decimal value.

Example: 255 = all bits are set to 1: all events of the 'Standard Event Status Register' are enabled.

***ESR? Standard Event Status Register Query**

Asks for the contents of the 'Standard Event Status Register.' The response is a decimal value. This query also clears the register contents.

***SRE Service Request Enable Command**

*SRE, followed by a decimal value, sets the bits to 1 of the 'Service Request Enable Register', except bit 6. For more detail on the assigned bits of the 'Status Byte Register,' see Page 6-15.

***SRE? Service Request Enable Query**

Asks for the contents of the 'Service Request Enable Register.' The response is a decimal value.

***STB? Read Status Byte Query**

Asks for the contents of the 'Status Byte Register.' The response is a decimal value.

Sending this query using IEEE-488 Interface causes the 54200 to set bit 4 (MAV) of the Status Byte Register. The output is 16 dec if no further bits are set.

Save and Recall Instrument Settings

***SAV Save Command**

This command, followed by a decimal value from 1 to 99, stores the current instrument setting into the corresponding internal memory register. The command is executed after all other commands in a common string are completed. The instrument cannot handle more than 25 *SAV commands in one message. The contents of the memory are not affected by the command *RST or when the instrument is turned off.

***RCL Recall Command**

This command, followed by a decimal value from 1 to 99 for the memory place, calls up and executes the instrument setting stored in that memory register.

Device Specific Messages

This section contains the remote programming commands necessary to select operation modes, parameters, and settings.

"|" Separates expressions which can be used by choice.

"[]" Means that this expression or unit need not necessarily be input. If the unit is missing the instrument automatically sets Hz for frequencies, V for amplitudes, dBc for levels, and s for time.

"NRf" Flexible numeric representation. Under the IEEE-488.2 standard, numeric values can be given to the instrument in integer <NR1 >, real <NR2>, or exponential <NR3> forms. The number of digits is limited to 100 for mantissa and 2 for the exponent. The instrument rounds automatically to the next possible value for the selected parameter.

You can set, for example, the carrier frequency to 203.25 MHz with following inputs for <NRf>:

```
FREQUENCY 203.25E6
FREQUENCY 203250000
FREQUENCY 203250000.0
FREQUENCY 203250E3
FREQUENCY 203300000
```

Instrument rounds to its nearest allowed frequency, which is 203.25 MHz.

"," Serves as a separator between several data elements in the program data. The length of a complete program message is limited to 2000 characters. The length of a string is limited to 1000 characters.

Example:

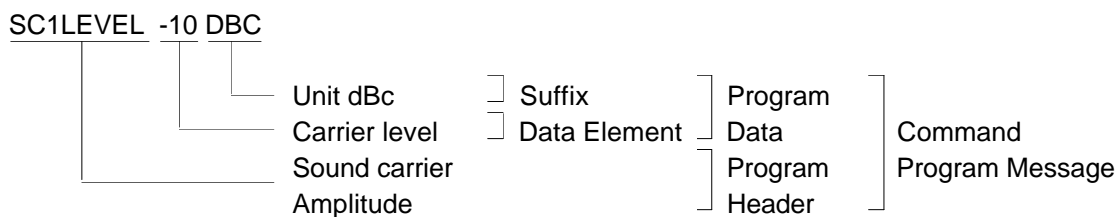

You can send most headers and data in short form, marked with bold letters.

Example: **FREQUENCY** is in short form **FREQ**
 SC1LEVEL is in short form **SC1L**

All headers can be sent as command headers to program the generator and also as query by adding a question mark. The instrument returns its actual setting in response to the query.

Example: FREQ 471250E3 Sets the instrument to 471.25 MHz
 FREQ? Response: FREQ 471.25E6

Vision Carrier

- RF Frequency

Header: **FREQUENCY**
Data element: NRf
Suffix: **[HZ | KHZ | MHZ | GHZ]**
Remark: NRf is the frequency range from 32.00 MHz to 900.00 MHz in 50 kHz steps. If no suffix is sent, the instrument sets HZ (Hertz).

Example: FREQUENCY 203.25 MHZ or
 FREQ 203.25E6
 sets the vision carrier frequency to 203.25 MHz.

- RF Level

Header: **LEVEL**
Data element: NRf
Suffix: **[DBUV | MV | UV | V]**
Remark: NRf is the level range from 0.01 mV to 100 mV in 0.01 mV steps to 10 mV and in 0.1 mV steps to 100 mV (20 to 100 dV μ V in 1 dB steps).
 If no suffix is sent, the instrument sets V (Volts).

Example: LEVEL 1MV or
 LEVE 0.001
 sets the vision carrier level to 1 mV.

- RF Level Range

Header: **LEVRANGE**
 Data element: **LOW | HIGH**
 Remark: LOW = maximum level setting 10 mV (80 dB μ V)
 HIGH = maximum level setting 100 mV (100 dB μ V)

Example: **LEVRANGE LOW** or
 LEVR L
 sets the maximum output level to 10 mV.

TV-System

- Country

Header: **COUNTRY**
 Data element: **NRf**
 Remark: The command sets the TV-standard, sound system, Teletext, etc.
 according to the national standards of the selected country.
 NRf is the telephone country code:

Table 6-3. Telephone Country Code

Argentina	54	Korea	82
Brazil	55	Mexico	52
Central African Republic	236	Poland	48
China Public Republic	86	Romania	40
Czech Republic	421	Russian Federal Rep.	7
France	33	Slovakia	429
Germany	49	Spain	34
Greece	30	Sweden	46
Hungary	36	United Kingdom	44
Japan	81	USA	1

Example: **COUNTRY 49** or
 COUN 49
 selects Germany.

- TV Standard

Header: **TVSTANDARD**

Data element: **PALB | PALD | PALG | PALI | PALK | PALM | PALN | NTSCM | NTSC4B | NTSC4D | NTSC4G | NTSC4I | NTSC4K | SECAMB | SECAMG | SECAMD | SECAMK | SECAMK1 | SECAML**

Remark: SECAMK and SECAMK1 are identical in the 54200.

Example: TVSTANDARD PALB or
TVST PALB
sets the German TV-standard PAL B

- Group Delay

Header: **GRPDELAY**

Data element: **ON | OFF**

Remark: The group delay is set according to the current TV-standard. It is defined for B/G and M/N standards. For all other standards the command is accepted but the group delay remains off until a B/G or M/N standard is selected.

Example: GRPDELAY OFF or
GRPD OF
switches the group delay off.

- Residual Carrier

Header: **RESCARRIER**

Data element: **LOW | HIGH**

Remark: LOW = 10% residual carrier, HIGH = 20% residual carrier
LOW for NICAM not available

Example: RESCARRIER LOW or
RESC L
sets the residual carrier to 10%.

- Frame Identification

Header: **FRAMEID**
 Data element: **ON | OFF**
 Remark: This command is only meaningful for SECAM, but can be set anyway.

Example: **FRAMEID OFF** or
 FRAM OF
 switches the frame identification pulses for SECAM off.

Video

- TV Patterns

Header: **PATTERN**
 Data element: Mnemonic:

Mnemonic	Pattern Description
CI	Circle, white or black, depending on background
CH_WNN	Crosshatch white, no color burst, no TL indication
CH_WCN	Crosshatch white, color burst, no TL indication
CH_WNT	Crosshatch white, no color burst, TL indication
CH_WCT	Crosshatch white, color burst, TL indication
CH_BNN	Crosshatch black, no color burst, no TL indication
CH_BCN	Crosshatch black, color burst, no TL indication
CH_BNT	Crosshatch black, no color burst, TL indication
CH_BCT	Crosshatch black, color burst, TL indication
CENTER_2	Center Cross, 2% border castellation ¹⁾
CENTER_3	Center Cross, 3% border castellation ¹⁾
DOTS_WHITE	White dots on black background
DOTS_BLACK	Black dots on white background
CHECKER	Checkerboard

Mnemonic	Pattern Description
WH_00	White, 0% ²⁾
WH_05	White, 5% ²⁾
WH_7_5	White, 7.5% ²⁾
WH_15	White, 15%
WH_20	White, 20%
:	in 5% steps to
WH_95	White, 95%
WH_100	White, 100%
GREYSCALE	Greyscale
MULTIBURST	Multiburst
COL_75_0	Full Field Color Bar 75/0/75/0 ³⁾
COL_100_0	Full Field Color Bar 100/0/75/0 ³⁾
COL_75_25	Full Field Color Bar 75/0/100/25
COL_100_25	Full Field Color Bar 100/0/100/25
COL_SMPTE	SMPTE Color Bar ³⁾
COL_HORZ	Horizontal Color Bar ³⁾
COL_SP_75	Split Field Color Bar 75/0/75/0 ⁴⁾
COL_SP_100	Split Field Color Bar 100/0/75/0 ⁴⁾
PUR_RED	Purity red
PUR_GREEN	Purity green
PUR_BLUE	Purity blue
PUR_CYAN	Purity cyan
PUR_MAGENTA	Purity magenta
PUR_YELLOW	Purity yellow
PUR_WHITE	Purity white
PUR_BLACK	Purity black
VCR_PAT1	VCR1 pattern
VCR_PAT2	VCR2 pattern
VCR_RES_STD	VCR pattern for standard resolution test
VCR_RES_HI	VCR pattern for high resolution test
VCR_WRITE	VCR pattern for Writing Current Adjustment
DEM_PAT1	Demodulator Test DEM 1
DEM_PAT2	Demodulator Test DEM 2
PLUGE	PLUGE pattern

Mnemonic	Pattern Description
DIGI_ADC1	Digital Scan, ADC Check 1
DIGI_ADC2	Digital Scan, ADC Check 2
DIGI_MOVE	Moving block
DIGI_SCAN1_S	Progressive Scan Check 1, still
DIGI_SCAN1_M	Progressive Scan Check 1, moving
DIGI_SCAN2_S	Progressive Scan Check 2, still
DIGI_SCAN2_M	Progressive Scan Check 2, moving
DIGI_SCAN3_S	Progressive Scan Check 3, still
DIGI_SCAN3_M	Progressive Scan Check 3, moving
CTA_SMALL	Color Temperature Adjustment, size 1 ⁵⁾
CTA_MEDIUM	Color Temperature Adjustment, size 2 ⁵⁾
CTA_LARGE	Color Temperature Adjustment, size 3 ⁵⁾
EHTTEST	EHT test pattern
IRS17	Pattern of Insertion-Reference Signal Line 17
OFF	Black pattern (black screen)

1. Black or white cross, depending on background.
2. 0% and 5% for 625 line systems only.
7.5% for 525 line systems only.
If you select 0% or 5% in a 625 line system and switch to a 525 line system, the instrument sets 7.5% (IRE), that is the lowest level in the 525 line system.
Switching back to a 625 line system sets the level to 0%.
3. The table shows the primary color signal levels for the 625 line systems. For the 525 line systems the minimum values are set to 7.5% instead of 0%.
4. Purity part of the split field color set by the purity command, e.g., PAT COL_SP1;PAT PUR_R.
5. The luminance value can be set by the command CTABORDER for the border and CTACENTER for the center.

Remark: For combinations send separate commands with the different patterns.
To reset all patterns send **PATTERN OFF**.
A string is executed from left to right.
If a pattern is selected that does not match with the previously selected, the previously selected is switched off.
The device cannot accept more than 16 pattern commands in one string.
PAT CHE; PAT CI; PAT VCR_PAT1; switches VCR1 and Circle on, the checkerboard is ignored because it does not match the VCR1 pattern.
For legal pattern combinations see Chapter 4.

Example: PATTERN OFF;PATTERN CI;PATTERN PUR_YELLOW;
PATTERN COL_SP_100; or
PAT O;PAT CI;PAT PUR_Y;PAT COL_SP_100
clears first all patterns and then sets circle, purity yellow, and split field colorbar.

- Insertion-Reference Signal in Line 17 (IRS)

Header: **REFLINE**

Data element: **ON | OFF**

Example: **REFLINE ON** or
REFLI ON
switches the Insertion-Reference Signal in line 17 and 330 on.

Remark: This command is only available for PAL 625 line systems.
Changing to a different TV standard switches the signal off.

- Video Source

Header: **VIDSOURCE**

Data element: **INT | SCART | EXTERN**

Example: **VIDSOURCE SCART** or
VIDSO SC
selects the SCART connector on the rear as video input.

- Video Amplitude

Header: **VIDAMPLITUDE**

Data element: **NRf**

Suffix: **[PCT]**

Remark: **NRf** is a range from 0 to 150% in 1% steps.
The suffix need not to be send.

Example: **VIDAMPLITUDE 100PCT** or
VIDA 100
sets the video amplitude to 100%.

- Chroma Amplitude

Header: **CHRAMPLITUDE**

Data element: **NRf**

Suffix: **[PCT]**

Remark: **NRf** is a range from 0 to 150% in 1% steps.
The suffix need not to be send.

Example: **CHRAMPLITUDE 100PCT** or
CHRA 100
sets the color amplitude to its standard value of 100%.

- White level for the border of the Color Temperature Adjustment pattern

Header: **CTABORDER**
 Data element: NRf
 Suffix: **[PCT | IRE]**
 Remark: NRf for 625 line systems: 0, 50, or 100%.
 NRf for 525 line systems: 7.5, 53.75, or 100 IRE.

Example: CTABORDER 100PCT or
 CTAB 100
 sets the luminance for the CTA border to 100% for 625 line systems.

- White level for the center of the Color Temperature Adjustment pattern

Header: **CTACENTER**
 Data element: NRf
 Suffix: **[PCT | IRE]**
 Remark: NRf for 625 line systems:
 Range from 0%, 5%, 15% to 100% in 5% steps.
 NRf for 525 line systems:
 Range from 7.5, 15, 20 to 100 IRE in 5 IRE steps.
 See also White Pattern, Page 6-26.

Example: CATCENTER 20PCT or
 CTAC 20
 sets the luminance for the center of the CTA pattern to 20%.

- Aspect Ratio

Header: **ASPRATIO**
 Data element: **R16_9 | R4_3**

Example: ASPRATIO R16_9 or
 ASPR R16_9
 sets the Aspect Ratio to 16:9.

- SCART Output

Header: **SCARTOUT**
Data element: **RGB | Y_C | CVBS | CV_RGB**

Example: SCARTOUT RGB or
SCARTO R
sets the SCART output to RGB.

- SCART CVBS status line

Header: **CVBS_STAT**
Data element: **OFF | AUTO**

Example: CVBS_STAT AUTO or
CVBS A
sets the status line according to the current aspect ratio.

- Video Synchronization for the RGB output

Header: **RGBSYNC**
Data element: **RED | GREEN | BLUE | OFF**

Example: RGBSYNC GREEN or
RGBS G
sets the sync in the green line.

- Video Polarity for the BNC video output

Header: **VIDPOLARITY**
Data element: **POSITIVE | NEGATIVE**

Example: VIDEOPOLARITY POSITIVE or
VIDP P
selects a positive video signal for the BNC video output.

Sound

- Sound System

Header: **SNDSYSTEM**

Data element: **AML | FMMONO | FMGERMANY | FMA2 | FMKOREA | BTSC |
NICAMB | NICAMDK | NICAMDC | NICAMG | NICAMI | NICAML**

Example: **SNDSYSTEM FMGERMANY** or
SNDSY FMG
selects the German sound system.

- Sound Mode

Header: **SNDMODE**

Data element: **MONO | DUAL | STEREO | TEST1 | TEST2 | TEST3**

Remark: If NICAM is on, this command selects the digital sound mode, the analog sound is always set to MONO.

Example: **SNDMOD DUAL** or
SNDM D
selects the DUAL sound mode.

- Sound Source

Header: **SNDSOURCE**

Data element: **INTERN | EXTERN | SCART | CINCH | MTS**

Remark: If NICAM is on, this command selects the analog sound source; the digital sound is always internal.
MTS is for 4.5 MHz systems only, for external BTSC.

Example: **SNDSOURCE INTERN** or
SNDSO I
selects the internal sound source.

- Sound modulation frequency channel 1.
Mono
Stereo, left channel
Dual, channel A

Header: **S1MODULATION**

Data element: **OFF/NRf**

Suffix: **[HZ | KHZ | MHZ | GHZ]**

Remark: NRf is a frequency of 0.3, 0.5, 1.0, 1.5, 3.0 kHz.
If no suffix is sent, the instrument sets HZ (Hertz).

The selectable frequencies depend on TV standard and sound system.

Example: S1MODULATION 0.3KHZ or
S1MOD 0.3K
sets the sound modulation frequency for channel 1 to 0.3 kHz.

- Sound modulation frequency channel 2.
Stereo, right channel
Dual, channel B

Header: **S2MODULATION**

Data element: **OFF/NRf**

Suffix: **[HZ | KHZ | MHZ | GHZ]**

Remark: NRf is a frequency of 0.3, 0.5, 1.0, 1.5, 3.0, 12 kHz.
If no suffix is sent, the instrument sets HZ (Hertz).

The selectable frequencies depend on TV-standard and sound system.

Example: S2MODULATION 1.0KHZ or
S2MOD 1K
sets the sound modulation frequency for channel 2 to 1 kHz.

- Sound modulation frequency channel 3.
Analog MONO channel with NICAM.

Header: **S3MODULATION**
 Data element: **OFF/NRf**
 Suffix: **[HZ | KHZ | MHZ | GHZ]**
 Remark: NRf is a frequency of 0.5, 1.0, 3.0 kHz.
 If no suffix is sent, the instrument sets HZ (Hertz).
 This command is for NICAM only. The RSSF is not influenced.

Example: **S3MODULATION 3.0KHZ** or
 S3MOD 3K
 sets the sound modulation frequency for channel 3 to 3 kHz.

- Sound Carrier amplitude, carrier 1

Header: **SC1LEVEL**
 Data element: **OFF/NRf**
 Suffix: **[DBC]**
 Remark: NRf is a level range from -5 to -15 dBc in step of 1 dB

Example: **SC1LEVEL -10DBC** or
 SC1L -10
 sets the sound carrier level 1 to -10 dB relative to the vision carrier.

- Sound Carrier amplitude, carrier 2 for analog stereo and NICAM

Header: **SC2LEVEL**
 Data element: **OFF/NRf:**
 Suffix: **[DBC]**
 Remark: NRf is a level of -20, -25, -27 dBc.

Example: **SC2LEVEL -20DBC** or
 SC2L -20
 sets the sound carrier level 2 to -20 dBc relative to the vision carrier.

- Pre-emphasis

Header: **PREEMPHASIS**

Data element: **ON | OFF**

Remark: The preemphasis is set according to the current TV-standard. If SECAM L is on, the command is accepted but the preemphasis is always off. After changing the standard the preemphasis is set according to this command.

Example: **PREEMPHASIS OFF** or
PREEM OF
switches the preemphasis off.

- NICAM RSSF

Header: **RSSF**

Data element: **ON | OFF**

Remark: You can only change the RSSF with this command or in manual operation using the keyboard of the generator. There is no automatism .

Example: **RSSF OFF** or
RSSF OF
switches RSSF off.

- NICAM Amplitude

Header: **NICAMPLITUDE**

Data element: **LOW | HIGH**

Example: **NICAMAMPLITUDE LOW** or
NICA L
sets the NICAM amplitude to low.

- NICAM Source

Header: **NICSOURCE**
 Data element: **OFF | INTERN**
 Remark: For this command NICAM must be switched on.

Example: **NICSOURCE OFF** or
 NICS O
 switches the internal NICAM source off.
 This is the same function as **S1MOD OF;S2MOD OF**.

- BTSC SAP

Header: **SAP**
 Data element: **OFF | MODULATED | UNMODULATED**

Example: **SAP MODULATED** or
 SAP M
 switches the modulated SAP on.

Digital Services

- Teletext

Header: **TTXSYSTEM**
 Data element: **AUTO | ANTIOPE | TOP1 | TOP2 | FLOF1 | FLOF2 | CC | OFF**
 Remark: This command selects the teletext system and mode.
 TOP/FLOF 1 and 2 define the VPT mode:
 1 VPT used in Germany,
 2 used in United Kingdom.

Example: **TTXSYSTEM AUTO** or
 TTXS AU
 sets the teletext system according to the TV standard.
 The settings are:
 ANTIOPE for SECAM L,
 TOP1 for PAL/SECAM B/G/D/K,
 FLOF2 for PAL I and
 OFF for all others.

- Number of Teletext lines

Header: **TTXLINES**
Data element: **4 | 8**
Remark: 8 not for SECAM

Example: **TTXLINES 4** or **TTXL 4**
enables teletext data in the lines 20,21 and 333,334

- Closed Caption

Header: **CCNUMBER**
Data element: **SEQUENCE | NRf**
Remark: NRf is a number from 1 to 8.
1 to 8 are the eight different sets,
SEQUENCE is the sequential output of set 1 to 8.

Example: **CCNUMBER 3** or
CCN 3
selects data set number 3.

- PDC

Header: **PDCNUMBER**
Data element: **MULTI | NRf**
Remark: NRf is a number from 0 to 9.
0 = off,
1 to 9 are the PDC data sets,
MULTI = multilabeling using the data sets 1 to 4.
This command switches PDC on or off and selects the data set.
For PDC, Teletext must be switched on.

Example: **PDCNUMBER 3** or
PDCN 3
recalls the PDC data set 3.

- VPS

Header: **VPSNUMBER**
 Data element: **NRf**
 Remark: **NRf** is a number from 0 to 9.
 0 = off,
 1 to 9 are the VPS data sets.
 This command switches VPS on or off and selects the data set.
 For VPS, Teletext must be switched on.

Example: **VPNSNUMBER** or
VPSN 3
 recalls the VPS data set 3.

- Programming of PDC/VPS

Header: **PDCDATA | VPSDATA**
 Data element: **NR1**
 Remark: **NR1** is the set number, a string with the complete PDC or VPS data, and a string with the program title.
 The data sets 1 to 4 are programmable.
 The format of the first string is:
DD.MM, HH:MM, Country, Network, PTY, Reserved bits, Flags.
 The ranges are:
 0 to 31 for day and hour,
 0 to 15 for month and flags,
 0 to 63 for minutes,
 0 to 255 for country, network and program type (PTY),
 0 to 3 for reserved bits,
 0 to 15 for the flags (PDC only).
 For the flags value the MSB bit is the PRF, the MSB -1 is the LUF bit, and the two LSB bits are the LCI bits.

The separators in the string may be a full stop, colon, comma, or a space. The second string may contain any printable ASCII character except ' ' or ' '. Its length is at most 20 characters.

Example: **PDCD 3,"27.12,12:00,123,23,255,0,0","Gentlemen Gangsters"**
VPSD 3,"27.12,12:00,123,23,255,0","Gentlemen Gangsters"
 writes the PDC/VPS data for date (27.12), time (12:00), country (123), Network (23), PTY (255), reserved bits (0), flags for PDC (0), and the program title as set number 3 into the memory.

- WSS, Wide Screen Signalling

Header: **WSSMODE**

Data element: **OFF | AUTO | MANUAL**

Example: WSSMODE AUTO or
WSSM A
switches the signalling bits on; they are set according to the instrument settings.

- Programming of WSS data

Header: **WSSDATA**

Data element: Binary number

Remark: Only 14 bits are accepted.

Example: WSSD #B00100100100100

Miscellaneous commands

- Display Mode

Header: **DISPMODE**

Data element: **ON | OFF | MAIN | SOUND | VIDEO | STANDARD | DIGDATA | SUPPORT**

Remark: This command switches the display of the generator on or off (in remote operation only) and selects the displayed screen. The support screen can only be shown for information purposes; the settings on this screen (except the clock) cannot be changed using remote control.

Example: DISPMODE OFF or
DISP OF
switched the display of the generator off.

- Real-time clock

Header: **TIME**

Data element: String

Remark: The string contains the date for the year, month, day, hour, and minute:
"YYYY.MM.DD,HH:MM"
Range for the date: From January 1st, 1991 to December 31st, 2090,
Range for the time: From 00:00 to 23:59

Example: TIME "1996.12.24,18:00"
sets the clock to 6.00 p.m. at Christmas Eve 1996.

- Local Time Offset

Header: **LTOFFSET**

Data element: NR1

Remark: NR1 is the range is from -12 to +12.
The command sets a local time offset related to selected time in hours.

Example: LTOFFSET 1 sets a time offset of one hour,
LTO 0 sets no time offset.

Device Setting Queries

All device specific commands can also be sent as query, except the commands for programmed Teletext, VPS, PDC data and WSS. The responses use the basic units Volts, Hertz, dBc, minutes or seconds. In addition you can send following queries:

- RF query

Query: **RF?**
Response headers: **FREQ** Vision carrier frequency
LEVE Carrier amplitude
LEVR Level range of the carrier amplitude
Response example: **FREQ 203.25E+6;LEVE 0.01;LEVR L**

- System query

Query: **STAN?**
Response headers: **COUN** Country
TVST TV standard
GRPD Group delay
RESC Residual carrier
FRAM SACAM Frame Identification
Response example: **COUN 49;TVST PALG;GRPD OFF;RESC L**
Remark: **FRAM** is only sent if **SECAM** is on.

- Video query

Query: **VIDEO?**

Response header:

VIDA	Video amplitude
CHRA	Chroma amplitude
ASPR	Aspect Ratio
VIDSO	Video source
VIDP	Video polarity (BNC)
RGBSY	Video synchronization (RGB)
SCARTO	SCART output
CVBS	SCART CVBS status line
CTAB	White level of CTA pattern border
CTAC	White level of CTA pattern center
PAT	TV pattern

Response example: VIDA 90PCT;CHRA 100 PCT;ASPR R 4_3;VIDSO I; VIDP P;RBSY OFF;SCARTO RGB;CVBS A;CTAB 50; CTAC 100;PAT CI

Remark: For pattern combinations each part is sent as one command, for example: PAT CI;PAT COL_SP_100

- Sound query

Query: **SOUND?**

Response header:

SNDSY	Sound system
SNDM	Sound mode
SNDSO	Sound source
S1MOD	Sound modulation frequency, channel 1
SC1L	Sound carrier amplitude, channel 1
PREEMP	Preemphasis

Additional for FM DUAL/STEREO:

S2MOD	Sound modulation frequency, channel 2
SC2L	Sound carrier amplitude, channel 2

Additional for NICAM MONO:

S3MOD	Sound modulation frequency, channel 3
SC2L	Sound carrier amplitude, channel 2
RSSF	Reserve Sound Switching Flag
NICA	NICAM amplitude
SNDN	Sound source NICAM

Additional for NICAM DUAL/STEREO:
S2MOD Sound modulation frequency, channel 2
S3MOD Sound modulation frequency, channel 3
SC2L Sound carrier amplitude, channel 2
RSSF Reserve Sound Switching Flag
NICA NICAM amplitude
SNDN Sound source NICAM

Additional for BTSC STEREO:
S2MOD Sound modulation frequency, channel 2
SAP Second Audio Program

For the BTSC/NICAM test mode you get:
SNDSY Sound system
SNDM Sound mode: Test 1, 2, or 3

Response example: SNDSY NICAMB;SNDM TEST1

- Digital Data query

Query: **DIGD?**
Response header: TTXS Teletext system
 TTXL Teletext lines
 CCN Closed Caption, set number
 PDCN Program Delivery Control, set number
 VPSN Video Programming System, set number
 WSSM White Screen Signalling

Response example: TTXS FLOF1;TTXL 4;PDCN 1; VPSN 0;WSSM A

Remark: This query is only for instruments with Digital Services.
 TTXS and CCN exclude each other.

The response to the *LRN? query is a combination of the response to these five queries.
The response is given when the instrument has received the queries in the sequence:
RF?;STAN?;DIGD?;SOUND?;VIDEO?.

If an option is not installed the correspondent query is omitted.

Programming Examples

The following examples are related to an IBM-compatible PC. The first one uses the built-in IEEE-488 Interface, the second one uses the standard serial port of the controller and the RS-232 Interface. You should have basic knowledge of the MS-DOS operating system of your controller and the programming language QuickBasic (version 4.0 and above) to understand the examples that follow.

Example for the IEEE-488 Interface

```

DECLARE SUB SendCmd (WR$)
DECLARE SUB SendStr (WR$)
DECLARE SUB ErrChk (Cs!, Sts%)
REM $INCLUDE: 'qbdecl4.bas'

CLS
PRINT " "
PRINT " "
PRINT "          ***** DEMO PROGRAM FOR FLUKE 54200/100 *****"
PRINT
PRINT "          PRESS 'RETURN' TO CONTINUE  "
PRINT
PRINT "          To leave running program type 'END' or 'end'  "
BEEP
PRINT
DO "          'waiting for 'RETURN'"
  B$ = ""
  DO UNTIL B$ <> ""
    B$ = INKEY$
  LOOP
LOOP UNTIL B$ = CHR$(13)

CLS "          'clears screen"
Stp = 0
BDNAME$ = "GEN1" "          'name of the device on the conf.table"
CALL IBFIND(BDNAME$, GEN%) "          'open device"
CALL ErrChk(1, GEN%) "          'check error

IF Stp = 0 THEN
  CALL IBCLR(GEN%) "          'send interface clear"
  CALL ErrChk(2, IBSTA%) "          'check error"
END IF

IF Stp = 0 THEN
  A$ = "*ese 255" "          'initialize ESR register"
  CALL SendCmd(A$) "          'send command"

  A$ = "*cls" "          'clear status register"
  CALL SendCmd(A$) "          'send command"

  A$ = "*IDN?" "          'ask for identity"
  CALL SendStr(A$) "          'send command string

  WHILE Stp = 0
    LINE INPUT "COMMAND :      ", A$ "          'reading keyboard input"
    IF A$ = "END" OR A$ = "end" THEN
      CALL IBLOC(GEN%) "          'set instrument to 'LOCAL'"
      CLS "          'clear screen"
      Stp = 1
    ELSE
      CALL SendStr(A$) "          'send command string"
    END IF
    PRINT
    PRINT
  WEND
END IF
END

```

```
SUB ErrChk (Cs, Sts%)                'Error handler
  SHARED Stp
  SELECT CASE Cs
    CASE 1
      IF Sts% < 0 THEN
        PRINT
        PRINT
        PRINT "IBFIND ERROR"
        PRINT "Check the configuration of the bus interface with
IBCONF.EXE"
        PRINT
        Stp = 1                        'terminate program
      END IF
    CASE 2
      IF Sts% < 0 THEN
        PRINT
        PRINT
        PRINT "      BUS ERROR!"
        PRINT
        PRINT "      Please check connections and start program again"
        PRINT
        Stp = 1                        'terminate the program
      END IF
    CASE 3
      IF Sts% < 0 THEN
        PRINT
        PRINT
        PRINT "GPIB ERROR"
        PRINT
      END IF
      IF Sts% > 16383 THEN
        PRINT
        PRINT
        PRINT "TIME OUT ERROR"
        PRINT
      END IF
  END SELECT
END SUB
```

```

SUB SendCmd (WR$)
'Send command string to instrument via GPIB without response
  SHARED GEN%
  CALL IBWRT(GEN%, WR$)           'output command string
  CALL ErrChk(3, IBSTA%)         'check error
END SUB

SUB SendStr (WR$)
'Send command string to instrument via GPIB with response
  SHARED GEN%
  qry = 0                         'query flag
  qer = 0                         'error query flag
  CALL IBWRT(GEN%, WR$)         'output command string

  IF IBSTA% < 0 THEN
    CALL ErrChk(3, IBSTA%)       'check error
  ELSE
    Stat = 0
    CALL IBRSP(GEN%, Stat%)      'get status byte from instrument
    CALL ErrChk(3, IBSTA%)       'check error
    IF (Stat% AND 16) THEN       'checks whether MAV is set
      qry = 1
    END IF
    IF (Stat% AND 32) THEN       'checks whether ESB is set
      BEEP
      WR$ = "err?"              'error query
      CALL IBWRT(GEN%, WR$)     'output command string
      qry = 1
      qer = 1
    END IF
  END IF

  IF INSTR(WR$, "?") > 0 OR qry = 1 THEN 'check if query command
    MaxLen = 164                 'max. length of response string
    RD$ = SPACE$(MaxLen)         'clear response string
    CALL IBRD(GEN%, RD$)         'get response string
    IF IBSTA% < 0 THEN
      CALL ErrChk(3, IBSTA%)     'check error
    ELSE
      PRINT
      PRINT "RESPONSE : " + RD$  'response string
      IF qer = 1 THEN
        WR$ = "*cls"            'clear status register
        CALL IBWRT(GEN%, WR$)   'output command string
      END IF
    END IF
  END IF
END SUB

```

Example for the RS-232 Interface

```

DECLARE FUNCTION TestCmd! (A$)
DECLARE SUB RecDat (St%)
DECLARE SUB SendCmd (Cmd%, Rsp%)
DECLARE SUB SendStr (WR$)
DECLARE SUB InitCom ()
DECLARE SUB ClrBuf ()

CLS
PRINT " "
PRINT " "
PRINT "          ***** Demonstration Program for FLUKE 54200/100 *****"
PRINT "          *****          with RS-232 Interface          *****"
PRINT
'
'          Enviroment : IBM AT or Compatible with Quick Basic 4.5
Stp = 0
A$ = ""
CALL InitCom          'open device
CALL ClrBuf           'clear input buffer

ErrSts% = 0
CALL SendCmd(4, 0)    'send interface clear

CALL SendCmd(2, 0)    'sets instrument to remote

A$ = "*ese 255"        'initialize ESR register
CALL SendStr(A$)      'send command

IF ErrSts% > 0 THEN   'if no answer
  PRINT "Please check the connection and setting!"
ELSE
  CLS                  'clears screen
  A$ = "*cls"          'clear status register
  CALL SendStr(A$)     'send command

  A$ = "*IDN?"         'ask for identity
  CALL SendStr(A$)     'send command string

  WHILE Stp = 0
    LINE INPUT "COMMAND : ", A$ 'reading keyboard input
    Cmd% = TestCmd(A$)         'test command
    SELECT CASE Cmd%
      CASE 0
        CALL SendCmd(1, 1)    'set instrument to 'LOCAL'
        CLOSE #1
        CLS                    'clear screen
        Stp = 1
      CASE 4
        CALL SendCmd(Cmd%, 1) 'send command
        CALL ClrBuf           'clear input buffer
      CASE 1 TO 8
        CALL SendCmd(Cmd%, 1) 'send command
      CASE IS > 8
        CALL SendStr(A$)      'send command string
    END SELECT
    PRINT
    PRINT
  WEND
END IF
END

```

```

DATA END,end,GTL,gtl,GTR,gtr,GTR,gtr,DCL,dcl,LLO,llo,LLO,llo,STB,spb,DTR,dtr

SUB ClrBuf
  'clear input buffer of comm. port
  DO WHILE LOC(1) > 0          'while buffer not empty
    C$ = INPUT$(1, #1)        'read one character
  LOOP
END SUB

SUB InitCom
  'Inilize serial communication channel
  PRINT "Please set the RS-232 parameters of the FLUKE 54200/100 to : "
  PRINT "          Baudrate   : 9600"
  PRINT "          Data       : 8"
  PRINT "          Stop bits  : 1"
  PRINT "          Parity     : none"
  PRINT "          Handshake  : yes"
  PRINT
  PRINT "Which communication port of the PC do You use ? "
  PRINT "          COM1      [1]"
  PRINT "          COM2      [2]           please select : ";
  C$ = ""
  DO UNTIL (C$ = "1" OR C$ = "2")
    C$ = INKEY$
  LOOP
  PRINT C$
  ComStr$ = "COM" + C$ + ":9600,N,8,1,CS,DS,LF"
  PRINT
  OPEN ComStr$ FOR RANDOM AS #1
  PRINT "Special commands :          GTL : go to local"
  PRINT "                               GTR : go to remote"
  PRINT "                               DCL : device clear"
  PRINT "                               LLO : local lock out"
  PRINT "                               STB : get status byte"
  PRINT "                               DTR : device trigger"
  PRINT
  PRINT
  PRINT "To leave running program type 'END' or 'end'. Press a key to
continue ";
  PRINT
  BEEP
  C$ = ""
  DO WHILE C$ = ""          'waiting for a key
    C$ = INKEY$
  LOOP
  PRINT
  PRINT
END SUB

```

```

SUB RecDat (Rsp%)
  SHARED stb%, ErrSts%
  Tr = TIMER
  RD$ = ""
  C$ = ""
  DO UNTIL (C$ = CHR$(10) OR (TIMER - Tr > 3))
    IF LOC(1) > 0 THEN
      C$ = INPUT$(1, #1)
      IF C$ <> CHR$(10) THEN
        RD$ = RD$ + C$
        C$ = ""
      END IF
    END IF
  LOOP
  IF (TIMER - Tr > 3) THEN
    ErrSts% = 1
    PRINT "**** receive timeout ****"
    PRINT
  ELSE
    ErrSts% = 0
    IF Rsp% = 0 THEN
      stb% = VAL(RD$)
    ELSE
      PRINT
      PRINT "RESPONSE :      " + RD$      'response string
      PRINT
    END IF
  END IF
END SUB

SUB SendCmd (Cmd%, Rsp%)
  'Send command string to instrument via serial bus without response
  WR$ = CHR$(27) + CHR$(Cmd% + 48)
  PRINT #1, WR$                                'output command string
  IF Cmd% = 7 THEN                             'if statusbyte requested
    CALL RecDat(Rsp%)                          'get status byte
  END IF
END SUB

SUB SendStr (WR$)
  'Send command string to instrument via serial bus with response
  SHARED stb%
  qry = 0                                     'query flag
  WR$ = WR$ + CHR$(10)                       'append LF
  PRINT #1, WR$                               'output command string

  IF INSTR(WR$, "?") > 0 THEN                 'check if query command
    CALL RecDat(1)                            'get response string
  END IF

  stb% = 0
  CALL SendCmd(7, 0)                          'ask for status byte
  IF (stb% AND 16) THEN                       'checks whether MAV is set
    qry = 1
  END IF
  IF (stb% AND 32) THEN                       'checks whether ESB is set
    BEEP
    WR$ = "err?" + CHR$(10)                   'error query
    PRINT #1, WR$                             'output command string
    qry = 1
  END IF
  IF qry = 1 THEN
    CALL RecDat(1)                            'get error string
  END IF

```



```

        WR$ = "*cls" + CHR$(10)           'clear status register
        PRINT #1, WR$                    'output command string
    END IF
END SUB

FUNCTION TestCmd (A$)
    RESTORE
    Cmd% = 100
    i% = 0
    DO UNTIL Cmd% < 100 OR i% > 17
        READ b$
        IF A$ = b$ THEN
            Cmd% = i% \ 2
        END IF
        i% = i% + 1
    LOOP
    TestCmd = Cmd%
END FUNCTION

```

Error Messages

After receiving the query **ERR?** the instrument generates a response message with an error number and an error description in clear text, which can be read in by the controller.

Error Message	See Page
Illegal Character in Header No... ..	6-16 to 6-43
Unknown Header No... ..	6-16 to 6-43
Unexpected Separator in Header No... ..	6-13
Illegal Character in Data for Header... ..	6-21 to 6-43
Unknown Data for Header... ..	6-16 to 6-42
Unexpected Separator in Data for Header... ..	6-13
Unknown Suffix in Data for Header... ..	6-16 to 6-32
Numeric Overflow in Data for Header... ..	6-21
Empty Mantissa in Data for Header... ..	6-21
Empty Exponent in Data for Header... ..	6-21
Value out of Range in Data for Header... ..	6-16 to 6-40
Illegal Value in Data for Header... ..	6-21 to 6-40
Header Separator expected after Header... ..	6-13
Data Separator expected after Header... ..	6-13
End of String expected in Data for Header	6-13
Message Separator expected after Header... ..	6-13
Too many queries, Query	6-21
Too many Pattern Commands, Header No.	6-27
Too many *SAV Commands, Header No.	6-21
Option not available, Query	6-41 to 6-43
*OPT? query must be last in Message, Header No.	6-16

In addition to this error messages the instruments generates messages in clear text if commands were sent with values exceeding the allowed ranges or for not allowed settings, for example, 'Sound Mode not available for Mono Systems' if you send the command for sound mode stereo when sound system FM Mono is selected, see Chapter 5, Operating Hints, 'Out of Range and Error Messages.'

Conversion Table for the PM 5415/18 Command Set to 54200 Commands

**Table 6-4. Conversion Table
 Common Commands and Queries according to IEEE-488.2**

Function	Command for PM 5415/18	Command for 54200
Clear Status	None	*CLS
Standard Event Status Enable	None	*ESE
Operation Complete	None	*OPC
Recall	REC 1...9	*RCL 1...99
Reset	None	*RST
Save	STO 1...9	*SAV 1...99
Service Request Enable	MSR	*SRE
Wait to Continue	None	*WAI
Standard Event Status Enable Query	None	*ESE?
Standard Event Status Register Query	None	*ESR?
Identification Query	ID?	*IDN?
Operation Complete Query	None	*OPC?
Option Query	None	*OPT?
Service Request Enable Query	None	*SRE?
Read Status Byte Query	None	*STB?
Self-test Query	TSI	*TST?
Learn Device Setup Query	IS?	*LRN?

Vision Carrier Setting

Function	Command for PM 5415/18	Command for 54200
Vision carrier frequency	FRQ <NRf> [Hz/Khz/Mhz]	FREQ <NRf> [HZ/KHZ/MHZ/GHZ/K/M/G]
Vision carrier level	None	LEVEL <NRf> [DBUV,Mv,Uv,V]

TV Standard Selection

Function	Command for PM 5415/18	Command for 54200
Pre-defined country list	None	COUNtry <NR1> NR1 = Telephone country code
TV standard PAL	STD PAL [B/G/H/D/I/M/N]	TVSTandard PALB TVSTandard PALD TVSTandard PALG TVSTandard PALI TVSTandard PALK TVSTandard PALM TVSTandard PALN
TV standard NTSC	STD NTSC [M/P]	TVSTandard NTSCM TVSTandard NTSC4B TVSTandard NTSC4D TVSTandard NTSC4G TVSTandard NTSC4I TVSTandard NTSC4K
TV standard SECAM	STD SEC [B/G/H/D/K/L]	TVSTandard SECAMB TVSTandard SECAMG TVSTandard SECAMD TVSTandard SECAMK TVSTandard SECAMK1 TVSTandard SECAML
Group delay precorrection	None	GRPDelay ON/OFF
Residual carrier	None	RESCarrier Low/High
Frame identification SECAM	None	FRAMEid ON/OFF

Video Settings

Function	Command for PM 5415/18	Command for 54200
Test Patterns:		
- Color Bar	PAT CB	PAT COL_100_25 PAT COL_75_25 PAT COL_75_0 PAT COL_SMpte PAT COL_Horz PAT COL_SP_100 PAT COL_SP_75
- Checkerboard	PAT CH	PAT CHEcker
- Circle	PAT CI	PAT CI
- Center Cross	PAT CR	PAT CENTER_2 PAT CENTER_3
- Demodulation	PAT DE	PAT DEM_PAT1 PAT DEM_PAT2

Video Settings

Function	Command for PM 5415/18	Command for 54200
Test Patterns:		
- Digital Scan	PAT DS	PAT DIGI_ADC1 PAT DIGI_ADC2 PAT DIGI_Move PAT DIGI_SCAN1_S PAT DIGI_SCAN1_M PAT DIGI_SCAN2_S PAT DIGI_SCAN2_M PAT DIGI_SCAN3_S PAT DIGI_SCAN3_M
- Dots	PAT DT	PAT DOTS_W PAT DOTS_B
- Greyscale	PAT GS	PAT Greyscale
- Crosshatch	PAT HA	PAT CH_WNN PAT CH_WCN PAT CH_WNT PAT CH_WCT PAT CH_BNN PAT CH_BCN PAT CH_BNT PAT CH_BCT
- Multiburst	PAT MB	PAT Multiburst
- Black pattern (black screen)	PAT OF	PAT Off
- Purity blue cyan green magenta black red white yellow	PAT PB PAT PC PAT PG PM PAT PO PAT PR PAT PW PAT PY	PAT PUR_BLUe PAT PUR_Cyan PAT PUR_Green PAT PUR_Magenta PAT PUR_BLAck PAT PUR_Red PAT PUR_White PAT PUR_Yellow
- Special pattern 1	PAT S1	None
- Special pattern 2	PAT S2	None
- Special pattern 3	PAT S3	None
- Video cassette recorder test	PAT VC	PAT VCR_PAT1 PAT VCR_PAT2 PAT VCR_RES_Std PAT VCR_RES_Hi PAT VCR_Write
- White screen	WH	PAT WH_00 PAT WH_05 PAT WH_7_5 PAT WH_15/20 ... 95/100

Function	Command for PM 5415/18	Command for 54200
Test Patterns:		
- Picture Line Up Generating Equipment (PLUGE)	None	PLUGE
- Color temperature adjusting	None	PAT CTA_Small PAT CTA_Medium PAT CTA_Large CTAB 0/50/100 (%) CTAB 7.5/53.5/100 (IRE) CTAC 0/5/15/20...95/100 (%) CTAC 7.5/15/20...95/100 (IRE)
- Pattern of Insertion-Reference Signal Line 17 (IRS17)	None	PAT Irs 17
Insertion-Reference Signal in line 17/330	None	REFLine ON/OFF
Aspect Ratio	ASP WI ASP NO	ASPR R16_9 ASPR R4_3
Chroma amplitude	CHR OFF/ON	CHRA 0/1/2...150
Video amplitude	None	VIDA 0/1/2...150
Video source	VID INT VID EXT	VIDSO Int VIDSO Extern VIDSO SCart VIDSO BNc VIDSO BMixed VIDSO SMixed
Video polarity	None	VIDP Positive/Negative
SCART output	None	SCARTO Rgb/Y_C/CVBS/CV_Rgb
CVBS status	None	CVBS_stat Off/Auto
RGB sync	None	RGBSYnc Red/Green/Blue/Off

Sound Settings

Function	Command for PM 5415/18	Command for 54200
Sound and vision carrier	OSC ON/OFF	None
Sound system	None	SNDSY AML SNDSY FMMono SNDSY FMGermany SNDSY FMA1 SNDSY FMA2 SNDSY FMKorea SNDSY Btsc SNDSY NICAMB SNDSY NICAMDK SNDSY NICAMDC SNDSY NICAMG SNDSY NICAMI SNDSY NICAML

Function	Command for PM 5415/18	Command for 54200
Sound carrier amplitude	SCA ON/OFF	SC1L Off/-5/-6/-7...-14/-15 SC2L Off/-20/-25/-27
Preemphasis	None	PREEM ON/OFF
Sound source internal	SIN ON/OFF	SNDSO Intern
Sound source external	SEX ON/OFF	SNDSO Extern SNDSO Scart SNDSO Cinch SNDSO Mts
Mono sound	MON	SNDM Mono
Dual sound	DUA	SNDM Dual
Stereo sound	STE	SNDM Stereo
NICAM sound	NIM NID NIS	NICSource Off/Int SNDSY NICAMB/DK/DC/G/I/L and SNDM Mono SNDSY NICAMB/DK/DC/G/I/L and SNDM Dual SNDSY NICAMB/DK/DC/G/I/L and SNDM Stereo
NICAM test signal 1	NT1	SNDM TEST1 (if NICAM on)
NICAM test signal 2	NT2	SNDM TEST2 (if NICAM on)
NICAM test signal 3	NT3	SNDM TEST3 (if NICAM on)
NICAM amplitude	NAP LOW/HIGH	NICA Low/High
Reserve Sound Switching Flag	NRF ON/OFF	RSSF ON/OFF
BTSC mono	MTM	SNDSY Btsc and SNDM Mono
BTSC stereo	MTS	SNDSY Btsc and SNDM Stereo
BTSC test signal 1	MT1	SNDM TEST1 (if BTSC on)
BTSC test signal 2	MT2	SNDM TEST2 (if BTSC on)
BTSC test signal 3	MT3	SNDM TEST3 (if BTSC on)
Second Audio Program	SAP ON SAP OFF SAP MOD SAP UNMOD	SAP Off SAP Modulated SAP Unmodulated

Function	Command for PM 5415/18	Command for 54200
Sound modulation for left channel	SL1 OFF SL1 ON SL3 ON	S1MOD Off S1MOD 0.3Khz S1MOD 0.5Khz S1MOD 1Khz S1MOD 1.5Khz S1MOD 3Khz
Sound modulation for right channel	SR1 OFF SR1 ON	S2MOD Off S2MOD 0.3Khz S2MOD 0.5Khz S2MOD 1Khz S2MOD 1.5Khz S2MOD 3Khz S2MOD 12Khz
Analog sound modulation for NICAM	None Frequency is set with RSSF depending on sound mode.	S3MOD Off S3MOD 0.3Khz S3MOD 0.5Khz S3MOD 1Khz S3MOD 3Khz

Digital Services

Function	Command for PM 5415/18	Command for 54200
Teletext	TTX FLOF TTX TOP TTX ANT TTX OFF	TTXS FLOF1 TTXS FLOF2 TTXS TOP1 TTXS TOP2 TTXS Antiope TTXS Off TTXS CC TTXS AUto
Teletext lines	None	TTXL 4/8
Closed Caption	CLC 0 CLC 1 ... 9	TTXS Off TTX CC;CCN 1 ... 8 / SEQUENCE
Wide Screen Signalling (WSS)	None	WSSM Off/Auto/Manual
WSS data programming	None	WSSD #B and 14 bits

Function	Command for PM 5415/18	Command for 54200
Video Programming System (VPS)	VPS 0 ... 9	VPSN 0 ... 9
VPD data programming	VPP N,TG.MO,ST:MI,LLL, PPP,TTT,R; VPP B,hhhh,hhhh,hhhh,hhhh, hhhh, hhhh, hhhh, hhhh, hhhh, hhhh, hhhh, hhhh, hhhh, hhhh, hhhh;	VPSD N,"DD.MM,HH:MM,CTR, NTW,PTY,R", "string with max. 20 characters" None
Programm Delivery Control (PDC)	PDC 0 ... 9	PDCN 0 ... 9 / Multi
PDC data programming	PDP N,TG.MO,ST:MI,LLL, PPP,TTT,R;FF;	PDCD N,"DD.MM,HH:MM,CTR, NTW,PTY,R,FL", "string with max. 20 characters"

Miscellaneous Commands

Function	Command for PM 5415/18	Command for 54200
Display mode	None	DISP ON/OFF DISP Main/Video/SOUND/ STANDARD/DIGDATA/SUPPORT
Time	TIM YYYY.MM.DD,HH:MM	TIME "YYYY.MM.DD,HH:MM"
Local time offset	LTO +/-HH	LTO +/-HH
Error query	EM?;EN?	ERR?

Device Settings Query

Function	Command for PM 5415/18	Command for 54200
Complete settings	IS?	*LRN?
RF settings	None	RF?
TV system	None	STAN?
Video settings	None	VIDEO?
Sound settings	None	SOUND?
Digital services	None	DIGD?

Chapter 7

Specifications

Title	Page
Safety and EMC Requirements.....	7-3
Performance Characteristics and Specifications	7-3
Video and RF	7-4
Outputs	7-4
CVBS Video.....	7-4
CVBS SYNC, LINE SYNC and FIELD Synchronization.....	7-4
EURO AV Control Voltages	7-4
Terrestrial RF Carrier	7-5
Video Modulation	7-6
Inputs	7-6
Video IN.....	7-6
Video	7-7
Synchronization	7-7
Luminance	7-7
Chrominance.....	7-7
Patterns.....	7-8
Sound	7-10
Outputs	7-10
Sound Carrier.....	7-10
Audio and Euro AV	7-10
BTSC MPX and FM Stereo Pilot	7-10
NICAM Data and NICAM Clock	7-11
Inputs	7-11
Audio, Euro AV and MTS Multiplex	7-11
Mono	7-11
Sound Carrier.....	7-11
Modulation	7-12
Stereo /Dual	7-12
Sound Carrier 1	7-12

Sound Carrier 2	7-12
Modulation.....	7-13
Identification/Subcarrier	7-13
NICAM Stereo	7-13
Sound Carrier 1	7-13
Sound Carrier 2	7-14
Modulation.....	7-14
BTSC Stereo	7-14
Sound Carrier	7-14
Modulation.....	7-15
Identification	7-15
Digital Services	7-16
Wide Screen Signalling (WSS).....	7-16
Teletext DIDON ANTIOPE (CCIR System A)	7-16
Teletext UK (CCIR System B)	7-17
PDC	7-17
VPS	7-17
Closed Caption.....	7-18
RGB, YC (S-VHS/Hi-8), YCrCb Outputs.....	7-19
RGB Outputs.....	7-19
YC Outputs	7-19
YCrCb Outputs	7-19
Feedthrough Connection.....	7-20
IEEE-488 and RS-232 Interface	7-20
IEEE-488 Interface	7-20
RS-232 Interface.....	7-20
General Specifications	7-21
Environmental Conditions	7-21
Power Requirements.....	7-22
Dimensions and Weight.....	7-22
Accessories.....	7-23
Standard	7-23
Optional	7-24

Safety and EMC Requirements

The Fluke 54200 TV Signal Generator complies with the following standards:

EN 61010-1 and IEC 1010-1/ CSA-C22.2 No. 1010.1 (safety requirements)

The 54200 is an instrument for measurement and test including accessories

- Intended for professional, industrial process, and educational use.
- Overvoltage Category II Pollution Degree 2.
- A Class I equipment.

EN 55011 and CISPR 11 (radio interference suppression)

The 54200 is an ISM instrument (industrial, scientific, and medical RF-equipment)

- Group 1,
Intentionally generates and/or uses conductively coupled radio frequency energy which is necessary for the internal functioning of the equipment itself.
- Class B,
Suitable for use in domestic establishments and in establishments directly connected to a low voltage power supply network which supplies buildings used for domestic purposes.

EN 50082-1 (radio frequency immunity)

The 54200 is an instrument for use in any location with the following characteristics:

- Powered directly from the local line power.
- Residential, commercial or light-industrial, both indoor and outdoor.

Performance Characteristics and Specifications

Properties expressed in numerical values with stated tolerance are guaranteed by the manufacturer.

Specified non-tolerance numerical values indicate those that could be nominally expected from the mean of a range of identical instruments.

This specification is valid after the instrument has warmed up for 30 minutes (reference temperature 23 ± 1 °C). If not stated otherwise, relative or absolute tolerances relate to the set value.

Video and RF

Outputs

CVBS Video

Voltage (V_{pp} into 75 Ω)	1 V (nominal setting)
Setting range	0 to 1.5 V
Tolerance of setting	10 mV or 5%, whichever is greater, 5 mV or 2%, whichever is greater, at reference temperature
Step size	1%, 10 mV for internal video
Resolution	10 mV
Impedance	75 Ω
Polarity	Positive/ negative, selectable
Coupling	DC
Luminance/chrominance timing difference	≤ 40 ns
Connector	VIDEO OUT, BNC front, EURO AV OUT, EURO AV connector rear
Max. external voltage	± 9 V

CVBS SYNC, LINE SYNC and FIELD Synchronization

Voltage (V_{pp} into 75 Ω)	2 V
Tolerance	0.3 V
Impedance	75 Ω
Polarity	Negative
Coupling	DC
Connector	SYNC OUT: COMP, LINE; FIELD, BNC rear
Max. external voltage	± 4 V

EURO AV Control Voltages

Aspect Ratio	Pin 8, Automatically or Off
OFF	0 V to +2 V
Ratio 4:3	+9.5 V to +12 V
Ratio 16:9	+4.5 V to +7 V
Impedance	850 Ω

Fast Blanking	Pin 16, Automatically or Off
RGB ON	+1 V to +3 V
RGB OFF	0 V to +0.4 V
Impedance	75 Ω
Max. external voltage	± 9 V

Terrestrial RF Carrier

Frequency	32 to 900 MHz
Tolerance	10 kHz
Resolution	50 kHz
Spectral purity	Harmonics, intermodulation products and spurious -60 dBc inside actual TV channel -30 dBc outside actual TV channel
Voltage (V _{rms} into 75 Ω)	100 mV for high range 10 mV for low range
Attenuation	0 to 80 dB for high range 0 to 60 dB for low range
Readout	mV, dB μ V
Resolution	0.01 mV for level \leq 10 mV 0.1 mV for level $>$ 10 mV 1 dB for dB μ V indication
Tolerance	3 dB
Impedance	75 Ω
Modulation	Internal, external
Connector	RF OUT, BNC front
Max. external voltage	± 7 V

Video Modulation

Double sideband AM, internal/external switchable

TV Systems	All systems except L	SECAM L
Polarity	Negative	Positive
RF sync level:		
Residual carrier low	100%	10%
Residual carrier high	100%	20% * ²
RF 100% white level:		
Residual carrier low	10% * ¹	100%
Residual carrier high	20%	100%
	* ¹ not available for NICAM sound systems	* ² only available with NICAM sound

Group delay pre-correction

Reference	Related to CCIR Rep. 624-4, 1990	
Types	2 different types (or off) Automatically switched with the respective TV system	
TV systems	B, G, N	PAL M, NTSC M
Characteristics	Closely matches CCIR B, G (type A)	Closely matches CCIR M/PAL, M/NTSC

Inputs

Video IN

Voltage (V _{pp})	1 V (nominal)
Setting range	100% fixed for video modulation 0 to 150% for video outputs
Tolerance of setting	10 mV or 5%, whichever is greater, 5 mV or 2%, whichever is greater, at reference temperature
Step size	1%
Superimposed dc component	-2 V to +2 V
Max. voltage (V _{pp} + dc)	-5 V to +5 V
Impedance	75 Ω
Polarity	Positive
Coupling	DC
Connector	VIDEO IN, BNC front, EURO AV IN, EURO AV connector rear

Video

Synchronization

Reference	CCIR Rep. 624-4, 1990 ANSI/SMPTE 170M-1994
System	625 lines (50 Hz) 525 lines (59.94 Hz)
Line frequency	15.625 kHz for 625 line systems 15.734265 kHz for 525 line systems
Tolerance	3 ppm for +5 to +45 °C 1 ppm at reference temperature
Aging	≤ 2 ppm per year
Level	-43% for 625 line systems -40 IRE for 525 line systems
Tolerance	3% for 625 line systems 3 IRE for 525 line systems

Luminance

Reference	CCIR Rep. 624-4, 1990 ANSI/SMPTE 170M-1994
Blanking level	0% (0 IRE)
Black level	0% for 625 line systems +7.5 IRE for 525 line systems
White level	100% (100 IRE)
Tolerance	2% for 625 line systems at reference temperature 2 IRE for 525 line systems at reference temperature

Chrominance

Reference	CCIR Rep. 624-4, 1990 ANSI/SMPTE 170M-1994
System	PAL B, D, G, I, K, M, N NTSC M NTSC with 4.433619 MHz subcarrier SECAM B, D, G, K, K1, L
Carrier frequency	4.433619 MHz for PAL B, D, G, I, K and NTSC 4.43 3.575611 MHz for PAL M 3.582056 MHz for PAL N 3.579545 MHz for NTSC M 4.406250 MHz and 4.250000 MHz for SECAM
Tolerance	3 ppm for +5 to +45 °C 1 ppm at reference temperature
Aging	≤ 2 ppm per year

Phase tolerance (PAL/NTSC)	2°, 1° at reference temperature
Freq. deviation (SECAM)	
Δf_{OB} (75% blue)	+230 kHz
Tolerance	4 kHz
Δf_{OR} (75% red)	-280 kHz
Tolerance	5 kHz
Level	100% (nominal setting)
Tolerance	5% (PAL/NTSC) 10% (SECAM) 2% (PAL/NTSC) at reference temperature for nominal setting
Setting range	0% to 150%
Tolerance of setting	1 step or 5%, whichever is greater
Resolution	1%

Patterns

Reference	ITU Rec. 471-1/1994 and SMPTE EG27-1994 for Color Bar SMPTE EG1-1990 for SMPTE Color Bar CCIR Rec. 473-5,1990 and CCIR Rec. R26-1981 for IRS 17 CCIR Rec. 473-5,1990 for Multiburst CCIR Rep. 1221 for PLUGE
Aspect ratio	4:3, 16:9
Circle	Centered circle with 4 additional corner circles in 16:9 mode
Center Cross	With border castellations (overscan indication selectable between 2% or 3%)
White	0, 5, 15 to 100% (5% steps) for 625 line systems 7.5, 15 to 100 IRE (5 IRE steps) for 525 line systems
Purity	Red, green, blue, cyan, magenta, yellow, white, black (100/0/75/0 for 625 line systems and 100/7.5/75/7.5 for 525 line systems)
Dots	17x13 dots in 4:3 mode, 23x13 dots in 16:9 mode With center indication
Crosshatch	18x14 lines in 4:3 mode, 24x14 lines in 16:9 mode With center indication, selectable 'top-left' indication and chroma

Checkerboard	12x9 squares in 4:3 mode, 16x9 squares in 16:9 mode
PLUGE	-1.6, 0, +1.6, 100% for 625 line systems 4.8, 7.5, 10.7, 100 IRE for 525 line systems
Greyscale	10 steps linear staircase
VCR	VCR Test (2 types) Resolution Test (2 types) Writing Current
Multiburst	0.5, 1.0, 2.0, 4.0, 4.8, 5.8 MHz for 625 line systems 0.5, 1.0, 2.0, 3.0, 3.58, 4.2 MHz for 525 line systems With time intervals
Digital Scan	ADC Check (2 types) Moving Block Progressive Scan Check (3 types)
Color Bar	75/0/75/0, 100/0/75/0, 75/0/100/25, 100/0/100/25 for 625 line systems 75/7.5/75/7.5, 100/7.5/75/7.5 for 525 line systems SMPTE Color Bar Horizontal Color Bar (75/0/75/0 for 625 line systems and 75/7.5/75/7.5 for 525 line systems)
DEM	Demodulator Test (2 types)
Color Temperature	3 different sizes with adjustable levels for center and border
Diverse	EHT Test (Reference rectangle with switching white/black window) Full field 'IRS 17', (in 625 line systems, reference line 17 can be selected separately)
Pattern combination	Circle with every other pattern (except Progressive Scan 3) or combination Center Cross / Crosshatch / Dots / Purity Greyscale / White / Multiburst / Color Bar

Sound

Outputs

Sound Carrier

Voltage (V _{pp} into 50 Ω)	142 mV for mono carrier and system B, G 200 mV for mono carrier and system D, I, K, K1, L, M, N 63.2 mV for stereo and NICAM B, G, D, I, K carrier (sound carrier 2) 28.3 mV for NICAM L carrier (sound carrier 2)
Setting range	for mono carrier (depends on sound carrier 1 level setting): 112.5 mV to 356 mV at -15 dBc to -5 dBc sound carrier level
Resolution	1 dB
Setting range	for stereo and NICAM carrier: 63.2 mV at -20 dBc sound carrier level 35.6 mV at -25 dBc sound carrier level 28.3 mV at -27 dBc sound carrier level
Tolerance	2 dB
Impedance	50 Ω
Connector	SOUND IF OUT, BNC rear

Audio and Euro AV

Voltage (V _{rms} in open circuit)	500 mV, 278 mV at 12 kHz intern in NICAM mode
Tolerance	5%
Impedance	600 Ω
Connector	AUDIO OUT, Cinch rear, EURO AV OUT, EURO AV connector rear

BTSC MPX and FM Stereo Pilot

Impedance	600 Ω
Connector	MTS/PILOT OUT, BNC rear
Voltage (V _{rms} open circuit)	Nominal
BTSC mode	BTSC baseband signal
Main channel	500 mV, at 13.5 kHz deviation
Pilot carrier	185 mV, equivalent to ±5 kHz deviation of sound carrier
SAP carrier	555 mV, equivalent to ±15 kHz deviation of sound carrier
Tolerance	5%

Stereo / Dual mode for sound systems	Germany, A2
Pilot signal	90 mV
Tolerance	5%

Stereo / Dual mode for sound system	Mk
Pilot signal	180 mV
Tolerance	5%

NICAM Data and NICAM Clock

Frequency	728 kHz
Tolerance	3 ppm for +5 to +45 °C 1 ppm at reference temperature
Aging	≤2 ppm per year
Voltage (V _{pp} into 50 Ω)	1 V
Tolerance	10%
Impedance	50 Ω
Connector	NICAM OUT DATA, BNC rear NICAM OUT CLOCK, BNC rear

Inputs

Audio, Euro AV and MTS Multiplex

Voltage (V _{rms})	500 mV (nominal)
Modulation bandwidth	40 Hz to 15 kHz
Impedance	0.1 MΩ
Connector	AUDIO IN, Cinch rear, EURO AV IN, EURO AV connector rear, MTS IN, BNC rear
Max. external voltage	±40 V

Mono

Sound Carrier

Frequency	4.5 MHz for system M, N 5.5 MHz for system B, G 6.0 MHz for system I 6.5 MHz for system D, K, K1, L
Tolerance	3 ppm for +5 to +45 °C 1 ppm at reference temperature

Aging	≤ 2 ppm per year
Level	-13 dBc for system B, G -10 dBc for system D, I, K, K1, L, M, N
Tolerance	2 dB at reference temperature
Setting range	-5 dBc to -15 dBc
Tolerance	2 dB at reference temperature
Resolution	1 dB

Modulation

Frequency	0.5, 1.0, 3.0 kHz: for system B, D, G, I, K, K1, L (S1 Modulation) or off 0.3, 1.0, 3.0 kHz: for system M and N (S1 Modulation) or off 0.5, 1.0, 3.0 kHz: (S3 Modulation) or as NICAM for system NICAM B/G, NICAM DK, DC, I, L or off
Type	FM for system B, D, G, I, K, K1, M, N AM for system L
Deviation	27 kHz for system B, D, G, I, K, K1 (pre-emphasis off), 13.5 kHz for system M, N (pre-emphasis off)
Tolerance	5%
Pre-emphasis (FM)	50 μs for system B, D, G, I, K, K1 or off 75 μs for system M, N or off
Modulation depth	54% for system L
Tolerance (absolute)	5%

Stereo /Dual

Sound Carrier 1

Data	As Mono
Modulation matrix: Stereo	(L+R)/2
Dual	CH1 (S1 Modulation)

Sound Carrier 2

Frequency	5.7421875 MHz for system B, G 6.2578125 MHz for system D, K (A2) 4.724 MHz for system Mk
Tolerance	3 ppm for +5 to +45 °C 1 ppm at reference temperature
Aging	≤ 2 ppm per year
Level	-20 dBc
Tolerance	3 dB at reference temperature

Setting range	-20, -25, -27 dBc
Tolerance	3 dB at reference temperature

Modulation

Frequency	0.5, 1.0, 3.0 kHz for system B, D, G, K or off 0.3, 1.0, 3.0 kHz for system Mk or off
Type	FM
Deviation	27 kHz for system B, D, G, K (pre-emphasis off) 13.5 kHz for system Mk (pre-emphasis off)
Tolerance	5%
Pre-emphasis	50 μ s for system B, D, G, K or off 75 μ s for system Mk or off
Modulation matrix:	
Stereo	L for systems B, D, G, K L-R for system Mk
Dual	CH2 (S2 Modulation)

Identification/Subcarrier

Reference	CCIR Rec. 707
Pilot carrier frequency	$3.5 \times f_H$
Identification frequency	$f_H / 133$ for stereo and system B, D, G, K $f_H / 105$ for stereo and system Mk $f_H / 57$ for dual
Tolerance	3 ppm for +5 to +45 °C 1 ppm at reference temperature
Aging	≤ 2 ppm per year
Type	AM
Modulation depth	50%
Tolerance (absolute)	5%

NICAM Stereo

Sound Carrier 1

Data	As MONO SOUND CARRIER
Modulation matrix:	
Mono	As NICAM (S1 Modulation) or independent selectable (S3 Modulation)
Stereo	(L+R)/2
Dual	CH1 (S1 Modulation)

Sound Carrier 2

Frequency	5.85 MHz for system B, D, G, K, L 6.875 MHz for system D, K 6.552 MHz for system I
Tolerance	3 ppm for +5 to +45 °C 1 ppm at reference temperature
Aging	≤ 2 ppm per year
Level	-20 dBc for system B, D, G, I, K -27 dBc for system L
Tolerance	3 dB at reference temperature
Setting range	-20, -25, -27 dBc
Tolerance	3 dB at reference temperature

Modulation

Reference	NICAM-728 CCITT Rec J17
Frequency	0.5, 1.0, 1.5, 3.0 kHz for channel 1 (S1 Modulation) or off 1.0, 1.5, 3.0, 12 kHz for channel 2 (S2) or off Test 1: Demodulator pattern Test 2: Decoder pattern Test 3: Unmodulated carrier
Type	QPSK
Mode	Mono, Dual, Stereo, Test
Bit-rate	728 kbits/s
Tolerance	3 ppm for +5 to +45 °C 1 ppm at reference temperature
Aging	≤ 2 ppm per year
Level	High, low
RSSF	On, off

BTSC Stereo**Sound Carrier**

Frequency	4.5 MHz for system M
Tolerance	3 ppm for +5 to +45 °C 1 ppm at reference temperature
Aging	≤ 2 ppm per year

Level	-10 dBc
Tolerance	2 dB at reference temperature
Setting range	-5 to -15 dBc
Tolerance	2 dB at reference temperature
Resolution	1 dB

Modulation

Frequency	0.3, 1.0, 3.0 kHz for channel 1 (S1 Modulation) or off 1.0, 3.0 kHz for channel 2 (S2 Modulation) or off 3.1 kHz and 8.0 kHz in Test modes 5.0 kHz for SAP (0.3 and 1.0 kHz in Test modes) or unmodulated or off
Type	FM with BTSC base band
Base band	Main channel (L+R) Pilot subcarrier Stereo sub channel (L-R, BTSC compressed) SAP sub channel (SAP signal, BTSC compressed)
Stereo sub channel	Subcarrier AM modulated with suppressed carrier by BTSC compressed L-R signal
SAP sub channel	Subcarrier FM modulated by SAP signal
Mode	Mono, Stereo, SAP
Deviation	13.5 kHz (with de-emphasis on) 15 kHz by SAP 5 kHz by pilot
Tolerance	5%
Pre-emphasis	75 μ s

Identification

Pilot subcarrier frequency	f_H
Stereo subcarrier frequency	$2 \times f_H$
SAP subcarrier frequency	$5 \times f_H$
Tolerance subcarrier	3 ppm for +5 to +45 °C 1 ppm at reference temperature
Aging	≤ 2 ppm per year

Digital Services

Wide Screen Signalling (WSS)

Reference	ETSI, ETS 300 294, November 1994 PALplus System Description, Revision 3.0, January 1994 Rec. ITU-R BT.1119
TV systems	625 line systems
Data line	23 (field 1)
Signalling method	Bi-phase coding, NRZ-L
Clock frequency	5 MHz
Tolerance	3 ppm for +5 to +45 °C 1 ppm at reference temperature
Aging	≤ 2 ppm per year
Level	0.5 V for '1' at 0.7 V maximum video level Black level for '0'
Tolerance	5% for '1' 3% of sync amplitude for '0'

Teletext DIDON ANTIOPE (CCIR System A)

Reference	CCIR Rec. 653-1 CCIR Doc. 11/345-E
TV systems	625 line systems
Data line	20, 21, 333, 334
Signalling method	Binary NRZ
Clock frequency	6.203125 MHz
Tolerance	3 ppm for +5 to +45 °C 1 ppm at reference temperature
Aging	≤ 2 ppm per year
Level	7/3 of sync amplitude for '1' Black level for '0'
Tolerance	0 to -10% for '1' 3% of sync amplitude for '0'

Teletext UK (CCIR System B)

Reference	CCIR Rec. 653-1 CCIR Doc. 11/282-E
System	625 line systems
Data line	13, 14, 20, 21, 326, 327, 333, 334 for 8 line mode (PAL) 20, 21, 333, 334 for 4 line mode (PAL and SECAM)
Signalling method	Binary NRZ
Clock frequency	6.9375 MHz
Tolerance	3 ppm for +5 to +45 °C 1 ppm at reference temperature
Aging	≤ 2 ppm per year
Level	66% of the difference between black level and peak white level for '1' Black level for '0'
Tolerance	6% for '1' 2% of the difference between black level and peak white level for '0'

PDC

Reference	EBU SPB 459 Revision 2 Specification of the Domestic Video Programme Delivery Control System February 1992
System	TELETEXT UK (CCIR system B)
Programming	All parameters
Labelling	Single, multi

VPS

Reference	Technische Richtlinie ARD/ZDF Nr. 8 R 2 Video Program System EBU SPB 459 Revision 2 Specification of the Domestic Video Programme Delivery Control System February 1992
TV systems	625 line systems
Data line	16
Signalling method	Bi-phase modulation

Clock frequency	5.0 MHz
Tolerance	3 ppm for +5 to +45 °C 1 ppm at reference temperature
Aging	≤ 2 ppm per year
Level	0.5 V for '1' at 0.7 V maximum video level Black level for '0'
Tolerance	5% for '1' 3% of sync amplitude for '0'
Programming	All parameters

Closed Caption

Reference	FCC 47 CFR Part 15 Report No E-7709-C Draft EIA-608
System	525 line systems 625 line systems
Data line	21 (field 1 and field 2)
Signalling method	Binary NRZ
Clock frequency	503.4965 kHz for 525 line systems 500 kHz for 625 line systems
Tolerance	3 ppm for +5 to +45 °C 1 ppm at reference temperature
Aging	≤ 2 ppm per year
Level	50 IRE (50%) for '1' 0 IRE (0%) for '0'
Tolerance	5 IRE (5%) for '1' 1 IRE (1%) for '0'
Operation mode	CC1 to CC4 T1 to T4

RGB, YC (S-VHS/Hi-8), YCrCb Outputs

RGB Outputs

Voltage (V _{pp} into 75 Ω)	700 mV
Tolerance	5% 2% at reference temperature
Impedance	75 Ω
Polarity	Positive
Coupling	DC
Blanking level	0 V
Offset	± 200 mV
Synchronization	Selectable in R, G, B or Off (only for BNC outputs)
Connector	RGB OUT, BNC rear, EURO AV OUT, EURO AV connector rear
Max. external voltage	±9 V

YC Outputs

Luminance signal amplitude (V _{pp} into 75 Ω)	1 V (including sync)
Tolerance	5% 2% at reference temperature
Coupling	DC
Blanking level	0 V
Offset	± 200 mV
Chrominance signal level	100%, same as chrominance part of CVBS signal
Tolerance	5% 2% at reference temperature
Coupling	AC
Impedance	75 Ω
Connector	Y/C OUT, 4-pin S connector, EURO AV OUT, EURO AV connector rear
Max. external voltage	±9 V

YCrCb Outputs

Voltage Y (V _{pp} into 75 Ω)	1 V (including Sync)
Voltage CrCb (V _{pp} into 75 Ω)	0.7 V
Tolerance	5% 2% at reference temperature

Impedance	75 Ω
Coupling	DC
Blanking level	0 V
Offset	± 200 mV
Connector	Y/ C _R / C _B OUT, BNC rear
Max. external voltage	± 9 V

Feedthrough Connection

Connection between rear and front, BNC connectors, not recommended for vision carrier.

TO REAR	connected with TO FRONT
TO FRONT	connected with TO REAR
Connector	TO REAR, BNC front TO FRONT, BNC rear

IEEE-488 and RS-232 Interface

IEEE-488 Interface

Allows selection and control of all functions

Instrument command set	see Chapter 6, Remote Control
Reference	ANSI/IEEE Std. 488-1987
Compatibility	IEEE-488.2-1987
Interface functions	AH1, SH1, L4, T6, RL1, SR1, DC1, E2
Connector	Amphenol rear (RFI/EMI shielded)

RS-232 Interface

Allows selection and control of all functions

Instrument command set	see Chapter 6, Remote Control
Baud rate	110, 150, 300, 600, 1200, 2400, 4800, 9600, or 19200
Data bits	7 or 8
Stop bits	1, 2 for 110 Baud
Parity check	Odd, even or none (none for 8 data bits only)
Handshake	Software, hardware
Connector	9 pin D-type rear (male)

General Specifications

Environmental Conditions

Environment	Laboratory equipment Class 5 (MIL-T-28800D)
Warming-up time	30 min
Temperature	+22 to +24 °C for reference temperature 0 to +50 °C for operating -20 to +71 °C for non-operating
Humidity	Relative humidity (MIL-T-28800D)
Operating (no condensation)	
+0 °C to 10 °C	not controlled
+11 °C to 30 °C	95% ±5%
+31 °C to 40 °C	75% ±5%
+41 °C to 50 °C	45% ±5%
Non-operating	5% to 95%
Altitude	(MIL-T-28800D)
Operating	3,050 m (10,000 ft)
Non-operating	4,570 m (15,000 ft)
Vibration	(MIL-T-28800D)
Operating	0.33 mm _{p-p} at 5 Hz to 55 Hz (2 g at 55 Hz)
Non-operating	0.70 mm _{p-p} at 10 Hz to 55 Hz, 5 g at 55 Hz to 150 Hz
Shock	(MIL-T-28800D)
Operating, Functional,	18 shocks/20 g
Transport	1 corner / 6 surfaces, drop height 0.67 m
Safety	EN 61010-1 +/A2, Class I IEC 1010-1 +A1 +A2, Class I CAN/CSA-C22.2 No 1010.1, Class I
EMC emission	EN 55011, Group 1, Class B VDE 0875, Part 11, Group 1, Class B CISPR 11, Group 1, Class B FCC Part 15J Class A
EMC immunity	EN 50082-1 (Generic)
RF EM field	IEC 801-3/84 (27-500 MHz, 3V/m)
Electrostatic discharge	IEC 801-2/84 (±8 kV air discharge)
Fast transient	IEC 801-4/88 (0.5 kV signal/ control lines, 1 kV mains)
Additional:	
RF EM field	ENV 50140 / 93 (80-1000 MHz, 3V/m)
Electrostatic discharge	IEC 1000-4-2 / 95 (±8 kV air discharge), (±4 kV contact discharge)
Magnetic Field	IEC 1000-4-8 /93 (50 Hz, 3 A/m)
Recalibration interval	12 months
Reliability	MTBF = 20,000 hours

Power Requirements

Rated line voltage range	100 to 240 V
Line voltage fluctuation	±10%
Rated line frequency range	50 to 60 Hz
Line frequency fluctuation	±5%
Power consumption	60 W

Dimensions and Weight

Width	323 mm (12.72 in)
Height	147 mm (5.79 in) 132.5 mm (5.22 in) without feet (\approx 3HE)
Depth	417 mm (16.42 in)
Weight	Net 9.8 kg (21.6 lb.) Shipping 11.4 kg (25.1 lb.)

Accessories

Standard

- Users Manual
- Power cable
- RF cable BNC - IEC 169-2 male connector
- IEC 169-2 male - F-male adapter
- Y/C cable only with RGB option
- SCART - SCART cable
- Cable SCART - 3 x Cinch cable

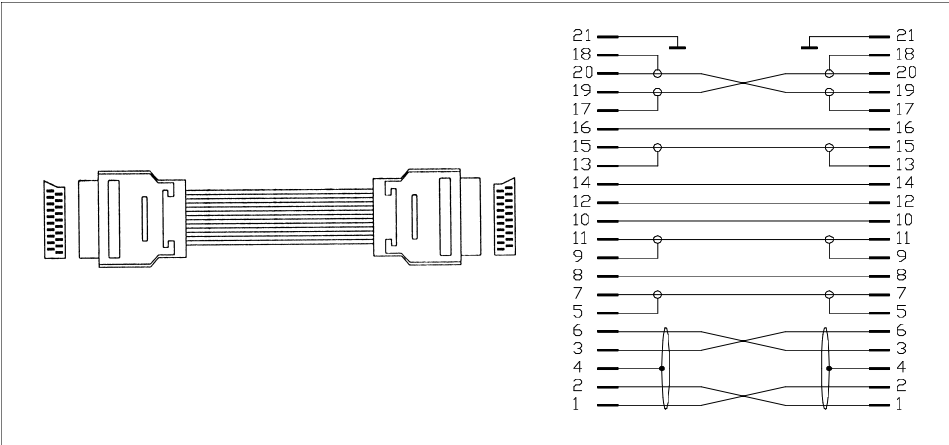

Figure 7-1. SCART - SCART Cable

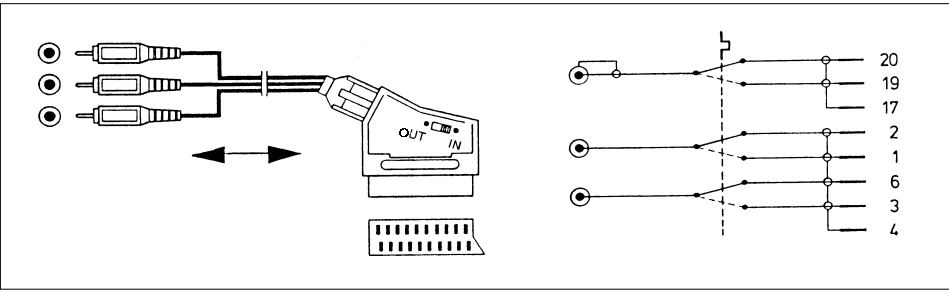

Figure 7-2. SCART - 3 x Cinch Cable

Optional

19" rack mount adapter	Order no. 54091
BNC - BNC Cable, 75 Ω	Order no. PM 9075
IEEE-bus cable, 1 m	Order no. PM2295/10
IEEE-bus cable, 2 m	Order no. PM2295/20
RS-232 cable, 3 m	Order no. PM9536/041
Users Manual, US-English	Order no. 4822 872 10182
Bedienungs-Handbuch, German	Order no. 4822 872 10183
Mode d'emploi, French	Order no. 4822 872 10184
Service Manual 54200/54100	Order no. 4822 872 15185
Service installable options:	
PAL TV standard	Order no. 54911
NTSC TV standard	Order no. 54912
SECAM TV standard	Order no. 54913
Teletext + WSS	Order no. 54921
PDC + VPS incl. Teletext and WSS	Order no. 54922
Closed Caption	Order no. 54923
RGB + YC + YCrCb outputs	Order no. 54931
IEEE + RS-232 interface	Order no. 54932
Analog stereo sound (German, Korean, and DK stereo)	Order no. 54961
NICAM stereo sound	Order no. 54962
BTSC stereo sound	Order no. 54963

Chapter 8

Brief Functional Test

Title	Page
Brief Functional Test.....	8-3
Introduction.....	8-3
Recommended Test Equipment	8-3
Self-Test Routine	8-4
Function Verification.....	8-5
TV Standard PAL.....	8-5
Video Part, using RF Connection	8-5
Video Part, using Y/C Connection (S-VHS, Hi-8).....	8-7
Sound Part	8-8
Teletext, VPS, PDC, and WSS (Digital Services).....	8-12
Wide Screen Signalling Bits (WSS)	8-14
TV Standard NTSC.....	8-15
Video Part, using RF Connection	8-15
Video Part, using Y/C Connection (S-VHS, Hi-8).....	8-17
Sound Part	8-18
Closed Caption (Digital Service CC).....	8-21
TV Standard SECAM.....	8-23
Video Part, using RF Connection	8-23
Video Part, using Y/C Connection (S-VHS, Hi-8).....	8-25
Sound Part	8-26
Teletext, VPS, PDC, and WSS (Digital Services).....	8-29

Brief Functional Test

Introduction

The information in the following paragraphs contains the functional test of the key parameters of the Fluke 54200 TV Signal Generator.

If you want to check the specifications of the generator in detail, you can use the Performance Test in the Service Manual, order number 4822 872 15185. For the Performance Test, special TV-Test Equipment, for example, a video analyzer (Tektronix VM700A) is necessary.

This Brief Functional Test may be used as an acceptance test upon receipt of the instrument, as an indication that repair and/or adjustment is required, or as an functional test after repair or adjustment of the instrument. This test describes a check of an instrument with all options built-in. If an option is not built-in in the instrument under test, please skip the corresponding steps.

When you have finished the Brief Functional Test or if you abort the test, you should perform **RECALL 0** to set the instrument in a defined default status, see Chapter 6, ‘*RST Reset Command.’

Recommended Test Equipment

TV Receiver, Multi System with:

- Analog stereo sound
- NICAM-sound
- Teletext
- RGB & Y/C input,

for example, Philips 25PT 8302

TV Receiver, NTSC-System with:

- BTSC-sound
- Closed Caption,

for example, Magnavox P2783 C101 / Philips 27V505-00A

Oscilloscope with:

- TV/Line trigger

for example, Fluke PM3382A/061

Self-Test Routine

After power on the instrument performs a self-test routine of the PROM, processor RAM, stored instrument settings, calibration data, and available digital modules. After approximately 2 seconds the generator automatically recalls its instrument state before power off.

If a fault is found during the self-test this fault is indicated as follows,

for example:

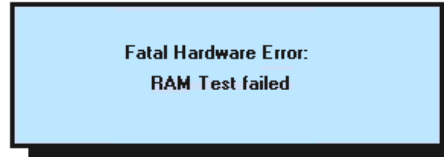

For detailed information see the end of Chapter 5, 'Operating Hints, Out of Range and Error Messages.'

Function Verification

TV Standard PAL

Video Part, using RF Connection

Procedure:

- Connect the **RF OUT** of the TV Signal Generator to the antenna input of the TV. Use an appropriate connection cable, for example, the attached cable BNC to TV.
- Load the default settings of the generator with **RECALL 0**.
- Press the **enter** softkey (F5) to return to the **main** screen.

The display of the generator shows:

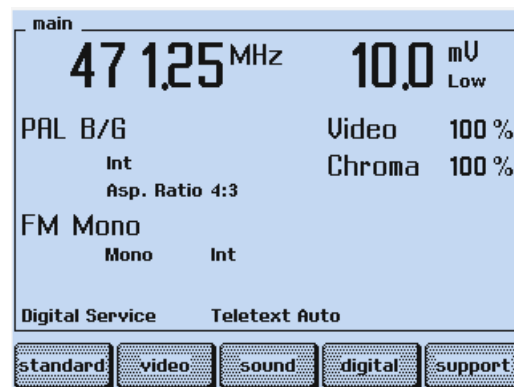

Figure 8-1. Generator Settings, PAL Standard

- Set the TV to a vision carrier frequency of 471.25 MHz. If your TV does not support this frequency, set the generator to an appropriate frequency.
- Press the **COLOR BAR** key longer than one second.
- Select with the **↑** or **↓** softkey (F1 or F2) **COL_100_0**.
- Press the **enter** softkey (F5) to confirm the setting.
- Add the test patterns **GREYSCALE**, **MULTIBURST**, **CIRCLE** with the keys in the **PATTERN** field.

Test Result Requirement:

The TV shows the following pattern and reproduces a mono sound with 1 kHz modulation:

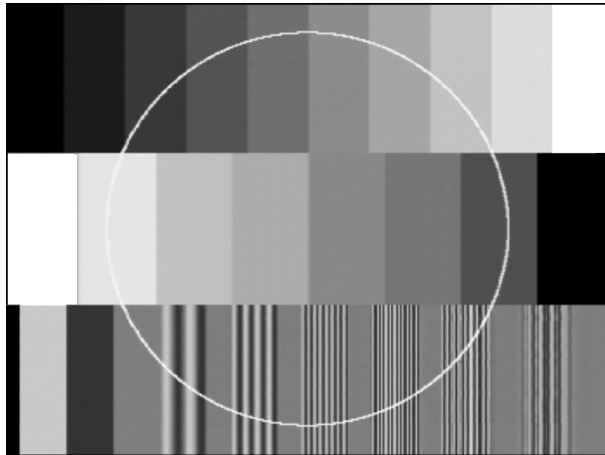

Figure 8-2. Combined Test Pattern, PAL Standard

The complete pattern is only shown by professional TV monitors. Common TV receivers do not show the edges of the pattern.

For details about the test patterns, see Chapter 4, 'Description and Application of Test Patterns.'

- Press the **CHROMA ON/OFF** key.
The TV shows the Color Bar in the middle of the screen in grey.
- Select **Aspect Ratio 16:9** using the **video** submenu.
The TV shows an ellipse instead of the circle and four additional ellipses in the corners of the screen. Select Aspect Ratio 16:9 on your TV. Some modern TVs automatically change the Aspect Ratio controlled by the WSS bits. The TV now shows geometrical circles.

- Switch the TV and the generator to Aspect Ratio 4:3.
- Press the **DIGITAL SCAN** key longer than one second.
- Select with the **↑** or **↓** softkey (F1 or F2) **DIGI_SCAN3_M**.
- Press the **enter** softkey (F5) to confirm the setting.
The TV shows the following pattern, moving from left to right. If you do not use a 100 Hz TV receiver, the three left lines flicker.

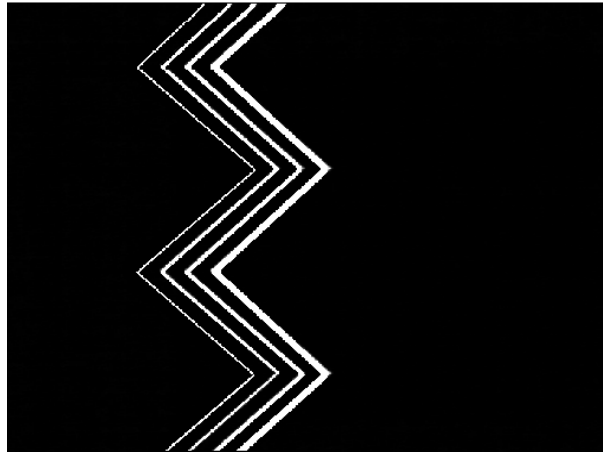

Figure 8-3. Progressive Scan Check 3

- Reduce the vision carrier amplitude to 0.01 mV.
The TV shows noise or a 'No Picture' indication.

Video Part, using Y/C Connection (S-VHS, Hi-8)

Procedure:

- Set the generator with **RECALL 0** to its default settings.
- Press the **enter** softkey (F5) to return to the **main** menu.
- Remove the connection cable from the **RF OUT** of the generator and the antenna input of the TV.
- Connect the generator using **Y/C OUT** on the rear panel to the Y/C input of the TV.
Use the attached Y/C cable.
- Set the TV to Y/C (S-VHS, Hi-8) input.
- Select the combined test pattern as described on Page 8-5.

Test Result Requirement:

The TV reproduces the test pattern shown in Figure 8-2, without sound.

Sound Part

Analog Mono

Procedure:

- Remove the Y/C cable.
- Connect the RF OUT of the TV Signal Generator to the antenna input of the TV.
- Set the TV to antenna input.
- Load the default settings of the generator with **RECALL 0**.
- Press the **enter** softkey (F5) to return to the **main** menu.
- Depending on the sound system you want to check, select the appropriate sound settings using the Pre-defined Country List in the **standard** submenu:
Germany for **FM Germany** (Mono and Analog Stereo for PAL B/G)
Czech. Republic for **FM A2** (Mono and Analog Stereo for PAL D/K)
- Press the **enter** softkey (F5) to confirm your setting and to return to the **main** menu.
- Select the **sound** submenu with the **sound** softkey (F3).

The display shows:

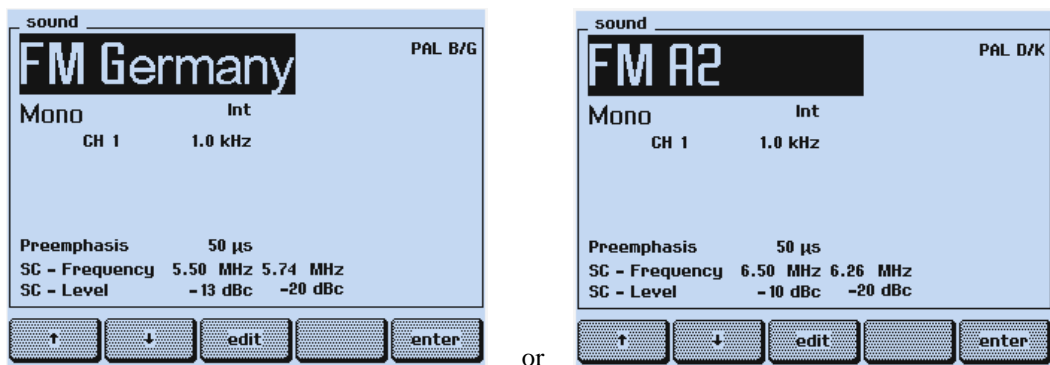

Figure 8-4. Sound Settings

Test Result Requirement:

The TV reproduces a sound with 1 kHz modulation in both channels.

- Press the **CH1** key longer than one second and select **3.0 kHz** in the popup menu.
- Press the **enter** softkey (F5) to confirm the setting and to return to the **main** menu.
The TV reproduces a sound with 3 kHz modulation in both channels.

Analog Stereo

Procedure:

- Same settings as above.
- Press the **STEREO** key.

The display shows:

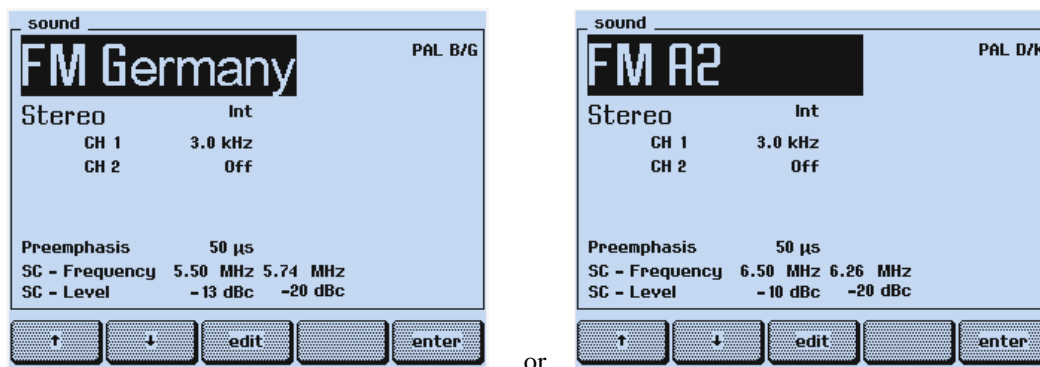

Figure 8-5. Analog Stereo Sound Settings

Test Result Requirement:

The TV shows a 'Stereo' indication (depends on used TV) and reproduces a sound with 3 kHz modulation in the left channel (**CH 1**). The right channel (**CH 2**) reproduces no sound.

- Press the **CH2** key longer than one second and select **1.0 kHz** in the popup menu.
- Press the **enter** softkey (F5) to confirm the setting.
The TV reproduces a sound with 3 kHz modulation in the left channel and a sound with 1 kHz modulation in the right channel.

Dual Sound

Procedure:

- Same settings as above.
- Press the **DUAL/SAP** key.
The display shows the label **Dual** instead of **Stereo**.

Test Result Requirement:

The TV shows a 'Dual Sound' indication (depends on used TV).

- Set the TV to Dual I (**CH 1**).
The TV reproduces a sound with 3 kHz modulation in both channels.
- Set the TV to Dual II (**CH 2**).
The TV reproduces a sound with 1 kHz modulation in both channels.

NICAM Sound

NICAM Mono

Procedure:

- Load the default settings of the generator with **RECALL 0**.
- Press the **enter** softkey (F5) to return to the **main** menu.
- Depending on the sound system you want to check, select the appropriate sound settings using the Pre-defined Country List in the **standard** submenu:
Sweden for **NICAM B/G** for PAL B/G
United Kingdom for **NICAM I** for PAL I
China for **NICAM DK** for PAL D/K
- Press the **enter** softkey (F5) to confirm your setting and to return to the **main** menu.
- Select the **sound** submenu with the **sound** softkey (F3).

The display shows, for example, for NICAM B/G or NICAM I:

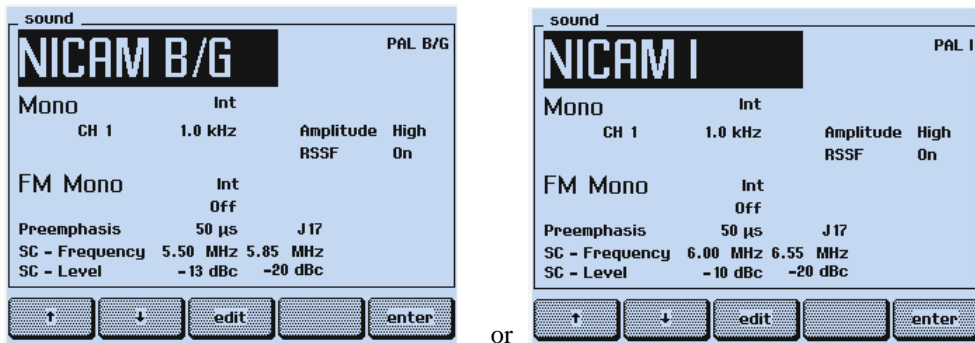

Figure 8-6. NICAM Sound Settings

Test Result Requirement:

The TV shows a 'Digital Sound' indication (depends on used TV) and reproduces a sound with 1 kHz modulation in both channels.

- Press the **CH1** key longer than one second and select **3.0 kHz** in the popup menu.
- Press the **enter** softkey (F5) to confirm the setting.
The TV reproduces a sound with 3 kHz modulation in both channels.

NICAM Stereo

Procedure:

- Same settings as above.
- Press the **STEREO** key.

Test Result Requirement:

The TV shows a 'Stereo' indication (depends on used TV) and reproduces a sound with 3 kHz modulation in the left channel (**CH 1**). The right channel (**CH 2**) reproduces no sound.

- Press the **CH2** key longer than one second and select **1.5 kHz** in the popup menu.
- Press the **enter** softkey (F5) to confirm the setting.
The TV reproduces a sound with 3 kHz modulation in the left channel and a sound with 1.5 kHz modulation in the right channel.

NICAM Dual Sound

Procedure:

- Same settings as above.
- Press the **DUAL/SAP** key.
The display shows the label **Dual** instead of **Stereo**.

Test Result Requirement:

The TV shows a 'Dual Sound' indication (depends on used TV).

- Set the TV to Dual I (**CH 1**).
The TV reproduces a sound with 3 kHz modulation in both channels.
- Set the TV to Dual II (**CH 2**).
The TV reproduces a sound with 1.5 kHz modulation in both channels.

NICAM, Conventional Analog FM Sound

Procedure:

- Same settings as above.
- Select with the **↑** or **↓** softkey (F1 or F2) the label **Off** below **FM Mono Int.**
- Press the **edit** softkey (F3) and select **0.5 kHz** in the popup menu.
- Press the **enter** softkey (F5) to confirm the setting.

The display shows:

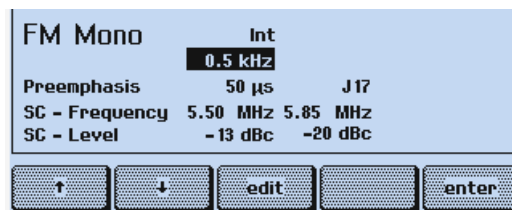

Figure 8-7. NICAM, Analog FM Sound

- Select with the **↑** or **↓** softkey (F1 or F2) the label **-20 dBc** in the lower row (sound carrier level of channel 2).
- Press the **edit** softkey (F3) and select **Off** in the popup menu.
- Press the **enter** softkey (F5) to confirm your setting.

Test Result Requirement:

The digital NICAM sound is not available (sound carrier level CH 2 off).

The TV does not show a NICAM sound indication.

The TV reproduces a conventional sound with 0.5 kHz modulation in both channels.

Teletext, VPS, PDC, and WSS (Digital Services)

Teletext and Program Delivery Data (PDC)

Procedure:

- Load the default settings of the generator with **RECALL 0**.
- Press the **enter** softkey (F5) to return to the **main** menu.
- Select the **digital** submenu.
- Press the **edit** softkey (F3) and select **Teletext B TOP 1** in the popup menu.
- Press the **enter** softkey (F5) and select 8 lines in the popup menu.

The display shows:

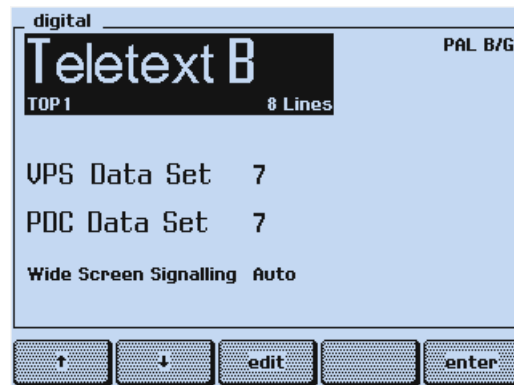

Figure 8-8. Teletext Settings

- Set your TV to the Teletext function.

Test Result Requirement:

The TV shows the Index Page (Teletext Page 100):

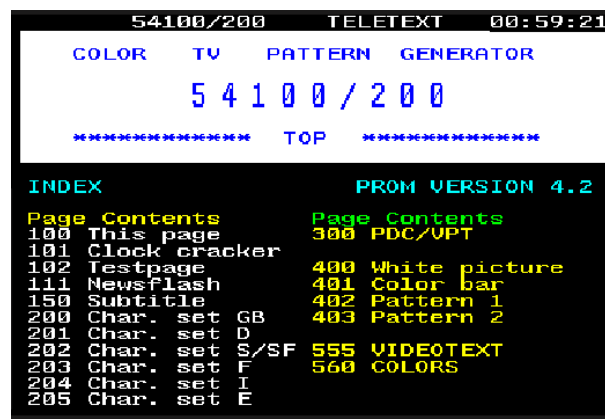

Figure 8-9. Teletext Page 100

- Check if the clock in the upper right corner is running and shows the same time as the clock of the generator (shown in the upper right corner in the **support** menu).

Depending on your TV additional symbols for page selecting are shown in the lower row of the screen.

The PDC data, Packet 8/30 Format 2, are included in the Teletext data; they are not visible on the screen.

Video Programming System (VPS)

Procedure:

- Same settings as above
- Connect the scope to the **VIDEO OUT** of the generator. Use a 75 Ω feedthrough termination.
- Set the scope to PAL (625 line system) and select TV line 16.
- Select an appropriate time base and amplitude scale.

Test Result Requirement:

The scope shows the following signal:

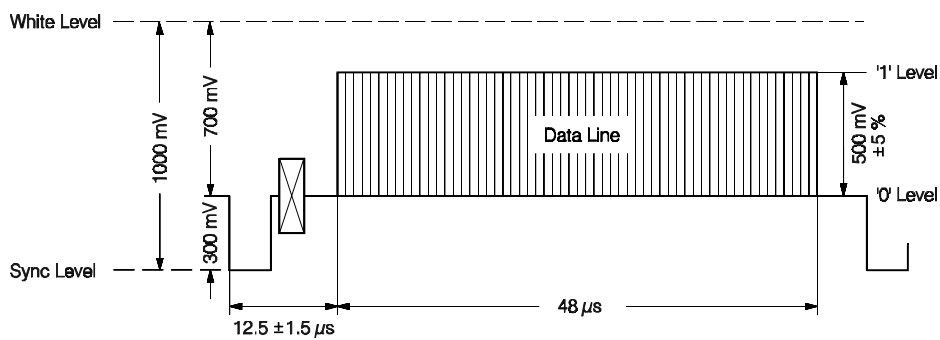

Figure 8-10. VPS Data in Line 16

Wide Screen Signalling Bits (WSS)

Procedure:

- Same connection as above
- Select TV line 23.
- Check in the **digital** submenu if the **Wide Screen Signalling** is set to **Auto**.

Test Result Requirement:

The scope shows the following signal:

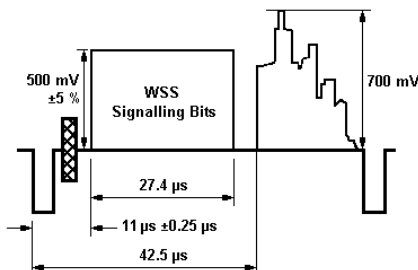

Figure 8-11. Wide Screen Signalling Bits

TV Standard NTSC

Video Part, using RF Connection

Procedure:

- Connect the **RF OUT** of the TV Signal Generator to the antenna input of the TV. Use an appropriate connection cable, for example, the attached cable BNC to TV and the F adapter.
- Load the default settings of the generator with **RECALL 0**.
- Press the **standard** softkey (F1) in the **main** menu.
- Press the **edit** softkey (F3) and select country **USA** in the popup menu with the Pre-defined Country List to set the instrument to **NTSC M**.
(Instruments without PAL are automatically set to **NTSC M** after **RECALL 0**).
- Press the **enter** softkey (F5) to return to the **main** screen.

The display of the generator shows:

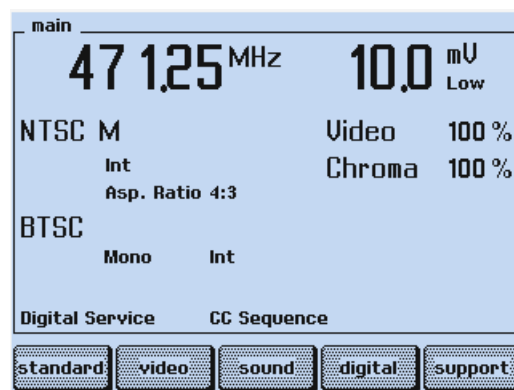

Figure 8-12. Generator Settings, NTSC Standard

- Set the TV to a vision carrier frequency of 471.25 MHz. If your TV does not support this frequency, set the generator to an appropriate frequency.
- Press the **COLOR BAR** key longer than one second.
- Select with the **↑** or **↓** softkey (F1 or F2) **COL_100_0**.
- Press the **enter** softkey (F5) to confirm the setting.
- Add the test patterns **GREYSCALE**, **MULTIBURST**, **CIRCLE** with the keys in the **PATTERN** field.

Test Result Requirement:

The TV shows the following pattern and reproduces a sound with 1 kHz modulation:

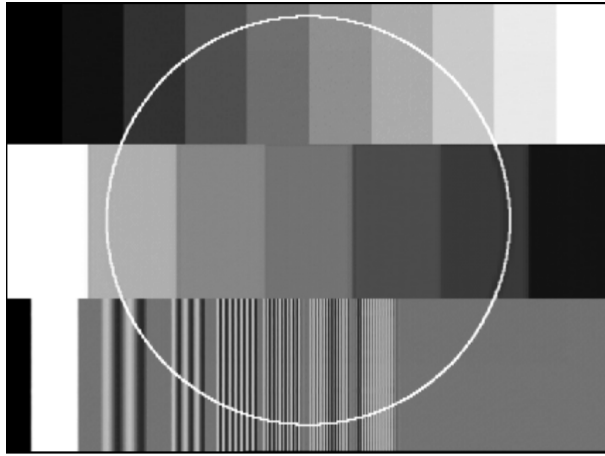

Figure 8-13. Combined Test Pattern NTSC

The complete pattern is only shown by professional TV monitors. Common TV receivers do not show the edges of the pattern.

For details about the test patterns, see Chapter 4, 'Description and Application of Test Patterns.'

- Press the **CHROMA ON/OFF** key.
The TV shows the Color Bar in the middle of the screen in grey.
- Select **Aspect Ratio 16:9** using the **video** submenu.
The TV shows an ellipse instead of the circle and four additional ellipses in the corners of the screen. Select Aspect Ratio 16:9 on your TV. The TV now shows geometrical circles.

- Switch the TV and the generator to Aspect Ratio 4:3.
- Press the **DIGITAL SCAN** key longer than one second.
- Select with the **↑** or **↓** softkey (F1 or F2) **DIGI_SCAN3_M**.
- Press the **enter** softkey (F5) to confirm the setting.
The TV shows the following pattern, moving from left to right. The three left lines flicker.

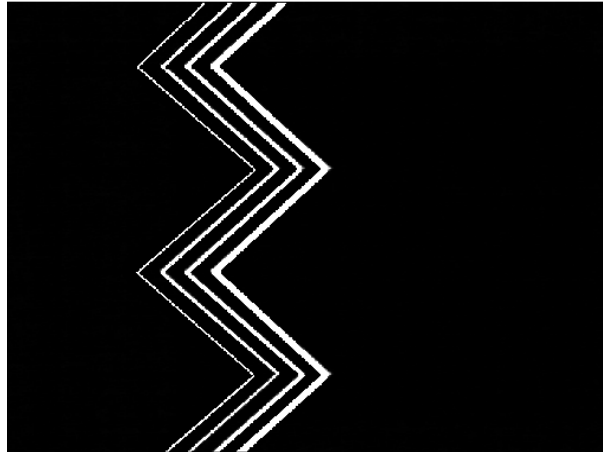

Figure 8-14. Progressive Scan Check 3

- Reduce the vision carrier amplitude to 0.01 mV.
The TV shows noise or a 'No Picture' indication.

Video Part, using Y/C Connection (S-VHS, Hi-8)

Procedure:

- Set the generator with **RECALL 0** to its default settings.
- Press the **enter** softkey (F5) to return to the **main** menu.
- Press the **standard** softkey (F1).
- Press the **edit** softkey (F3) and select country **USA** in the popup menu with the Pre-defined Country List to set the instrument to **NTSC M**.
(Instruments without PAL are automatically set to **NTSC M** after **RECALL 0**).
- Press the **enter** softkey (F5) to return to the **main** screen.
- Remove the connection cable from the **RF OUT** of the generator and the antenna input of the TV.
- Connect the generator using **Y/C OUT** on the rear panel to the Y/C input of the TV.
Use the attached Y/C cable.
- Set the TV to Y/C (S-VHS, Hi-8) input.
- Select the combined test pattern as described Page 8-15.

Test Result Requirement:

The TV reproduces the test pattern shown in Figure 8-13, without sound.

Sound Part

BTSC Mono

Procedure:

- Remove the Y/C cable.
- Connect the **RF OUT** of the TV Signal Generator to the antenna input of the TV.
- Set the TV to antenna input.
- Load the default settings of the generator with **RECALL 0**.
- Press the **standard** softkey (F1) in the **main** menu.
- Press the **edit** softkey (F3) and select country **USA** in the popup menu with the Pre-defined Country List to set the instrument to **NTSC M**.
(Instruments without PAL are automatically set to **NTSC M** after **RECALL 0**).
- Press the **enter** softkey (F5) to return to the **main** screen.
- Select the **sound** submenu with the **sound** softkey (F3).

The display shows:

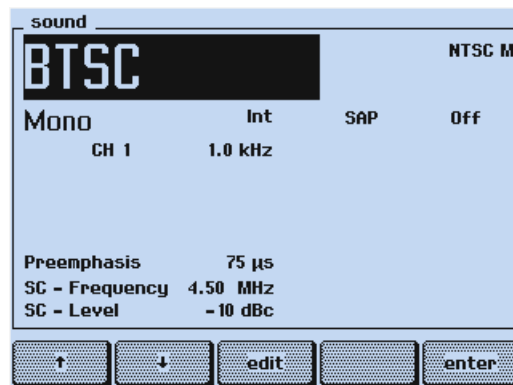

Figure 8-15. BTSC Sound Settings

Test Result Requirement:

The TV reproduces a sound with 1 kHz modulation in both channels.

- Press the **CH1** key longer than one second and select **3.0 kHz** in the popup menu.
- Press the **enter** softkey (F5) key to confirm the setting.
The TV reproduces a sound with 3 kHz modulation in both channels.

BTSC Stereo

Procedure:

- Same settings as above.
- Press the **STEREO** key.

The display shows:

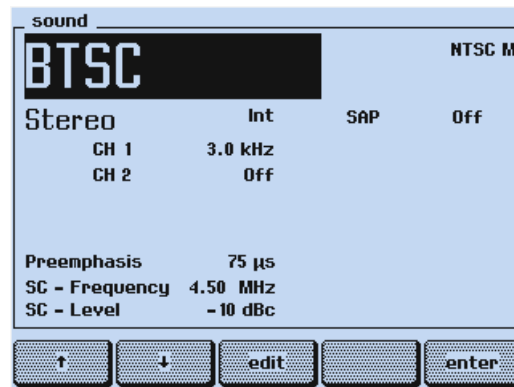

Figure 8-16. BTSC Stereo Sound Settings

Test Result Requirement:

The TV shows a 'Stereo' indication (depends on used TV) and reproduces a sound with 3 kHz modulation in the left channel (**CH 1**). The right channel (**CH 2**) reproduces no sound.

- Press the **CH2** key longer than one second and select **1.0 kHz** in the popup menu.
- Press the **enter** softkey (F5) to confirm the setting.
The TV reproduces a sound with 3 kHz modulation in the left channel and a sound with 1 kHz modulation in the right channel.

Analog Sound, FM Korea

Mono Sound, FM Korea

- Load the default settings of the generator with **RECALL 0**.
- Press the **enter** softkey (F5) to return to the **main** menu.
- Press the **standard** softkey (F1).
- Press the **edit** softkey (F3) and select country **Korea** in the popup menu with the Pre-defined Country List to set the instrument to **NTSC M** and **FM Korea**.
- Press the **enter** softkey (F5) to confirm the setting.
- Select the **sound** submenu with the **sound** softkey (F3).

The display shows:

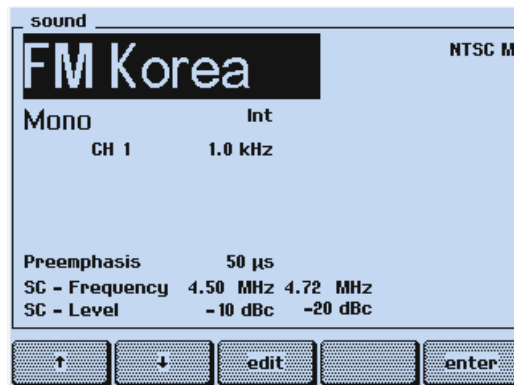

Figure 8-17. Analog Sound Settings, NTSC M

Test Result Requirement:

The TV reproduces a sound with 1 kHz modulation in both channels.

- Press the **CH1** key longer than one second and select **3.0 kHz** in the popup menu.
- Press the **enter** softkey (F5) to confirm the setting.
The TV reproduces a sound with 3 kHz modulation in both channels.

Analog Stereo, FM Korea

Procedure:

- Same settings as above.
- Press the **STEREO** key.

The display shows:

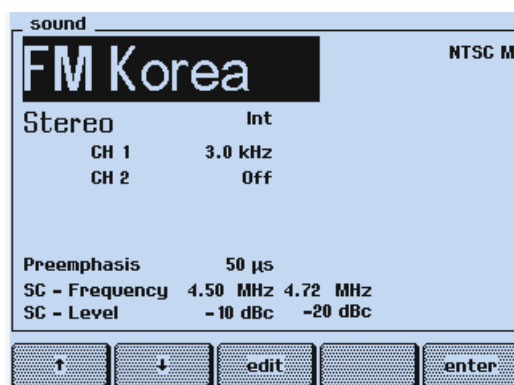

Figure 8-18. Analog Stereo Sound Settings, NTSC M

Test Result Requirement:

The TV shows a 'Stereo' indication (depends on used TV) and reproduces a sound with 3 kHz modulation in the left channel (**CH 1**). The right channel (**CH 2**) reproduces no sound.

- Press the **CH2** key longer than one second and select **1.0 kHz** in the popup menu.
- Press the **enter** softkey (F5) to confirm the setting.
The TV reproduces a sound with 3 kHz modulation in the left channel and a sound with 1 kHz modulation in the right channel.

Dual Sound, FM Korea

Procedure:

- Same settings as above.
- Press the **DUAL/SAP** key.
The display shows the label **Dual** instead of **Stereo**.

Test Result Requirement:

The TV shows a 'Dual Sound' indication (depends on used TV).

- Set the TV to Dual I (**CH 1**).
The TV reproduces a sound with 3 kHz modulation in both channels.
- Set the TV to Dual II (**CH 2**).
The TV reproduces a sound with 1 kHz modulation in both channels.

Closed Caption (Digital Service CC)

Procedure:

- Load the default settings of the generator with **RECALL 0**.
- Press the **enter** softkey (F5) to return to the **main** menu.
- Select the **digital** submenu.
- Press the **edit** softkey (F3) and select country **USA** in the popup menu with the Pre-defined Country List to set the instrument to **NTSC M**.
(Instruments without PAL are automatically set to **NTSC M** after **RECALL 0**).
- Select the **digital** submenu.
- Press the **edit** softkey (F3).
- Press the **enter** softkey (F5).
- Select **CC Number 1** in the popup menu.

The display shows:

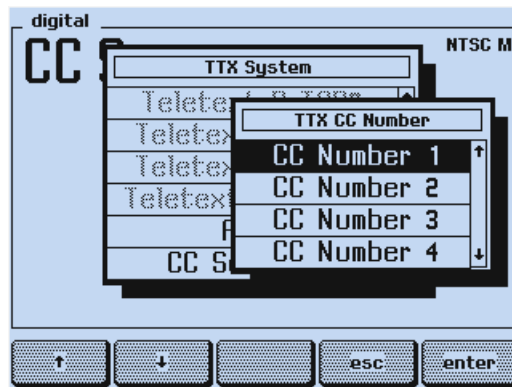

Figure 8-19. Closed Caption Settings

- Press the **enter** softkey (F5) to confirm your setting.
- Set your TV to Closed Caption Number 1.

Test Result Requirement:

The TV shows the standard character set, transmitted in field 1, data channel 1, in a roll-up style.

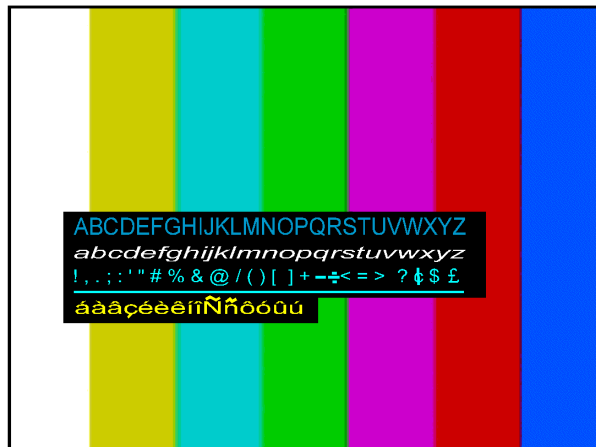

Figure 8-20. Displayed Characters in Closed Caption Mode

The displayed character style and the correct display of the extended characters, for example, Å, É, Û, etc., depends on the decoder of your TV.

TV Standard SECAM

Video Part, using RF Connection

Procedure:

- Connect the **RF OUT** of the TV Signal Generator to the antenna input of the TV. Use an appropriate connection cable, for example, the attached cable BNC to TV.
- Load the default settings of the generator with **RECALL 0**
- Press the **standard** softkey (F1) in the **main** menu.
- Press the **edit** softkey (F3) and select country **France** in the popup menu with the Pre-defined Country List to set the instrument to **SECAM L**.
- Press the **enter** softkey (F5) to confirm the setting.

The display of the generator shows:

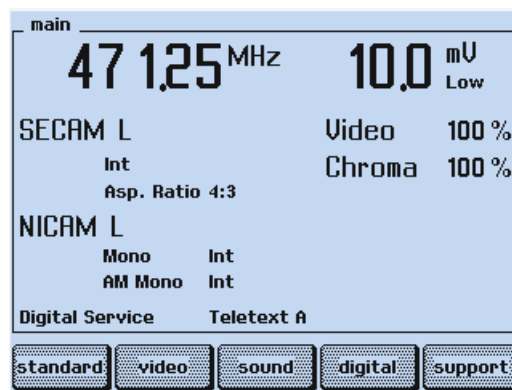

Figure 8-21. Generator Settings, SECAM Standard

- Set the TV to a vision carrier frequency of 471.25 MHz. If your TV does not support this frequency, set the generator to an appropriate frequency. Some older instruments need the Identification Lines for color reproduction. To generate this lines, select **Frame ID On** in the **standard** submenu.
- Press the **enter** softkey (F5) to return to the **main** menu.
- Press the **COLOR BAR** key longer than one second.
- Select with the **↑** or **↓** softkey (F1 or F2) **COL_100_0**.
- Press the **enter** softkey (F5) to confirm the setting.
- Add the test patterns **GREYSCALE**, **MULTIBURST**, **CIRCLE** with the keys in the **PATTERN** field.

Test Result Requirement:

The TV shows the following pattern and reproduces a sound with 1 kHz modulation:

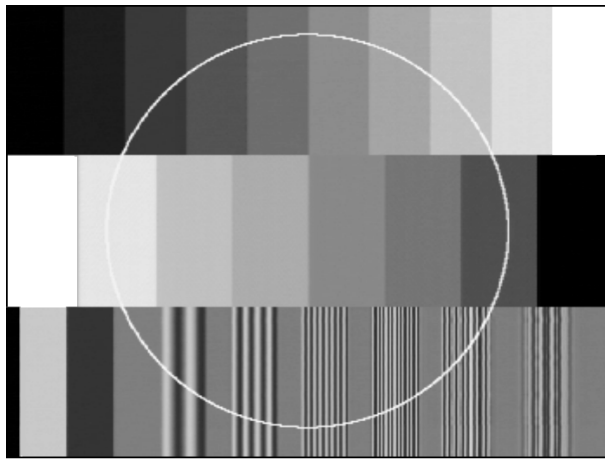

Figure 8-22. Combined Test Pattern, SECAM Standard

The complete pattern is only shown by professional TV monitors. Common TV receivers do not show the edges of the pattern.

For details about the test patterns, see Chapter 4, 'Description and Application of Test Patterns.'

- Press the **CHROMA ON/OFF** key.
The TV shows the Color Bar in the middle of the screen in grey.
- Select **Aspect Ratio 16:9** using the **video** submenu.
The TV shows an ellipse instead of the circle and four additional ellipses in the corners of the screen. Select Aspect Ratio 16:9 on your TV. Some modern TVs automatically change the Aspect Ratio controlled by the WSS bits. The TV now shows geometrical circles.

- Switch the TV and the generator to Aspect Ratio 4:3.
- Press the **DIGITAL SCAN** key longer than one second.
- Select with the **↑** or **↓** softkey (F1 or F2) **DIGI_SCAN3_M**.
- Press the **enter** softkey (F5) to confirm the setting.
The TV shows the following pattern, moving from left to right. If you do not use a 100 Hz TV receiver, the three left lines flicker.

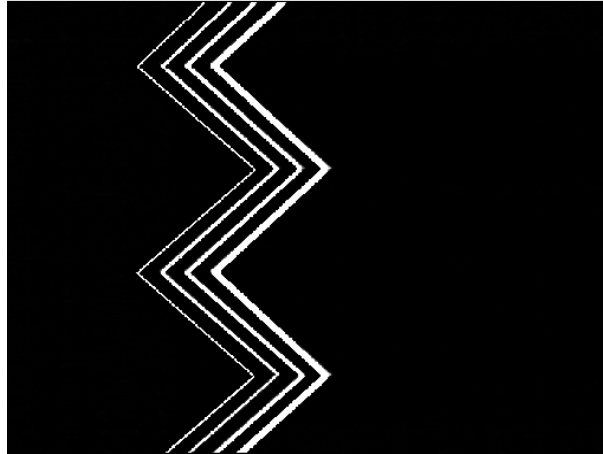

Figure 8-23. Progressive Scan Check 3

- Reduce the vision carrier amplitude to 0.01 mV.
The TV shows noise or a 'No Picture' indication.

Video Part, using Y/C Connection (S-VHS, Hi-8)

Procedure:

- Set the generator with **RECALL 0** to its default settings.
- Press the **standard** softkey (F1) in the **main** menu.
- Press the **edit** softkey (F3) and select country **France** in the popup menu with the Pre-defined Country List to set the instrument to **SECAM L**.
- Press the **enter** softkey (F5) to return to the **main** menu.
- Remove the connection cable from the **RF OUT** of the generator and the antenna input of the TV.
- Connect the generator using **Y/C OUT** on the rear panel to the Y/C input of the TV. Use the attached Y/C cable.
- Set the TV to Y/C (S-VHS, Hi-8) input.
- Select the combined test pattern as described Page 8-23.

Test Result Requirement:

The TV reproduces the test pattern shown in Figure 8-22, without sound.

Sound Part

NICAM L Mono

Procedure:

- Remove the Y/C cable.
- Connect the RF OUT of the TV Signal Generator to the antenna input of the TV.
- Set the TV to antenna input.
- Load the default settings of the generator with **RECALL 0**.
- Press the **standard** softkey (F1) in the **main** menu.
- Press the **edit** softkey (F3) and select country **France** in the popup menu with the Pre-defined Country List to set the instrument to **SECAM L**.
- Press the **enter** softkey (F5) to confirm the setting and to return to the **main** menu.
- Select the **sound** submenu with the **sound** softkey (F3).

The display shows:

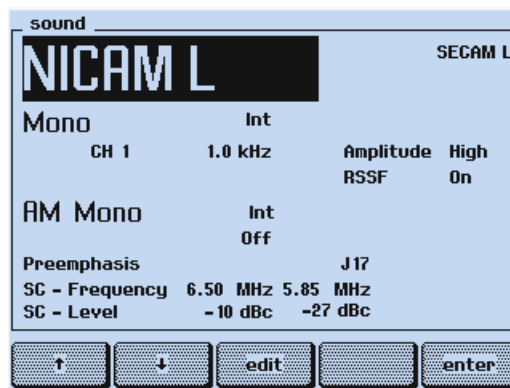

Figure 8-24. Sound Settings, NICAM L

Test Result Requirement:

The TV reproduces a sound with 1 kHz modulation in both channels.

- Press the **CH1** key longer than one second and select **3.0 kHz** in the popup menu.
- Press the **enter** softkey (F5) to confirm the setting.
The TV reproduces a sound with 3 kHz modulation in both channels.

NICAM L Stereo

Procedure:

- Same settings as above.
- Press the **STEREO** key.

The display shows:

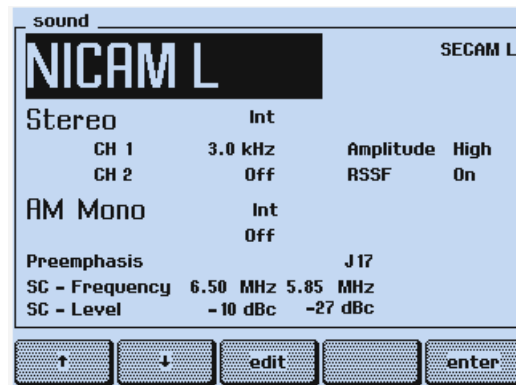

Figure 8-25. Stereo Sound Settings, NICAM L

Test Result Requirement:

The TV shows a 'Stereo' indication (depends on used TV) and reproduces a sound with 3 kHz modulation in the left channel (**CH 1**). The right channel (**CH 2**) reproduces no sound.

- Press the **CH2** key longer than one second and select **1.0 kHz** in the popup menu.
- Press the **enter** softkey (F5) to confirm the setting.
The TV reproduces a sound with 3 kHz modulation in the left channel and a sound with 1 kHz modulation in the right channel.

NICAM L, Conventional Analog AM Sound

Procedure:

- Same settings as above.
- Select with the **↑** or **↓** softkey (F1 or F2) the label **Off** below **AM Mono Int.**
- Press the **edit** softkey (F3) and select **0.5 kHz** in the popup menu.
- Press the **enter** softkey (F5) to confirm the setting.

The display shows:

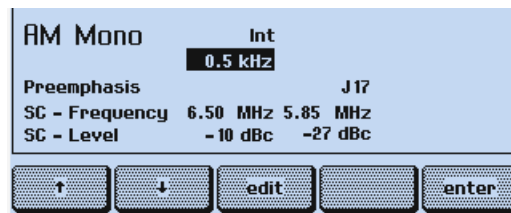

Figure 8-26. Analog AM Sound, NICAM L

- Select with the **↑** or **↓** softkey (F1 or F2) the label **-27 dBc** in the lower row (sound carrier level of channel 2).
- Press the **edit** softkey (F3) and select **Off** in the popup menu.
- Press the **enter** softkey (F5) to confirm your setting.

Test Result Requirement:

The digital NICAM L sound is not available (sound carrier level CH 2 off).

The TV does not show a NICAM sound indication.

The TV reproduces a conventional sound with 0.5 kHz modulation in both channels.

Analog AM Sound (AM L)

Procedure:

- Load the default settings of the generator with **RECALL 0**.
- Press the **standard** softkey (F1) in the **main** menu.
- Press the **edit** softkey (F3) and select country **France** in the popup menu with the Pre-defined Country List to set the instrument to **SECAM L**.
- Select with the **↑** or **↓** softkey (F1 or F2) **NICAM L**.
- Press the **edit** softkey (F3) and select **AM L** in the popup menu.
- Press the **enter** softkey (F5) to confirm your setting and to return the **main** menu.
- Select the **sound** submenu with the **sound** softkey (F3).

The display shows:

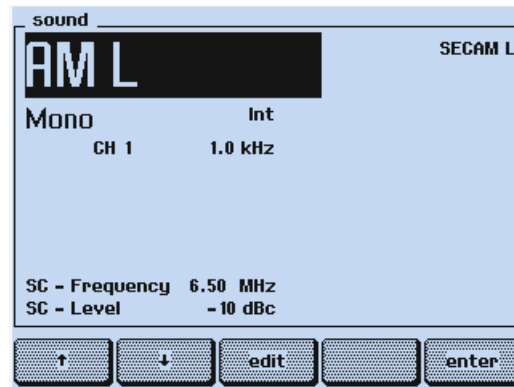

Figure 8-27. Analog AM Sound Settings

Test Result Requirement:

The TV reproduces a sound with 1 kHz modulation in both channels.

- Press the **CH1** key longer than one second and select **3.0 kHz** in the popup menu.
- Press the **enter** softkey (F5) to confirm the setting.
The TV reproduces a sound with 3 kHz modulation in both channels.

Teletext, VPS, PDC, and WSS (Digital Services)

If you already have checked the Teletext function in the TV Standard PAL B/G, skip the following steps.

Teletext and Programme Delivery Data (PDC)

Procedure:

- Load the default settings of the generator with **RECALL 0**.
- Press the **standard** softkey (F1) in the **main** menu.
- Press the **edit** softkey (F3) and select country **France** in the popup menu with the Pre-defined Country List to set the instrument to **SECAM L**.
- Press the **enter** softkey (F5) to confirm the setting and to return to the **main** menu.
- Select the **digital** submenu.
- Press the **edit** softkey (F3) and select **Teletext B TOP 1** in the popup menu.
- Press the **enter** softkey (F5) and select **4** lines in the popup menu.
- Press the **enter** softkey (F5) to return to the **digital** submenu.
- Select with the **↑** or **↓** softkey (F1 or F2) **VPS Data Set Off**.
- Press the **edit** softkey (F3) and select Data Set **7**.
- Press the **enter** softkey (F5) to confirm the setting.
- Select with the **↑** or **↓** softkey (F1 or F2) **PDC Data Set Off**.
- Press the **edit** softkey (F3) and select Data Set **7**.
- Press the **enter** softkey (F5) to confirm the setting.

The display shows:

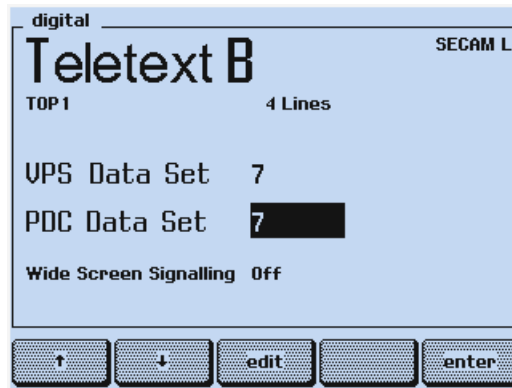

Figure 8-28. Teletext Settings

Set your TV to the Teletext function.

Test Result Requirement:

The TV shows the Index Page (Teletext Page 100):



Figure 8-29. Teletext Page 100

- Check if the clock in the upper right corner is running and shows the same time as the clock of the generator (shown in the upper right corner in the **support** submenu).

Depending on your TV, additional symbols for page selecting are shown in the lower row of the screen.

The PDC data, Packet 8/30 Format 2, are included in the Teletext data; they are not visible on the screen.

Video Programming System (VPS)

Procedure:

- Same settings as above.
- Connect the scope to the **VIDEO OUT** of the generator. Use a $75\ \Omega$ feedthrough termination.
- Set the scope to PAL (625 line system) and select TV line 16.
- Select an appropriate time base and amplitude scale.

Test Result Requirement:

The scope shows the following signal:

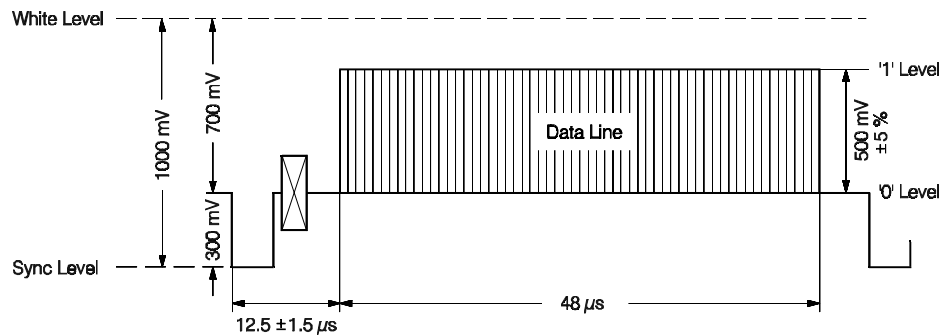

Figure 8-30. VPS Data in Line 16

Wide Screen Signalling Bits (WSS)

Procedure:

- Same connection as above.
- Select TV line 23.
- Select the **digital** submenu and set the **Wide Screen Signalling** to **Auto**.

Test Result Requirement:

The scope shows the following signal:

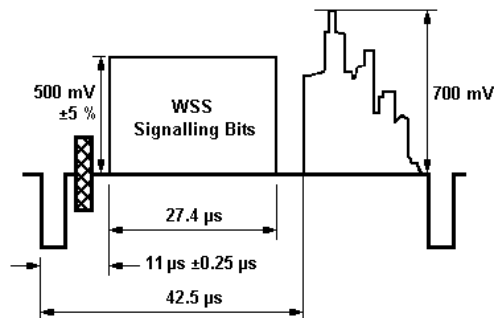

Figure 8-31. Wide Screen Signalling Bits

- Set the generator with **RECALL 0** to its default settings.

Appendices

Appendix	Title	Page
A	TV Systems Used in Various Countries	A-1
B	VHF/UHF-Channel Frequencies for Different TV Systems.....	B-1
C	Default Settings for Countries.....	C-1
D	Spectras of TV Audio Systems	D-1
E	Nomenclature of Color Bar Signals	E-1
F	Menu Trees	F-1
G	Pattern Popup Menus.....	G-1

Appendix A
TV Systems Used in Various Countries

COUNTRY	COLOR	TV VHF	TV UHF	TELETEXT	PDC	SUBTITLING	STEREO
Abu Dhabi	PAL	B	G	-	-	-	-
Afghanistan	PAL / SECAM	B	D	-	-	-	-
Albania	PAL	B	G	-	-	-	-
Algeria	PAL	B	-	-	-	-	-
Andorra	PAL	B	G	-	-	-	-
Angola	PAL	I	I	-	-	-	-
Antigua and Barbuda	NTSC	M	-	-	-	-	-
Antiles	NTSC	M	-	-	-	-	-
Argentina	PAL	N	N	-	-	-	BTSC
Armenia	SECAM	D	K	-	-	-	-
Aryenua	PAL	N	N	-	-	-	-
Australia	PAL	B	H	-	-	-	FM BG
Austria	PAL	B	G	B TOP	VPS	TELETEXT★	FM BG
Azerbaijan	SECAM	D	K	-	-	-	-
Azores	PAL	B	-	-	-	-	-
Azores (US Forces)	NTSC	M	-	-	-	-	-
Bahamas	NTSC	M	-	-	-	-	-
Bahrain	PAL	B	G	-	-	-	-
Bangladesh	PAL	B	-	-	-	-	-
Barbados	NTSC	M	-	-	-	-	-
Belarus	SECAM	D	K	B		TELETEXT★	
Belgium	PAL	B	GH	B	PDC	TELETEXT★	NICAM BG
Belize	NTSC	M	M	-	-	-	-
Benin	SECAM	K1	K1	-	-	-	-
Bermuda	NTSC	M	M	-	-	-	-
Bhutan	PAL	B	-	-	-	-	-
Bolivia	NTSC	M	M	-	-	-	-
Bosnia Herzegovina	PAL	B	G	-	-	-	-
Botswana	PAL	I	I	-	-	-	-
Brazil	PAL	M	M	-	-	CC	MTS USA
Brunei	PAL	B	-	-	-	-	-
Bulgaria	SECAM	D	K	B	-	TELETEXT★	-
Burkina Faso	SECAM	K1	-	-	-	-	-

Lines indicated in bold are directly selectable via the country popup menu of the instrument.

* 54200 Subtitling in Teletext B page 150

COUNTRY	COLOR	TV VHF	TV UHF	TELETEXT	PDC	SUBTITLING	STEREO
Burma	NTSC	M	M	-	-	-	-
Burundi	SECAM	K1	K1	-	-	-	-
Cambodia	NTSC	M	-	-	-	-	-
Cameroon	PAL	B	G	-	-	-	-
Canada	NTSC	M	M	C	-	-	MTS USA
Canary Islands	PAL	B	-	-	-	-	NICAM BG
Central African Rep.	SECAM	K1	K1	-	-	-	-
Chad	SECAM	K1	K1	-	-	-	-
Chile	NTSC	M	M	-	-	-	-
China P.R.	PAL	D	D	B	-	TELETEXT★	NICAM DK
Colombia	NTSC	M	M	A	-	-	-
Congo	SECAM	K1(D)	K1(D)	-	-	-	-
Costa Rica	NTSC	M	M	-	-	-	-
Côte d'Ivoire	SECAM	K1	K1	-	-	-	-
Croatia	PAL	B	G	B	-	TELETEXT★	-
Cuba	NTSC	M	M	-	-	-	-
Curacao	NTSC	M	M	-	-	-	-
Cyprus	PAL / SECAM	B	G	-	-	-	-
Czech Republic	SECAM / PAL	D	K	B	-	TELETEXT★	FM DK
Dahomey	SECAM	K1	K1	-	-	-	-
Denmark	PAL	B	G	B	PDC	TELETEXT★	NICAM BG
Diego Garcia	NTSC	M	M	-	-	-	-
Djibuti	SECAM	K1	K1	-	-	-	-
Dominica	NTSC	M	M	-	-	-	-
Dominican Republic	NTSC	M	M	-	-	-	-
Dubai	PAL	B	G	-	-	-	-
Ecuador	NTSC	M	M	-	-	-	-
Egypt	SECAM	B	G	B	-	TELETEXT★	-
El Salvador	NTSC	M	M	-	-	-	-
Equatorial Guinea	PAL	B	-	-	-	-	-
Estonia	SECAM	D	K	B	-	TELETEXT★	-
Ethiopia	PAL	B	G	-	-	-	-

Lines indicated in bold are directly selectable via the country popup menu of the instrument.
* 54200 Subtitling in Teletext B page 150

COUNTRY	COLOR	TV VHF	TV UHF	TELETEXT	PDC	SUBTITLING	STEREO
Falkland Islands	PAL	I	I	-	-	-	-
Faroe Islands	PAL	B	G	-	-	-	-
Fernando Po	PAL	B	-	-	-	-	-
Fiji	PAL	B	-	-	-	-	-
Finland	PAL	B	G	B	PDC	TELETEXT★	NICAM BG
France	SECAM	L1	L	A(B)	-	TELETEXT★	NICAM L
French Polynesia	SECAM	K1	K1	-	-	-	-
Gabon	SECAM	K1	K1	-	-	-	-
Gambia	PAL	I	I	-	-	-	-
Georgia	SECAM	D	K	-	-	-	-
Germany	PAL	B	G	B TOP	VPS	TELETEXT★	FM BG
Ghana	PAL	B	G	-	-	-	-
Gibraltar	PAL	B	H	-	-	-	-
Greece	SECAM / PAL	B	G	-	-	-	-
Greenland	PAL / NTSC	B	M	-	-	-	-
Guadeloupe	SECAM	K1	K1	-	-	-	-
Guam	NTSC	M	M	-	-	-	-
Guatemala	NTSC	M	M	-	-	-	-
Guinea	SECAM	K1	K1	-	-	-	-
Guinea Bissau	PAL	I	I	-	-	-	-
Guyana (French)	SECAM	K1	-	-	-	-	-
Guyana (Rep.)	SECAM	B	G	-	-	-	-
Haiti	NTSC	M	-	-	-	-	-
Hawaii	NTSC	M	-	-	-	-	MTS USA
Honduras	NTSC	M	-	-	-	-	-
Hong Kong	PAL	I	I	-	-	-	NICAM I
Hungary	SECAM	D	K	B	-	TELETEXT★	NICAM DK
Iceland	PAL	B	G	B	-	TELETEXT★	NICAM BG
India	PAL	B	G	A	-	-	-
Indonesia	PAL	B	-	-	-	-	-
Iran	SECAM	B	G	-	-	-	-
Iraq	SECAM	B	G	-	-	-	-

Lines indicated in bold are directly selectable via the country popup menu of the instrument.

* 54200 Subtitling in Teletext B page 150

COUNTRY	COLOR	TV VHF	TV UHF	TELETEXT	PDC	SUBTITLING	STEREO
Ireland	PAL	I	I	B	-	TELETEXT★	NICAM I
Israel	PAL	B	G	B	-	TELETEXT★	
Italy	PAL	B	G	B	-	TELETEXT★	FM BG
Ivory Coast	SECAM	K1	K1	-	-	-	-
Jamaica	NTSC	M	-	-	-	-	-
Japan	NTSC	M	M	D	-	TELETEXT★	MTS Japan
Jordan	PAL	B	G	B	-	TELETEXT★	-
Kampuchea	NTSC	M	-	-	-	-	-
Kazakhstan	SECAM	D	K	-	-	-	-
Kenya	PAL	B	G	-	-	-	-
Kirgizstan	SECAM	D	K	-	-	-	-
Korea North	SECAM	D	K	-	-	-	-
Korea South	NTSC	M	M	-	-	-	FM Mk
Kuwait	PAL	B	G	-	-	-	-
Kyrgystan	SECAM	D	K	-	-	-	-
Latvia	SECAM	D	K	-	-	-	-
Lebanon	SECAM	B	G	-	-	-	-
Leeward Islands	NTSC	M	-	-	-	-	-
Lesotho	PAL	I	-	-	-	-	-
Liberia	PAL	B	H	-	-	-	-
Libya	SECAM	B	G	-	-	-	-
Liechtenstein	PAL	B	G	-	-	-	-
Lithuania	SECAM	D	K	-	-	-	-
Luxembourg	PAL / SECAM	B	GL	B	-	-	FM BG
Macao	PAL	I	I	-	-	-	-
Macedonia	PAL	B	G	-	-	-	-
Madagascar	SECAM	K1	-	-	-	-	-
Madeira	PAL	B	-	-	-	-	-
Malagasy	SECAM	K1	K1	-	-	-	-
Malawi	PAL	B	G	-	-	-	-
Malaysia	PAL	B	G	B	-	-	FM BG
Maldives	PAL	B	-	-	-	-	-
Mali	SECAM	K1	-	-	-	-	-

Lines indicated in bold are directly selectable via the country popup menu of the instrument.

* 54200 Subtitling in Teletext B page 150

COUNTRY	COLOR	TV VHF	TV UHF	TELETEXT	PDC	SUBTITLING	STEREO
Malta	PAL	B	G	-	-	-	-
Martinique	SECAM	K1	-	-	-	-	-
Mauritania	SECAM	K1 (B)	K1 (B)	-	-	-	-
Mauritius	SECAM	B	-	-	-	-	-
Mexico	NTSC	M	M	-	-	-	MTS USA
Micronesia	NTSC	M	M	-	-	-	-
Midway Islands	NTSC	M	M	-	-	-	-
Moldova	SECAM	D	K	-	-	-	-
Monaco	PAL / SECAM	L1	GL	-	-	-	-
Mongolia	SECAM	D	K	-	-	-	-
Montenegro	PAL	B	G	-	-	-	-
Montserrat	NTSC	M	M	-	-	-	-
Morocco	SECAM	B	H	-	-	-	-
Mozambique	PAL	B	G	-	-	-	-
Myanmar (Birma)	NTSC	M	-	-	-	-	-
Namibia	PAL	I	I	-	-	-	-
Nepal	PAL	B	-	-	-	-	-
Netherlands	PAL	B	G	B	PDC	TELETEXT★	FM BG
New Caledonia	SECAM	K1	K1	-	-	-	-
New Zealand	PAL	B	G	B	-	-	NICAM BG
Nicaragua	NTSC	M	M	-	-	-	-
Niger	SECAM	K1	K1	-	-	-	-
Nigeria	PAL	B	-	-	-	-	-
Norway	PAL	B	G	B	PDC	TELETEXT★	NICAM BG
Okinawa	NTSC	M	M	-	-	-	MTS Japan
Oman	PAL	B	G	-	-	-	-
Pakistan	PAL	B	G	-	-	-	-
Panama	NTSC	M	M	-	-	-	-
Papua New Guinea	PAL	B	G	-	-	-	-
Paraguay	PAL	N	N	-	-	-	-
Peru	NTSC	M	M	-	-	-	-
Philippines	NTSC	M	M	-	-	-	-
Poland	PAL / SECAM	DD	KK	B		TELETEXT★	

Lines indicated in bold are directly selectable via the country popup menu of the instrument.

* 54200 Subtitling in Teletext B page 150

COUNTRY	COLOR	TV VHF	TV UHF	TELETEXT	PDC	SUBTITLING	STEREO
Portugal	PAL	B	G	-	-	-	-
Puerto Rico	NTSC	M	M	-	-	-	-
Qatar	PAL	B	G	-	-	-	-
Reunion	SECAM	K1	K1	-	-	-	-
Romania	PAL	D	(G)K	B	-	TELETEXT★	-
Russian Fed.	SECAM	D	K	-	-	-	-
Rwanda	SECAM	K1	K1	-	-	-	-
Saba and Sarawak	PAL	B	G	-	-	-	FM BG
Samoa	NTSC	M	-	-	-	-	-
San Marino	PAL	B	G	-	-	-	FM BG
Saudi Arabia	PAL / SECAM	B	G	-	-	-	-
Senegal	SECAM	K1	K1	-	-	-	-
Serbia	PAL	B	G	-	-	-	-
Seychelles	PAL	B	-	-	-	-	-
Sierra Leone	PAL	B	G	-	-	-	-
Singapore	PAL	B	G	B	-	-	NICAM BG
Slovakia	PAL / SECAM	BK	GK	B	-	TELETEXT★	FM BG / FM K
Slovenia	PAL	B	G	-	-	-	FM BG
Society Islands	SECAM	K1	-	-	-	-	-
Somalia	PAL	B	G	-	-	-	-
South Africa	PAL	I	I	B	-	-	-
Spain	PAL	B	G	B FLOF	-	TELETEXT★	NICAM BG
Sri Lanka	PAL	B	G	-	-	-	-
St. Kitts & Nevis	NTSC	M	-	-	-	-	-
Sudan	PAL	B	-	-	-	-	-
Surinam	NTSC	M	-	-	-	-	-
Swaziland	PAL	B	G	-	-	-	-
Sweden	PAL	B	G	B	PDC	TELETEXT★	NICAM BG
Switzerland	PAL	B	G	B TOP	VPS	TELETEXT★	FM BG
Syria	SECAM	B	H	-	-	-	-
Tahiti	SECAM	K1	-	-	-	-	-
Taiwan	NTSC	M	M	-	-	CC	MTS USA

Lines indicated in bold are directly selectable via the country popup menu of the instrument.
* 54200 Subtitling in Teletext B page 150

COUNTRY	COLOR	TV VHF	TV UHF	TELETEXT	PDC	SUBTITLING	STEREO
Tajikistan	SECAM	D	K	-	-	-	-
Tanzania	PAL	B	-	-	-	-	-
Thailand	PAL	B	G	-	-	-	-
Tibet	PAL	D	-	-	-	-	-
Togo	SECAM	K1	K1	-	-	-	-
Trinidad & Tobago	NTSC	M	M	-	-	-	-
Tunisia	PAL / SECAM	B	GG	-	-	-	-
Turkey	PAL	B	G	B	-	TELETEXT★	-
Turkmenistan	SECAM	D	K	-	-	-	-
Uganda	PAL	B	G	-	-	-	-
Ukraine	SECAM	D	K	-	-	-	-
United Arab Emirates	PAL	B	G	-	-	-	-
United Kingdom	PAL		I	B FLOF	PDC	TELETEXT★	NICAM I
Upper Volta	SECAM	K1	K1	-	-	-	-
Uruguay	PAL	N	-	-	-	-	-
USA	NTSC	M	M	-	EDS	CC	MTS USA
Uzbekistan	SECAM	D	K	-	-	-	-
Vatican City	PAL	B	G	-	-	-	FM BG
Venezuela	NTSC	M	-	-	-	-	-
Vietnam	PAL	B	G	-	-	-	-
Virgin Islands	NTSC	M	M	-	-	-	-
Yemen	PAL	B	-	-	-	-	-
Yugoslavia	PAL	B	G	-	-	-	-
Zaire	SECAM	K1	K1	-	-	-	-
Zambia	PAL	B	G	-	-	-	-
Zanzibar	PAL	I	I	-	-	-	-
Zimbabwe	PAL	B	G	-	-	-	-

Lines indicated in bold are directly selectable via the country popup menu of the instrument.

* 54200 Subtitling in Teletext B page 150

Appendix B
***VHF/UHF-Channel Frequencies for
Different TV Systems***

VHF Channel Specifications - Broadcast

Europe

CCIR VHF SYSTEM B,C (7 MHz)			
CH	Vision	Sound	Range
1			
2	48.25	53.75	47-54
3	55.25	60.75	54-61
4	62.25	67.75	61-68
5	175.25	180.75	174-181
6	182.25	187.75	181-188
7	189.25	194.75	188-195
8	196.25	201.75	195-202
9	203.25	208.75	202-209
10	210.25	215.75	209-216
11	217.25	222.75	216-223
12	224.25	229.75	223-230

Europe

FRANCE VHF SYSTEM L (8 MHz)			
CH	Vision	Sound	Range
A 1	47.75	41.25	41-49
B 2	55.75	49.25	49-57
C 3	63.75	57.25	57-65
C1 4	60.50	54.00	53.75- 61.75
1 5	176.00	182.50	174.75-182.75
2 6	184.00	190.50	182.75-190.75
3 7	192.00	198.50	190.75-198.75
4 8	200.00	206.50	198.75-206.75
5 9	208.00	214.50	206.75-214.75
6 10	216.00	222.50	214.75-222.75

Africa

AFRICA VHF SYSTEM I (8 MHz)			
CH	Vision	Sound	Range
4	175.25	181.25	174-182
5	183.25	189.25	182-190
6	191.25	197.25	190-198
7	199.25	205.25	198-206
8	207.25	213.25	206-214
9	215.25	221.25	214-222
10	223.25	229.25	222-230
11	231.25	237.25	230-238
12	239.25	245.25	238-246
13	247.43	253.43	246-254

ITALY VHF SYSTEM B (7 MHz)			
CH	Vision	Sound	Range
A	53.75	59.25	52.5-59.5
B	62.25	67.75	61-68
C	82.25	87.75	81-88
D	175.25	180.75	174-181
E	183.75	189.25	182.5-189
F	192.25	197.75	191-198
G	201.25	206.75	200-207
H	210.25	215.75	209-216
H-1	217.25	222.75	216-223
H-2	224.25	229.75	223-230

VHF SYSTEM K1 (8 MHz)			
CH	Vision	Sound	Range
4	175.25	181.75	174-182
5	183.25	189.75	182-190
6	191.25	197.75	190-198
7	199.25	205.75	198-20
8	207.75	213.75	206-214
9	215.25	221.75	214-222

MOROCCO VHF SYSTEM B (7 MHz)			
CH	Vision	Sound	Range
M-4	163.25	168.75	162-169
M-5	171.25	176.75	170-177
M-6	179.25	184.75	178-185
M-7	187.25	192.75	186-193
M-8	195.25	200.75	194-201
M-9	203.25	208.75	202-209
M-10	211.25	216.75	210-217

IRELAND VHF SYSTEM I (8 MHz)			
CH	Vision	Sound	Range
IA	45.75	51.75	44.5-52.5
IB	53.75	59.75	52.5-60.5
IC	61.75	67.75	60.5-68.5
ID	175.25	181.25	174-182
IE	183.25	189.25	182-190
IF	191.25	197.25	190-198
IG	199.25	205.25	198-206
IH	207.25	213.25	206-214
IJ	215.25	221.25	214-222

OIRT VHF SYSTEM D (8 MHz)			
CH	Vision	Sound	Range
R-I	49.75	56.25	48.5-56.5
R-II	59.25	65.75	58-66
R-III	77.25	83.75	76-84
R-IV	85.25	91.75	84-92
R-V	93.25	99.75	92-100
R-VI	175.25	181.75	174-182
R-VII	183.25	189.75	182-190
R-VIII	191.25	197.75	190-198
R-IX	199.25	205.75	198-206
R-X	207.25	213.75	206-214
R-XI	215.25	221.75	214-222
R-XII	223.25	229.75	222-230

VHF Channel Specifications - Broadcast (cont)

Far East

AUSTRALIA VHF SYSTEM B (7 MHz)			
CH	Vision	Sound	Range
0	46.25	51.75	45-52
1	57.25	62.75	56-63
2	64.25	69.75	63-70
3	86.25	91.75	85-92
4	95.25	100.75	94-101
5	102.25	107.75	101-108
5 A	138.25	143.75	137-144
6	175.25	180.75	174-181
7	182.25	187.75	181-188
8	189.25	194.75	188-195
9	196.25	201.75	195-202
10	209.25	214.75	208-215
11	216.25	221.75	215-222

Far East

JAPAN VHF SYSTEM M (6 MHz)			
CH	Vision	Sound	Range
J 1	91.25	95.75	90-96
J 2	97.25	101.75	96-102
J 3	103.25	107.75	102-108
J 4	171.25	175.75	170-176
J 5	177.25	181.75	176-182
J 6	183.25	187.75	182-188
J 7	189.25	193.75	188-194
J 8	193.25	197.75	192-198
J 9	199.25	203.75	198-204
J 10	205.25	209.75	204-210
J 11	211.25	215.75	210-216
J 12	217.25	221.75	216-222

America

NORTH/SOUTH AMERICA VHF SYSTEM M,N (6 MHz)			
CH	Vision	Sound	Range
A 02	55.25	59.75	54-60
A 03	61.25	65.75	60-66
A 04	67.25	71.75	66-72
A05	77.25	81.75	76-82
A 06	83.25	87.75	82-88
A 07	175.25	179.75	174-180
A08	181.25	185.75	180-186
A 09	187.25	191.75	186-192
AIO	193.25	197.75	192-198
A I 1	199.25	203.75	198-204
A 12	205.25	209.75	204-210
A 13	211.25	215.75	210-216

CHINA VHF SYSTEM D (8 MHz)			
CH	Vision	Sound	Range
1	49.75	56.25	48.5-56.5
2	57.75	64.25	56.5-64.5
3	65.75	72.25	64.5-72.5
4	77.25	83.75	76.0-84.0
5	85.25	91.75	84.0-92.0
6	168.25	174.75	167-175
7	176.25	182.75	175-183
8	184.25	190.75	183-191
9	192.25	198.75	191-199
10	200.25	206.75	199-207
11	208.25	214.75	207-215
12	216.25	222.75	215-223

NEW ZEALAND VHF SYSTEM B (7 MHz)			
CH	Vision	Sound	Range
1	45.25	50.75	44-51
2	55.25	60.75	51-61
3	62.25	67.75	61-68
4	175.25	180.75	174-181
5	182.25	187.75	181-188
6	189.25	194.75	188-195
7	196.25	201.75	195-202
8	203.25	208.75	202-209
9	210.25	215.75	209-216
10	217.25	222.75	216-223

UHF Channel Specifications - Broadcast

Europe

CCIR UHF SYSTEM G,H,I,K,L (8 MHz)					
CH	Vision	Sound	Sound	Sound	Range
		G,H	I	K,L	
21	471.25	476.75	477.25	477.75	470-478
22	479.25	484.75	485.25	485.75	478-486
23	487.25	492.75	493.25	493.75	486-494
24	495.25	500.75	501.25	501.75	494-502
25	503.25	508.75	509.25	509.75	502-510
26	511.25	516.75	517.25	517.75	510-518
27	519.25	524.75	525.25	525.75	518-526
28	527.25	532.75	533.25	533.75	526-534
29	535.25	540.75	541.25	541.75	534-542
30	543.25	548.75	549.25	549.75	542-550
31	551.25	556.75	557.25	557.75	550-558
32	559.25	564.75	565.25	565.75	558-566
33	567.25	572.75	573.25	573.75	566-574
34	575.25	580.75	581.25	581.75	574-582
35	583.25	588.75	589.25	589.75	582-590
36	591.25	596.75	597.25	597.75	590-598
37	599.25	604.75	605.25	605.75	598-606
38	607.25	612.75	613.25	613.75	606-614
39	615.25	620.75	621.25	621.75	614-622
40	623.25	628.75	629.25	629.75	622-630
41	631.25	636.75	637.25	637.75	630-638
42	639.25	644.75	645.25	645.75	638-646
43	647.25	652.75	653.25	653.75	646-654
44	655.25	660.75	661.25	661.75	654-662
45	663.25	668.75	669.25	669.75	662-670

Europe

CCIR UHF SYSTEM G,H,I,K,L (8 MHz)					
CH	Vision	Sound	Sound	Sound	Range
		G,H	I	K,L	
46	671.25	676.75	677.25	677.75	670-678
47	679.25	684.75	685.25	685.75	678-686
48	687.25	692.75	693.25	693.75	686-694
49	695.25	700.75	701.25	701.75	694-702
50	703.25	708.75	709.25	709.75	702-710
51	711.25	716.75	717.25	717.75	710-718
52	719.25	724.75	725.25	725.75	718-726
53	727.25	732.75	733.25	733.75	726-734
54	735.25	740.75	741.25	741.75	734-742
55	743.25	748.75	749.25	749.75	742-750
56	751.25	756.75	757.25	757.75	750-758
57	759.25	764.75	765.25	765.75	758-766
58	767.25	772.75	773.25	773.75	766-774
59	775.25	780.75	781.25	781.75	774-782
60	783.25	788.75	789.25	789.75	782-790
61	791.25	796.75	797.25	797.75	790-798
62	799.25	804.75	805.25	805.75	798-806
63	807.25	812.75	813.25	813.75	806-814
64	815.25	820.75	821.25	821.75	814-822
65	823.25	828.75	829.25	829.75	822-830
66	831.25	836.75	837.25	837.75	830-838
67	839.25	844.75	845.25	845.75	838-846
68	847.25	852.75	853.25	853.75	846-854
69	855.25	860.75	861.25	861.75	854-862

UHF Channel Specifications - Broadcast (cont)

Far East

JAPAN UHF SYSTEM M (6 MHz)			
CH	Vision	Sound	Range
45	663.25	667.75	662-668
46	669.25	673.75	668-674
47	675.25	679.75	674-680
48	681.25	685.75	680-686
49	687.25	691.75	686-692
50	693.25	697.75	692-698
51	699.25	703.75	698-704
52	705.25	709.75	704-710
53	711.25	715.75	710-716
54	717.25	721.75	716-722
55	723.25	727.75	722-728
56	729.25	733.75	728-734
57	735.25	739.75	734-740
58	741.25	745.75	740-746
59	747.25	751.75	746-752
60	753.25	757.75	752-758
61	759.25	673.75	758-764
62	765.25	769.75	764-770

Far East

CHINA UHF SYSTEM K (8 MHz)			
CH	Vision	Sound	Range
13	471.25	477.75	470-478
14	479.25	485.75	478-486
15	487.25	493.75	486-494
16	495.25	501.75	494-502
17	503.25	509.75	502-510
18	511.25	517.75	510-518
19	519.25	525.75	518-526
20	527.25	533.75	526-534
21	535.25	541.75	534-542
22	543.25	549.75	542-550
23	551.25	557.75	550-558
24	559.25	565.75	558-566
25	607.25	613.75	606-614
26	615.25	621.75	614-622
27	623.25	629.75	622-630
28	631.25	637.75	630-638
29	639.25	645.75	638-646
30	647.25	653.75	646-654
31	655.25	661.75	654-662
32	663.25	669.75	662-670
33	671.25	677.75	670-678
34	679.25	685.75	678-686
35	687.25	693.75	686-694
36	695.25	701.75	694-702
37	703.25	709.75	702-710
38	711.25	717.75	710-718
39	719.25	725.75	718-726
40	727.25	733.75	726-734

Far East

CHINA UHF SYSTEM K (8 MHz)			
CH	Vision	Sound	Range
41	735.25	741.75	734-742
42	743.25	749.75	742-750
43	751.25	757.75	750-758
44	759.25	765.75	758-766
45	767.25	773.75	766-774
46	775.25	781.75	774-782
47	783.25	789.75	782-790
48	791.25	797.75	790-798
49	799.25	805.75	798-806
50	807.25	813.75	806-814
51	815.25	821.75	814-822
52	823.25	829.75	822-830
53	831.25	837.75	830-838
54	839.25	845.75	838-846
55	847.25	853.75	846-854
56	855.25	861.75	854-862
57	863.25	869.75	862-870
58	871.25	877.75	870-878
59	879.25	885.75	878-886
60	887.25	893.75	886-894
61	895.25	901.75	894-902
62	903.25	909.75	902-910
63	911.25	917.75	910-918
64	919.25	925.75	918-926
65	927.25	933.75	926-934
66	935.25	941.75	934-942
67	943.25	949.75	942-950
68	951.25	957.75	950-958

UHF Channel Specifications - Broadcast (cont)

America

NORTH/SOUTH AMERICA UHF SYSTEM M (6 MHz)				NORTH/SOUTH AMERICA UHF SYSTEM M (6 MHz)				NORTH/SOUTH AMERICA UHF SYSTEM M (6 MHz)			
CH	Vision	Sound	Range	CH	Vision	Sound	Range	CH	Vision	Sound	Range
14	471.25	475.75	470-476	38	615.25	619.75	614-620	62	759.25	763.75	758-764
15	477.25	481.75	476-482	39	621.25	625.75	620-626	63	765.25	769.75	764-770
16	483.25	487.75	482-488	40	627.25	631.75	626-632	64	771.25	775.75	770-776
17	489.25	493.75	488-494	41	633.25	637.75	632-638	65	777.25	781.75	776-782
18	495.25	499.75	494-500	42	639.25	743.75	638-644	66	783.25	787.75	782-788
19	501.25	505.75	500-506	43	645.25	749.75	644-650	67	789.25	793.75	788-794
20	507.25	511.75	506-512	44	651.25	755.75	650-656	68	795.25	799.75	794-800
21	513.25	517.75	512-518	45	657.25	661.75	656-662	69	801.25	805.75	800-806
22	519.25	523.75	518-524	46	663.25	667.75	662-668	70	807.25	811.75	806-812
23	525.25	529.75	524-530	47	669.25	673.75	668-674	71	813.25	817.75	812-818
24	531.25	535.75	530-536	48	675.25	679.75	674-680	72	819.25	823.75	818-824
25	537.25	541.75	536-542	49	681.25	685.75	680-686	73	825.25	829.75	824-830
26	543.25	547.75	542-548	50	687.25	691.75	686-692	74	831.25	835.75	830-836
27	549.25	553.75	548-554	51	693.25	697.75	692-698	75	837.25	841.75	836-842
28	555.25	559.75	554-560	52	699.25	703.75	698-704	76	843.25	847.75	842-848
29	561.25	565.75	560-566	53	705.25	709.75	704-710	77	849.25	853.75	848-854
30	567.25	571.75	566-572	54	711.25	715.75	710-716	78	855.25	859.75	854-860
31	573.25	577.75	572-578	55	717.25	721.75	716-722	79	861.25	865.75	860-866
32	579.25	583.75	578-584	56	723.25	727.75	722-728	80	867.25	871.75	866-872
33	585.25	589.75	584-590	57	729.25	733.75	728-734	81	873.25	877.75	872-878
34	591.25	595.75	590-596	58	735.25	739.75	734-740	82	879.25	883.75	878-884
35	597.25	601.75	596-602	59	741.25	745.75	740-746	83	885.25	889.75	884-890
36	603.25	607.75	602-608	60	747.25	751.75	746-752				
37	609.25	613.75	608-614	61	753.25	757.75	752-758				

UHF Channel Specifications - Broadcast (cont)

America

NORTH/SOUTH AMERICA UHF SYSTEM M (8 MHz)				NORTH/SOUTH AMERICA UHF SYSTEM M (8 MHz)			
CH	Vision	Sound	Range	CH	Vision	Sound	Range
65	469.25	473.75	468-474	96	not used		
66	475.25	479.75	474-480	97	not used		
67	481.25	485.75	480-486	98	see A-2		
68	487.25	491.75	486-492	99	see A-1		
69	493.25	497.75	492-498	100	649.25	653.75	648-654
70	499.25	503.75	498-504	101	655.25	659.75	654-660
71	505.25	509.75	504-510	102	661.25	666.75	660-666
72	511.25	515.75	510-516	103	667.25	671.75	666-672
73	517.25	521.75	516-522	104	673.25	677.75	672-678
74	523.25	527.75	522-528	105	679.25	683.75	678-684
75	529.25	533.75	528-534	106	683.25	689.75	684-690
76	535.25	539.75	534-540	107	691.25	695.75	690-696
77	541.25	545.75	540-546	108	697.25	701.75	696-702
78	547.25	551.75	546-552	109	703.25	707.75	702-708
79	553.25	557.75	552-558	110	709.25	713.75	708-714
80	559.25	563.75	558-564	111	715.25	719.75	714-720
81	565.25	569.75	564-570	112	721.25	725.75	720-726
82	571.25	575.75	570-576	113	727.25	731.75	726-732
83	577.25	581.75	576-582	114	733.25	737.75	732-738
84	583.25	587.75	582-588	115	739.25	743.75	738-744
85	589.25	593.75	588-594	116	745.25	749.75	744-750
86	595.25	599.75	594-600	117	751.25	755.75	750-756
87	601.25	605.75	600-606	118	757.25	761.75	756-762
88	607.25	611.75	606-612	119	763.25	767.75	762-768
89	613.25	617.75	612-618	120	769.25	773.75	768-774
90	619.25	623.75	618-624	121	775.25	779.75	774-780
91	625.25	629.75	624-630	122	781.25	785.75	780-786
92	631.25	635.75	636-642	123	787.25	791.75	786-792
93	637.25	641.75	642-648	124	793.25	797.75	792-798
94	643.25	647.75		125	799.25	803.75	798-804
95	not used						

Special VHF Channels

Europe

CCIR VHF SYSTEM B,G (8 MHz)			
CH	Vision	Sound	Range
E 2	48.25	53.75	47-54
E 3	55.25	60.75	54-61
E 4	62.25	67.75	61-68
S 01	69.25	74.75	68-75
S 02	76.25	81.75	75-82
S 03	83.25	88.75	82-89
S 1	105.25	110.75	104-111
S 2	112.25	117.75	111-118
S 3	119.25	124.75	118-125
S 4	126.25	131.75	125-132
S 5	133.25	138.75	132-139
S 6	140.25	145.75	139-146
S 7	147.25	152.75	146-153
S 8	154.25	159.75	153-160
S 9	161.25	166.75	160-167
S 10	168.25	173.75	167-174
E 5	175.25	180.75	174-181
E 6	182.25	187.75	181-188
E 7	189.25	194.75	188-195

Europe

CCIR VHF SYSTEM B,G (8 MHz)			
CH	Vision	Sound	Range
E 8	196.25	201.75	195-202
E 9	203.25	208.75	202-209
E 10	210.25	215.75	209-216
E 11	217.25	222.75	216-223
E 12	224.25	229.75	223-230
S11	231.25	236.75	230-237
S 12	238.25	243.75	237-244
S 13	245.25	250.75	244-251
S 14	252.25	257.75	251-258
S 15	259.25	264.75	258-265
S 16	266.25	271.75	265-272
S17	273.25	278.75	272-279
S 18	280.25	285.75	279-286
S 19	287.25	292.75	286-293
S 20	294.25	299.75	293-300
S 21	303.25	308.75	302-310
S 22	311.25	316.75	310-318
S 23	319.25	324.75	318-326
S 24	327.25	332.75	326-334

Europe

CCIR VHF SYSTEM B,G (8 MHz)			
CH	Vision	Sound	Range
S 25	335.25	340.75	334-342
S 26	343.25	348.75	342-350
S 27	351.25	356.75	350-358
S 28	359.25	364.75	358-366
S 29	367.25	372.75	366-374
S 30	375.25	380.75	374-382
S 31	383.25	388.75	382-390
S 32	391.25	396.75	390-398
S 33	399.25	404.75	398-406
S 34	407.25	412.75	406-414
S 35	415.25	420.75	414-422
S 36	423.25	428.75	422-430
S 37	431.25	436.75	430-438
S 38	439.25	444.75	438-446
S 39	447.25	452.75	446-454
S 40	455.25	460.75	454-462
S 41	463.25	468.75	462-470
S 40	455.25	460.75	454-462
S 41	463.25	468.75	462-470

Japan

JAPAN VHF SYSTEM M (6 MHz)			
CH	Vision	Sound	Range
C 13	109.25	113.75	
C 14	115.25	119.75	
C 15	121.25	125.75	
C 16	127.25	131.75	
C 17	133.25	137.75	
C 18	139.25	143.75	
C 19	145.25	149.75	
C 20	151.25	155.75	
C 21	157.25	161.75	
C 22	165.25	169.75	
C 23	223.25	227.75	
C 24	231.25	235.75	
C 25	237.25	241.75	
C 26	243.25	247.75	
C 27	249.25	253.75	
C 28	253.25	257.75	
C 29	259.25	263.75	

Japan

JAPAN VHF SYSTEM M (6 MHz)			
CH	Vision	Sound	Range
C 30	265.25	269.75	
C 31	271.25	275.75	
C 32	277.25	281.75	
C 33	283.25	287.75	
C 34	289.25	293.75	
C 35	295.25	299.75	
C 36	301.25	305.75	
C 37	307.25	311.75	
C 38	313.25	317.75	
C 39	319.25	323.75	
C 40	325.25	329.75	
C 41	331.25	335.75	
C 42	337.25	341.75	
C 43	343.25	347.75	
C 44	349.25	353.75	
C 45	355.25	359.75	
C 46	361.25	365.75	

Japan

JAPAN VHF SYSTEM M (6 MHz)			
CH	Vision	Sound	Range
C 47	367.25	371.75	
C 48	373.25	377.75	
C 49	379.25	383.75	
C 50	385.25	389.75	
C 51	391.25	395.75	
C 52	397.25	401.75	
C 53	403.25	407.75	
C 54	409.25	413.75	
C 55	415.25	419.75	
C 56	421.25	425.75	
C 57	427.25	431.75	
C 58	433.25	437.75	
C 59	439.25	443.75	
C 60	445.25	449.75	
C 61	451.25	455.75	
C 62	457.25	461.75	
C 63	463.25	467.75	

Special VHF Channels (cont)

America

USA VHF SYSTEM M (6 MHz)				
CH	Vision	Sound	Range	
2	2	55.25	59.75	54-60
3	3	61.25	65.75	60-66
4	4	67.25	71.75	66-72
5A	1	73.25	77.75	72-78
5	5	77.25	81.75	76-82
6	6	83.25	87.75	82-88
A-5	95	91.25	95.75	90-96
A-4	96	97.25	101.75	96-102
A-3	97	103.25	107.75	102-108
A-2	98	109.25	113.75	108-114
A-1	99	115.25	119.75	114-120
A	14	121.25	125.75	120-126
B	15	127.25	131.75	126-132
c	16	133.25	137.75	132-138
D	17	139.25	143.75	138-144
E	18	145.25	149.75	144-150
F	19	151.25	155.75	150-156
G	20	157.25	161.75	156-162
H	21	163.25	167.75	162-168
I	22	169.25	173.75	168-174
7	7	175.25	179.75	174-180
8	8	181.25	185.75	180-186
9	9	187.25	191.75	186-192
10	10	193.25	197.75	192-198
11	11	199.25	203.75	198-204
12	12	205.25	209.75	204-210
13	13	211.25	215.75	210-216
J	23	217.25	221.75	216-222
K	24	223.25	227.75	222-228
L	25	229.25	233.75	228-234
M	26	235.25	239.75	234-240
N	27	241.25	245.75	240-246
O	28	247.25	251.75	246-252

America

USA VHF SYSTEM M (6 MHz)				
CH	Vision	Sound	Range	
P	29	253.25	257.75	252-258
Q	30	259.25	263.75	258-264
R	31	265.25	269.75	264-270
S	32	271.25	275.75	270-276
T	33	277.25	281.75	276-282
U	34	283.25	287.75	282-288
V	35	289.25	293.75	288-294
W	36	295.25	299.75	294-300
AA	37	301.25	305.75	300-306
BB	38	307.25	311.75	306-312
CC	39	313.25	317.75	312-318
DD	40	319.25	323.75	318-324
EE	41	325.25	329.75	324-330
FF	42	331.25	335.75	330-336
GG	43	337.25	341.75	336-342
HH	44	343.25	347.75	342-348
II	45	349.25	353.75	348-354
JJ	46	355.25	359.75	354-360
KK	47	361.25	365.75	360-366
LL	48	367.25	371.75	366-372
MM	49	373.25	377.75	372-378
NN	50	379.25	383.75	378-384
OO	51	385.25	389.75	384-390
PP	52	391.25	395.75	390-396
QQ	53	397.25	401.75	396-402
RR	54	403.25	407.75	402-408
SS	55	409.25	413.75	408-414
TT	56	415.25	419.75	414-420
UU	57	421.25	425.75	420-426
VV	58	427.25	431.75	426-432
WW	59	433.25	437.75	432-438
AAA	60	439.25	443.75	438-444
BBB	61	445.25	449.75	444-450

America

USA VHF SYSTEM M (6 MHz)				
CH	Vision	Sound	Range	
CCC	62	451.25	455.75	450-456
DDD	63	457.25	461.75	456-462
EEE	64	463.23	467.75	462-468
	65	469.25	473.75	468-474
	66	475.25	479.75	474-480
	67	481.25	485.75	480-486
	68	487.25	491.75	486-492
	69	493.25	497.75	492-498
	70	499.25	503.75	498-504
	71	505.25	509.75	504-510
	72	511.25	515.75	510-516
	73	517.25	521.75	516-522
	74	523.25	527.75	522-528
	75	529.25	533.75	528-534
	76	535.25	539.75	534-540
	77	541.25	545.75	540-546
	78	547.25	551.75	546-552
	79	553.25	557.75	552-558
	80	559.25	563.75	558-564
	81	565.25	569.75	564-570
	82	571.25	575.75	570-576
	83	577.25	581.75	576-582
	84	583.25	587.75	582-588
	85	589.25	593.75	588-594
	86	595.25	599.75	594-600
	87	601.25	605.75	600-606
	88	607.25	611.75	606-612
	89	613.25	617.75	612-618
	90	619.25	623.75	618-624
	91	625.25	629.75	624-630
	92	631.25	635.75	630-636
	93	637.25	641.75	636-642
	94	643.25	647.75	642-648

Appendix C
Default Settings for Countries



Country	Residual Carrier	Video Modul.	Group Delay	Color	Mono Sound		Stereo Sound		1. Sound Carrier		2. Sound Carrier		Digital Services					
					System	Level	System	Level	Freq. MHz	Pre-emph.	Freq. MHz	Pre-emph.	Teletext System	PDC/VPS	CC	WSS		
					Line 23	Line 21	Line 23	Line 21	Line 23	Line 21	Line 23	Line 21	Line 23	Line 21	Line 23	Line 21	Line 23	
Argentina	10%	neg.	M	PAL/N	FM M	-10 dBc	BTSC*	-	4.5	75 µs	-	-	-	-	-	-	-	-
Brazil	10%	neg.	M	PAL/M	FM M	-10 dBc	BTSC *	-10 dBc	4.5	75 µs	-	-	-	-	-	CC	-	-
Centr. African Rep.	10%	neg.	-	SECAM	FM D,K	-10 dBc	-	-	6.5	50 µs	-	-	-	-	-	-	-	-
China P.R.	20%	neg.	-	PAL4.4	FM D,K	-10 dBc	NICAM DK	-20 dBc	6.5	50 µs	5.85	J17	FLOF2	-	-	-	-	-
Czech Republic	10%	neg.	-	PAL4.4	FM D,K	-10 dBc	FM A2	-20 dBc	6.5	50 µs	6.25781	50 µs	FLOF2	-	-	-	-	-
France	20%	pos.	-	SECAM	AM L	-10 dBc	NICAM L	-27 dBc	6.5	-	5.85	J17	Antiope	VPS*	-	-	-	-
Germany	10%	neg.	B/G (A)	PAL4.4	FM B,G	-13 dBc	FM B/G	-20 dBc	5.5	50 µs	5.74219	50 µs	TOP1	VPS	-	-	-	Auto
Greece	10%	neg.	-	SECAM	FM B,G	-13 dBc	-	-	5.5	50 µs	-	-	-	-	-	-	-	-
Hungary	20%	neg.	-	SECAM	FM D,K	-10 dBc	NICAM DK	-20 dBc	6.5	50 µs	5.85	J17	FLOF2	-	-	-	-	-
Japan	10%	neg.	M	NTSC	FM M	-10 dBc	-	-	4.5	75 µs	-	-	-	-	-	-	-	-
Korea	10%	neg.	M	NTSC	FM M	-10 dBc	FM Mk	-20 dBc	4.5	75 µs	4.724	75 µs	-	-	-	-	-	-
Mexico	10%	neg.	M	NTSC	FM M	-10 dBc	BTSC *	-	4.5	75 µs	-	-	-	-	-	CC*	-	-
Poland	10%	neg.	-	SECAM	FM D,K	-10 dBc	-	-	6.5	50 µs	-	-	FLOF2	-	-	-	-	-
Romania	10%	neg.	-	PAL4.4	FM D,K	-10 dBc	-	-	6.5	50 µs	-	-	FLOF2	-	-	-	-	-
Russian Fed. Rep.	10%	neg.	-	SECAM	FM D,K	-10 dBc	-	-	6.5	50 µs	-	-	-	-	-	-	-	-
Slovakia	10%	neg.	B/G (A)	PAL4.4	FM B,G	-13 dBc	FM B/G	-20 dBc	5.5	50 µs	5.74219	50 µs	FLOF2	-	-	-	-	-
Spain	20%	neg.	B/G (A)	PAL4.4	FM B,G	-13 dBc	NICAM B/G	-20 dBc	5.5	50 µs	5.85	J17	FLOF2	-	-	-	-	-
Sweden	20%	neg.	B/G (A)	PAL4.4	FM B,G	-13 dBc	NICAM B/G	-20 dBc	5.5	50 µs	5.85	J17	FLOF2	PDC	-	-	-	-
United Kingdom	20%	neg.	-	PAL4.4	FM I	-10 dBc	NICAM I	-20 dBc	6.0	50 µs	6.552	J17	FLOF2	PDC	-	-	-	Auto
USA	10%	neg.	M	NTSC	FM M	-10 dBc	BTSC	-10 dBc	4.5	75 µs	-	-	-	-	-	CC	-	-

*not default, but may be switched on manually

- = Off

Appendix D
Spectras of TV Audio Systems

Examples

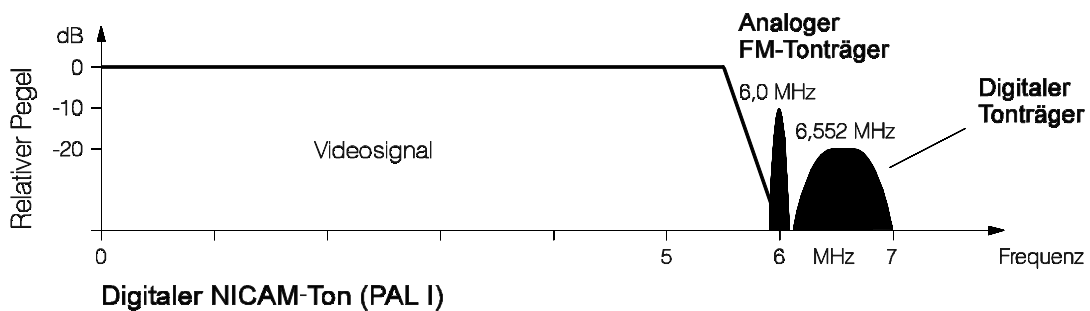
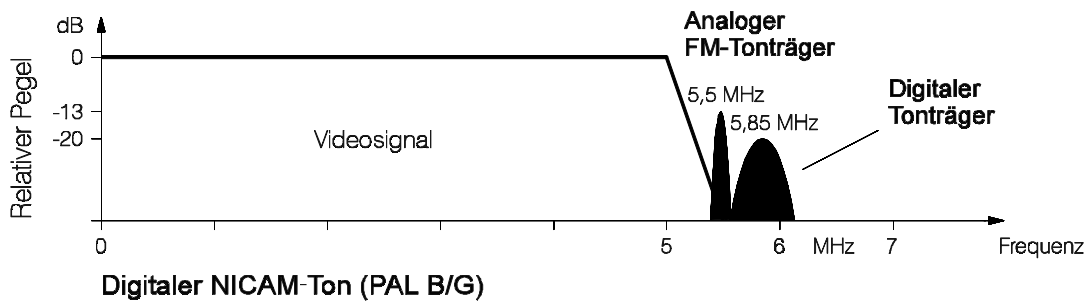
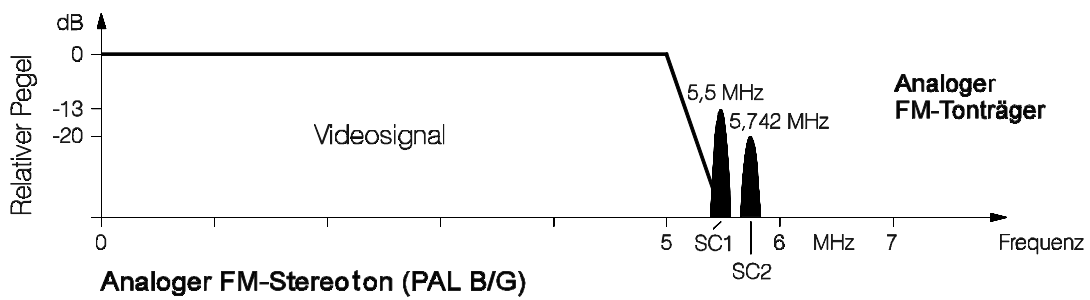
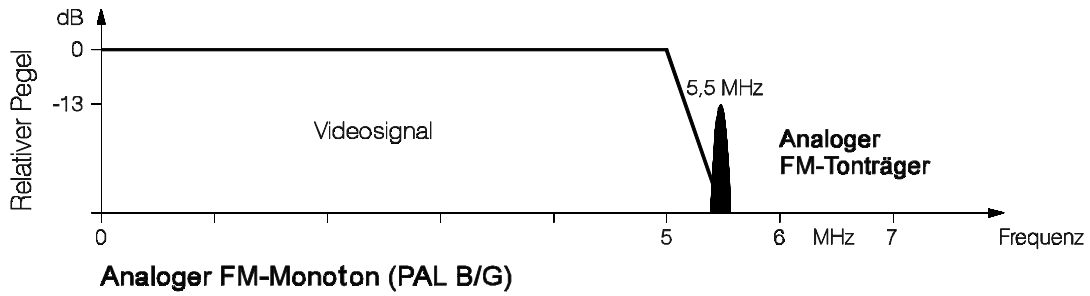

Appendix E
Nomenclature of Color Bar Signals

The following nomenclature is used to identify and distinguish between color signals (according to CCIR Rec. 471).

	Signal Level Relative to Peak White (%)				TV Systems
	A	B	C	D	
Color bars	75	0	75	0	625 line systems
Color bars	100	0	75	0	625 line systems
Color bars	75	0	100	25	625 line systems
Color bars	100	0	100	25	625 line systems
Color bars	75	7.5	75	7.5	525 line systems
Color bars	100	7.5	75	7.5	525 line systems

- A The primary color signal level during transmission of the 'white' color bar, for example maximum value of E'R, E'G, and E'B.
- B The primary color signal level during transmission of the 'black' color bar, for example minimum value of E'R, E'G, and E'B.
- C The maximum level of the primary color signal during transmission of 'colored' color bars, for example maximum value of E'R, E'G, and E'B.
- D The minimum level of the primary color signal during transmission of 'colored' color bars, for example minimum value of E'R, E'G, and E'B.

The color bar is generated by the three primary color signals **Red, Green, and Blue** (E'R, E'G, and E'B). The signal amplitudes shown below, are expressed as a percentage of the white level, whereby peak white corresponds to 100%, and the blanking level to zero.

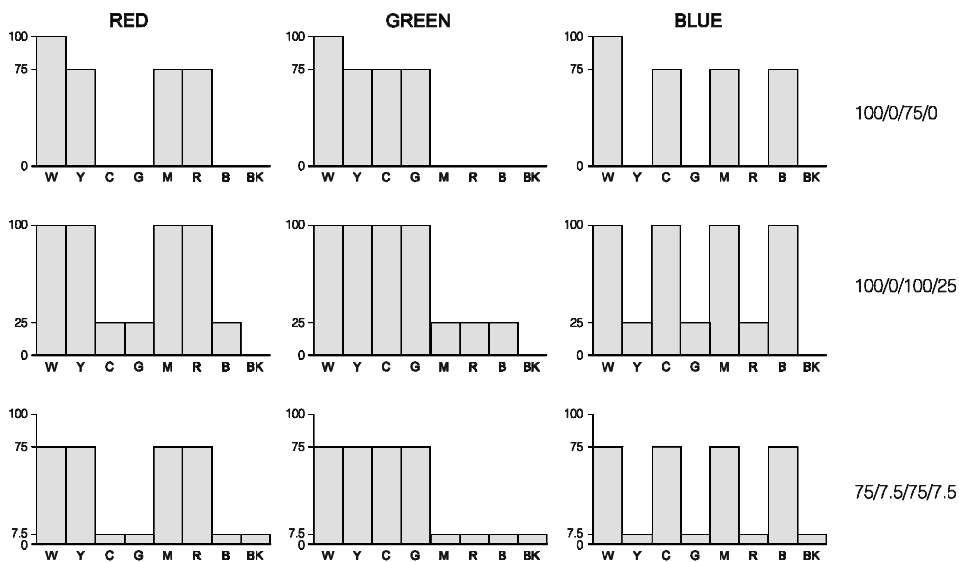

W: white, Y: yellow, C: cyan, G: green, M: magenta, R: red, B: blue, BK: black

Appendix F
Menu Trees

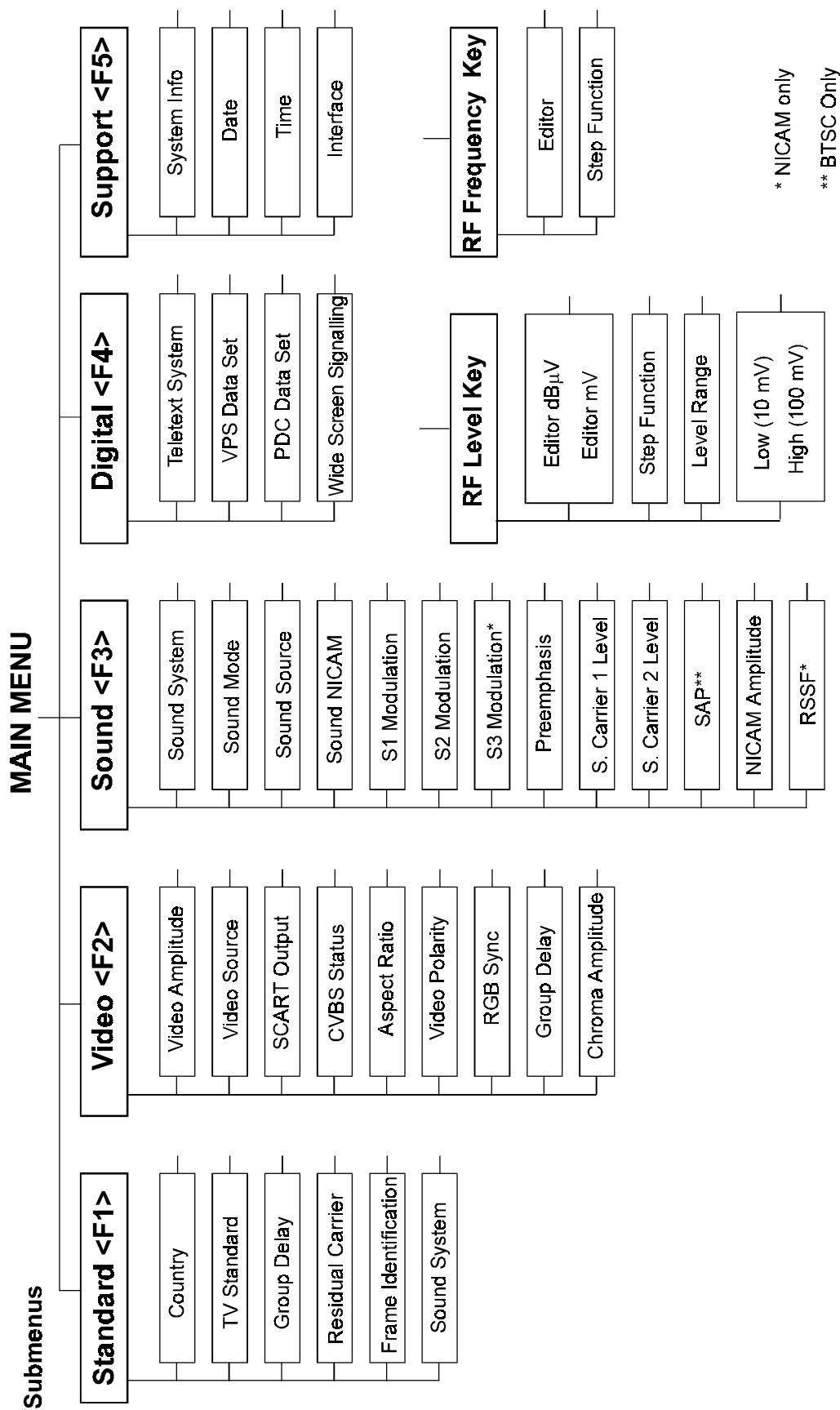

Standard

Country	TV Standard	Group Delay	Residual Carrier	Frame Identification	Sound System
Argentina	PAL B/G	Off	Low	Off	AM L
Brazil	PAL D/K	On	High	On	FM Mono
Central African Rep.	PAL I				FM Germany
China	PAL M				FM Korea
Czech. Rep.	PAL N				FM A2
France	SECAM B/G				NICAM B/G
Germany	SECAM D/K/K1				NICAM D/K
Greece	SECAM L				NICAM DC
Hungary	NTSC M				NICAM I
Japan	NTSC 4 B/G				NICAM L
Korea	NTSC 4 D/K				BTSC
Mexico	NTSC 4 I				
Poland					
Rumania					
Russian Fed. Rep.					
Slovakia					
Spain					
Sweden					
United Kingdom					
U.S.A.					
no Country					

Information
Sound System
Sound Mode
Sound Carrier 1 Freq.
Sound Carrier 2 Freq.
SC1 NICAM*
TV Lines
Vertical Frequency

* NICAM only

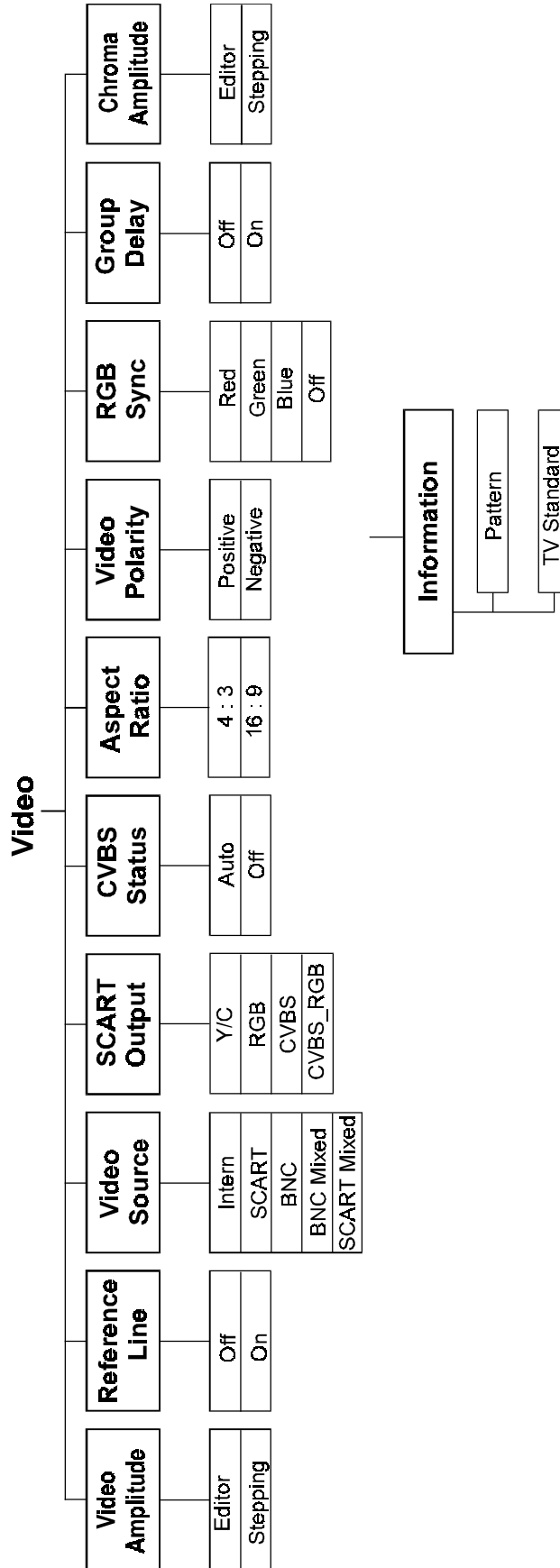

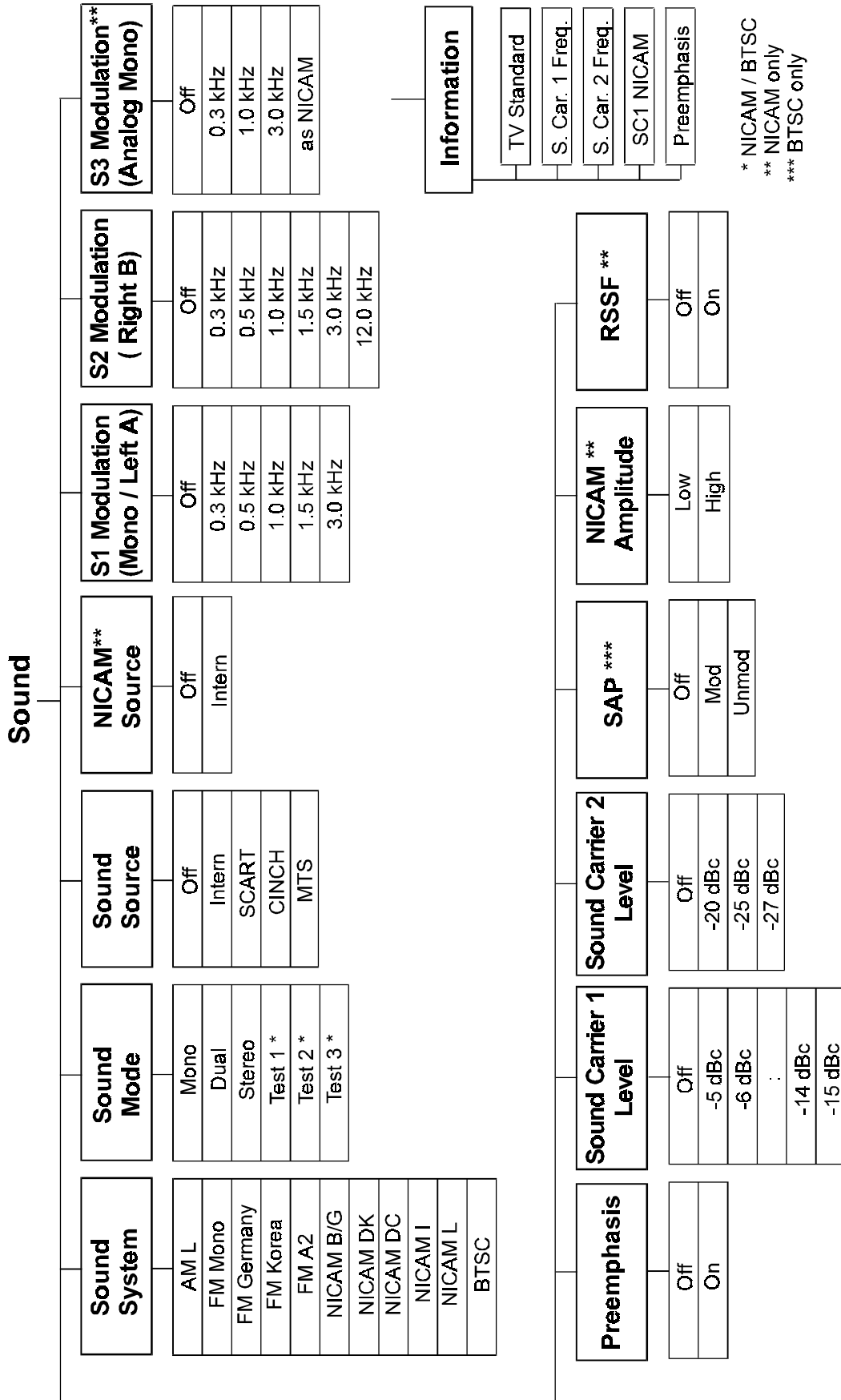

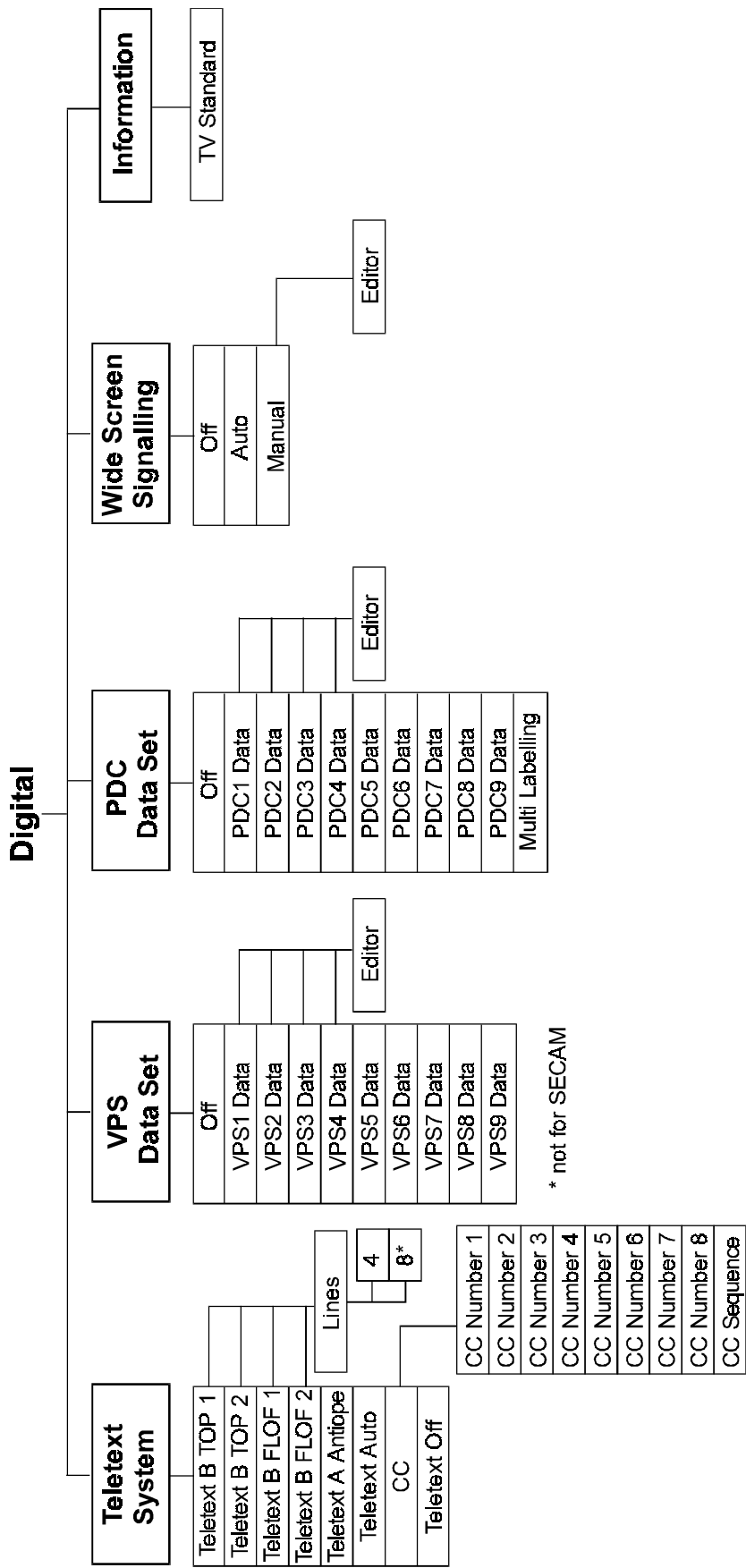

Support

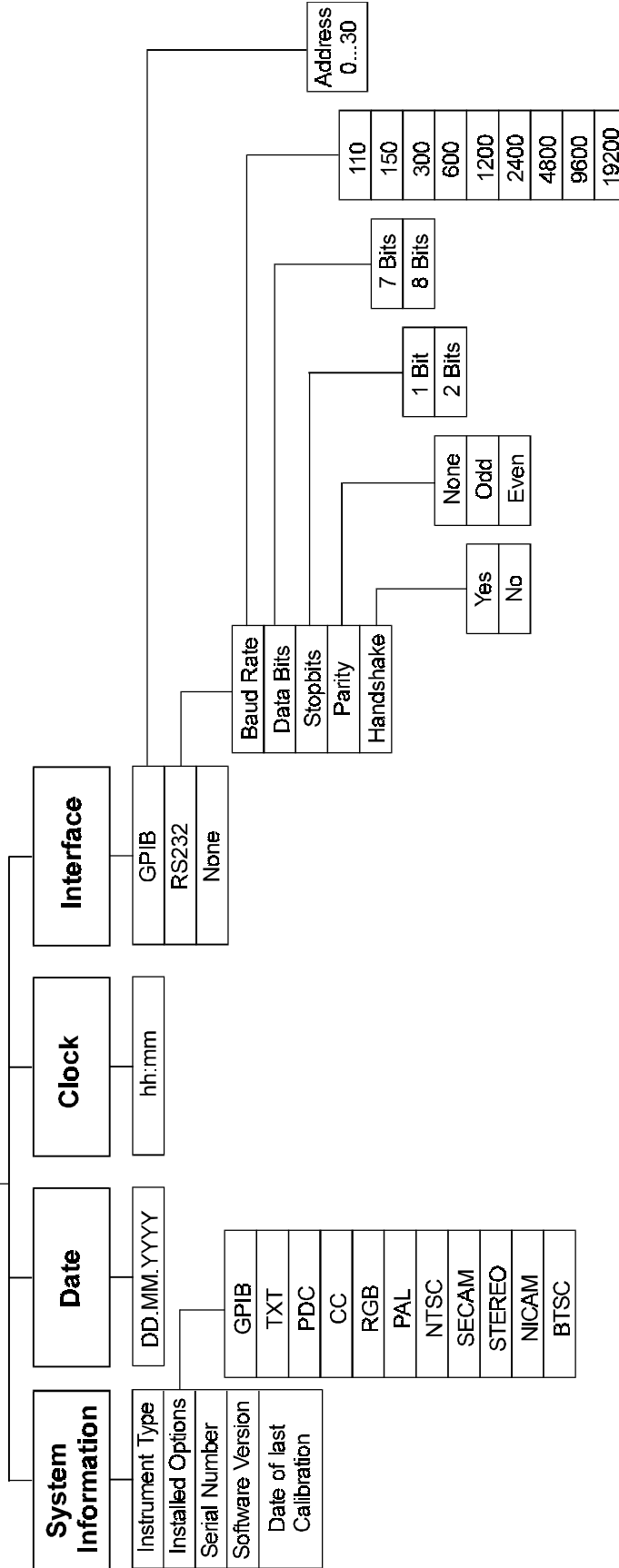

Appendix G
Pattern Popup Menus



Center Cross
Off
Center_2%
Center_3%



Dots
Off
Dots_White
Dots_Black



Crosshatch
Off
CH_White
CH_White_C
CH_White_TL
CH_White_C_TL
CH_Black
CH_Black_C
CH_Black_TL
CH_Black_C_TL



625 Line Systems

White
Off
White_0%
White_5%
White_15%
:
in 5% steps to
:
White_90%
White_95%
White_100%

525 Line Systems

White
Off
White_7.5IRE
White_15IRE
White_20IRE
:
in 5IRE steps to
:
White_90IRE
White_95IRE
White_100IRE



Demodulation Test
Off
DEM_PAT1
DEM_PAT2



Purity
Off
PUR_White
PUR_Yellow
PUR_Cyan
PUR_Green
PUR_Red
PUR_Magenta
PUR_Blue
PUR_Black/Off



Color Bar
Off
COL_100_25
COL_75_25
COL_100_0
COL_75_0
COL_SMPTE
COL_Horz
COL_SP_100
COL_SP_75

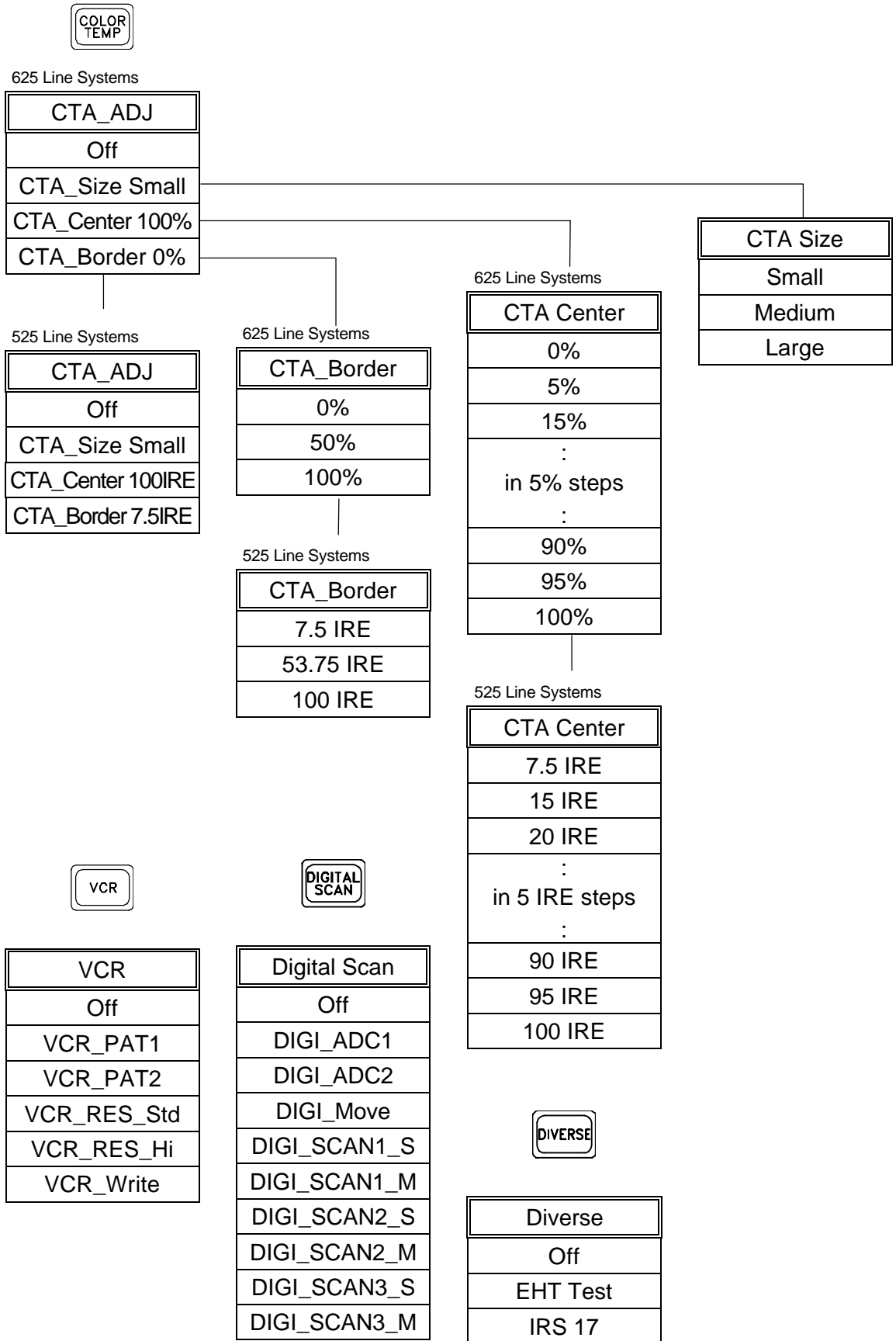

For details see Chapter 4, Description and Applications of the Test Patterns

Abbreviation	Pattern
Center Cross	
Center_2%	White or black cross with 2% overscan indication
Center_3%	White or black cross with 3% overscan indication
Dots	
Dots_White	White dots on black background
Dots_Black	Black dots on white background
Crosshatch	
CH_White	White crosshatch on black background
CH_White_C	White crosshatch with color burst
CH_White_C_TL	White crosshatch with color burst and Top Left indication
CH_Black	Black crosshatch on white background
CH_Black_C	Black crosshatch with color burst
CH_Black_C_TL	Black crosshatch with color burst and Top Left indication
White	
White_7.5IRE	White fullfield pattern
White_15IRE	White level 7.5 IRE (525 lines systems)
White_100IRE	White level 15 IRE (525 lines systems) in 5 IRE steps to
White_0%	White level 100 IRE (525 lines systems)
White_5%	White level 0% (625 lines systems)
White_15%	White level 5% (625 lines systems)
White_20%	White level 15% (625 lines systems)
White_100%	White level 20% (625 lines systems) in 5% steps to
	White level 100% (625 lines systems)
Demodulation Test	
DEM_PAT1	Demodulator test. Pattern depends on TV system.
DEM_PAT2	Demodulator test. Pattern depends on TV system.

Purity

PUR_White	Full field, white pattern
PUR_Yellow	Full field, yellow pattern
PUR_Cyan	Full field, cyan pattern
PUR_Green	Full field, green pattern
PUR_Red	Full field, red pattern
PUR_Magenta	Full field, magenta pattern
PUR_Blue	Full field, blue pattern
PUR_Black/Off	Full field, black pattern

Color Bar

COL_100_25	Full field. Level 100/0/100/25
COL_75_25	Full field. Level 75/0/100/25
COL_100_0	Full field. Level 100/0/75/0 for 625 Line Systems 100/7.5/75/7.5 for 525 Line Systems
COL_75_0	Full field. Level 75/0/75/0 for 625 Line Systems 75/7.5/75/7.5 for 525 Line Systems
COL_SMPTE	Three horizontal bars according to SMPTE EG 1-1990
COL_Horz	Eight horizontal bars with different colors
COL_SP_100	Split field. 2/3 color bar, 1/3 purity. White level 100%
COL_SP_75	Split field. 2/3 color bar, 1/3 purity. White level 75%

CTA_ADJ

CTA_Size Small	Color Temperature Adjustment Center size selecting: Small, Medium, or Large
CTA_Center 100%	Luminance level for white center
CTA_Border 0%	Luminance level for black border

CTA Center	For 625 Line Systems
0%	Luminance level 0%
5%	Luminance level 5%
10%	Luminance level 10%
	in 5% steps to
100%	Luminance level 100%

CTA Center	For 525 Line Systems
7.5IRE	Luminance level 7.5 IRE
15IRE	Luminance level 15 IRE in 5 IRE steps to
100IRE	Luminance level 100 IRE

CTA_Border	For 625 Line Systems
0%	Luminance level 0%
50%	Luminance level 50%
100%	Luminance level 100%

CTA_Border	For 525 Line Systems
7.5IRE	Luminance level 7.5 IRE
53.75IRE	Luminance level 53.75 IRE
100IRE	Luminance level 100 IRE
VCR	
VCR_PAT1	Two black and one white vertical bars
VCR_PAT2	Three horizontal bars with different contents and one black horizontal bar with moving white square
VCR_RES_Std	Pattern for Standard Resolution Test (2.8 MHz burst)
VCR_RES_Hi	Pattern for High Resolution Test (5 MHz burst)
VCR_Write	Red field to adjust writing current of VCRs
Digital Scan	
DIGI_ADC1	Eight horizontal bars with different ramps
DIGI_ADC2	Five times three horizontal bars with different ramps
DIGI_Move	Moving white vertical bar on black
DIGI_SCAN1_S	Four different horizontal white lines on black (still)
DIGI_SCAN1_M	Four different horizontal white lines on black (moving)
DIGI_SCAN2_S	Four different vertical white lines on black (still)
DIGI_SCAN2_M	Four different vertical white lines on black (moving)
DIGI_SCAN3_S	Five groups of four white lines $\pm 45^\circ$ shifted (still)
DIGI_SCAN3_M	Five groups of four white lines $\pm 45^\circ$ shifted (moving)
Diverse	
EHT Test	Black border and toggling center between white and black
IRS17	Visible pattern of the Insertion Reference Signal in line 17

Index

—<—

<NR1>, 6-21
<NR2>, 6-21
<NR3>, 6-21
<NRf>, 6-21

—3—

3-wire connection, 6-12

—A—

Acceptor handshake, 6-6
Accessories, 7-23
ADC Check, 4-65, 4-66, 7-9
AM modulation, 5-38
Analog mono sound, 5-38
Analog stereo sound, 5-39
Antiope, 5-10, 7-16
Aspect Ratio, 6-29, 7-4
Attenuation, 7-5
Audio, 7-10, 7-11
Audio input, 3-18, 7-11
Audio output, 3-18, 5-38, 5-41, 7-10
Audio signals, 5-39
Audio/Video input, 3-19
Audio/Video output, 3-19

—B—

Base band, 7-15
Baud rate, 6-9, 6-11, 7-20
Bi-phase coding, 7-16
Bi-phase modulation, 7-17
Bit-rate, 7-14
Blanking level, 7-7, 7-19, 7-20
Brief Checking Procedure, 3-3, 3-4
Brief functional test, 8-3

BTSC base band, 7-15
BTSC compressed, 7-15
BTSC Compressor, 5-48
BTSC Mixed, 5-60
BTSC MPX, 7-10
BTSC sound, 5-48, 5-49, 5-50
BTSC sound system, 5-48
BTSC Test Modes, 5-53
Built-in options, 1-5

—C—

Calibration, 1-9
Carrier frequency, 7-7
Carrier level setting, 3-9
CC Number, 5-35
CC1 Service, 5-32, 5-35
CCIR System, 7-16, 7-17
Center Cross, 4-43, 7-8
Center indication, 7-8
Character set, 5-9, 5-10, 5-13
Checkerboard, 4-47, 7-9
Chroma amplitude, 6-28
Chroma amplitude setting, 4-26
Chroma signal, 3-15
Chrominance, 7-7, 7-19
Circle, 4-42, 7-8
Clock cracker, 5-9, 5-10
Closed Caption, 7-24
Closed Caption (CC), 4-14, 5-32, 6-36, 7-18
Closed Caption, function verification, 8-21
Color Bar, 4-57, 7-8, 7-9
Color Temperature, 7-9
Combined test patterns, 3-12, 4-71
Common Commands, 6-16
Common system functions, 6-3
Composite sync, 5-64
Connectors, 3-13

Control elements, 3-13
Corner circles, 7-8
Country, 6-23
Crosshatch, 4-46
Current settings, 4-3, 4-35
CVBS SYNC, 7-4
CVBS Video, 7-4

—D—

Damage, 1-5
Data bits, 6-11, 7-20
Data Terminal Equipment, 6-11
Decoder pattern, 7-14
Default settings, 4-38
DEM pattern, 4-49
Demodulator pattern, 7-14
Demodulator Test, 7-9
Deviation, 7-12, 7-13, 7-15
Device clear, 6-12
Device clear function, 6-6
Device functions, 6-3
Device setting queries, 6-40
Device Specific Messages, 6-21
DIDON, 5-10
Digital data, 4-39
Digital Data query, 6-42
Digital menu, 4-14
Digital Scan, 7-9
Digital Services, 4-14, 7-16
Dimensions and weight, 7-22
Display, 3-13, 3-16
Display mode, 6-39
Diverse, 4-70, 7-9
Dots, 4-45, 7-8
Double sideband AM, 7-6
Dual sound, 5-39, 5-42, 7-11

—E—

EHT Test, 4-69, 7-9
Electrostatic discharge, 7-21
EMC emission, 7-21
EMC immunity, 7-21
Environmental Conditions, 7-21
Error messages, 3-3, 6-50
EURO AV, 7-4, 7-10, 7-11, 7-19
EURO AV Control Voltages, 7-4
Extension packet X/26, 5-7
External sound modes, 5-62
External sound modulation, 5-61
External video modulation, 5-60

—F—

Fast Blanking, 7-5
Fast transient, 7-21
FASTEXT, 5-5

FAW, 5-42, 5-43
Feed through capability, 3-16
Feedthrough Connection, 7-20
Field Synchronization, 7-4
FLOF, 5-5
FM A2, 5-39, 5-40, 5-56, 5-58, 5-62
FM Germany, 5-40, 5-56, 5-58, 5-62
FM Korea, 5-40, 5-58, 5-62
FM modulation, 5-38
FM Stereo Pilot, 7-10
Frame Alignment Word. *See* FAW
Frame Identification, 6-25
FREQ key, 4-7, 4-15
Freq. deviation, 7-8
Front panel, 1-3, 3-13
function verification, 8-23
Full Field Color Bar, 4-57
Full Level-One Features. *See* FLOF
Function verification, 8-5, 8-15
Fuses, 1-10

—G—

Go to local, 6-12
Go to remote control, 6-12
Greyscale, 4-49, 7-9
Group Delay, 6-24, 7-6

—H—

Handshake, 7-20
Handshake procedure, 6-6
Hardware connection, 6-11
Hardware handshake, 6-11
High Resolution Test, 4-64
Horizontal Color Bar, 4-60, 7-9

—I—

Identification frequency, 7-13
IEEE Address Popup Menu, 6-5
IEEE-488 bus connector, 3-17
IEEE-488 bus interface, 6-3, 7-20
IF sound carrier signal, 3-18
Index page, 5-4, 5-9
Input power module, 3-17
Installed option, 1-7
Instrument address, 6-4
Instrument configuration, 6-7
Instrument default settings, 6-17
Interface communication configuration, 6-7
Interface functions, 6-3, 6-6, 6-12
Interface selection, 6-8
Internal operations, 6-17
IRS17, 4-70
Isolation transformer, 1-11

—K—

Keyboard, 4-6
Korean Stereo, 5-40

—L—

Label Channel Identifier, 5-23
Labeling, 7-17
LCI, 5-23
LEVEL key, 4-7, 4-18
Level range, 6-23
LF bandwidth, 5-39
Line 21 Data Service, 5-32, 5-33
Line connector, 1-10
Line frequency, 7-22
LINE SYNC, 7-4
Line voltage, 7-22
Listener function, 6-6
Local lock out, 6-6, 6-12
Local time offset, 6-39
Luminance, 7-4, 7-7, 7-19
Luminance level selection, 4-34
Luminance signal amplitude, 7-19

—M—

Main channel, 7-10, 7-15
Main menu, 3-4, 4-3
Maintenance, 1-9
Manual settings, 4-9
Memory registers, 4-35
Message communication functions, 6-3
Message Terminator, 6-13
Modulation, 7-5, 7-6, 7-12, 7-13, 7-15
Modulation frequency setting, 3-11
Modulation matrix, 7-12, 7-13
Mono carrier, 7-10
Mosaic graphics, 5-9
Moving Block, 4-67, 5-16, 7-9
MTBF, 7-21
MTS input, 5-52, 5-62, 5-63
MTS Multiplex, 7-11
MTS multiplex input, 3-18
Multi Labelling, 5-22, 5-23
Multiburst, 4-48, 7-8, 7-9

—N—

NICAM amplitude, 6-34
NICAM Clock, 7-11
NICAM data, 5-46, 5-47, 7-11
NICAM de-emphasis, 5-46
NICAM output, 5-46, 7-11
NICAM sound, 5-44, 5-61, 7-11
NICAM source, 6-35
NICAM Test Modes, 5-46
NICAM test signal, 5-46

NICAM-728, 5-42
Nominal line frequency, 1-10
Nominal voltage range, 1-10
Numerical input, 4-15, 4-18, 4-22, 4-26
Numerical keypad, 4-7

—O—

Operating position, 1-11
Out of Range message. *See* Error message
Output of NICAM sound, 3-18
Overscan indication, 7-8

—P—

Page Header Control Bits, 5-9, 5-13
Page update, 5-9
PAL, function verification, 8-5
Parity, 6-11
Parity check, 7-20
Pattern combinations, 4-31, 7-9
PATTERN keys, 4-6, 4-30
Pattern parameter, 3-11
Pattern parameter selection, 4-31
Pattern selection, 4-30
Patterns, 7-8
PDC, 4-14, 6-36
PDC Data Set, 5-23
PDC description, 5-22
PDC memory location, 5-8
PDC Preselection data, 5-7
PDC Program Title, 5-24
PDC test data, 5-8
PDC, function verification, 8-12, 8-29
Performance Characteristics, 7-3
Phase tolerance, 7-8
PIL, 5-24, 5-30
Pilot carrier, 5-48
Pilot carrier frequency, 7-13
Pilot signal, 7-11
Pilot subcarrier, 7-15
PLUGE, 4-56, 7-8, 7-9
Polarity, 7-4, 7-6, 7-19
Power cable, 1-10, 7-23
Power consumption, 7-22
Power Requirements, 7-22
Power switch, 3-13
Pre-defined country list, 3-5, 4-7
Pre-emphasis (FM), 6-34, 7-12
Preselection Function, 5-7, 5-22, 5-23
Program message, 6-21
Program Message Syntax, 6-13
Programme Delivery Control, 5-22
Programme Identification Label. *See* PIL
Programming examples, 6-43
Progressive Scan Check, 4-67, 4-68, 5-16, 7-9
Protective earth conductor, 1-9
PSF, 5-7, 5-23
Purity, 4-55, 7-8

—Q—

QPSK modulation, 5-43, 7-14
Queries, 6-16

—R—

R G B output, 3-17
Rack mount adapter, 7-24
Radio frequency output, 3-16
Radio interference, 1-11, 6-11
Range exceedings. *See* Error messages
RCF, 5-23
Readout, 7-5
Real Time Clock, 5-20, 6-39
Rear panel, 1-3
Recalibration interval, 7-21
Recall, 3-14, 4-37
Recall command, 6-21
RECALL key, 4-7, 4-37
Recording Control Function, 5-23
Register 0, 4-38
Repair, 1-9
Reserve Sound Switching Flag. *see* RSSF
Reset command, 6-17
Residual carrier, 6-24, 7-6
Resolution Test, 7-9
RF carrier, 4-15
RF carrier frequency, 3-8, 3-14
RF Frequency, 6-22
RF level, 4-18, 6-22
RF level setting, 3-14
RF query, 6-40
RF sync level, 7-6
RGB Outputs, 7-19
RGB, YC, 7-19
RS-232 configuration, 6-9
RS-232 connector, 3-17
RS-232 Interface, 6-7, 7-20
RSSF, 5-44, 6-34, 7-14

—S—

S1 Modulation, 5-44, 5-56, 5-58, 7-12, 7-15
S2 Modulation, 5-45, 5-57, 5-59, 7-13, 7-15
S3 Modulation, 5-45, 5-56, 5-58, 7-12
Safety instructions, 1-9
Safety requirements, 7-3
Safty and EMC Requirements, 7-3
SAP signal, 5-57, 5-59, 6-35, 7-15
SAP sub channel, 7-15
SAP subcarrier frequency, 7-15
Save, 4-35
Save command, 6-21
SCART CVBS, 6-30
SCART output, 6-30
SCART/Euro-AV connector, 3-19
SECAM system, 5-12

Second Audio Program, 5-48
Self-test routine, 3-3, 8-4
Separator, 6-21
Service installable options, 7-24
Service Manual, 7-24
Service Request, 6-14, 6-20
Signalling method, 7-16
SMPTE Color Bar, 4-59, 7-8
Softkeys, 3-13, 4-3, 4-7
Sound, 7-10
Sound carrier, 7-10
Sound carrier 1, 7-12
Sound carrier 2, 7-12, 7-14
Sound carrier amplitude, 6-33
Sound carrier frequencies, 5-40, 5-42, 7-11, 7-12
Sound carrier level, 5-38, 7-10
Sound channel, 3-15
Sound frequencies, 5-38
Sound IF output, 5-38, 5-41, 7-10
SOUND keys, 4-13
Sound mode, 6-31
Sound mode settings, 4-12
Sound modes, 3-15
sound modulation, 3-15
Sound modulation frequency, 6-32
Sound operating modes, 5-56
Sound output, 5-38, 5-41, 7-10
Sound query, 6-41
Sound settings, 3-10, 4-12
Sound source, 6-31
Sound submenu, 4-5
Sound system, 3-6, 5-41, 5-44, 5-51, 6-31
Sound, function verification, 8-8, 8-18, 8-26
Source handshake, 6-6
Specifications, 7-1, 7-3, 7-21
Spectral purity, 7-5
Split Field Color Bar, 4-58
Standard Event Status Register, 6-15
Standard Resolution Test, 4-64
Status and Event, 6-20
Status Registers, 6-14
Step function, 4-17, 4-20, 4-24, 4-28
Step keys, 3-14
Stereo, 7-10
Stereo sub channel, 7-15
Stereo subcarrier frequency, 7-15
Stereo/Dual, 7-12
Stop bits, 6-11, 7-20
Store, 3-14, 4-35
STORE key, 4-7, 4-35
Stored settings, 4-37
Submenu for Digital Services, 4-5
Support submenu, 4-6
Survey of pages, 5-4
Synchronization, 6-19, 7-4, 7-7, 7-19
Synchronization outputs, 3-17, 5-64, 7-4

System data, 6-16
 System Mk, 7-13
 System query, 6-40

—T—

T1 Service, 5-36
 Talker function, 6-6
 Teletext, 4-14, 6-35
 Teletext A, 5-12
Teletext Auto, 5-12
 Teletext B, 5-3, 5-5, 5-12
 Teletext data, 5-12, 5-13
 Teletext Data Packet 8/30, 5-25
 Teletext DIDON ANTIOPE, 5-10, 7-16
 Teletext lines, 4-14, 6-36
 Teletext pages, 5-9
 Teletext UK, 5-3, 7-17
 Teletext, function verification, 8-12, 8-29
 Temperature, 7-9, 7-21
 Terrestrial RF Carrier, 7-5
 Test 1, 7-14
 Test 2, 7-14
 Test 3, 7-14
 Test equipment, 3-4, 8-3
 Test pattern indication, 4-30
 Test patterns, 3-15, 4-30
 Text, 4-39
 Text Service (T), 5-32
 TIMER block, 5-5, 5-7
 TO FRONT, 7-20
 TO REAR, 7-20
 TOP (Table of Pages), 5-3
 Top-left indication (TL), 4-46, 7-8
 Transport method, 5-7
 Triggering, 5-64
 TTX CC Number, 5-34
 TTX System popup, 5-12, 5-34
 TV channel, 3-9
 TV patterns, 6-25
 TV standard, 4-7, 6-24
 TV standard submenu, 4-4
 TV system, 3-15, 4-7
 TV system settings, 4-9

—U—

UDT, 5-8, 5-21
 Universal Date and Time. *See* UDT
 Unmodulated carrier, 7-14
 Unpacking, 1-9

—V—

VCR Test, 4-62, 7-9

Video, 7-7
 Video amplitude, 6-28
 Video amplitude setting, 3-7, 4-22
 Video and RF, 7-4
 Video component output, 3-17
 Video input, 3-16, 7-6
VIDEO keys, 4-11
 Video modulation, 3-15, 7-6
 Video outputs, 3-16, 7-4
 Video polarity, 6-30
 Video Programme System, 5-26, 7-17
 Video query, 6-41
 Video Recorder Programming, 5-5, 5-7
 Video settings, 4-10
 Video signal, 3-15
 Video source, 6-28
 Video source settings, 4-11
 Video standard, 3-6
 Video submenu, 3-7, 4-4
 Video synchronization, 6-30
 Video, function verification, 8-5, 8-15, 8-23
 Vision carrier, 5-60
 Vision carrier frequency, 7-5
 Vision carrier frequency settings, 4-15
 Vision carrier level settings, 4-18
 VPS, 4-14, 6-37, 7-17, 7-24
 VPS data line, 5-26
 VPS Data Set, 5-27
 VPS description, 5-26
 VPS Program Title, 5-28
 VPS, function verification, 8-14, 8-31
 VPS/PDC option, 5-6, 5-7
 VPT, 5-5

—W—

Warming-up time, 7-21
 White, 4-48, 7-7, 7-8
 Wide Screen Signalling (WSS), 4-14, 5-14, 6-38, 7-16
 Writing Current, 7-9
 Writing Current Adjustment, 4-64
 WSS Auto mode, 5-16
 WSS data, 6-38
 WSS manual mode, 5-17
 WSS signal, 5-15, 7-16
 WSS Status Bits, 5-14, 5-18
 WSS, function verification, 8-14, 8-31

—Y—

Y/C output, 3-19, 7-19
 YCrCb output, 7-19

Manual Supplement

Manual Title: 54200/54100 Users Manual
Part Number: 4822 872 10186
Print Date: 12/1/96
Revision/Date: 15/1/97 (rev. 2)

Supplement Issue: 2
Part Number: 4822 872 08569
Issue Date: 02/11/00
Page Count: 8

This supplement contains information necessary to ensure the accuracy of the above manual.

This manual supplement is valid for the undermentioned manuals:

Fluke 54100: 4822 872 10186 Users Manual English
4822 872 10187 Users Manual German
4822 872 10188 Users Manual French

Fluke 54200: 4822 872 10182 Users Manual English
4822 872 10183 Users Manual German
4822 872 10184 Users Manual French



SUPPLEMENT FOR USERS MANUAL.

Extensions of Fluke Model 54200/54100 User Interface.

The popup menus under the keys DIVERSE, WHITE, and COLOR TEMP have had a number of extensions. There are also extensions to the GREYSCALE pattern and to CLOSED CAPTION:

DIVERSE:

- The selection SINX/X has been added. This selection gives a black & white test pattern: the left half of the screen is black with a vertical white line in the middle; the right half of the screen is white with a vertical black line in the middle (see figure).

This type of test pattern has been added to check bandwidth and phase behaviour of a video-transmission system like e.g. a video amplifier. The narrow white line on the black background and the narrow black line on the white background result in narrow pulses to be applied to a video system under test. These so-called SINX/X pulses consist of multiple frequencies with a flat amplitude across the total bandwidth.

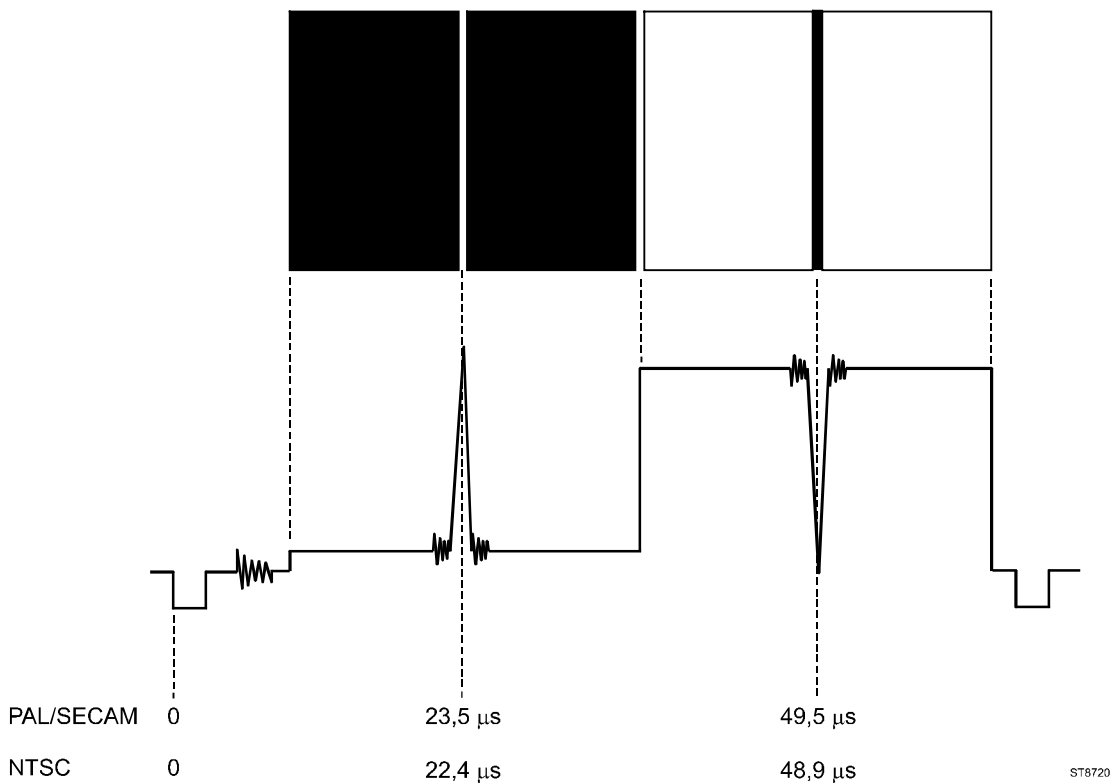

- Four extra selections OPT_1 .. OPT_4 are added. These selections are intended for future extensions: they are not active and therefore presented in a shaded tone. OPT stands for OPTIONAL.

WHITE:

The step 'White_10%' has been added for the systems PAL and SECAM.

COLOR TEMP:

The step '10%' has been added under the key COLOR TEMP and menu selection 'CTA_Center'. This is valid for the systems PAL and SECAM.

NEW REMOTE CONTROL COMMANDS.

The following remote control commands have been added in relation with the new functions (See also the pages 6-25 .. 6-27 of the Users Manual):

Pattern	Long form	Short form
SINX/X	PATTERN SINX_X	PAT S
White 10%	PATTERN WH_10	PAT WH_10
White 100%	PATTERN WH_100	PAT WH_100
Optional 1	PATTERN OPT_1	PAT OPT_1
Optional 2	PATTERN OPT_2	PAT OPT_2
Optional 3	PATTERN OPT_3	PAT OPT_3
Optional 4	PATTERN OPT_4	PAT OPT_4
Off	PATTERN OFF	PAT OF (PAT O not possible!).

Note: the Remote Control Interface ignores characters that follow on to a valid command. This means that e.g. WH_101 is interpreted as WH_10 and WH_100XYZ is seen as WH_100. On the other hand WH_99 results in an error message.

GREYSCALE.

The greyscale pattern consists of 11 vertical bars of increasing brightness on the TV screen, as per the specification of the pattern in section 7 (page 7-9) which says the pattern contains 10 intensity steps. In earlier versions of the generator, 10 vertical bars were displayed on the TV-screen, using only 9 intensity steps.

As a result, the pattern description and figures throughout chapter 4 are not correct. The TV screen will show 11 vertical bars of increasing intensity instead.

CLOSED CAPTION DATA EXTENDED WITH V-CHIP DATA.

Closed Caption (CC) is extended with a limited number of Data Packets according "EIA-608 - line 21 Extended Data Services packets", a system also referred to as 'the V-chip system'.

For this purpose, existing Closed Caption Numbers or 'pages' have been extended with fixed EDS data. The data packets represent 'MPAA Ratings' and 'TV Parental Guideline' information in the table below. This data can be used to perform a basic test of the V-chip decoder in a TV-set.

See the pages 5-32 through 5-38 for further details on the CC system and the data transmitted.

If CC-Sequence is selected, and the generator generates the individual CC-numbers sequentially, all EDS data sets will also sequentially be activated.

Extended Data Packets for the V-Chip system have been added to the following data sets:

Set	Hex	EDS data
1		(non)
2		(non)
3	01 05 41 40 0F 6A	MPAA rating 'G'
4	01 05 46 40 0F 65	MPAA rating 'X'
5		(non)
6		(non)
7	01 05 48 41 0F 62	TV-Parental Guide rating 'TV-Y'
8	01 05 48 66 0F 3D	TV-Parental Guide rating 'TV-MA' + violence

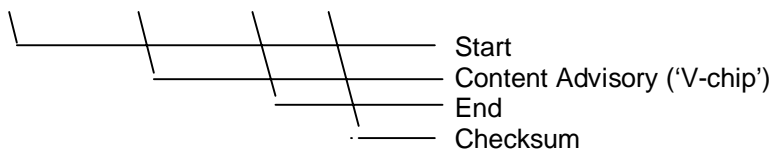

EDS-data as contained in the Closed Caption Numbers.

ERGÄNZUNG ZUM BEDIENUNGS-HANDBUCH

Erweiterungen der Benutzeroberfläche der Fluke-Meßgeräte vom Typ 54200/54100.

Bei den Popup-Menüs unter den Tasten DIVERSE, WHITE und COLOR TEMP hat es einige Ergänzungen gegeben. Es gibt auch Ergänzungen zum Testbild GRAUTREPPE und CLOSED CAPTION:

DIVERSE:

- Die Wahlmöglichkeit SINX/X wurde hinzugefügt. Wenn Sie diese Option wählen, erscheint ein Schwarzweiß-Testbild: Die linke Hälfte des Schirms ist schwarz mit einer senkrechten weißen Linie in der Mitte; die rechte Hälfte des Schirms ist weiß mit einer senkrechten schwarzen Linie in der Mitte (siehe Abbildung).

Dieser Typ von Testbild wurde hinzugefügt, um das Bandbreiten- und Phasenverhalten eines Videoübertragungssystems wie z.B. eines Bildverstärkers zu testen. Die schmale weiße Linie auf dem schwarzen Hintergrund und die schmale schwarze Linie auf dem weißen Hintergrund bewirken, daß schmale Pulse an einem zu testenden Videosystem angelegt werden. Diese sogenannten SINX/X-Pulse bestehen aus mehreren Frequenzen mit einer flachen Amplitude über die gesamte Bandbreite.

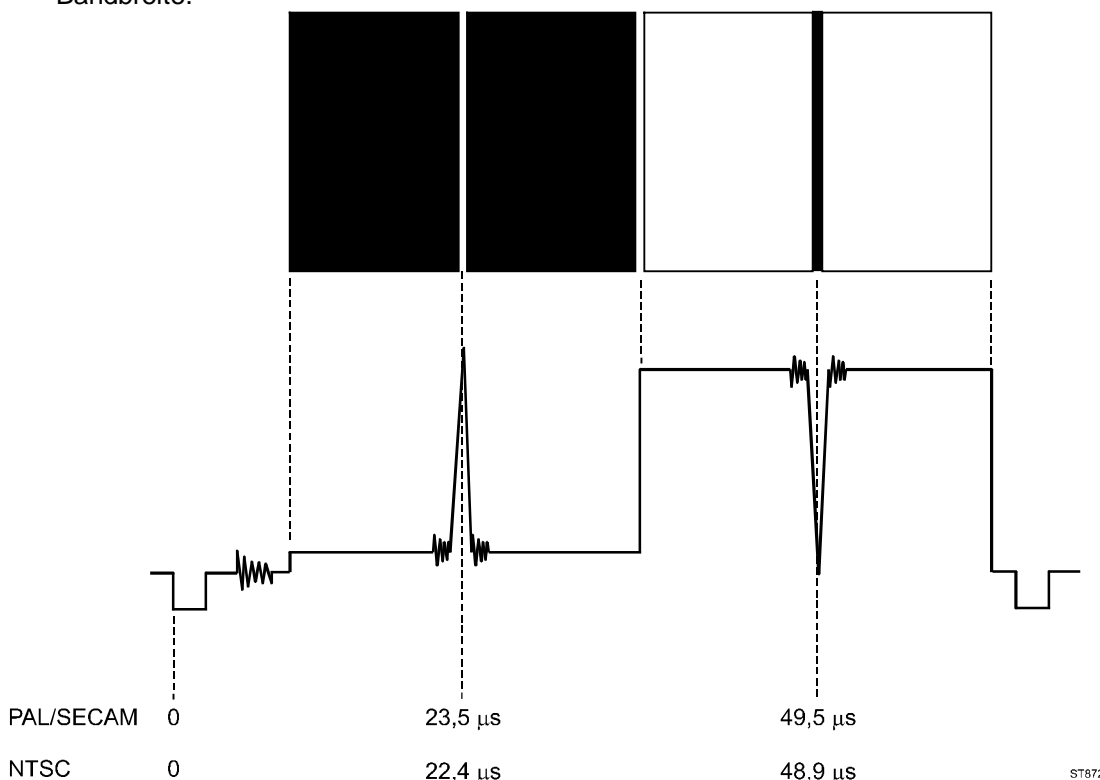

- Vier zusätzliche Wahlmöglichkeiten OPT_1 .. OPT_4 wurden hinzugefügt. Diese Optionen sind für künftige Erweiterungen gedacht: Sie sind nicht belegt/aktiv und werden daher schattiert angezeigt. OPT steht für OPTIONAL.

WHITE:

Für die Systeme PAL und SECAM wurde der Schritt 'White_10%' hinzugefügt.

COLOR TEMP:

Unter der Taste COLOR TEMP und der Menüauswahl 'CTA_Center' wurde der Schritt '10%' hinzugefügt. Dies gilt für die Systeme PAL und SECAM.

NEUE FERNBEDIENUNGSBEFEHLE.

Die folgenden Fernbedienungsbefehle wurden im Zusammenhang mit den neuen Funktionen hinzugefügt (Siehe auch die Seiten 6-25 .. 6-27 des Bedienungs-Handbuchs):

Pattern	Long form	Short form
SINX/X	PATTERN SINX_X	PAT S
White 10%	PATTERN WH_10	PAT WH_10
White 100%	PATTERN WH_100	PAT WH_100
Optional 1	PATTERN OPT_1	PAT OPT_1
Optional 2	PATTERN OPT_2	PAT OPT_2
Optional 3	PATTERN OPT_3	PAT OPT_3
Optional 4	PATTERN OPT_4	PAT OPT_4
Off	PATTERN OFF	PAT OF (PAT O nicht möglich!)

Hinweis: Die Fernbedienungsschnittstelle übergeht Zeichen nach einem gültigen Befehl. Dies bedeutet, daß z.B. WH_101 als WH_10 interpretiert wird und daß WH_100XYZ als WH_100 gedeutet wird. Dahingegen führt WH_99 zu einer Fehlermeldung.

GRAUTREPPE.

Die technischen Daten (Kapitel 7, Seite 7-9) zeigen daß das Testbild 'Grautreppe' besteht aus 10 Stufen mit linearem Anstieg. Das Resultat ist ein Testbild über den gesamten Bildschirm mit 11 vertikalen Stufen von Schwarz bis Weiß.

Frühere Versionen der Generator stellen 10 vertikalen Stufen dar auf dem Bildschirm.

Es ist deshalb daß einigen Beschreibungen und Figuren von Testbilder in Kapitel 4 nicht ganz richtig sind. Der Bildschirm der Fernseher wird 11 vertikalen Stufen von Schwarz bis Weiß zeigen.

CLOSED CAPTION (CC) FUNKTION AUSGEDEHNT.

Die Funktion Closed Caption ist ausgedehnt mit einem beschränkten Zahl von Datenpakete gemäß 'EIA-608 – line 21 Extended Data Services packets' (EDS), ein System auch bekannt unter dem Name 'V-chip' System.

Die bereits existierende Closed Caption Dienste sind ausgedehnt mit fixierte EDS Datenpakete.

Die Datenpakete sind gemäß die Normen 'MPAA Ratings' und 'TV Parental Guideline' und werden gezeigt in die Tabelle an Seite 3.

Diese Datenpakete können verwendet werden um die 'V-chip' Dekoder in einem Fernsehgerät zu überprüfen. Siehe die Seiten 5-34 bis 5-39 für weiteren Informationen über Closed Caption.

SUPPLEMENT AU MODE D'EMPLOI.

Extensions de l'interface utilisateur du modèle Fluke 54200/54100.

Un certain nombre d'extensions ont été prévues aux menus popup sous les touches DIVERSE, WHITE, et COLOR TEMP. Aussi les fonctions ECHELLE DES GRIS et CLOSED CAPTION sont agrandi:

DIVERSE:

- La sélection SINX/X a été ajoutée. Cette sélection permet d'obtenir une configuration d'essai en noir et blanc: La moitié gauche de l'écran est noire avec une ligne verticale blanche au milieu; la moitié droite de l'écran est blanche avec une ligne verticale noire au milieu (voir la figure). Ce type de configuration d'essai a été prévu pour permettre de contrôler le comportement de la bande passante et de la phase d'un système de transmission vidéo tel qu'un amplificateur vidéo. La fine ligne blanche sur l'arrière-plan noir et la fine ligne noire sur l'arrière-plan blanc provoquent d'étroites impulsions qui sont envoyées à un système vidéo sous test. Ces impulsions, appelées impulsions SINX/X, sont formées de fréquences multiples avec une amplitude plate sur la totalité de la bande passante.

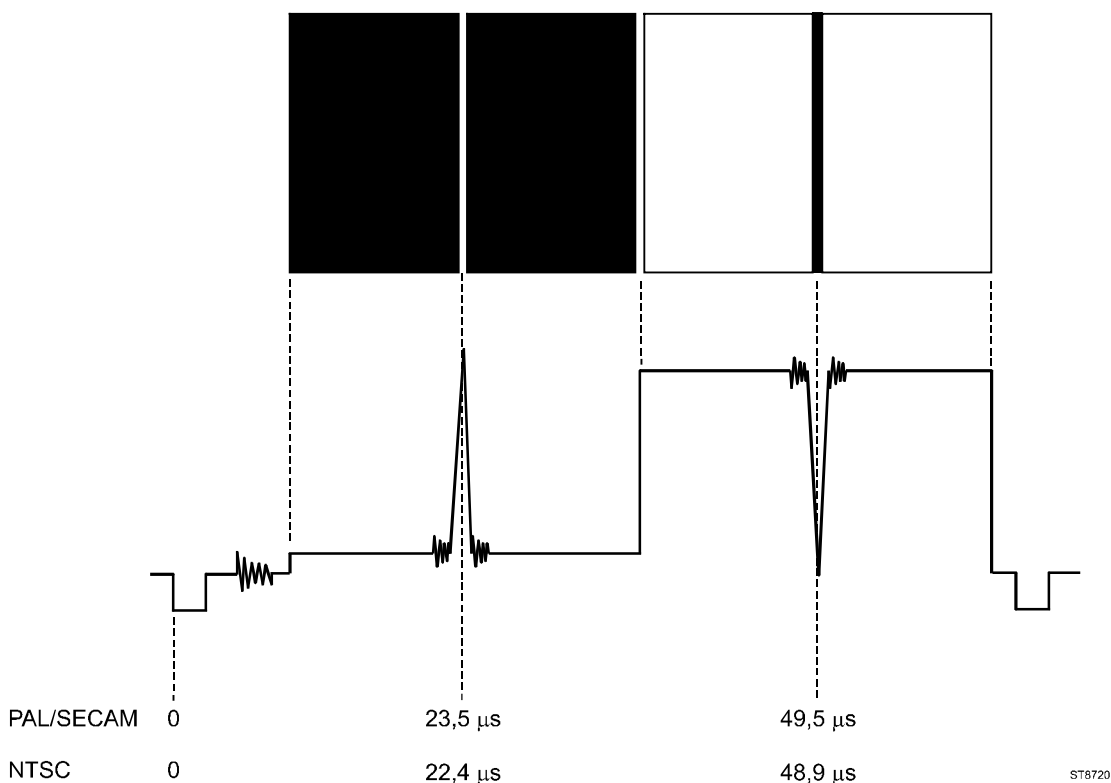

- Quatre sélections supplémentaires OPT_1 .. OPT_4 ont été ajoutées. Ces sélections sont prévues pour des extensions futures: elles ne sont pas actives et sont donc affichées ombrées. OPT est l'abréviation de OPTIONAL (optionnel).

WHITE:

Le pas 'White_10%' a été ajouté pour les systèmes PAL et SECAM.

COLOR TEMP:

Le pas '10%' a été ajouté sous la touche COLOR TEMP et le menu de sélection 'CTA_Center' pour les systèmes PAL et SECAM.

NOUVELLES FONCTIONS DE TÉLÉCOMMANDES.

Les nouvelles fonctions de télécommande suivantes ont été ajoutées (Voir aussi sur les pages 6 –25 .. 6-27 du Mode d'Emploi):

Configuration	Courte	Longue
SINX/X	PAT S	PATTERN SINX_X
White 10%	PAT WH_10	PATTERN WH_10
White 100%	PAT WH_100	PATTERN WH_100
Optional 1	PAT OPT_1	PATTERN OPT_1
Optional 2	PAT OPT_2	PATTERN OPT_2
Optional 3	PAT OPT_3	PATTERN OPT_3
Optional 4	PAT OPT_4	PATTERN OPT_4
Off	PAT OF	PATTERN OFF (PAT O pas possible!)

Remarque: l'interface de télécommande ignore les caractères qui suivent une commande valide. Cela signifie par exemple que WH_101 est interprété comme WH_10 et WH_100XYZ comme WH_100. D'autre part, WH_99 entraîne un message d'erreur.

ECHELLE DES GRIS.

Les caractéristiques techniques (Chapitre 7, Page 7-9) indiquent que l'échelle des gris contient 10 pas échelonnés. Le résultat est un signal en paliers recouvrant tout l'écran et comportant 11 paliers verticaux du noir au blanc.

Dans les versions préliminaires du générateur, un signal en 10 paliers est affiché sur l'écran du téléviseur. Cela est la raison que quelques descriptions et figures dans le chapitre 4 ne sont pas correctes. L'écran du téléviseur affiche un signal en 11 paliers verticaux du noir au blanc.

CLOSED CAPTION (CC) AGRANDI.

Le fonction Closed Caption est agrandi avec un nombre limité de paquets d'information selon la norme 'EIA-608 – line 21 Extended Data Services packets' (EDS), un système aussi mentionné 'V-chip data'. Les paquets de champ ont été étendue avec paquets d'information EDS fixé. Les paquets d'information sont selon les normes 'MPAA Ratings' et 'TV Parental Guideline' comme indiqué dans le tableau sur la page 3.

Les paquets d'information peuvent être utilisé pour tester la fonction 'detection de violence' dans un téléviseur. Voir sur les pages 5-34 ... 5-39 pour information supplémentaire sur Closed Caption.

Si 'CC-Sequence' a été sélectionné et le générateur produit les numéros CC séquentiel, tout les paquets d'information EDS ont été activé aussi séquentiel.