

LOGIC ANALYZERS PM 3580/PM 3585 User manual

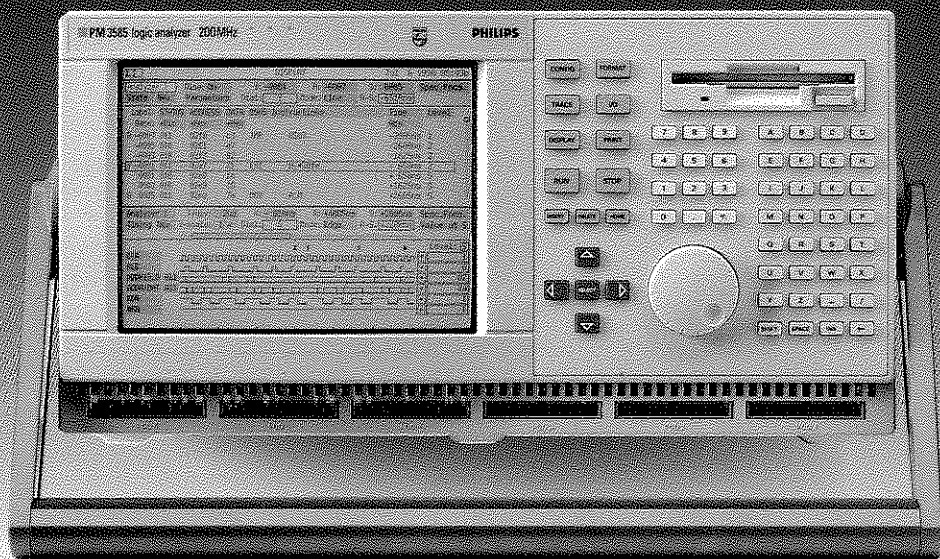

FLUKE AND PHILIPS - THE GLOBAL ALLIANCE IN TEST & MEASUREMENT



PHILIPS

General

Indicator number : Customer information.
 : CIS 1116
 : PF 8690/00 System Software,
Version 1.03, English
 for PM 3580/PM 3585 Logic An-
alyzers
 : October 1991
 : PM 3580/PM 3585 User Manual
To be inserted in

Please read the following notes carefully before you start working. They contain some important information on the differences between this and previous versions, as well as describing a number of minor limitations and restrictions.

Version 1.03 software contains a number of significant enhancements, as well as a number of cosmetic changes and bug-fixes. Most of the enhancements relate to the displaying the Data") has been extended. A brief list of the new display features, as well as the other changes, follows. For full details, refer to the User Manual.

New DISPLAY Menu Features

- Wavform display mode for state data.
- List display for timing data.
- Graph display for bus data ("chart mode").
- Accumulate mode for wavform data.
- Cursor control/readout (X, Y, R, S, R-S) can be in samples or time.
- Coscroll of upper/lower screens can be in samples or time.
- Wavform displays can be reset to a default "Best" horizontal scale (T/Div or S/Div).

Cosmetic changes and Bug-Fixes

- Disassembler files are protected from being inadvertently deleted/overwritten.
- After executing a "System reset" in the CONFIG menu, disas will be (re-)loaded from disk when required and not from memory as is currently the case in previous software versions.

System version 1.03 contains many small changes, including fixes for some bugs and inconsistencies which have been discovered and a number of small improvements relating to the operation ("cosmetic" changes). The most significant of these are:

- The pre-defined trigger sequence:
 $t_7 < \text{Pulse duration} < (t_7 + t_8)$
does not work correctly in previous versions. This has now been changed to:
 $t_7 > \text{Pulse duration} < t_8$
This sequence now works correctly. You fill in the same pattern values for t_{w7} and t_{w8} and the required lower/up-per time limits for t_7 and t_8 .
- In previous versions, under certain conditions the trigger point was flagged in the displayed data in the wrong place. This has been corrected.
- Range value in TRACE can now be entered in decimal mode.
- The DELETE action in the FIND window in a state and timing list has been inhibited. This lead a number of users to inadvertently delete labels.
- In Auto-Repeat mode ("stop on state not-equal") previous software versions compared all channels (whether defined for state acquisition or not). This could in certain

The R-S field in the display only gives 3/4 figure accuracy, so resolution is lost when the units are 10us or longer. If greater accuracy is required in a time difference measurement the individual R and S cursor values must be read out individually and manually subtracted (see page 76 of the Reference Guide).

Time Point Reconstitutions

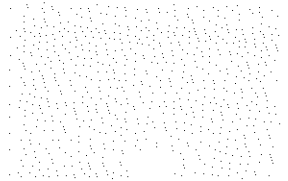

Manual Synchronization of Disassemblers

After stopping data acquisition and before displaying the data, a software algorithm is used to locate the precise trigger point in the data. Every effort has been made to minimize the time taken, though in certain cases (usually complex trigger sequences) it can still be rather long (several seconds).

Synchronization information entered in the display via the Disassembly Parameters pop-up is not saved in the measurement file.

Measurement File Format

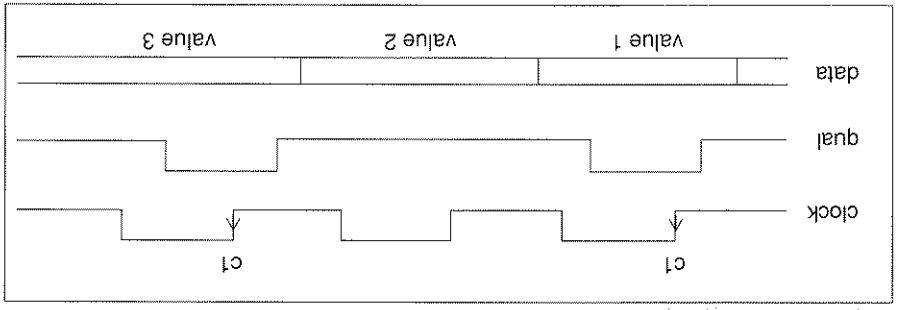

```

L1  If SW1  goto L2
L2  If SW2  Stop
    Or If SW2  goto L1

```

immediate state word triggering does not always work correctly when clocks are qualified. This typically applies in the case of processors such as the 80286, and is illustrated by the diagram below. A qualified clock, c1, is defined when the signal "qual" is high. Defining an immediate trigger condition "if sw1" with "sw1=value1" and "sw2=value3" will not cause the analyzer to trigger. This is because the immediate word recognizer incorrectly "sees" the unqualified "value 2". To trigger correctly, you should use the 2 level sequence as follows:

Version 1.03 has extensions to the format of the measurement files. Files created by version 1.03 can not be read on systems booted with earlier software versions. However, files created by these versions can still be read on systems booted with version 1.03.

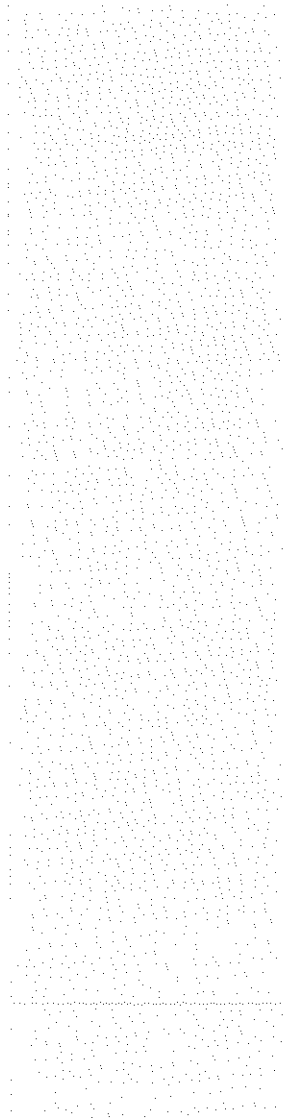

• RASCONV.MAN
SUN raster image format for sub-sequent processing (eg. import into document).
On-disk manual (DOS-text) for RASCONV.

LOGIC ANALYZERS

PM 3580 / PM 3585

User manual



Dual logic analysis

PF8690/00 System Software
Software Version 1.0, English
&E, Test & Measurement
© Copyright 1990, Philips Export B.V.

Publication Number 4022 104 90171

The foregoing guarantee is exclusive and is in lieu of all other guarantees, expressed or implied, including but not limited to any implied guarantee of merchantability, fitness, or adequacy for any particular purpose or use. We shall not be liable for any direct, indirect, special incidental, or consequential damages, whether based on contract, tort, or otherwise.

Some countries or states do not allow the foregoing limitations. Other rights may also vary.

Copyright ©1990, Phillips Export B.V.
Printed in the Netherlands

Thank you for purchasing this PHILIPS logic analyzer. It has been designed and manufactured to the highest quality standards to give you many years of trouble-free and accurate measurements.

Should you have any comments on how this product could be improved then please contact your local Fluke/Philips representative. Fluke/Philips addresses are listed in chapter 11 of this User Manual.

Introduction

- The PM 3580 / PM 3585 Family 1-2
- Dual Analysis Per Pin Architecture 1-3
- Key Features 1-4
- Menus 1-5
- Basic Measurement Loop 1-5
- Default Set up 1-6
- Repetitive Runs 1-6
- Disk Facilities 1-6
- Menu Overview 1-7
- Manuals 1-7
- Accessories 1-10

Overview of the Instrument

- Switching on the Logic Analyzer 1-10

Front Panel 2-2

- Keyboard 2-3
- Rear Panel 2-7

Menu Overview

- The Menus 3-2
- The Menu Bar 3-2
- Menu Fields 3-3
- The Analyzer Name Field 3-3
- Field Types 3-4
- The Configuration Menu 3-6
- The Format Menu 3-8
- Clock and Label Attributes 3-9
- The Threshold Level 3-11
- Polarity 3-12
- The Trace Menu 3-14
- Run Definition Area 3-15
- Sequencer Area 3-16
- Trigger Words Area 3-17
- The Display Menus 3-18
- The Special Functions Popup Menu 3-20
- Time Origin - T₀ 3-21
- The I/O Menu 3-22
- The Print Menu 3-24

State Clocks

- Sampling of State Data 4-2
- Example 4-2
- Specifying State Clocks 4-2

- Interrupt Response Time 5-20
- Check Minimum Pulse Width 5-29
- Check Maximum Pulse Width 5-29
- Check Pulse Duration 5-30
- Check Pattern Sequence 5-31
- Wait for a Pattern Sequence 5-31
- One Immediate Sequence of Two Patterns 5-32
- Two Immediate Sequences of Two Patterns 5-33
- Separately Trigger State and Timing 5-34
- Predicted Sequences 5-35
- The Predetermined Timing Sequences 5-36
- The Predetermined State Sequences 5-37
- Last User-defined Sequence 5-38
-
- Repetitive Measurements 5-39
- Starting Repetitive Measurements 5-39
- Terminating Repetitive Measurements 5-39
- Repeat Mode Timer 5-41
- Analyzing the Data**
- Display Concepts 6-2
- Data Source 6-4
- Data Type and Form 6-6
- Reference Data 6-7
- Data Comparison 6-7
- Measurement Data Overview 6-8
- Time Origin - T_0 6-9
- Time or Sample Numbers 6-10
- Sample Number 0 6-10
- Dial Operation 6-11
- Viewing Parts of the Measurement Data 6-12
- Display Locators 6-14
- Measurements (R and S cursors) 6-15
- Selecting Labels for Display 6-16
- Display of Sequencer Levels 6-17
- Waveform Displays 6-18
- Dial Movement (Dial Mode) 6-19
- X-scale (T/div and S/div) 6-21
- Y-scale 6-23
- Bus Data 6-23
- Waveform Data Representation 6-26
- Label Values 6-26
- Accumulate Mode 6-27
- List Displays 6-28
- Dial Movement (Dial Mode) 6-29
- List Data Representation 6-30

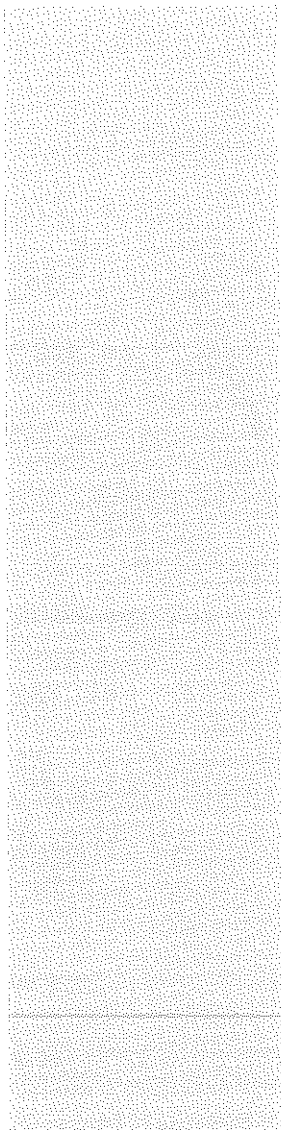

Safety Precautions	11-2
Caution and Warning Statements	11-3
Symbols	11-4
Impaired Safety Protection	11-4
Safety Notice	11-4
Installation	11-6
Working Position	11-6
Earthing	11-6
Setting the Line Voltage	11-7
Switching on the Logic Analyzer	11-9
Setting the Date and Time	11-10
Fluke/Phillips Addresses	11-11
U.S.A.	11-24
Utilities	
Utility Disk	12-2
Setting the Date and Time	12-3
Formatting Disks	12-4
Copying Disks	12-4
Index	
Microprocessor Support	

Chapter 1

Introduction

The PM 3580 / PM 3585 Family	1-2
Dual Analysis Per Pin Architecture	1-3
Key Features	1-4
Menus	1-5
Basic Measurement Loop	1-5
Default Set up	1-6
Repetitive Runs	1-6
Disk Facilities	1-6
Menu Overview	1-7
Manuals	1-7
Accessories	1-10
Switching on the Logic Analyzer	1-10

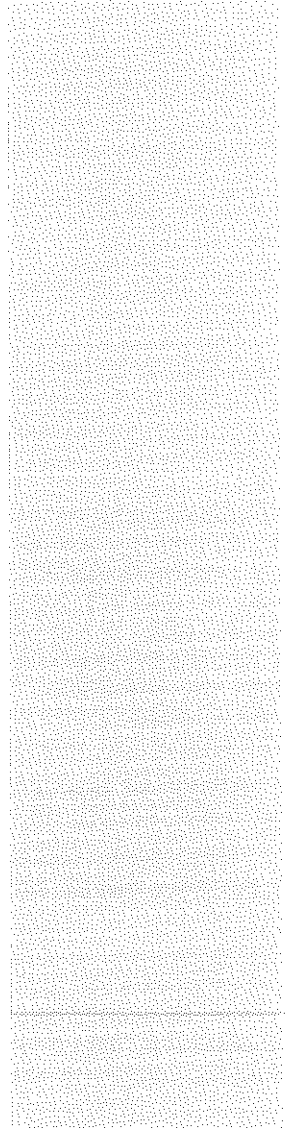

The new Dual Analysis Per Pin (DAPP) architecture makes simultaneous state *and* timing analysis possible per pin with *single probing*. The basic DAPP architecture is shown below.

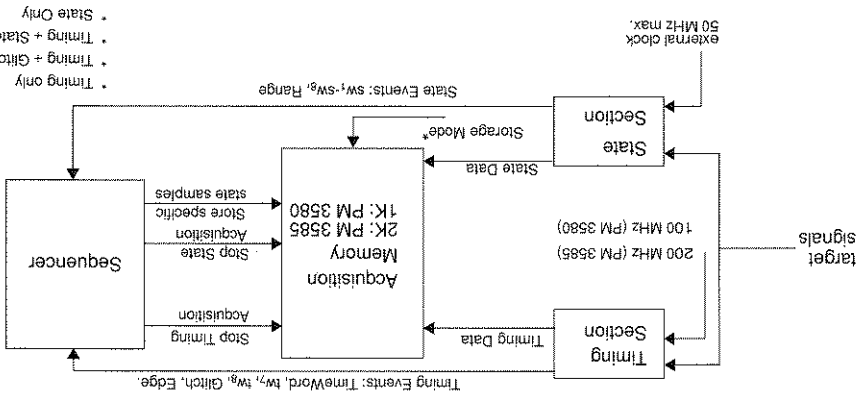

Simultaneous State and Timing Per Pin

PM3585: Two Analyzers

Both a timing section and a state section simultaneously observe the same target signals. The pattern recognition results (timing events and state events) of both sections are routed to one common sequencer. The sampled timing and state data are routed to the acquisition memory which can store a total of 2K samples (1K for PM 3580 units) and which you can assign to timing only data (100%, timing + glitch data (50%/50%), timing + state data (50%/50%), or state only data (100%).

The pattern recognition logic for state and timing patterns operates independently from the storage mode you select. This allows you always to search for state and timing patterns in parallel.

Inside your PM 3585 Logic Analyzer there are two independent Logic Analyzers, both having this unique Dual Analysis Per Pin architecture. These two analyzers can

In using a logic analyzer you generally go through the following basic measurement loop:

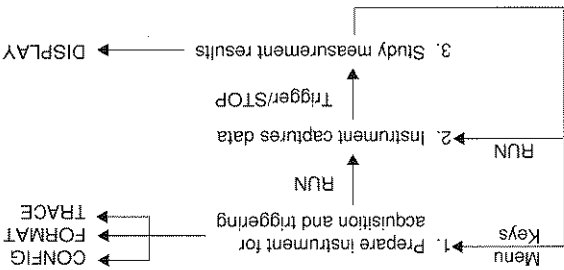

Basic Measurement Loop

In the first step you prepare the instrument for data acquisition. You should specify:

1. Which pods are relevant,
 2. The threshold levels of the signals,
 3. The signal names and attributes,
 4. The sequence of patterns to search for,
 5. Which data is to be stored (Timing only, Timing + Glitch, Timing + State, or State only).
- You do this by using the 3 menus referred to as:

- Configuration (CONFIG)
- Format (FORMAT)
- Trace (TRACE)

After you have set up the instrument, press the *RUN* key. The analyzer now captures data and searches for the sequence of patterns specified. As soon as the analyzer has found the trigger sequence, it stops data acquisition and shows you the results in the *DISPLAY* menu. You can then study the results, measuring how long signals show a specific level; how long program loops are etc..

The next two pages show you an overview of the four main menus (CONFIG, FORMAT, TRACE and DISPLAY) used during measurements, with typical entries. Compare the "Dual Analysis Per Pin (DAP) Mode" in the *PM 3580/PM 3585 Getting Started Guide*.

All menus are of the type "fill in the form". Each menu is extensively described in the *PM 3580/PM 3585 Reference Guide*. This guide is organized per menu. Given a menu, it concisely describes per field the purpose of the field and all the possible options.

The *PM 3580/PM 3585 Getting Started Guide* leads you through the different menus by means of a number of examples. In this guide the front and rear panels of the instrument are also described.

This manual, the *PM 3580/PM 3585 User Manual*, gives more background information with respect to the concepts implemented in your instrument. It explains, besides other things, the concepts and possibilities of the State Clock mechanism and sequencer. It also contains a number of more advanced examples. Understanding the background information provided in this manual allows you to get the most out of your instrument.

The *PM 3580/PM 3585 Service Manual* helps you in troubleshooting and repair at module level. It also contains the performance verification procedures for checking out the performance of your instrument.

Overview of the Instrument

Chapter 2

Front Panel 2-2
Keyboard 2-3
Rear Panel 2-7

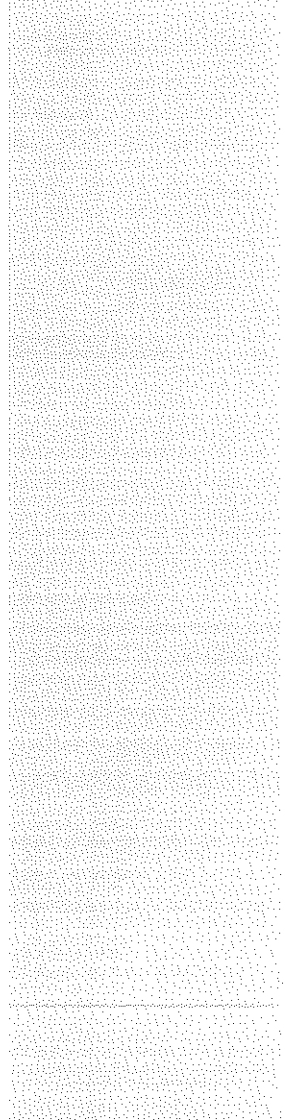

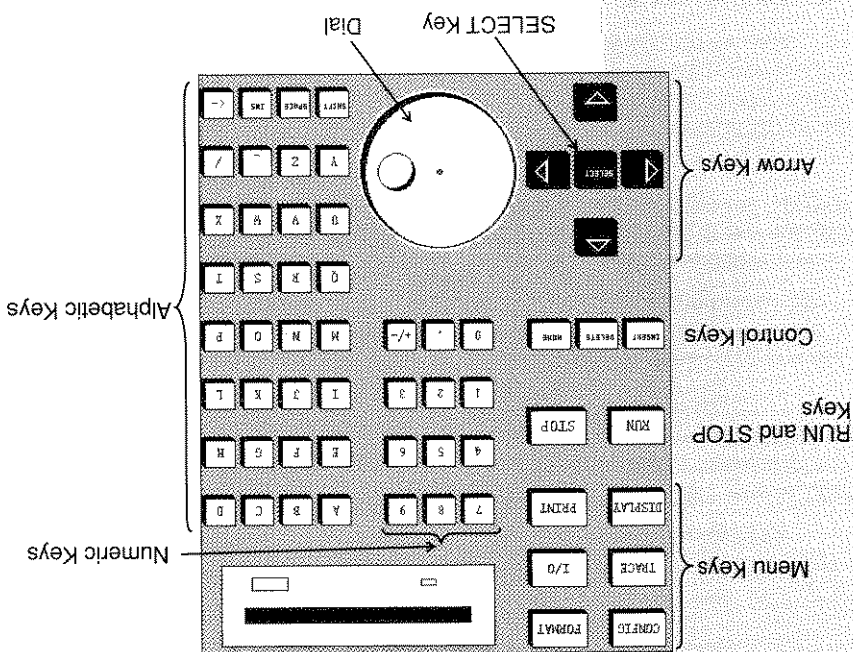

The PM 3580 / PM 3585 Logic Analyzer keyboard is logically grouped into several areas, plus the dial, as shown below. These areas, and the effect of their keys is as follows:

list or popup menu. (These terms are defined in the next chapter.) On the Display menu, however, the dial is used to scroll the data displayed or to move the selected cursor.

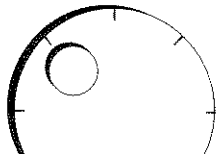

The **SELECT** key is used to select an action, toggle a value, and to end a numeric entry. (It has a function similar to the Enter or Return key of a computer keyboard.) The specific function of the **SELECT** key is explained in the relevant places.

The numeric keys allow the entry of numeric data and numbers within names.

The +/- key can be used to toggle the sign in numeric fields.

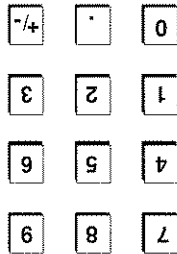

The alphabetic keys are used to rename the analyzer, signals, and files, etc. They can also be used to make quick selections from lists and to define units of measurement.

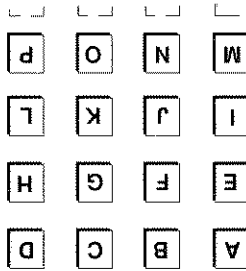

The alphabetic keys consist of the characters A through Z, the underscore, the forward slash, and the space.

Alphabetic Keys

Numeric Keys

Select Key

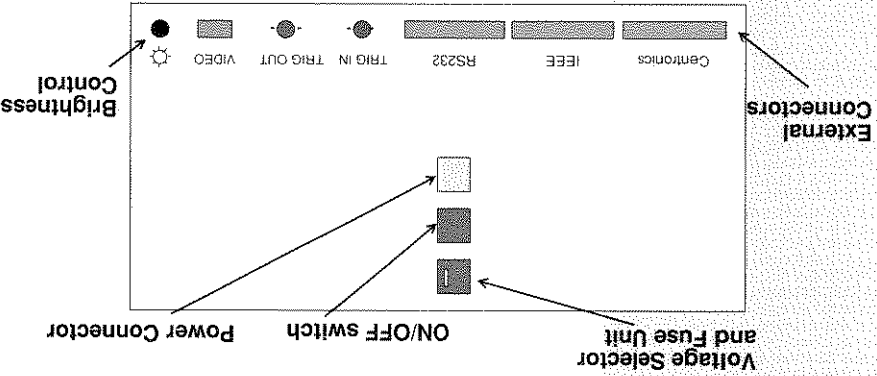

The rear panel has all the external connectors (communication interfaces, printer output, video output, trig in and out), the brightness control, power connection and the ON/OFF switch. The illustration at the foot of the page shows the connectors located at the bottom of the rear panel (described from left to right).

- Centronics connector: A female 25-pin 'D' connector for the attachment of a parallel printer with a Centronics interface.
- IEEE connector: optional IEEE-488 (24 pins) connector for remote operation.
- RS232 connector: A male 25-pin 'D' connector for the attachment of a serial mouse.
- TRIG IN connector: A male BNC connector by which a trigger pulse from another instrument can be input to the logic analyzer.
- TRIG OUT connector: A male BNC connector for supplying an external trigger pulse from the Logic Analyzer to another instrument.

Menu Overview

Chapter 3

- The Menus 3-2
- The Menu Bar 3-2
- Menu Fields 3-3
- The Analyzer Name Field 3-3
- Field Types 3-4
- The Configuration Menu 3-6
- The Format Menu 3-8
- Clock and Label Attributes 3-9
- The Threshold Level 3-11
- Polarity 3-12
- The Trace Menu 3-14
- Run Definition Area 3-15
- Sequencer Area 3-16
- Trigger Words Area 3-17
- The Display Menus 3-18
- The Special Functions Popup Menu 3-20
- Time Origin - T₀ 3-21
- The I/O Menu 3-22
- The Print Menu 3-24

To the right of the analyzer activity indicators, if the analyzer is in repeat mode (see Chapter 5, "Trace Control"), the repeat mode timer is shown. If auto-repeat is defined but not active, the repeat mode time is *light gray*. If auto-repeat is defined and active, the repeat mode time is *black and counting down* during the time interval between runs.

On each menu, there are a number of fields. These are the small white or gray boxes containing text. The currently active field is highlighted: it is the one with a white background. Key press actions only affect highlighted fields. You use the arrow keys or the dial to move the highlight from field to field.

To do something with the instrument, you will select the appropriate menu, highlight the appropriate field, and then press the appropriate key to do the action you want done. (While you are getting to know the instrument, this will most often be the *SELECT* key. You can also think of the *SELECT* key as a kind of help function.)

All the major menus concerning analyzers (*i.e.*, except the I/O menu) contain a field in which the current analyzer name is shown. On the Configuration menu, if you have a PM 3585 instrument, there are two such fields, one for each analyzer. The default names, used throughout the documentation, are Analyzer 1 and (on PM3585) Analyzer 2. These names can be changed on the Configuration menu. The

Repeat Mode Timer

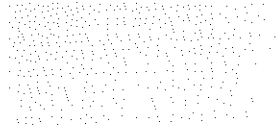

Menu Fields

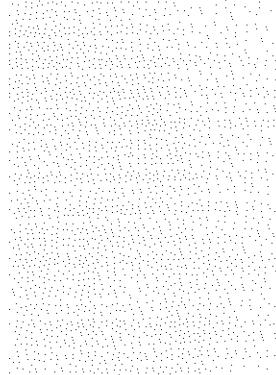

The Analyzer Name Field

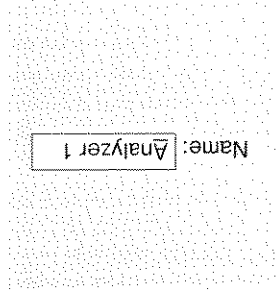

check field is not selected, the check (✓) that it is selected.

First Character Select:

Press the initial character of one of the options. (The appropriate options are shown in the *Reference Guide*.) Alternatively press *SELECT* to show the list of options.

List:

In these fields, the first character selection is not available. Press *SELECT* to show the list of options. The "▶" symbol after an option on a list indicates that on pressing *SELECT* or the right arrow on the option, a list or popup menu is shown appropriate to the option. When this "child" menu is closed, the "parent" menu is closed too.

Popup Menu:

Press *SELECT* to show a popup menu. The first field of any popup menu, in the *home* position, is the return field. To indicate that all changes have been made on the popup menu and to close the menu, press the *SELECT* or the *HOME* key on this field. The return field is a function field (see below).

Function:

When you press *SELECT* on a highlighted function field, the action described by the field is performed.

signment arrows). This is done by highlighting the pod you want to assign or deassign and then pressing *SELECT* to toggle the arrow between the two analyzers and none.

Pressing *DELETE* also causes the arrow to disappear. See the activity on the pods (the pod activity indicators). These fields (information only) show the current activity of the signals of the associated pod. Activity is high (-), low (-), or changing (‡).

- Reset the instrument to its start-up condition (*System Reset* field). On selection, a confirmation popup menu (Yes/No) is shown. If you select Yes, the system is first reset to the factory preset condition. If there is an auto-load file on the disk, this is then loaded.

The figure below shows the two popup menus for clock attributes, and label attributes. These popup menus give you access to more advanced parameters (attributes) of clock and data labels. The attribute *Timing label* is discussed below. The other attributes: *Qualifier(s)*, *Display on same line* and *State Clocks*. The menu for the current signal is popped up by pressing *SELECT* on its label field. By pressing *SELECT* on the Attribute field in this menu, the attributes menu is popped up.

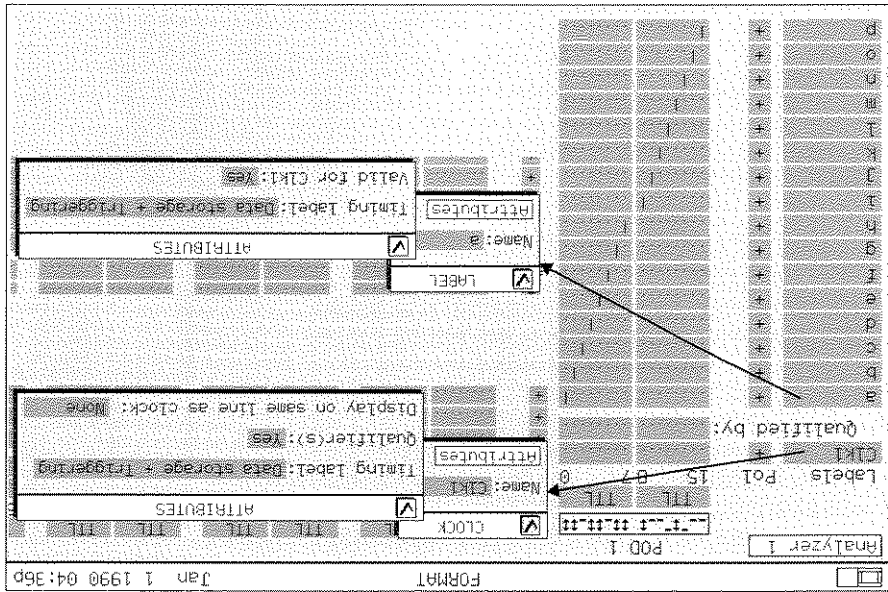

Timing label Attribute

The *Timing label* attribute allows you to switch off timing analysis for a specific label or clock.

Because of the Dual Analysis Per Pin architecture the PM3580/PM3585 Logic Analyzers capture both state and timing data simultaneously for all channels of all pods

can still specify trigger patterns (on the Trace menu) including conditions for these signals.

The analyzer interprets captured data as a logical 1 or 0 depending on whether or not the voltage exceeds the threshold selected in the threshold field. As all logic analyzers, the PM 3580 and the PM 3585 use a threshold detector on each channel. This is based on a user selectable threshold. Typical thresholds used are TTL (+1.4V) and ECL (-1.3V).

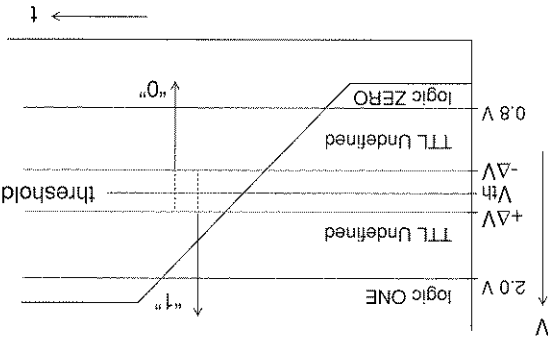

Note that this principle will always result in either a logic ONE or a logic ZERO. Undefined levels are still interpreted as one or the other, depending on their value with respect to the selected threshold.

If you are dealing with a noisy system, using different thresholds will show you how critical the noise on your system is.

Please pay attention to the overdrive required (+ΔV / -ΔV in the above figure) with respect to the threshold voltage. A rising edge must pass through $V_{th} + \Delta V$ before it is re-

Thus if the polarity is toggled (on the Format menu), you will see a corresponding change and adjustment in the trigger words and on the displays.

On first displaying the menu, the cursor (highlighted box) is on the analyzer field in the Run Definition area.

Run Definition Area

- Change between the first and second analyzer on PM 3585 instruments if both analyzers have pods assigned. (The *Analyzer* field.)
- Define the type of sequence to be used in the sequencer area (the *Sequence Type* field). You can choose between predefined sequences (shown at the bottom of the page), user-defined sequences (the default shown on the previous page) and restart sequences. Restart sequences are the same as user-defined, except that the *or* condition is used as a restart condition. That is, at

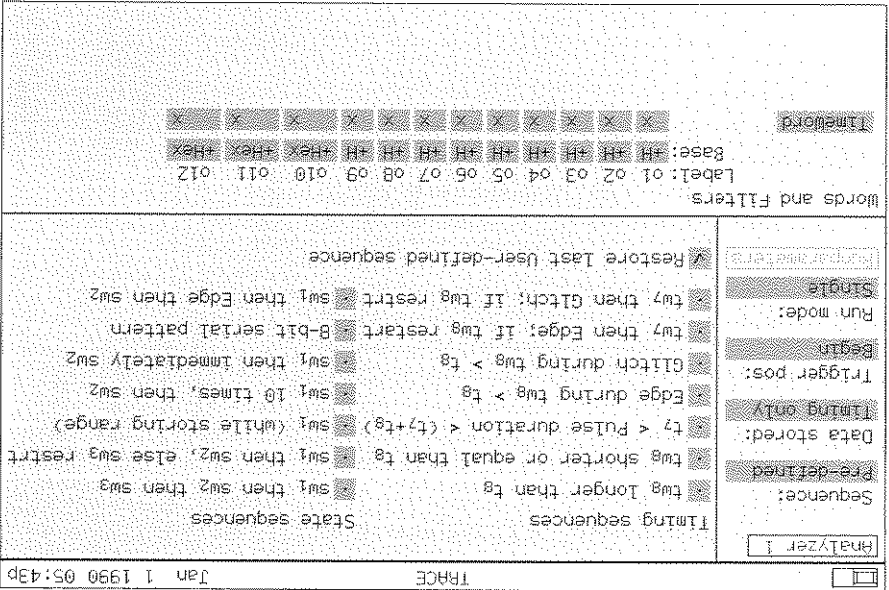

The trigger words area is where you define the patterns that the sequencer is to match on. This is fully explained in Chapter 5, "Trace Control".

Both timing and state displays allow you to see either the newly-acquired data or the reference data, or a comparison display. You copy data to the reference memory using the Display Special functions menu, as described below.

New and Reference Data

On PM 3580 instruments there are two memories: one for newly-acquired data, and one for reference data. PM 3585 instruments have twice as much: two memories for each analyzer.

Scrolling Modes

The scrolling modes allow quick paging, medium division, or fine step-wise movement through acquisition memory. It also allows movement from one item to the next, where the items are edges, glitches, sequencer levels, compared signal differences or equalities or, on state displays, a defined pattern.

Display Cursors

For timing and state displays, the center-point of the display (the X cursor for timing, and Y cursor for state) can be scrolled with the dial in a number of different modes. Two freely-definable cursors (called R and S cursors) can also be moved independently of the center cursor, also in a number of modes.

The screenshot shows a digital oscilloscope interface. At the top, there are control fields: 'Dial: Y', 'Mode: Fine', 'R-S: 250ns', 'S: 0004', and 'R: 0000'. Below these is a grid of data points, likely representing a state display. The grid consists of multiple rows and columns of 0s and 1s. A horizontal line labeled 'Y cursor' is positioned near the top of the grid. A vertical line labeled 'X cursor' is positioned on the left side of the grid. The data points appear to be organized into several distinct patterns or sequences.

Y cursor

X cursor

If there is only one trigger point in memory (*newly* acquired timing *and* state data for *both* Analyzer 1 and 2), then that is taken as T_0 . If there is more than one such trigger point, then that trigger point with the earliest time is the time origin.

In either of these cases, samples occurring *before* T_0 will then have a negative time value associated with them.

If there is no trigger point in memory (the trigger has been lost) then the oldest sample in memory is taken to be T_0 .

For more details, refer to Chapter 6, "Analyzing the Data": "Time Origin - T_0 ".

ings are saved together in one file having a name you specify. Settings and data cannot be saved separately. If a measurement is loaded, all data and instrument settings contained in the file specified, are loaded. Settings and data cannot be loaded separately.

2. To copy complete disks you can use the "copy disk" utility on the utility disk delivered with your instrument. For details refer to Chapter 12, "Utilities".
3. Because the file format is MS-DOS compatible, you can also use your PC to copy, rename or delete files, or to format new disks if your PC is equipped with an appropriate floppy disk drive. (See Chapter 9, "User Hardware Specifications" for more details.)

State Clocks

Chapter 4

- Sampling of State Data 4-2
 - Example 4-2
- Specifying State Clocks 4-2
 - Clock Qualification 4-3
 - Example 4-5
 - Specifying Clock Qualifiers 4-5
 - Multiple Clocks 4-6
 - Example 4-6
 - Maximum Number of Clocks and Qualifiers 4-8
 - Label Attributes 4-9
 - Valid for Clock 4-9
 - Timing Label 4-11
 - Default Values 4-11
- Clock Attributes 4-12
 - Display on Same Line as 4-12
 - Qualifier(s) 4-13
 - Timing Label 4-14
 - Default Values 4-14
- Multiplexed Buses 4-14
 - Example 4-15

Clock Qualification

Label definition

State Clock definition

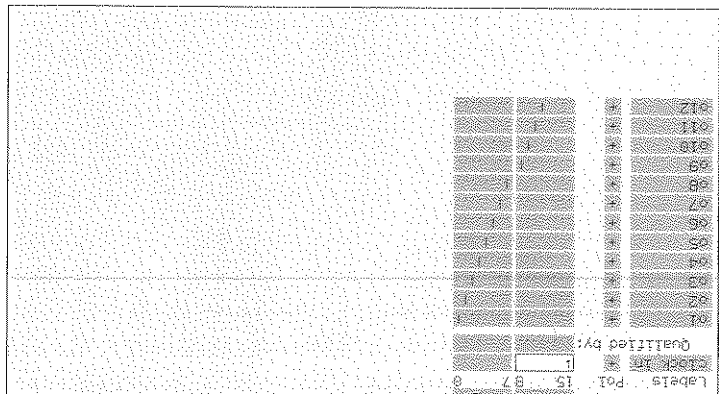

Clock-qualifiers allow you to selectively enable clock pulses on the wanted sample instants to avoid irrelevant data in the Logic Analyzer memory and on the screen.

Figure (a) on the next page shows a timing diagram indicating the Analyzer sample instants derived from the external clock shown on the upper line in this figure. The same data is sampled more than once by the analyzer. It is assumed that the falling edge of the clock was selected for data sampling.

Figure (b) shows the Analyzer sample instants derived from the same external clock. This clock is now qualified by a separate signal. In this diagram, the clock is enabled if the qualifier signal is high. The same data is now only sampled once by the analyzer.

A 12-stage binary counter is controlled by two signals: a clock signal (clock-in) and an active high count enable signal (enable). The clock is running continuously, however, the outputs of the counter will only change if the count enable signal is active (high).

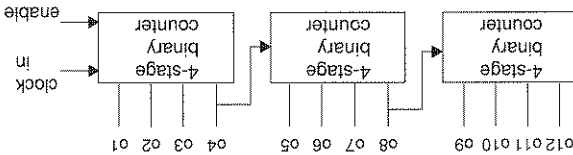

If the clock signal is used by the analyzer without further qualification, a large number of equivalent samples may result, depending on the activity of the count enable signal. Qualification of the clock signal by means of the count enable signal will result in a clock for the analyzer which is only active if the count enable signal is active (high). This prevents the analyzer from sampling the same counter value repeatedly.

The state clock expression for the Logic Analyzer should thus be:

State Clock = clock in & enable

Specifying Clock Qualifiers

The specification of clock qualifiers is also done on the Format menu in the State clock definition area. For our example this is shown on the next page.

The UDSN and LDSN signal are only meaningful (i.e. indicate a bus transfer to or from the microprocessor) if the microprocessor has control over the busses. This is indicated by the status of the Bus Grant Acknowledge signal (BGACKN) of the microprocessor. In order to capture only meaningful states of the processor's busses the UDSN and LDSN signals should therefore be qualified by the BGACKN signal of the microprocessor.

The state clock expression for the Logic Analyzer should thus be:

$$\text{State Clock} = \text{UDSN} \downarrow \cdot \text{BGACKN} \uparrow + \text{LDSN} \downarrow \cdot \text{BGACKN} \uparrow$$

This expression can be defined on the Format menu in the State clock definition area as shown below.

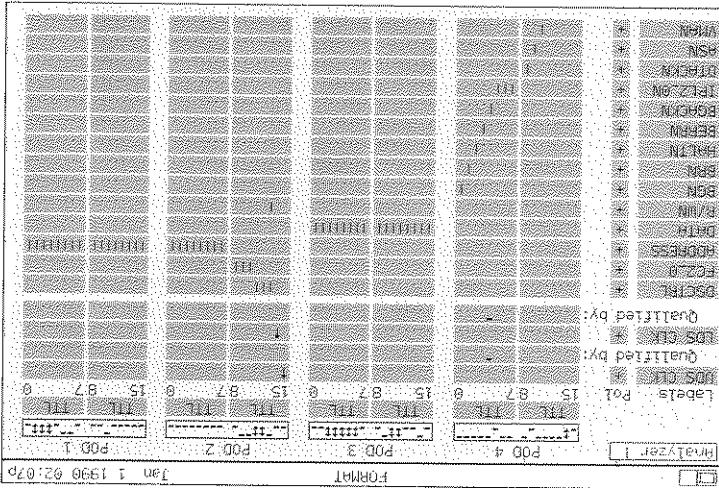

When an external clock occurs, the Logic Analyzer takes a sample of all the signals of all the pods assigned to that analyzer.

If more than one external clock is defined it may, however, be that only some signals are valid for one clock while other signals are valid for another clock. For example, sometimes it is needed for a microprocessor to use one clock at which only the address lines are valid and another clock for which only the data lines are valid. In order to get a proper display of the data captured the analyzer should only display the values sampled for those signals which were actually valid for the clock which caused the sample to be captured. For that it is necessary to tell the analyzer which signals are actually valid for which clock.

This can be done by means of *label attributes* which can be defined in the label attributes menu. This menu is accessed by pressing *SELECT* on the label field in the Format menu. The menu for the label is then popped up. By pressing *SELECT* on the *Attribute* field in this menu, the attributes menu is popped up (compare, Chapter 3, "Menu Overview"; "Clock and Label Attributes").

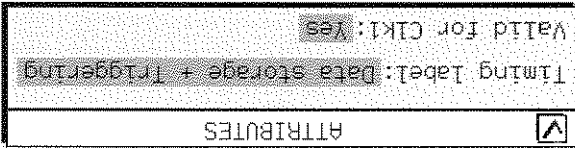

Valid for Clock

In the *Valid for CLK1* field it can be specified whether a label is valid or invalid for that specific clock.

On displaying the state data the analyzer will show the samples in the order they were captured, with one sample

"Trace Control": "State Pattern Recognizers".

Timing Label

The other attribute found on the label attributes menu is *Timing label*. The purpose of this attribute is extensively described in Chapter 3, "Menu Overview": "Clock and Label Attributes".

Default Values

When you insert a new label, the attributes for this label are set to their default values, i.e.:

Timing label : Data Storage + Triggering
Valid for Ck1 : Yes (for all clocks)

Specifically note that if a new clock (e.g. Ckx) is inserted, the *Valid for Ckx* attribute for all labels already defined is set to "Yes".

The timing diagram for a read cycle is shown below:

Consider the 8085 microprocessor from Intel. This processor has a multiplexed address/data bus where the least significant address lines are multiplexed with the data bus.

The timing diagram for a write cycle and interrupt acknowledge cycle are equivalent.

The multiplexed address/data lines ($AD_0 - AD_7$) contain a stable address on the falling edge of the ALE signal. This signal should therefore be used to clock the address signals.

The address/data lines contain stable data on the rising edge of the RDN, WRN or INTAN signals as appropriate for the data transfer cycle. These signals should therefore be used to clock the data signals into the analyzer.

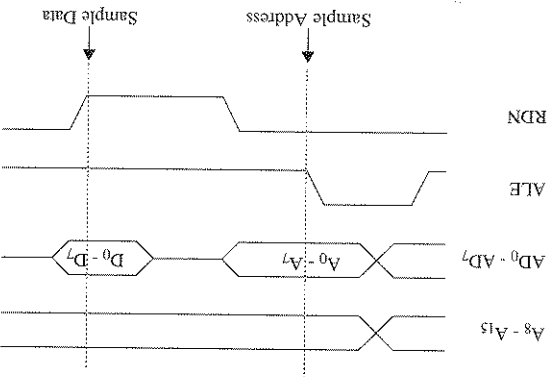

The timing diagram for a read cycle is shown below:

Consider the 8085 microprocessor from Intel. This processor has a multiplexed address/data bus where the least significant address lines are multiplexed with the data bus.

The four clock signals (ALE, RDN, WRN and INTAN) are only meaningful (i.e. indicate a bus transfer to or from the microprocessor) if the microprocessor has control over the buses. This is indicated by the status of the Hold Acknowledge signal (HLDA) of the microprocessor. In order to capture only meaningful states of the processor's bus-
 es, the four clock signals should therefore be qualified by the HLDA signal of the microprocessor.

The following table summarizes the attributes for all the labels of the 8085 as set by the setup files provided with the RDN, WRN, INTAN = "No".

For these last two labels it should be specified that they are not valid for any of the state clocks; i.e., Valid for ALE, RDN, WRN, INTAN = "No".

The Timing label attribute for the labels "AD7_0" and "A15_8" should be set to "Yes", i.e., "Data storage + Triggering".

The Timing label attribute for the labels "ADDRESS" and "DATA" should thus be set to "No".

The timing display would thus be very confusing. It is therefore necessary to explicitly tell the analyzer that the labels "ADDRESS" and "DATA" are to be used for state analysis only. Two other labels "AD7_0" and "A15_8" should be specified, and used for timing analysis only.

- "DATA" would not properly reflect this.
- For the label "DATA", half of the address and all data would be shown. Although this is correct, the label name for the label "DATA", half of the address and all data address/data bus changes from data to floating.
1. "ADDRESS" changes because the multiplexed address/data bus changes from address to floating.
 2. "ADDRESS" changes because the multiplexed address/data bus changes from floating to data.
 3. "ADDRESS" changes because the multiplexed address/data bus changes from data to floating.

Where, for each of the indicated time instants, signal changes occur in the label "ADDRESS" for the following reasons:

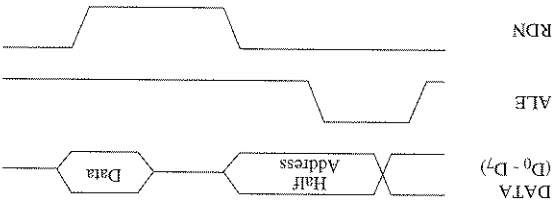

Trace Control

- Trace Control Features 5-3
- Kind of Data Stored 5-4
- Triggering 5-5
- Trigger Point Position 5-5
- Pattern Recognition 5-7
- Timing Pattern Recognizers 5-7
- Timing Words 5-7
- Timing Pattern Duration 5-7
- Glitch Detector 5-8
- Edge Detector 5-9
- State Pattern Recognizers 5-10
- State Words 5-10
- Not State Words 5-11
- Immediate State Words 5-11
- Range Detector 5-12
- Not in Range Detector 5-15
- State Clocks 5-15
- Combinations of Pattern Recognizers 5-16
- Specifying Patterns for Recognition 5-17
- Recognizer Fields 5-17
- Value Entry 5-20
- Overlapping Labels 5-21
- Ranges 5-21
- Sequencer Facilities 5-22
- Level Structure 5-23
- Creating a Level 5-24
- Time-Out Value 5-25
- Restart Sequence 5-26
- Examples 5-26
- Program Flow 5-26
- Interrupt Response Time 5-28
- Check Minimum Pulse Width 5-29
- Check Maximum Pulse Width 5-29
- Check Pulse Duration 5-30
- Check Pattern Sequence 5-31
- Wait for a Pattern Sequence 5-31
- One Immediate Sequence of Two Patterns 5-32
- Two Immediate Sequences of Two Patterns 5-33

Triggering of the logic analyzer is based on the recognition of a sequence of one or more specific data patterns in the data captured by the analyzer. Your logic analyzer has built-in a number of pattern recognizers (trigger words) for recognition of state and timing patterns (see "Pattern Recognition" beginning on page 5-7). Patterns can be specified in the Trigger words area of the Trace menu. Thanks to the Dual Analysis Per Pin architecture, the analyzer can search for state and timing patterns in parallel. Both state and timing patterns can be specified within one single sequence (see "Sequencer Facilities" beginning on page 5-22).

Trigger Point Position

Considering the data stored during a run, two periods can be distinguished: that before the trigger point, and that after the trigger point. The diagram below shows this graphically.

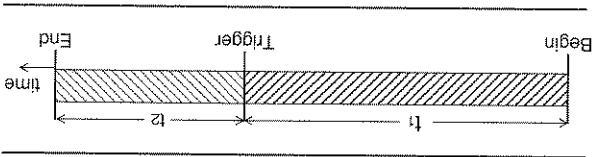

You define by the sequence what the conditions must be for the trigger to occur, and by the Trigger Position, the relationship between t_1 and t_2 . During the pre-trigger period t_1 , data is stored and a sequence of data patterns is searched for. If the sequence is not found before the memory fills, old data is pushed from memory, and new data inserted so the newest data is always available. When the sequence is found, the hardware is triggered.

Pre-trigger Period

For timing pattern recognition, the following recognizers are available:

- One timing word.
- Two filter words.
- One glitch detector.
- One edge detector.

For state pattern recognition, the available recognizers are:

- Eight state words.
- One range detector.

Each of these recognizers is described below.

Timing Pattern Recognizers

Timing Words

Each timing word is the AND combination of bit (0,1 or x) patterns in each label.

Three timing words are available per analyzer:

TimeWord: If specified, all timing samples captured are compared against the **TimeWord**.

tw7,tw8: If specified, all timing samples captured at 20 ns intervals are compared against **tw7** or **tw8** or both.

Note: **tw7** and **tw8** may alternately be used as state words **sw7** and **sw8** respectively.

Timing Pattern Duration

For timing words **tw7** and **tw8**, a pattern duration (filter) can be specified, allowing recognition of patterns which are present for more than or less than a specified time period. The time period can be specified in a range from 20 ns to 1.31 ms in steps of 20 ns.

nels for which glitch triggering is specified. If glitch triggering is not specified, but the *Data Stored* field indicates that glitch data should be stored, then glitch data is stored for all channels.

You can specify a rising edge (↑), a falling edge (↓) or either edge (↑) per channel. When an edge is specified on more than one channel, the analyzer logically ORs them together. That is, an edge pattern is found when an edge occurs on at least one of the channels you specified.

The analyzer may be programmed to look for an isolated edge, or for one during a pattern which has been present for at least a specified time. In the latter case, this is defined as:

Edge during ($tw_f > t_f$) (1 = 7 or 8)

This condition is true if any edge specified occurs after time interval t_f , but before or at the moment when tw_f becomes false. That is, if any edge specified occurs within the time interval t_e shown below:

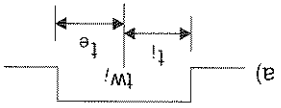

Note that glitch and edge patterns may be specified together in combination with a pattern duration, that is:

(Glitch or Edge) during ($tw_f < t_f$).

Note: The PM 3580/30 and PM 3580/60 instruments store data sampled at 100 MHz. However, edge detection in these units operates at 200 MHz. Consequently, if a pulse occurs which is smaller than the minimum detectable pulse for these units, triggering on the edge of such a pulse may occur, even if that pulse data is not stored.

Not state words are the same as state words, except that they are true if the sample captured *does not* match the state word specified.

Immediate State Words

State words may be combined into immediate word pairs labeled sw_{12} , sw_{34} , sw_{56} , sw_{78} . An immediate word pair sw_{xy} reveals a true condition if the state words sw_x and sw_y are recognized in two consecutive state samples, with sw_x being the first recognized.

Applications

Applications which require the use of immediate state words are given in the examples "One Immediate Sequence of Two Patterns" on page 5-32 and "Two Immediate Sequences of Two Patterns" on page 5-33.

Multiplexed Buses

Immediate state words are also useful in analyzing multiplexed buses. As an example, consider a multiplexed address/data bus where the address is valid for clk_1 , and the data is valid for clk_2 . Recognition of an address/data combination in this case requires two state words, one to recognize the address, and the other to recognize the data. If sw_1 and sw_2 are programmed to be valid for clk_1 and clk_2 respectively, the immediate word pair sw_{12} may be used to recognize an address/data combination on the multiplexed address/data bus.

Note that for this particular example, the use of an immediate word pair is practical, but not absolutely necessary. The detection of the address/data combination could also be done by using two levels of the sequencer. The first level then looks for the occurrence of sw_1 , the next level for the occurrence of sw_2 and if sw_2 does not occur, jumps back to the first level to look for sw_1 again.

If a range is specified for L32 where range high and low for the channels of pods 2 and 1 differ, then the values for range high and low must be equal for the channels of pods 5 and 3. Alternatively, set pod 1 as don't care and the range can then be specified over pods 2 and 3. (Lose accuracy to extend range.) The values for range high and low must then be equal for the channels of pod 5. Similarly, if all channels of both pods 2 and 1 are set to don't care, a range may be specified for both pods 5 and 3.

When two or more labels share a pod, then, at any one time, only one of those labels can have a range specified for it. The label for which the range is specified is freely selectable.

The example below shows which range expressions can be defined for two different labels which share a pod:

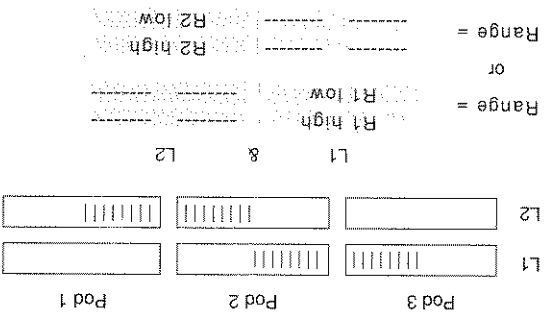

Multiple Labels

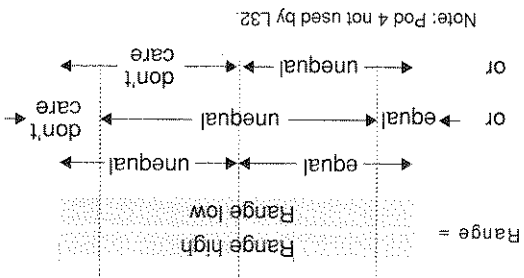

ency is detected, you are notified via a popup menu, and you can select how the software resolves the inconsistency. You have a choice of:

- undoing the last value entered,
- updating this label only (RangelH = RangelL),
- updating all other labels as necessary.

Note that the second option is shown only if such an action can resolve the inconsistency.

Not in Range Detector

The "Not in range detector" is the inverted output of the range detector. So for example:

$$\text{Range} = \text{not} \{ (\text{Address in address range}) \cdot (\text{Data in data range}) \\ = (\text{Address in address range}) + (\text{Data in data range}) \}$$

Not in range identifies label data which is numerically neither between nor on two specified patterns RangelH and RangelL.

Note that not in range is only evaluated for the state samples captured with the state clock specified for the range in the Trace menu's Trigger Words area.

State Clocks

State Clocks may also be used as patterns themselves for both triggering as well as storage qualification. When state clocks are referred to, the edge definition and clock qualification as specified in the Format menu is used.

The screenshot shows a software interface with a trace menu and a data table. The trace menu includes options like 'Store my state', 'If Timeword', and 'Trigger ENC'. The data table has columns for 'Timeword', 'Label', and 'Valid for'.

Timeword	Label	Valid for
Label 1	Label	Yes*
Label 2	Label	Yes*
Label 3	Label	No
Label 4	Label	Yes*
Label 5	Label	Yes*

* Either "Data storage + Triggering" or "Triggering only".

Timing Valid for

State Pattern Recognizers:

A pattern field is present for a label if the label is valid for the state clock for which the state recognizer is valid.

In the Trace menu shown below an example is given of a possible appearance of the Trigger Words area. In this example the labels have the following attributes:

Triggering" or "Triggering only".

The sequencer can have a maximum of eight levels. Each of these levels can independently have its own structure, ranging from simple to complex.

The simplest level construct is:

L₁ If times, goto

While the most complex is:

① Store

After

If times, goto trigger

Or if times, goto trigger

In the level construct, five different columns are distinguished as indicated above. These are:

1 Level number:

Shows which level is concerned, acts as a label to branch to, and allows you to select level options.

2 Condition:

Store: Specifies what state data should be stored. The storage condition may be any combination of state pattern recognizers.

After: Specifies whether the sequencer must be suspended until either the other analyzer (on PM 3585) or BNC has provided a signal.

The **trigger** field is simply attached to the *If* or *Or/If* lines by selecting the trigger option on the Level options popup menu for the level. This popup is accessed by pressing **SELECT** while on the *level* field.

Deselecting the trigger option for this level on the popup menu removes the *trigger* field from the level construct.

The **After** line is simply added to the level structure by selecting the After option on the level options popup menu for the level. This popup is accessed by pressing **SELECT** while on the *level* field.

Deselecting the After option for this level on the popup menu removes the *After* line from the level construct.

The **Store** line cannot be added separately per level. Instead, this line is automatically present in the structure of a level if you set the global store condition to "Per Level". This global store condition is displayed on a separate line above the sequence when you instruct the analyzer to store state data by setting the *Data Stored* field in the Trace menu to either "State only" or "Timing + State".

Note: If you do selective data acquisition, the trigger word which causes the triggering of the state section (either via *stop* or *trigger state*) is only stored in the memory if this trigger word is also specified in the store condition.

The Time-out option in the *If* and *Or/If* fields allows a branch to be performed after a certain amount of delay.

When you select time-out, the times expression changes to the field shown at left. The time-out value field is real numeric, 40 ns through the maximum time-out value, in steps of 20 ns with a default of 40 ns. If the occurrence of the Time-out condition leads to a sequencer stop (i.e., *Goto*

Time-Out Value

Trigger

After

Store

of 1 ns

Note that calling Procedure B from within procedure A is conditional, so may be skipped, as indicated by the curved arrow. The same applies to the calling of procedure Test from within procedure B.

Using these state words, the sequence to detect this program flow and trigger on it is:

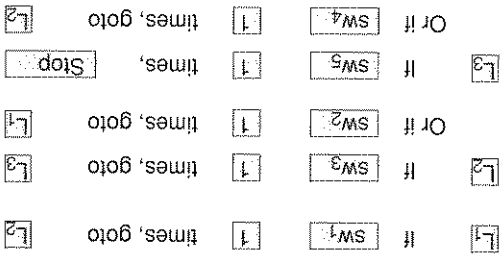

In level 1, the sequencer waits until procedure A (sw₁) has been called, and then goes to level 2.

In level 2, the sequencer waits until either procedure B has been called (sw₃) or procedure A is ended (sw₂). If procedure A has been left, the sequencer returns to level 1, again waiting until procedure A is called. If procedure B has been called, the sequencer progresses to level 3.

At the third level the sequencer waits until either procedure Test has been called (sw₅) or procedure B has been ended (sw₄). If procedure B has been left, the sequencer returns to level 2.

If procedure Test has been called, the sequencer stops and triggers the acquisition hardware. Using the trigger position facilities (*Trig Pos* field in the Run Definition area), you can opt to store a specific amount of samples after the trigger before acquisition is completely stopped. (See "Trigger Point Position" beginning on page 5-5.)

In this example the analyzer is used to check if the pulse width of a signal is always large enough.

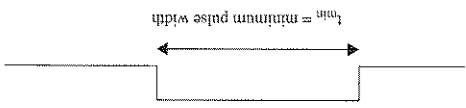

The sequence is:

```
L1 [1] If  $tW \leq t_{min}$  1 times, Stop
```

Where t_z is defined such that $t_z = t_{min}$. If the pulse width is less than, or equal to t_{min} , the analyzer will trigger.

Check Maximum Pulse Width

This example checks if the pulse width of a signal is not too long.

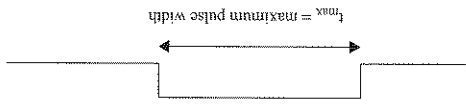

The sequence is:

```
L1 [1] If  $tW > t_z$  1 times, Stop
```

Where t_z is defined such that $t_z = t_{max}$. The analyzer now triggers if the pulse width is greater than t_{max} .

The sequence below can be used to check if three patterns always occurs in the proper order. If the sequence is interrupted (sequence break) the analyzer triggers. Words sw_1 , sw_2 and sw_3 are programmed to respectively match the first, second and third pattern of the pattern sequence to be verified.

The sequence is:

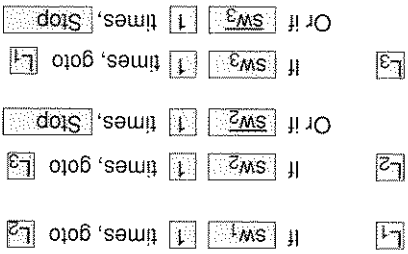

After the first pattern has been detected, it is checked whether the next two samples match the second and third patterns. If this is not the case, the sequencer stops and acquisition hardware is triggered. Otherwise the sequencer goes to level 1 and starts the search for the first pattern again.

Wait for a Pattern Sequence

In this example, a sequence is defined such that the analyzer will wait until three patterns occur in a specific order. The pattern sequence is always preceded by a pattern not occurring in the sequence. Words sw_1 , sw_2 and sw_3 are programmed to respectively match the first, second and third pattern of the pattern sequence to be verified.

In this example we will use the analyzer to detect the occurrence of an immediate sequence of patterns p_1 and p_2 , or an immediate sequence of patterns p_3 and p_4 in a long sequence of patterns sampled. All patterns are valid for the same state clock.

Proper detection requires the analyzer to keep track of the patterns according to the following state diagram:

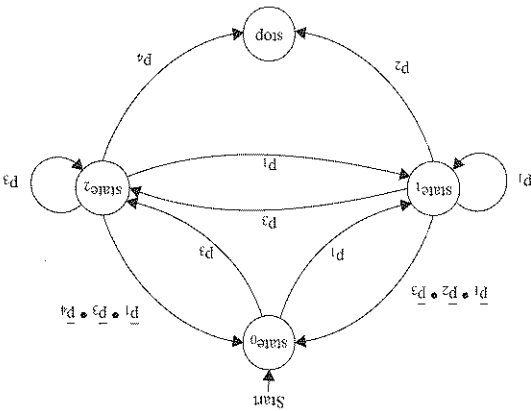

Words sw_1 - sw_4 are programmed to respectively match p_1 - p_4 . Use of immediate state word pairs sw_{12} and sw_{34} as in the sequence below, allows the analyzer to trigger as required.

The sequence is:

[L1] If $SW_{12} + SW_{34}$ 1 times, Stop

The State sequences are as follows. Except for the third sequence (store range) all state data is stored:

sw₁ then sw₂ then sw₃

Triggers on a sequence of three state words, one occurring after the other.

sw₁ then sw₂, else sw₃ restart

Triggers on the sequence of two state words (sw₁ and sw₂), provided that sw₃ does not occur before sw₂.

sw₁ (while storing Range)

Triggers on one state word and limits the data stored.

sw₁ 10 times then sw₂

Triggers on one state word after another state word has been detected 10 times.

sw₁ then immediately sw₂

Triggers if state words sw₁ and sw₂ are recognized in two consecutive samples, with sw₁ being the first recognized. Compare examples "One immediate Sequence of Two Patterns" on page 5-32 and "Two Immediate Sequences of Two Patterns" on page 5-33.

8-bit serial pattern

Triggers when 8 state words follow each other in a specified order without a break. Compare the example "Check Pattern Sequence" beginning on page 5-31.

sw₁ then Edge then sw₂

Triggers on one state word followed by a change of state of one or more signals followed by another state word.

Explanations of the exact meaning of the terms in these sequences are to be found in the sections concerning pattern recognition beginning on page 5-7. They are also defined in the "Timing Sequences" and the "State Sequences" in the *PM 3580/PM 3585 Reference Guide*.

You can set up your analyzer to automatically restart itself after each non-manual acquisition stop. This is called the auto-repeat mode and can be selected in the Run Definition area of the Trace menu, in the *Run Mode* field.

When auto-repeat mode has been selected, pressing the *RUN* key starts the analyzer. After the trigger condition has been detected and acquisition has stopped, the analyzer displays the data and then automatically restarts itself.

You can specify the amount of time between analyzer stop and automatic restart using the run parameters popup menu.



The value specified in the *Start acquisition every* field determines the amount of time between analyzer stop and automatic restart (5 sec. by default).

The automatic repeat can be terminated on the basis of data comparison results between newly acquired data and data stored in reference memory.

Data can be stored in reference memory by using the copy functions provided in the special functions popup menu of the display menu (see Chapter 3, "Menu Overview"; "The Special Functions Popup Menu"; and the "Display Special

Starting Repetitive Measurements

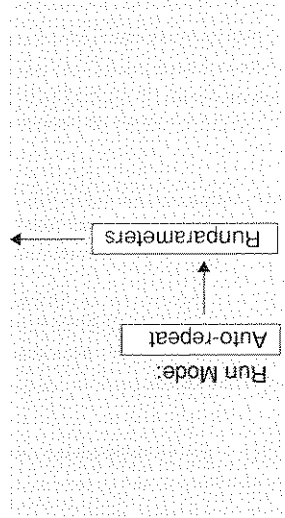

Terminating Repetitive Measurements

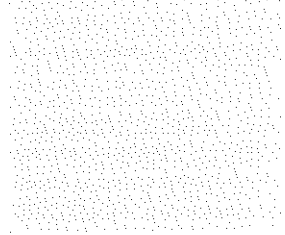

If the auto-repeat mode is selected (*Run mode* field is set to auto-repeat), a time counter is displayed on the menu bar immediately adjacent to the analyzer activity icons. If the auto-repeat mode is inactive, such as when the *RUN* key has not yet been pressed, or the auto-repeat is stopped, this time counter is displayed in *light gray*. If the auto-repeat mode is active, the counter is displayed in *black and is counting down*. On reaching zero, an acquisition run is automatically started.

Chapter 6 Analyzing the Data

- Display Concepts 6-2
 - Data Source 6-4
 - Data Type and Form 6-6
 - Reference Data 6-7
 - Data Comparison 6-7
 - Measurement Data Overview 6-8
 - Time Origin - T_0 6-9
 - Time or Sample Numbers 6-10
 - Sample Number 0 6-10
 - Dial Operation 6-11
 - Viewing Parts of the Measurement Data 6-12
 - Display Locators 6-14
 - Measurements (R and S cursors) 6-15
 - Selecting Labels for Display 6-16
 - Display of Sequencer Levels 6-17
 - Waveform Displays 6-18
 - Dial Movement (Dial Mode) 6-19
 - X-scale (T/div and S/div) 6-21
 - Y-scale 6-23
 - Bus Data 6-23
 - Waveform Data Representation 6-26
 - Label Values 6-26
 - Accumulate Mode 6-27
 - List Displays 6-28
 - Dial Movement (Dial Mode) 6-29
 - List Data Representation 6-30
 - The Find Function 6-30
 - "Time" Label 6-31
 - "Level" Label 6-32
 - Label Base 6-32
 - Disassembly 6-33
 - Split Screen 6-34
 - Creating a Split Screen 6-34
 - Deleting a Window 6-35
 - Active Window 6-35
 - Moving Between Windows 6-35
 - Coscroll 6-36

You can select to display the data from any one of these sources using the three fields at the left-hand side of the display definition area.

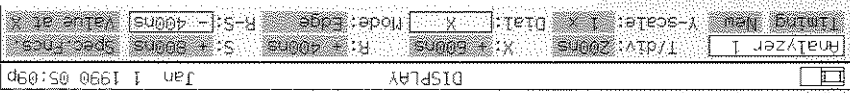

Three fields to select the data source

- Analyzer Name This field selects between data from Analyzer 1 or Analyzer 2. On PM 3580 instruments data for Analyzer 2 can only be selected if a measurement file has been loaded which was generated on a PM 3585 instrument.
- Data Type and Form (Timing/State) This field selects between the display of timing data or state data and also the form of the display: waveform or list. (See below).
- Data Source This field selects between the display of newly acquired data, (New), reference data (Ref) or the results of the comparison between New and Reference data (Comp). The data shown on the menu the first time it is displayed, depends on whether data has already been acquired, and, if not, the setting of the *Data Stored* field on the Trace menu. Data is shown, for preference, from Analyzer 1, and state data is shown rather than timing.

In addition to memory for storage of newly acquired data your analyzer contains a separate memory in which reference data can be stored. Newly acquired data can be compared with this reference data.

You can copy data to the reference memory by using the *Copy New to Reference* function field on the Display Special Functions popup menu. You can also use the *Exchange New and Reference* field.

If you saved a measurement to disk (using the Save command on the I/O menu) while reference data was defined, this reference data is also saved. If you load the measurement file (using the Load command on the I/O menu) the reference data will also be loaded.

Note: To make a Reference file for subsequent use you will save disk space and will be able to load faster if there is no New data. This will be the case if after acquiring a measurement you use "Exchange New and Reference" instead of "Copy New to Reference".

Copying Data to the Reference memory

Measurement File

Data Comparison

Comparisons can be made between new and reference data on the Display menu by selecting "Comp" in the *Data Source* field of the display definition area.

In the *Waveform display*, the data shown is the result of the comparison of New and Reference data using the exclusive-OR function. Differences between New and Reference data are displayed as high (1) and equalities as low (0).

In the *List display* New data is shown with the differences from the Reference data highlighted.

Data comparison can also be executed during *repetitive measurements*. The positions of the R and S cursors then determine which part of the measurement data is compared for autostop. (See Chapter 5, "Trace Control"; "Repetitive Measurements").

Waveform Display

List Display

Repetitive Measurements

During an acquisition, two analyzers may be active (only one for PM 3580 instruments) and for each analyzer, two independent sections (timing and state). By default, all sections are triggered simultaneously at T_0 . However, each of the analyzers and each of its sections can be triggered at different instants. Consequently, four different (two for PM 3580 instruments) triggering instants may exist within a single measurement:

- Trigger for Analyzer 1, Timing.
- Trigger for Analyzer 1, State.
- Trigger for Analyzer 2, Timing (PM 3585 only).
- Trigger for Analyzer 2, State (PM 3585 only).

An example is shown in the figure below:

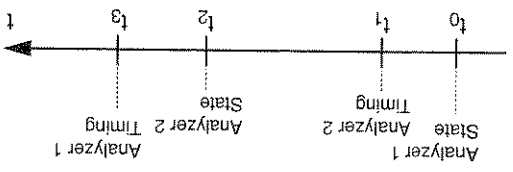

To properly correlate the data captured by the different sections one trigger instant is selected for references. This trigger instant is mapped to 0 and labelled T_0 .

This time instant is selected as follows:

- If there is only one trigger point in memory, then that point is taken as T_0 .
- If there is more than one trigger point in memory, then the trigger point with the earliest time is the time origin (in the example above this is the instant where the state section of Analyzer 1 was triggered).
- If there is no trigger point in memory (the trigger has been lost) then the oldest sample in memory is taken to be T_0 .

In the Display menu, the dial is used to scroll through the measurement data and to set reference cursors (R and S). The dial can be operated in different modes. The dial mode, selected in the *Dial Mode* field, determines how much the element on which the dial currently operates (measurement data, R or S cursor) moves per click of the dial. For example each click may represent a movement of one or more pixels (step) or one line only or a whole page. For a complete overview see "Waveform Displays" beginning on page 6-18 and "List Displays" beginning on page 6-27.

For example:

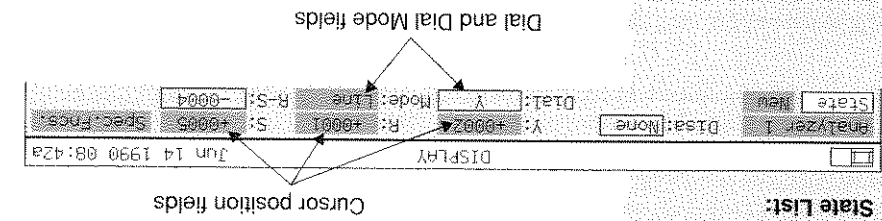
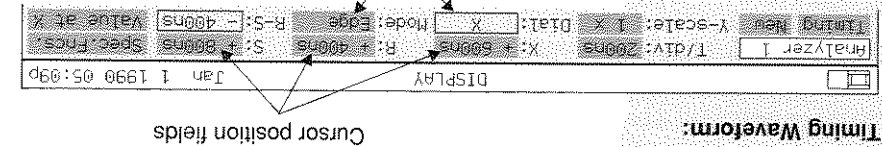

Dial Locking

On cursor position fields (X, Y, R, S), auto dial locking takes place. That is, if the dial is moved when any of these fields is highlighted, the dial is locked to that field. When any other field is highlighted and the dial is turned, the dial affects the cursor that was last locked.

Depending on whether you were editing a sample or a time value proceed as follows.

If you were editing a *sample number*, press **SELECT**. This closes the popup. The screen is refreshed so that the sample value selected for X or Y is in the center of the display area.

If you were editing a *time value* and you want to change the units also, proceed as follows.

Use the right arrow key to move to the units field, then, either press the appropriate key or press **SELECT** to toggle through the options.

Units	
n	nanoseconds
u	microseconds
m	milliseconds
s	seconds
k	kiloseconds

The units you may select for a cursor position are:

Finally close the popup by pressing **HOME** then **SELECT**, or **HOME** again. The screen is refreshed so that the time position selected for X or Y is in the center of the display area.

You can also move the X or Y position to a predefined position quickly by pressing an appropriate alphabetic key, as shown in the box below.

Quick Movement Characters	
B	Beginning of data
C	Center of data
E	End of data
R	R position
S	S position
T	Trigger position
X	X position
Y	Y position

**Measurements
(R and S cursors)**

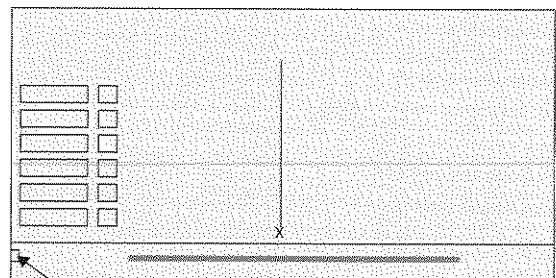

You can set the R and S cursors to measure differences between timing events (e.g., the difference between edges on two different signals) or state events. The difference can be shown in time or sample numbers.

The position of these cursors is indicated in the display definition area. The value in these fields may be time or sample number (see "Time or Sample Numbers" on page 6-10). The difference between the R and S cursor positions can be read immediately from the R-S field.

Timing:

Analyzer 1 T/DIV: 200ns X: + 600ns R: + 400ns S: + 800ns Spec. Funcs. Value at %

Timing New Y-scale: 1 X Dial: X Mode: Edge R-S: - 400ns

DISPLAY Jan 1 1990 05:03p

R and S position fields

R-S difference field

State:

Analyzer 1 Dsta: None Y: + 000Z R: + 6001 S: + 0005 Spec. Funcs.

State New Dial: Y Mode: Line R-S: - 0004

DISPLAY Jun 14 1990 08:42a

R and S position fields

R-S difference field

The R and S cursors are also used to select the part of data that should be compared during repetitive measurements (see Chapter 5, "Trace Control"; "Repetitive Measurements").

In all displays you can see at which level the sequencer was when a particular data sample was captured. In waveform displays this is shown at the top of the values area in the *Level* field (information field). This list displays a special label called "Level" is available. This label can be added as described in subsection "Selecting Labels for Display" on page 6-16.

Note: An "S" (Stop level) is shown as value for the level for those samples which were captured after the trigger.

To add a label, highlight the label after which you want the new label to be inserted, and press the *INSERT* key. A menu of all the available labels (as you defined them in the Format menu) appears. Highlight the label you want, and press either *SELECT* or *INSERT*. The label is now added to the display.

Use delete then add to move a label to a different position. Note: You may add the same label more than once.

To replace one label by another, highlight the label you want to change, and press *SELECT*. A menu of all the available labels (as you defined them in the Format menu) appears. Highlight the label you want to appear in place of the current label, and press *SELECT*. The label is now replaced by the one selected.

You can also change a label using the first character select method: highlight the label to be changed and press the first letter of the label to replace it. If there is more than one label starting with the same letter, keep pressing the letter until the required label is shown.

Hint: To insert a label before the first label, insert (add) the first label (so it appears twice), then change the first label to the one you want.

In all displays you can see at which level the sequencer was when a particular data sample was captured. In waveform displays this is shown at the top of the values area in the *Level* field (information field). This list displays a special label called "Level" is available. This label can be added as described in subsection "Selecting Labels for Display" on page 6-16.

Note: An "S" (Stop level) is shown as value for the level for those samples which were captured after the trigger.

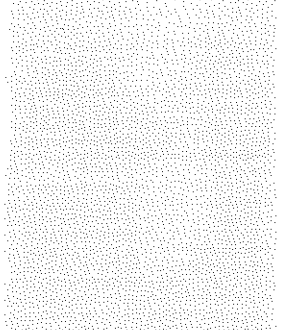

Display of Sequencer Levels

Adding Labels

Changing Labels

Quick Label Selection

If the Dial Field shows X, then turning the dial causes the waveforms to move. The amount moved depends on what is set in the Mode field and whether the highlight is on a label (at the left of the screen) or in the display definition area (at the top of the screen). The mode field also applies when moving the R and S cursors. For X, the cursor remains in the center of the display and the *waveforms* move in the direction the dial is turned. For R and S cursors, the *cursors* move in the direction the dial is turned.

The available mode settings are:

Step This mode is only for changing the X scaling (*T/div* or *S/div*). It is only available when the X scaling field is highlighted and does not appear on the mode popup. The Time or Sample number per division moves to the next or previous scale division per "click" (see "X-scale" (*T/div* and *S/div*)" beginning on page 6-20).

Scroll The default for waveform displays. This mode allows very fine adjustment of the cursor. The waveforms or cursor move one or more pixels per "click".

Edge Moves the waveforms or cursor such that the appropriate cursor is on the next edge (transition). If a label field is highlighted, then the dial moves the cursor from edge to edge of that label only. If any other field is highlighted, the dial moves the cursor to the edge of any label which is displayed.

Division Moves the waveforms or cursor by one scale division (these are the marks below the display locator and at the bottom of the data display area). You can change the scale of these divisions: see "X-scale (*T/div* and *S/div*)" beginning on page 6-20.

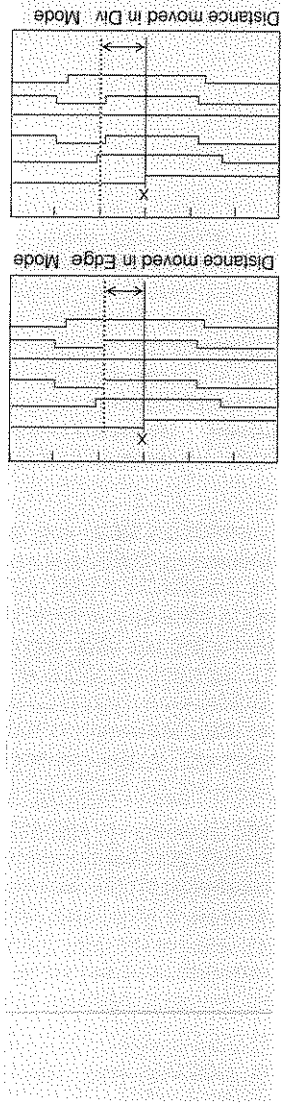

Depending on the horizontal (X) scale set, a larger or smaller part of the total measurement is displayed. When first displaying newly acquired data, the Logic Analyzer sets the scale so that at least 10% of the total measurement is displayed.

The horizontal dimension (X) of the data display is divided into six divisions as shown on the line below the display locator and at the bottom of the display. You select the

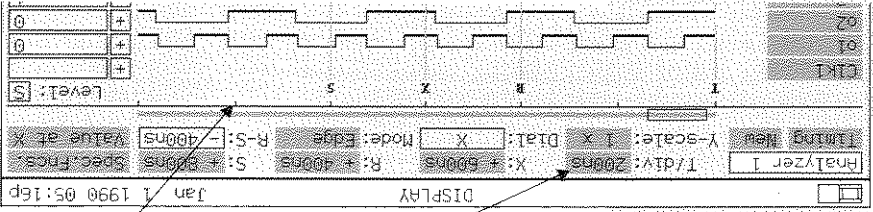

scale by specifying the number of units per division in the X-scale (*T/div* or *S/div*) field in the display definition area. Changing the X scale allows you to zoom in or out on the data around the X position.

The X-scale field shows *T/div* if the X, R and S fields show time values, or *S/div*, if they show sample numbers. You set the display to use time or sample numbers in the Special Functions menu (see "Time or Sample Numbers" on page 6-10) or you can use the pop-up menu which appears when you press *SELECT* on the X-scale field.

Note that "Sample" for timing data refers only to those samples in which a transition (high/low or low/high) has occurred on one or more analyzer channels which have been enabled for timing analysis in the *FORMAT* menu.

If more than one channel is connected to a label, by default, all signals of that label are shown together on the waveform display. The resulting waveform is the OR of each of the separate signals of the label. The figure above shows the effect. (Label "output").

The values field at the far right of the screen shows the hexadecimal value of the label at a specified cursor position (here it is "00d" under the X cursor). See "Label Values" on page 6-26 for more information.

Instead of showing the whole bus, you can show just one signal. To do this, highlight the bus field, and either press *SELECT* to toggle through the signals of the bus, or use the numeric keys to enter the number of the channel you want to display. The *B* key selects all channels (Bus). The

Individual bus signals

Bus Data

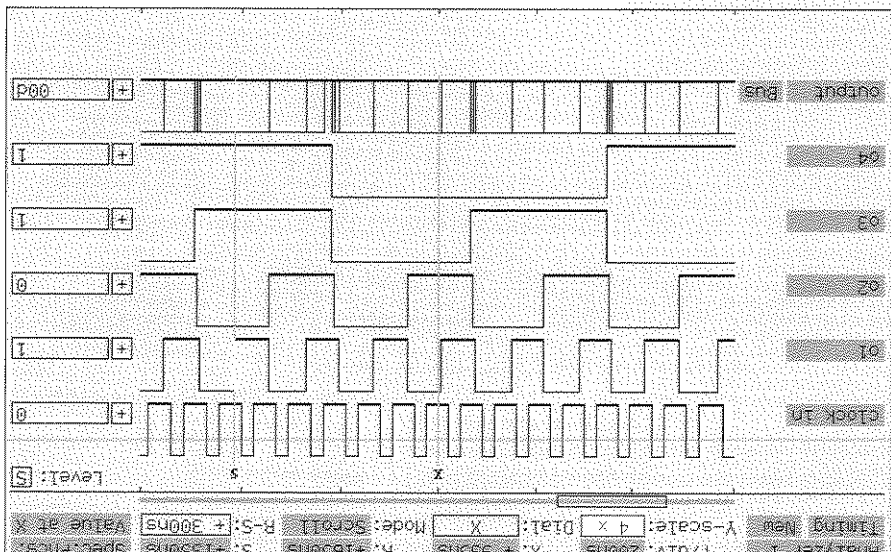

You can also type in a value (or select Value from the pop-up, then type in the value).

Values of the bus that have the same value as the border value are shown on the border line. Those values which lie outside the border values are shown just outside the borders.

The following screen shows another application of the bus graph mode. This screen shows the execution of a program loop, an interrupt and the operation of the interrupt. The R (=T) and S cursors show the interrupt service delay time.

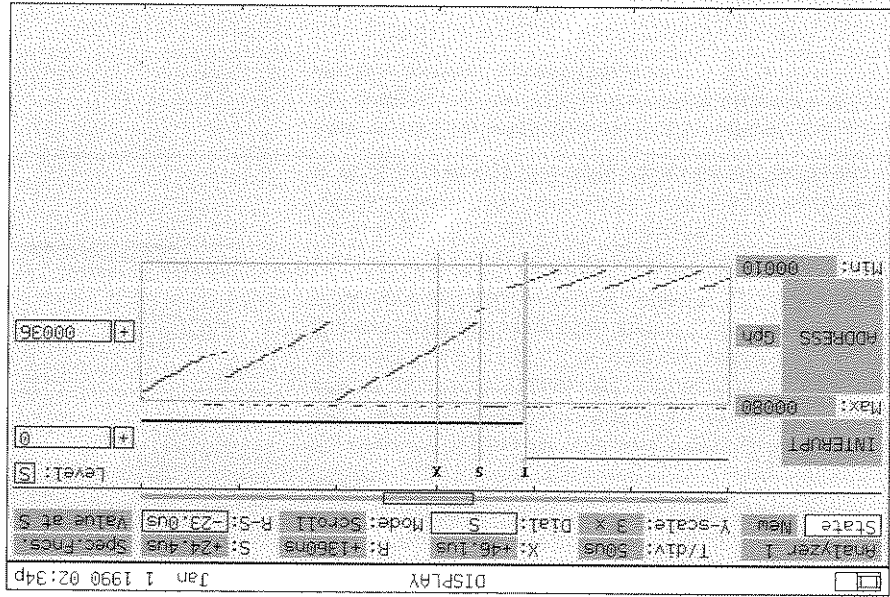

The graph mode can for example also be used to check the proper functioning of an analog-to-digital converter (ADC). Displaying the output signals of the ADC in graph mode will show the analog waveform that was converted by the ADC on the analyzer display.

You can enable waveform "accumulate mode" in the *Display Special Functions* menu (see page 6-8). If you set "Accumulate: On" then the waveforms displayed on the screen are not refreshed each time a new data set is acquired. The new data then overlays all the previously acquired data since accumulate mode was enabled.

You can typically use this to examine the stability of a set of timing signals. An unstable baudrate on a serial communication link can cause parity errors. Incoming bits (RS232-Rx) are sometimes missed by the internal receiver clock. The instability rate can be traced over a period of time (R-S cursors). See example screen below.

Note that this is purely a bit-map function. The previously acquired data is not stored. So although you can at all times scroll the data on the screen, the data scrolling onto the screen will only be from the current acquisition, and will not be accumulated. If the picture is zoomed, the accumulated information is removed.

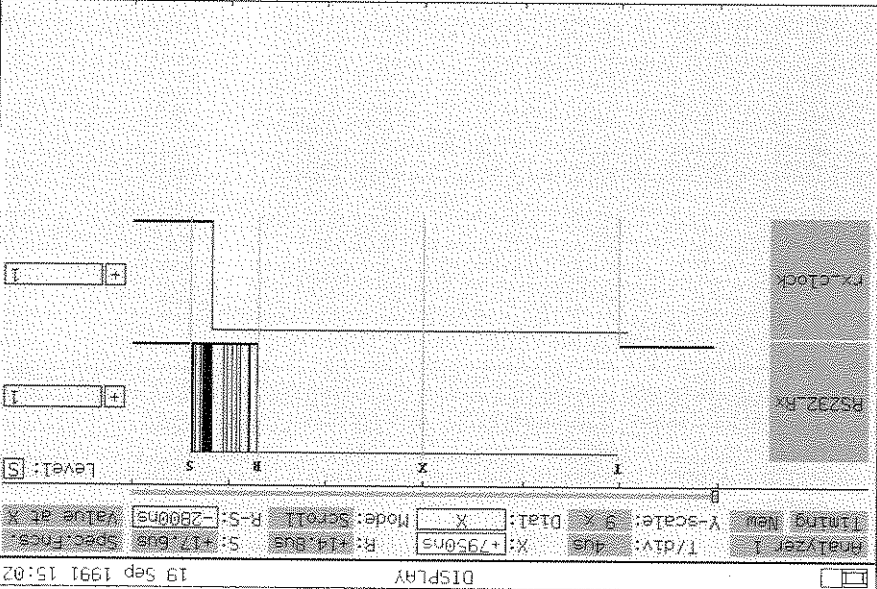

If the Dial Field shows Y, then turning the dial causes the list items to move. The amount moved depends on what is set in the Mode field and whether the highlight is on a label field (at the top of the list) or in the display definition area (at the top of the screen). The mode field also applies when moving the R and S cursors. For Y, the cursor remains in the center of the display and the *list items* move opposite to the direction the dial is turned. For R and S cursors, the *cursors* move in the direction the dial is turned. The available mode settings are:

- Line** Moves one line per "click". Clockwise is down, anti-clockwise is up.
- Page** Moves one display page (the length of the data display) per "click".
- Level** Moves the cursor to the next (previous) sequence level transition. Not when Data Source field is *Compare*.
- Find** Moves the cursor to the next (or previous) occurrence of the selected word (see "The Find Function" on page 6-29).
- Different** Only when Data Source field is *Compare*. Moves the cursor from one difference between new and reference data to the next in the direction the dial is turned. If a label field is highlighted, then the dial moves the cursor from difference to difference in that label only. If any other field is highlighted, the dial moves the cursor to the next difference in any label displayed.
- Equal** Only when Data Source field is *Compare*. Moves the cursor from one equality of new and reference data to the next in the direction the dial is turned. If a label field is highlighted, then the dial moves the cursor from equality to equality in that label only. If any other field is highlighted, the dial moves the cursor to the next equality in any label displayed.

Label: output time	clock in	01	02	03	04	05	06	07	08	09	010	011	012
Base: +Hex	-Hex	-Hex	-Hex	-Hex	-Hex	-Hex	-Hex	-Hex	-Hex	-Hex	-Hex	-Hex	-Hex
Find: 00x	X	X	X	X	X	X	X	X	X	X	X	X	X
-0005 f8a	-	370ns	✓	0	1	0	1	1	1	1	1	1	1
-0004 fbh	-	295ns	✓	1	1	0	1	1	1	1	1	1	1
-0003 ffc	-	225ns	✓	0	0	1	1	1	1	1	1	1	1
-0002 ffd	-	150ns	✓	1	0	1	1	1	1	1	1	1	1
-0001 ffe	-	75ns	✓	0	1	1	1	1	1	1	1	1	1
T+0000 fff	+	0ns	✓	1	1	1	1	1	1	1	1	1	1
R+0001 f80	+	70ns	✓	0	0	0	0	0	0	1	1	1	1
Y+0002 001	+	145ns	✓	1	0	0	0	0	0	0	0	0	0
+0003 002	+	220ns	✓	0	1	0	0	0	0	0	0	0	0
+0004 003	+	295ns	✓	1	1	0	0	0	0	0	0	0	0
S+0005 004	+	365ns	✓	0	0	1	0	0	0	0	0	0	0
+0006 005	+	440ns	✓	1	0	1	0	0	0	0	0	0	0
+0007 906	+	515ns	✓	0	1	1	0	0	0	0	0	0	0
+0008 007	+	585ns	✓	1	1	1	0	0	0	0	0	0	0
+0009 008	+	660ns	✓	0	0	0	1	0	0	0	0	0	0
+0010 009	+	730ns	✓	1	0	0	1	0	0	0	0	0	0

A special label, called "Time", is available in list displays. In this column, the time instant at which the sample was captured is shown. This time instant may be shown relative to the next sample (Base: Rel) or absolute with respect to T₀ (Base: Abs).

Notes:

1. If the samples displayed on a line originate from different clocks (due to the specification of "display on same line as" in the "Label attributes" menu) then the time value shown is that of the "first clock". That is, of the clock specified in the *display on same line as* field. (Compare Chapter 4, "State Clocks"; "Display on Same Line as").
2. The "Time" label can be operated on as a normal data label. Thus it can be deleted, added, changed, etc. as described in "Selecting Labels for Display" beginning on page 6-16).

If a disassembler is loaded, the *Disa* field in the display definition area of the state list can be toggled to switch disassembly "On" or "Off". Furthermore, a *Disassembler parameters* field is added to the display definition area of the state list display. Using this field, a popup menu can be selected on which different disassembler parameters can be set. The parameters control which state samples are shown, and the disassembly process.

See "Disassembler Parameters Menu" in the *PM 3580/PM 3585 Reference Guide* for more detailed information on disassembler parameters. See Chapter 7, "Disassemblers" for general information on disassemblers, and the appropriate microprocessor support documentation (supplied separately as an appendix of this manual) for specific information.

If disassembly is "On", a special label, "Processor instructions", is added to the state list display. The results of the disassembly are shown in this column.

Note that, if no disassembler is loaded, the *Disa* field shows "None" and is not selectable.

Disassembly is only available on state list displays. The *Disa* field does not appear in the header area of any other display.

New data will be shown either from the other analyzer or of a different type (state or timing) than that already shown. The next time a split screen is created the data type and form that was most recently "hidden" will again be displayed.

Deleting a Window

To delete a window of a split screen, go to the analyzer name field shown in that window and press the *DELETE* key. The complete screen is now again available for the remaining window.

Active Window

Only one window can be active at the same time (i.e., the dial operates only on that window, unless Coscrolling is on). The currently active window is that window in which one of the selectable fields is highlighted.

As with all fields, you can use first letter select to position the cursors in the data. If you type, respectively, R or S on the R or S cursor fields the cursor value from the other window is set. Similarly in the special case when you have two of the same window type (waveform or list) typing X (or Y) on the X (or Y) cursor select field sets the corresponding value from the other window.

Moving Between Windows

You can move between the two windows by pressing the *DISPLAY* key.

You can also move between the two windows by using the up and down arrow keys as appropriate.

two acquired occurrences of a routine (separated in time) are to be correlated. You might be examining these two occurrences to see if the program flow was the same. Alternatively, you could compare ("New") data captured at a different speed with ("Ref") data captured at a different speed. For example if you want to test your circuit using a faster version of the microprocessor.

Although coscrolling on samples will typically be used with two state windows, it can also be used to compare timing patterns. For example, to see if an RS-232 serial bit stream contains the same information at 38.4 kbaud as at 19.2 kbaud.

Chapter 7 Disassemblers

Disassembly 7-2
Disassembler Packages 7-2
Microprocessor Adapters 7-2
Loading a Disassembler 7-3
Disassembler Setup 7-3
Instruction Representation 7-5
Instruction Mnemonics 7-5
Operand Field 7-5
Disassembler Parameters 7-6
Display Options 7-7
Translation Options 7-9
Activating/Deactivating the Disassembler 7-10

Loading a Disassembler

Disassembler Setup

Loading a disassembler into your logic analyzer is simple and straightforward.

Put the floppy disk with the appropriate disassembler in the floppy disk drive. (Disassembler files have names with the extension ".DIS".) Go to the Configuration menu and press **SELECT** on the field called "Option". A list appears on the screen showing all the disassemblers available on the floppy disk. Highlight the disassembler you want to be loaded and press **SELECT**.

The disassembler software and the associated setup are then loaded.

After the disassembler has been loaded, it automatically configures the Logic Analyzer as required. That is, "pods" are assigned if necessary, all label and clock assignments (including attributes) are made in the Format menu, and the Display menu is updated. As an example the Format menu as set up by the 68000 disassembler is shown on the next page.

As the disassembler is being loaded, it is checked whether sufficient resources (e.g., pods, labels and clocks) are free. Furthermore, if you already had assigned clocks, labels or both to channels in the Format menu, you are asked whether these assignments should be deleted or left intact. If the number of the resulting tree resources is sufficient, the disassembler is loaded. If not, you are notified, and the disassembler is not loaded, except as noted below.

The disassembler does not require the pods assigned to the analyzer to be adjacent.

Instruction mnemonics are displayed in capitals according to the specification of the processor's manufacturer. The mnemonics are shown with a suffix indicating the operand size. For these suffixes the following notation is used:

“B”	:	Byte
“W”	:	Word
“D” or “L”	:	Double-Word or Long-Word

Note: For 8-bit microprocessors these suffixes are not necessary, so are not shown.

Operand Field

In the operand field of an instruction, the operands are displayed in the same order as specified by the manufacturer. The operand values are shown according to the following rules:

Signed operand parts: shown as decimal numbers with sign.

Unsigned operand parts: shown as hexadecimal numbers.

Immediate operands: are preceded by the “#” symbol.

Absolute long pointer addresses: are preceded by the “@” symbol.

Target addresses for both conditional and unconditional program transfers (jumps, branches etc.) are calculated whenever possible. Addresses calculated by the disassembler are then shown as hexadecimal numbers enclosed in braces (“{” and “}”), and concatenated to the operand field.

Target Addresses

Operand Values

Instruction Mnemonics

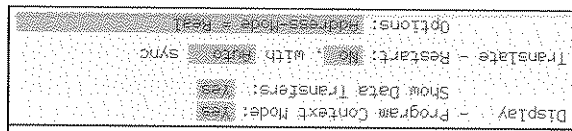

The *Options* field is only present on this popup menu for those disassemblers which have additional options. This field is described, when appropriate, in the microprocessor support package documentation (appendices to this manual).

The fields on the Disassembler Parameters menu are grouped in two sections:

- Display** This controls which state samples are shown.
- Translate** This controls the disassembly process.

The display options fields together determine which disassembled instructions are displayed.

The *Program Context Mode* field determines if the instructions are shown in raw mode or analyzed by the disassembler and displayed in context. If program context mode is chosen, the disassembler filters out irrelevant instructions and arranges instructions in the order they were executed.

Irrelevant instructions are those near program transfers (e.g., jumps or branches) or program exceptions, fetched but not executed, and those related to state samples captured with external clocks not defined by the disassembler. The two Display menus on the next page show the output of the Disassembler with the *Program Context Mode* respectively on ("Yes") and off ("No").

Program Context Mode

Display Options

croprocessor has a pipeline architecture, in Program Context Mode these samples are shown immediately following the instructions that caused them. The upper figure on the next page illustrates this also. Specifically look at the order of the sample numbers and the location of the data transfer samples shown (mr and mw).

The fields relating to translation are *Restart* and *Synchronization*.

Restart determines whether a new translation (disassembly) should be performed on the current measurement as soon as the disassembler parameters menu is closed.

The *Synchronization* field, and the other fields that may subsequently appear on that line, determine how the disassembler searches for proper instruction starting points.

For automatic synchronization, the disassembler starts at the earliest point in memory, and keeps correcting itself until a properly synchronized disassembly is achieved.

For a manually synchronized disassembly, the disassembler starts at the instruction you set the Y cursor to.

You can define where on the bus the disassembler takes the starting point for disassembly using the *At Y* fields. This, however, only applies to microprocessors whose instructions can start at an address that is not a multiple of the data bus width. Each of the *Xs* in the *At Y* fields represents a nibble (4 bits). The number of *Xs* shown in each field depends on the minimum size the microprocessor uses to fetch opcodes. You toggle the field which is to be the starting point to show *Xs*. The other fields remain, or become, blank.

Translation Options

Restart

Synchronization

Automatic Synchronization

Manual Synchronization

Chapter 8 Probing

- The Pod System 8-2
- Front Ends 8-2
- Probe Impedance 8-3
- Pod Cable 8-3
- Standard Front End 8-4
- Microprocessor Adapters 8-6
- RC Connectors 8-7
- Adapter Types 8-7
- Disassembler and Setting Files 8-8
- RC Connectors 8-9

The probe impedance of the pod system depends on the type of front end used. Typical values for the probe impedance are:

Standard front end: 200 k Ω /7 pF

Microprocessor adapters: 200 k Ω /15 pF

RC connectors: 200 k Ω /7 pF

(excluding traces on PCB.)

Pod Cable

The pod cable is a specially-designed cable. It carries sixteen signals in parallel plus two power lines (+5V, -5V) at each side of the cable (see chapter 9, "User Hardware Specification": "Pod Cable Connector"). The cable is fully symmetrical.

The connector housing has a location in which the pod number stickers supplied with your instrument fit.

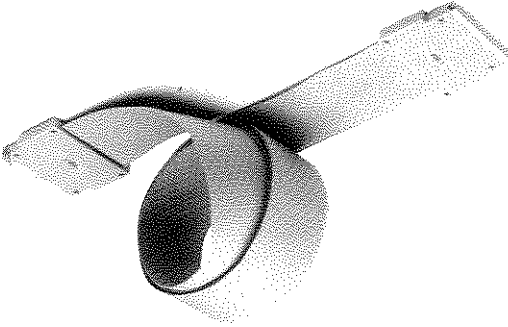

The best orientation for these stickers is with the bottom of the text closest to the cable (see photograph).

Keying Mechanism

Connecting Leads to Signals

The signal leads will not fit in the ground lead positions on the plug due to the built-in keying mechanism. The same keying mechanism prevents you from connecting leads to the +5V, -5V power lines on the cable.

The leads can be connected to the signals you want to measure by means of the gray grabbers or red mini-clips supplied with your instrument.

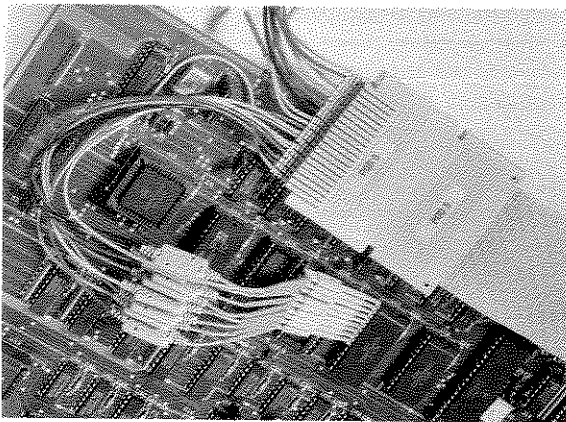

You can also directly connect a lead to a wire wrap pin on your board or to the pins of a measuring clip.

The adapters contain special RC connectors to which the pod cables can be directly connected. The RC connectors contain the same RC compensation networks as the signal leads of the standard front end.

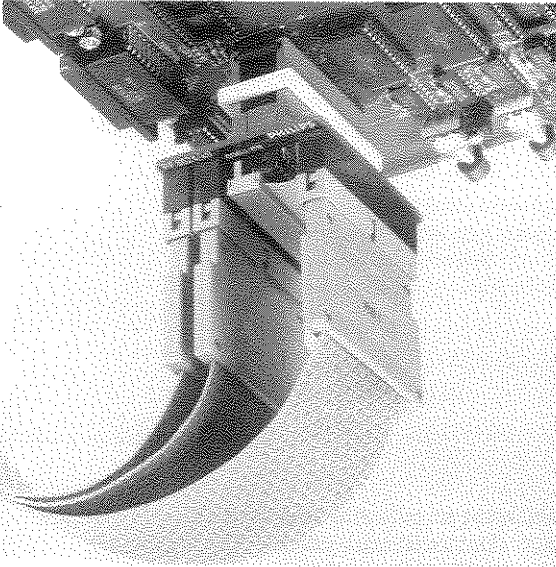

Microprocessor adapters are available for DIP, PLCC, and PGA packages.

For the *DIP* packages, either a clip version (clip onto the chip), a socket version (insert between the microprocessor chip and its socket) or both are available. For the socket version extension sockets are separately available.

PGA and *PLCC* versions are socket type. For these adapters, extension sockets are separately available.

The microprocessor adapters, whenever possible, have been designed such that both microprocessor state and

Adapter Types

DIP

PGA and PLCC

Passive Adapters

You can also incorporate the RC connectors as used on the microprocessor adapters in your own designs. You then mount the RC connectors directly on your boards.

The connectors, of course, require some board space. However, it is the most convenient way to probe your signals, since this solution creates the minimum adaptation height and the most firm connection. The Logic Target, as described in the *Getting Started Guide* is one example of this type of probing.

The RC connectors can be separately purchased from your local Fluke/Phillips sales representative, and come in sets of ten connectors (order number: PF 8603/20). These connectors are the same as the RC connectors used in the microprocessor adapters.

Chapter 9

User Hardware Specifications

Floppy Disk Drive 9-2
Centronics Connector 9-3
IEEE-488 Connector 9-4
RS232 Connector 9-5
Video Connector 9-6
Pod Cable Connector 9-7

Timing Centronics
Parallel Interface

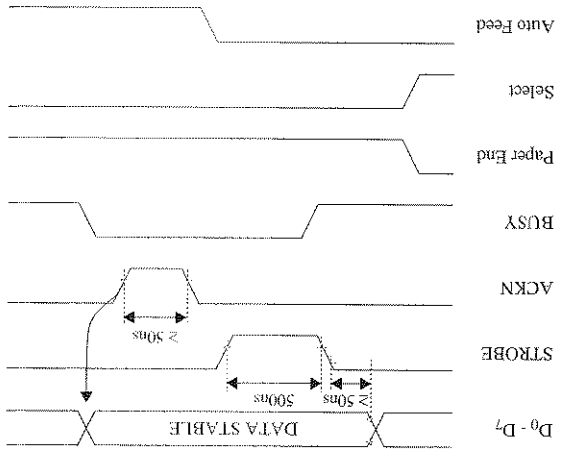

Pin	Signal	Pin	Signal
1	STROBE	10	ACKN
2	D0	11	BUSY
3	D1	12	Paper End
4	D2	13	Select
5	D3	14	Auto Feed
6	D4	15	not connected
7	D5	16	not connected
8	D6	17-25	GND
9	D7		

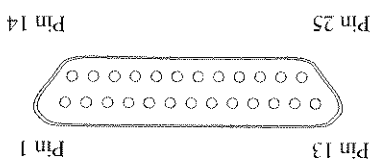

RS232-C compatible

Pin	Signal	Pin	Signal
1	GND	5	CTS
2	TX	6	not connected
3	RX	7	GND
4	RTS	8-25	not connected

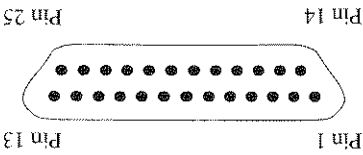

Chapter 10 File Formats

Hardcopy File 10-2
Header 10-2
Screen Image 10-2

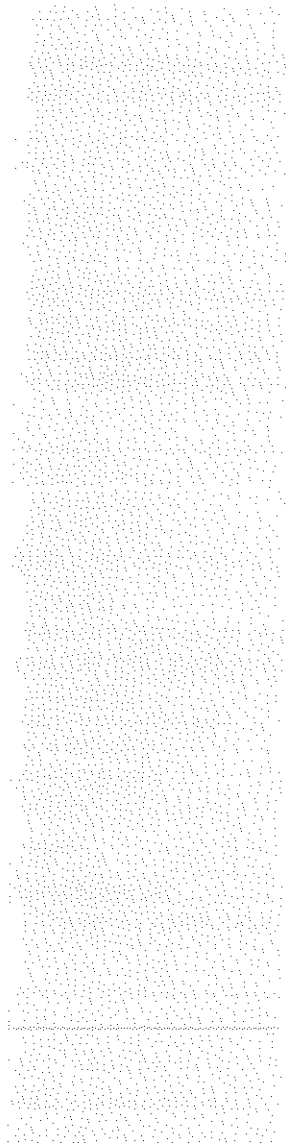

LOGIC ANALYZERS PM 3580 / PM 3585

Read the procedures for

Initial Inspection

Operator Safety

Installation

found on top of this documentation package **first**.

Then insert the description of these procedures as Chapter 11 after the "Safety and Installation" tab in the *PM 3580/PM 3585 User Manual*. You may then discard this page.

Chapter 11

Safety and Installation

- Initial Inspection 11-2
- Operator Safety 11-3
- Safety Precautions 11-3
- Caution and Warning Statements 11-3
- Symbols 11-4
- Impaired Safety Protection 11-4
- Safety Notice 11-4
- Installation 11-6
- Working Position 11-6
- Earthing 11-6
- Setting the Line Voltage 11-7
- Switching on the Logic Analyzer 11-9
- Setting the Date and Time 11-10
- Fiuke/Phillips Addresses 11-11
- U.S.A. 11-24

The following subsections contain information, warnings and cautions which must be followed to ensure safe operation and to retain the instrument in a safe condition. Read these carefully before installation and use of the instrument.

Adjustment, maintenance and repair of the instrument shall only be carried out by qualified personnel.

Safety Precautions

For the correct and safe use of this instrument it is essential that both operating and service personnel follow generally accepted safety procedures in addition to the safety precautions specified in this manual.

Specific warning and caution statements, where they apply, will be found throughout the manuals.

Where necessary, the warning and caution statements and/or symbols are marked on the apparatus.

Caution and Warning Statements

WARNING
Calls attention to a potential danger that requires correct procedures or practices in order to prevent personal injury.

CAUTION
Is used to indicate the correct operating and maintenance procedures in order to prevent damage to, or destruction of, the equipment or other property.

Note that the capacitors inside the instrument can hold their charge even if the instrument has been disconnected from all voltage sources.

Any adjustment, replacement, maintenance or repair of the powered-up, opened instrument shall be avoided as far as possible, and, if inevitable, shall be carried out only by a skilled person who is aware of the hazard involved.

WARNING

For any adjustment, maintenance, replacement or repair the procedures and additional safety instructions contained in the *PM 3580/PM 3585 Service Manual* must be adhered to.

Before plugging in the instrument make certain that it has been set to the local voltage.

Note: If the power plug has to be adapted to the local situation, such adaptation should only be done by a qualified technician.

WARNING
The instrument shall be disconnected from all voltage sources when a fuse is to be renewed, or when the instrument is to be adapted to a different line voltage.

The two possible settings are 110 V (90 V - 135 V supplies) and 220 V (180 V - 264 V supplies).

Note
The correct fuse should be used for each of the voltage settings:
• 220 V: 2 A/250 V slow
• 110 V: 4 A/250 V slow

This setting is determined by the voltage selector unit located at the rear of the instrument: see the figure below.

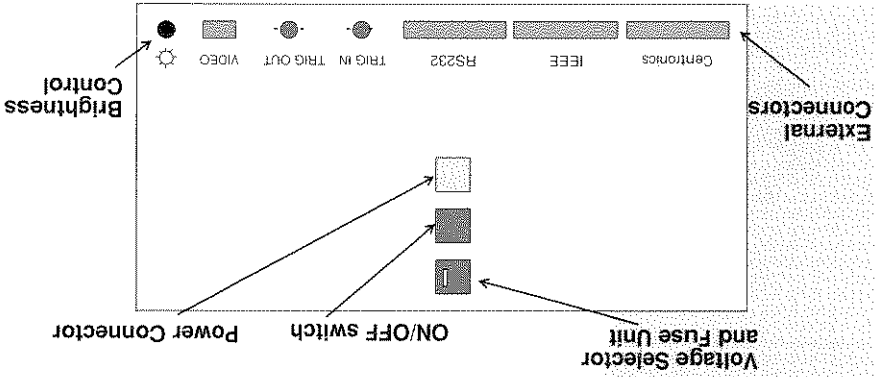

Ensure that the instrument has been set to the local line voltage.

- Ensure that the power cable is not connected to the power supply and that the power switch on the instrument is OFF.

- Plug the female end of the power cable into the instrument.
- Plug the power cable into an appropriate **earthed** power source.

- Remove the transport protector (if any) from the floppy disk drive by pushing the eject button.
- Switch on the instrument. This will cause the light on the floppy drive to illuminate and a start-up message to appear on the screen.

- Push the System disk (PF 8690) into the drive until it locks.

The system software is now loaded, including the auto-load file if present. After loading a calibration procedure is executed. This procedure ensures that the propagation delay is the same on all channels.

After successful completion of the calibration, the Configuration menu is displayed, and your system is ready for use.

Adjust the brightness of the screen, using the control located at the rear of the instrument (see the figure on page 11-7), to suit your requirements.

Note: If you press any key during the power on sequence of the analyzer, it will perform a (15 minute) self-test and display the results of the test on the screen. After the self-test has been completed and is satisfactory, you can proceed to use the instrument.

Power on Self-Test

Brightness Control

Calibration

* Service Center.

Australia/New Zealand

Phillips Scientific & Industrial PTY Ltd.
 Test & Measurement Dept.
 NZ Head Office
 2 Wagner Place
 PO Box 4021
 Auckland 3
 New Zealand
 Tel: 09-894160
 Fax: 09-862728
 TLX: NZ 2395

Australia Head Office

Phillips Scientific & Industrial PTY Ltd.
 Test & Measurement Dept.
 Centrecourt 25-27 Paul Street
 North Ryde
 Sydney New South Wales 2113
 Tel: 02-888 0416
 Tel: 02-888 8222*
 Fax: 02-888 0440
 TLX: AA 20165 phillind ausnrsi

Phillips Scientific & Industrial PTY Ltd.

Test & Measurement
 23 Lakeside Drive
 East Burwood
 Melbourne Victoria 3151
 Tel: 03-235 3666
 Fax: 03-235 3618

Phillips Scientific & Industrial PTY Ltd.

Test & Measurement
 348 Torrens Road
 Croyden
 Adelaide South Australia 5008
 Tel: 08-3482888
 Fax: 08-3482813

Algeria

Bureau de Liaison Phillips
 24 rue Bougainville
 El Mouradia, Alger
 Tel: 60 14 05
 TLX: 62221

Angola

Lusolanda Trading S.A.R.L.
 C.P. 178
 LUANDA
 Tel: 244-2-372250
 Fax: 244-2-373413

Antilles

Phillips Antilliana N.V.
 (For Phillips products)
 Kaminda Michigan 4
 PO Box 3523/3051
 Willemstad, Curacao
 Tel: 599-9-615277
 Fax: 599-9-612772
 TLX: 1047 PHINA

Argentina

Phillips Argentina S.A.
 (For Phillips products)
 Casilla Correo 3479
 Vedia 3892
 1430 Buenos Aires
 Tel: 54-1-5414106/5417141
 Fax: 54-1-7869818
 Tel: 54-1-5422411/5422451*

Coasin S.A.

(For Fluke products)
 Virrey del Pino 4071 DEP E-1
 1430 CAP FED
 Buenos Aires, Argentina
 Tel: (54) (1) 552-5248
 TLX: (390) 22284 COASN AR

Trimp's Project Development
 (S) PTY Ltd.
 Lorong 1, Toa Payoh
 Singapore 1231
 PO Box 340 Tao Payoh C.P.O.
 Tel: 65-3502000
 TLX: philips rs/21375

Rank O'Connor's, Snd Bhd
 (For Fluke products)
 No. 8 Block D,
 Sutr Shopouse Complex
 Mile 1 Jalan Tuitong
 Bandar Seri Begawan
 Negara Brunel Darussalam
 Tel: (673) (2) 23109 or 23557
 TLX: (799) BU 2265 RANKOC

Bolivia
E.P.T.A. INGENIERA S.R.L.
 C.P. 20942
 Calle Camoos No. 284
 LA PAZ
 Tel: 3-25952
 TLX: 2518 EPTABV

Bulgaria
Interconsult
 (Philips Service)
 Bul. Jane Sandanski, blok 65
 P.O. Box 42
 1309 SOFIA
 Tel: 359-2-200785

Canada
Fluke Electronics Canada Inc.
 400 Britannia Rd. East Unit #1
 Mississauga, Ontario
 L4Z 1X9 Canada
 Tel: (416) 890-7600
 Fax: (416) 890-6866

Fluke Electronics Canada Inc.
 1690 Woodward Drive
 Suite 216
 Ottawa, Ontario
 K2C 3R8 Canada
 Tel: (613) 723-9453
 Fax: (613) 723-9458

* Service Center.

China, People's Republic of
Phillips Hongkong Ltd.
 Site 7 ground floor, Whampoa
 Garden
 Hung Hom, Kowloon,
 Hongkong
 Tel: 7735588
 Fax: (852) 3345496
 TLX: 43752 PHILH HX

Instrimpex - Fluke Service Center
 (For Fluke products)
 Site Tower Room 2101
 22 Jiam Guo Man Wai Daije
 PO Box 9085
 Beijing
 People's Republic of China
 Tel: 86 01 512-3436

Chile
Phillips Chilena S.A.
de Product Electr.
 (For Phillips products)
 Avenida Santa Maria 0760
 Casilla 2678
 Santiago de Chile
 Tel: 56-2-770038
 Fax: 56-2-776730
 TXL: 240239

Hronsa
 (For Fluke products)
 Casilla 16228
 Santiago, Chile
 Tel: (56) (2) 232-4308
 Fax: (56) 2-2322694
 TLX: (332) 346351

Fluke Electronics Canada Inc.
 101, 1144 - 29th Ave. N.E.
 Calgary, Alberta
 T2E 7P1 Canada
 Tel: (403) 291-5215
 Fax: (403) 291-5219

Fluke Electronics Canada Inc.
 H9P 2V4, Canada
 Tel: (514) 685-0022
 Fax: (514) 685-0039

20052 Monza
 Andheri (E) Bombay
 400 093, India
 Tel: (91) (22) 636-4560
 (91) (22) 634-8268
 Fax: (91) 22-822-0197
 TLX: (953) 11-79286 HIPL IN

Indonesia
P.T Daeng Brothers
 (For Phillips products)
 3-20 Tsunashima Higashi, 6
 Chome,
 Kokokuku, Yokohama 223
 Tel: (045) 452-0411
 TLX: 3823-297

Nihon Phillips Corporation*
 Shuwa Shinagawa Building
 26/38 Taharawa 3-Chrome
 Minatu-ku Tohyo 108
 Tel: 4485511

P.T. Lamda Triguna
 (For Fuke products)
 PO Box 6/JATJG, Jakarta
 13001
 Indonesia
 Tel: (62) (21) 819-5365
 Fax: (62) 21-819-9631
 TLX: (796) 63938 KA IA

Iran
Phillips Iran Ltd.
 Private John Stock Comp.
 PO Box 11365-3891
 TEHRAN
 Tel: 98-21-674138/675158
 TLX: 212545 pphs ir

Iraq
Al-Tei Co. Ltd.
 P.O.B. 5904
 Baghdad
 Tel: 964-1-7191982
 Fax: 964-1-7191982
 TLX: 213899 SAKO IK

Ireland
Circuit Specialists Ltd.
 Unit 5, Enterprise Centre,
 Plasssey Technology Park
 Castletroy, Limerick
 Tel: 061 330333
 * Service Center

Japan
NF Circuit Design
Block Co., Ltd.
 (For Phillips products)
 3-20 Tsunashima Higashi, 6
 Chome,
 Kokokuku, Yokohama 223
 Tel: (045) 452-0411
 TLX: 3823-297

Japan
Block Co., Ltd.
 (For Phillips products)
 3-20 Tsunashima Higashi, 6
 Chome,
 Kokokuku, Yokohama 223
 Tel: (045) 452-0411
 TLX: 3823-297

Japan
John Fuke Mfg. Co., Inc.
 Japan Branch
 (For Fuke products)
 Sumitomo Higashi
 ShinbashiBldg.
 1-1-1 Hamamatsusho
 Minato-ku, Tokyo 105, Japan
 Tel: (81) (3) 434-0181
 Fax: (81) 3-434-0170
 TLX: (781) 2424331 FLUKJJPJ

Jordan
Jordan Medical Supplies & Services
 PO Box 140415
 Al Blader
 Amman Jordan
 Tel: 962-6-819929
 Fax: 962-2-823556
 TLX: 22161 jms jo

Kenya
Phillips Kenya Ltd.
 Ol Kalou Road, Industrial Area
 PO Box 30554
 Nairobi
 Tel: 254-2-557999
 Fax: 254-2-543135
 TLX: 24033 PHLP KE

2 Wagner Place
PO Box 4021
Auckland 3
Tel: 09-084-160
Fax: 09-662728
TLX: N2 2395

Nigeria

Associated Electronic Products

(Nigeria) Ltd.

KM 16, Ikorodu Road

Ojota

PO Box 1921

Lagos

Tel: 234-1-900160/69

Fax: 234-1-615601

Norway

Norsk A/S Philips

Dept. 1 & E Test & Measure-

ment

Sandsluveien 70

PO Box 1 Manglerud

0612 Oslo 6

Tel: 47-2-741010

Fax: 47-2-290942

Tel: 47-2-381457

Fax: 47-2-381457

TLX: 856-72640

Oman

Messrs. Mustafa Jawad

Trading Co.

PO Box 4918

RUWI - MUSKAT

Tel: 968-709955

Fax: 968-797277

Pakistan

Philips Electrical Co. of

Pakistan

(Private) Ltd.

(For Philips products)

Philips Markaz, M.A. Jinnah

Road

PO Box 7101

Karachi - 74400

Tel: 92-21-725772-8

Fax: 92-21-726694

TLX: 2874 PHPAK PH

TLX: 27021

Mozambique

Intelecta E.E.

P.O. Box 1159

MAPUTO

TLX: 6203 NEGONHO

Nepal

Bhaurana Engineering &

Sales (P) Ltd.

(For Philips products)

Jyoti Bhawan

PO Box 133 Kantipath

Kathmandu

Tel: 2-25134

TLX: 2264 NPLKAPH

Associated Enterprises

(For Fluke products)

GPO Box 790, Pyaphal Tole

Kathmandu, Nepal

Tel: 13868

TLX: (947) 2588 ASCENT NP

Netherlands

Philips Nederland B.V.

Test en Meetapparaten

Hooversweg 55A

Postbus 115

5000 AC Tilburg

Tel: 013-390112

Fax: 013-427528

TLX: 52683

Philips Nederland

Technische Service Prof. Akt.*

Hurksestraat 20

Gebouw HBR

5652 AJ Eindhoven

Tel: 040-723293

Fax: 040-723337

TLX: 59279 milapnl

* Service Center

* Service Center.

10 Bondstreef, Randburg
Johannesburg 2000
Tel: 27-11-889-3911
Fax: 27-11-889-3098/889 3191
TLX: 426152-sa

South African Phillips PTY Ltd*
I & E Customer Support Centre
195 Mai Road, PO Box 58088
Martindale, New Ville 2092
Tel: 27-11-470-5937
Fax: 27-11-470-5166
TLX: 426152 SA

Spain
Phillips Iberica SAE
Dep'to Instrumentacion de Medida
Poligono Industrial Zona Franca Sector C-calle F
08004 Barcelona
Tel: 34-3-3361061
Fax: 34-3-3355838
TLX: 51293/59292

Phillips Iberica*
Dep'to Instrumentacion de Medida
Martinez Villergas 2
28027 Madrid
Tel: 34-1-4042200
Fax: 34-1-4048603
TLX: 27710

Phillips Iberica SAE*
Jose Olabarria 6
48012 Bilbao
Tel: 34-4-4313800
Fax: 34-4-432 0961
TLX: 31230

Jeddah 21411
Tel: 966-2-6610006
Fax: 966-2-6610164
TLX: 601180 amdass sj

Messrs. A. Rajab & A. Sillalah
PO Box 260
Riyadh 11411
Tel: 966-1-4122425
Fax: 966-1-4122366
TLX: 404787 amdass sj

Messrs. A. Rajab & A. Sillalah
PO Box 587
Dammam
Tel: 966-3-8322596/8331870
Fax: 966-3-8271962
TLX: 601044 amdass sj

Singapore
Phillips Project Development (S) PTY Ltd.
(For Phillips products)
Lorong 1, Toa Payoh
Singapore 1231, PO Box 340
Toa Payoh Central Post Office
Singapore 9131
Tel: 65-3502000
Fax: 65-2535873
TLX: philips rs/21375

Rank O'Connor's Pie Ltd.
(For Fluke products)
O'Connor House
98 Pasir Panjang Road
Singapore 0511
Republic of Singapore
Tel: (65) 473-7944
Fax: (65) 472-4508
TLX: (766) RS 21023 OCONSIN

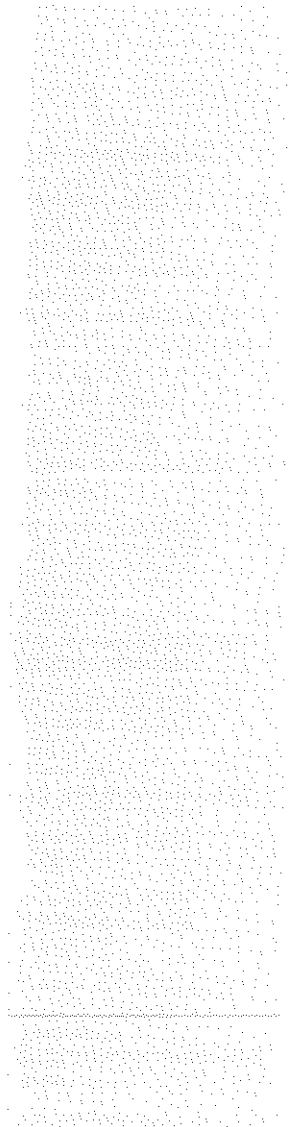

Thailand
Tel: (66) (2) 375-2733
Fax: (66) 2-374-9965
TLX: (788) 82796 HUAMARK
TH

Trinidad / West Indies
Compression & Power Service-
es (1988) Ltd.
P.O. Box 76
SAN FERNANDO By Pass
Tel: 653-5445/6/7
Fax: 1.809.657.0353
TLX: 32451 WG

Tunisia

S.T.I.E.T.
32 bis rue Ben Ghedhem
Tunis
Tel: 348666
TLX: 14512

Turkey

Türk Philips Ticaret A.S.
Talapaşa Caddesi no. 5
PO Box 161
80640 Levent-Istanbul
Tel: 90-1-1792770
Fax: 90-1-1693094
TLX: 24192 phtr tr

United Arab Emirates

Al Sanani Trading Est.
PO Box 7187
Abu Dhabi, U.A.E.
Tel: 971-2-771370
Fax: 971-2-728963
TLX: 23966 Sanani em

Haris Al-Afaq Ltd.

PO Box 8141
Dubai, U.A.E.
Tel: 971-4-283625
Fax: 971-4-281285

* Service Center.

U.S.S.R.

Avenida Uruguay 1287
Castilla de Correo 294
Montevideo, Uruguay
Tel: (598) (2) 921111
Fax: (598) (2) 920601

**N.V. Philips Gloeilampen-
fabrieken**
Miyaya Str. 1
Fl. 7, Office 18
MOSCOW
Tel: 7095-2302485
Fax: 7095-2302485
TLX: 413961 PHIL SU

Intromedia Sotrudnichestvo

Kievskaya, 2 - Office 106
121111 MOSCOW
Tel: 240 52 52
Fax: 230 28 18
TLX: 411670 DNEPR SU

Venezuela

**Inds. Venezolanas Philips
S.A.**
(For Philips products)
Apartado Aereo 1167
Caracas 1010-A
Tel: 58-2-905.7061
Fax: 58-2-951.7339
TLX: 25267 1psa vc

Cossin C.A.

(For Fike products)
Calle 9 Con Calle 4, Edifi
Edimunbi
Apartado de Correos NR-70.136
Los Rucios
Caracas 1070-A, Venezuela
Tel: (58) (2) 241-03-09
TLX: (395) 21027EMVEN VC

**Rashed Trading & Travel
Agency**

All Abdulmugni st.
PO Box 1221
Sana'a, Yemen
Tel: 967-2-273231
TLX: 2230 abgbar ye

* Service Center.

Center
 Building 8
 Billerica, MA 01821
 (508) 663-2400

Maryland
 Rockville*
 5640 Fishers Lane
 Rockville, MD 20852
 (301) 770-1570

Michigan
 Detroit
 45550 Helm Street
 Plymouth, MI 48170
 (313) 522-9140

Minnesota
 Minneapolis
 1380 Corporate Center Curve
 Suite 113
 Eagan, MN 55121
 (612) 854-5526

Missouri
 St. Louis
 11756 Borman Drive Suite 160
 St. Louis, MO 63146
 (314) 993-3805

New Jersey
 Paramus*
 PO Box 930
 Paramus, NJ 07652
 (201) 262-9550

New York
 Rochester
 4515 Culver Road
 Rochester, NY 14622
~~(716) 929-1400~~
~~716-383-1400~~

North Carolina
 Greensboro
 1310 Beaman Place
 Greensboro, NC 27408
 (919) 273-1918

Nothern*
 46610 Landing Parkway
 Fremont, CA 94538
 (415) 651-5112

Colorado
 Denver*
 14180 E. Evans Ave.
 Aurora, CO 80014
 (303) 695-1000

Connecticut
 Hartford
 Glen Lochen East
 41 C New London Turnpike
 Glastonbury, CT 06033
 (203) 659-3541

Florida
 Altamonte Springs*
 550 South Northlake Blvd.
 Altamonte Springs,
 FL 32803
 (407) 331-4881

Georgia
 Atlanta
 2700 Deik Road Suite 150
 Marietta, GA 30067
 (404) 953-4747

Illinois
 Chicago*
 1150 W. Euclid Avenue
 Palatine, IL 60067
 (708) 705-0500

Indiana
 Indianapolis
 8777 Purdue Road Suite 101
 Indianapolis, IN 46268
 (317) 875-7870

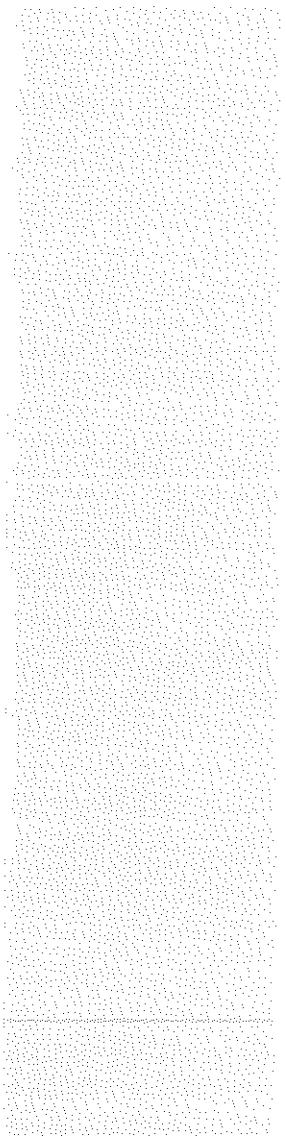

Chapter 12

Utilities

Utility Disk 12-2
Setting the Date and Time 12-3
Formatting Disks 12-4
Copying Disks 12-4

A facility is available on the Utility disk to enable you to set the date and time, and the format of presentation, on the instrument.

After the procedure has been verified the date and time are stored in the RAM of the instrument and protected by the battery backup, therefore this procedure is not required every time the instrument is powered on.

The date and time can be set using the following procedure:

- Select the "Set date and time" utility from the utilities menu. The "Set date and time" popup menu appears.
- Move to the check field defining the time format required and press the *SELECT* key.
- Move to either the *Date* or *Time* field. These are normal editable fields (see Chapter 3, "Menu Overview"; "Field Types"); Each part of the date and time (day, month, year, hour and minutes) must consist of two digits, so include leading zeros. The parts are separated by dots. The hours should always be entered in 24-hour format. You will not be able to leave a field if the entries you make in it are not valid.
- Exit this popup menu by selecting either the *return* or *cancel* field. If the *return* field is selected, the instrument will use the new date and time.

Microprocessor Support

Insert the documentation delivered with the Micro-processor support options in this section.

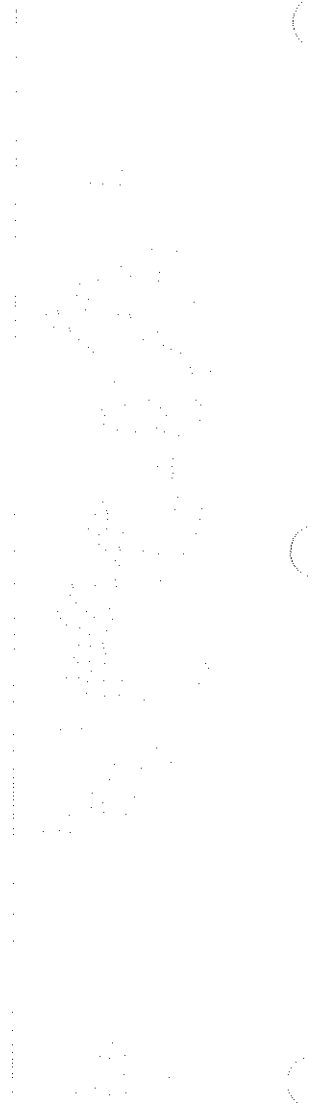

PROBLEM REPORTING / CHANGE REQUESTS

This PHILIPS instrument has been designed and manufactured to the highest quality standards to give you many years of trouble-free and accurate measurements.

However, if malfunctions are detected during the correct operational use of the instrument you are invited to report these problems to your local Fluke/Philips representative by means of the "PROBLEM REPORT / CHANGE REQUEST", reply cards included.

If you have any further suggestions about how this product could be improved, please contact your local Fluke/Philips representative.

Fluke/Philips addresses are listed in chapter 11 of this User Manual

accessories 1-10, 11-2
 accessory pouch 11-2
 accumulate mode 6-27
 action fields 3-5
 activating the dissembler 7-10
 active adapters 8-8
 active window 6-15
 activity indicators 3-2
 activity on the pods 3-7
 adapter types 8-7
 adapters 7-2
 add labels to display 6-17
 address lines 4-13
 addresses for Fluke/Philips 11-11
 addresses, target 7-3
 adjustment safety instructions 11-5
 after condition 5-23, 5-25
 analyzer activity indicators 3-2
 analyzer name field 3-3, 6-3
 analyzing the data 6-1-6-36
 architecture of Dual Analysis Per Pm 1-3
 arrow keys 2-4, 3-8
 trace menu 3-14
 ASCII label 6-30, 6-32
 assigned channels 4-8, 7-3, 6-26, 6-30
 assigned clocks 7-3
 assigned labels 7-3
 assigned pods 3-4, 3-8, 4-9, 7-3
 clocks 8-8
 labels 8-8
 pods 3-6
 qualifiers 4-8
 thresholds 3-12
 AXI field 7-9
 attribute field 3-9, 4-9, 4-12
 attributes
 clock 3-9, 4-12
 label 3-9, 4-9, 5-18
 set by dissembler 7-3
 tuning label 3-9, 4-11, 5-19, 6-16
 auto in data stored field 5-4
 auto-load 1-6, 3-7, 3-22
 automatic self-test 1-10, 11-9
 automatic synchronization 7-9
 auto-repeat 1-6, 3-3, 3-13, 3-16, 5-39
B
 backspace key 2-6
 base field 5-20, 6-32
 base of label 6-32
 basic measurement loop 1-3
 blank columns 6-30
 blinking activity indicator 3-2
 BNC connectors 2-7, 3-16
 triggering 5-24
 boxes on display 3-3, 3-4, 6-14
 brightness control 2-8, 11-9
 bus signals 6-23

DAP connectors 2-7, 9-1
 DAP see *Dual Analysis Per Pin*
 data
 analysis 6-1-6-36
 busses 4-14
 capture time 6-9
 comparison 5-40, 6-7
 copy to reference memory 6-7
 console 6-36
 display 6-1-6-36
 finding 6-30
 overview 6-8
 position in 6-12
 reference 6-7
 representation 7-5, 6-26, 6-30
 sampling 4-2
 scrolling 6-12
 scrolling through 6-11
 searching 6-30
 source 6-4
 storage, post-trigger 5-6
 stored at level 5-25
 stored type 5-4
 synchronous display 6-36
 transfers 7-9
 viewing 6-12
 data comparison field 5-40
 data source field 6-5
 data stored field 5-4
 date display 3-2
 date setting 12-3
 deactivating the disassembler 7-10
 default
 display on same line as 4-14
 qualifier(s) 4-14
 set up 1-6
 timing label 4-11, 4-14
 valid for clock 4-11
 delete files 3-22
 delete key 2-4
 delete labels from display 6-16
 detaching leads 8-4
 dial 2-1-2-5
 locking 6-11
 movement 6-12
 operation 6-11
 scrolling 3-19, 6-12
 time scale 6-22
 time field 6-29
 dial node
 dial field 6-29
 time scale 6-22
 scrolling 3-19, 6-12
 operation 6-11
 movement 6-12
 locking 6-11
 dial 2-1-2-5
 different dial mode 6-20, 6-29
 DIP packages 8-7
 DMS file 8-8

- executed instructions 7-7
- exploring the instrument 2-2
- extension sockets 8-7
- external clocks (*see also clocks*) 1-4, 6-6
- external connectors 2-7, 9-1-9-7
- external monitor connector 2-8, 9-6
- external output 3-16
- F**
- falling edge detection 5-9
- fetched instructions 7-7
- field types 3-4
- file handling 3-22
- files
 - copying 12-4
 - formats 10-1-10-3
 - reference data 6-7
 - find dial mode 6-29, 6-30
 - first character select fields 3-5
 - flashing activity indicator 3-2
 - floppy disk 3-22, 11-2
 - floppy disk drive 9-2
 - Fluke addresses 11-11
 - format disks 3-22, 12-4
 - format menu 3-8, 5-18, 7-3, 6-16, 8-8
 - clocks 4-2
 - labels and polarity 6-2
 - format of files 10-1-10-3
 - French manuals 11-2
 - front cover 11-2
 - front ends 8-4
 - standart 8-4
 - front panel 2-2
 - function fields 3-5
 - fuse 2-8
- G**
- German manuals 11-2
- German started guide 1-7, 11-2
- gilich data 3-16, 5-36
- gilich detector 3-8
- gilich dial mode 6-20
- go to level 5-24
- grabbers 8-3
- graph mode 6-24
- graphic display 6-24
- ground leads 8-4
- grounding 11-6
- grounding symbol 11-4
- H**
- half printing 3-24
- hardcopy file format 10-2
- hardcopy to disk file 3-24
- hexadecimal label 6-32
- high voltage symbol 11-4
- highlighted compartments 6-7
- highlighted field 3-3
- hollow rectangle 6-14
- home key 2-4

- number 5-23
- structure 5-23
- level options popup menu 5-25
- line dial mode 6-29
- line voltage 2-8
 - setting 11-7
- list display 3-18
 - setting 11-7
- list fields 3-5
- live part symbol 11-4
- load data 3-22
- load instrument settings 1-6
- loading disassembler 3-6, 7-3
- locator on display 6-14
- locking dial 6-11
- logic pod 11-2
- logic target 8-9, 11-2
- logical interpretation of signals 3-12
- M**
- mains lead 2-8
- mains voltage 2-8
 - setting 11-7
- maintenance safety instructions 11-5
- manual step 5-40
- manual synchronization 7-9
- manuals 1-7, 11-2
- maximum number of clocks and qualifiers 4-8
- maximum pulse width 5-29
- measure time differences 6-15
- measurement file 6-7
- measurement loop 1-5
- measuring clips 8-5, 11-2
- memory 3-16
- activity 7-9
- contents 6-8
- overview 6-8
- reference 6-7
- trigger point in 3-16
- usage 5-20, 6-8
- menu
 - clock attributes 3-9, 4-12
 - clocks on format 4-2
 - configuration 3-6, 7-3, 6-4
 - disassembler
 - parameters 7-9
 - display 3-18, 4-10, 5-40, 7-3, 7-10, 6-2-27
 - fields 3-3
 - format 3-8, 5-18, 7-3, 6-16, 8-8
 - I/O 3-22, 6-7, 8-8
 - label attributes 3-9, 4-9, 4-11
 - level options popup 5-25
 - menu bar 3-2, 5-41
 - overview 3-1, 3-24
 - popup menu fields 3-5
 - predefined sequences 5-35
 - print 3-24
 - purpose 3-2
 - run parameters popup 5-39, 5-40
 - set trigger word popup 5-20

- clock 3-9
- disassembler 7-6
- labels 3-9
- passive adapters 8-7
- pattern duration 5-7
- pattern recognition 1-3, 5-7
 - specifying 5-17
- pattern recognizer combinations 5-16
 - pattern recognizer fields 5-17
 - pattern recognizers
 - state 5-10
- pattern sequence example 5-31
 - patterns 3-14
 - pause printing 3-24
 - PC usage 3-23
 - percentage of memory filled 5-6
 - periods of a run 5-5
 - PF 8600/20 11-2
 - PF 8600/24 11-2
 - PF 8666/20 11-2
 - PF 8666/20 11-2
 - PF 8669/20 11-2
 - PF 8690 11-2, 11-9
 - PGA packages 8-7
 - Philips addresses 11-11
 - pin specifications 9-1-9-7
 - pipeline architecture 7-9
 - PLCC adapters 8-7
 - PM 3580 instruments 1-2, 5-9, 11-2
 - data from PM 3585 6-4
 - PM 3585 instruments 1-2, 1-3, 11-2
 - pod label sheet 11-2
 - pod system 8-2
 - activity indicator 3-7
 - assigned 4-9, 7-3
 - assigning 3-6
 - cables 8-3, 9-7
 - connectors 8-3, 9-7
 - format menu 3-8
 - microprocessor adapters 7-2
 - power lines on 8-3
 - range detector 5-12
 - scrolling 3-8
 - stickers for connectors 8-3
 - thresholds 3-8
 - polarity 3-8, 3-12
 - popup menu fields 3-5
 - popup menus *see menus*
 - position in data 6-12
 - position of cursor 6-12
 - position of the trigger point 3-16
 - position of trigger 3-21, 6-9
 - post-trigger period 5-6
 - power cable 2-8, 11-2, 11-9
 - power lines on pods 8-3
 - power on 1-10, 11-9, 12-2
 - power on auto-load 3-22
 - power on self-test 1-10, 11-9
 - power switch 2-8
 - power up 11-9, 12-2

S
 run periods 5-5
 S cursor 3-19, 6-11, 6-15, 6-19, 6-29
 comparisons 6-7
 safety 11-11-11-10
 safety notice 11-4
 sample numbers 6-10
 sampling state data 4-2
 save data 3-22, 6-7
 save reference to disk 6-7
 scale divisions 6-19
 screen image file format 10-2
 screen *see display or menu*
 SCREEN.FHC file 3-24
 format 10-2
 scroll dial mode 6-19
 scrolling 6-36
 display 2-4, 3-19, 6-11, 6-19, 6-29
 fields 2-4, 6-16
 labels 5-18, 6-16
 modes 3-19, 6-19, 6-29
 pattern fields 5-18
 pods 3-8
 synchronized 3-20
 waveforms 6-19
 search data 6-30
 select
 analyzer 3-3
 data source 6-4
 disassembler 3-6, 7-3
 display position 6-12
 fields 3-3
 labels for display 6-16
 SELECT key 2-5
 self-test 1-10, 11-9
 separately trigger state and timing example 5-34
 sequence
 break 5-31
 last user-defined 5-38
 pattern 5-7
 patterns 3-14
 restart 3-15, 5-36
 state 5-10
 timing 5-7
 type 3-15
 user-defined 5-7
 sequencer 1-3
 level display 6-17
 sequencer area 3-16
 sequencer facilities 5-22
 sequences
 predefined 5-35-5-38
 serial mouse connector 2-7, 9-5
 service center addresses 11-11
 service manual 1-7, 11-2
 SET file 8-8
 set reference cursors 6-11
 see also R cursor and S cursor

LOGIC ANALYZERS
PM 3580 / PM 3585

JTAG / IEEE 1149.1
Boundary-Scan Protocol
Analysis Package

PF 8683

Insert this document as an appendix of your
PM 3580/PM 3585 User Manual.

Table of Contents

Introduction 5
Adapter 5
Adapter Modes 6
Switch TDI/TDO 7
Disassembler 8
Installation 9
Application Notes 10
Signal Labels 10
Timing Analysis 10
State Analysis 10
Channel to Signal Assignment 11
Adapter Connector 1 11
Adapter Connector 2 12
TAP Connector Pinning 12
Technical Data PF 8683/x6 13
Electrical Data Adapter 13
Mechanical Data Adapter 13
Environmental Data 14

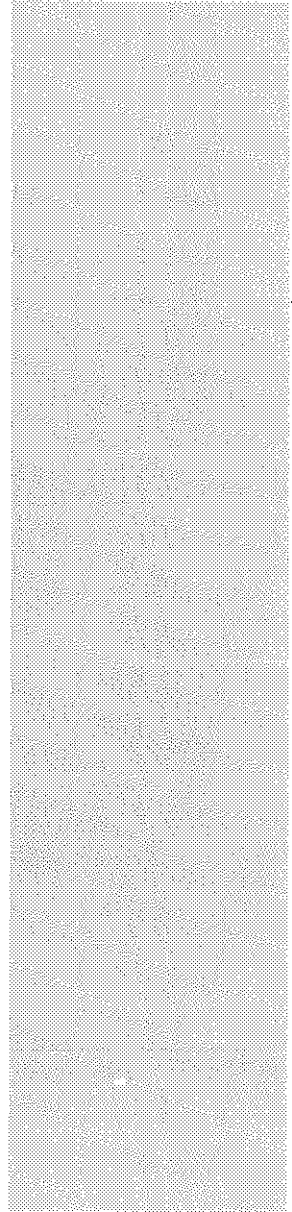

Boundary scan support

Introduction

Compatibility

Adapter

Dual Analysis

Supply Voltage

Adapter Connections

The JTAG / IEEE 1149.1 Boundary-Scan Protocol Analysis Package consists of a:

- Boundary-Scan TAP Adapter.
- Boundary-Scan Disassembler.

The package is used in combination with the Philips PM 3580/PM 3585 Logic Analyzers. It allows simultaneous timing and state analysis of the signals of a Test Access Port (TAP).

The design of the adapter complies with the JTAG / IEEE 1149.1 Standard Test Access Port and Boundary-Scan Architecture. It supports the 5 signals defined in the standard TCK (Test Clock), TDI (Test Data Input), TDO (Test Data Output), TMS (Test Mode Select) and TRST* (Test Reset). The disassembler displays the TAP controller states as defined in the standard (Test-Logic-Reset, Run-Test/Idle, Select-DR-Scan, etc.).

The adapter has been designed such that the Dual Analysis Per Pin architecture of the Logic Analyzer can be fully exploited. Simultaneous measurements in the timing and domain without any reconnection or multiple probing of TAP signal lines are possible.

This single probing methodology also avoids additional DC and AC loading of the TAP signal lines.

The adapter contains active circuitry which is powered by the Logic Analyzer.

The adapter can be connected to the interface cable between a boundary-scan tester and the Test Access Port (TAP) of a board under test. The adapter contains two 10-pin TAP connectors for this purpose.

By means of the switch labelled "SHIFT" you can select to display either the input of the scan chain "TDI" or the output "TDO" in the disassembler output column.

CAUTION
Using the pod cable without the right RC networks can damage the Logic Analyzer.

When the Mode switch is set into position "II" the 16-bit data collection mechanism of the adapter is disabled. Each data bit shifted is now displayed on a separate line in the state display. Furthermore consecutive Run-Test/Idle and Pause states are displayed on multiple lines. In this mode only one 40-pin connector has to be used.

Mode I clearly allows for a longer time interval (more scan patterns) to be traced than Mode II at the expense of 16 additional channels.

Note: The Logic Analyzer cables can be directly connected to the adapter. The adapter connectors contain RC networks for correct signal adaption from the adapter to the Logic Analyzer.

Boundary scan support

Switch TDI/TDO

Mode II

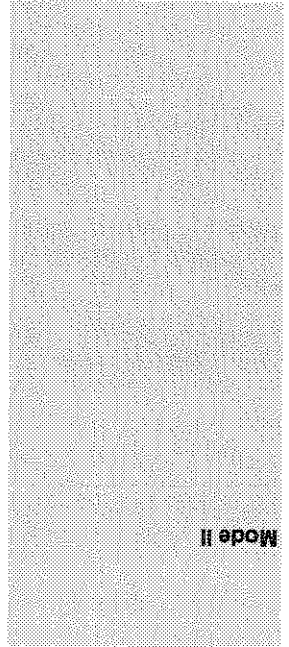
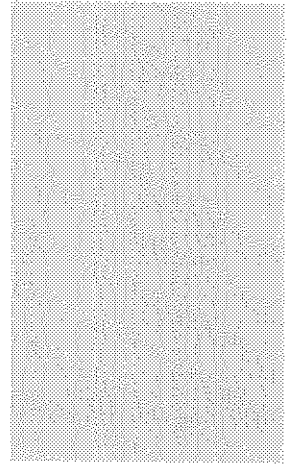

To install your Boundary-scan adapter and disassembler, complete the following procedure:

1. Disconnect the target system from any power source.
2. Switch off the Logic Analyzer.
3. Connect the pod cables 1 and 2 to the adapter connectors 1 and 2 in sequence. For mode II, only pod 1 is sufficient.
4. Ensure that the TAP connector pins on the adapter are connected with the corresponding Boundary-scan signals on the target.

CAUTION
Incorrect connection of the adapter can damage the adapter and the Boundary-scan target.

5. Switch on the Analyzer.

6. Power up your target. Proper working of the adapter requires that the reset sequence of the Boundary-scan target must be completed with the adapter connected.
7. Load the appropriate disassembler file (B_SCAN.DIS) from the distribution disk using the option field in the Configuration menu.

CAUTION
Do not connect the adapter onto the Logic Analyzer or target system with power applied to your Logic Analyzer or target system.
Integrated circuits contain protective circuitry against damage due to ESD. However, it is advised that normal precautions be taken to avoid application of any voltages higher than the maximum rated voltages to the adapter.

Channel to Signal Assignment

The first digit of the adapter channel number corresponds with the pod number. The last two digits of the adapter channel number correspond with the pod channel number. For example: Adapter channel 1.06 corresponds with pod 1 and channel 6

Adapter Connector 1

Adapter Channel Number	Analyzer Screen Label	Index	Boundary Scan Signal Name
------------------------	-----------------------	-------	---------------------------

1.00	INSTR	0	3
1.01	INSTR	1	3
1.02	INSTR	2	3
1.03	INSTR	3	3
1.04	SOIO	0	3
1.05	SOIO	1	3
1.06	QUAL ^{1,3}		3
1.07	STCK ^{2,3}		3
1.08	TRSTN ⁴		3
1.09	TCK		
1.10	TMS		
1.11	TDI		
1.12	TDO		
1.13	-		
1.14	TDIS		3
1.15	TDOS		3

Notes page 8683-12

- Notes:
1. Adapter connected to Logic Analyzer.
 2. Setup time and hold time with respect to the positive-going TCK signal edge, which is used as Logic State Analyzer clock.
 3. Without pod cables.

Characteristic	Unit
Contact life	100 cycles
Dimensions (l,w,h) ³	62, 112, 36 mm

Mechanical Data Adapter

Characteristic	Unit
Input capacitance ¹ (tp.)	40 pF
Input leakage current	± 10 nA
Input voltage, VIL min.	-0.3 V
Input voltage, VIH max.	0.8 V
VIL max.	2.0 V
VIH min.	2.0 V
VIH max.	V _{DD} +0.3 V
Max. TCK clock frequency	12.5 MHz
Min. setup time ²	40 ns
Min. hold time ²	10 ns
Max. voltage	6 V
ESD immunity	2 kV

Electrical Data Adapter

Characteristic	Unit
	PF8683/36

Technical Data
PF 8683/x6

Boundary scan support