

Programmable Automatic RCL Meter

PM6306

Programmers Manual

960508

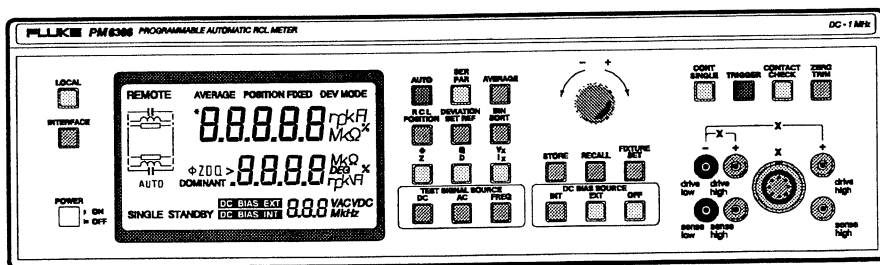

FLUKE®

Please note

In correspondence concerning this instrument, please quote the type number and serial number as given on the type plate.

Bitte beachten

Bei Schriftwechsel über dieses Gerät wird gebeten, die Typennummer und die Gerätenummer anzugeben. Diese befinden sich auf dem Typenschild an der Rückseite des Gerätes.

Noter s.v.p.

Dans votre correspondance et dans vos réclamations se rapportant à cet appareil, veuillez toujours indiquer le numéro de type et le numéro de série qui sont marqués sur la plaquette de caractéristiques.

Important

As the instrument is an electrical apparatus, it may be operated only by trained personnel. Maintenance and repairs may also be carried out only by qualified personnel.

Wichtig

Da das Gerät ein elektrisches Betriebsmittel ist, darf die Bedienung nur durch eingewiesenes Personal erfolgen. Wartung und Reparatur dürfen nur von geschultem, fach- und sachkundigem Personal durchgeführt werden.

Important

Comme l'instrument est un équipement électrique, le service doit être assuré par du personnel qualifié. De même, l'entretien et les réparations sont à confier aux personnes suffisamment qualifiées.

The wordmark Philips and the Philips shieldemblem
are used under licence from Philips Export B.V.

© 1995, 1996 Fluke Corporation.

All rights reserved.

Data subject to change without notice

Printed in Germany

FLUKE®

INSIDE THIS MANUAL

This PROGRAMMERS MANUAL contains information about how to control the PM6306 by a Personal Computer or Controller via IEEE-488 or RS-232.

The manual is organized into the following chapters:

Chapter 1 IEEE-488 Interface

This chapter describes the function of the IEEE-488 interface and how to set the instrument address.

Chapter 2 RS-232 Interface

This chapter describes the RS-232 interface and the steps necessary for configuration.

Chapter 3 Remote Control Commands

This chapter contains information about the Message Syntax and describes all commands necessary for operation via IEEE-488 as well as via RS-232.

Chapter 4 Programming Examples

This chapter shows programming examples for IEEE-488 and RS-232.

Chapter 5 Printing of Measurement Results

This chapter shows a setup for direct printing of measurement results without PC.

Chapter 6 Error Messages

This chapter lists error messages with references to chapters in this manual and to the Service Manual where the topic is described.

Chapter 7 Commands in Alphabetical Order

This chapter shows all commands and queries in a short form. It serves as a reference for correct syntax.

Using the Programmers Manual requires that you are acquainted with the functions of the instrument, measurement setups, parameters, and limits.

For detailed information about:

- Safety Precautions
- Getting Started
- How to Use the Instrument
- Function Reference
- Characteristics
- Specifications

see

USERS MANUAL (English)

GEBRAUCHSANLEITUNG (German)

MODE D'EMPLOI (French)

CONTENTS

		Page
1	IEEE-488 INTERFACE	1 – 1
1.1	INSTRUMENT ADDRESS	1 – 1
1.2	INTERFACE FUNCTIONS	1 – 2
2	RS-232 INTERFACE	2 – 1
2.1	INSTRUMENT CONFIGURATION	2 – 1
2.2	INTERFACE FUNCTIONS AND WIRING	2 – 5
2.3	SPECIAL INTERFACE FUNCTIONS	2 – 7
3	REMOTE CONTROL COMMANDS	3 – 1
3.1	PROGRAM MESSAGE SYNTAX	3 – 1
3.2	MESSAGE TERMINATOR	3 – 1
3.3	SERVICE REQUEST (SRQ) AND STATUS REGISTERS	3 – 2
3.4	COMMON COMMANDS (IEEE-488.2)	3 – 4
3.5	DEVICE SPECIFIC MESSAGES	3 – 8
	3.5.1 Instrument Settings and Measurements	3 – 9
	3.5.2 Binning	3 – 21
	3.5.3 Additional Commands	3 – 27
4	PROGRAMMING EXAMPLES	4 – 1
	IEEE-488 INTERFACE	4 – 1
	RS-232 INTERFACE	4 – 4
5	PRINTING OF MEASUREMENT RESULTS	5 – 1
6	ERROR MESSAGES	6 – 1
7	COMMANDS IN ALPHABETICAL ORDER	7 – 1
7.1	COMMON COMMANDS AND QUERIES (IEEE-488.2)	7 – 1
7.2	DEVICE SPECIFIC COMMANDS	7 – 2
	7.2.1 Settings and Measurements	7 – 2
	7.2.2 Commands for Binning	7 – 5

Chapter **1**

IEEE-488 INTERFACE

1 IEEE-488 INTERFACE

1.1 INSTRUMENT ADDRESS

All instrument functions can be controlled via the IEEE-488/IEC interface.

Before learning the remote interface command set, first get acquainted with the functions of the instrument, measurement setups, parameters, and limits. A detailed description with examples is in the USERS MANUAL (GEBRAUCHSANLEITUNG or MODE D'EMPLOI).

The following chapter describes the functions of the IEEE-488 bus interface.

For commands, queries, syntax, and terminators, see Chapter 3.

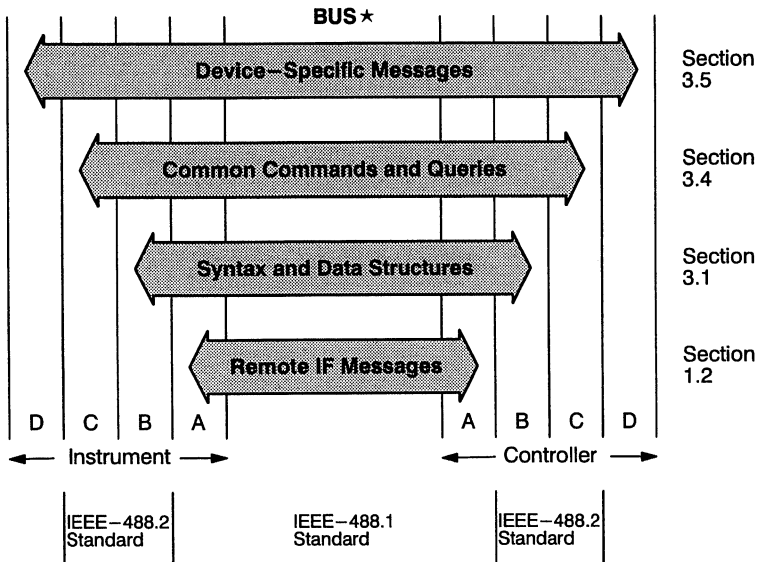

- A = Interface functions
- B = Message communication functions
- C = Common system functions
- D = Device functions

* This figure is in accordance with 'IEEE-488 Standard Codes, Formats, Protocols, and Common Commands' (ANSI/IEEE-488 Std 488.2-1987).

Remote control of the instrument requires the instrument address to be known. On delivery from the factory the address is set to 20. You can display the set address by pressing the INTERFACE key. You can change the address by turning the rotary knob from 1 to 30.

On power up the instrument is in 'local' mode (input via keyboard). When addressed as listener by a controller, the text REMOTE appears in the display field. All keys except LOCAL are locked and you can now operate the instrument in remote control. To return to local operation, use the addressed command GTL (go to local) or press the LOCAL key. To avoid unintended local control, you can disable the LOCAL key by using the universal command LLO (local lockout).

1.2 INTERFACE FUNCTIONS

The following interface functions are implemented:

AH1: acceptor handshake	SR1: service request SRQ
SH1: source handshake	DC1: device clear function
L4: listener function	DT1: device trigger function
T6: talker function	PP0: no parallel poll
RL1: local/remote with local lockout	C0: no controller function
	E2: tri-state drivers

Hardware, connections, and the handshake procedure are in accordance with IEEE-488.1.

Chapter **2**

RS-232 INTERFACE

2 RS-232 INTERFACE

2.1 INSTRUMENT CONFIGURATION

All instrument functions can be controlled via the RS-232 interface.

Before learning the remote interface command set, first get acquainted with the functions of the instrument, measurement setups, parameters, and limits. A detailed description with examples is in the **USERS MANUAL** (also in the **GEBRAUCHSANLEITUNG** or **MODE D'EMPLOI**).

The following chapter describes the functions of the RS-232 bus interface. Chapter 3 contains information about commands, queries, syntax, and terminators.

You can also send measurement results directly to a printer via the interface without any PC or controller. This mode is described in Chapter 5.

Remote control of the instrument requires an interface communication configuration that matches that of your PC. Press the **INTERFACE** key to display the current configuration. Turn the rotary knob to change the displayed configuration.

Pressing the **INTERFACE** key shows the current configuration:

Function and Key Operation

INTERFACE



and after 2 seconds

Display

Communication or Printer mode
(Co or Pr)

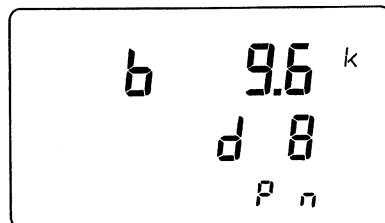

That means:
baud rate 9600, data bits 8,
parity no

If you want different settings, press the **INTERFACE** key again during display:

Function and Key Operation

Display

INTERFACE

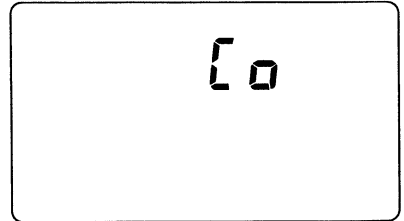
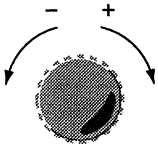

select operating mode

Pr Printer mode or

Co Communication mode

INTERFACE

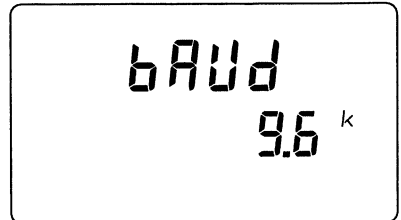
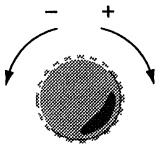

select baud rate

110, 150, 300, 600,

1200, 2400, 4800, 9600, 19200

for 110 baud 2 stop bits are set,
otherwise 1 stop bit

Function and Key Operation

Display

INTERFACE

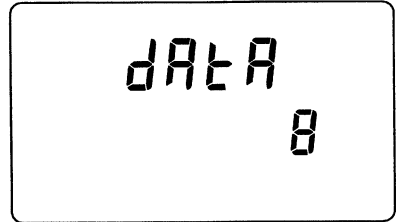
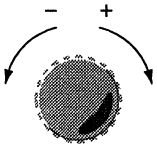

select data bits **7** or **8**
(7 bits for parity **Even** or **Odd**)

INTERFACE

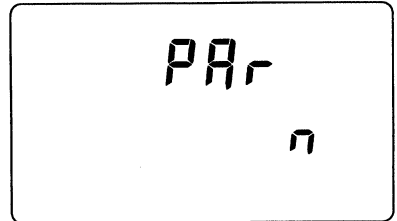
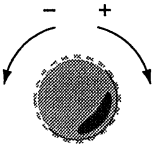

select parity **Even**, **Odd** or **no**
(parity **no** for 8 data bits only)

Function and Key Operation

Display

INTERFACE

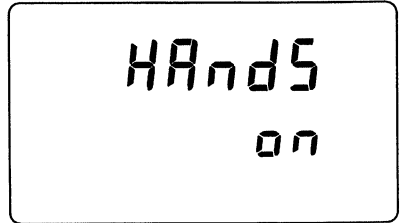
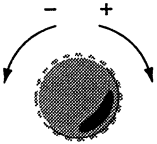

select Xon/Xoff handshake
on or **off**

INTERFACE

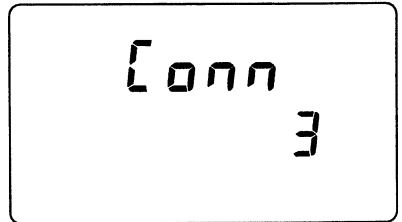
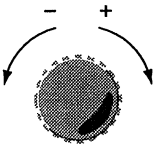

select **3** or **7** wire connection

Press the **INTERFACE** key again to leave the mode.

If you do not press a key within 3 seconds during configuration, the instrument automatically returns to measuring mode, and the altered configurations are not stored.

On power up, the instrument is in 'local' mode (input via keyboard). When you set the instrument to listener mode by sending the command **ESC2** via the PC, the REMOTE text appears on the display. All keys except LOCAL are locked and the instrument can now be operated in remote control. Return to local operation is done by the command **ESC 1** or by the LOCAL key. To avoid unintended local control, you can disable the LOCAL key by using the command **ESC 5**.

2.2 INTERFACE FUNCTIONS AND WIRING

Operating modes:	Communication mode, talk only mode (Printer mode)
Baud rates:	110, 150, 300, 600, 1200, 2400, 4800, 9600, 19200
Data bits :	7 or 8
Stop bits:	1 (2 for 110 baud only)
Parity:	ODD EVEN NO (with 8 data bits)
Xon/Xoff Handshake:	ON or OFF
Hardware connection:	3 wires, no hardware handshake 7 wires, with hardware handshake
Hardware handshake:	DSR/DTR and CTS/RTS
Connector:	9-pin D-connector (male)

Because the PC and the PM6306 are DTE (Data Terminal Equipment) you should use the following pin configuration for the RS-232 connection cable. In general it is recommended that you use a well shielded cable for adequate radio interference suppression.

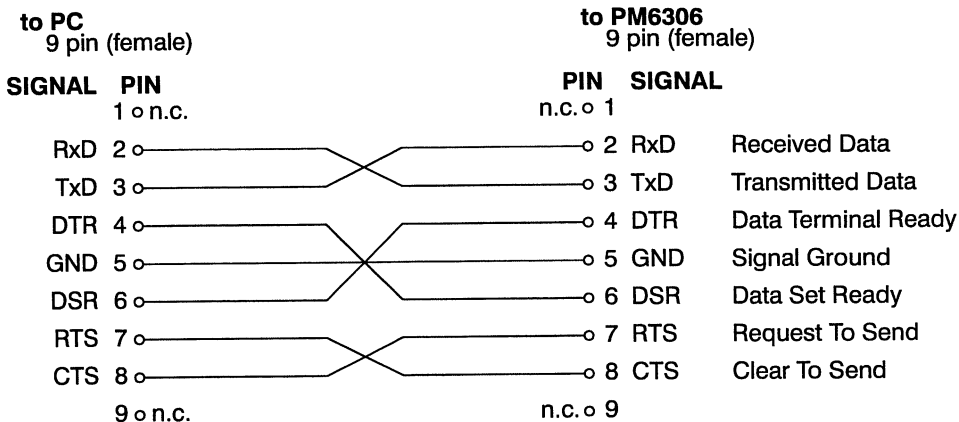

This cable can be purchased from your local Fluke organization, order number PM 9536/041.

If you use a 3-wire connection, set the PM6306 to software handshake.

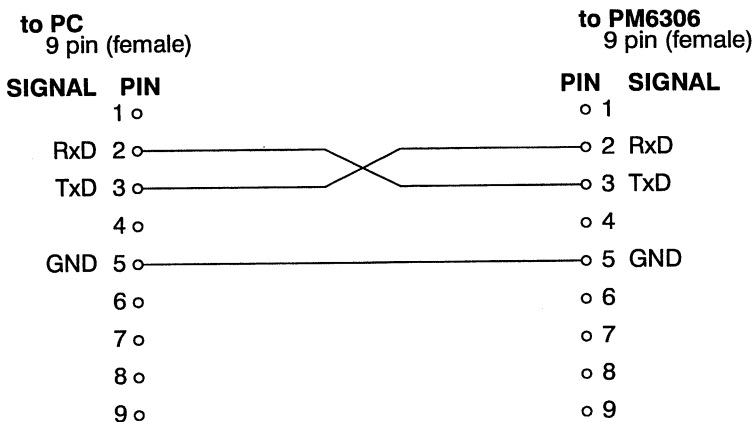

2.3 SPECIAL INTERFACE FUNCTIONS

For communication with the RS-232 interface, use the following commands (similar to the addressed and unaddressed interface commands for IEEE-488):

RS-232	Function	Similar to IEEE-488
ESC 1	go to local	GTL
ESC 2	go to remote control	GTR
ESC 4	device clear	DCL
ESC 5	local lock out	LLO
ESC 7	asks for status byte	★ STB?
ESC 8	device trigger	DTR

These commands should be implemented in an application program, so they can be send to the instrument by a PC.

Chapter **3**

REMOTE CONTROL COMMANDS

3 REMOTE CONTROL COMMANDS

In this section the commands are described as they relate to the instrument functions and front panel keys, which are listed in the PM6306 Users Manual in Chapter 5, Function Reference. If not stated otherwise, following commands are used for IEEE-488 as well as for RS-232.

3.1 PROGRAM MESSAGE SYNTAX

You can combine several commands in a message and send them to the instrument, using the semicolon ";" as a separator between the commands.

Header and data element must be separated by a space; the end of a message must be terminated by NL (new line), ^END or both for the IEEE-488 interface and by NL for the RS-232 interface.

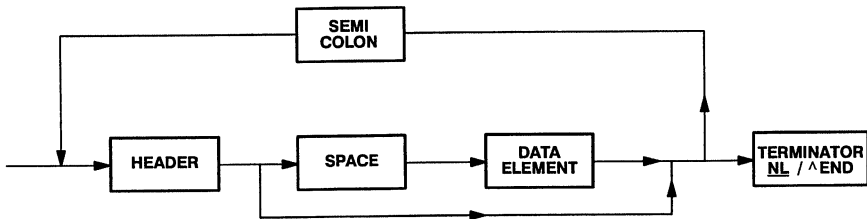

3.2 MESSAGE TERMINATOR

The instrument accepts ^END or NL (ASCII 10 dec.) or both as the terminator for a program message via the IEEE-488 interface.

The instrument also sets ^END and NL as the terminator for a response message. For compatibility to earlier controllers, you can program terminators that depart from the IEEE-488.2 standard. Use the command TRM followed by the decimal value of the required ASCII character.

Example: **TRM 13,10** sets CR NL as terminator for a response message

The command TRM without the decimal value, *RST or the interface functions SDC/DCL sets the initial terminator again. The initial terminator is also set after power on.

Programming via the RS-232 interface uses only NL as the terminator.

3.3 SERVICE REQUEST (SRQ) AND STATUS REGISTERS

A Service Request will be generated if one or more bits of the 'Status Byte Register' are set to 1 and if the corresponding bits are enabled by the 'Service Request Enable Register' (IEEE-488 interface only). The controller asks the contents of the 'Status Byte Register' in 'Serial Poll Mode.'

PM6306 'Status Byte Register':

Bit	Function	Decimal Value
0	} not used	1
1		2
2		4
3		8
4	message available (MAV)	16
5	bit of the 'Standard Event Status Register' high	32
6	request for service (RSQ)	64
7	not used	128

To get the information via Service Request that bits of the 'Standard Event Status Register' are set, those bits must have been enabled by *ESE, **and** bit 5 of the 'Status Byte Register' must have been enabled by *SRE.

Direct readout without Service Request is possible for the IEEE-488 as well as for the RS-232 interface by using the *ESR? query for the 'Standard Event Status Register' and by the *STB? query for the 'Status Byte Register.'

PM6306 'Standard Event Status Register'

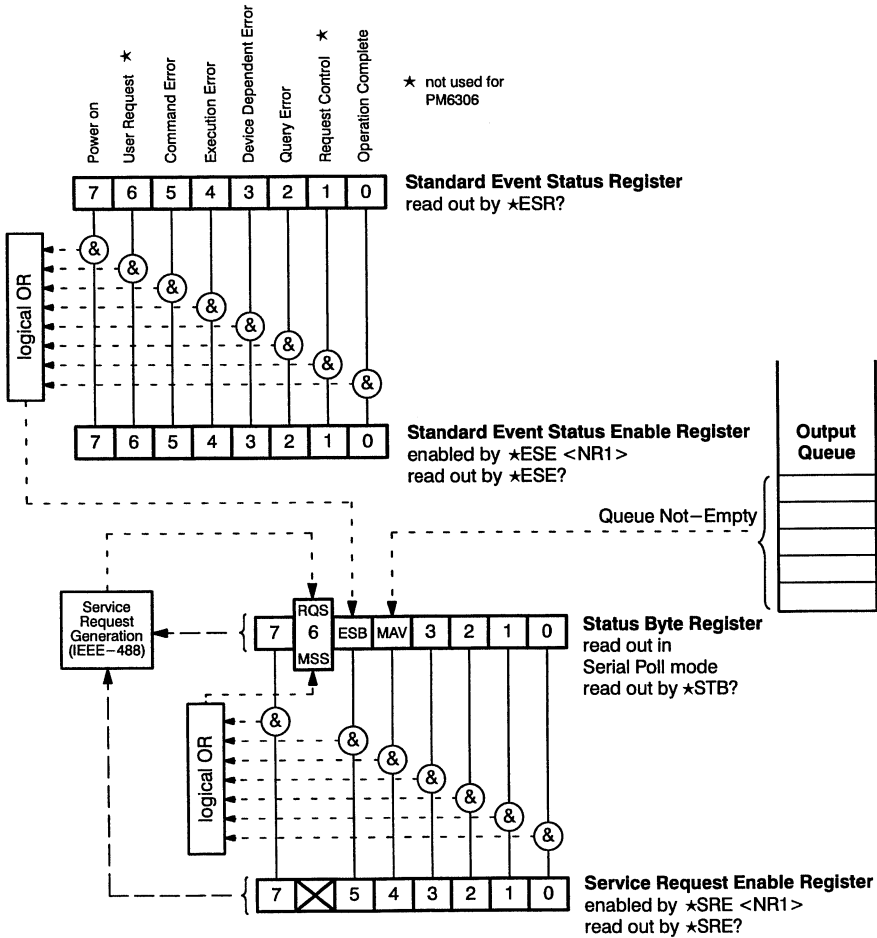

<NR1> represents a decimal value. The binary pattern of the decimal value sets the corresponding bits of the 'Enable Registers' to 1, which enables the bits of the 'Status Registers'.

All bits of the 'Standard Event Status Enable Register' and the 'Service Request Enable Register' are automatically set to 0 when powering up the instrument. Therefore, in a user program it is necessary that the required bits are set to 1 after power-on, if Service Request is required.

3.4 COMMON COMMANDS (IEEE-488.2)

System Data:

★IDN? Identification Query

After receipt of this query, the instrument generates the following response message:

FLUKE,PM6306,0,Vx.x/0000

x.x = software status

★LRN? Learn Device Setup Query

After receipt of the query the PM6306 generates a response message which comprises the complete actual instrument setups. This message can be read in by a controller, stored in a program, and re-sent as a program command message to the instrument later on. By this method, manual keyboard inputs can be read into a program.

Internal Operations:

★RST Reset Command

This command performs a reset, which sets the instrument to a default status:

Measuring mode:	AUTO
Test signal:	AC
Measurements:	CONTINUOUS
Average:	OFF (normal)
Test signal frequency:	1 kHz
AC test signal level:	1 V rms
DC bias:	OFF
Deviation mode:	OFF
Fast measurement:	OFF
Binning:	OFF
Position fixed:	OFF
Range Hold:	OFF

The reset does not affect the internal memories of the instrument, the enable registers, or the status registers of the interface.

★TST? Self-test Query

The instrument automatically checks the RAM and the EEPROM. The contents of the register will not be destroyed, and instrument settings remain unchanged. The test lasts approximately 1 second.

A zero in the response indicates that the self-test has completed without errors detected.

In case of an error, one of the following digits is displayed:

- 1 = error during RAM test
- 2 = error in storage register 0
- 3 = error in other storage registers
- 4 = EEPROM defective
- 8 = calibration data not valid
- 12 = trimming data not valid
- 16 = bin data not valid
- 32 = line frequency identification defective
- 64 = no trimming data
- 128 = no calibration data

If the test detects more than one error, the sum of the single error numbers is displayed.

Synchronization:**★OPC Operating Complete Command**

For PM6306, this command is suggested only for single measurements, trimming, contact check, calibration, and when the test signal has been altered. Selecting one of these functions via the IEEE-488 bus, followed by the command ★OPC in the same string, sets bit 0 (operation complete) of the 'Standard Event Status Register' to 1 when the function is finished. This bit activates bit 5 of the 'Status Byte Register' (Event Status Bit), which generates a Service Request. This alerts the controller that the function is finished. See Section 3.3 to enable the Service Request.

Example: TRIG;★OPC

causes the instrument to set bit 0 of the 'Standard Event Status Register' to 1 when the operation (single measurement) is completed.

When the instrument is externally triggered, it is recommended you send ★OPC alone. Bit 0 is set to 1 when the externally triggered measurement is finished.

If ★OPC is sent when the operation is already finished bit 0 is not set to 1.

★OPC? Operation Complete Query

This command also works well for single measurements, trimming, contact check and calibration. Sending the query ★OPC? to the instrument during a running function causes the instrument to wait until the function is finished, and then set a 1 in the output queue. The register can be read out by the controller without a Service Request. When a 1 is returned, your user program can then continue.

Data in the output queue activates bit 4 of the 'Status Byte Register' (MAV, message available), which may generate a Service Request. To avoid generating an SRQ, disable bit 4 (set it to 0). Bit 0 (operation complete) of the 'Standard Event Status Register' is not affected by ★OPC?

Contrary to ★OPC, the query ★OPC? is more convenient for the RS-232 interface because the 1 is directly sent; a separate read-out is not necessary as it would be for the IEEE-488 interface.

If ★OPC? is sent when the operation is already finished, bit 0 is not set to 1.

★WAI Wait-to-Continue Command

This command sent to the instrument in a message string with other commands causes the instrument to execute the command following ★WAI only when the previous command is completed.

Example: TRIG;★WAI;COMP?

In single measurement mode this message causes the instrument to wait until the measurement is finished; after that it sends the result. This avoids a readout of the stored values of the previous measurement.

The message SINGL;★WAI;COMP? is only applicable for external trigger; the command TRIG via interface is not accepted in this case.

Sending ★WAI alone or at the end of a string could stop the communication via the interface.

★TRG Trigger Command

When receiving ★TRG, the instrument starts a measurement in single measurement mode (see Section 3.5.1.7 to set instrument for single measurement mode).

Status and Event:**★CLS Clear Status Command**

Sets bits of the 'Standard Event Status Register' and of the 'Status Byte Register' to zero. Sending ★CLS as a single command or as the first command of a string also clears the contents of the Output Queue.

★ESE Standard Event Status Enable Command

★ESE, followed by a decimal value, sets the bits of the 'Standard Event Status Enable Register.' For more detail on the assigned bits of the 'Standard Event Status Register,' see Section 3.3.

★ESE? Standard Event Status Enable Query

This query asks the instrument for the contents of the 'Standard Event Status Enable Register.' The response is a decimal value.

Example: 255 = all bits are set to 1: all events of the 'Standard Event Status Register' are enabled.

★ESR? Standard Event Status Register Query

Asks for the contents of the 'Standard Event Status Register.' The response is a decimal value. This query also clears the register contents.

★SRE Service Request Enable Command

★SRE, followed by a decimal value, sets the bits to 1 of the 'Service Request Enable Register', except bit 6. For more detail on the assigned bits of the 'Status Byte Register,' see Section 3.3.

★SRE? Service Request Enable Query

Asks for the contents of the 'Service Request Enable Register.' The response is a decimal value.

★STB? Read Status Byte Query

Asks for the contents of the 'Status Byte Register.' The response is a decimal value.

Sending this query via IEEE-488 interface causes the PM6306 to set bit 4 (MAV) of the Status Byte Register. The output is 16 dec if no further bits are set.

Save and Recall Instrument Settings:**★SAV Save Command**

This command, followed by a decimal value from 1 to 9, stores the current instrument setting including trimming data into the corresponding internal memory register. The contents of the memory are not affected by the command ★RST or when the instrument is turned off.

★RCL Recall Command

This command followed by a decimal value from 1 to 9 for the memory place calls up and executes the instrument setting stored in that memory register. Trim data are also recalled.

3.5 DEVICE SPECIFIC MESSAGES

This section contains the remote programming commands necessary to select operation modes and parameters and to read out measurement values.

Numeric entry

<NRf> flexible numeric representation

Under the IEEE-488.2 standard, numeric values can be given to the instrument in integer <NR1>, real <NR2>, or exponential <NR3> forms. The number of digits is limited to 10 for mantissa and 2 for the exponent. The dimension (**Hz**, **F**, **H**, **Ω**, **V**, **I**, or **degrees**) is automatically set by the instrument.

You can set the test frequency, for example, to 1 kHz with following inputs for <NRf>:

FREQUENCY 1.000e3	
FREQUENCY 1000	
FREQUENCY 1000.0	
FREQUENCY 1E3	
FREQUENCY 1000.1	instrument rounds to its nearest available frequency which is 1 kHz

Some headers can be sent as command headers to program the instrument and also as queries by adding a question mark. The instrument returns its actual setting in response to the query.

Example:	FREQUENCY 1E3	sets the test signal frequency to 1 kHz
	FREQUENCY?	response: FREQ 1.0E3

Sending several queries in a single string could cause an error message if the answer exceeds 31 characters.

Most headers can be used in short form, marked with bold letters in the table.

Example: **DEVIATION ON** in short forms **DEV ON**

3.5.1 **Instrument Settings and Measurements**

3.5.1.1 **Measuring Modes**

In most cases, you will be interested in the dominant parameter of the component. This is automatically determined in the AUTO mode. The display shows AUTO, the value of the dominant parameter in the upper line, the value of the secondary parameter in the lower line, and the appropriate equivalent circuit symbol.

If you want to determine a parameter that differs from the automatically determined by the instrument, select SERIAL or PARALLEL MODE.

Auto Mode Decision Diagram

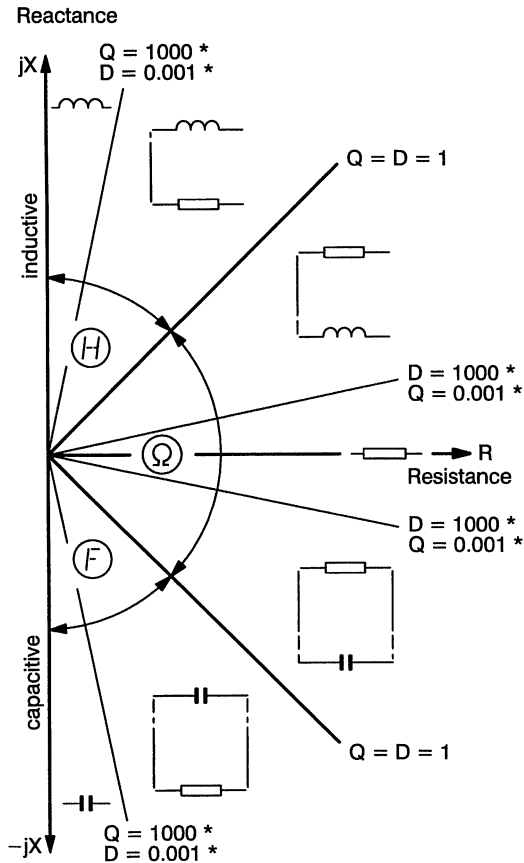

* For test signal voltages ≤ 0.25 V, the decision criterion is $Q = 200$, $D = 0.05$, or $Q = 0.05$, $D = 200$.

Commands:
MODE AUTO
MODE SERIAL
MODE PARAL

Query:
MODE?

Response:
MODE AUTO
MODE AUTO SER
MODE AUTO PAR
MODE SER
MODE PAR

3.5.1.2 Parameters

You also can select certain parameters to be displayed, for example, phase angle, quality factor, impedance, etc.

Commands:	PARAM QUALITY	quality factor
	PARAM DISSIPATION	dissipation factor
	PARAM PHASE	phase angle
	PARAM IMPEDANCE	impedance
	PARAM VOLTAGE	measured voltage
	PARAM CURRENT	measured current
	PARAM AUTO	measurement selected before (AUTO, SER or PARAL)

Query: **PARAMETER?**

Response: PARAM QUA
PARAM DISS
PARAM PHA
PARAM IMP
PARAM VOL
PARAM CUR
PARAM AUTO

To read out measured values see Section 3.5.1.8.

3.5.1.3 Automatic Zero Trim

If you measure low-resistance components (i.e., less than 100 Ω), or small inductances (i.e., less than 100 nH) short circuit the connection sockets and perform trimming.

For measuring small capacitances (i.e., less than 200 pF) or high resistances, perform trimming with open connection sockets.

For detailed information see the Users Manual, Section 4.3 and Chapter 5. You can select TRIM SINGLE or TRIM ALL. If you select TRIM SINGLE the instrument only measures with the test frequency selected. If you select TRIM ALL the instrument measures with the test frequency selected, with 15 additional frequencies and with DC, if a DC-Unit is built-in.

Commands: **TRIM SINGLE** (the extension SINGLE may be left out).
TRIM ALL

Query: none

Response: none

If the trim fails, the instrument generates an error message.

3.5.1.4 Contact Check

With this function you can check whether transition resistances of your setup affect the measuring accuracy in an inadmissible way. For detailed information see USERS MANUAL, Section 4.4 and Chapter 5.

Commands: **CONTA_CHE**

Query: none

Response: none

If the resistances are too high, the instrument generates an error message.

3.5.1.5 Test Signal

You can select an AC test signal with different frequencies or a DC test signal (option). If you want to send a query for measurement results after you change the test signal, allow the instrument to set the new settings, see \star OPC(?) and \star WAI, Section 3.4.

Test signal AC/DC

Commands: **TEST_SIGNAL AC**
 TEST_SIGNAL DC

Query: **TEST_SIGNAL?**

Response: **TEST_SIG AC**
 TEST_SIG DC

Test signal frequency

You can select following frequencies: 50, 60, 100, 120 Hz
 200 Hz to 100 kHz in 100 Hz steps
 100 kHz to 1 MHz in 1 kHz steps.

If you select different values, the instrument automatically rounds to the next valid frequency value.

Commands: **FREQUENCY <NRf>** NRf = values see above

Query: **FREQUENCY?**

Response: **FREQ <NR1> or <NR3>**

Test signal level

You can select test signal voltages from 0.05 V to 2.00 V, resolution 0.01 V:

AC voltage: **AC_LEVEL** <NRf> NRf = value in V_{rms} within the
range mentioned above.

Query: **AC_LEVEL?**

Response: **AC_LEVEL** <NR2>

DC voltage: **DC_LEVEL** <NRf> NRf = value in V within the
range mentioned above.

Query: **DC_LEVEL?**

Response: **DC_LEVEL** <NR2>

3.5.1.6 DC Bias

You can add an internal bias voltage up to 10 V, resolution 0.1 V, or an external one of maximum 40 V to the AC test signal voltage.

Commands: **DC_BIAS OFF**
 DC_BIAS INT
 DC_BIAS EXT
 BIAS VOLTAGE <NRf>

Query: **DC_BIAS?**
 BIAS_VOLTAGE?

Response: **DC_BIAS OFF**
 DC_BIAS INT
 DC_BIAS EXT
 BIAS_VOLTAGE <NR2> or <NR3>

3.5.1.7 Measuring Types

For normal measurement you should select continuous measurement.

For binning or using the instrument for checking in automatic systems you should select single measurements. This allows you to remove or to insert components and to start a measurement at a defined moment.

You can increase the measurement speed up to 10 measurements per second. The measurement results are returned via remote interface only. The display shows FAST, and the measured values can be read out by the controller (IEEE-488 interface). When you use the RS-232 interface, the value is sent directly to the computer.

In FAST mode different tolerances are valid. See USERS MANUAL, Section 6A in the Appendix.

The following test signal frequencies are available in FAST mode:
200 Hz to 100 kHz in 200 Hz steps,
100 kHz to 1 MHz in 1 kHz steps.

If you select a different frequency via interface or keyboard, the instrument sets to the next lower frequency.

Continuous or single measurements

Commands: **CONTIN**
 SINGLE

Query: **TRIG?**

Response: **CONTIN**
 SINGLE

Start a single measurement

Commands: **TRIGGER**

Query: **TRIGGER?**

Response: **CONTIN**
 SINGLE

Fast measurement

Commands: **MEAS_FAST ON**
 MEAS_FAST OFF

Query: **MEAS_FAST?**

Response: **MEAS_FAST ON**
 MEAS_FAST OFF

Note:

- FAST measurement is possible only in SINGLE mode.
- The instrument measures the value of the dominant parameter or of the parameter selected by PARAM
- The measured value and the bin number must be read out by a controller without query when the measurement is finished.
- Instrument settings cannot be stored.
- The command TRIM or BIN_RCL <NRf> switches off FAST measurement.
- When you switch to LOCAL, the instrument returns to FAST measurement OFF. When you combine FAST measurement and Binning, the instrument remains in this mode when you switch to LOCAL; so you can bin in FAST measurement mode without a PC.
- In FAST measurement mode, the bin 0 output of the Handler Interface provides a timing signal for an external component handler; see Users Manual, Section 6A.6 in the Appendix.
- If you trigger externally in FAST measurement mode, avoid contact bouncing.

RCL Position Fixed

When the instrument measures components with a quality factor of about $Q=1$ either a resistance or a capacitance/inductance is determined as the dominant parameter; see Auto Mode Decision Diagram, Section 3.5.1.1. With the Position Fixed, function you can define which parameter will be displayed in the upper display row. In the response string this parameter is the first one, regardless of whether or not it is the dominant one.

The function is applicable for the modes AUTO, SER, PAR, DEVIATION, and FAST modes. It cannot be stored with *SAV into the internal memory registers.

Commands:	POSITION_FIX R	sets resistance
	POSITION_FIX C	sets capacitance
	POSITION_FIX L	sets inductance
	POSITION_FIX CL	sets capacitance or inductance
	POSITION_FIX OFF	switches the function off
	POSITION_FIX ON	switches the function on

Query: **POSITION_FIX?**

Response: POSITION_FIX R
POSITION_FIX C
POSITION_FIX L
POSITION_FIX CL
POSITION_FIX OFF

Deviation Mode

In this mode you can measure components, and the instrument simultaneously displays the absolute measurement value and the deviation in percent from a previously set reference value.

Commands: **DEVIATION ON**
 DEVIATION OFF

Query: **DEVIATION?**

Response: DEV ON
 DEV OFF

Query for value: **DEVIATION_RESULT?**

Response: DEV_RES <NR1>

You can directly program a reference value for R, C, or L:

Commands:	REF_CAPACITANCE <NRf>	NRf = value within the permitted measuring ranges
	REF_INDUCTANCE <NRf>	
	REF_RESISTANCE <NRf>	

You can also set the currently measured parameter and its value for reference:

Command: **SET_REFERENCE**

Query for reference: **REFERENCE?**

Response: REF_CAP <NRf>
 REF_INDU <NRf>
 REF_RESI <NRf>

3.5.1.8 Queries for measured values

Query:	COMPONENT?	asks for dominant and secondary parameter shown in the display
	RESISTANCE?	
	CAPACITANCE?	
	INDUCTANCE?	
	IMPEDANCE?	
	QUALITY?	
	DISSIPATION?	
	PHASE?	
	VOLTAGE?	
	CURRENT?	
	DEVIATION_RESULT?	

Responses for COM?

Dominant ; secondary parameter in Auto mode in accordance with the Auto Mode Decision Diagram, Section 3.5.1.1. If you have selected a certain parameter with the POSITION FIXED command, this parameter is shown at first, regardless of whether or not it is the dominant one.

```
L <NRf>  
L <NRf>;R <NRf>  
R <NRf>;L <NRf>  
R <NRf>  
R <NRf>:C <NRf>  
C <NRf>;R <NRf>  
C <NRf>
```

Response for selected parameter:

R <NRf>	for resistances in ohms
C <NRf>	for capacitances in farads
L <NRf>	for inductances in henrys
Z <NRf>	for impedances in ohms
Q <NRf>	for quality factor
D <NRf>	for dissipation factor
P <NRf>	for phase angle in degrees
V <NRf>	for measured voltage in volts
I <NRf>	for measured current in amperes
% <NRf>	for deviation

Exceeds a parameter of the component under test the measurement range, the response is OVER, or >, or <; for example:

C 22E-9;R OVER or Q>1000

3.5.1.9 Store/Recall of Instrument Settings

Nine complete instrument settings including trim data can be stored in nonvolatile registers 1 to 9; the measured values are not stored. Already existing data will be overwritten. Register 0 contains the current instrument settings.

Commands: Common Commands in accordance with IEEE-488.2

★SAV <NR1>

★RCL <NR1>

3.5.2 Binning

Binning means sorting components into separate boxes or containers to get tighter tolerances or match like values.

During binning with the PM6306, single items of similar components are allocated to defined sorting fields based on their measured value. These fields are called bins.

3.5.2.1 Programming of Bin Tolerances

You can define ten different bins (bin 0 to 9). The instrument checks in the sequence bin 1, bin 2 to bin 9 and then bin 0. If the greatest tolerance is programmed for bin 1, then all components lying within this tolerance are immediately allocated to bin 1.

A different parameter can be defined for bin 0 than that for bin 1 to bin 9.

For example, bins 1 to 9 can be used to check the tolerance of a capacitor while bin 0 checks its quality factor.

The test sequence for binning is as follows:

Component meets tolerance defined in:		Display
bin 1 to 9	bin 0	
YES	YES	bin 1 to 9
NO	do not care	FAIL
YES	NO	bin 0

In FAST measurement mode, bin 0 is ignored.

The limits of the bins can be defined in several ways according to various application requirements:

- Binning components with certain value according to different tolerance class, e.g., for quality control or incoming inspection.

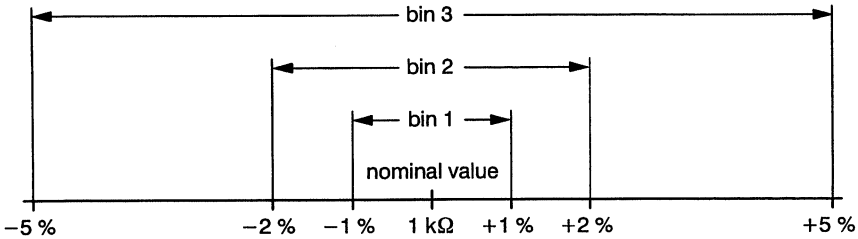

Nested limits with reference to a nominal value.

- Binning components according to certain values, e.g., resistors according to the series E12, here with $\pm 5\%$.

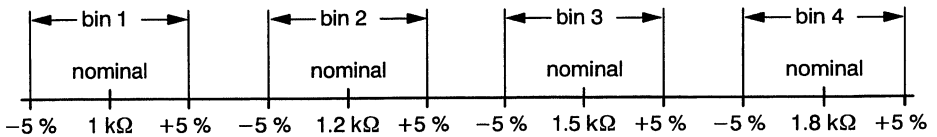

Sequential limits with reference to nominal values.

If limits overlap, a component lying within this overlapping area is always allocated to the bin with the lower number.

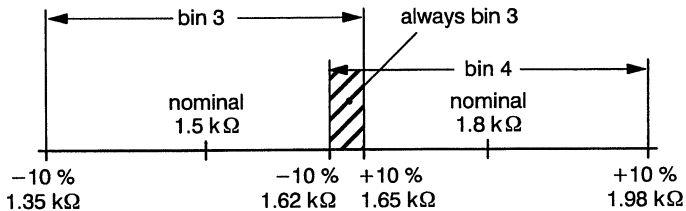

- Nested and sequential limits can be combined.

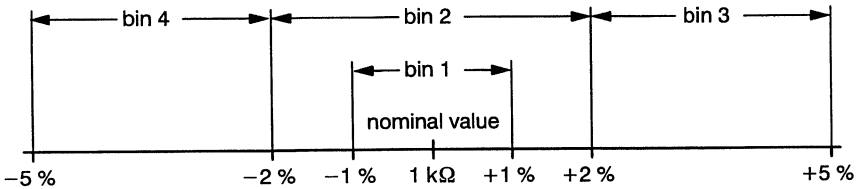

Sequential and nested limits.

The limits can be programmed directly as absolute values instead of a nominal value with an upper and lower limit in percent.

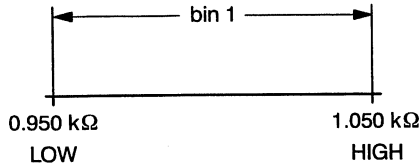

- Commands:
- BINNING_RELATIV** input with reference to a nominal value
 - BINNING_ABSOLUT** input of absolute values
 - LIMIT_LOW <NRf>** lower tolerance limit
 - LIMIT_HIGH <NRf>** upper tolerance limit
 - BIN <NR1>** defines the bin number which programmed values are valid for

Parameter for bins:

- RESISTANCE <NRf>** resistances in ohms
- CAPACITANCE <NRf>** capacitances in farads
- INDUCTANCE <NRf>** inductances in henrys
- IMPEDANCE <NRf>** impedance in ohms
- QUALITY <NRf>** quality factor
- DISSIPATION <NRf>** dissipation factor
- PHASE <NRf>** phase angle in degrees

<NRf> is necessary only when you are programming nominal values and tolerances in percent. For input of absolute LOW and HIGH LIMIT values, skip <NRf>.

Examples:

The following example shows a complete binning set for capacitors of 100 nF with tolerances of $\pm 0.5\%$, $\pm 1\%$, $\pm 2\%$, $\pm 3\%$, $\pm 4\%$, $\pm 5\%$, $\pm 6\%$, $\pm 7\%$, $\pm 10\%$, programmed with nominal value and tolerances in percent.

Bin 0 checks if the quality factor is within 300 to 600.

```

BIN_REL;CAP 100E-9;LIM_LO -.5;LIM_HI .5;BIN 1;
    LIM_LO -1;LIM_HI 1;BIN 2;
    LIM_LO -2;LIM_HI 2;BIN 3;
    LIM_LO -3;LIM_HI 3;BIN 4;
    LIM_LO -4;LIM_HI 4;BIN 5;
    LIM_LO -5;LIM_HI 5;BIN 6;
    LIM_LO -6;LIM_HI 6;BIN 7;
    LIM_LO -7;LIM_HI 7;BIN 8;
    LIM_LO -10;LIM_HI 10;BIN 9;
    QUAL 400;LIM_LO -25;LIM_HI +50;BIN 0 <LF>

```

Same values and tolerances are programmed with absolute values.

```

BIN_ABS;CAP;LIM_LO 99.5E-9;LIM_HI 100.5E-9;BIN 1;
    LIM_LO 99E-9;LIM_HI 101E-9;BIN 2;
    LIM_LO 98E-9;LIM_HI 102E-9;BIN 3;
    LIM_LO 97E-9;LIM_HI 103E-9;BIN 4;
    LIM_LO 96E-9;LIM_HI 104E-9;BIN 5;
    LIM_LO 95E-9;LIM_HI 105E-9;BIN 6;
    LIM_LO 94E-9;LIM_HI 106E-9;BIN 7;
    LIM_LO 93E-9;LIM_HI 107E-9;BIN 8;
    LIM_LO 90E-9;LIM_HI 110E-9;BIN 9;
BIN_ABS;QUAL;LIM_LO 300;LIM_HI 600;BIN 0; <LF>

```

3.5.2.2 Store/Recall of Bin Sets

Nine complete bin records (bins 0 to 9), including selected instrument settings can be stored into registers 1 to 9 of the instrument. Storage register 0 contains the bin set for current binning. These registers are independent of those mentioned in Section 3.5.1.8.

Commands:	BINNING_STORE <NR1>	stores binning set into selected register (1 to 9)
	BUFFER_RECALL <NR1>	loads binning set from selected register into a buffer for editing
	BINNING_RECALL <NR1>	transfers binning set from selected register into register 0 for binning
	BUFFER_CLEAR	deletes buffer for editing
	BINNING_ERASE <NR1>	deletes binning set of selected register
Query:	BINNING_SET? <NR1>	asks for the complete bin set of selected register
Response:	BIN_REL;RESI 1E3;LIM_LO -5;LIM_HI 5;BIN 1; LIM_LO -10;LIM_HI 10;BIN 2; LIM_LO -15;LIM_HI 15;BIN 3; LIM_LO	
Query:	BUFFER_BIN? <NR1>	asks for the selected bin in the buffer for editing
Response:	e.g. LIM_LO -10;LIM_HI 10; BIN 2	

3.5.2.3 Operation Mode Binning

Select desired bin set and transfer it into register 0 for binning.

If you do not need all the bins for sorting, you can disable bins not needed, except bin 1. To do this, load the set into the buffer for editing, disable the bins, and load the set into register 0.

Storage Registers

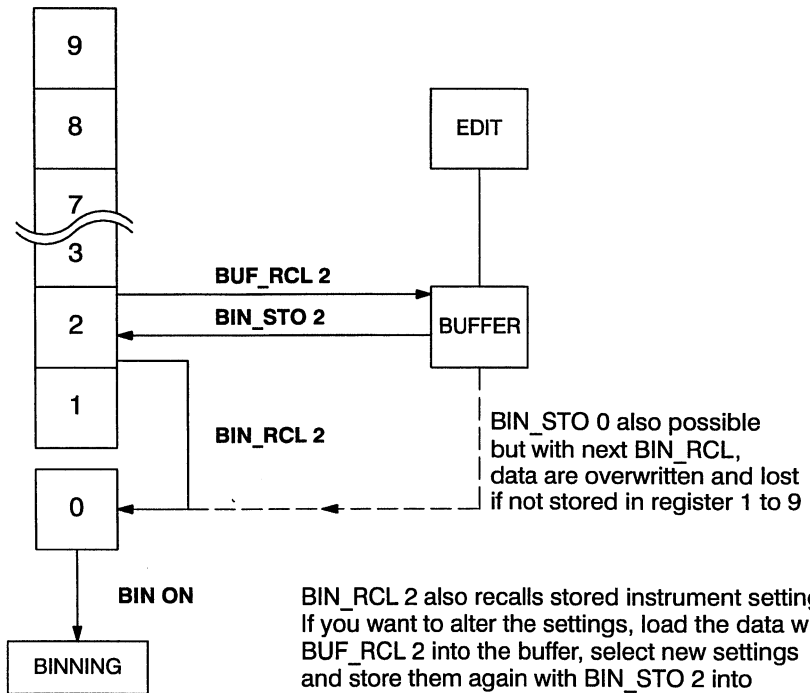

Commands: **BINNING ON**
BINNING OFF

BIN_DISABLE <NR1>

BIN_ENABLE <NR1>

Fixture Set

If you use measuring leads, you should take into account the additional capacitance between the LOW contacts (drive– and sense–) and circuit ground potential, especially at test signal frequencies > 20 kHz.

Commands: **SET_FIXTURE** <NR1> NR1 = 0 for <50 pF
 1 for 50 to 150 pF
 2 for 150 to 250 pF
 3 for 250 to 350 pF
 4 for 350 to 450 pF
 5 for 450 to 550 pF
 6 for 550 to 650 pF
 7 for 650 to 750 pF
 8 for 750 to 850 pF
 9 for 850 to 950 pF
 10 for 950 to 1050 pF

Query: **SET_FIXTURE?**

Response: SET_FIXTURE <NR1>

Range Hold

When you measure components, the instrument checks voltage and current and internally selects an appropriate gain factor. If you measure similar components with slightly different values, perform one measurement and set the instrument to Range Hold. This prevents the instrument from setting a new gain factor for each component.

Range Hold increases the measurement speed because the instrument no longer needs to check current and voltage for selecting the gain factor. Range Hold is particularly valuable in the Fast Measurement Mode (Section 3.5.1.7).

Commands: **RANGE_HOLD ON**
 RANGE_HOLD OFF

Query: **RANGE_HOLD?**

Response: RNG_HOLD ON
 RNG_HOLD OFF

RANGE_HOLD ON is applicable only in SINGLE mode.

After receiving one of the following commands, the instrument automatically returns to RANGE_HOLD OFF:

TRIM, BIN ON, BIN OFF, BIN_RCL <NR1>, *RCL, TEST_SIG DC, TEST_SIG AC, DC_LEV <NRf>, AC_LEV <NRf>, or FRE <NRf>.

Calibration

The instrument was calibrated in the factory prior to shipment.

The calibrating data are stored in an EEPROM and are referenced for each measurement.

It is necessary to calibrate again after loss of data (replacing the EEPROM), after changing components during repair which influence the measuring results, or when the instrument does not meet the technical specifications.

In normal operation recalibration once a year is sufficient.

Details on calibration can be found in the SERVICE MANUAL.

Query: **CALIBRATE?**

Response: CAL OFF (means calibration data not valid or lost)
 CAL ON;YY/MM/DD

YY/MM/DD = Year/Month/DAY
 is the date of last calibration

Chapter **4**

PROGRAMMING EXAMPLES

4 PROGRAMMING EXAMPLES

The following examples are related to an IBM-compatible PC. The first one uses a built-in IEEE-488 interface, the second one uses the standard serial port of the controller and the RS-232 interface. You should have a basic knowledge of the MS-DOS operating system of the controller and the programming language QuickBasic (version 4.0 and above) to understand the examples that follow. The programs allow you to input commands via the controller keyboard and send them to the RCL meter via the interface.

▪ Example for the IEEE-488 interface:

```

DECLARE SUB SendCmd (WR$)
DECLARE SUB SendStr (WR$)
DECLARE SUB ErrChk (Cs!, Sts%)
REM $INCLUDE: 'qbdecl4.bas'

CLS
PRINT " "
PRINT " "
PRINT "          ***** DEMO PROGRAM FOR PM6306 *****"
PRINT
PRINT "          PRESS 'RETURN' TO CONTINUE "
PRINT
PRINT "          To leave running program type 'END' or 'end' "
BEEP
PRINT
B$ = ""
DO
    B$ = INKEY$
LOOP UNTIL B$ = CHR$(13)

CLS
Stp = 0
BDNAME$ = "RCL1"
CALL IBFIND(BDNAME$, RCL%)
CALL ErrChk(1, RCL%)

IF Stp = 0 THEN
    CALL IBCLR(RCL%)
    CALL ErrChk(2, IBSTA%)

IF Stp = 0 THEN
    A$ = "**ese 255"
    CALL SendCmd(A$)

    A$ = "**cls"
    CALL SendCmd(A$)

    A$ = "**IDN?"
    CALL SendStr(A$)

```

```

        WHILE Stp = 0
            INPUT "COMMAND : ", A$ 'reading keyboard input
            IF A$ = "END" OR A$ = "end" THEN
                CALL IBLOC(RCL%) 'set instrument to 'LOCAL'
                CLS 'clear screen
                Stp = 1
            ELSE
                CALL SendStr(A$) 'send command string
            END IF
            PRINT
            PRINT
        WEND
    END IF
END

SUB ErrChk (Cs, Sts%) 'Error handler
    SHARED Stp
    SELECT CASE Cs
        CASE 1
            IF Sts% < 0 THEN
                PRINT
                PRINT
                PRINT "IBFIND ERROR"
                PRINT "Check the configuration of the bus interface with
IBCONF.EXE"
                PRINT
                Stp = 1 'terminate program
            END IF
            CASE 2
                IF Sts% < 0 THEN
                    PRINT
                    PRINT
                    PRINT " BUS ERROR!"
                    PRINT
                    PRINT " Please check connections and start program again"
                    PRINT
                    Stp = 1 'terminate the program
                END IF
            CASE 3
                IF Sts% < 0 THEN
                    PRINT
                    PRINT
                    PRINT "GPIB ERROR"
                    PRINT
                END IF
                IF Sts% > 16383 THEN
                    PRINT
                    PRINT
                    PRINT "TIME OUT ERROR"
                    PRINT
                END IF
            END SELECT
    END SUB

```



```

SUB SendCmd (WR$)
'Send command string to instrument via GPIB without response
SHARED RCL%
CALL IBWRT(RCL%, WR$)           'output command string
CALL ErrChk(3, IBSTA%)         'check error
END SUB

SUB SendStr (WR$)
'Send command string to instrument via GPIB with response
SHARED RCL%
qry = 0                         'query flag
qer = 0                         'error query flag
CALL IBWRT(RCL%, WR$)         'output command string

IF IBSTA% < 0 THEN
CALL ErrChk(3, IBSTA%)         'check error
ELSE
Stat = 0
CALL IBRSP(RCL%, Stat%)       'get status byte from instrument
CALL ErrChk(3, IBSTA%)         'check error
IF (Stat% AND 16) THEN        'checks whether MAV is set
qry = 1
END IF
IF (Stat% AND 32) THEN        'checks whether ESB is set
BEEP
WR$ = "err?"                   'error query
CALL IBWRT(RCL%, WR$)         'output command string
qry = 1
qer = 1
END IF
END IF

IF INSTR(WR$, "?") > 0 OR qry = 1 THEN 'check if query command
MaxLen = 164                   'max. length of response string
RD$ = SPACE$(MaxLen)           'clear response string
CALL IBRD(RCL%, RD$)           'get response string
IF IBSTA% < 0 THEN
CALL ErrChk(3, IBSTA%)         'check error
ELSE
PRINT
PRINT "RESPONSE : " + RD$      'response string
IF qer = 1 THEN
WR$ = "**cls"                   'clear status register
CALL IBWRT(RCL%, WR$)         'output command string
END IF
END IF
END IF
END SUB

```

▪ Example for the RS-232 interface:

```

DECLARE SUB SndCmd (WR$)
DECLARE SUB SndMsg (WR$)
DECLARE FUNCTION ChkCmd$ (WR$)
DECLARE SUB ClrBuf (COMFILE)
DECLARE FUNCTION IniPrg (COMFILE)
DECLARE FUNCTION RecMsg$ (COMFILE)
DECLARE SUB SetDTR (Cnt)

COMMON SHARED COMFILE, MCREG, Chk
COMFILE = 1 'file buffer handle
MCREG = IniPrg(COMFILE) 'inilize program
Stp = 0
WHILE (Stp = 0)
  SEND$ = CHR$(27) + "2"
  CALL SndCmd(SEND$) 'send goto remote
  SEND$ = "*cls;*ese 255"
  CALL SndCmd(SEND$) 'send status clear
  SEND$ = "*idn?"
  CALL SndCmd(SEND$) 'send identifikation query
  REC$ = RecMsg$(COMFILE) 'get identifikation
  IF LEN(REC$) = 0 THEN 'if buffer empty
    PRINT
    PRINT "No answer! Please check the connection and setting!"
    CLOSE COMFILE
    Stp = 1
  ELSE
    CLS
    PRINT "connected instrument : "; REC$ 'display identity string
    PRINT
  END IF
'
'***** main loop *****
WHILE (Stp = 0)
  PRINT
  PRINT
  LINE INPUT "COMMAND : "; SEND$ 'command input
  SEND$ = ChkCmd(SEND$) 'checks the command
  IF Chk = 0 THEN
    SEND$ = CHR$(27) + "1"
    CALL SndCmd(SEND$) 'sets instrument to local
    CLOSE COMFILE
    Stp = 1
    CLS
  ELSE
    CALL SndMsg(SEND$) 'send message
  END IF
WEND
WEND
END

```

```

FUNCTION ChkCmd$ (WR$)
  ***** command check *****
  Chk = 2
  IF LEN(WR$) = 3 THEN
    IF WR$ = "END" OR WR$ = "end" THEN Chk = 0
    IF WR$ = "GTL" OR WR$ = "gtl" THEN WR$ = CHR$(27) + "1"
    IF WR$ = "GTR" OR WR$ = "gtr" THEN WR$ = CHR$(27) + "2"
    IF WR$ = "DCL" OR WR$ = "dcl" THEN WR$ = CHR$(27) + "4"
    IF WR$ = "LLO" OR WR$ = "llo" THEN WR$ = CHR$(27) + "5"
    IF WR$ = "dtr" OR WR$ = "DTR" THEN WR$ = CHR$(27) + "8"
    IF WR$ = "STB" OR WR$ = "stb" THEN
      WR$ = CHR$(27) + "7"
      Chk = 3
    END IF
  ELSE
    'no special command
    Chk = 1
    WR$ = WR$ + CHR$(10)
    'append terminator
  END IF
  ChkCmd$ = WR$
END FUNCTION

SUB ClrBuf (COMFILE)
  ***** clear buffer *****
  CALL SetDTR(1)
  WHILE (LOC(COMFILE) > 0)
    C$ = INPUT$(1, #COMFILE)
    CALL SetDTR(1)
  WEND
END SUB

FUNCTION IniPrg (COMFILE)
  CLS
  PRINT " *****"
  PRINT " ***** Demonstration program for PM6306 *****"
  PRINT " ***** with RS-232 interface *****"
  PRINT " *****"
  PRINT
  PRINT
  PRINT "***** list of special commands *****"
  PRINT "Special commands : "
  PRINT
  PRINT "          GTL : go to local"
  PRINT "          GTR : go to remote"
  PRINT "          DCL : device clear"
  PRINT "          LLO : local lock out"
  PRINT "          STB : get status byte"
  PRINT "          DTR : device trigger"
  PRINT
  PRINT
  PRINT "To leave running programm type 'END' "
  PRINT
  PRINT
  PRINT "          press a key to continue ";
  C$ = ""
  WHILE (C$ = "")
    C$ = INKEY$
  WEND
  CLS

```

```

PRINT
'***** Enviroment : IBM AT or Compatible *****
'***** Initialisation of PM6304 / serial interface *****
PRINT "           Please set the RS-232 interface parameters of the PM6304 to : "
PRINT "           Mode       : CCommunication "
PRINT "           Baudrate    : 9600"
PRINT "           Parity       : off"
PRINT "           Data         : 8"
PRINT "           Handshake    : on"
PRINT "           Wire         : 7"
PRINT
PRINT
'
'***** Initialisation of PC communication port *****
PRINT "           Which communication port of the PC do you use ?"
PRINT
PRINT "           COM1    [1]"
PRINT "           COM2    [2]           please select "
PRINT
PORT = 0
WHILE (PORT = 0)
  C$ = INKEY$ 'get key code
  IF C$ = "1" THEN PORT = 1
  IF C$ = "2" THEN PORT = 2
WEND
MCREG = &H3FC
IF PORT = 2 THEN MCREG = &H2FC 'modem control register address
SER$ = "COM" + CHR$(48 + PORT) + ":9600,N,8,1,CS,DS,CD,RS"
OPEN SER$ FOR RANDOM AS #COMFILE
WIDTH #COMFILE, 255
CALL ClrBuf(COMFILE) 'clear input buffer
IniPrg = MCREG
END FUNCTION

FUNCTION RecMsg$(COMFILE)
'***** receive message from instrument *****
Del = 1 'communication delay
REC$ = "" 'clear response string
DO
  TR! = TIMER 'start timeout timer
  DO
    IF TIMER < TR! THEN TR! = TR! - 86400! 'adjust 24.00h
  LOOP UNTIL (LOC(COMFILE) > 0) OR (TIMER - TR! > Del)

  IF LOC(COMFILE) = 0 THEN 'if there no characters
    PRINT "**** receive timeout ****"
    Stp = 1
  ELSE
    C$ = INPUT$(1, #COMFILE) 'read one character
    CALL SetDTR(1) 'set DTR on
    IF NOT C$ = CHR$(10) THEN
      REC$ = REC$ + C$ 'append character
    END IF
  END IF
LOOP UNTIL ((C$ = CHR$(10)) OR (Stp = 1))
RecMsg$ = REC$
END FUNCTION

```

```

SUB SetDTR (Cnt)
'***** buffer size check *****
IF Cnt = 0 THEN
'if input buffer becomes full then reset DTR to stop transmission
  IF LOC(COMFILE) > 200 THEN
    OUT MCREG, INP(MCREG) AND 254          'set DTR off
  END IF
ELSE
'if input buffer has enough space then continue transmission
  IF LOC(COMFILE) < 100 THEN
    OUT MCREG, INP(MCREG) OR 3            'set DTR on
  END IF
END IF
END SUB

```

```

SUB SndCmd (WR$)

'***** send command to instrument *****
IF NOT LEFT$(WR$, 1) = CHR$(27) THEN
  WR$ = WR$ + CHR$(10)                    'append terminator
END IF
PRINT #COMFILE, WR$;                      'send command string
END SUB

```

```

SUB SndMsg (WR$)
PRINT #COMFILE, WR$;                      'send command string

T1 = TIMER
WHILE (T1 + .1 > TIMER)                   'delay 100ms
WEND
IF (INSTR(WR$, "?") > 0) OR Chk = 3 THEN  'if a query
  REC$ = RecMsg$(COMFILE)                 'get response message
  PRINT
  PRINT "RESPONSE : "; REC$
END IF
WR$ = CHR$(27) + "7"
CALL SndCmd(WR$)                           'sends get status byte
Sts% = VAL(RecMsg$(COMFILE))
IF (Sts% AND 32) THEN                       'checks wether ESB is set
  BEEP
  WR$ = "err?"
  CALL SndCmd(WR$)                         'sends command
  REC$ = RecMsg$(COMFILE)
  PRINT
  PRINT " ERROR : "; REC$
  WR$ = "*cls"
  CALL SndCmd(WR$)                         'clear status register
END IF
END SUB

```

Chapter **5**

PRINTING OF MEASUREMENT RESULTS

5 PRINTING OF MEASUREMENT RESULTS

The PM6306 RCL Meter can send measurement results directly to a printer without any special program or PC.

- Select an appropriate measurement setup; select required instrument settings for measurement.
- Set the interface configuration in accordance with your printer, see Chapter 2.1, and refer to your printer manual if necessary.
- Connect the PM6306 to the printer via the RS-232 cable as shown on Page 5 – 3.
- Set the Operating Mode of the interface to Printer Mode (**Pr**) by pressing the **INTERFACE** key and using the rotary knob. The instrument is automatically set to single measurement mode.

Function and Key Operation

Display

INTERFACE

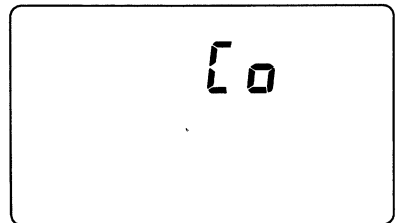

INTERFACE

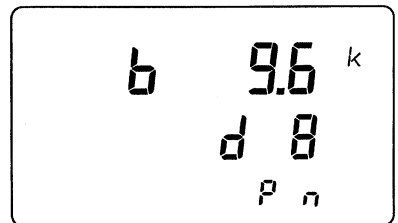

display shows
current configuration

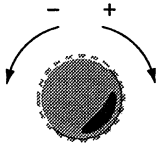
Function and Key Operation**Display****INTERFACE**

select printer mode

[0]

Pr

If you do not press the **INTERFACE** key within 3 seconds, the instrument returns automatically to measurement mode, the altered settings are not stored.

Press the **INTERFACE** key to step completely through the menus, and select the required settings by turning the rotary knob (see Section 2.1) until the normal display appears.

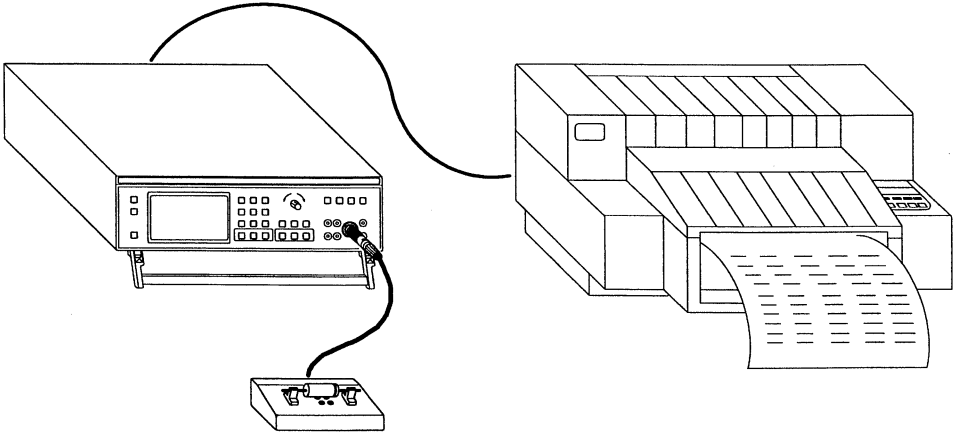

Connection cable

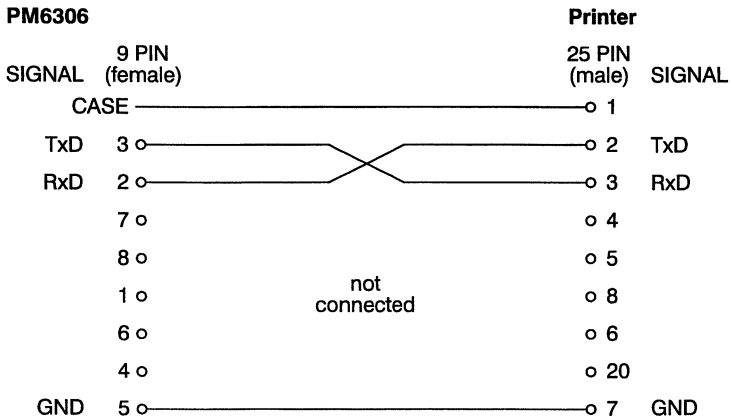

Xon/Xoff software handshake must be switched on.

- The printer prints the first header line.
- Insert a component and press the **TRIGGER** key to start a measurement.
- The printer prints the second header line and the measurement result.
- Insert a different component, and press the **TRIGGER** key.
- The printer prints the result, etc.

Example of a print:

PM6306 RCL METER : TEST PROTOCOL							FLUKE
NO	DOMINANT	SECOND	CIRCUIT	MODE	FREQ	LEVEL	BIAS
1	C=10.046 nF	R=78.67 kOhm	Par	Auto	1.0kHz	1.00V	Off
2	C=10.454 nF	R=3.066 kOhm	Ser	Ser	1.0kHz	1.00V	Off
3	C=10.046 nF	Z=15.53 kOhm	Par	Par	1.0kHz	1.00V	Off
4	C=10.047 nF	p=-78.7 H	Par	Par	1.0kHz	1.00V	Off
5	C=10.047 nF	D=.201	Par	Par	1.0kHz	1.00V	Off
6	C=10.047 nF	Q=4.97	Par	Par	1.0kHz	1.00V	Off
7	C=10.068 nF	R=78.93 kOhm	Par	Auto	2.0kHz	1.00V	Off
8	C=10.068 nF	R=79.06 kOhm	Par	Auto	3.0kHz	1.00V	Off
9	C=10.068 nF	R=79.06 kOhm	Par	Auto	4.0kHz	1.00V	Off
10	C=10.068 nF	R=79.23 kOhm	Par	Auto	5.0kHz	1.00V	Off
11	C=10.068 nF	R=78.95 kOhm	Par	Auto	6.0kHz	1.00V	Off
12	C=10.067 nF	R=78.85 kOhm	Par	Auto	700kHz	1.00V	Off
13	C=10.067 nF	R=79.06 kOhm	Par	Auto	8.0kHz	1.00V	Off
14	C=10.066 nF	R=79.14 kOhm	Par	Auto	9.0kHz	1.00V	Off
15	C=10.065 nF	R=79.04 kOhm	Par	Auto	10.0kHz	1.00V	Off
16	R=78.953 kOhm	----	----	----	DC	1.00V	----
17	C=515.67 uF	R=54.57 Ohm	Par	Auto	100Hz	1.00V	5.0V
18	C=517.48 uF	R=.1733 Ohm	Ser	Ser	100Hz	1.00V	5.0V
19	C=465.0 uF	R=1.137 Ohm	Par	Auto	1.0kHz	1.00V	5.0V
20	C=515.83 uF	Z=3.081 Ohm	Par	Par	100Hz	1.00V	5.0V
21	R=1.3817 Ohm	----	----	Auto	1.0kHz	1.00V	Off
22	R=1.3209 Ohm	----	----	Auto	1.0kHz	1.00V	Off
23	R=1.1934 Ohm	L=-13.6	Ser	Auto	1.0kHz	1.00V	Off
24	R=1.1955 Ohm	----	----	Auto	1.0kHz	1.00V	Off
25	R=1.3378 Ohm	----	----	Auto	1.0kHz	1.00V	Off

To leave the Printer Mode press the **INTERFACE** key to set the PM6306 to Communication Mode and turn the rotary knob.

Chapter **6**

ERROR MESSAGES

6 ERROR MESSAGES

After receiving the query **ERR?** the instrument generates a response message with an error number and an error description in clear text, which can be read in by the controller.

Error Messages	see
ERROR 0/NO ERROR	
ERROR 101/PROM CHECKSUM ERROR	SM
ERROR 102/INTERNAL RAM ERROR	SM
ERROR 103/EXTERNAL RAM ERROR	SM
ERROR 104/BACKUP ERROR	SM
ERROR 105/EXTERNAL MEMORY ERROR	SM
ERROR 106/EXTERNAL MEMORY ERROR	SM
ERROR 107/EEPROM ERROR	SM
ERROR 108/EEPROM ERROR ADJ. DATA	SM
ERROR 109/EEPROM ERROR CAL. DATA	SM
ERROR 110/HARDWARE ERROR	SM
ERROR 111/HARDWARE ERROR	SM
ERROR 112/DISPLAY ERROR	SM
ERROR 113/TIME OUT ERROR	
ERROR 114/ERROR DURING TRIMMING	UM, Section 4.3
ERROR 115/TRIMMING RESISTANCE OUT OF RANGE	UM, Section 4.3
ERROR 117/OVERLOADED	UM, Section 4.7
ERROR 118/BINNING SET IS EMPTY	PM, Section 3.5.2
ERROR 119/CONTACT CHECK ERROR	UM, Section 4.4
ERROR 120/CALIBRATION ERROR	SM
ERROR 121/ILLEGAL CALIBRATION NUMBER	SM

PM = Programming Manual

SM = Service Manual

UM = Users Manual

Error Messages**see**

ERROR 140/NO VALID REFERENCE	SM
ERROR 141/REFERENCE OUT OF RANGE	SM
ERROR 142/ILLEGAL REGISTER ADDRESS	PM, Section 3.5.1.9
ERROR 143/ILLEGAL BINNING NUMBER	PM, Section 3.5.2.2
ERROR 144/DATA INCOMPLETE	PM, Section 3.5.2.1
ERROR 145/BINNING SET IS EMPTY	PM, Section 3.5.2.1
ERROR 146/BINNING SET IS NOT CONSISTENT	PM, Section 3.5.2.1
ERROR 147/BIN IS EMPTY	PM, Section 3.5.2.1
ERROR 150/SYNTAX ERROR	PM, Section 3.1
ERROR 151/ILLEGAL HEADER	PM, Chapter 7
ERROR 152/BODY SYNTAX ERROR	PM, Chapter 7
ERROR 153/DATA OUT OF RANGE	UM, Appendix 6A.2
ERROR 154/NO QUERY HEADER	PM, Chapter 7
ERROR 155/NO OUTPUT DATA AVAILABLE	PM, Section 3.3
ERROR 156/OUTPUT DATA DESTROYED	PM, Section 3.3
ERROR 158/TIME OUT	
ERROR 159/VALUE OUT OF RANGE	SM
ERROR 161/RESISTANCE OUT OF RANGE	PM, Sections 3.5.2.1, 3.5.17
ERROR 162/CAPACITANCE OUT OF RANGE	PM, Sections 3.5.2.1, 3.5.17
ERROR 163/INDUCTANCE OUT OF RANGE	PM, Sections 3.5.2.1, 3.5.17
ERROR 164/IMPEDANCE OUT OF RANGE	PM, Sections 3.5.2.1, 3.5.17
ERROR 165/QUALITY OUT OF RANGE	PM, Sections 3.5.2.1, 3.5.17
ERROR 166/DISSIPATION OUT OF RANGE	PM, Sections 3.5.2.1, 3.5.17
ERROR 167/PHASE OUT OF RANGE	PM, Sections 3.5.2.1, 3.5.17
ERROR 168/DC MEASURE NOT AVAILABLE	PM, Section 3.5.1.5
ERROR 169/NO TRIGGER POSSIBLE	PM, Section 3.5.1.7
ERROR 170/ILLEGAL PARAMETER	PM, Chapter 7
ERROR 171/FREQUENCY OUT OF RANGE	PM, Section 3.5.1.5
ERROR 172/FREQUENCY OUT OF RANGE	PM, Section 3.5.1.5
ERROR 173/FREQUENCY CORRECTED	PM, Section 3.5.1.7
ERROR 174/DC-BIAS NOT POSSIBLE	PM, Section 3.5.1.6
ERROR 175/NO CONTINUOUS MODE IN FAST	PM, Section 3.5.1.7

PM = Programming Manual

SM = Service Manual

UM = Users Manual

Error Messages**see**

ERROR 176/NO CHANGE IN BINNING MODE	PM, Section 3.5.2
ERROR 177/LEAVE BINNING MODE FIRST	PM, Section 3.5.2.3
ERROR 178/LEAVE CALIBRATION MODE FIRST	SM
ERROR 179/NO RANGE HOLD IN CONT. MODE	PM, Section 3.5.3
ERROR 180/NO AVERAGE IN FAST MODE	PM, Section 3.5.1.7
ERROR 181/ILLEGAL AVERAGE NUMBER	PM, Section 3.5.3
ERROR 182/ILLEGAL FIXTURE NUMBER	PM, Section 3.5.3
ERROR 183/NO VALID DATA	PM, Section 3.5.1.7
ERROR 184/TEST VOLTAGE OUT OF RANGE	PM, Section 3.5.1.5
ERROR 185/BIAS VOLTAGE OUT OF RANGE	PM, Section 3.5.1.6
ERROR199/UNKNOWN ERROR	

PM = Programming Manual

SM = Service Manual

UM = Users Manual

Chapter **7**

COMMANDS IN ALPHABETICAL ORDER

7 COMMANDS IN ALPHABETICAL ORDER

7.1 COMMON COMMANDS AND QUERIES (IEEE-488.2)

Command/Query	Description	Page
★CLS	Sets 'Standard Event Status Register' and 'Status Register' to zero	3 – 7
★ESE <NRf>	'Standard Event Status Enable' Command	3 – 7
★ESE?	'Standard Event Status Enable' Query	3 – 7
★ESR?	Reads 'Standard Event Status Register'	3 – 7
★IDN?	Identification Query	3 – 4
★LRN?	Learn Device Setup Query	3 – 4
★OPC	'Operation Complete' Command	3 – 5
★OPC?	'Operation Complete' Query	3 – 6
★RCL 1...9	Recall Command	3 – 8 / 20
★RST	Reset Command	3 – 4
★SAV 1...9	Save Command	3 – 8 / 20
★SRE <NRf>	'Service Request Enable' Command	3 – 7
★SRE?	'Service Request Enable' Query	3 – 7
★STB?	Reads Status Byte	3 – 8
★TRG	Trigger Command	3 – 7
★TST?	Self-test Query	3 – 5
★WAI	Wait-to-Continue Command	3 – 6

7.2 DEVICE SPECIFIC COMMANDS

7.2.1 Settings and Measurements

Command/Query	Description	Page
AC_LEV <NRf>	Sets AC test signal level 0.05 to 2 V	3 – 14
AC_LEV?	Asks for AC test signal level	3 – 14
AUTO	Automatic measurement mode	3 – 9
AVG <NR1 >	Sets averaging factor 1, 2, or 3	3 – 27
AVG OFF	Normal averaging	3 – 27
AVG?	Asks for averaging factor	3 – 27
BIAS_VOL <NRf>	Sets internal DC bias voltage up to 10 V	3 – 14
BIAS_VOL?	Asks for DC bias voltage	3 – 14
CAL?	Asks for last valid calibration	3 – 30
CAP?	Asks for capacitance value	3 – 19
COM?	Asks for dominant/secondary parameter	3 – 19
CONTA_CHE	Starts contact check	3 – 12
CONTI	Continuous measurement	3 – 15
CUR?	Asks for measured current	3 – 19
DC_BIAS?	Asks for DC bias	3 – 14
DC_BIAS EXT	External DC bias	3 – 14
DC_BIAS INT	Internal DC bias	3 – 14
DC_BIAS OFF	No DC bias	3 – 14
DC_LEV <NRf>	Sets DC test signal level 0.05 to 2 V	3 – 14
DC_LEV?	Asks for DC test signal level	3 – 14
DEV ON	Switches DEVIATION measurement on	3 – 18
DEV OFF	Switches DEVIATION measurement off	3 – 18
DEV?	Asks if DEVIATION measurement is on or off	3 – 18
DEV_RES?	Asks for deviation in percent	3 – 18
DISS?	Asks for dissipation factor value	3 – 19
ERR?	Asks for error messages	6 – 1

Command/Query	Description	Page
FRE <NRf>	Sets test signal frequency	3 – 13
FRE?	Asks for test signal frequency	3 – 13
IMP?	Asks for impedance value	3 – 19
INDU?	Asks for inductance value	3 – 19
MEA_FAST?	Asks for fast measurement mode	3 – 16
MEA_FAST OFF	Fast measurement off	3 – 16
MEA_FAST ON	Fast measurement on	3 – 16
MODE?	Asks for measuring mode	3 – 10
PHA?	Asks for phase angle value	3 – 19
PARAL	Sets parallel measurement mode	3 – 10
PARAM?	Asks for selected parameter	3 – 11
PARAM AUTO	Sets measurement selected before	3 – 11
PARAM CUR	Current is displayed	3 – 11
PARAM DISS	Dissipation factor is displayed	3 – 11
PARAM IMP	Impedance is displayed	3 – 11
PARAM PHA	Phase angle is displayed	3 – 11
PARAM QUA	Quality factor is displayed	3 – 11
PARAM VOL	Voltage is displayed	3 – 11
POS_FIX?	Asks for fixed parameter	3 – 17
POS_FIX R	Fixes to resistance	3 – 17
POS_FIX C	Fixes to capacitance	3 – 17
POS_FIX L	Fixes to inductance	3 – 17
POS_FIX CL	Fixes to capacitances or inductances	3 – 17
POS_FIX OFF	Switches the function off	3 – 17
POS_FIX ON	Switches the function on	3 – 17
QUAL?	Asks for quality factor value	3 – 19

Command/Query	Description	Page
REF_CAP <NRf>	Sets capacitance reference value	3 – 18
REF_INDU <NRf>	Sets inductance reference value	3 – 18
REF_RESI <NRf>	Sets resistance reference value	3 – 18
REF?	Asks for reference	3 – 18
RESI?	Asks for resistance value	3 – 19
RNG_HOLD?	Asks for hold function	3 – 29
RNG_HOLD OFF	Internal gain factor is automatically determined	3 – 29
RNG_HOLD ON	Internal gain factor is fixed	3 – 29
SER	Sets serial measuring mode	3 – 10
SET_FIX <NR1>	Sets correction factor for ground capacitance	3 – 28
SET_FIX?	Asks for correction factor	3 – 28
SET_REF	Sets current parameter and value for reference	3 – 18
SIN	Single measurement	3 – 15
TEST_SIG?	Asks for test signal	3 – 13
TEST_SIG AC	AC test signal	3 – 13
TEST_SIG DC	DC test signal	3 – 13
TRIG	Starts single measurement	3 – 16
TRIG?	Asks for single or continuous measurement	3 – 15
TRIM ALL	Performs Automatic Zero Trim	3 – 12
TRIM SINGLE	Performs Automatic Zero Trim only at selected frequency	3 – 12
TRM <NR1>	Defines message terminator	3 – 1
VOL?	Asks for voltage value	3 – 19

7.2.2 Commands for Binning

Command/Query	Description	Page
BIN <NR1>	Allocates data to bins 0 to 9	3 – 23
BIN?	Asks for the bin the component is allocated to	3 – 27
BIN OFF	Normal measuring mode	3 – 26
BIN ON	Binning mode	3 – 26
BIN_ABS	Input of absolute values	3 – 23
BIN_DISABL <NR1>	Disables selected bin	3 – 26
BIN_ENABL <NR1>	Enables selected bin	3 – 26
BIN_ERA <NR1>	Deletes selected bin set	3 – 25
BIN_RCL <NR1>	Loads bin set into register 0	3 – 25
BIN_REL	Input of tolerances in percent	3 – 23
BIN_SET? <NR1>	Asks for selected bin set	3 – 25
BIN_STO <NR1>	Stores bin set into register 1 to 9	3 – 25
BUF_BIN? <NR1>	Asks for the selected bin from the buffer for editing	3 – 25
BUF_CLR	Deletes buffer for editing	3 – 25
BUF_RCL <NR1>	Loads selected bin set into buffer for editing	3 – 25
CAP	Capacitance; absolute	3 – 23
CAP <NRf>	Capacitance; nominal	3 – 23
DISS	Dissipation factor; absolute	3 – 23
DISS <NRf>	Dissipation factor; nominal	3 – 23
IMP	Impedance; absolute	3 – 23
IMP <NRf>	Impedance; nominal	3 – 23
INDU	Inductance; absolute	3 – 23
INDU <NRf>	Inductance, nominal	3 – 23
LIM_HI <NRf>	Upper tolerance limit	3 – 23
LIM_LO <NRf>	Lower tolerance limit	3 – 23

Command/Query	Description	Page
PHA	Phase angle; absolute	3 – 23
PHA <NRf>	Phase angle; nominal	3 – 23
QUA	Quality factor; absolute	3 – 23
QUA <NRf>	Quality factor; nominal	3 – 23
RESI	Resistance; absolute	3 – 23
RESI <NRf>	Resistance; nominal	3 – 23

If you wish, you can note down your programmed settings for binning in this table. Please make your own copies if necessary.

Register No. <input type="checkbox"/> 1 <input type="checkbox"/> 2 <input type="checkbox"/> 3 <input type="checkbox"/> 4 <input type="checkbox"/> 5 <input type="checkbox"/> 6 <input type="checkbox"/> 7 <input type="checkbox"/> 8 <input type="checkbox"/> 9			
Bins	LOW LIMIT	Nominal Value	HIGH LIMIT
Bin 1			
Bin 2			
Bin 3			
Bin 4			
Bin 5			
Bin 6			
Bin 7			
Bin 8			
Bin 9			
Bin 0			

Instrument Settings

Measuring Mode: AUTO SERIAL PARALLEL

Measuring: DEV Q D Z Φ

Test Signal Frequency _____ Hz/kHz/MHz

Test Signal Voltage AC ____ V DC ____ V

DC BIAS: INT ____ V EXT ____ V

Used for: _____

