

Programmable Frequency Counters

PM6685 & PM6685R

Operators Manual

Table of Contents

Warranty Statement I-V

1 Preface

Introduction 1-2
Design Innovations 1-2
New fast SCPI Bus 1-4
Rubidium Counter 1-4

2 Safety Instructions

Introduction 2-2
Safety precautions 2-2

3 Preparation for Use

Unpacking 3-2
Installation 3-2

4 Using the Controls

About This Chapter 4-2
The User Interface 4-2
Default Settings 4-3
Basic controls 4-4
Input A controls 4-5
Measurement control keys 4-6
Display controls 4-7
. 4-7
Display 4-8
Display 4-9
Rear Panel 4-10
Rear Panel 4-11
PM6685R Front Panel 4-12

4822 872 20033
July 2001 Fifth Edition

5 Input Signal Conditioning

Introduction to this chapter 5-2
Input A 5-2
Input C 5-6
Reducing Noise and Interference 5-6

6 Measuring Functions

Introduction to this chapter 6-2
Selecting function 6-2
Frequency **6-3**
Introduction 6-3
Burst Frequency and PRF 6-6
AM Signals 6-10
Period **6-12**
Introduction 6-12
Pulse Width and Duty Factor **6-13**
Introduction 6-13
Pulse Width A 6-14
Duty Factor 6-14
Totalize **6-15**
TOTALize A 6-15

7 Measurement Control

About this chapter 7-2
Measuring Time 7-2
Display Hold 7-3
Arming 7-3
Digit Blanking 7-5
Controlling Measurement Timing . **7-6**
Arming Set Up Time 7-12
Arming Examples **7-13**
Example #1: 7-13
Example #2 7-16
Example #3 7-17

///

8 Processing	
Introduction	8-2
Averaging	8-2
Nulling	8-2
9 Auxiliary Functions	
About this chapter	9-2
Auxiliary Menu	9-2
10 Performance Check	
General Information	10-2
Recommended Test Equipment	10-2
Front Panel Controls	10-3
Short Form Specification Test	10-5
Rear Input/Output	10-6
Measuring Functions	10-7
PM9621, PM9624 and PM9625/25B	10-8
11 Preventive Maintenance	
Calibration and adjustment	11-2
Other Maintenance	11-4
12 Specifications	
Measuring Functions	12-2
Input and Output Specifications	12-3
Auxiliary Functions	12-4
GPIB (PM 9626B)	12-5
Measurement Uncertainties	12-6
Time Base Options	12-7
General Specifications	12-8
Ordering Information	12-8
13 Appendix	
Appendix 1, Error Messages	13-2
14 Index	
INDEX	14-II
15 Service Centers	
Sales and Service office	15-II

Warranty Statement

This **Fluke** guarantee is in addition to all rights which the buyer may have against his supplier under the sales agreement between the buyer and the supplier and according to local legislation.

Fluke guarantees this product to be free from defects in material and workmanship under normal use and service for a period of one (1) year from the date of shipment. This guarantee does not cover possible required re-calibration and/or standard maintenance actions. This guarantee extends only to the original end purchaser and does not apply to fuses, batteries, power adapters, or to any product or part thereof that has been misused, altered, or has been subjected to abnormal conditions of operation and handling.

Fluke-supplied software is guaranteed to be properly recorded on non-defective media. We will replace improperly recorded media without charge for 90 days after shipment upon receipt of the software. Our software is not guaranteed to be error free.

Fluke' obligation under this guarantee is limited to have repaired or replace a product that is returned to an authorized **Fluke** Service Center within the guarantee period, provided that **Fluke** determines that the product is defective and that the failure has not been caused by misuse, alteration or abnormal operation.

Guarantee service for products installed by **Fluke** will be performed at the Buyer's facility at no charge within **Fluke**' service travel area; outside this area guarantee service will be performed at the Buyer's facility only upon **Fluke** prior agreement and the Buyer shall pay **Fluke** round trip travel expenses.

If a failure occurs, send the product, freight prepaid, to the Service Center designated by **Fluke** with a description of the difficulty. At **Fluke**' option, repairs will be made or the product replaced. **Fluke** shall return the product, F.O.B. Repair Center, transportation prepaid, unless the product is to be returned to another country, in which case the Buyer shall pay all shipping charges, duties, and taxes. **Fluke** assume NO risk for damage in transit.

Disclaimer

The foregoing guarantee is exclusive and is in lieu of all other guarantees, expressed or implied, including but not limited to any implied guarantee of merchantability, fitness, or adequacy for any particular purpose or use. We shall not be liable for any direct, indirect, special incidental, or consequential damages, whether based on contract, tort, or otherwise.

DECLARATION OF CONFORMITY

for

Fluke
Universal Frequency Counter PM6685
Universal Frequency Counter / Calibrator PM6685R

Fluke Precision Measurement Ltd.
Norwich Airport Industrial Estate
Norwich
Norfolk NR6 6JB
UK

Statement of Conformity

Based on test results using appropriate standards, the product is in conformity with
Electromagnetic Compatibility Directive 89/336/EEC
Low Voltage Directive 73/23/EEC

Sample tests

Standards used:

EN 61010-1 (1993) CAT II
Safety Requirements for Electronic Measuring Apparatus

EN 55011 (1991) Group 1, Class B
Limits and methods of measurement of radio disturbance characteristics of industrial,
scientific and medical radio-frequency equipment

EN 50082-2 (1991)
Electromagnetic Compatibility Generic Immunity Standard

The tests have been performed in a typical configuration.

This Conformity is indicated by the symbol **CE**, i.e. "Conformité européenne".

Chapter 1

Preface

Introduction

Your PM6685 Counter is designed to bring you a new dimension to portable and bench-top counting. It offers significantly increased performance compared to traditional counters. The Counter offers the following advantages:

- Ten digits of frequency resolution per second and 250 ps resolution, as a result of high-resolution interpolating reciprocal counting
- A 2.7 GHz input frequency option
- A foolproof auto trigger function

New powerful and versatile functions

The unique versatile auto sensitivity and auto waveform compensation takes care of all triggering from 50 Hz and up. It even optimizes itself to the requirements of different measuring functions.

Another unique feature in your instrument is the bar-graph level monitor. It always shows you the input signal level on a dB scale to verify proper signal strength.

The burst frequency and PRF functions measure bursts and AM signals without any external synchronization signal.

To solve even tougher tasks, the counter has complete arming possibilities which lets you synchronize measurements with external events. You can even delay the arming of the counter (compare to delayed time base triggering in an oscilloscope). Read more about Arming in Chapter 7, "Measurement Control".

No mistakes

You will soon find that your new Counter is a delight to operate. One example is the back

light LCD that shows you measurement results, setting status, and operator messages. The AUTO function triggers automatically on any input wave form. A bus-learn mode simplifies GPIB programming. With bus-learn mode, manual counter settings can be transferred to the controller for later reprogramming. There is no need to learn code and syntax for each individual counter setting if you are an occasional bus user.

Design Innovations

State of the art technology gives durable use

This counter and the other models in the PM668X family are designed for quality and durability. The design is highly integrated. The digital counting circuitry consists of just two custom developed VLSI-ASICs and a 16-bit micro controller. The high integration and low component count reduces power consumption and results in an MTBF of 30,000 hours. Modern production surface-mount technology ensures high production quality and a rugged mechanical construction including a metal cabinet that withstands mechanical shocks and protects against EMI.

High resolution

The use of reciprocal interpolating counting in this new counter results in excellent relative resolution: 10 digits in one second for all frequencies, see Figure 1-1.

The measurement is synchronized with the input cycles instead of the time base. Simultaneously with the normal "digital" counting, the counter makes analog measurements of the time between the start/stop trigger events and the next following clock pulse. This is done in

two identical circuits by charging an integrating capacitor with a constant current, starting at the trigger event. Charging is stopped at the leading edge of the first following clock pulse. The stored charge in the integrating capacitor represents the time difference between the start trigger event and the leading edge of the first following clock pulse.

When the "digital" part of the measurement is ready, the stored charges in both capacitors are measured. The capacitors are discharged with a constant current, which is only 1/400:th of the charging current, which means that the discharge time will be 400 times the charging time. This 400-fold stretched time is digitally measured by the counter itself, with adequate resolution.

The counter's microcomputer calculates the result after completing all measurements, i.e., the digital time measurement and the two interpolation measurements.

The result is that the basic "digital resolution" of ± 1 clock pulse (100 ns) is reduced to 0.25% of a clock pulse cycle, or 250 ps.

Since the measurement is synchronized with the input signal, the resolution for frequency measurements is very high and is independent of frequency.



The Counter has 10 display digits to ensure that the display does not restrict the display resolution. It also has an overflow function that lets you see digit 11 and 12.

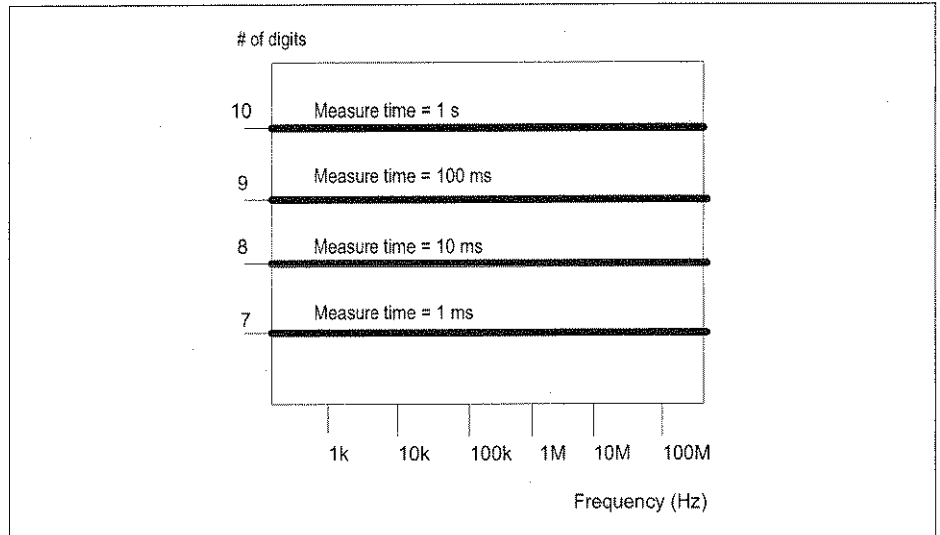

Fig. 1-1 Resolution for The Counter.

New fast SCPI Bus Rubidium Counter

The counter is not only an extremely powerful and versatile bench-top instrument, it also features extraordinary IEEE-488 bus properties. To ensure compatibility now and in the future, the Counter incorporates the latest IEEE-488.2 bus standard and the internationally standardized SCPI Command set (Standard Commands for Programmable Instruments). The bus transfer rate of the Counter is up to 1,000 measurements over the IEEE-488 bus, and 1,600 measurements per second to internal memory. This very high measurement rate makes new measurements possible. For example, you can perform *jitter analysis* on several thousands of pulse width measurements and capture them in a second. Together with the IEEE-488 interfaces you get an extensive programming manual that helps you understand SCPI and programming of the counter.

You get an analog recorder output as standard with all IEEE-488 interfaces. This output provides an analog signal proportional to the value of any three consecutive display digits. The output can be used for recordings of measurements on a strip-chart recorder or as a feedback signal to an analog control system.

The counter is easy to use in IEEE-488 bus environments. A built-in bus-learn mode makes it possible to set all counter settings manually and to transfer the complete counter setting to the controller. The response can later be used to re-program the counter to the same settings. This eliminates the need for the occasional user to learn all individual programming codes. Complete (manually set) counter settings can also be stored in 19 internal memory locations and can easily be recalled at a later occasion. Another user-friendly feature is macro-programming. You can define your own mnemonics and define group settings for complex measurements, then reduce them to one macro command.

The PM6685R contains an atomic resonance-controlled time-base (Rubidium) that gives a new meaning to 10-12 digit measurements.

Quick to operation, the warm-up time for the rubidium counter is only 4-6 minutes, compared to 10 minutes for an oven enclosed time-base.

The counter uses a larger cabinet due to the size and power requirements of the Rubidium time-base.

Chapter 2

Safety Instructions

Introduction

Read this page carefully before you install and use the instrument.

This instrument has been designed and tested according to safety Class I requirements of IEC publication 1010-1 and CSA 22.2 No.231, and has been supplied in a safe condition. The user of this instrument must have the required knowledge of it. This knowledge can be gained by thoroughly studying this manual.

This instrument is designed to be used by trained personnel only. Removing the cover for repair, maintenance, and adjustment of the instrument must be done by qualified personnel who are aware of the hazards involved.



Fig. 2-1 Do not overlook the safety instructions!

Safety precautions

To ensure the correct and safe operation of this instrument, it is essential that you follow generally accepted safety procedures in addition to the safety precautions specified in this manual.

Caution and warning statements

CAUTION: Shows where incorrect procedures can cause damage to, or destruction of equipment or other property.

WARNING: Shows a potential danger that requires correct procedures or practices to prevent personal injury.

Symbols



Shows where the protective ground terminal is connected inside the instrument. Never remove or loosen this screw.



Indicates that the operator should consult the manual.

One such symbol is printed on the instrument, below the A input. It points out that the damage level for the input voltage decreases from 350Vp to 12Vrms when you switch the input impedance from 1 MΩ to 50 Ω.

If in doubt about safety

Whenever you suspect that it is unsafe to use the instrument, you must make it inoperative by doing the following:

- Disconnecting the line cord
- Clearly marking the instrument to prevent its further operation
- Informing your local Fluke Service Center.

For example, the instrument is likely to be unsafe if it is visibly damaged.

Disposal of hazardous materials

WARNING: Disposal of lithium batteries requires special attention. Do not expose the batteries to heat or put them under extensive pressure. These measures may cause the batteries to explode.

The counter uses a lithium battery (See Figure 2-2) to power a backup RAM. Return used batteries to the vendor for recycling.

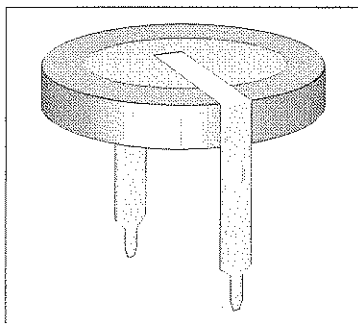

Fig. 2-2 *A lithium battery in the counter ensures that all settings are saved even when the power is turned off.*

This page is intentionally left blank

2-4 *Safety precautions*



Chapter 3

Preparation for Use

Unpacking

Check that the shipment is complete and that no damage has occurred during transportation. If the contents are incomplete or damaged, file a claim with the carrier immediately. Also notify your local Fluke sales or service organization in case repair or replacement may be required.

Check list

The shipment should contain the following (See Figure 3-1):

- The PM6685 Counter
- Line cord
- This Operators Manual
- Options you ordered should be installed. See "Identification."
- Programming Manual (when GPIB option is installed).
- N-to-BNC Adapter, (only with prescaler, PM 9624)

Identification

Check marks on the rear panel show what options are installed in your counter, see Figure 3-2.

Installation

Supply voltage

■ Setting

The Counter may be connected to any AC supply with a voltage rating of 90 to 265V_{rms} 45 to 440 Hz. The counter automatically adjusts itself to the input line voltage.

■ Fuse

An 1.6A/250V slow blow fuse is placed inside the counter. This fuse rating is used for the full voltage range.

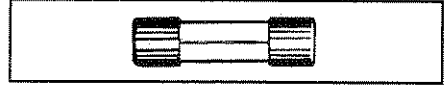

Fig. 3-1 1.6AT 5x20mm fuse

CAUTION: If this fuse is blown, it is likely that the power supply is badly damaged. Do not replace the fuse. Send the counter to the local Service Center.

Grounding



Grounding faults in the line voltage supply will make any instrument connected to it dangerous. Before connecting any unit to the power line, you must make sure that the protective ground functions correctly. Only then can a unit be connected to the power line and only by using a three-wire line cord. No other method of grounding is permitted. Extension cords must always have a protective ground conductor.

CAUTION: If a unit is moved from a cold to a warm environment, condensation may cause a shock hazard. Ensure, therefore, that the grounding requirements are strictly met.

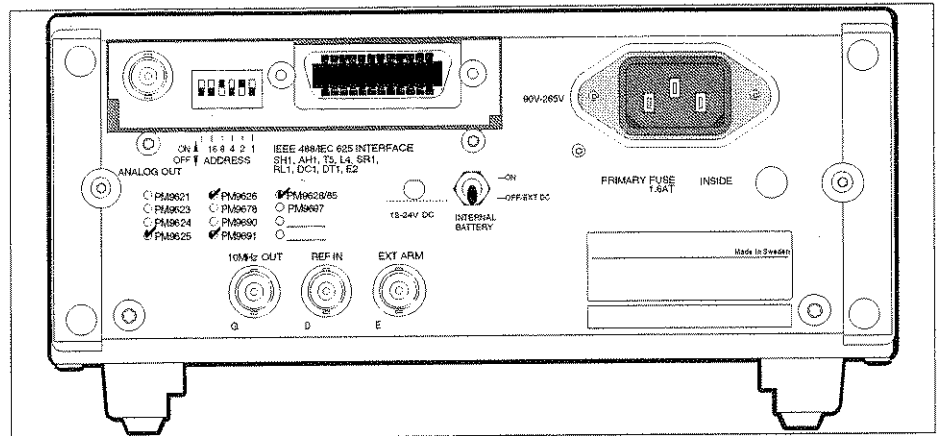

Fig 3-2 Check marks on rear panel showing options included.

WARNING: Never interrupt the grounding cord. Any interruption of the protective ground connection inside or outside the instrument or disconnection of the protective ground terminal is likely to make the instrument dangerous.

Orientation and cooling

The counter can be operated in any position desired. Make sure that the air flow through the ventilation slots at the top, and side panels is not obstructed. Leave 5 centimeters (2 inches) of space around the counter.

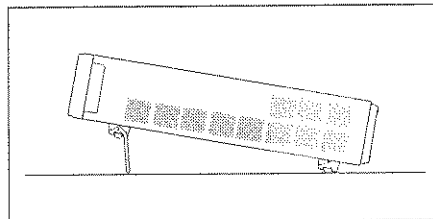
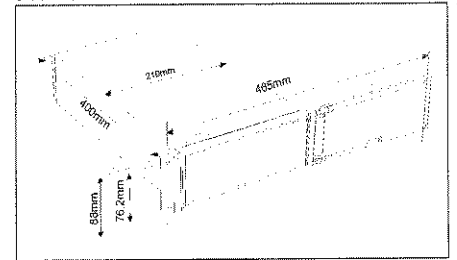

Fig. 3-3 Fold-down support for comfortable bench-top use.

Fold-down Support

For bench top use, a fold-down support is available for use underneath the counter. This support can also be used as a handle to carry the instrument.



Rack mount adapter

If you have ordered a 19 inch rack mount kit for your instrument, it has to be assembled after delivery of the instrument. The rack mount kit consists of the following:

- 2 brackets, (short, left; long, right)
- 4 screws, M5 x 8
- 4 screws, M6 x 8

WARNING: When you remove the cover you will expose live parts and accessible terminals which can cause death.

WARNING: Capacitors inside the instrument can hold their charge even if the instrument has been separated from all voltage sources.

■ **Assembling the rack mount kit**

Make sure the power cord is disconnected from the instrument.

Turn the instrument upside down.

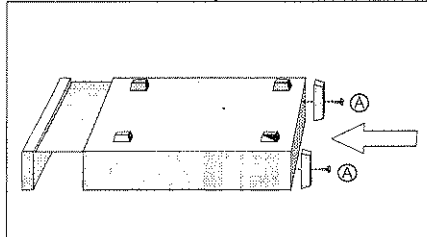

- Loosen the two screws (A) at the rear feet.
- Grip the front panel and gently push at the rear.
- Pull the instrument out of the cover.
- Remove the four feet from the cover.

Use a screwdriver as shown in the following illustration or a pair of pliers to remove the springs holding each foot, then push out the feet.

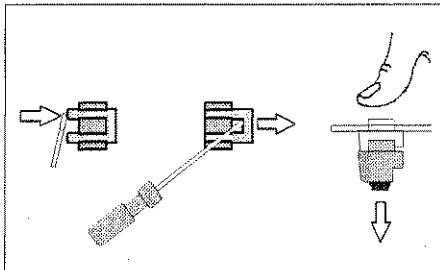

3-4 Installation

- Remove the two plastic lids that cover the screw holes on the right and left side of the front panel.
- Push the instrument back into the cover.
- Turn it upside down
- Install the two rear feet with the screws (A) to the rear panel.
- Fasten the brackets at the left and right side with the screws included as illustrated below.

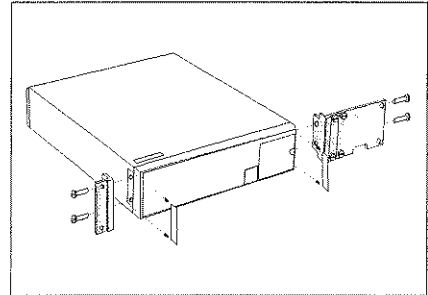

- Fasten the PM6685 or PM6685R in the rack via screws in the four rack mounting holes

■ **Reversing the rack mount kit**

The instrument may also be mounted to the right in the rack. To do so, first remove the plate on the long bracket and fasten it on the short one, then perform the preceding steps.

Chapter 4

Using the Controls

About This Chapter

This chapter gives you a quick introduction to all the controls of the counter, the design of the user interface, and front panel text. For the occasional user, the information in this chapter is often sufficient to solve a measurement problem.

The User Interface

Keys

Most keys are simple toggle keys that turn on and off the function printed above the key. Most of the keys have an on/off annunciator in the display directly over the key. This annunciator is on when the function is active.

Auxiliary menu selection

Functions which are not so frequently used are gathered together in the AUX MENU. To select from this menu:

- Press **AUX MENU** and scroll through the functions with the **FUNCTION** key.
- Press **ENTER** when the function you are looking for is displayed. Now new selections appear.
- Press **DATA ENTRY** keys or **FUNCTION** to select.
- Press **ENTER** to confirm the selection.

Changing numerical values

You must enter numerical values when you set the following:

- Measuring time.
- Arming delay.

- Reference values for nulling.
- Timeout.
- Scaling factor for the analog output (when GPIB option is installed).

The counter has no numerical keypad, so you must use the following keys:

■ Coarse adjustment

- Press **DATA ENTRY ▲** or **FUNCTION** to increase, and **DATA ENTRY ▼** or **FUNCTION** to decrease a value in 1-2-5 steps.

■ Fine adjustment

- Press **SENS** and the parameter to be set expands over the entire display.
- A cursor flashes to the left of the MSD digit. Move this cursor to the digit you want to change. Using the **SENS** keys.
- Change the value of the selected digit by pressing the **DATA ENTRY** keys.
- The sign (+ or -) is changed when the cursor flashes to the left of the MSD (only minus is indicated).

Move the cursor to the next digit and repeat the above procedure until the display shows the desired value. Then press **ENTER** to confirm the selection.

Default Settings

PARAMETER	VALUE/ SETTING
Input A:	
Sensitivity	AUTO
Trigger level	AUTO
Impedance	1M Ω
Trigger slope	Pos
Filter	OFF
Arming:	
Start	OFF
Start Delay	OFF
Stop	OFF
Miscellaneous:	
Function	FREQ A
Null/offset	OFF
Time out	OFF
Measuring time	0.2s
Check	OFF
Single cycle	OFF
Analog output control	OFF
Auxiliary functions	All switched OFF
Blank LSD	OFF

Table 4-1 Settings directly after the counter has been switched on, or the counter has been PRESET.

Basic controls

STAND-BY LED

Lit when the counter is off, but power is available to an oven oscillator.

STANDBY/ON

Press **ON** and the counter turns on and returns to its default (standard) setting. If you want to recall the settings you used before you turned off the counter, press **AUX MENU**, then press **ENTER** twice. Press **STAND-BY** to turn off the counter.

FUNCTION

Selects measuring function

LOCAL/PRESET

The instrument will ask Default? If you press **ENTER** the counter will return to preset (default) settings (see page 4-3).

If in Remote mode: the counter switches to local operation.

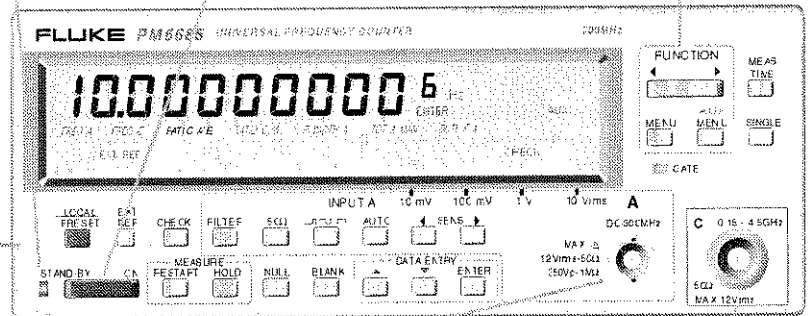

INPUT A

This input is used for all measuring functions except frequency C and Ratio C/A. It measures signals with frequencies between 10 Hz and 300 MHz and levels between 30mVp-p and 70Vp-p.

INPUT C

This input is used for high frequency measurements. The frequency range is printed above the connector. This is an option and if no connector is installed you do not have this function. The C input is fully automatic and no controls affect its performance.

Up and running in no time!

- Turn on the counter by pressing the **ON** key.
- Connect a signal to the input.
- Select function with the **FUNCTION** key.

Now the counter automatically measures with optimum input settings.

Input A controls

WAVEFORM

Offsets the trigger level, when the AUTO function is switched off, for signals with:

very low duty cycle



normal duty cycle



very high duty cycle



AUTO

This key switches on the auto sensitivity and auto waveform compensation.

AUTO selects 33% of V_{pp} as sensitivity for input A, and it adjusts to the waveform more accurately than the three choices available via manual setting.

Both the waveform and the sens keys switches off AUTO.

SENSITIVITY

Increases or decreases the sensitivity of the counter when the AUTO function is switched off. The set sensitivity is shown on the bar graph display.

If you turn off AUTO by pressing the SENS keys, the selections made by AUTO remain as fixed settings.

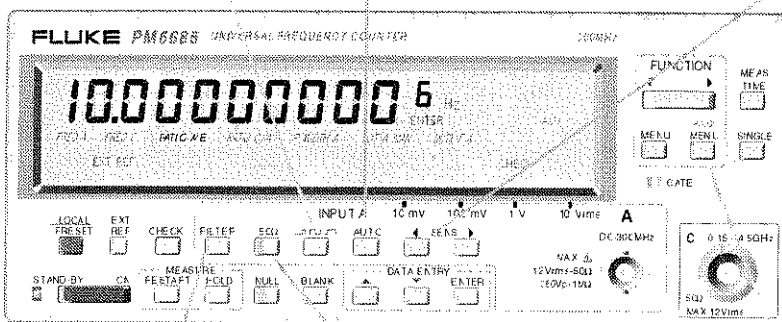

Filter

Switches on and off the 100kHz low pass filter. This filter removes high frequency interference when measuring on LF sine wave signals.

50 Ω

Switches between 50 Ω /1M Ω input impedance. 1M Ω allows the counter to measure without loading down the measuring signal while 50 Ω terminates the cables in 50 Ω systems, minimizing reflections and interference.

SLOPE

The trigger slope can be set in the AUX MENU, see chapter 10, "Auxiliary functions".

This selection is intended for negative pulse width and negative duty factor measurements. The negative slope of the waveform indicator flashes when the counter triggers on negative slopes.

Measurement control keys

MEASURING TIME

Sets measuring time between 800ns and 400 s.
Use FUNCTION key to step up/down the time in 1-2-5 steps. The measuring time works like the exposure time of a camera, a long measuring time captures more information giving more details to the result (higher resolution).

SINGLE

When on, the result from each measurement cycle is displayed. Now the set measuring time becomes the Display Time (time between measurements). When off, the counter averages all data captured during the set measuring time.

GATE LED

On while a measurement proceeds.

EXT REF

Switches between the external and the internal Time Base

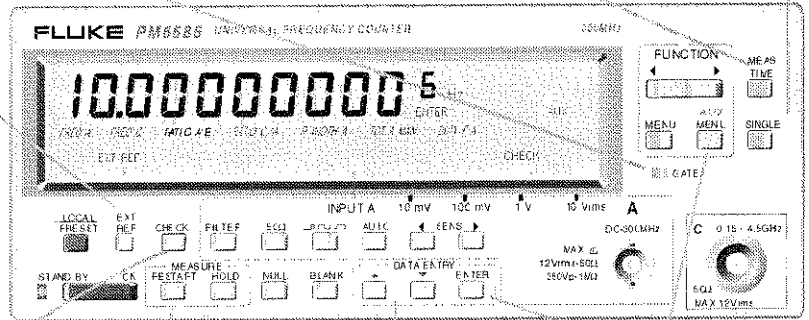

CHECK

Connects the internal 10MHz reference to the counter logic to allow test of all measuring functions.

DATA ENTRY

Increases and decreases numerical values on the display. Used for MEAS TIME, BURST, PRF, ARM START/STOP, TIME OUT and ANALOG OUT.

AUX MENU

Gives you access to additional functions like arming, burst triggering, save/recall and much more. See Chapter 10 "Auxiliary Functions".

MEAS RESTART

Interrupts the measurement, clears the display, and starts a new measurement.
Reset the measurement result in TOT A MAN.
Arms individual measurements when DISPLAY HOLD is active.

ENTER

Confirms a selection

Display controls

DISPLAY HOLD

Freezes the display until you press the key again. New measurements are armed every time MEAS RESTART is pressed. Starts/stops the measurement in TOT A MAN.

NULL

The NULL function stores the current result on the display, then shows all the following results as deviation from that result. You can read and change the stored reference in the AUX MENU.

BLANK DIGIT

Each press on this key blanks out one display digit, starting with the LSD. When all digits are blanked, the next press disables the blanking.

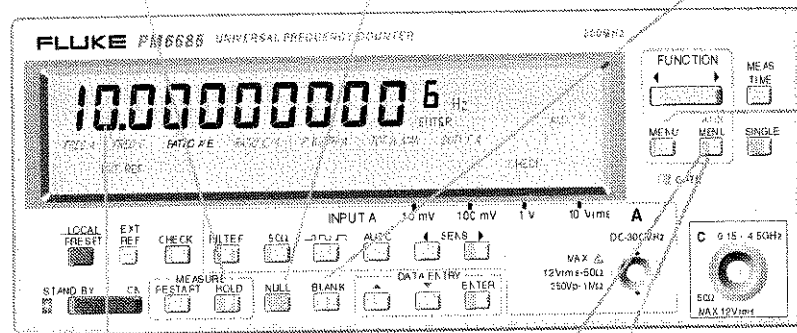

DISPLAY LIGHT

You can switch on and off the display back lighting in the AUX MENU.

DISPLAY OVERFLOW

The measurement result can contain up to 12 digits. With the overflow function you can see the two additional digits that normally are hidden.

MENU

If you press MENU, the display shows all selectable functions and the current selections blinks.

Display

MEASURING FUNCTIONS

The current measuring function is shown on the display.

If MENU is pressed, all possible selections are shown on the display and current setting is blinking.

NUMERICAL PRESENTATION

A10-digit display used to show measuring results and other values.

The display always shows basic units (Hertz, counts or seconds) plus an exponent when necessary.

ENTER

Displayed when the instrument wants you to confirm a selection by pressing ENTER.

Mantissa Exponent Unit Indicator

NULL

On if the result is displayed relative to a nulling constant.

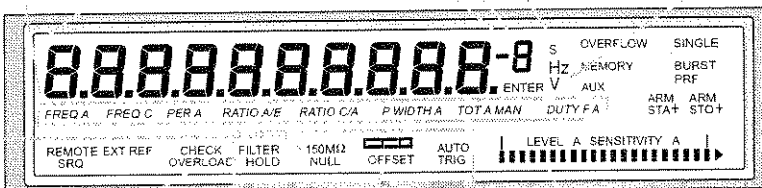

OVERLOAD

Flashes if you press 50Ω when the input signal is 12 to 24 Vrms. Press 50Ω again to confirm selection. If OVERLOAD turns off, the input signal falls below 12 Vrms when loaded with 50Ω.

Caution: Immediately disconnect the signal if this annunciator is on; otherwise, the input could be seriously damage.

OFFSET

Read more about the offset annunciator on page 5-5 under "Auto Once".

INPUT SETTINGS

Input settings are shown on the display directly above the key used for each setting.

LEVEL/SENSITIVITY BAR GRAPH

Shows A-input level between -27dB and +33 dB (3dB/bar) when AUTO is on. Level above +33dB is indicated by an arrow in the right edge of the graph. When AUTO is off, it shows sensitivity. Max. Sensitivity, -27dB= all segments, except the leftmost, are off.

Display

REMOTE

On when the instrument is controlled from the GPIB. Press LOCAL to go to local control.

MEMORY

This indicator is on when a setting has been recalled from, or saved in memory. MEMORY is only until something is changed in the instrument setting.

OVERFLOW

When this annunciator is on, the counter has measured an 11 or 12 digit result, and shows the 10 least significant digits on the display. The overflow function is enabled/disabled in the AUX MENU.

BURST and PRF

One of these segment are on when the instrument is set up for a frequency burst measurement (via AUX MENU).

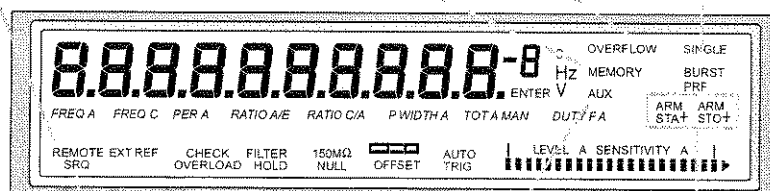

SRQ

On when the instrument has sent a Service Request via GPIB but the controller has not fetched the message. Reading the status byte via the controller will show what caused the SRQ and turn off the annunciator.

AUXILIARY

Displayed when an AUX MENU function results in a setting that cannot otherwise be shown on the display. Make it a rule to keep an eye at this indicator.

ARMING

Indicates that the Arming function is in use and shows the selection of positive or negative slope for arming start/stop.

Rear Panel

GPIB OPTION

ANALOG OUTPUT

Outputs any 3 digits on the display as 0 to 4.98 V.

GPIB ADDRESS SWITCH

Selects address between 1 and 30. The display shows the address every time the counter is turned on.

GPIB CONNECTOR

A standard IEEE 488.1 connector for connection to a controller.

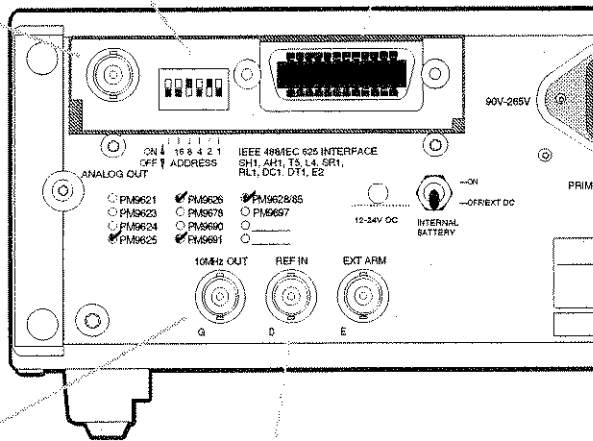

10 MHz OUTPUT

A frequency reference output to be used with other instrument.

REFERENCE INPUT

If you have an in-house reference or want to run several instruments on the same reference, connect 10 MHz here and select it by pressing the EXT REF key on the front.



Rear Panel

POWER SOCKET

The input can handle 90 to 265 V_{AC} and 45 to 440 Hz without any range switching.

Just connect and go!

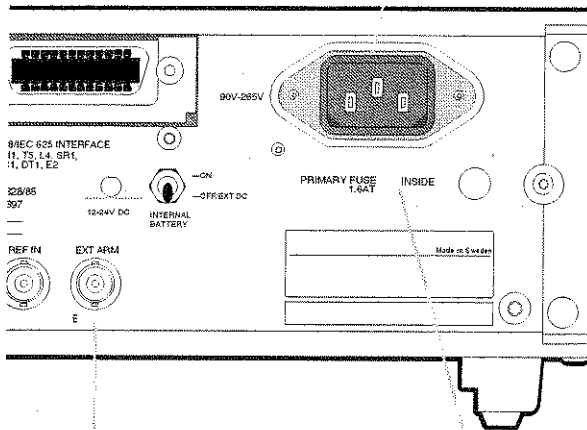

ARMING (Input E)

An arming input used to start and stop the measurement with external signal.
Also used as an extra measuring input for Ratio measurements.

FUSE

There is a 1.6 A slow-blow primary fuse inside the housing. If blown, the fuse should not be replaced without a thorough examination of the power supply.

PM6685R Front Panel

■ Operation

- Switch on the counter.
- Locate the "UNLOCKED" indicator to the right on the front panel. As long as this indicator is lit, the time-base is warming up.

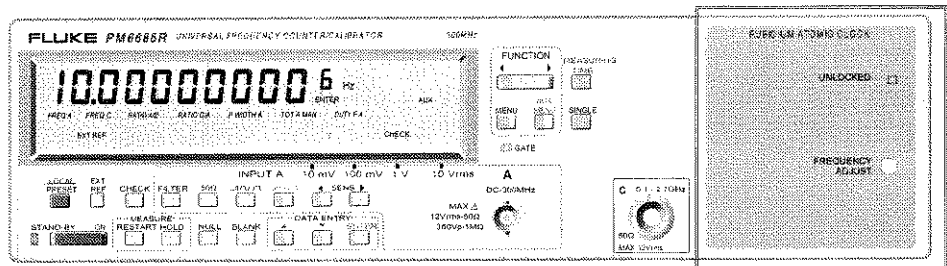

- When the indicator turns off, start using the counter.
- Apart from this UNLOCKED indicator, the counter works like a normal PM6685.

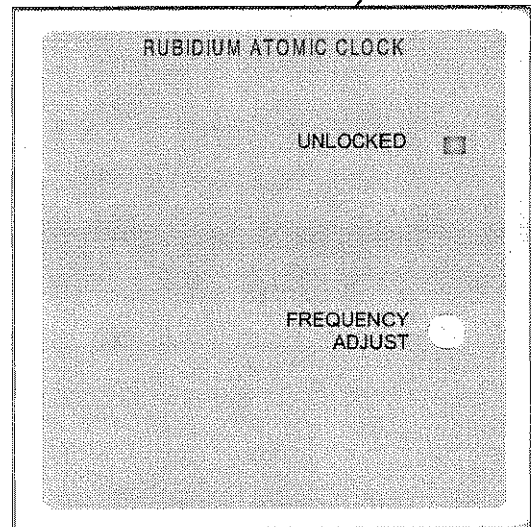

Chapter 5

Input Signal Conditioning

Introduction to this chapter

This chapter describes how the input amplifier operates, and when and how to set its controls.

Input A

The input amplifier adapts the measuring signal to the measuring logic of the counter.

The built in microprocessor automatically controls the trigger level, sensitivity, and attenuation of the input amplifier. This AUTO function is so powerful that you scarcely ever need to turn it off. At four measurements per second it is quick enough to enable real-time adjustments, and it works down to 50 Hz.

The AUTO function even adapts itself to different measurements. It gives frequency-related

measurements a wide hysteresis band that reduces noise and gives time measurements the narrow band they need to minimize trigger error. AUTO ON is the recommended setting for 99% of all measurements.

You can easily switch off the AUTO function, but to successfully set these parameters manually, it is essential to understand how the controls work with the AC-coupling of the input. Read more about it further on under AUTO OFF.

The block diagram shows the order in which the different controls are connected. This is not a complete technical diagram; it is only intended to help in understanding the controls.

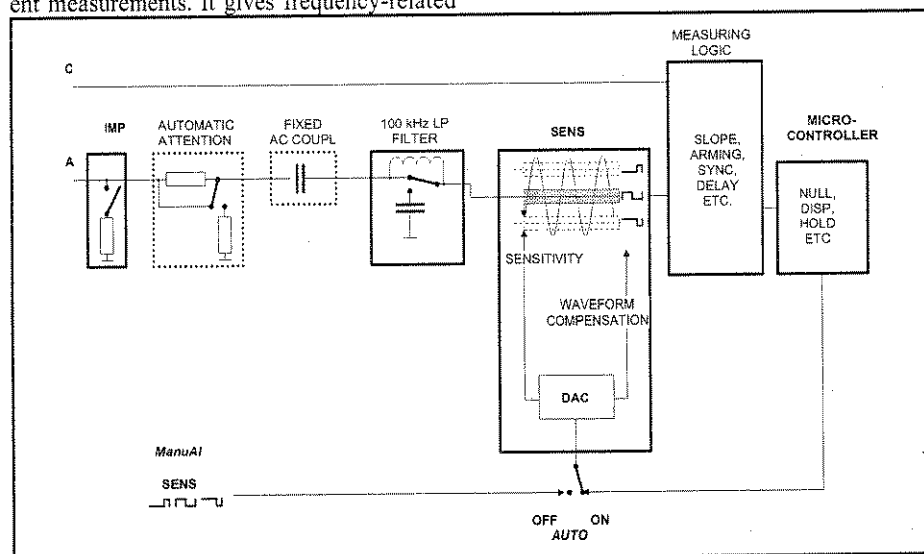
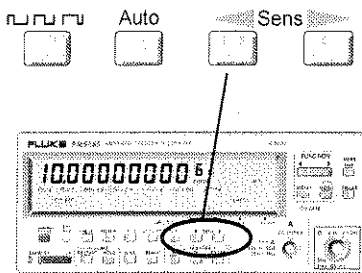

Fig. 5-1 PM6685 Signal Conditioning Block Diagram.

Triggering



indicator shows the symbol that is closest to the auto-selection made.

Hand icon: *Auto sets the waveform compensation much more accurately than is possible manually. So it is likely that the auto trigger can handle signals that are impossible to trigger manually.*

■ AUTO ON

AUTO The AUTO key turns the auto function on. Switching on the power always activates AUTO.



If the duty factor of the signal changes very much, the auto function can follow a slow change, but signals with rapidly changing duty factors are best measured with a DC-coupled timer/counter, such as the PM6680.

Hand icon: *Turn off AUTO:*
 - If the input frequency is <50 Hz
 - If you measure AM signals
 - If you measure single shot phenomena

The auto triggering function of the counter controls both the sensitivity (also called trigger window or hysteresis) and the waveform compensation (also called trigger level offset, or duty factor compensation). Auto measures the peak-to-peak levels of the input signal and sets the upper level of the hysteresis band to 66% and the lower level to 33% of that value (for pulse width and duty factor measurements, both levels are set to 50%). AUTO accurately sets the waveform compensation to compensate for duty factors other than 50%. The waveform

Speed

The counter measures amplitude and calculates sensitivity and trigger level offset rapidly. The typical time is 50 ms. If you use the counter in an automatic test system and need faster measurements, read about speed in chapter 19 "How to Measure" in the GPIB Programming Manual.

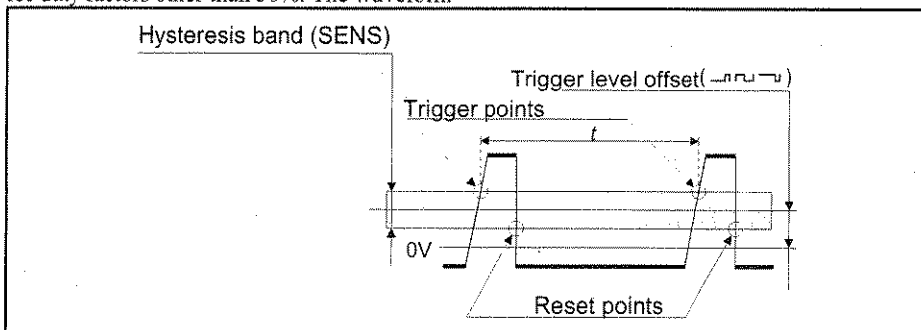





Fig. 5-2 Parameters controlled by SENS and Waveform keys.

■ **AUTO OFF**



Switch to manual triggering by pressing the waveform key    so that the AUTO TRIG annunciator on the display is switched off.

The sensitivity and waveform indicators return to the last manual settings, and you can control the input amplifier by pressing the **SENS** and the **waveform** keys.

When to use manual sensitivity

- The most obvious use for manual settings is for signals below 50 Hz, for which AUTO does not function.
- When measuring on non-repetitive signals, you also need to use manual trigger levels; see Chapter 6.
- When measuring AM signals.
- When measuring sine wave signals with little noise, you may want to measure with a high sensitivity (narrow hysteresis band) to reduce the trigger uncertainty. Triggering at or close to the middle of the sig-

nal leads to the smallest trigger (timing) error since the signal slope is steepest at the sine wave zero crossing, see Figure 5-9.

< SENS > Press the **< SENS** and **SENS >** keys to set manual sensitivity.

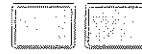



The hysteresis band can be set between 10mV and 10V and is shown on the bar graph.



It is much easier to set the correct sensitivity if you know the signal level. Read the level on the bar graph before switching off AUTO.



You can use the **Waveform** key to compensate a waveform in three steps:

-  (0 - 25% duty factor)
-  (25-75% duty factor)
-  (75-100% duty factor)

The reason for this setting is that non-symmetrical signals do not center on 0V, but get a dc shift after the ac coupling capacitor. Signals with less than 50% duty factor have a

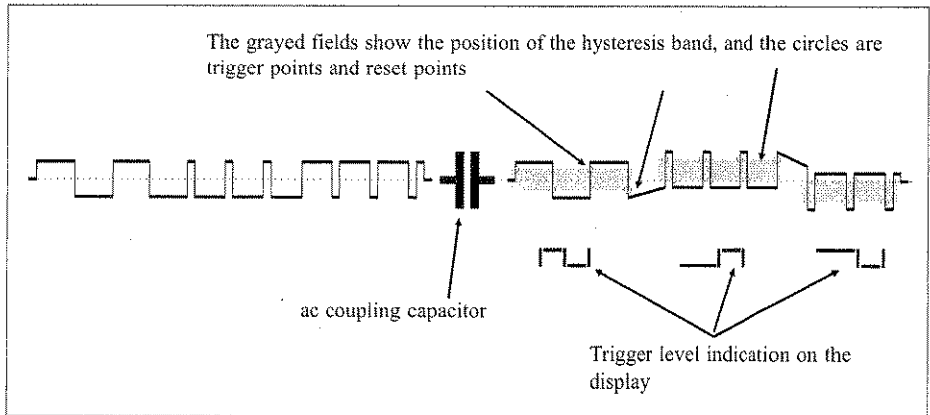

Fig. 5-3 Dc shift caused by the ac coupling capacitor.

positive dc shift, and signals with more than 50% duty factor have a negative dc shift, see Figure 5-3. When the duty factor exceeds a certain factor, the input will stop triggering unless the trigger window is offset to compensate for the dc shift of the signal.

■ AUTO once

Press one of the <SENS> keys when AUTO is on. Now the counter will switch to manual settings and freeze the last sensitivity and trigger level offset selections made by AUTO. The OFFSET annunciator on the display is on to show that the counter uses a trigger level offset that cannot be manually entered. You can use the <SENS > keys to adjust the sensitivity around the frozen trigger level offset. When you press the **waveform** key, the counter returns to one of the three ordinary trigger level offset selections.

■ Analog Low-pass, Noise Suppression Filter

FILTER Input signals having a signal-to-noise ratio less than approximately 6 dB cannot be measured successfully without filtering in one way or another.

The counter has an analog LP (Low Pass) filter with a cutoff frequency of approximately 100 kHz and a signal rejection of 40 dB at 1 MHz.

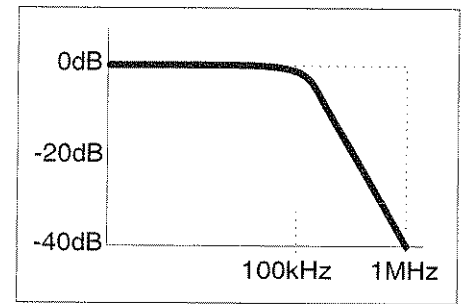

Fig. 5-4 Characteristics of LP filter.

Accurate frequency measurements of noisy LF (Low Frequency) signals (less than 200 kHz) can be made, even when the noise components are significantly higher in frequency than the fundamental signal.

■ Impedance

50Ω The input impedance can be set to 1MΩ or 50Ω.

Before switching to 50Ω, the counter checks to see if the amplitude of the signal exceeds the maximum allowed 12Vrms. If it does, the overload annunciator on the display flashes and the counter does not switch to 50Ω unless you press the 50Ω key once more.

You can force the counter to 50Ω this way since a too high signal may fall below 12Vrms when loaded with 50Ω.

- If the signal falls below the limit, the overload annunciator will turn off and you can continue to measure.
- If the annunciator remains on, quickly disconnect the signal cable from the input A BNC connector. Here you must use an external 50Ω terminator that can withstand the power you feed into it.

If the signal check shows an amplitude above 24Vrms, the overload annunciator will turn on and the counter will refuse switching to 50Ω.

CAUTION: To avoid permanent damage to the input amplifier, do not connect signals with amplitudes above 12Vrms to the counter when the counter is already set to 50Ω.

Reducing Noise and Interference

Sensitive counter input circuits are, of course, also sensitive to noise. By matching the signal amplitude to the counter's input sensitivity, you reduce the risk for erroneous counts from noise and interference. These could otherwise ruin a measurement.

To ensure reliable measuring results, the counter has the following functions to reduce or eliminate the effect of noise.

- Continuously variable sensitivity.
- Analog low-pass noise suppression filter.
- Trigger level offset.

To make reliable measurements possible on very noisy signals, you may use several features simultaneously. Optimizing the input amplitude and optimizing the trigger sensitivity by using the sensitivity control are independent from input frequency and useful over the entire frequency range. LP filters function selectively over a limited frequency range.

Input C

Input C is the input for the optional prescalers. As opposed to input A, input C can only measure frequency. All prescalers are fully automatic and require no settings at all.

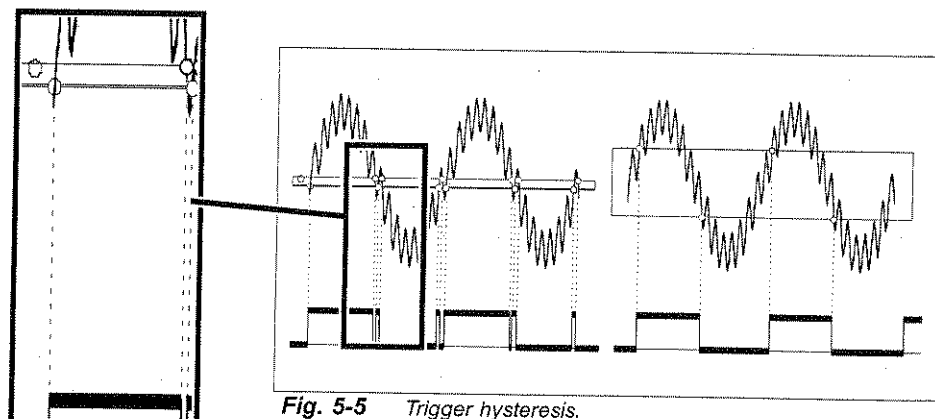

Fig. 5-5 Trigger hysteresis.

5-6 Input C

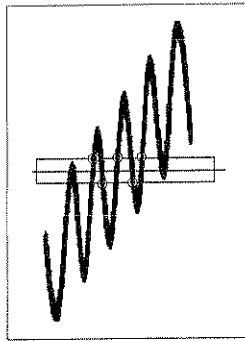

Fig. 5-6 Erroneous Counts due to Noise.

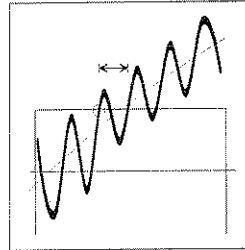

Fig. 5-7 Trigger Uncertainty due to Noise.

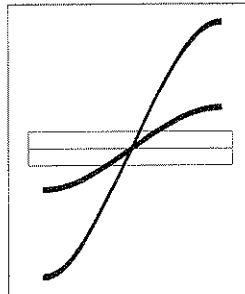

Fig. 5-8 Low Amplitude delays the Trigger Point.

Trigger Hysteresis

Each trigger device has some hysteresis (or trigger window) that the signal must cross before triggering occurs. Other names are "trigger sensitivity" or "noise immunity" and explain the various characteristics of the hysteresis.

Fig. 5-5 and 5-6 show how spurious signals can cause the input signal to cross the trigger or hysteresis window more than once per input cycle and cause erroneous counts.

Figure 5-7 shows that less noise still influences the trigger point by advancing or delaying it, but it does not cause erroneous counts. The trigger (timing) uncertainty in Figure 5-7 is shown as trigger uncertainty or trigger error.

This trigger uncertainty is important when measuring low frequency signals, since the signal slew rate (in V/s) is low for LF signals. To reduce the trigger uncertainty, it is de-

sirable to cross the hysteresis as fast as possible. Figure 5-8 shows that a high amplitude signal passes the hysteresis faster than a low amplitude signal. For low frequency measurements, where the trigger uncertainty might be important, the sensitivity should be as high as possible, due to the trigger timing error (see Figure 5-9).

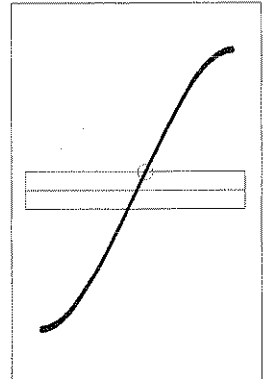

Fig. 5-9 Timing error due to slew rate.

In practice however, trigger errors caused by erroneous counts (Figure 5-5 and 5-6) are much more important and require just the opposite measures to be solved.

To avoid erroneous counting caused by spurious signals, you need to avoid excessive input signal amplitudes. This is particularly valid when measuring on high impedance circuitry and when using the $1M\Omega$ input impedance. Under these conditions, the cables easily pick up noise.

External attenuation reduces the signal amplitude, including the noise, while the internal sensitivity control in the counter reduces the counter's sensitivity, including sensitivity to noise. Reduce excessive signals with external coaxial attenuators. You can set the input sensitivity of the counter continuously between 10 mVp-p and 10Vp-p.

The auto function normally takes care of setting the hysteresis band by setting its limits to 33% and 66% of the amplitude.

■ **Stable readings**



As a rule, stable readings are free from noise or interference.

However, stable readings are not necessarily correct; harmonic distortion can cause erroneous yet stable readings.

If you cannot obtain a stable reading, the signal-to-noise ratio is too poor (assumably poorer than six to ten decibels), and you should use a filter.



Chapter 6

Measuring Functions

Introduction to this chapter

This chapter describes the different measuring functions of the counter. The functions have been grouped as follows:

Frequency measurements

- Frequency
- Burst frequency and PRF
- AM
- Ratio

Period measurements

- Period

Pulse width measurements

- Pulse width
- Duty factor

Totalize measurements

- Totalize A-B Manual

Selecting function

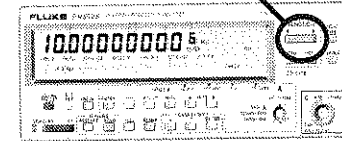
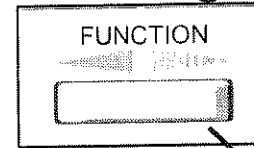

FUNCTION Press one end of the **FUNCTION** key. This scrolls the function cursor on the display. Release the key when the desired function is high-lighted.



Frequency

Introduction

Frequency is the basic function of a frequency counter. The PM6685 measures frequency between 10 Hz and 300 MHz on the A input, and up to 2.7 GHz on the optional C input. Frequencies above 50 Hz are best measured using the AUTO triggering and the default measuring time of 200 ms. The counter always starts up with Frequency A selected and AUTO on, ready to measure.

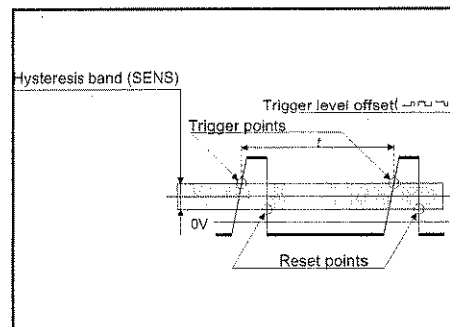

Fig. 6-1 Frequency is measured as the inverse of the time between the one trigger point and the next.

$$f = \frac{1}{T}$$

Theory of Measurement

■ Reciprocal Counting

Simple frequency counters count the number of input cycles during a preset gate time, for instance one second. This leads to the ± 1 input cycle count error that, at least for low-frequency measurements, is a major contribution to uncertainty.

However, this counter uses a high resolution, input signal synchronized, reciprocal counting technique. With this technique, the counter counts an exact number of integral input cycles, thereby omitting the ± 1 cycle error.

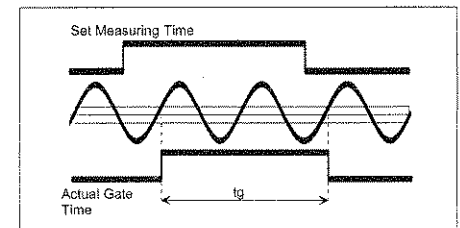

Fig. 6-2 Synchronization of a measurement.

After the start of the set measuring time, the counter synchronizes the beginning of the actual gate time with the first trigger event (t_1) of the input signal it measures on.

In the same way, the counter synchronizes the stop of the actual gate time with the input signal, after the set measuring time has elapsed. The multi-register counting technique in the counter allows you to simultaneously measure the actual gate time (t_g) and the number of cycles (n) that occurred during this gate time.

Thereafter, it calculates the frequency according to Mr. Hertz's definition:

$$f = \frac{n}{t_g}$$

The counter measures the gate time, t_g , with a resolution of only 250 ps, independent of the measured frequency. Consequently the use of prescalers does not influence the quantization error. Therefore, the *relative* quantization error is: $250 \text{ ps}/t_g$.

$$\text{Relative RMS quantization error} = 250 \frac{\text{ps}}{t_g}$$

For a 1-second measuring time, this value is:

$$250 \frac{\text{ps}}{1 \text{ s}} = 250 * 10^{12} = 2.5 * 10^{10}$$

Except for very low frequencies, t_g is nearly identical with the set measuring time.

■ Signal detection

The counter has an automatic signal detection that terminates the measurement if no triggering has occurred about 200 ms after the measuring time has expired.

When auto trigger is turned on, the counter will show NO SIGNAL when triggering has stopped. When auto trigger is turned off, the counter will show NO trig when triggering has stopped.

Signal detection is on for all functions but TOT A MAN, burst frequency, PRF, arming and single measurements.

■ Sample-hold

If the input signal disappears during the measurement, the counter will show NO SIGNAL. If you probe test points and you cannot simultaneously view the display this will be a problem.

In such case, press **DISPL HOLD** to activate hold, put your probe tip on the test point and press **MEAS RESTART**. Now the counter makes one measurement, and when you remove the probe tip from a test point, the counter continues to display the measured value and behaves like a voltmeter with a sample-hold feature.

■ Timeout

Mainly for GPIB use, you can manually select a fixed timeout in the AUX MENU. The range of the fixed timeout is 100 ms to 25.5s and the default setting is OFF.

Select a timeout that is longer than the cycle time of the lowest frequency you are going to measure; multiply the timeout by the prescaling factor of the input channel. When no triggering has occurred during the timeout time, the counter will show Ti.Out.

Measuring Speed

The set measuring time determines the measuring speed. For continuous signals,

$$\text{Speed} \approx \frac{1}{t_g} + 0.2$$

when AUTO is on and can be increased to:

$$\text{Speed} \approx \frac{1}{t_g} + 0.001$$

with AUTO turned off.

■ Frequency Average and Single Cycle Measurements

To reduce the actual gate time or measuring aperture, the counter has very short measuring times and a measuring time called SINGLE. The latter means that the counter can measure during only *one cycle* of the input signal. In applications where the counter uses an input channel with a prescaler, the divider causes the SINGLE measurement to last as many cycles as the divider factor. If you want to measure with a very short aperture, use an input with the lowest possible divider factor.

■ Prescaling May Influence Measuring Time

Prescalers do influence the actual gate time to some extent. This may be a problem for example when measuring the carrier wave frequency in a short burst signal.

Fig 6-3 shows the effect of the 2.7 GHz prescaler. For 16 input cycles, the prescaler gives one (shaped) output cycle. When the counter uses a prescaler, it counts the number of prescaled output cycles, here $f/16$. The display shows the correct input frequency since the microcomputer compensates for the effect of the dividing factor d as follows: $f = n * \frac{d}{t_g}$

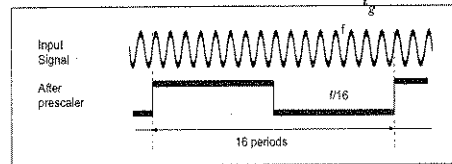

Fig. 6-3 Divide-by-16 Prescaler.

Prescalers do not reduce resolution in reciprocal counters. The relative quantization error is still: $250 \frac{ps}{t_g}$.

The prescaling factors are:

Function	Prescaling factor
BURST A	1 (160 MHz)
FREQ A	2 (300 MHz)
FREQ A, negative slope	1 (160 MHz)
FREQ C	16 (2.7 GHz)
All other functions	1 (160 MHz)

Note that a "SINGLE" cycle measurement in FREQ A measures two input cycles. You can however force FREQ A SINGLE to measure on one input cycle by selecting negative trigger slope via the AUX MENU.

■ LF Signals

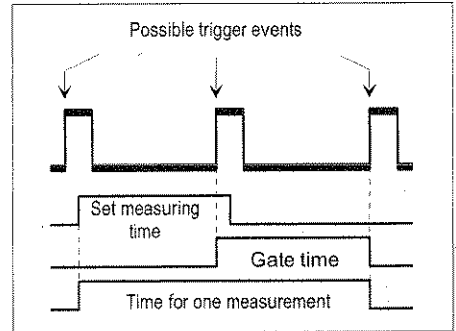

Fig. 6-4 Measuring time.

Signals below 50 Hz must be measured with manual triggering. The lower frequency limit for the counter is 10 Hz for sine waves. However, the counter can measure pulses with a lower repetition rate. For example, when you measure a 0.1 Hz pulse with a non-prescaled function like PERIOD, the measurement will require at least the duration of one cycle, that is 10 seconds, and worst case nearly 20 seconds. The worst case is when a trigger event took place just before the beginning of a measuring time (Fig. 6-4). Measuring the frequency of the same signal will take twice as long, since frequency prescales the signal by two.

Even if you have chosen a short measurement time, the measurement will require between 20 and 40 seconds.

■ HF Signals

As mentioned before, a prescaler in the C input divides the input frequency before it is counted by the normal digital counting logic. The division factor is called *prescaler factor*, see table on previous page. For example, the 2.7 GHz input has a value of 16. That means that an input C frequency of, e.g., 1.024 GHz is transformed to 64 MHz.

Prescalers are designed for optimum performance when measuring stable continuous RF. The prescalers have a nasty habit, and that is that they are not stable and would like to self-oscillate when there is no input signal present. To prevent a prescaler from oscillating, the prescaler incorporate a “go-detector.” The go-detector continuously measures the level of the input signal and simply blocks the prescaler output when no signal, or a signal that is too weak is present.

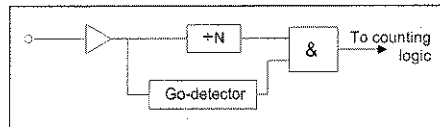

Fig. 6-5 Go detector in the prescaler.

Burst Frequency and PRF

A burst signal as in Figure 6-6 is an AM modulated signal with 100% modulation depth. The signal has a carrier wave (CW) frequency and a modulation frequency, also called the pulse repetition frequency (PRF), that switches the CW signal on and off.

With PM6685's built-in measurement control facilities, you can measure burst signals without the external arming signals that traditional counters need. You can also make measure-

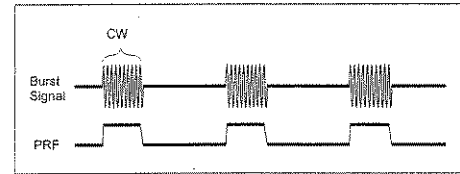



Fig. 6-6 Burst signal.

ments using external arming signals with the counter. See Chapter 7 “Measurement Control” about arming and arming delay.

 When measuring Burst A or PRF A, the maximum burst frequency is 160 MHz and the minimum number of cycles in a burst is three.

■ Triggering

Bursts with a PRF above 50 Hz can be measured with auto triggering on.

The out of sync error described under heading “Possible errors” on page 6-8 may occur more frequently when using autotrigger.

When PRF is below 50 Hz and when the gap between the bursts is very small, use manual triggering.

Try using auto once to make the counter set fixed trigger levels, it will work in most cases.

Burst PRF

The pulse (burst) repetition frequency can be measured as follows by using the PRF function in the AUX MENU:

- Press **MEAS TIME** and enter a measuring time that gives you the resolution you want.

- Switch off SINGLE.
- Press **AUX MENU**, select PRF, and press **ENTER**.
- Select channel A or C as measurement input, and press **ENTER**
- Set a sync delay longer than the burst duration and shorter than the burst repetition period. See Fig. 6-7.
- Press **ENTER** to measure.

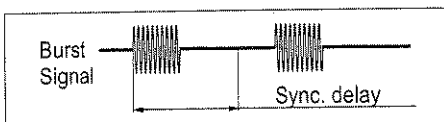

Fig. 6-7 Set the sync delay so that it expires in the gap between the bursts.

■ How does PRF work?

The PRF is the number of bursts per second. This means that the counter must count one pulse in each burst.

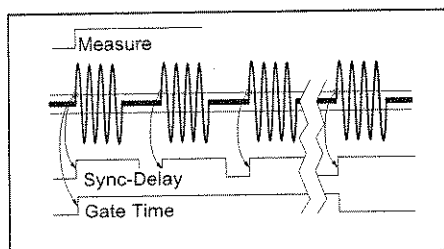

Fig. 6-8 Measuring Burst Pulse Repetition Frequency.

When the PRF function is on and the counter is triggered, all further input triggering is blocked until the PRF sync delay has expired. When correctly set, the PRF delay should expire in the gap between the bursts, making the counter ready to measure again when the next burst arrives.

The selected measuring time is not used for synchronization. It only decides how many bursts the counter should use in its averaging, i.e., the resolution.

Burst Frequency using sync. delay

You can measure the frequency on input A to 160 MHz and on input C (using PM9625 or PM9625B) to 2.7 GHz with the internally synchronized BURST function as follows:



Internal burst synchronization works best with the PM9625 and PM9625B prescalers. You can also use PM9621 and PM9624, but with limited specifications.

- Select a measuring time that is shorter than the burst duration minus two burst frequency cycles or pulses.
- Press **AUX MENU**, select BURST, and press **ENTER**.
- Select channel A or C as measurement input, and press **ENTER**.
- Set a sync delay longer than the burst duration and shorter than the burst repetition period. See Figure 6-7.
- Press **ENTER** to measure.

■ Selecting measuring time

The measuring time must fit inside the burst. Should the measurement also include a part of the burst gap, no matter how small, the measurement is ruined. Choosing a measuring time that is too short is better since it only reduces the resolution. Making burst frequency measurements on short bursts means using short measuring times, giving a poorer resolution than normally achieved with the counter.

■ **How does the sync delay work?**

The sync delay works as an internal start arming delay; it prevents the start of a new measurement until the set sync delay has expired. See Figure 6-9.

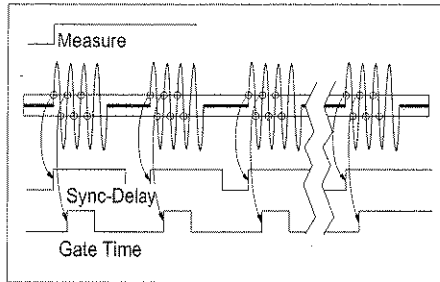

Fig. 6-9 Measuring the frequency of the carrier wave signal in a burst.

After the set measuring time has started, the counter synchronizes the start of the measurement with the second trigger event in the burst. This means that the measurement does not start erroneously during the Burst Off duration or inside the burst.

■ **Possible errors**

Before the measurement has been synchronized with the burst signal, the first measurement(s) could start accidentally during the presence of a burst. If this would happen and if the remaining burst duration is shorter than the set measuring time, the readout of the first measurement will be wrong. However, after this first measurement, a properly set start-arming sync delay time will synchronize the next measurements.

In manually operated applications, this is not a problem. In automated test systems where the result of a single measurement sample must be reliable, at least two measurements must be made, the first to synchronize the measurement

and the second from which the measuring result can be read out.

Autosync on slow-starting bursts

Burst may start a bit slowly especially RF bursts. The result when measuring the burst frequency will then be erroneous unless the first few pulses are excluded from the measurement.

A delay can be used that starts on the first negative slope of the burst, and expires when the set arm start delay ends.

■ **Preparations**

- Switch off the AUTO function
- Check that the waveform compensation shows .
- Set a suitable sensitivity

■ **Switching on burst measurements**

- Press **AUX MENU**
- Select **BURST**
- Press **ENTER**
- Select **A** or **C**
- Press **ENTER** when the display shows **SYNC DELAY**
- Enter a synchronization delay that is longer than the burst duration but shorter than the burst repetition time.
- Press **ENTER**
- Press **MEAS TIME** and select 800 ns
- Increase the measuring time until you get the number of digits you want. Take care not to increase it so much that the counter counts incorrectly

- Now the counter measures the burst frequency on the burst, starting with the first pulse

So far this description is the same as for normal burst frequency.

■ Switching on arming delay

- Press **AUX MENU**
- Select **ARM START**

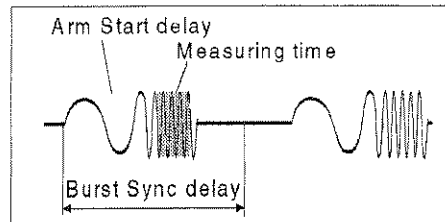



Fig. 6-10 Three time values must be set to measure the correct part of a burst

- Press **ENTER** and the display will show **POS**
- Regardless of selecting **POS** or **NEG**, the arming delay will trigger on the negative slope of the signal
- Select **DELAY ON**
- Enter a delay that equals the part of the burst that you want to mask
- Press **ENTER**

Now the counter measures on the remaining part of the burst.

 *Make sure that the delay plus meas time is shorter than the burst length.*

 *As long as burst is ON, the arming delay is triggered by the burst itself, not by the arming signal on input E.*

■ Switching off burst

Don't forget to switch off arming start when you switch off **BURST** in the **AUX MENU** or change function. Otherwise the counter will not measure unless there is an arming signal on the **E** input.

Burst Frequency using external arming

The counter can also measure burst frequencies on the **GHz** input **C** options. However, to ensure good synchronization, this requires an external synchronization signal and the use of arming and arming delay.

The counter will measure correctly when an adequate, continuous, input signal is present. When this signal disappears, however, as is the case with burst signals, the prescaler oscillates and generates an output frequency on its own. The counter would erroneously display this signal if the go-detector did not block the signal.

There is a drawback with the go-detector. It takes some time before the go-detector is convinced that an input signal is really present. It cannot enable the prescaler output immediately. The go-detector delay time is dependent on the input signal levels. High level input signals result in a fast go-detector reaction; whereas, low-level input signals mean a longer delay. The delay is at most $50\ \mu\text{s}$ for the go-detector to switch on, and 5ms for the go-detector to switch off.

This means that bursts shorter than $50\ \mu\text{s}$ cannot be measured at all unless you take "special actions" and use ext. arming for synchronization.

■ How to disable the go-detector

The counter automatically disables the go-detector when both start arming and

FREQ C are active; thus, there is no special function to enable.

■ **Do the self-oscillations disturb my burst measurement?**

The answer is yes if you start to measure immediately at the first burst cycle.

The answer is no if you are wise and use start arming delay to delay the measurement:
 $> 2 * \text{prescaling factor} * \text{period}$.

For instance when measuring 1 GHz burst frequencies using input C, the delay time should be

$> 2 * 16 * 1 \text{ ns} = > 32 \text{ ns}$. Thus, the minimum delay of 200 ns is OK.

■ **How do I set up my measurement?**

Use arming with time delay as described in the previous example.

Set up a correct burst frequency measurement as follows:

- Connect burst signal to input C.
- Connect external SYNC to input E.
- Use the **FUNCTION** key to select FREQ C.
- Set a measuring time shorter than the burst duration.
- Press the **AUX MENU** key, select ARM START, and positive slope (ARM STA+).
- Press **ENTER**.
- Enter a delay time and press **ENTER**.
- Measure.

AM Signals

The counter can usually measure both the carrier wave frequency and modulation frequency of AM signals. These measurements are much like the burst measurements described earlier in this manual.

Carrier Wave Frequency

The carrier wave (CW) is only continuously present in a narrow band in the middle of the signal. If the sensitivity is too low, cycles will be lost, and the measurement ruined.

To measure the CW frequency:

- Select a measuring time that gives you the resolution you want.
- Turn off **AUTO**.
- Press the waveform key and select symmetrical signals.
- Press **<SENS** to select the highest sensitivity and then decrease the sensitivity until the measurement result is no longer stable.
- Increase the sensitivity a couple of dB's and measure.

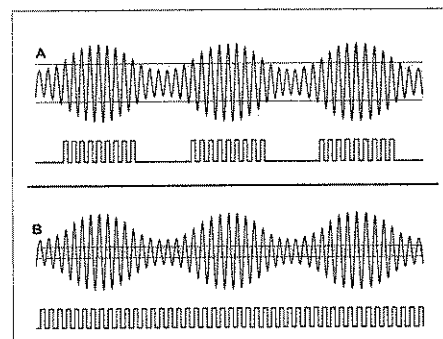

Fig. 6-11 Effects of different sensitivity when measuring the CW Frequency of an AM signal.

Modulating Frequency

The easiest way to measure the modulating frequency is after demodulation. If no suitable demodulator is available, use the PRF function to measure the modulation frequency in the same way as when measuring Burst PRF.

- Press **MEAS TIME** and enter a measuring time that gives you the resolution you want.
- Switch off **SINGLE**.
- Press **AUX MENU**, select **PRF**, and press **ENTER**.
- Select input **A** as measurement input, and press **ENTER**.
- Set a sync delay of approximately 75% of the modulating period. See Figure 6-7.
- Press **ENTER** to leave the **AUX MENU**.
- Switch off **AUTO**.
- Press the waveform key to select symmetrical signal.
- Press **SENS >** until the counter stops triggering.
- Increase the sensitivity a couple of dB's and measure.

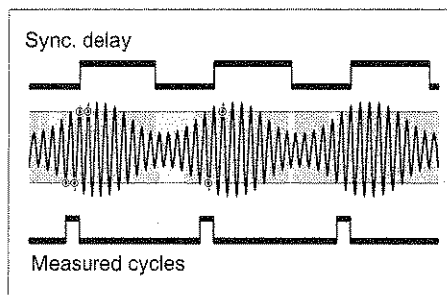

Fig. 6-12 Effects of different sensitivity when measuring the CW Frequency of an AM signal.

Ratio

To find the ratio between two input frequencies, the counter counts the cycles on two channels simultaneously and divides the result on the primary channel with the result on the secondary channel.

Ratio can be measured between A and E inputs or between C and A inputs.



The input frequency range of input E is limited to 50 MHz.

Note also that the resolution calculations are very different as compared to frequency measurements.

Period

Introduction

From a measuring point of view, the period function is identical to the frequency function. This is because the period of a cyclic signal has the reciprocal value of the frequency ($\frac{1}{f}$).

In practice there are two minor differences.

1. Where the counter calculates **FREQUENCY** as:

$$f = \text{number of } \frac{\text{cycles}}{\text{actual gate time}}$$

it calculated **PERIOD** as:

$$p = \frac{\text{actual gate time}}{\text{number of cycles}}$$

2. In the **PERIOD** mode, the counter uses no prescaler, resulting in a 160MHz maximum frequency.

All other functions and features as described earlier under "Frequency" apply to Period measurements.

Pulse Width and Duty Factor

Introduction

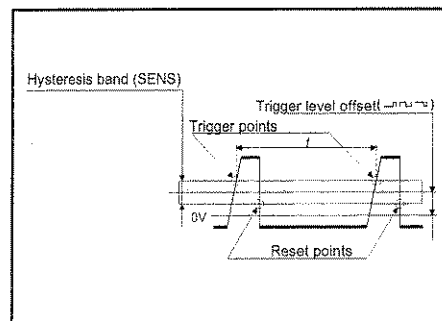

Fig. 6-13 Time is measured between the trigger point and the reset point. Accurate measurement are possible only if the hysteresis band is narrow and centered around 50 % of the amplitude.

This counter can measure Pulse Width and Duty Factor.

Triggering

If AUTO is on when these functions are selected, the counter sets a 50% trigger level and the highest possible sensitivity.

The set trigger level and trigger slope define the start and stop triggering. The manual trigger function of the counter allows only three trigger level settings. This limited selection makes it possible to trigger correctly only on signals with very steep slopes.



Always use AUTO or AUTO ONCE when measuring Pulse Width and Duty Factor.

■ Hysteresis

In pulse width measurements the trigger hysteresis, among other things, causes measuring errors. Actual triggering does not occur when the input signal crosses the trigger level at 50 percent of the amplitude, but when the input signal has crossed the entire hysteresis band. At maximum sensitivity, the hysteresis band is as small as possible, about 10 mV.

Pulse Width A

The counter measures pulse width on input A.

Normally the counter measures the positive pulse width. If you want to measure the negative pulse width, you must select negative trigger slope in the AUX MENU. The selected trigger slope controls the start trigger slope. The counter automatically selects an inverse polarity as stop slope. Thus, a selected positive slope lets the counter start measuring on the first positive slope triggering; thereafter, the first negative slope trigger event stops the counting.

Duty Factor

A duty factor (or duty cycle) measurement consists of two measurements: one pulse width measurement and one period measurement. The duty factor is then calculated as:

$$\text{Duty factor} = \frac{\text{Pulsewidth}}{\text{Period}}$$



This takes 2x the set measuring time



Totalize

TOTalize A

This mode enables you to totalize (count) the number of trigger events on channel A. Start and stop of the totalizing is manually controlled.

The counting capability is $1 * 10^{17}$ events at rates to 160 MHz.

FUNCTION Select TOT A MAN with the **FUNCTION** key.



**DISPL
HOLD**



Start and stop the totalization manually by pressing the **DISPLAY HOLD** key. Repetitive start/stops causes the counter to accumulate the number of events.

**MEAS
RESTART**



Press the **RESTART** key when you want to reset the total sum to zero.



AUTO is switched off during totalize. You must always set manual trigger level.

Chapter 7

Measurement Control

About this chapter

This chapter explains how you can control the start and stop of measurements and what you can obtain by doing that. The chapter starts by explaining the keys and the functions behind them, then gives some theory, and ends with actual measurement examples.

The measuring time changes in $\frac{1}{5}$ steps from 50 μs and up.

Range: 800 ns to 400 s. The range is divided into a continuous section between 50 μs and 400 s and a discrete section with the following steps: 800 ns, 1.6 μs , 3.2 μs , 6.4 μs , and 12.8 μs . Preset Measuring Time is 200 ms.

 If you select **SINGLE**, the set Measuring Time becomes the Display Time (time between measurements).

Measuring Time

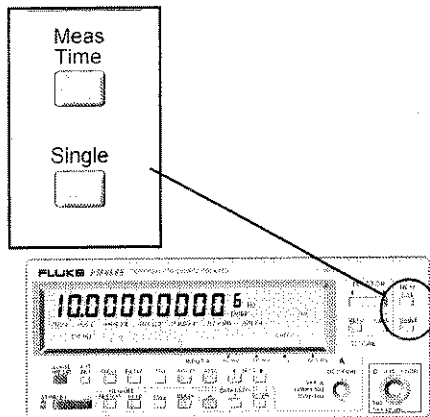

MEAS TIME



The measuring time is preset to 200ms. This gives nine digits on the display, and four measurements each second.

Increasing the measuring time gives more digits, but fewer measurements per second.

To change the measuring time:

- Press the **MEAS TIME** key.
- Increase/decrease the value by pressing the **FUNCTION** key.
- Confirm your selection by pressing **MEAS TIME** again.

■ Fine-tuning the measuring time

For times above 50 μs , you can set your own measuring time as follows:

- Press **MEAS TIME**.
- Press **SENS>** and the parameter to be set expands over the entire display.
- A cursor flashes to the left of the MSD digit. Move this cursor to the digit you want to change. Using the **<SENS>** keys.
- Change the value of the selected digit by pressing the **DATA ENTRY** keys **▲** and **▼**.
- Move the cursor to the next digit and repeat the above procedure until the display shows the desired value. Then press **ENTER** to confirm the selection.

SINGLE



When **SINGLE** is on, the counter shows the results from a single measurement cycle.

When **SINGLE** is off (default setting), the counter makes an average measurement over the set measuring time.

Use **SINGLE** when you want to measure on single-shot phenomena or when you just want fast results without the need for many digits.

The number of input periods in a SINGLE measurement depends on the prescaler factor of the input and which function is selected as follows:

Frequency A measurements: The result is the average of two consecutive periods.

Duty factor measurements: The counter does a composite measurement (one period and one pulse width).

Totalize A measurements: This is always a single measurement; the result is always from one period.

Period A, Pulse Width A Ratio A/E measurements: The result is from one period.

*Frequency C measurements:
The prescaling factor sets the number of periods used:
256 for prescaler, PM9621
16 for prescaler, PM9624
32 for prescaler, PM9625
32 for prescaler, PM9625B*

* Gate indicator

The GATE LED is on when the counter is busy counting input cycles.

Display Hold

DISPLAY HOLD Pressing **DISPLAY HOLD** freezes the result on the display. The display is not frozen until one measurement has been completed after **DISPLAY HOLD** has been pressed.



MEAS RESTART **MEAS RESTART** initiates a new measurement.



Arming

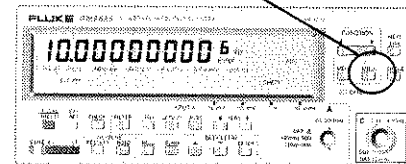

AUX MENU



External arming gives you the opportunity to start and stop a measurement when an external qualifier event occurs.

Start and stop of the arming function can independently be set to positive slope, negative slope, or switched off.

Input E on the rear panel is the arming input.

Arming is somewhat complicated, so use the examples later in this chapter to see what you can obtain by using it. There is normally no need to use arming other than in complex signals (non continuous wave).

Start Arming

Start arming acts like an EXT TRIGGER on an oscilloscope. It allows the start of the actual measurement to be synchronized to an external trigger event.

In a complex signal, you may want to select a certain part, where to perform measurements. For this purpose, there is an arming delay function which delays the actual start of measurement, with respect to the arming pulse, in a similar way as a "delayed time base" does in an oscilloscope.

Activate start arming as follows:

- Press **AUX MENU**; use the **FUNCTION** key to select **AR. START** and press **ENTER**.
- Select **POS** or **NEG** trigger slope with the **DATA ENTRY** keys, and press **ENTER**.
- Select **DELAY ON** or **OFF** with the **DATA ENTRY** keys and press **ENTER**.
- If you enabled delay, select delay time from the predefined times using the **DATA ENTRY** keys. You can also enter a delay of your own by selecting a digit with the **< SENS >** keys and increasing/decreasing that digit with the **DATA ENTRY** keys. Continue with other digits until the display shows the desired delay. End by pressing **ENTER**.

Start arming can be used for all functions except burst and PRF. If you use start arming to arm an average measurement, it only controls the start of the first sample.

Stop Arming

Stop arming prevents the stop of a measurement until the counter detects a level shift on the E input. Combining Start and Stop Arming results in an "external gate" function which determines the duration of the measurement.

Activate stop arming as follows:

- Press **AUX MENU**, select **AR. STOP** with the **FUNCTION** key, and press **ENTER**.
- Select **POS** or **NEG** trigger slope with the **DATA ENTRY** keys, and press **ENTER**.

Stop arming can be used for all functions except pulse width, duty factor, burst, and PRF.

Digit Blanking

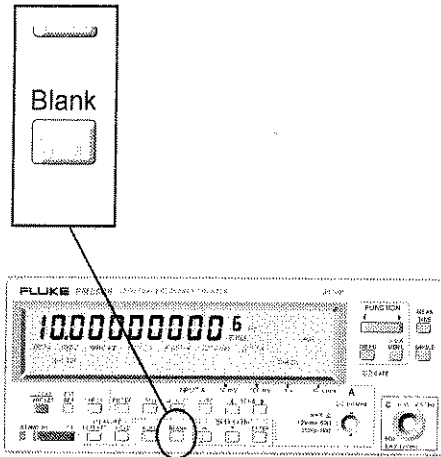

BLANK DIGITS Blanking switches off unnecessary digits on the display. Press **BLANK DIGIT** once for each digit you want blanked.

To turn off blanking, press **BLANK DIGIT** once after you have blanked all digits.

■ Two methods to reduce the number of digits

Reading a 10 digit display when you do not need more than five or six takes more time than necessary, and makes the result more difficult to read.

Reducing the measuring time gives fewer digits on the display. However, it also means that each result is shown for a shorter time, with more display updates per second. If the display is to be easy to read, it should not be updated more than a few times per second as with the default measuring time, which gives four display updates each second.

Digit blanking on the other hand, decreases the number of digits on the display without increas-

ing the display update frequency. It makes it possible to switch off any number of digits between zero and ten. This means that the number of digits displayed is zero to ten less than as calculated by the counter's truncation algorithm.

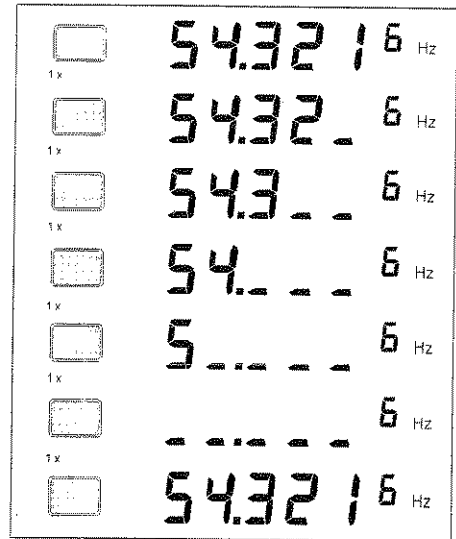

Fig. 7-1 Each press on the **BLANK DIGITS** key removes one digit.

Controlling Measurement Timing

The Measurement Process

Basic free-running measurements

Since the counter uses the reciprocal counting technique, it always synchronizes the start and stop of the actual measuring period to the input signal trigger events. In free-running mode a new measurement automatically starts when the previous measurement is finished. This is ideal for continuous wave signals.

The *start of a measurement* takes place when the following conditions have been met (in order):

- The counter has fully processed the previous measurement.
- If the counter makes SINGLE measurements, the display time (=set measuring time) must have expired.
- All preparations for a new measurement are made.
- The input signal triggers the counter's measuring input.

The measurement ends when the input signal meets the stop trigger conditions. That happens directly after one of the following events:

- The set measuring time has expired (in frequency measurements, for example).
- In SINGLE, the measurement stops immediately when the input signal fulfils the stop trigger conditions (which is normally when it passes the trigger window the second time).

Measuring Time and Measurement Rates

The set measuring time decides the length of a measurement in all *average* types of measurements. In a *single-shot* type of measurement, however, the measuring time instead acts as a "display time" setting. For example, if a measuring time of 500 ms is set in a *single period* measurement, and the period is 100 ns, the display will show the result for 500 ms before the next measurement can start.

This is important to know when you want to make fast measurements, for example, when using the GPIB bus.





To get a high measuring speed, it is not enough to set the counter for single-cycle measurements. You should also set the measuring time to the minimum value.

The time between the stop of one measurement and the start of the next one can be below 1 ms in free-running mode if you do the following:

- Do not use AUTO.
- Do not use NULL.
- Switch off the display via GPIB.

Additional controls over start and stop of measurements

Free-running measurements may be easy to understand, but measurements can get more complex.

Besides input signal triggering, the *start* of a measurement is further controlled by the following elements:

- Manual **MEAS RESTART**, if Display Hold is selected.
- GPIB triggering (<GET> or *TRG), if bus triggering is selected.
- External arming signal, if Start Arming is selected.
- Expired start arming delay, if Arming Delay is selected.

In addition to expired measuring time and stop signal triggering, the *stop* of measurement is further controlled by:

- External arming signal triggering, if Stop Arming is selected.

GPIB triggering is described in the Programmer's manual. Now let's look deeper into the concept of *arming*.

Resolution as function of measuring time

The quantization error and the number of digits on the display mainly define the resolution of the counter, that is the least significant digit displayed.

As explained on page 6-4 under Reciprocal Counting, the calculated frequency f is:

$$f = \frac{n}{t_g}$$

while the relative rms quantization error = $\pm 250\text{ps}/t_g$.

The counter calculates the mantissa of f with up to 15 digits. However, the number of justified digits depends on the selected measuring time and the measured frequency, and is much more limited.

The counter truncates irrelevant digits so that the rms quantization resolution cannot change the LSD (least-significant digit) more than ± 2.5 units. This is when the displayed value is 99999999, and the quantization error is worst case.

 ± 1 unit in 99999999 (=1E8) means 10 times more relative resolution than ± 1 unit in 10000000 (=1E7), despite the same number of digits.

In practice, the quantization error is two to three times better than the specified value, and the measured value can range from 10000000 to 99999999. Therefore, in practice the quantization uncertainty shown as instability in the LSD can range from 0.25 to 2.5 LSD units.

A gradual increase of the measuring time reduces the instability in the LSD caused by the quantization uncertainty. At a specific measuring time setting, the counter is justified to display one more digit. That one additional digit

suddenly gives ten times more display resolution, but not a ten times less quantization uncertainty. Consequently, a measuring time that gives just one more display digit shows more visual uncertainty in the last digit.

For a stable LSD read out, the maximum measuring time selected should be one that still gives the required number of digits. Such optimization of the measuring time enables the total resolution to be equal to the quantization resolution. This is shown in Figure 7-2 as a function of the selected measuring time.

What is arming?

Arming is a pretrigger condition ("qualifier") that must be fulfilled before the counter allows a measurement to start. The pretrigger condition can be compared to using a gun. When you use a gun, you must first *arm* the gun before you can pull the *trigger*.

Arming can also be used to qualify the stop of a measurement. This is called "stop arming" as opposed to the more common "start arming."

When you use arming, you disable the normal free-run mode, i.e., individual measurements must be preceded by a valid start arming signal transition.

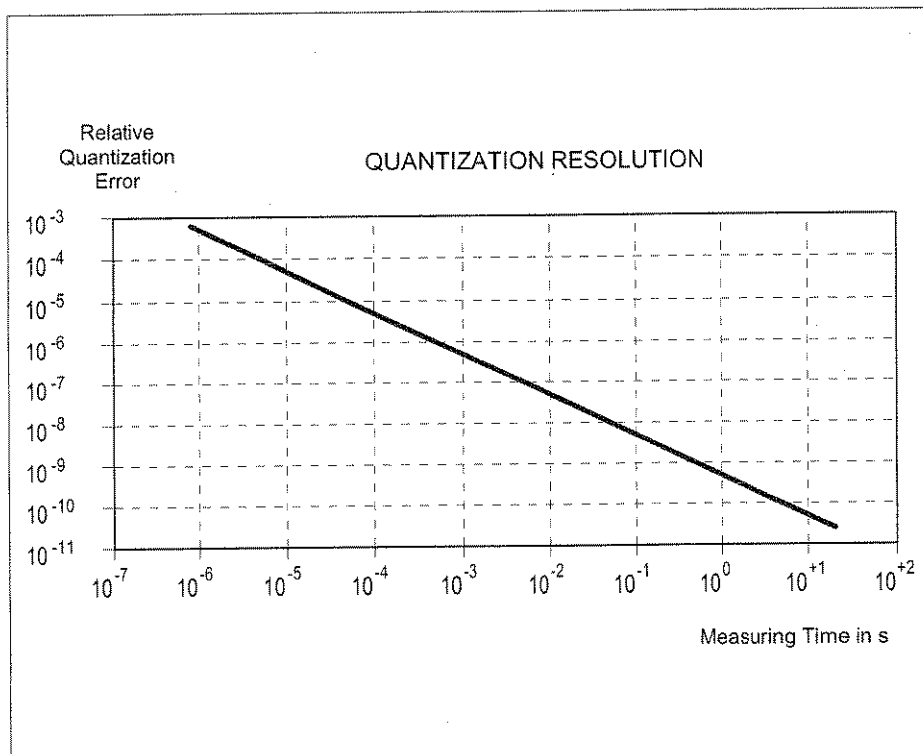

Fig. 7-2 Resolution as a function of measuring time.

7-8 Digit Blanking

If you use start arming and stop arming together you get an externally controlled measuring time.

■ Manual arming

The counter has a manual arming function called **DISPLAY HOLD**. Here you manually arm individual measurements one-by-one by pressing the **RESTART** key.

Use this manual arming mode to measure single-shot phenomena, which are either triggered manually or occur at long intervals. Another reason for using this manual arming could simply be to allow sufficient time to write down individual results.

■ When do I use start arming?

Start arming is useful for measurements of frequency in signals, such as the following:

- Single shot events or non-cyclic signals.
- Burst signals.
- Signals with frequency variations versus time ("profiling").
- A selected part of a complex waveform signal.

Signal sources that generate complex waveforms like pulsed RF, pulse bursts, tv line signals, or sweep signals, usually also produce a *sync* signal that coincides with the start of a sweep, length of an RF burst, or the start of a tv line. These sync signals can be used to arm the counter. See Figure 7-3.

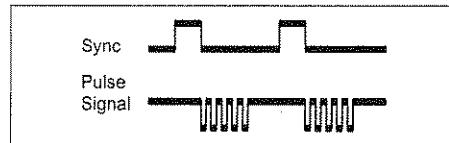

Fig. 7-3 A synchronization signal starts the measurement when start arming is used.

■ When do I use stop arming?

You normally use stop arming together with start arming. That means that the external gating signal controls both the start and the stop of the measurement. Such a gating signal can be used to force the counter to measure the frequency of a pulsed RF signal. Here the position of the external gate must be inside a burst. See Figure 7-4.

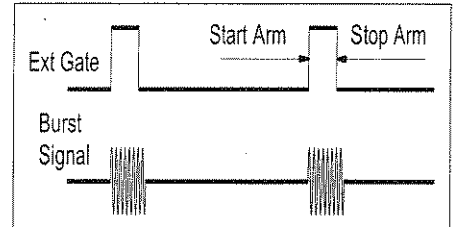

Fig. 7-4 Start and stop arming together is used for burst signal gating.

■ The Arming input

Input E is the arming input. This input is suitable for arming (sync) signals that have TTL levels. The trigger level is fixed at 1.4V and cannot be changed. The trigger slope can be set to positive or negative.

■ When do I use arming with delay?

You can delay the start arming point with respect to the arming signal. Use this function when the external arming signal does not coincide with the part of the signal that you are interested in.

The range for time delay is 200 ns to 1.6 seconds with a setting resolution of 100 ns.

■ Getting the whole picture

The flowchart in Figure 7-5 illustrates how *arming* enables precise control of the start and stop of the actual measurement when you operate the counter from the front panel. If you use the counter via the GPIB, read more about bus arming and triggering under the heading "How to use the trigger system" in Chapter 18, "Trigger Subsystem" of the GPIB Programming Manual.



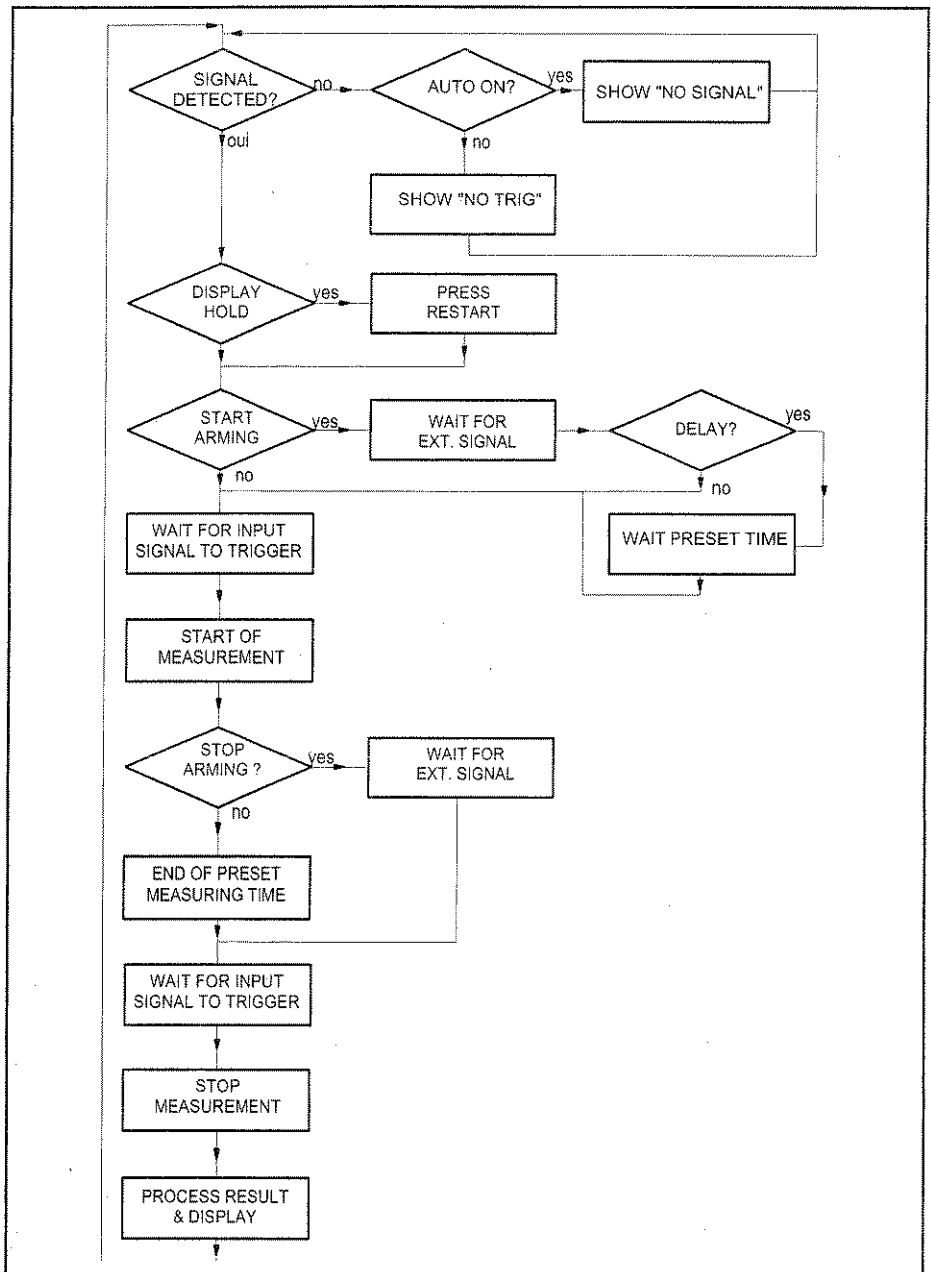

Fig. 7-5 Measurement control flow diagram.

Arming Set Up Time

The arming logic needs a set up time of about 5 nanoseconds before the counter is really armed; see Figure 7-6.

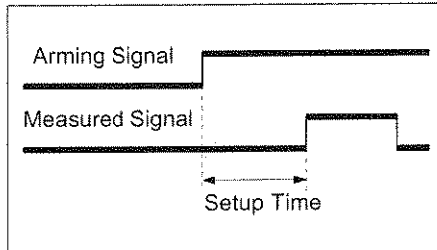

Fig. 7-6 Time from active external control edge before the measurement is armed: E channel . < 5 ns

When arming delay is selected, the set up time is different; see Figure 7-7. It illustrates the effect of the 100ns delay resolution.

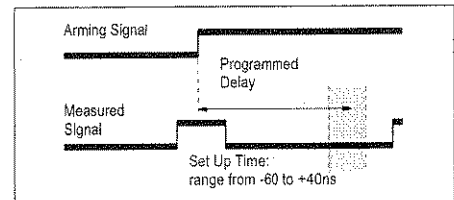

Fig. 7-7 Time from expired time delay until the measurement is armed: -60 to +40 ns.

Figure 7-7 shows that a start trigger signal may be detected although it appears 60 nanoseconds before the programmed time delay has expired. The start trigger signal must come 40 nanoseconds after the programmed time delay has expired to guarantee correct start of the measurement.

Arming Examples

Example #1:

Measuring pulse width in a pulse burst

In the first example we will measure the width of pulse #1 in a repetitive pulse burst. In this example, a synchronization signal (SYNC) with TTL levels is also available. See Figure 7-8.

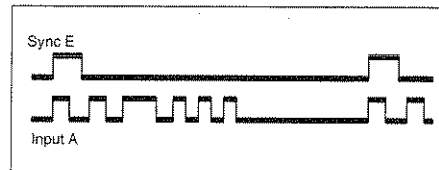

Fig. 7-8 Synchronizing the measurement so that the pulse width of the first pulse is measured.

Our task is to synchronize the start of the measurement (start trigger) to the leading edge of the first pulse. Depending on the signal timing, this can be easy, difficult, or very difficult.

■ A. Auto synchronization without arming

If we are lucky, we can manage without using the arming function at all. Often, the counter can automatically synchronize the measurement start to the triggering of the first pulse. The conditions for success are that the pulse burst does not repeat itself more than 50 to 150 times per second. The duration of a pulse burst (between first and last pulse) must be substantially less than the distance to the next burst.

Do the following steps to perform auto synchronization without arming:

- Connect the burst signal to input A.
- Adjust the manual sensitivity and trigger level until the burst signal triggers the counter correctly.
- Use the **FUNCTION** key to select Pulse Width.
- Select **SINGLE** measuring mode.
- Press **MEAS TIME** and set a measuring time according to the following text.

The measuring time setting can be used for synchronization purposes. The preset measuring time does not influence the actual measurement time in single interval measurements, but it will influence the time between measurements. If

Example #1: 7-13

you select a measuring time that almost equals the duration of a burst, the auto-synchronization will work.

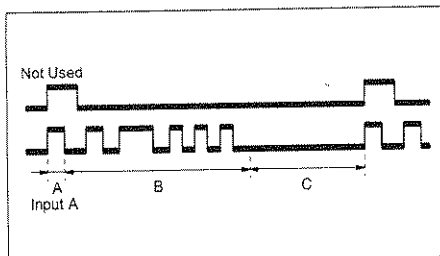

Fig. 7-9 A= Measure
 B= Process time + display time(=set measuring time) minimum 3 to 4 ms
 C= Waiting for next input signal trigger event.

If the repetition rate is too high, synchronization will not be guaranteed, but there is a high probability that auto-synchronization will work anyway. However occasional erroneous values will be displayed. To achieve guaranteed synchronization, use the Start Arming function.

■ **B. Synchronization using start arming**

The SYNC signal can be directly used to arm the measurement. This requires that the leading edge of the SYNC signal occurs more than 5 nanoseconds before the leading edge of the first pulse in the burst. See the Figure 7-10.

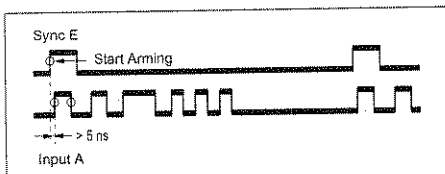

Fig. 7-10 Synchronization using start arming.

Do the following steps to perform synchronization using start arming:

7-14 Example #1:

- Connect SYNC to input E.
- Connect the burst signal to input A.
- Adjust the manual sensitivity and trigger level until the burst signal triggers the counter correctly.
- Press **AUX MENU**, select **ARM START**, and select arming on positive slope (**ARM STA+**).
- Use **FUNCTION** key to select **Pulse Width**.
- Press **MEAS TIME** and set a short measuring time.
- Select **SINGLE** measuring mode and measure.

If there is no (or too little) time difference between the arming signal and the first pulse in the pulse burst, arming must be combined with a delay. See example c.

■ **C. Start signal synchronization using start arming with time delay**

If the pulse bursts have a stable repetition frequency, you synchronize the measurement using Start Arming with Time Delay. Here you use the SYNC pulse belonging to a preceding burst to synchronize the start of measurement. Set the time delay to a time longer than the duration of a pulse burst and shorter than the repetition time of the pulse bursts. See Figure 7-11.

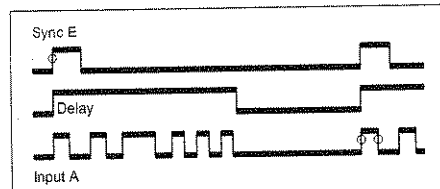

Fig. 7-11 Synchronization using start arming with time delay.

Do the following steps to start signal synchronization using start arming with time delay:

- Connect SYNC to input E.
- Connect the burst signal to input A.
- Adjust the manual sensitivity and waveform until the burst signal triggers the counter correctly.
- Press the **AUX MENU**, select **ARM START**, and arming on positive slope (**ARM STA+**), and press **ENTER**.
- Select 'delay ON' using **DATA ENTRY** keys and press **ENTER**.
- Enter a suitable delay, and confirm with **ENTER**.
- Use **FUNCTION** key to select Pulse Width.
- Press **MEAS TIME**, and set a short measuring time.
- Select **SINGLE** measuring mode, and measure.

Example #1: 7-15

Example #2

Measuring frequency in two-tone bursts

Sonar bursts can consist of two different frequencies with different durations. See Figure 7-12

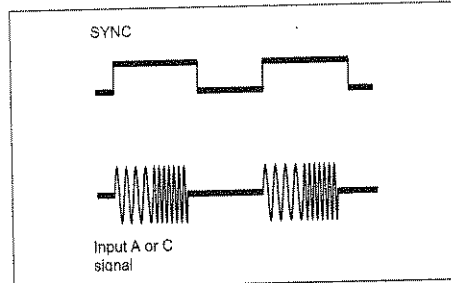

Fig. 7-12 A two-tone burst with its sync-pulse.

To measure the frequency of the first part is normally no problem. Because of the reciprocal measurement, the counter automatically synchronize the measurement with the start of the burst. And for fool-proof synchronization, start arming can be used, as in Figure 7-13. The measuring time should of course be short enough.

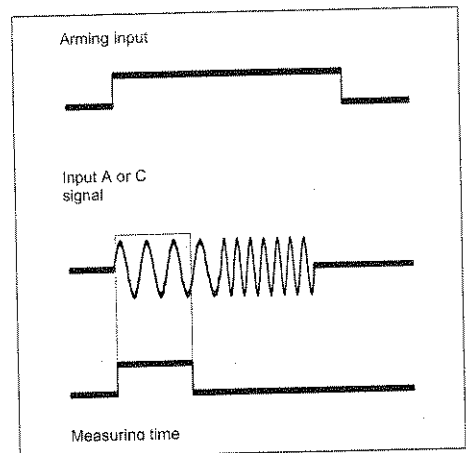

Fig. 7-13 Autosync or external arming makes it possible to measure the first tone in the burst.

To measure the frequency of the second half requires the use of arming delay. The delay time should be set to a value slightly longer than the duration of the first tone in the two-tone burst. See Figure 7-14.

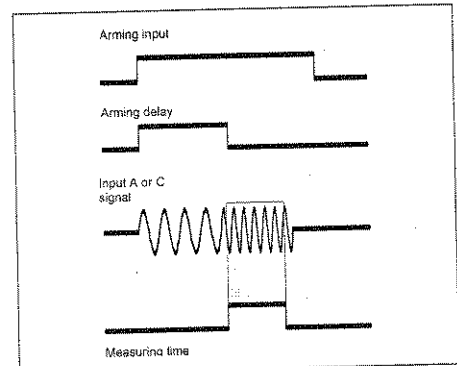

Fig. 7-14 Add a delay to the External arming, and the second tone can be measured.

Example #3

Profiling

Profiling means measuring frequency versus time. Examples are measuring warm up drift in signal sources over hours, measuring the linearity of a frequency sweep during seconds, VCO switching characteristics during milliseconds, or the frequency changes inside a "chirp radar" pulse during microseconds. The counter can handle many profiling measurement situations. Profiling can theoretically be done manually, i.e., by reading individual measurement results and plotting in a graph. However, to avoid getting bored long before reaching your 800th or so measurement result, you must use some computing power and a counter with GPIB interface. In profiling applications, counter acts as a fast, high resolution sampling front end, storing results in its internal memory. These results are later transferred to the controller for analysis and graphical presentation.

You must distinguish between two different type of measurements called *free-running* and *repetitive sampling*.

■ Free-running measurements

Free-running measurements are performed over a longer period, e.g., to measure the stability over 24 hours of oscillators, to measure initial drift of a generator during a 30-minute warm-up time, or to measure short-term stability during 1 or 10s. In these cases, measurements are performed at intervals from half a millisecond and upwards. In other words, the maximum sampling rate is 1.6 kHz. There are several different ways of performing the measurements at regular intervals.

Single-cycle measurements using measuring time setting for "pacing"

When single measurements are set on the counter, the measuring time acts as a "measurement hold time". By setting the measuring time to 10s for example, single-cycle measurements are automatically made at 10s intervals.

Using a controller as "pacer"

With fairly large intervals such as seconds between individual samples, the timer in the controller can be used for pacing the individual measurements.

Using external arming signals

External arming signals can also be used for "pacing." For example with an arming signal consisting of 10 Hz pulses, individual measurements are armed at 100 ms intervals.

Letting the counter run free

When the counter is free running, the shortest distance between measurements is approximately 600 μ s plus set measuring time. For example when a measuring time of 2 ms is set, the time between each sample is approximately 2.6 ms. You have to perform some special actions in search of that high speed, for instance blanking the display. This is described in Chapter 19 of the Programming Manual.

■ Repetitive sampling profiling

The measurement setup just described will not work when the profiling demands less than 600 μ s intervals between samples.

How to do a VCO step response profiling

- With 100 samples during a time of 10 ms, i.e., 100 μ s between samples.

This measurement scenario requires a repetitive input step signal, and you have to repeat your measurement 100 times, taking one sample per switch period. And every new sample should be delayed 100 μ s with respect to the previous one.

This is easiest controlled by a controller, although it is possible but tedious to manually set and perform all 100 measurements.

The following are required to set up a measurement:

- A repetitive input signal (e.g., frequency output of VCO).
- An external SYNC signal (e.g., step voltage input to VCO).
- Use of arming delayed by a preset time (e.g., 100, 200, 300 μ s).

See Figures 7-15 and 7-16.

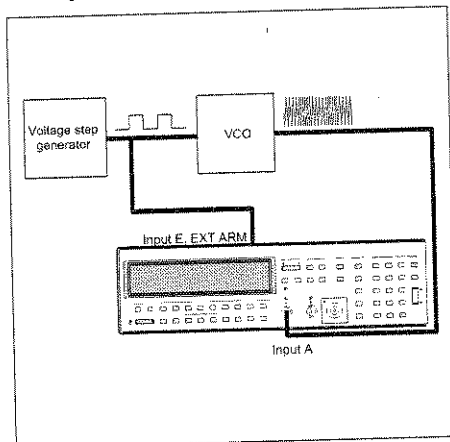

7-15 Set up for transient profiling of a VCO.

When all 100 measurements have been made, the results can be used to plot frequency versus time. Note that the absolute accuracy of the time scale is dependent on the input signal itself. Although the measurements are armed at 100 μ s \pm 100 ns intervals, the actual start of measurement is always synchronized to the first input signal trigger event after arming.

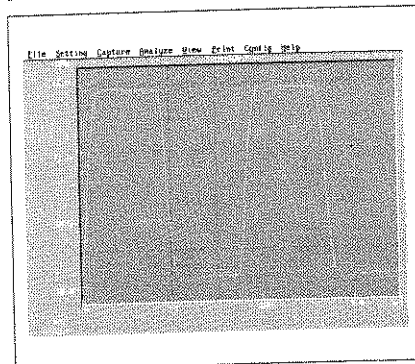

Fig. 7-16 Results from a transient profiling measurement.

7-18 Example #3

Chapter 8

Processing

Introduction

Two different ways to process a measuring result are available: Averaging and Nulling.

Averaging

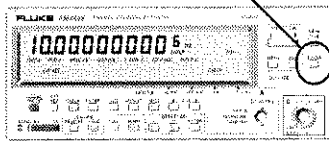
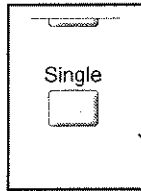

SINGLE



If **SINGLE** is switched off, the counter makes a multiple period average. That means that it averages all data captured during the set measuring time and displays the result.

Nulling

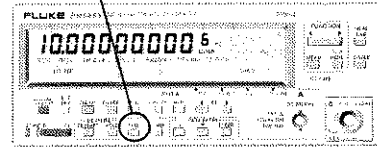
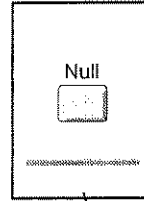

NULL



One press on the **NULL** key stores the current by displayed result, then shows all the following results as deviation from that result.



*It can be difficult to freeze the display in exactly the right moment when all ten digits show the desired value. Don't worry, you can display and change the null value by entering the **AUX MENU**.*

To show the stored nulling value:

- Press **AUX MENU**, select **NULL** with the **FUNCTION** key and press **ENTER**.

To change the value:

- Press the **< SENS >** keys to select the digit you want to change and press the **DATA ENTRY ▲ ▼** keys to change the value.
- Press **ENTER**, and the new value is stored.

■ Manually entering a null value

When nulling is off:

- Press the **AUX MENU** key
- Select **NULL** with the **FUNCTION** key
- Press **ENTER** and the display shows the previous Null value (if any).
- To use the shown value, press **ENTER**.
- To change the value, press the **< SENS >** keys to select the digit you want to change, and increase/decrease the digit with the **DATA ENTRY ▲ ▼** keys. Repeat these steps for all digits you want to change, then exit the **AUX MENU** by pressing **ENTER**.

The **NULL** annunciator on the display is switched on and the display shows the deviation from the entered value.

Chapter 9

Auxiliary Functions

About this chapter

This chapter describes less commonly used functions that are “hidden” in the auxiliary menu.

Auxiliary Menu

Introduction

All the counter’s measuring logic and input settings are computer controlled. The ability to select, combine, and add new functions is limited only by the number of controls on the front panel.

To keep the normal operation of the counter as simple as possible, the use of dual or triple function keys has been avoided. For the same reason the number of keys has been restricted, however, the counter contains many “hidden” features. The **AUX MENU** key gives you access to all the extras that are not generally found in a traditional counter.

If you frequently need to use some AUX MENU functions, we recommend that you save your favorite complete front panel setup in one of the 19 memory locations for easy recall later.

You can use such preprogrammed settings as default settings for your particular applications, from which you can manually modify the various individual control settings.

When you select something in the AUX MENU, that cannot otherwise be indicated, an AUX annunciator on the display is switched on.



The AUX annunciator shows only that a change has been made in the AUX MENU. The unique settings that have been made are not shown on the display.

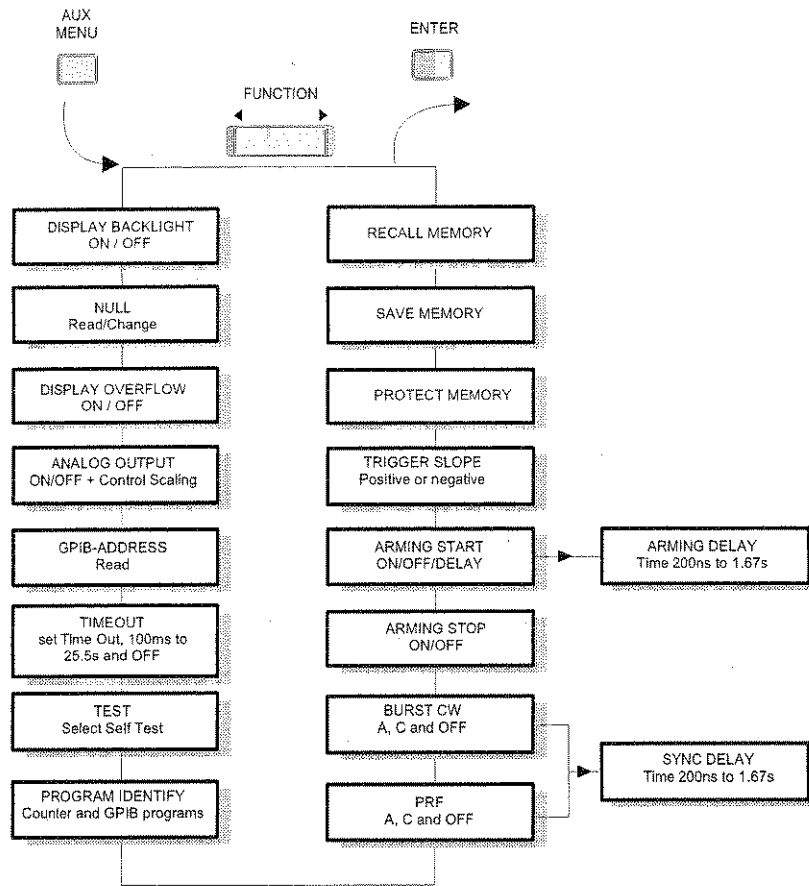

Fig. 9-1 You will enter the AUX MENU at the same selection as you used the previous time, except after power on when you enter the menu at RECALL. To recall the last setting before power off, recall memory 0.

**Plain English AUX MENU
Commands**

**AUX
MENU**



FUNCTION



ENTER



The selection of functions from the menu that you find when you press the **AUX MENU** key is simple. Just scroll through the list with the **FUNCTION** key until you find the function you are locking for. Pressing **ENTER** will select the function or take you to a submenu with more selections.

The texts on the display are messages in abbreviated English. However, the ability to express oneself using ten, 7-segment indicators is somewhat limited. Here is a list of all display messages with explanations.

AnALoG Out

Analog output ON/OFF and scaling factor

Ar. StArt

Arming Start

Ar. StOP

Arming Stop

bUrSt

Burst Frequency

bUS 1.23

Identity of the GPIB firmware

dISP. L ight

Display light

dISP. OFL.

Display overflow

Err. ProtEc

You tried to save a front panel setting while the memory was protected

GP Ib Addr

GPIB Address Read/Set

InStr. 1.23

Identity of the Instrument firmware

NEG

Negative

No bUS

No GPIB interface is installed

NULL

Null

OFF

Off

On

On

POS

Positive

PrF

PRF Pulse Repetition Frequency

Prog. Id. n.

Program Identity

ProtEc

Memory Protect Menu

rEcALL

Recall from memory position 0 to 19.

SAVE

Save in memory position 1 to 19

Sync. dLy.

Synchronization delay

tEST

Enter the test submenu

tEST ALL

All tests in sequence



tEst AS IC

Test of measurement logic

tEst dISP

Display test

tEst rA.

Internal RAM test

tEst rO.

Internal ROM test

t i. Out

Timeout menu

tr 19 SLOPE

Trigger slope

Recall

Recalls one of the 20 previously stored front panel settings. Press **AUX MENU**, select **RECALL** and press **ENTER**, then select one memory location from zero to 19, with the **DATA ENTRY** keys and confirm by pressing **ENTER**.

Memory 0 always contains the settings the counter had when it was last turned off.

The memory annunciator is on as long as the recalled setting remains unchanged.

If the memory annunciator is on when you turn off the counter, it will recall that memory automatically when the counter is turned on again.

Save

Saves the current front panel setting in one of the 19 front panel memory locations. Press **AUX MENU**, select **SAVE** and press **ENTER**, then use the **DATA ENTRY** keys to select an unused memory location between 1 and 19. Confirm by pressing **ENTER**.



The **MEMORY** annunciator is only on as long as no changes from the saved setting have been made.

Memory protect

Protects memory 10-19 from accidental overwrite, just like the write-protect tab on a diskette.

Trig slope

Selects what slope the counter should trigger on. The default trigger slope is positive. Changing to negative trigger slope enables you to measure negative pulse width and duty factor.

Changing slope makes normally no sense in frequency, period or ratio measurements.



Selecting negative trigger slope means that the maximum input frequency of the counter decreases to 160 MHz.

Arming Start

Selects if the counter should free-run, or if a separate signal must arm the start of each measurement. Press **AUX MENU**, select **AR.START**, press **ENTER**, select **POS**, **NEG** or **OFF**, and press **ENTER**. If you select **POS** or **NEG**, the display shows **DELAY OFF**. Select **ON** and you can enter a delay from the arrival of the arm start signal and the actual start of a measurement. Press **ENTER** to exit the menu.

Arming Stop

Selects if the counter should stop measuring when the measuring time expires, or if a separate signal must arm the stop of each measurement. Press **AUX MENU**, select **AR.STOP**, and press **ENTER**. Select **POS**, **NEG** or **OFF** and press **ENTER**.

Burst Frequency

Turns the burst frequency function on or off and select measuring input. Read the explanation of this function in the Chapter 6 "Measuring Functions".

PRF

Turns the burst PRF function on or off and select measuring input. Read the explanation of this function in the Chapter 6 "Measuring Functions".

Program Identity

Shows the firmware version of the instrument and the GPIB interface.

Test

In the Test menu, you can choose to run tests used in the power up test one at a time:

- Select the test submenu by pressing the **FUNCTION** key until the display shows **TEST**.
- Enter the test menu by pressing the **ENTER** key.

Selections for internal self-tests are as follows:

- TEST ALL (the four tests below in sequence)*
- TEST DISP (Display Test)*
- TEST Logic (Measuring Logic)*
- TEST RA (RAM)*
- TEST RO (ROM)*

If any fault is detected, an error message will appear on the display and the program halts. Possible error messages are as follows:

- Internal ROM test failed.
- Internal RAM test failed. The hex-address where an error is detected is shown.
- Test of measuring logic failed.



The display test turns on all segments of the display for a visual inspection. No failure is reported. Press ENTER to end the test.

If an error message is displayed, press any key to make the instrument continue even though an error was detected. Contact your Local Service Center for repair.

Time Out

Turns the time out on and off for measurements. Use the **DATA ENTRY** keys to change. If you select ON, you enter a submenu where you can set the value of the timeout. Timeout is a programmable stop for a measurement in progress. The timeout starts when the counter starts a measurement, and it interrupts the measurement if a result is not ready within the timeout period.

The range is 100 ms to 25.5 s. Preset timeout is OFF.



The timeout is mainly used for GPIB applications.

GPIB Address

Shows and changes the GPIB address. The new address is stored in nonvolatile memory and remains until changed again via this menu, the address switches on the rear panel or via a bus command.

This means that the address of the counter can differ from the address indicated by the switches on the rear panel.



 *The last set address is the valid address whether it is set via the aux menu, address switches or GPIB command.*

The counter shows the used address during the power up test.

Analog Output (GPIB option only)

The analog output is turned off as a default. You turn it on/off and set the scaling factor under ANALOG OUT in the aux menu.

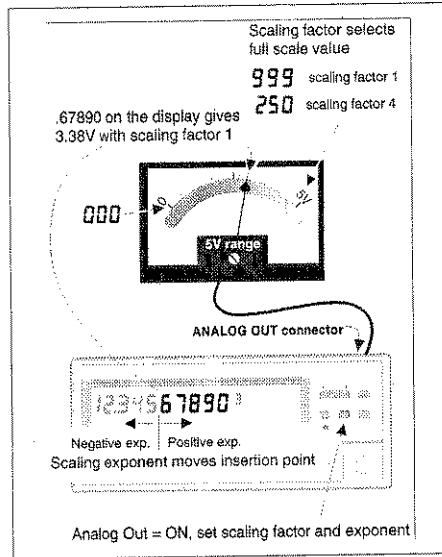

Fig. 9-2 The analog output function.

Scaling factor

The scaling factor has two functions:

- It's exponent selects which digits to output on the analog output
- It's value sets what reading should represent full scale

As default, the scaling factor is 1 (1E0). This means that the full scale value is 0.999 and the analog output converts the fraction (digits to the right of the decimal point) to a voltage.

The scaling factor should be:

$$\text{Scaling factor} = \frac{1}{\text{full scale value}}$$

where full scale value is the value for which you

want the analog output to output its maximum voltage (5 V).

Example:

- Take a measurement result, for instance: 12.34567890 E+6 Hz
- Represent this result without exponent: 12345678.90 Hz
- Multiply this value with the scaling factor, for instance 0.001. 12345.67890
- Take the fractional part of the result: .67890
- This is the value that will determine the output voltage, .00 will give 0 V and .99 will give 5 V. this means that "our" reading will give .67890*5=3.3945 V. This is output as 3.38 V due to the 0.02 V resolution of the analog output.

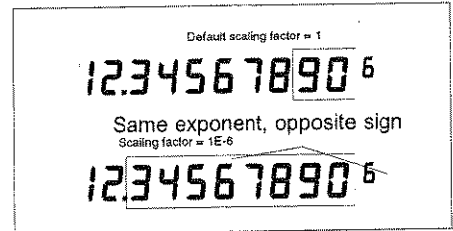

Fig. 9-3 To use the shown decimal point as reference; set the exponent of the scaling factor to the same value as the exponent of the measurement result but with opposite sign.

■ Resolution

The analog output range is 0 to 5 V in 250 steps, so one step is 0.02 V. If the scaling factor is 1, one such step is taken each time the display changes with X.004, and if the scaling factor is 4, one step is taken each time the display changes with X.001.

The X in the above paragraph can be any digit and does not influence the output voltage. If the display changes from 0.996 to 1.000, the voltage drops from 4.98 V to 0V. If the display value increases further, the output voltage starts to increase again, see Figure 9-4.

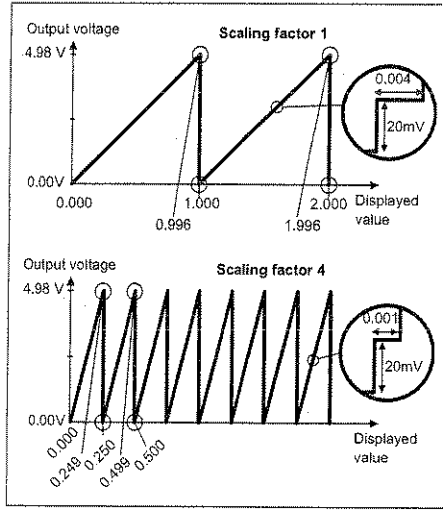

Fig. 9-4 Output voltage versus displayed value for two different scaling factors.

Display overflow

Display overflow makes it possible to make 12-digit measurements. When OVERFLOW is on and the measurement justifies 11 or 12 digits, the OVERFLOW annunciator turns on, and the counter truncates one or two MSD:s and shows one or two extra LSD:s instead. You have to keep track of the decimal point yourself, compare the values with overflow on and off to see if one or two overflow digits are shown when the OVERFLOW annunciator is on.

Using OVERFLOW with display hold

When display hold is active, The enter key toggles overflow on/off. If the counter has measured a result with more than 10 digits and you press ENTER, the OVERFLOW annunciator will switch on and the display show the additional digits. The counter is designed this way because switching on overflow in the AUX MENU will initiate a new measurement. This is undesirable if you want to study a single shot phenomena or a long term totalizing.

In totalizing the result can be up to 10^{17} , that is 17 digits, but overflow will not show more than 12 digits.

Null

The null function stores the result currently displayed, then shows all the following results as deviations from that result.

You store the current display reading by pressing the **NULL** key on the front panel. You can read and change the stored result in the **AUX MENU**.

When **NULL** is on:

- Press **AUX MENU**
- Select **NULL** with the **FUNCTION** key.
- Press **ENTER** and the display will show the stored value.

Change the value in 1-2-5 steps with the **DATA ENTRY** keys, or select what digit you want to change with the **SENS** keys and change it with the **DATA ENTRY** keys.

- When the display shows the desired value, press **ENTER**.

As default the null value is negative and subtracted from the new readings, but you can also enter a positive null value.

Turn off the nulling by pressing **NULL** again.

If you want to turn on nulling without storing the currently displayed value but keep the old one, press **AUX MENU**, select **NULL** and press **ENTER** twice.

Display light

You can turn the display backlighting on or off:

- Press **AUX MENU**
- Select **DISP LIGHT** with the **FUNCTION** key
- Press **ENTER**
- Select **ON** or **OFF** with the **DATA ENTRY** keys
- Press **ENTER** again to exit the aux menu.

Chapter 10

Performance Check

General Information

WARNING: Before turning on the instrument, ensure that it has been installed in accordance with the installation instructions outlined in Chapter 3 of this manual.

This performance procedure is intended to do the following:

- Check the instrument's specification.
- Be used for incoming inspection to determine the acceptability of newly purchased instruments and recently recalibrated instruments.
- Check the necessity of recalibration after the specified recalibration intervals.



The procedure does not check every facet of the instrument's calibration; rather, it is concerned primarily with those parts of the instrument which are essential for determining the function of the instrument.

It is not necessary to remove the cover of the instrument to perform this procedure.

If the test is started less than 30 minutes after turning on the instrument, results may be out of specification, due to insufficient warm-up time.

Recommended Test Equipment

Type of instrument	Required Specifications	Suggested Instrument
LF Synthesizer	Square; Sine up to 10 MHz	
Power Splitter	50 Ω	PM9584/02
T-piece		
Termination	50 Ω	PM9585
Reference oscillator	10 MHz $\pm 1 * 10^{-8}$ for standard oscillator and TCXO	Fluke 908, or a counter with calibrated PM 9691*)
	10 MHz $\pm 1 * 10^{-9}$ for PM9691 and PM9692.	Fluke 909 910R, PM6685R or PM6681R*)
	10 MHz $\pm 1 * 10^{-11}$ for PM6685R.	Fluke 910R or Cesium Standard
HF signal generator	500 MHz (no option) 1.5 GHz (PM9621) 3 GHz (PM9624) 5 GHz (PM9625(B))	
Pulse Generator	to 125 MHz	PM5786B
Oscilloscope	350 MHz	
BNC-cables	5-7 cables**)	PM9588

Table 10-1 Recommended Test Equipment

*) This test equipment is needed if an option is installed.

**) Two of the cables must have 10 ns difference in delay, for example: 5 ns and 15 ns.

Preparations



Power up your instruments at least 30 minutes before beginning the performance check to let the instrument reach normal operating temperature.

Failure to do so may result in certain test steps not meeting equipment specifications.

Front Panel Controls

Power-On Test

At power-on the counter performs an automatic self-test of the following:

- Microprocessor
- RAM
- ROM
- Measuring circuits
- Display

If a GPIB interface is installed, the GPIB address is displayed.

If there are any test failures, an error message is shown.

- Turn on your counter and check that all segments light up on the display and that no error message appears.

Internal Self-Tests

The built-in test programs from the power-on test can also be activated from the front panel as follows:

- Enter the Auxiliary Menu by pressing **AUX MENU**.
- Select the test submenu by pressing **DATA ENTRY** up or down.
- Enter the test menu by pressing the **ENTER** key.

Selections for internal self-tests are as follows:

- 1 *TEST RO (ROM)*
- 2 *TEST RA (RAM)*
- 3 *TEST ASIC (Measuring Logic)*
- 4 *TEST DISP (Display Test)*
- 5 *TEST ALL (Test 1 to 4 in sequence)*

- Use **DATA ENTRY** up/down to select **TEST ALL**, then press **ENTER**.
- If any fault is detected, an error message appears on the display and the program halts.
- If no faults are detected, the program returns to measuring mode.

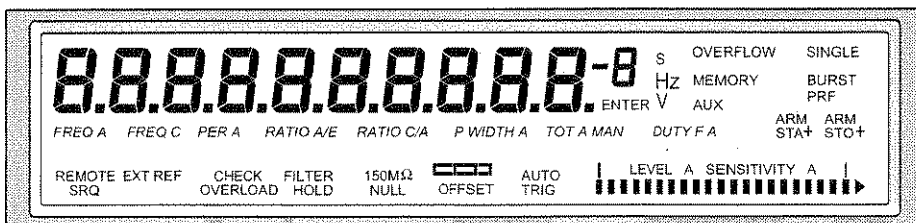





Fig. 10-1 Text on the display

Keyboard Test

The keyboard test verifies that the counter responds when you press any key. To check the function behind the keys, see the tests further on in this chapter.

Press the keys as described in the left column and look on the display for the text, as described in the second column. Some keys change more text on the display than described here. The display text mentioned here is the text mostly associated with the selected key.

Key(s)	Display	Note	Pass /Fail
Standby	Display Off	Red LED beside the key On	
ON	Back light on		
PRESET Local	DEFAULT? NO SIGNAL	Default setting	
Ext Ref	EXT REF		
Input A			
Filter	FILTER		
50 Ω	50 Ω		
Auto	AUTO TRIG disappears		
TRGLVL (2 times)			
Sens ← (2 times)	Bar graph: 		
Sens → (2 times)	Bar graph: 		
Other			
PRESET Local	DEFAULT? NO SIGNAL	Default setting	
Meas Time	200.0 ⁻³ s		
DATA ENTRY↑	500.0 ⁻³ s		

For the instrument to respond correctly, this test must be carried out in sequence, and you must start with the preset (power on) setting.

DATA ENTRY↓	200.0 ⁻³ s		
Enter	NO SIGNAL		
MEASURE Hold	HOLD		
MEASURE Hold			
Single	SINGLE		
FUNCTION ←	DUTY F A		
FUNCTION ←	TOT A MAN		
FUNCTION →	DUTY F A		
FUNCTION →	FREQ A		
Aux Menu	RECALL		
MEASURE Restart	NO SIGNAL		
PRESET Local	DEFAULT? NO SIGNAL	Default setting	
Null	NO SIGNAL		
Check	10.0000000 ⁶ Hz *	Start counting	
Blank (3 times)	10.00000. ⁶ Hz *		
Menu	Displays all available functions, processes and input controls. Selected items are blinking.		
PRESET Local	DEFAULT? NO SIGNAL **	Default setting	

Table 10-2 Keyboard test.
* The LSD digit may vary.
** MENU is not disabled by setting DEFAULT; press menu again.

Short Form Specification Test

Sensitivity and Frequency Range

- Press the **PRESET** key to set the counter in the default setting. Then confirm by pressing **ENTER**.
- Turn off **AUTO**.
- Select 50 Ω / Input A and maximum sensitivity.
- Connect the output from an HF generator to a BNC power splitter.
- Connect the power splitter to your counter and an oscilloscope.
- Set input impedance to 50 Ω on the oscilloscope.
- Adjust the amplitude according to the following table. Read the level on the oscilloscope. The Counter should display the correct frequency.

Freq MHz	Level			Pass/ Fail Input A
	mVpp	mV RMS	dBm	
1	30	10	-27	
25	30	10	-27	
50	30	10	-27	
150	45	15	-23	
200	60	20	-21	
250	90	30	-17	
300	120	40	-15	

Table 10-3 Sensitivity for input A at various frequencies

Reference Oscillators

Crystal oscillators are affected by a number of external conditions such as ambient temperature and supply voltage but also by aging. Therefore, it is hard to give limits for the allowed frequency deviation. You must decide the limits depending on your application, and recalibrate the oscillator accordingly. See Chapter 11 Preventive Maintenance.

Oscillator	Max. temperature dependence	Max. aging per month	Max. aging per year
Standard	± 100 Hz	± 5 Hz	± 50 Hz
PM9678B	± 10 Hz	± 1 Hz	± 5 Hz
PM9691	± 0.05 Hz	± 0.1 Hz	± 0.75 Hz
PM9692	± 0.025 Hz	± 0.03 Hz	± 0.2 Hz
Rubidium	± 0.003 Hz	± 0.0005 Hz	± 0.002 Hz

Table 10-4 Deviation (for PM9691 and PM9692 after 48 hours warm-up time).

To check the accuracy of the oscillator, you must have a calibrated reference signal that is at least five times as stable as the oscillator that you are testing. See the following table.

- Set the counter to default settings by pressing **PRESET** and **ENTER**.
- Connect the reference to input A
- Check the read-out against the accuracy requirements of your application.

■ **Acceptance Test**

As an acceptance test the following table gives a worst case readout figure after 30 minutes warm-up time. All deviations that can occur in a year are added together.

Oscillator	Frequency read-out	Suitable reference	Pass/Fail
Standard	$10.00000000^6 \pm 120 \text{ Hz}$	PM9691 or PM9692	
PM9678 B	$10.00000000^6 \pm 15 \text{ Hz}$		
PM9691	$10.00000000^6 \pm 1 \text{ Hz}$	909, PM6685R or PM6681R	
PM9692	$10.00000000^6 \pm 0.25 \text{ Hz}$		

Table 10-5 Acceptance test for oscillators

■ **Acceptance Test, PM6685R**

To fully test the accuracy of the PM6685R, an extremely high stability reference signal is needed. Examples of such references are Cesium Atomic references, or transmitted signals from a nationally or internationally traceable source.

Recommended Test Equipment

Type	Stability	Model
10 MHz reference	$\leq 1 \times 10^{-10}$	910R with satellite contact during the last 72 hours.

Test Procedure

- Connect the counter to the line power.
- Check that the UNLOCK indicator turns on, and then turns off again within 6 minutes after connecting line power.
- Connect the 10 MHz reference signal to input A of the counter.
- Select FREQUENCY A measurement.
- Select 2 s measuring time.
- Check that the displayed frequency is $10.00000000 \text{ MHz} \pm 0.05 \text{ Hz} \leq 10 \text{ minutes}$ after connection to line power.

Rear Input/Output

INT REF Output

- Connect an oscilloscope to the 10 MHz output on the rear of the counter. Use coaxial cable and 50 Ω termination.
- Check that the output voltage is sine wave shaped and that the amplitude is minimum 1.4 Vpp.

EXT REF Input

- Set the counter to Default Setting by pressing PRESET and ENTER.
- Apply a 10 MHz sine wave signal to input A equipped with a T-piece and to the Ext Ref input at the rear, terminated with 50 Ω. Amplitude on 10 MHz signal; 500 mVRMS, (1.4 Vpp)
- Press the EXT REF key.
- The display should show $10.00000000^6 \text{ Hz} \pm 5 \text{ LSD}$.

EXT ARM INPUT

- Press the **PRESET** key, and confirm by pressing the **ENTER** key to set the counter in the default setting.
- Select 50 Ω input impedance.
- Apply 10 MHz 500 mVRMS, (1.4 VPP) sine to input A
- The counter measures and displays 10 MHz.
- Press **AUX MENU** key.
- Press **DATA ENTRY UP/DOWN** keys until display shows 'Ar. Start', confirm by pressing the **ENTER** key.
- Press **DATA ENTRY UP/DOWN** keys until display shows 'POS', confirm by pressing the **ENTER** key.
- Press **ENTER** once more.
- The counter does not measure.
- Connect a pulse generator to Ext Arm input.
- Settings for pulse generator:
 - single shot pulse
 - TTL levels (0 and +2 V)
 - 10 ns duration
- Apply one single shot pulse to Ext Arm input.
- The counter measures once and shows 10 MHz on the display.

Measuring Functions

Preparation for Check of Measuring Function is as follows:

- Connect a 10 MHz sine wave signal with 2.0 Vpp amplitude via a T-piece to Input A.
- Connect a cable from the T-piece to Input E (Ext Arm).
- Select the measuring function as in the 'Selected Function' column and check that the counter performs the correct measurement, by displaying the result as shown under the "Display" column in the following table.

Selected Function	Display	Pass/Fail
PRESET ENTER	DEFAULT? 10 MHz ²⁾	
50 Ω Input A	10 MHz ²⁾	
Non AUTO PER A	10 MHz ²⁾ 100 ns ²⁾	
RATIO A/E	1.0000000	
PWIDTH A	50 ns ¹⁾	
TOT A MAN DISPLAY HOLD	Start counting	
DISPLAY HOLD	Stop counting	
DUTY FACT	0.500000 ¹⁾	
AUTO	0.500000 ¹⁾	

Table 10-6 Measuring functions check

- 1) Value depends on the symmetry of the signal
2) Exact value depends on input signal.

PM9621, PM9624 and PM9625/25B

Prescaler Check

To verify the specification of the HF input in the instrument:

- If your counter do not have a any input C connector, skip this test.
- Connect the output of the signal generator to the HF-input of the counter.

Required Test Equip-ment	Suggested instrument
HF signal generator	Wiltron 6717B-20

Table 10-7 Test equipment

Connect the 10 MHz REFERENCE OUT of the generator to the REFERENCE IN at the rear panel of the counter.

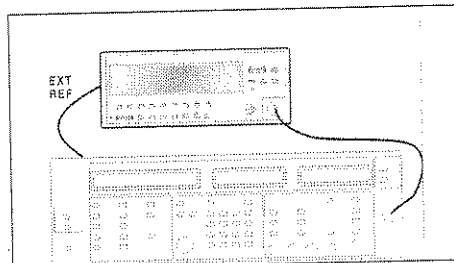

Fig 10-2 Connection.

- Preset the counter.
- Set Function to **FREQ C**.
- Select **EXT REF**.
- Generate a sine wave in accordance with the corresponding tables below.

Frequency MHz	Amplitude		Pass
	mVRMS	dBm	
70-90	10	-23	
900-1100	15	-23	
1100-1300	40	-15	

Table 10-8 Sensitivity of PM 9621.

Frequency MHz	Amplitude		Pass
	mVRMS	dBm	
100-300	20	-21	
300-2500	10	-27	
2500-2700	20	-21	

Table 10-9 Sensitivity of PM9624

Frequency MHz	Amplitude		Pass
	mVRMS	dBm	
150-300	20	-21	
-2500	10	-27	
-3500	15	-23,5	
-4200	25	-19	
-4500	50	-13	

Table 10-10 Sensitivity of PM9625

Frequency MHz	Amplitude		Pass
	mVRMS	dBm	
150-300	20	-21	
-2200	10	-27	
-3500	15	-23,5	
-4200	25	-19	

Table 10-11 Sensitivity of PM9625B

Chapter 11

Preventive Maintenance

Calibration and adjustment

To maintain the performance of the frequency counter, we recommend that you calibrate the time base of your instrument every year, or more often if you require greater time base accuracy. Calibration should be performed with traceable references and instruments at a certified calibration laboratory. Contact your local service center for calibration.

To know the present status of your instrument, test your counter from time to time. The test can be made according to the information in Chapter 10, "Performance Check."

Oscillators

The frequency of the reference crystal oscillator is the main parameter that influences accuracy of a counter. External conditions, such as ambient temperature and supply voltage, influence the frequency, but aging is also a factor. When adjusting, you compensate the reference crystal oscillator only for deviation in frequency due to aging.

■ Some important points:

- The high-stability oscillators, PM 9691 and PM 9692, have been built into an oven to keep the oscillator temperature as stable as possible. Continuous operation is also important for optimum stability. For example the PM 9692 has an aging/24h that is 3×10^{-10} when operating continuously. After a power interruption, the oscillator drift is higher and the specification of 3×10^{-10} per 24h is reached first after 48h continuous operation.
- The frequency uncertainty for standard oscillators is mainly dependent on the ambient temperature. Variations in ambient

temperature between 0 and 50 degrees may cause a frequency change of up to 100 Hz, whereas the aging per month is only 5 Hz. There is always a temperature increase inside the counter, during the first 30 minutes of operation, that will influence the oscillator.

How often to calibrate?

In the table below you can see the uncertainty of your time base oscillator for various MTBRC (Mean Time Between Recalibration) intervals.

Compare the requirements of your application with the values in the table, and select the proper MTBRC accordingly.

Please note that the frequency uncertainty when operating in a temperature controlled environment is different from field use. See the two sections in the table.

■ **Stability of time base oscillators:**

Model	PM6685				PM6685R
Option: Time base type:	Standard UCXO	PM9678B TCXO	PM 9691 OCXO	PM 9692 OCXO	Rubidium
Total uncertainty, for operating temperature 0°C to 50°C, at 2σ (95%) confidence interval:					
- 1 month after calibration	$< 1.2 \times 10^{-5}$	1.1×10^{-6}	$< 3 \times 10^{-8}$	$< 8 \times 10^{-9}$	$< 4 \times 10^{-10}$
- 3 month after calibration	$< 1.2 \times 10^{-5}$	1.1×10^{-6}	$< 4 \times 10^{-8}$	$< 1.2 \times 10^{-8}$	$< 4 \times 10^{-10}$
- 1 year after calibration	$< 1.2 \times 10^{-5}$	1.2×10^{-6}	$< 1 \times 10^{-7}$	$< 2.5 \times 10^{-8}$	$< 4 \times 10^{-10}$ *
- 2 year after calibration	$< 1.5 \times 10^{-5}$	1.5×10^{-7}	$< 2 \times 10^{-7}$	$< 5 \times 10^{-8}$	$< 6 \times 10^{-10}$ *
Typical total uncertainty, for operating temperature 20°C to 26°C, at 2σ (95%) confidence interval:					
- 1 month after calibration	$< 4 \times 10^{-6}$	3.1×10^{-7}	$< 3 \times 10^{-8}$	$< 8 \times 10^{-9}$	$< 1 \times 10^{-10}$
- 3 month after calibration	$< 4 \times 10^{-6}$	4.2×10^{-7}	$< 4 \times 10^{-8}$	$< 1.2 \times 10^{-5}$	$< 2 \times 10^{-10}$
- 1 year after calibration	$< 7 \times 10^{-6}$	7×10^{-7}	$< 1 \times 10^{-7}$	$< 2.5 \times 10^{-8}$	$< 2.5 \times 10^{-10}$ *
- 2 year after calibration	$< 1.2 \times 10^{-5}$	1.2×10^{-6}	$< 2 \times 10^{-7}$	$< 5 \times 10^{-8}$	$< 5 \times 10^{-10}$ *

* After 1st year of operation. For 1st year add: $< 3 \times 10^{-10}$

For complete specifications see chapter 12 (specifications).

Other Maintenance

Fan Replacement

The PM6685R is equipped with a fan, and if it is operating in a 24h/day system, you need to replace the fan every second year to maintain high reliability. For part-time applications and low ambient temperatures, an extended service interval is acceptable.

Backup Battery Replacement

The counter has a lithium battery to power the memory that stores the setting data when the power is switched off. The lithium battery has an estimated lifetime of five to ten years. We recommend you to replace the battery every five years to avoid loss of data in operation.

Contact your local service center to replace the battery.

When the battery is empty, the counter will lose all settings and any data in memory.

Chapter 12

Specifications

Measuring Functions

Refer to table 1 for measurement uncertainty information.

Frequency A, C

Range

Input A: 10 Hz to 300 MHz
Input C: 70 MHz to 1.3 GHz (PM 9621)
100 MHz to 2.7 GHz (PM 9624)
150 MHz to 4.2 GHz (PM 9625B)
150 MHz to 4.5 GHz (PM 9625)

Resolution: 10 digits/s measurement time

Burst Frequency A

Frequency Range: 100 Hz to 160 MHz
PRF Range: 1 Hz to 100 kHz
Burst duration: 1 μ s to 50 ms, min. 3 periods of this signal

Period A

Range: 6 ns to 100 ms
Resolution: 10 digits/s measurement time

Ratio A/E, C/A

Range: 10^{-7} to 10^{10}

Frequency Range:

Input A: 10 Hz to 160 MHz
Input E: 10 Hz to 50 MHz
Input C: 70 MHz to 1.3 GHz (PM 9621)
100 MHz to 2.7 GHz (PM 9624)
150 MHz to 4.2 GHz (PM 9625B)
150 MHz to 4.5 GHz (PM 9625)

Pulse Width A

Range: 3 ns to 10 ms
Frequency Range: 50 Hz to 160 MHz
Voltage Range: 100 mV p-p to 70V p-p

Duty Factor A

Range: 0 to 1
Frequency Range: 50 Hz to 160 MHz
Voltage Range: 100 mV p-p to 70V p-p

Totalize A

Event counting on input A with manual start and stop

Range: 0 to 10^{17}
0 to 160 MHz

Input and Output Specifications

Input A

Frequency Range: 10 Hz to 300 MHz

Coupling: AC

Impedance: 1 M Ω //25 pF or 50 Ω , VSWR 2:1

Sensitivity:

Sinewave: 10 mV rms, 10 Hz to 50 MHz

15 mV rms, 50 MHz to 100 MHz

20 mV rms, 100 MHz to 150 MHz

30 mV rms, 150 MHz to 200 MHz

50 mV rms, 200 MHz to 300 MHz

Pulse: 50 mV p-p, 3 ns minimum pulse width

Dynamic Range: 30 mV p-p to 70V p-p

Manual Trigger:

Sensitivity Range: 10 mV rms to 10V rms, variable in 3 dB steps, indicated on a bar graph.

Trigger Level: Selectable for optimum triggering on waveforms with duty factors, 0.25 to 0.75 and 0.75.

Trigger Slope: Positive or negative

Auto Trigger: Automatic setting of input signal conditioning circuits for optimum triggering on different amplitudes and waveforms

Frequency: Minimum 50 Hz

Sensitivity Range: 10 mV rms to 25V rms

Signal Monitor: A bar graph displays actual input signal level in 3 dB steps, 10mV rms to 10V rms

Low Pass Filter: 100 kHz nominal 3 dB point. Minimum 40 dB attenuation at 1 MHz.

Damage Level:

1 M Ω : 350V (dc + ac peak) at dc to 440 Hz, falling to 12V rms at 1 MHz and above

50 Ω : 12V rms

Input C (PM 9621)

Frequency Range: 70 MHz to 1.3 GHz

Prescaler Factor: 256

Operating Input Voltage Range:

70 to 900 MHz: 10 mVrms to 12Vrms

900 to 1100 MHz: 15m Vrms to 12Vrms

1100 to 1300 MHz: 40m rms to 12Vrms

Amplitude Modulation:

dc to 0.1 MHz: Up to 94% depth

0.1 to 6 MHz: Up to 85% depth

Minimum signal must exceed minimum operating input voltage.

Impedance: 50 Ω nominal

Coupling: AC coupled

VSWR: <2:1

Max Voltage Without Damage:

12V rms, pin-diode protected

Connector: BNC

Input C (PM 9624)

Frequency Range: 100 MHz to 2.7 GHz

Prescaler Factor: 16

Operating Input Voltage Range:

100 to 300 MHz: 20 mV rms to 12V rms

0.3 to 2.5 GHz: 10 mV rms to 12V rms

2.5 to 2.7 GHz: 20 mV rms to 12V rms

Amplitude Modulation: As in PM9621

Impedance: 50 Ω nominal

Coupling: AC coupled

VSWR: <2.5:1

Max Voltage Without Damage:

12V rms, pin-diode protected

Connector: Type N Female

Input C (PM 9625B)

Frequency Range: 150 MHz to 4.2 GHz
Operating Input Voltage Range:
150 to 300 MHz: 20 mV rms to 1V rms
(-21 to +13 dBm)
0.3 to 2.2 GHz: 10 mV rms to 1V rms
(-27 to +13 dBm)
2.5 to 3.5 GHz: 15 mV rms to 1V rms
(-23.5 to +13 dBm)
3.5 to 4.2 GHz: 25 mV rms to 1V rms
(-19 to +13 dBm)

All other parameters as PM9625

Input C (PM 9625)

Frequency Range: 150 MHz to 4.5 GHz
Burst frequency Range: 150 MHz to 4.5 GHz
Prescaler Factor: 32
Operating Input Voltage Range:
150 to 300 MHz: 20 mV rms to 1V rms
(-21 to +13 dBm)
0.3 to 2.5 GHz: 10 mV rms to 1V rms
(-27 to +13 dBm)
2.5 to 3.5 GHz: 15 mV rms to 1V rms
(-23.5 to +13 dBm)
3.5 to 4.2 GHz: 25 mV rms to 1V rms
(-19 to +13 dBm)
4.2 to 4.5 GHz: 50 mV rms to 1V rms
(-13 to +13 dBm)

Amplitude Modulation: As PM962
Impedance: 50Ω nominal
Coupling: AC coupled
VSWR: <2.5:1
Max Voltage Without Damage:
12V rms (+34 dBm), pin-diode protected
Connector: Type N Female

External Reference Input D

The use of external reference is indicated on the display.
Input Frequency: 10 MHz
Voltage Range: 500 mV rms to 10V rms
Impedance: Approx. 1 kΩ (ac coupled)

Input E

Used in Ratio A/E and external arming/gating modes.
Frequency Range: DC to 50 MHz
Pulse Width: 10 ns minimum
Slew Rate: 2V/μs minimum
Trigger Level: TTL level, 1.4V nominal
Trigger Slope: Positive or negative
Impedance: Approx. 2 kΩ (dc coupled)
Damage Level: 25V peak

Reference Output G

Frequency: 10 MHz, sine wave
Output Level: 0.5V rms into 50Ω load,
0.7V rms into high impedance load
Coupling: AC

Auxiliary Functions

External Arming/External Gate

An external signal on input E can be used to inhibit start and/or stop triggering.
Stop arming is not applicable to Pulse Width and Duty Factor measuring modes.
Start Arming Delay: OFF or 200 ns to 1.6s in 100 ns steps.

Nulling/Frequency Offset

Nulling enable measurements to be displayed relative to a previously measured value or any frequency offset value entered via front panel keys.

Other Functions

Measuring Time: Single cycle, 0.8, 1.6, 3.2, 6.4, 12.8 μ s and 50 μ s to 20 s, (up to 400 s, depending on measuring function and input signal frequency).

Local/Preset: Go to local function in remote mode, or preset counter to default setting in local mode.

Restart: Starts a new measurement

Display Hold: Freezes measuring result. Start and stop of the totalization in TOT A MAN.

Check: Applies 10 MHz to the measuring logic

Display: LCD with high-luminance Back light

Number of Digits: 10 digits plus exponent

Blanking: Least significant digits can be blanked.

Bar graph: Displays input signal level or sensitivity setting in 3 dB steps from 10mV rms to 10V rms.

Auxiliary Menu:

Functions available from AUX MENU or via GPIB (PM 9626B):

Save/Recall: 19 complete instrument settings. 10 settings can be user protected

GPIB-Address: Read and temporarily change via front panel keys

Burst Frequency A: Select Burst function, set synchronization delay time

PRF: Select PRF function, set synchronization delay time

Trigger Slope: Positive or negative trigger slope

Arming Start: Positive or negative arming slope, set start arming delay time

Arming Stop: Positive or negative arming slope

Null: Read and change stored offset frequency

Display Overflow: Display of the 11th and 12th digits

Test: Select self-tests

Program Version: Display instrument and GPIB program versions

Time Out: OFF or 100 ms to 25.5s in 100 ms

steps

Analog Output: Select digits and scaling factor

Display Back light: On/Off

GPIB (PM 9626B)

Programmable Functions:

All front panel and AUX MENU functions

Compatibility: IEEE 488.2-1987, SCPI 1991.0

Interface Functions: SH1, AH1, T6, L4, SR1, RL1, DC1, DT1, E2

Maximum Measurement Rate to Internal Memory:

200 to 1600 readings/s, depending on measurement function and internal data format

Internal Memory Size: 764 to 2600 readings, depending on measurement function and internal data format

Data Output Format: ASCII, IEEE double precision floating point

Analog output (included with GPIB option)

The analog output produces a voltage that is proportional to three selected consecutive display digits showing the measurement result

Output Voltage: 0.00 to 4.98 V in 20 mV steps

Output Impedance: 200 Ω

Output connector: BNC

Measurement Uncertainties

Measuring function	Random Uncertainty rms	Systematic Uncertainty	LSD Displayed
Frequency Period	$\pm \frac{\sqrt{QE^2 + 2 \times (Trigger\ Error)^2}}{Measuring\ Time} \times Freq.\ or\ Per.$	$\pm Time\ Base\ Error \times Freq.\ Per.$ $\pm \frac{250\ ps}{Meas.\ Time} \times Freq.\ or\ Per.$	$\frac{250\ ps \times Freq.\ or\ Per.}{Measuring\ Time}$
Ratio f ₁ /f ₂	$\pm \frac{\sqrt{(presc.\ factor)^2 + 2 \times (f_1 \times Trig.\ Err.\ of\ f_1)^2}}{f_1 \times Meas.\ Time}$		$\frac{Prescaler\ Factor}{f_1 \times Meas.\ Time}$
Pulse Width (Auto Trigger)	$\pm \sqrt{QE^2 + (Start\ TE)^2 + (Stop\ TE)^2}$	$\pm Time\ Base\ Err. \times Pulse\ Width$ $\pm 0.5 \times Transition\ Time$ $\pm 1.5\ ns$	100 ps
Duty Factor	$\pm \sqrt{QE^2 + (Start\ TE)^2 + (Stop\ TE)^2} \times Freq.$	$\pm (0.5 \times Transition\ Time + 1.5ns) \times Frequency$	1×10^{-6}

Table 12-1 Measurement Uncertainties and LSD Displayed

■ **Random Uncertainty**

- (QE) Quantization Error: 250 ps
- (N) Number of samples:
 - Frequency < 2 kHz: Measuring Time x Frequency/2
 - Frequency > 2 kHz: Measuring Time x 1000

■ **Start/Stop Trigger Errors (TE):**

$$\sqrt{(V_{noise-input})^2 + (V_{noise-signal})^2} \text{ rms}$$

Signal slewrate (V / s) at trigger point

- V noise-input: 250 μV rms typical
- V noise-signal: The rms noise of the input signal over a 300 MHz bandwidth

■ **Systematic Uncertainties**

Time Base Error: See Table 2 "Time Base Options" for total uncertainty specifications

■ **Display Resolution**

LSD Displayed

Unit value of Least Significant Digit (LSD) displayed. After calculation, the LSD value is rounded to the nearest decade before display (for example 0.5 Hz will be 1 Hz and 0.4 Hz will be 0.1 Hz). LSD blanking is available to reduce displayed resolution. Measuring time 1s can give significance in 10 digits. The 11th and 12th digits can be displayed using the display overflow function.

Time Base Options

Product Family	PM6685 /PM6685R series				
Model:	PM6685	PM6685	PM6685	PM6685	PM6685R
Option: Time base type:	Standard UCXO	PM9678B TCXO	PM9691 OCXO	PM9692 OCXO	Rubidium
Uncertainty due to: - Cal. adjustment tolerance, at $+23^{\circ}\text{C} \pm 3^{\circ}\text{C}$	$< 1 \times 10^{-6}$	$< 2 \times 10^{-7}$	$< 2 \times 10^{-8}$	$< 5 \times 10^{-9}$	$< 5 \times 10^{-11}$
- Aging: per 24 hr. per month per year	n.a. $< 5 \times 10^{-7}$ $< 5 \times 10^{-6}$	n.a. $< 1 \times 10^{-7}$ $< 5 \times 10^{-7}$	$< 5 \times 10^{-10}$ 1) $< 1 \times 10^{-8}$ $< 7.5 \times 10^{-8}$	$< 1 \times 10^{-10}$ 4) $< 3 \times 10^{-9}$ $< 2 \times 10^{-8}$	not specified $< 5 \times 10^{-11}$ 2) $< 2 \times 10^{-10}$ 3)
- Temp. Variation: $0^{\circ}\text{C} - 50^{\circ}\text{C}$, $20^{\circ}\text{C} - 26^{\circ}\text{C}$ (typ. values)	$< 1 \times 10^{-5}$ $< 3 \times 10^{-6}$	$< 1 \times 10^{-6}$ $< 2 \times 10^{-7}$	$< 5 \times 10^{-9}$ $< 6 \times 10^{-10}$	$< 2.5 \times 10^{-9}$ $< 4 \times 10^{-10}$	$< 3 \times 10^{-10}$ $< 2 \times 10^{-11}$
- Power voltage variation: 10%	$< 1 \times 10^{-8}$	$< 1 \times 10^{-9}$	$< 5 \times 10^{-10}$	$< 5 \times 10^{-10}$	$< 1 \times 10^{-11}$
Short term stability : $\tau = 1 \text{ s}$ (root Allan Variance) $\tau = 10 \text{ s}$ Typical values	not specified.	not specified.	$< 5 \times 10^{-12}$ $< 5 \times 10^{-12}$	$< 5 \times 10^{-12}$ $< 5 \times 10^{-12}$	$< 5 \times 10^{-11}$ $< 1.5 \times 10^{-11}$
Power-on stability: - Deviation versus final value after 24hr on time, after a warm-up time of:	not speci- fied 30 min	n.a. 30 min	$< 1 \times 10^{-8}$ 10 min	$< 5 \times 10^{-9}$ 10 min	$< 4 \times 10^{-10}$ 10 min
Time to lock at 25°C (PM6685R only):	n.a.	n.a.	n.a.	n.a.	approx. 5 min.
Total uncertainty, for operat- ing temperature 0°C to 50°C , at 2σ (95 %) confidence interval: - 1 year after calibration - 2 year after calibration	$< 1.2 \times 10^{-5}$ $< 1.5 \times 10^{-5}$	$< 1.2 \times 10^{-6}$ $< 1.5 \times 10^{-6}$	$< 1 \times 10^{-7}$ $< 2 \times 10^{-7}$	$< 2.5 \times 10^{-8}$ $< 5 \times 10^{-8}$	$< 4 \times 10^{-10}$ 3) $< 6 \times 10^{-10}$ 3)
Typical total uncertainty, for operating temp. 20°C to 26°C , at 2σ (95 %) confidence interval: - 1 year after calibration - 2 years after calibration	$< 7 \times 10^{-6}$ $< 1.2 \times 10^{-5}$	$< 7 \times 10^{-7}$ $< 1.2 \times 10^{-6}$	$< 1 \times 10^{-7}$ $< 2 \times 10^{-7}$	$< 2.5 \times 10^{-8}$ $< 5 \times 10^{-8}$	$< 2.5 \times 10^{-10}$ 3) $< 5 \times 10^{-10}$ 3)

1) after 48 hours of continuous operation.

2) after 1 month of continuous operation.

3) after 1st year, aging during 1st year:
 $< 5 \times 10^{-10}$.

4) after 14 days of continuous operation.

Explanation

Calibration Adjustment Tolerance: Is the maxi-
mal tolerated deviation from the true 10MHz fre-

quency after a calibration. When the reference
frequency does not exceed the tolerance limits
at the moment of calibration, an adjustment is
not needed.

OCXO = Oven Controlled X-tal Oscillator.

UCXO = Un-Compensated X-tal Oscillator.

General Specifications

■ Environmental Conditions

Temperature
 Operating: 0°C to +50°C
 Storage: -40°C to +70°C
 Humidity: 95% RH, 0°C to 30°C
 Altitude
 Operating: Up to 4600m (15000 ft)
 Non-operating: Up to 12000m (40000 ft)
 Vibration: 3G at 55 Hz per MIL-T-28800D, Class 3, Style D
 Shock: Half-sine 40G per MIL-T-28800D, Class 3, Style D. Bench handling. Shipping container.
 Reliability: MTBF 30 000 hours
 Safety: CSA 22.2 No. 231, EN61010, CE
 EMC: EN 55011, group 1, class B; EN 50082-2; FCC Part 15J Class A, CE

■ Power Line Requirements (at 25°C)

AC voltage:
 PM6685 90 to 264Vrms, 47 to 440 Hz
 PM6685R 90 to 264Vrms, 47 to 63 Hz
 Power rating:
 PM6685 max 30 W
 PM6685R max 100W during warm-up (5 min.)
 max 47 W (continuous operation)

Mechanical Data

Width:
 PM6685: 210 mm (8.25 in)
 PM6685R: 315 mm (12.4 in)

Height 86 mm (3.4 in)
 Depth 395 mm (15.6 in)

Net Weight:
 PM6685: 3.2 kg (7 lb)
 PM6685R: 5.5 kg (12 lb)
 Shipping Weight:
 PM6685: 5.5 kg (12 lb)
 PM6685R: 8.8 kg (19 lb)

Ordering Information

Basic models
 PM6685 300 MHz Frequency Counter including standard time base (5x10⁻⁷/month)
 PM6685R 300 MHz Frequency Counter/Calibrator including rubidium time base (5x10⁻¹¹/month)

Included with Instrument
 Power line cord
 Users manual
 Programming manual (only when GPIB is included)
 Certificate of Calibration

Input Frequency options

PM6685/0 __ Standard 300 MHz Frequency Counter
 PM6685/4 __ 1.3 GHz Input C (PM9621)
 PM6685/6 __ 2.7 GHz Input C (PM9624)
 PM6685/7 __ 4.5 GHz Input C (PM9625)
 PM6685/8 __ 4.2 GHz Input C (PM9625B)

Timebase Options

PM6685/ _ 1_ Standard Timebase

PM6685/ _ 2_ TCXO (PM9678B)

PM6685/ _ 5_ Very High Stability Oven Timebase (PM9691)

PM6685/ _ 6_ Ultra Stability Oven Timebase (PM9692)

PM6685/ _ 8_ Standard Timebase plus 1 and 5 MHz External Reference Frequency Multiplier (PM9697)

Battery Unit and GPIB Options

PM6685/ __ 1 No Battery Unit or GPIB

PM6685/ __ 3 Battery Unit (PM9623)

PM6685/ __ 6 GPIB (PM9626/02)

PM6685/ __ 8 Battery Unit plus GPIB

Example Ordering Configuration

To order the 300 MHz version of PM6685 with the TCXO Timebase and GPIB, select the Complete Model Number PM6685/026.

To order the 2.7 GHz version of PM6685R including GPIB, select PM6685R/676.

Options and Accessories

PM9621 1.3 GHz Input C

PM9622/02 Rack-Mount Kit

PM9623 Battery Unit

PM9624 2.7 GHz Input C

PM9625B 4.2 GHz Input C

PM9625 4.5 GHz Input C

PM9626/02 GPIB-Interface

PM9627 Carrying Case

PM9627H Heavy Duty Carrying Case

PM9678B TCXO Timebase

PM9691 Very High Stability Oven Timebase

PM9692 Ultra High Stability Oven Timebase

PM9697 External Reference Frequency Multiplier (1, 5, 10 MHz)

When ordered with the basic counter, options are factory installed. Options ordered separately can be retrofitted by the customer.

PM9697 can be used only with the Standard Timebase.

Chapter 13

Appendix

Appendix 1, Error Messages

If the counter detects an internal error or an invalid setting, it shows an error message on the display. This appendix lists all possible error messages.

If the counter has PM 9626B (GPIB) installed, GPIB error messages can be displayed in addition to the messages shown below. When a GPIB error is placed in the GPIB error queue, the display shows an error code number which is explained in Chapter 21 of the GPIB Programming Manual. This error message is removed the next time the counter uses the display for a message or a measuring result.

Messages due to False Settings:

Err. FAIL

Error Failure: The internal instrument setting is not valid.

Err. No SAV

Error No Save: An attempt to recall a memory that has never been saved

Err. OFLO

Error Overflow: A math operation in the counter caused an overflow error.

Err. PRESC.

Error Prescaler: An attempt to use the prescaler functions without a prescaler.

Err. RANGE

Error Range: An attempt to enter a value above the maximum or below the minimum limit was made.

Err. UFLO

Underflow: A math operation in the counter caused an underflow error.

no BUS

No Bus: No GPIB interface is installed.

no DATA

No data: A reading of statistics data is made before data is captured.

no PRESC

No Prescaler: No Prescaler is installed.

no SIGNAL

No signal: Displayed when measurement is interrupted by a timeout. Disable Timeout (in Auxiliary Menu) or set a longer time.

Err. ProtEc.

Error Protect: An attempt to make a save in a protected memory position.

OFLO

Overflow: The measurement has been abandoned due to an overflow condition.

Messages due to Severe Errors:

Err. AS IC

Error ASIC: Displayed when this is a Measuring Logic Circuits failure.

E. rA 8888

Error RAM XXXXh: Displayed when there is a RAM test failure. XXXXh is the hexadecimal address where failure is detected first.

Err. r0

Error ROM: Displayed when ROM test failure.

Err. UP r0C.

Error Microprocessor: Displayed when an error is detected in the microprocessors internal RAM, timers, or I/O port.

Chapter 14

Index

INDEX

!

- +1 cycle count error 6-3
- 50ohm/1Mohm key 4-5

A

- AC coupling 5-5
- Address
 - Reading the GPIB Address 9-7
- Address switch 4-10
- Adjustments
 - time base 11-2
- Air flow 3-3
- AM modulated signals 6-10
- Analog output
 - connector 4-11
 - specification 12-5
 - using 9-8
- Aperture
 - SEE Measuring time
- Arming
 - delay 7-4 - 9-5
 - description 7-8
 - examples 7-13
 - indication 4-8
 - input E 4-11
 - manually 7-9
 - selection 7-3
 - setup time 7-12
 - start 9-5
 - stop 9-5
 - sync. delay 7-9
- Auto
 - once 5-5
 - time to determine levels 5-3
 - timeout 6-4
- Auto trigger
 - levels 5-3
- Aux
 - annunciator 9-2
 - indication 4-8

- menu description 9-2 - 9-10
- menu key 4-6
- Averaging 6-5, 8-2

B

- Battery
 - replacement of backup 11-4
 - safety when handling 2-3
- Blank digits 7-5
- Burst 6-6
 - Frequency (CW) 6-7, 6-9, 9-6
 - indication 4-9
 - PRF 6-6, 9-6
 - specification 12-2

C

- Calibration
 - intervals 11-2
- Carrier wave frequency AM 6-10
- Caution statements 2-2
- Channel
 - SEE Input
- Check 4-6
- Cooling 3-3
- Count error, +1 cycle 6-3
- Counting
 - erroneously 5-7
 - events 6-15 - 6-16
 - reciprocal 6-3
- Coupling 5-5
- Crystal oscillators
 - calibration 11-2
- CW
 - AM 6-10
 - burst 9-6

D

- Default settings 4-3
- Delay
 - arming sync. 7-9
- Delayed time base 7-4
- Delta measurements
 - SEE Nulling

Digit blanking	7-5 - 7-11
Disclaimer	I-V
Display	
hold key	4-7
Display hold	7-3, 7-9
Display time	7-2, 7-6
Drift measurements	7-17
Duration	
<i>SEE</i> Pulse width	
Duty cycle	
<i>SEE</i> Duty factor	
Duty factor	6-14
Duty Factor	
specification	12-2
uncertainty	12-6
E	
Earthing	
<i>SEE</i> Grounding	
End of a measurement	7-6
Enter	
indicator	4-8
key	4-6
Erroneous counts	5-7
Error	
Messages	13-2
Error ASIC	13-3
Error Failure	13-2
Error Microprocessor	13-3
Error NO SIGNAL	6-4
Error NO TRIG	6-4
Error Prescaler	13-2
Error Protect	13-2
Error RAM XXXXh	13-3
Error Range	13-2
Error ROM	13-3
Event counting	
<i>SEE</i> Totalize	
Examples	
arming	7-13
Ext Ref	
input	4-10

key	4-6
output test	10-6
specification	12-4
External Arming	
input test	10-7
specification	12-4
External Gate	
specification	12-4
F	
Fan	
replacement	11-4
Filter	
analog LP	5-5
characteristics	5-5
key	4-5
Firmware release	
<i>SEE</i> Program version	
Fixed	
timeout	6-4
Fold-down Support	3-3
Free-running	
measurements	7-6, 7-17
Freezing the display	
<i>SEE</i> Display hold	
Frequency	6-3
burst	9-6
burst PRF	9-6
range test	10-5
ratio	6-11
specification	12-2
uncertainty	12-6
Frequency versus time	
<i>SEE</i> Profiling	
Function	
indication	4-8
period	6-12
ratio	6-11
selection	4-4
Functions hidden	
<i>SEE</i> Aux menu	
Fuse	3-2

G

Gate indicator	7-3
Go-detector	6-9
GPIB	
Address switch	4-10
connector	4-10
reading the address	9-7
specification	12-5
Grounding	3-2

H

Handle	3-3
Hidden functions	
<i>SEE</i> Aux menu	
Hiding digits	
<i>SEE</i> Digit blanking	
High measuring speed	7-7
Hold display	4-7
Hysteresis	5-7, 6-13
<i>SEE ALSO</i> Sensitivity	

I

Identification	3-2
Impedance	
key	4-5
setting	5-5
Input	
impedance	4-5
selection	6-3 - 6-5
Input A	4-4
keys	4-5
specification	12-3
test	10-5
Input C	
specification	12-3 - 12-4
test	10-8
Input D	
specification	12-4
Input E	
specification	12-4
Interference	5-6 - 5-8
Interpolators	1-2

K

Keyboard	
test	10-4

L

Lithium battery	
<i>SEE</i> battery	
Local	4-4
Low pass filter	5-5

M

Maintenance	
backup battery	11-4
fan	11-4
Manual	
arming	7-9
sensitivity	5-4
Measurement	
end	7-6
free-running	7-17
rate	7-6
start	7-6
timing	7-6
Measurement start control	
<i>SEE</i> Start Arming	
Measurement stop control	
<i>SEE</i> Stop Arming	
Measuring Functions	
test	10-7
Measuring speed	6-4, 7-7
Measuring time	4-6, 7-6
influence by prescaling	6-5
setting	7-2
specification	12-5
Memory	
specification	12-5
Menu	4-7
with more functions	9-2 - 9-10
Modulating frequency AM	6-11

N

No Bus	13-2
No data	13-2

No Prescaler	13-2
No Save	13-2
No signal.	13-2
display message	6-4
No trig	
display message	6-4
Noise	5-6 - 5-8
Noise Suppression Filter	5-5
Null	
annunciator	8-3
Nulling.	8-2
copy measurement result to . . .	8-2

O

Offset	
<i>SEE</i> Nulling	
On	
key	4-4
settings after	4-3
Oscillators	
calibration	11-2
Output G	
specification	12-4
Overflow	13-2

P

Packing list	3-2
Period	6-12
specification	12-2
uncertainty	12-6
PM9621	
specifications	12-3
test	10-8
PM9624	
specifications	12-3
test	10-8
PM9625	
specification	12-4
test	10-8
PM9625B	
specifications	12-4
test	10-8
PM9626B	
specifications	12-5

PM9691	
specifications	12-7
test	10-5
PM9692	
specifications	12-7
test	10-5
Power-On Test	10-3
Prescaler	
test	10-8
Prescaling	
effect of	6-5
Preset	
key	4-4
settings after	4-3
PRF	
burst	9-6
specification	12-2
Processing	
measuring results	8-2
Profiling.	7-17
transient	7-17
VCO step response.	7-18
Program version	9-6
Pulse period	6-12
Pulse Width	6-14
specification	12-2
uncertainty	12-6

R

Rack mount adapter	
installation	3-3
Rate of measurement	7-6
Ratio	
function	6-11
specification	12-2
uncertainty	12-6
Recalibration	
intervals.	11-2
Reciprocal counting	6-3
Recommended Test Equipment . .	10-2
Reference	
input	4-10
input specification	12-4

output	4-10
output specification	12-4
Reference Oscillators	
test	10-5
Relative measurements	
<i>SEE</i> Nulling	
Remote	4-9
Reset	
totalizing	6-15
Resolution	
test	10-6
Restart	4-6
Rubidium reference	1-4
specification	12-7
test	10-5
S	
Sample-hold	6-4
Scaling factor	
analog output	9-8
Self-test	9-6, 10-3
SENS key	5-4
Sensitivity	6-13
<i>SEE ALSO</i> Hysteresis	
manual setting	5-4
speed of auto setting	5-3
test	10-5
Setup time	
for arming	7-12
Signal detection	6-4
Single	4-6, 6-5 - 7-6, 8-2
Single-shot phenomena	7-9
Slope	4-5
Speed	7-7
arming	7-12
of measurement	6-4
of the auto function	5-3
SRQ	4-9
Standard Oscillator	
test	10-5
Stand-by	
indicator	4-4
key	4-4

Start	
a new measurement	4-6
arming	7-3, 7-9, 9-5
of a measurement	7-6 - 7-7
totalizing	6-15
Stop	
arming	7-3, 7-9, 9-5
of measurement	7-7
totalizing	6-15
Supply voltage	
setting	3-2
Support	
fold-down	3-3
Suppression of noise	
<i>SEE</i> Analog lowpass filter	
Synchronization of a measurement	6-3
Synchronization delay	
arming	7-9
T	
Test Equipment	10-2
Test programs	
<i>SEE</i> Self test	
Time	
set the measuring	7-2
period	6-12
to set up arming	7-12
Time interval	
<i>SEE</i> Pulse width	
Time base	
calibration	11-2
Timeout	
auto	6-4
fixed	6-4
manual	6-4
set	9-6
Totalize	6-15 - 6-16
specification	12-2
Totalizing	
reset	6-15
start	6-15
stop	6-15
Touch-hold	
<i>SEE</i> Samplehold	

Transient profiling	7-17
Trigger	
auto level	5-3
error	5-4
hysteresis	5-7
slope selection	4-5
uncertainty	5-7
Trigger level	4-5
<i>SEE ALSO</i> sensitivity	
output test	10-7

U

Uncertainty	
duty factor	12-6
frequency	12-6
period	12-6
PM9691	12-7
PM9692	12-7
pulse width	12-6
random	12-6
ratio	12-6
rubidium reference	12-7
standard time base	12-7
systematic	12-6
Underflow	13-2

V

VCO	
step response profiling	7-18
Voltage, supply	3-2

W

Warm-up time	10-2
Warning statements	2-2
Waveform	4-5
how to set	5-4
Width	
of pulse	6-14