

Agilent 11713B/C Attenuator/Switch Drivers

**Operating and Service
Manual**



Agilent Technologies

Notices

© Agilent Technologies, Inc. 2007

No part of this manual may be reproduced in any form or by any means (including electronic storage and retrieval or translation into a foreign language) without prior agreement and written consent from Agilent Technologies, Inc. as governed by United States and international copyright laws.

Certification

Agilent Technologies certifies that this product met its published specifications at the time of shipment from the factory. Agilent Technologies further certifies that its calibration measurements are traceable to the United States National Institute of Standards and Technology (NIST, formerly NBS), to the extent allowed by the Institute's calibration facility, and to the calibration facilities of the other International Standards Organization members.

Manual Part Number

11713-90024

Edition

Second edition, January 2010

Printed in Malaysia

Agilent Technologies, Inc.
Phase 3 Bayan Lepas Free Industrial Zone
Penang, 11900 Malaysia

Warranty

The material contained in this document is provided "as is," and is subject to being changed, without notice, in future editions. Further, to the maximum extent permitted by applicable law, Agilent disclaims all warranties, either express or implied, with regard to this manual and any information contained herein, including but not limited to the implied warranties of merchantability and fitness for a particular purpose. Agilent shall not be liable for errors or for incidental or consequential damages in connection with the furnishing, use, or performance of this document or of any information contained herein. Should Agilent and the user have a separate written agreement with warranty terms covering the material in this document that conflict with these terms, the warranty terms in the separate agreement shall control.

Technology Licenses

The hardware and/or software described in this document are furnished under a license and may be used or copied only in accordance with the terms of such license.

Restricted Rights Legend

If software is for use in the performance of a U.S. Government prime contract or subcontract, Software is delivered and licensed as "Commercial computer software" as defined in DFAR 252.227-7014 (June 1995), or as a "commercial item" as defined in FAR 2.101(a) or as "Restricted

computer software" as defined in FAR 52.227-19 (June 1987) or any equivalent agency regulation or contract clause. Use, duplication or disclosure of Software is subject to Agilent Technologies' standard commercial license terms, and non-DOD Departments and Agencies of the U.S. Government will receive no greater than Restricted Rights as defined in FAR 52.227-19(c)(1-2) (June 1987). U.S. Government users will receive no greater than Limited Rights as defined in FAR 52.227-14 (June 1987) or DFAR 252.227-7015 (b)(2) (November 1995), as applicable in any technical data.

Safety Notices

CAUTION

A **CAUTION** notice denotes a hazard. It calls attention to an operating procedure, practice, or the like that, if not correctly performed or adhered to, could result in damage to the product or loss of important data. Do not proceed beyond a **CAUTION** notice until the indicated conditions are fully understood and met.

WARNING

A **WARNING** notice denotes a hazard. It calls attention to an operating procedure, practice, or the like that, if not correctly performed or adhered to, could result in personal injury or death. Do not proceed beyond a **WARNING** notice until the indicated conditions are fully understood and met.

General Safety Information

The following general safety precautions must be observed during all phases of operation of this instrument. Failure to comply with these precautions or with specific warnings elsewhere in this manual violates safety standards of design, manufacture, and intended use of the instrument. Agilent Technologies, Inc. assumes no liability for the customer's failure to comply with these regulations.

NOTE

The 11713B/C complies with INSTALLATION CATEGORY II as well as POLLUTION DEGREE 2 in IEC61010-1. The 11713B/C is an INDOOR USE product.

Before applying power

Verify that all safety precautions are taken. Make all connections to the unit before applying power.

Ground the instrument

This product is provided with protective earth terminals. To minimize shock hazard, the instrument must be connected to the ac power mains through a grounded power cable, with the ground wire firmly connected to an electrical ground (safety ground) at the power outlet. Any interruption of the protective (grounding) conductor or disconnection of the protective earth terminal will cause a potential shock hazard that could result in personal injury.

DO NOT operate the product in an explosive atmosphere or in the presence of flammable gases or fumes

DO NOT use repaired fuses or short-circuited fuse holders

For continued protection against fire, replace the line fuse(s) only with fuse(s) of the same voltage and current rating and type.

Do Not Remove the Instrument Cover

Only qualified, service-trained personnel who are aware of the hazards involved should remove the instrument covers. Always disconnect the power cable and any external circuits before removing the instrument cover.

Do Not Modify the Instrument

Do not install substitute parts or perform any unauthorized modification to the instrument. Return the instrument to an Agilent Sales and Service Office for service and repair to ensure that safety features are maintained.

In Case of Damage

Instruments that appear damaged or defective should be made inoperative and secured against unintended operation until they can be repaired by qualified, service-trained personnel.

Waste Electrical and Electronic Equipment (WEEE) Directive 2002/96/EC

This product complies with the WEEE Directive (2002/96/EC) marking requirements. The affixed label indicates that you must not discard this electrical/electronic product in domestic household waste.

Product Category:

With reference to the equipment types in the WEEE Directive Annex 1, this product is classed as a “Monitoring and Control Instrumentation” product.

The affixed product label is shown as below:

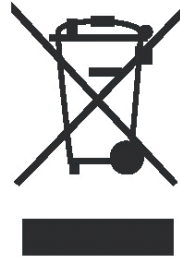

Do not dispose in domestic household waste.





To return unwanted products, contact your local Agilent office, or visit:

www.agilent.com/environment/product

for more information.

Safety Symbols

The following symbols on the instrument and in the documentation indicate precautions that must be taken to maintain safe operation of the instrument.

	Alternating current
	Earth (grounding) terminal
	Off (supply)
	On (supply)
	Caution, risk of danger (refer to this manual for specific Warning or Caution information)

Contacting Agilent

For more information, please contact your nearest Agilent office.

Americas

Canada	(877) 894-4414
Latin America	305 269 7500
United States	(800) 829-4444

Asia Pacific

Australia	1 800 629 485
China	800 810 0189
Hong Kong	800 938 693
India	1 800 112 929
Japan	81 426 56 7832
Korea	080 769 0800
Malaysia	1 800 888 848
Singapore	1 800 375 8100
Taiwan	0800 047 866
Thailand	1 800 226 008

Europe

Austria	0820 87 44 11
Belgium	32 (0) 2 404 93 40
Denmark	45 70 13 15 15
Finland	358 (0) 10 855 2100
France	0825 010 700
Germany	01805 24 6333
Ireland	1890 924 204
Italy	39 02 92 60 8484
Netherlands	31 (0) 20 547 2111
Spain	34 (91) 631 3300
Sweden	0200-88 22 55
Switzerland(French)	41 (21) 8113811 (Opt 2)
Switzerland(German)	0800 80 53 53 (Opt 1)
United Kingdom	44 (0) 118 9276201
Other European Countries:	www.agilent.com/find/contactus

Or, go to www.agilent.com/find/assist for more information.

Contents

1 Introduction

Key Features of Agilent 11713B/C Attenuator/Switch Drivers	12
Table 1. Key Features of 11713B/11713C	12
Compatible Agilent Attenuators and Switches	13
Table 2. Compatible Agilent Switches	13
Table 3. Compatible Agilent Attenuators	13
Connecting Accessories	14
Table 4. Connecting Accessories for Agilent 11713B/11713C	14
11713B Front and Rear Panels at a Glance	15
Figure 1. 11713B Front Panel Features	15
Figure 2. 11713B Rear Panel Features	17
11713C Front and Rear Panels at a Glance	18
Figure 3. 11713C Front Panel Features	18
Figure 4. 11713C Rear Panel Features	20

2 Installation

Initial Inspection	24
Preparing for Use	25
Bench Operation	25
Figure 5. Handle Positioning for Bench Operation	25
Rack Mounting One Instrument (Option 908)	26
Figure 6. Illustrations of steps 2 and 3	26
Rack Mounting Two Instruments (Option 909)	27
Figure 7. Illustration of completed setup	27
Connecting to Agilent Attenuators and Switches	28
Table 5. Summary of switches and attenuators connections to 11713B/C	28
Table 6. 11713CB/C Front Panel and Back Panel Properties	30
Driving Four-Section Attenuators and Switches	31
Figure 8. Typical connection for a programmable four-section attenuator	31
Driving Additional Coaxial Switches	32

Figure 9. Typical connection for 8762 and 8765 series coaxial switches	32
Figure 10. Typical connection for 8761 series coaxial switches	33
Driving Relays	34
Figure 11. Typical connection for relay driving circuit	34

3 Specifications

General Specifications	36
Drive Power Supply Specifications	36
Table 7. 11713B/C Drive Power Supply Specifications	36
Supplement Characteristics	36
Table 8. 11713B/C Supplemental Characteristics	36
Physical Specifications	37
Remote Programming Characteristics	37
Environmental Specifications	38
Table 9. 11713B/C Environmental Specifications	38
Safety and Regulatory Information	39
Safety Considerations	39
Compliance With Electromagnetic Compatibility (EMC)	39
Compliance With German Noise Requirement	39
Regulatory Markings	40

4 Verification

Operator's Check for Local Operation	42
Recommended Test Equipment	42
Table 10. Recommended Test Equipment	42
Procedure	43
Figure 12. Switching System for Verification	43
Operator's Check for Remote Operation	44

5 Local Operations

Getting Started with 11713B/C	46
Step One: Turn on 11713B/C	46
Step Two: Configure 11713B/C settings to drive attenuators and switches	47
Step Three: Configure 11713B/C connections to attenuators and switches	51
Table 11. Connection between 11713B/C and programmable attenuators	51
Table 12. Connection between 11713B/C and switches	51
Main Menu of 11713B/C	52

SYSTEM Menu	52
ATTEN Menu	53
CYCLE Menu	54
IO Menu	55
INFO Menu	56
UTILITY Menu	57
Preset Menu	59
Save/Recall State Menu	60
List of Default Values	61

6 Remote Operations

Configuring Remote Interface	64
Interface Selection	64
GPIB Configuration	64
USB Configuration	65
LAN Configuration	65
Control over telnet server	66
Conversational control using telnet (using port 5024)	66
Figure Figure 6-1. Example of control using telnet	67
Control from a program (using port 5025)	68
Figure Figure 6-2. Example of control from a program	68
Control using C or Visual Basic	69
Control using Agilent VEE	69
Figure Figure 6-3. Example of control using Agilent VEE	69
Control using Agilent I/O	70
Figure Figure 6-4. Example of control using Agilent I/O	70
Programming Guide (SCPI)	71
SCPI Command Syntax	71
Rules for Using a Channel or Scan List	71
Commands Relevant to Attenuators	72
Commands Relevant to Switches	74
Programming Guide (Legacy)	76
Data Message Input Format	76
SCPI and Legacy Commands Compatibility	77

7 Remote Interface Configurations

Connecting the 11713B/C to Your Computer	80
Connecting Over GPIB	80
Connecting Over USB	82
Connecting Over LAN	83
Exploring the 11713B/C Web Interface Over LAN	89

Launching the Web Interface	89
Figure 1. 11713B/C Web Interface's Welcome Window	90
Navigation Bar	90
Displaying the Browser Web Control Page	91
Figure 2. 11713B/C Browser Web Control Interface	91

8 Servicing the Attenuator/Switch Driver

Preparing a Static-Safe Workstation	94
Reducing ESD Damage	95
Maintenance and Adjustments	96
Fuse Removal/Replacement	96
Adjustment	96

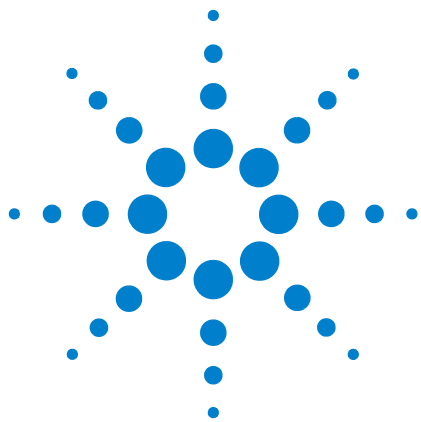

1 Introduction

Key Features of Agilent 11713B/C Attenuator/Switch Drivers	12
Compatible Agilent Attenuators and Switches	13
“Connecting Accessories	
11713B Front and Rear Panels at a Glance	15
11713C Front and Rear Panels at a Glance	18

This chapter provides you the overview of Agilent 11713B/C attenuator/switch drivers that includes the instruments’ functions and capabilities, compatibility with Agilent switching components and physical appearances.

Key Features of Agilent 11713B/C Attenuator/Switch Drivers

The 11713B attenuator/switch driver is a GPIB compatible instrument that concurrently drives up to two four-section programmable step attenuators and two microwave coaxial switches, or up to 10 SPDT switches. The 11713B is fully backward compatible with 11713A in terms of functionality and fit. Connectivity using USB and LAN are optional.

The 11713C attenuator/switch driver is a GPIB/USB/LAN compatible instrument that concurrently drives up to four four-section programmable step attenuators and four microwave coaxial switches, or up to 20 SPDT switches. The 11713C comes with tri-voltage selection of +5 V, +15 V and +24 V and also permits user-defined voltage supply capability.

NOTE

The 11713B/C attenuator/switch drivers output continuous current and do not support pulse drive. Please ensure your switching devices can withstand continuous current or have a built-in current interrupt feature.

Table 1 Key Features of 11713B/11713C

Key Features	11713B	11713C
Manually-controlled using front panel push buttons	Yes	Yes
Automatically-control through:		
GPIB	Yes	Yes
USB	Optional	Yes
LAN	Optional	Yes
Integrated LCD display	Yes	Yes
Self-contained power supply with current limiting	Yes	Yes
Common terminal supplies of:		
+5 Vdc	No	Yes
+15 Vdc	No	Yes
+24 Vdc	Yes	Yes
User-defined*	No	Yes
TTL control†	No	Yes

* For 11713C, maximum user-defined voltage supply is 30 Vdc.

† This TTL specification is 2.4V at 1mA.

Compatible Agilent Attenuators and Switches

The 11713B/C attenuator/switch drivers are designed to drive the following Agilent attenuators and switches. If you are using attenuators and switches made by another supplier, check the switching characteristics against those specified in [Chapter 3](#), “Specifications. Refer to Agilent 11713B/C Configuration Guide, literature number 5989-7277EN, for the most updated list.

Table 2 Compatible Agilent Switches

Agilent Model Number	Description *
8761A/B, 8765A/B/C/D/F (33314A/B/D), N1810UL	SPDT, unterminated
8762A/B/C/F (33311A/B/C), N1810TL	SPDT, terminated
8763A/B/C (33312A/B/C), N1811TL	Bypass, 4-port, terminated
8764A/B/C (33313A/B/C), N1812UL	Bypass, 5-port, unterminated
8766K (33366K)	SP3T, unterminated
8767K (33367K), 8767M, L7204A/B/C	SP4T, unterminated
87104A/B/C/D/E, 87204A/B/C/D/E, L7104A/B/C	SP4T, terminated
8768K (33368K), 8768M	SP5T, unterminated
8769K (33369K), 8769M, L7206A/B/C	SP6T, unterminated
87106A/B/C/D/E, 87206A/B/C/D/E, L7106A/B/C	SP6T, terminated
87222C/D/E, L7222C	DPDT (transfer), unterminated
87406B	Matrix, 4-port, terminated
87606B	Matrix, 6-port, terminated
U9397A/C	SPDT, terminated, solid state

* Electromechanical switches unless specified

Table 3 Compatible Agilent Attenuators

Agilent Model Number	Description
8494G/H (33320G/H), 84904K/L/M (33324K/L)	11 dB, 1 dB steps
8495G/H/K (33321 G/H/K), 84907K/L (33327K/L)	70 dB, 10 dB steps
8496G/H (33322G/H)	110 dB, 10 dB steps
8497K (33323K), 84906K/L (33326K/L)	90 dB, 10 dB steps
84905M	60 dB, 10 dB steps
84908M	65 dB, 5 dB steps

Connecting Accessories

Various types of connecting accessories are available to drive Agilent attenuators and switches using the 11713B/C attenuator/switch drivers. [Table 4](#) lists available accessories.

Table 4 Connecting Accessories for Agilent 11713B/11713C

Connecting Accessories	Description
11716A	Interconnect kit (Type-N connectors)*
11716C	Interconnect kit (SMA connectors)*
11713B-001 11713C-001	11764-60004, Viking connector to 10-pin DIP connector, 60 inches long
11713B-101 11713C-101	8120-2703, Viking connector to Viking connector, 60 inches long
11713B-201 11713C-201	5061-0969, Viking connector to 12-Pin conductor cable, bare wire (for five switches), 60 inches long
11713B-301 11713C-301	11761-60001, Viking connector to (4) ribbon cables, connect up to four switches, 60 inches long
11713B-401 11713C-401	11713-60042, Dual Viking connector to 16-Pin DIP connector, 60 inches long
11713B-501 11713C-501	11713-60043, Viking connector to (4) 9-Pin Dsub connectors, connect up to four switches, 60 inches long
11713B-601 11713C-601	11713-60044, Viking connector to 16-Pin DIP connector, 60 inches long
11713B-701 11713C-701	5064-7848, Viking connector to 14-pin DIP connector, 60 inches long
11713B-801 11713C-801	11713-60047, Viking connector to (4) 10-pin DIP connectors, connect up to 4 switches, 50 inches long
11713B-908 11713C-908	5063-9240, Rack mount kit for one instrument
11713B-909 11713C-909	5061-9694 & 5063-9212, Rack mount kit for two instruments

* Order this kit to connect two programmable step attenuators in series

Refer to Agilent 11713A/B/C Attenuator/Switch Driver Configuration Guide, literature number 5989-3703EN, for configuration details.

11713B Front and Rear Panels at a Glance

This section briefly describes the function of the front panel keys of 11713B.



Figure 1 11713B Front Panel Features

- 1 LCD screen.**
- 2 Softkeys.** These unmarked keys are referred to by the text on display next to them.
- 3 Menu/Enter.** Press this key to select the highlighted parameter On/Off or select the highlighted field or go back to the main menu.
- 4 Preset.** Press this key to preset the driver.
- 5 Config.** Press this key to access the configuration menu. You can set the attenuator type, supply voltage and TTL condition through this menu.
- 6 Save/Recall.** Press this key to save current settings or recall saved settings.
- 7 Navigation buttons.** The arrow keys are used to navigate parameters displayed on the LCD screen or change parameters such as GPIB address.

- 8 Switches.** In the local mode, pushbutton switches 9 and 0 change the position of a coaxial switch connected to rear panel banana jacks S9 A/B and S0 A/B respectively.
- 9 Attenuator Y.** In the local mode, pushbuttons 5, 6, 7, and 8 change the attenuation setting of an attenuator or change the position of coaxial switch(es) connected to the ATTEN Y connector on the rear panel.
- 10 Attenuator X.** In the local mode, pushbuttons 1, 2, 3, and 4 change the attenuation setting of an attenuator or change the position of coaxial switch(es) connected to the ATTEN X connector on the rear panel.
- 11 On/Standby.** Press this key to switch between on and standby. When power is supplied, the background LED is red. Pressing the key once, switches the driver on and the background LED turns to green.
- 12 Local.** Press this key to control the driver from the front panel when it is operating via the remote interfaces.

This section briefly describes the function of the rear panel connectors of 11713B.

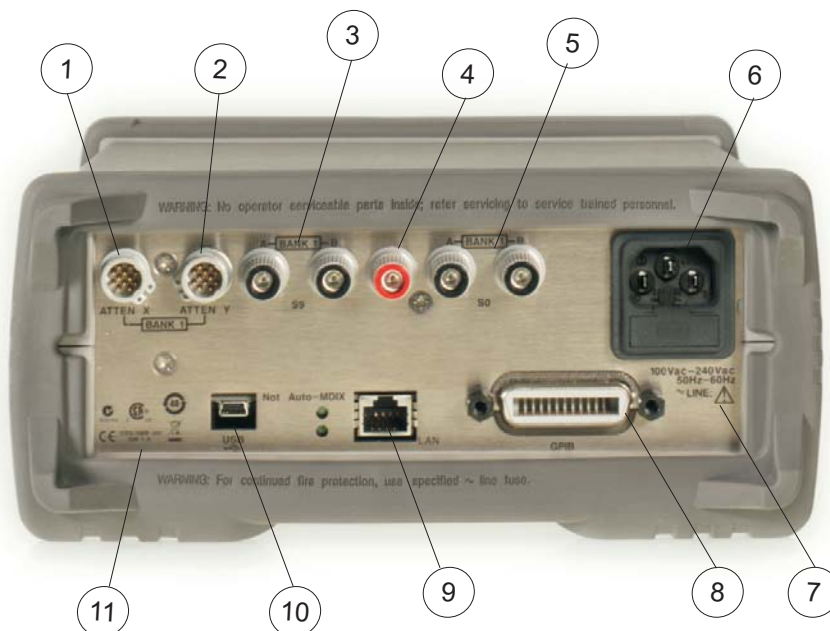

Figure 2 11713B Rear Panel Features

- 1 **ATTEN X.** Viking connector for connection to attenuator or switch(es).
- 2 **ATTEN Y.** Viking connector for connection to attenuator or switch(es).
- 3 **S9 A/B.** Banana jack connectors for connection to coaxial switch.
- 4 **24 VDC COM.** Banana jack connector to provide common +24 Vdc in driving the coaxial switches connected to S9 and/or S0.
- 5 **S0 A/B.** Banana jack connectors for connection to coaxial switch.
- 6 **Receptacle.** Matches transformer primary to line voltage via power cable.
- 7 **Alert symbol.** This symbol is used to point out a necessary reference for the user.
- 8 **GPIB Connector.** The interface connector from a source device to a listening device for the remote mode of operation.
- 9 **LAN Connector.** The interface connector for LAN cable (option LXI only).
- 10 **USB Connector.** The interface connector for Type mini B 5-pin USB cable (option LXI only).
- 11 **Instrument Markings.**

11713C Front and Rear Panels at a Glance

This section briefly describes the function of the front panel keys of 11713C.

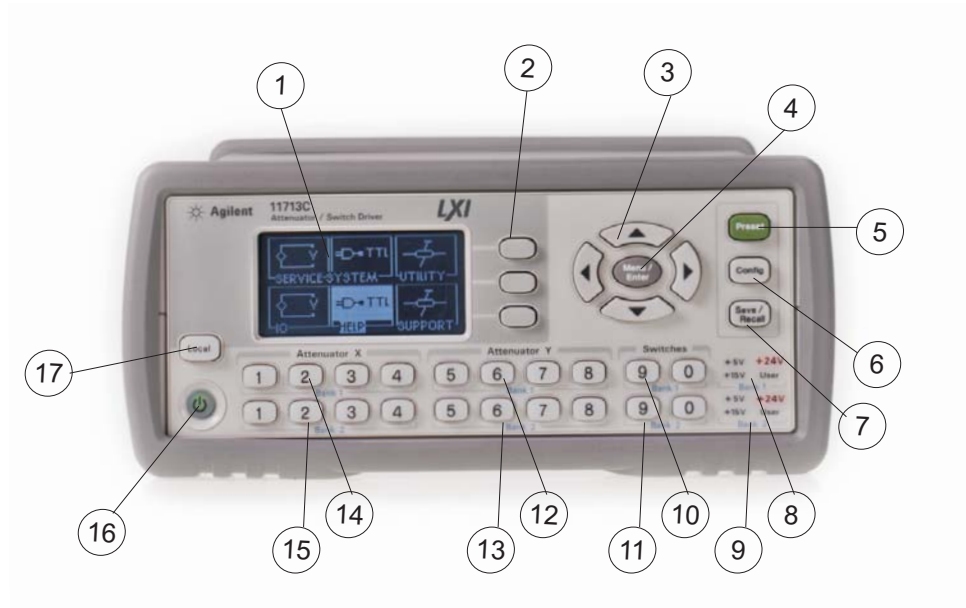

Figure 3 11713C Front Panel Features

- 1 LCD screen.**
- 2 Softkeys.** These unmarked keys are referred to by the text on display next to them.
- 3 Navigation buttons.** The arrow keys are used to navigate parameters displayed on the LCD screen or change parameters such as GPIB address.
- 4 Menu/Enter.** Press this key to select the highlighted parameter On/Off or select the highlighted field or go back to the main menu.
- 5 Preset.** Press this key to preset the driver.
- 6 Config.** Press this key to access the configuration menu. You can set the attenuator type, supply voltage and TTL condition through this menu.
- 7 Save/Recall.** Press this key to save current settings or recall saved settings.
- 8 Supply Voltage for Bank 1.** Indicates supply voltage setting (background LED in red) for bank 1.

- 9 Supply Voltage for Bank 2.** Indicates supply voltage setting (background LED in red) for bank 2.
- 10 Switches for Bank 1.** In the local mode, pushbutton switches 9 and 0 change the position of a coaxial switch connected to rear panel banana jacks S9 A/B and S0 A/B respectively, for bank 1.
- 11 Switches for Bank 2.** In the local mode, pushbutton switches 9 and 0 change the position of a coaxial switch connected to rear panel banana jacks S9 A/B and S0 A/B respectively for, bank 2.
- 12 Attenuator Y for Bank 1.** In the local mode, pushbuttons 5, 6, 7, and 8 change the attenuation setting of an attenuator or change the position of coaxial switch(es) connected to the ATTEN Y connector on the rear panel, for bank 1.
- 13 Attenuator Y for Bank 2.** In the local mode, pushbuttons 5, 6, 7, and 8 change the attenuation setting of an attenuator or change the position of coaxial switch(es) connected to the ATTEN Y connector on the rear panel, for bank 2.
- 14 Attenuator X for Bank 1.** In the local mode, pushbuttons 1, 2, 3, and 4 change the attenuation setting of an attenuator or change the position of coaxial switch(es) connected to the ATTEN X connector on the rear panel, for bank 1.
- 15 Attenuator X for Bank 2.** In the local mode, pushbuttons 1, 2, 3, and 4 change the attenuation setting of an attenuator or change the position of coaxial switch(es) connected to the ATTEN X connector on the rear panel, for bank 2.
- 16 On/Standby.** Press this key to switch between on and standby. When power is supplied, the background LED is red. Pressing the key once, switches the driver on and the background LED turns to green.
- 17 Local.** Press this key to control the driver from the front panel when it is operating via the remote interfaces.

This section briefly describes the function of the rear panel connectors of 11713C.

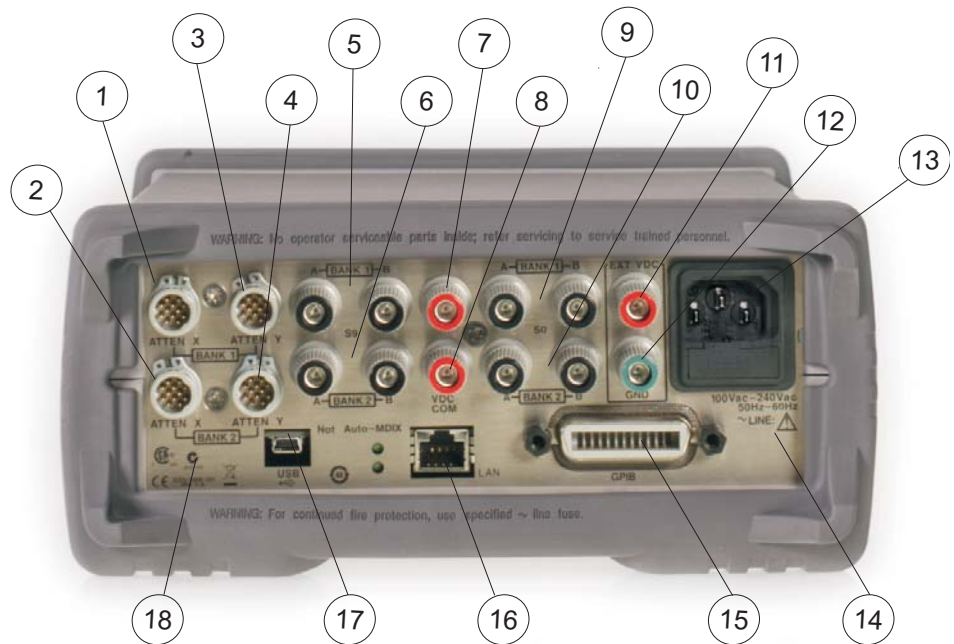

Figure 4 11713C Rear Panel Features

- 1 **ATTEN X Bank 1.** Viking connector for connection to attenuator or switch(es), for bank 1.
- 2 **ATTEN X Bank 2.** Viking connector for connection to attenuator or switch(es), for bank 2.
- 3 **ATTEN Y Bank 1.** Viking connector for connection to attenuator or switch(es), for bank 1.
- 4 **ATTEN Y Bank 2.** Viking connector for connection to attenuator or switch(es), for bank 2.
- 5 **S9 A/B Bank 1.** Banana jack connectors for connection to coaxial switch, for bank 1.
- 6 **S9 A/B Bank 2.** Banana jack connectors for connection to coaxial switch, for bank 2.
- 7 **VDC COM Bank 1.** Banana jack connector to provide common Vdc in driving the coaxial switches connected to S9 and/or S0, for bank 1.
- 8 **VDC COM Bank 2.** Banana jack connector to provide common Vdc in driving the coaxial switches connected to S9 and/or S0, for bank 2.

- 9 **S0 A/B Bank 1.** Banana jack connectors for connection to coaxial switch, for bank 1.
- 10 **S0 A/B Bank 2.** Banana jack connectors for connection to coaxial switch, for bank 2.
- 11 **External VDC.** Banana jack connector to provide user-defined Vdc, for both banks.
- 12 **Ground.** Banana jack connector to provide grounding, for both banks.
- 13 **Receptacle.** Matches transformer primary to line voltage via power cable.
- 14 **Alert symbol.** This symbol is used to point out a necessary reference for the user.
- 15 **GPIB Connector.** The interface connector from a source device to a listening device for the remote mode of operation.
- 16 **LAN Connector.** The interface connector for LAN cable.
- 17 **USB Connector.** The interface connector for Type mini B 5-pin USB cable.
- 18 **Instrument Markings.**

1 Introduction



2 Installation

Initial Inspection	24
Preparing for Use	25
“Bench Operation	
“Rack Mounting One Instrument (Option 908)	
“Rack Mounting Two Instruments (Option 909)	
Connecting to Agilent Attenuators and Switches	28
Driving Four-Section Attenuators and Switches	31
Driving Additional Coaxial Switches	32
Driving Relays	34

This chapter provides you important information on how to unpack and check your instrument, how to prepare your instrument for bench operation and tips on configuring 11713B/C with Agilent attenuators and switches.



Initial Inspection

- 1 Unpack and inspect the shipping container and its contents thoroughly to ensure that nothing was damaged during shipment. If the shipping container or cushioning material is damaged, the contents should be checked both mechanically and electrically.
- 2 If the contents are damaged or defective, contact your nearest Agilent Technologies Service and Support Office. Refer to the Service and Support information in the front matter of this manual. Agilent Technologies will arrange for repair or replacement of the damaged or defective equipment. Keep the shipping materials for the carrier's inspection.
- 3 If you are returning your instrument for service, repackaging the attenuator/switch driver requires original shipping containers and materials or their equivalents. Agilent Technologies can provide packaging materials identical to the original materials. Refer to "Service and Support" on page v for the Agilent Technologies nearest you.

Preparing for Use

Bench Operation

Pull the handle outwards, and adjust it into one of the two positions illustrated in Figure 5.

- (Top) Handle placed underneath the instrument to assure self-alignment of the instruments when stacked
- (Bottom) Handle tilted to raise the front of the instrument for easier viewing of the front panel



Figure 5 Handle Positioning for Bench Operation

Rack Mounting One Instrument (Option 908)

- 1 Remove the handle and front/rear bumpers
- 2 Fit the rack mount flanges (part number 5063-9240)
- 3 Ready for installation



Figure 6 Illustrations of steps 2 and 3

CAUTION

When installing the product in a cabinet, the convection into and out of the product must not be restricted. The ambient temperature (outside the cabinet) must be less than the maximum operating temperature of the product by 4 °C for every 100 watts dissipated in the cabinet. If the total power dissipated in the cabinet is greater than 800 watts forced convection must be used.

Rack Mounting Two Instruments (Option 909)

- 1 Remove the handle and front/rear bumpers
- 2 Fit one small mounting flange to opposite sides of each instrument (part numbers 5061-9694 and 5063-9212)
- 3 Fit two front linking plates to each instrument
- 4 Engage the linking plates at the front of the instruments
- 5 Attach the rear linking brackets
- 6 Ready for installation



Figure 7 Illustration of completed setup

CAUTION

When installing the product in a cabinet, the convection into and out of the product must not be restricted. The ambient temperature (outside the cabinet) must be less than the maximum operating temperature of the product by 4 °C for every 100 watts dissipated in the cabinet. If the total power dissipated in the cabinet is greater than 800 watts forced convection must be used.

Connecting to Agilent Attenuators and Switches

The 11713B/C attenuator/switch drivers can be used to drive various switches and attenuators. [Table 5](#) shows the summary of switches and attenuators connections to 11713B/C, with various interface cables for point-to-point connection. [Table 6](#) shows the properties of 11713B/C's front panel and rear panel.

For configuration details, please refer to Agilent 11713B/C Configuration Guide, literature number 5989-7277EN.

Table 5 Summary of switches and attenuators connections to 11713B/C

Switches/Attenuators	11713B/C Cable Option*	# of channels required†	Control by ATTEN X (1-4) ATTEN Y (5-8)	Control by SWITCHES (9/0)
Switches • 8761A/B	201	1	No	Yes
Switches • 8762A/B/C/F • 8763A/B/C • 8764A/B/C	201	2	Yes	Yes
Switches • 8765A/B/C/D/F	201, 301	2	Yes	Yes
Switches • 8766K	001, 101	2	Yes	Yes
Switches • N1810UL/TL‡ • N1811TL‡ • N1812UL‡	201, 501	2	Yes	Yes
Switches • 87222C/D/E • L7222C	201, 801	2	Yes	No
Switches • 8767K Attenuators • 8495G/H	001, 101	3	Yes	Yes
Switches • 8767M Attenuators • 84905M • 84907K/L	001	3	Yes	Yes

Table 5 Summary of switches and attenuators connections to 11713B/C

Switches • 8768K				
Attenuators • 8494G/H • 8496G/H • 8495K, 8497K	001, 101	4	Yes	Yes
Switches • 8768M				
Attenuators • 84904K/L/M • 84906K/L • 84908M	001	4	Yes	Yes
Switches** • 87104A/B/C/D • 87204A/B/C • L7104A/B/C • L7204A/B/C	201, 601	4††	Yes	Yes
Switches • 8769K	101	5	Yes	Yes
Switches • 8769M	701	5	Yes	Yes
Switches • 87106A/B/C/D • 87206A/B/C • L7106A/B/C • L7206A/B/C • 87406B, 87606B	201, 401	6††	Yes	Yes

* Type of interface cable required depends on the DC connector on the switching device

† One channel represent control with one pushbutton

‡ Ensure switch is equiped with current interrupt (option 403) to protect switch from overhetaing and destruction as this switch cannot withstand continuous current

**For switches with option 161, ground pin 16 opens all path. Use S9 for Attenuator X or S0 for Attenuator Y. Do not close any path and ground pin 16 simultaneously as this makes the switch buzz.

††If option 601 is used, number of channels required is 5, to cater for open all path function controlled via S9/S0

‡‡If option 401 is used, number of channels required is 7, to cater for open all path function controlled via S9/S0

Table 6 11713CB/C Front Panel and Back Panel Properties

Front Panel Pushbuttons*		Rear Panel Connectors	
Pushbutton Number	Pushbutton LEDs	Pin Numbers	Wire Color Code†
		1	Red (Vcc)
		2	White/Brown (Gnd)
SWITCHES			
9	ON	ATTEN X-3 (S9-A)	Gray
	OFF	ATTEN X-4 (S9-B)	White/Red
0	ON	ATTEN Y-3 (S0-A)	Gray
	OFF	ATTEN Y-4 (S0-B)	White/Red
ATTENUATORS			
X	Y		
1	5	OFF	5 Violet
		ON	6 Yellow
2	6	OFF	7 Black
		ON	8 Green
3	7	OFF	9 Orange
		ON	10 Blue
4	8	OFF	11 Brown
		ON	12 White

* The ON/OFF status of the pushbutton LEDs indicates which cable wire or pin on the rear panel connector is grounded. As an example, if ATTENUATOR X pushbutton 3 is illuminated, pin 10 of the ATTEN X connector (blue wire from cable) is grounded and pin 9 floats at a high impedance. For SWITCHES, if pin 3 is grounded (LED on), pin 4 is connected to +Vcc.

† With reference to interface cable option 201 (Viking connector to 12-pin bare), consists of 12 color-coded wires

Driving Four-Section Attenuators and Switches

- To use one four-section attenuator assembly, connect an attenuator interface cable either to the ATTEN X output (A6J1) or ATTEN Y output (A6J2). Connect all outputs (two for 11713B and four for 11713C) to have more than four attenuator segments.
- A typical connection for a programmable four-section attenuator to 11713B is illustrated in Figure 8, together with pin number for each connector.
- Using these same connections to Agilent 8762 or 8765 series coaxial switches, control can be extended to number of switches in multiple of four. If S9 and S0 outputs are utilized, 11713B and 11713C can drive up to 10 switches and 20 switches respectively.

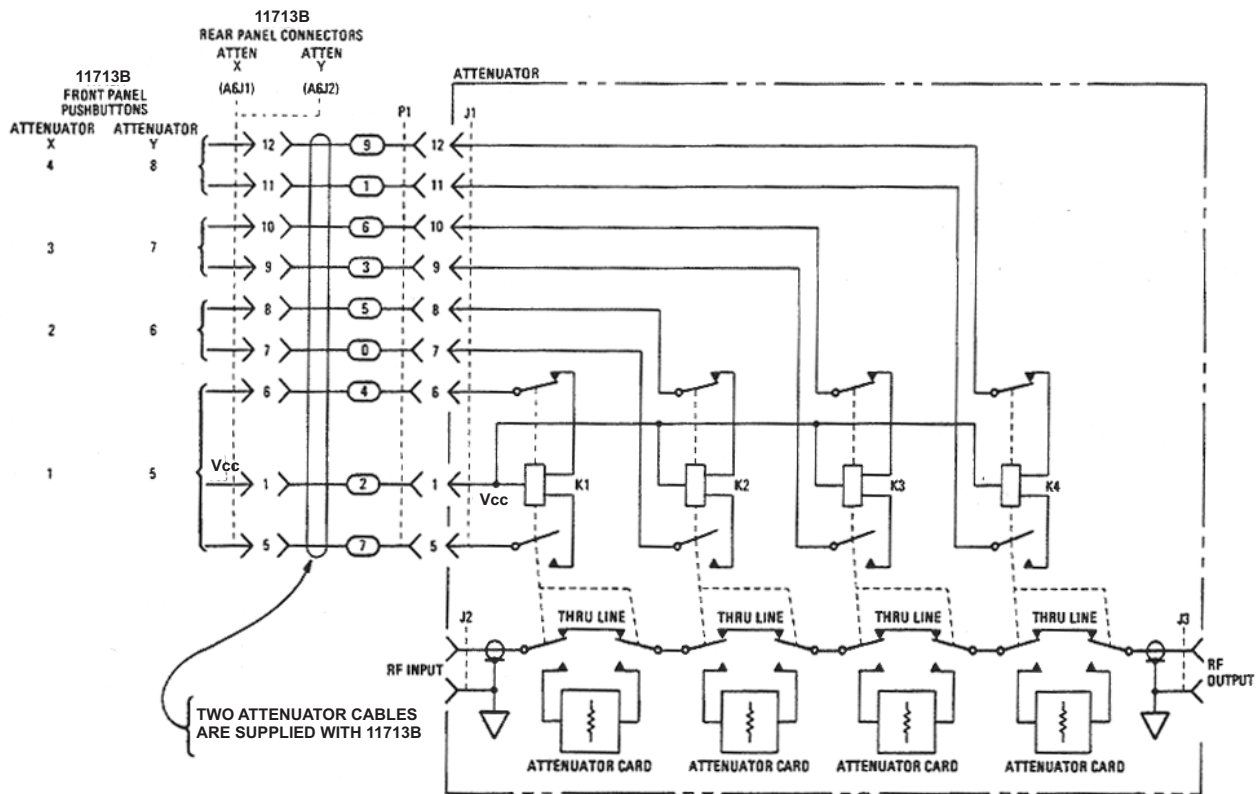

Figure 8 Typical connection for a programmable four-section attenuator

Driving Additional Coaxial Switches

- Make switch connections to S0 outputs, S9 outputs, or to rear panel ATTEN X output or ATTEN Y output.
- [Figure 9](#) below shows the rear panel connections to S0 outputs and the corresponding switch positions reflected by pushbutton indicators.
- Connections to Agilent 8762 or 8765 series coaxial switches can also be made to the ATTEN X output or ATTEN Y output as illustrated in [Figure 8](#).

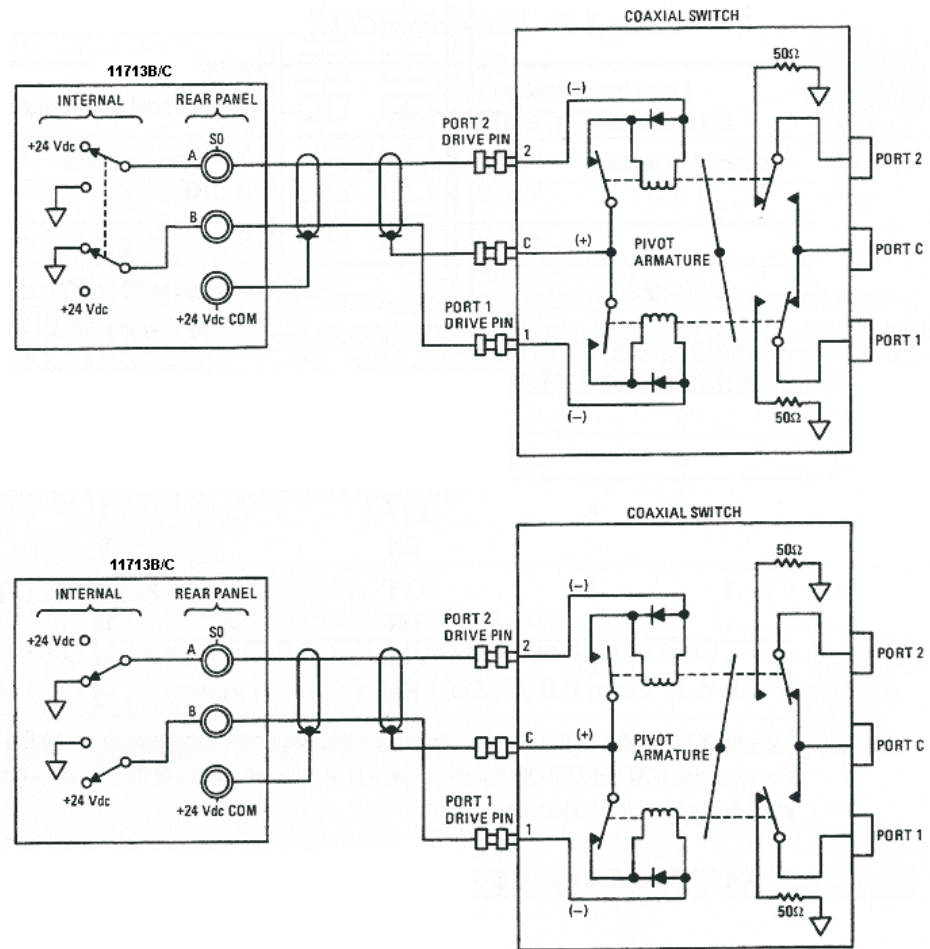

Figure 9 Typical connection for 8762 and 8765 series coaxial switches

- Connections to Agilent 8761 series coaxial switches can only be made to S0 outputs and S9 outputs.
- **Figure 10** illustrates the rear panel connections to S9 outputs and the corresponding switch positions reflected by pushbutton indicators.

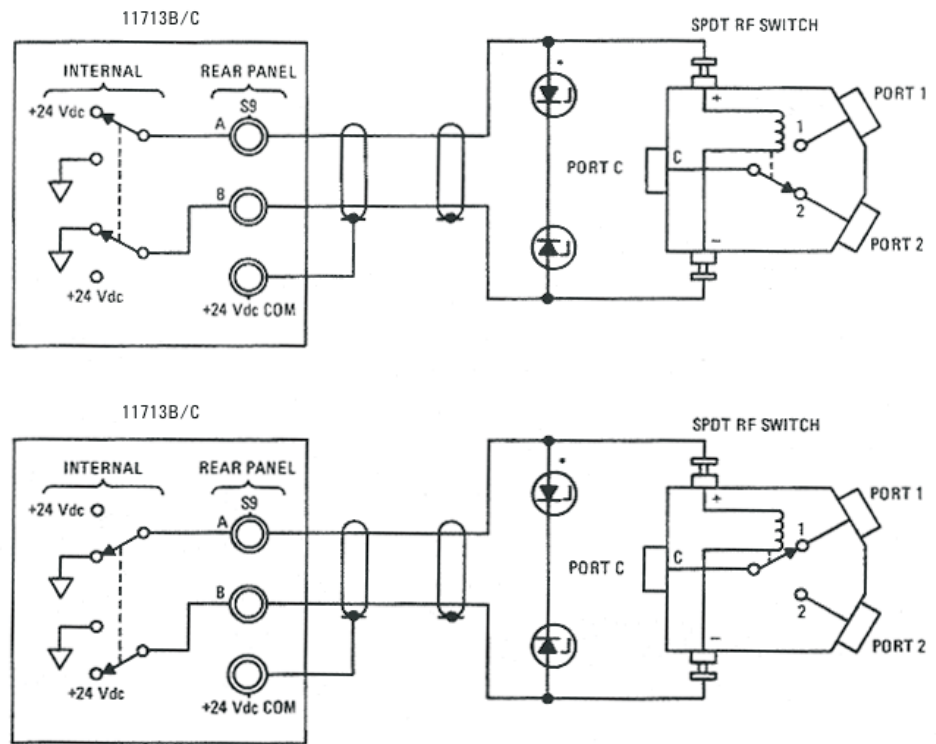

Figure 10 Typical connection for 8761 series coaxial switches

Driving Relays

- To drive ten devices for 11713B, connect attenuator cables at ATTEN X and Y and switch cables to S9 and S0.
- A total of 10 relays may be on at one time if the total current is less than 1.7 A. However, since there are dual transistor and relay drivers, where one driver is on while the other is off, a total of 20 relays may be controlled.

NOTE

11713C is capable of driving double the amount of devices that 11713B can. However, the total load current can be consumed is still 1.7 A.

CAUTION

If the total load current of 1.7 A is exceeded, damage may result.

- [Figure 11](#) below shows the connections for a simplified relay driving circuit. The circuit is adaptable for simple non-latching relays.

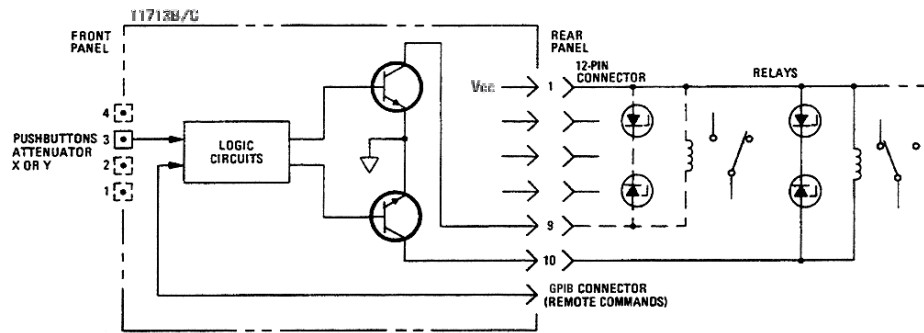
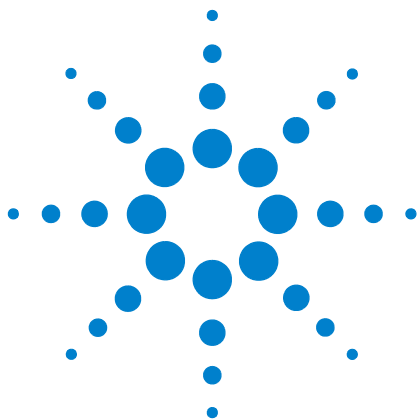

Figure 11 Typical connection for relay driving circuit

NOTE

It is also recommended that two 28.7 V zener diodes be connected back-to-back across the relay coils to reduce voltage transients.



3 Specifications

General Specifications	36
"Drive Power Supply Specifications	
"Supplement Characteristics	
"Physical Specifications	
"Remote Programming Characteristics	
Environmental Specifications	38
Safety and Regulatory Information	39
"Safety Considerations	
"Compliance With Electromagnetic Compatibility (EMC)	
"Compliance With German Noise Requirement	
Regulatory Markings	40

This chapter provides you the specifications of Agilent 11713B/C attenuator/switch drivers.

General Specifications

Drive Power Supply Specifications

Specifications below describe warranted performance over the temperature range 0 to +50 °C after one hour of continuous operation, unless otherwise noted.

Table 7 11713B/C Drive Power Supply Specifications

Voltage	+24 ± 8% Vdc +5 ± 5% Vdc * +15 ± 12% Vdc *
Current	1.7 A maximum continuous current Contact pairs 1 through 8, 9, and 0, maximum current of 1.7 A continuous through all contacts (< 0.7 A per contact)

* For 11713C only

Supplement Characteristics

Supplement characteristics are intended to provide useful information and are typical but non-warranted performance parameters.

Table 8 11713B/C Supplemental Characteristics

Power	100 to 240 Vac, automatic selection, 50/60 Hz 100 VA maximum Mains supply voltage fluctuations are not to exceed 10 percent of the nominal supply voltage
Response Time	100 µs maximum for contact pairs 1 through 8 20 ms maximum for contact pairs 9 and 0
Driver Life	> 2,000,000 switchings at 0.7 A for contact pairs 9 and 0
Maximum Load Inductance	500 mH
Maximum Load Capacitance	< 0.01 µF for contact pairs 9 and 0

Physical Specifications

Net Weight	3.2 kg (7.1 lbs)
Dimensions (H x W x D) with handle and rubber bumper	103.8 mm x 232.2 mm x 378.7 mm (4.1 inches x 9.1 inches x 14.9 inches)
Dimensions (H x W x D) without handle and rubber bumper	88.3 mm x 212.7 mm x 346.0 mm (3.5 inches x 8.4 inches x 14.3 inches)

Remote Programming Characteristics

Interface	GPIB interface operates to IEEE 488.2 and IEC65 10/100 BaseT LAN interface USB 2.0 interface
Command Language	SCPI standard interface commands (Agilent 11713A backward compatible)
GPIB Compatibility	SH0, AH1, T0, TE0, L2, LE0, SR0, RL1, PP0, DC0, DT0, C0

Environmental Specifications

Agilent 11713B/C attenuator/switch drivers are designed to fully comply with Agilent Technologies' product operating environmental specifications shows in table below.

Table 9 11713B/C Environmental Specifications

Temperature	
• Operating	0°C to +50°C
• Storage	-40°C to +70°C
Humidity	
• Operating	95% RH at 40°C, 5 days cyclic
• Storage	90% RH at 65°C, 24 hours
• Condensing	95% RH at 40°C, 5 hours (condensation 15 minutes)
Shock	
• End-user handling	Half-sine: 2-3 ms duration, 60 in/s (1.6 ms) delta-V
• Bench Handling	Per MIL-PRF-28800F
• Functional	Half-sine: 11 ms duration, 30 grms
• Transportation	Trapezoidal: 18-22 ms duration, 337 in/s (8.56 ms) delta-V
Vibration	
• Operating	Random: 0.21G rms, 5 to 500 Hz, 10 min/axis
• Survival	Random: 2.09G rms, 5 to 500 Hz, 10 min/axis Swept-sine: 0.5 G rms, 5 to 500 Hz, 10 min/axis
Altitude	
• Operating	< 4,000 meters (13,123 feet)
• Non-operating	< 15,300 meters (50,000 feet)

Safety and Regulatory Information

Safety Considerations

This product has been designed and tested in accordance with IEC 61010-1:2001, Safety Requirements for Electronic Measuring Apparatus, and has been supplied in a safe condition. The Instruction documentation contains information and warnings which must be followed by the user to ensure safe operation and to maintain the product in safe condition.

Compliance With Electromagnetic Compatibility (EMC)

This product conforms with the protection requirements of EMC Directive 2004/108/EC for Electromagnetic Compatibility.

The conformity assessment requirements have been met using the technical Construction file route to compliance, using EMC test specifications EN 55011:1990 (Group 1, Class A).

In order to preserve the EMC performance of the product, any cable which becomes worn or damaged must be replaced with the same type and specifications.

Refer to the Declaration of Conformity

Compliance With German Noise Requirement

Acoustic Noise Emission This is to declare that this instrument is in conformance with the German Regulation on Noise Declaration for Machines.



- LpA < 70 dB
- Operator position
- Normal position
- per ISO 7779

Gerauschemission Laermangabe nach der Maschinenlaermverordnung-3.GSGV Deutschland.

- LpA < 70 dB
- am Arbeitsplatz
- normaler Betrieb
- nach DIN 45635 t.19

Regulatory Markings

The following markings can be found on the rear panel.

	The CE mark shows that the product complies with all the relevant European Legal Directives.
ISM 1-A	ICES/NMB-001 indicates that this ISM device complies with Canadian ICES-001. Cet appareil ISM est conforme a la norme NMB-001 du Canada.
	The CSA mark is a registered trademark of the Canadian Standards Association. A CSA mark with the indicators "C" and "US" means that the product is certified for both the U.S. and Canadian markets, to the applicable American and Canadian standards.
ICES/NMB -001	This is the symbol of an Industrial Scientific and Medical Group 1 Class A product.
	The C-Tick mark is a registered trademark of the Spectrum Management Agency of Australia. This signifies compliance with the Australian EMC Framework Regulations under the terms of the Radio communications Act of 1992.



4 Verification

Operator's Check for Local Operation 42

“Recommended Test Equipment

“Procedure

Operator's Check for Remote Operation 44

This chapter provides you simply instructions to verify Agilent 11713B/C attenuator/switch drivers' functionality in both local operation and remote (GPIB/USB/LAN) operation.



Operator's Check for Local Operation

Recommended Test Equipment

Table 10 lists the test equipment required for performance test verification and equipment troubleshooting. Equipment other than the recommended models can be used, provided minimum specifications are satisfied.

Table 10 Recommended Test Equipment

Instrument Type	Critical Specifications	Use*
Digital Voltmeter	0 to +30 Vdc	T
Attenuators (2 required)	Programmable, 4 sections	P, T
Switches (2 required)	+5 Vdc, +15 Vdc or +24 Vdc drive source	P, T

* P = Performance, T = Troubleshooting

Procedure

- 1 Configure switching system illustrated in [Figure 12](#) by following all steps found in [Chapter 5](#), “Local Operations.”

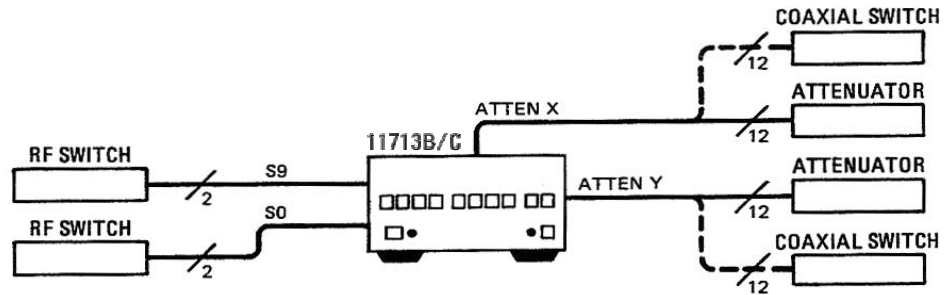

Figure 12 Switching System for Verification

- 2 Once configuration is completed, press and depress the 10 numbered pushbuttons on the driver front panel. Each LED should alternate between off and on as each key is pressed.
- 3 In addition, if any switching devices is connected (attenuators, relays or switches), an audible click should be heard from the unit actuated. Pressing any numbered pushbutton should not cause any other push button to change state.

Operator's Check for Remote Operation

These procedure verify that the driver can be controlled remotely using GPIB, USB and/or LAN.

- 1 Refer to [Chapter 7](#), "Remote Interface Configurations, to connect 11713B/C to your computer through GPIB, USB and/or LAN.
- 2 Once remote connection is available, send the following SCPI commands to the driver and note the changes on front panel LEDs.

Description	Command	Observation
Close switching paths from channel 1 to channel 4 (bank1)	ROUte:CLoSe (@101:104)	LEDs for pushbuttons 1 to 4 light ON
Open switching paths from channel 5 to channel 8 (bank 1)	ROUte:OPEn (@105:108)	LEDs for pushbuttons 5 to 8 light OFF
Query status on channel 2 (bank 1)	ROUte:CLoSe? (@102)	Return value "1" (LED for pushbutton 2 light ON)
Query status on channel 7 (bank 1)	ROUte:CLoSe? (@107)	Return value "0" (LED for pushbutton 7 light OFF)

If the above checks are successful, the driver's remote operation is working correctly. These procedures do not check all of the drivers's program codes that can be executed. However, if the driver work correctly from the front panel, there is a high probability that the driver will respond to all the program codes.

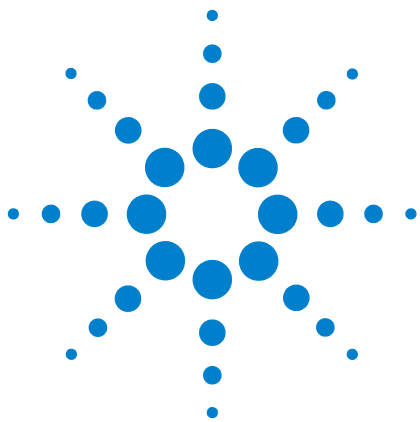

5 Local Operations

Getting Started with 11713B/C 46

“Step One: Turn on 11713B/C

“Step Two: Configure 11713B/C settings to drive attenuators and switches

“Step Three: Configure 11713B/C connections to attenuators and switches

Main Menu of 11713B/C 52

“SYSTEM Menu

“ATTEN Menu

“CYCLE Menu

“IO Menu

“INFO Menu

“UTILITY Menu

Preset Menu 59

Save/Recall State Menu 60

List of Default Values 61

This chapter outlines the some simple steps to begin using the 11713B/C in local operations. Also, functionality of all menus are described to assist operations using 11713B/C.



Getting Started with 11713B/C

Agilent 11713B/C attenuator/switch driver can be easily configured to drive programmable attenuators and/or switches through the front panel operations. The following three simple steps will guide you through the configuration of 11713B/C.

Step One: Turn on 11713B/C

NOTE

For Step One, all details on 11713C is applicable to 11713B

- 1 Connect AC power supply to 11713B/C. You should see:
 - background LED of the power button is red which indicates that 11713B/C is in standby mode
- 2 Press power button once to turn on the 11713B/C. You should see:
 - background LED turns green
 - six menus displayed on the LCD screen
 - all numbered buttons are lighted up¹

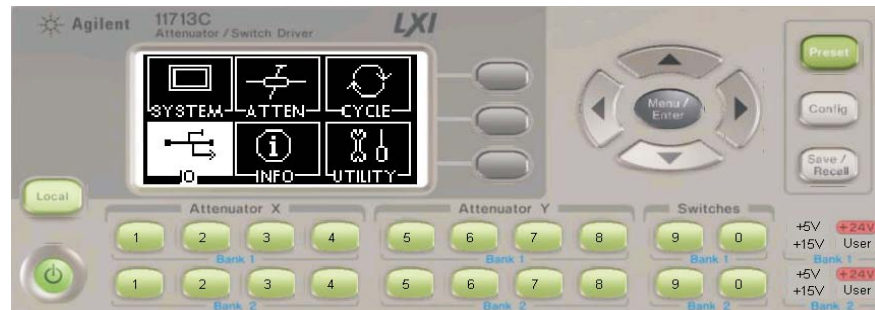

- 3 Ensure **Local** button is lighted up to enable operation through front panel. If not, press button once.
- 4 Now, you are ready to configure the 11713B/C.

¹ At factory default setting. Last state is followed if instrument was configured before shut down.

Step Two: Configure 11713B/C settings to drive attenuators and switches

To drive programmable attenuators

NOTE

Step Two - to drive programmable attenuators, only item 2 is applicable to 11713B. When Config button is pressed, the next screen is CONFIGURATION MENU.

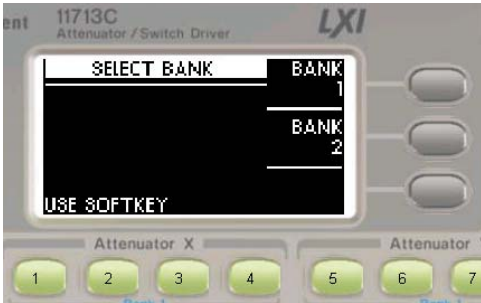
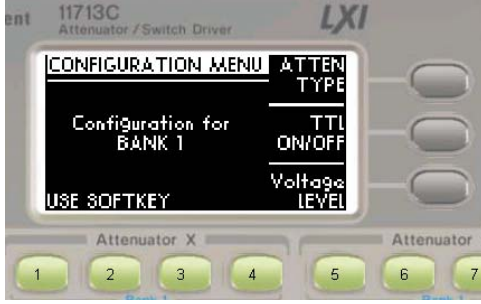
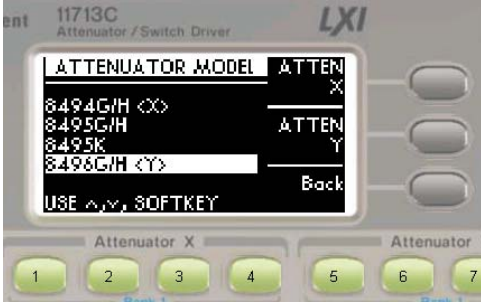
Item	Action	Illustration
1 Select bank (only for 11713C)	<p>a Press Config button</p> <p>b At SELECT BANK screen, you can see two softkey selections: BANK1 and BANK2</p> <p>c Press BANK1 softkey to select bank 1</p> <p>d Press BANK2 softkey to select bank 2</p>	
2 Select attenuator type	<p>a At CONFIGURATION MENU screen, press ATTEN TYPE softkey</p> <p>b At ATTENUATOR MODEL screen, scroll to highlight the desired attenuator model number using the navigation keys.</p> <p>c Once the attenuator model is determined, press ATTEN X or ATTEN Y softkey to assign the selected attenuator model</p> <p>d Repeat step b and c if needed</p> <p>e Model assigned to ATTEN X and ATTEN Y is marked <X> (e.g. 8494G/H) and <Y> (e.g. 8496G/H) respectively</p> <p>f To return to the previous screen, press BACK softkey</p>	 

Item	Action	Illustration
<p>3 Select voltage type (only for 11713C)</p>	<p>a At CONFIGURATION MENU screen, press Voltage LEVEL softkey</p> <p>b At OUTPUT VOLTAGE screen, scroll to highlight the desired voltage (e.g. +5V)</p> <p>c Press SET softkey to assign highlighted voltage</p> <p>d At the next screen, press OK softkey to confirm decision or press Cancel softkey to cancel</p> <p>e Output voltage assigned is marked <*></p> <p>f To exit this screen, press BACK softkey</p>	

To drive switches

NOTE

Step Two - to drive switches, only applicable to 11713C as 11713B is predefined with +24 Vdc supply and no TTL drive

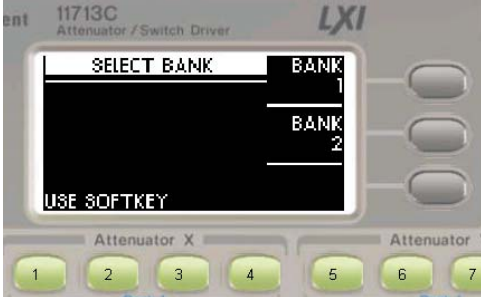
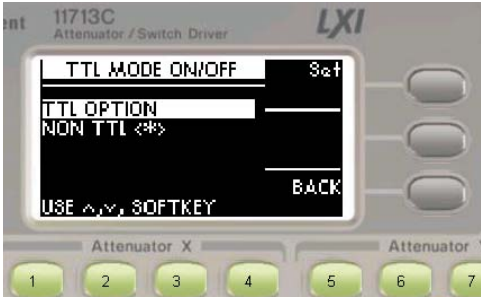
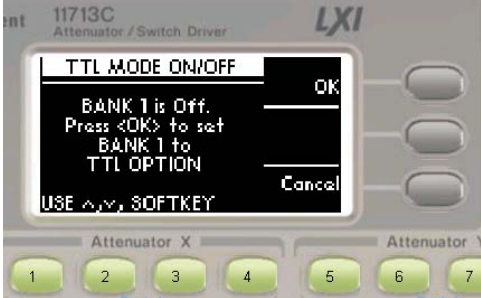
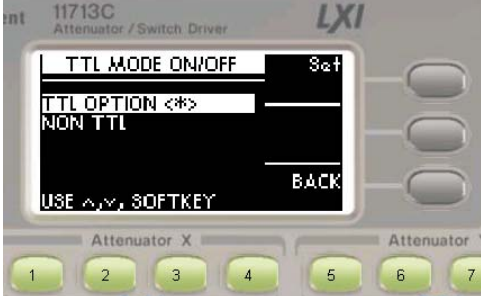
Item	Action	Illustration
1 Select bank (only for 11713C)	<p>a Press Config button</p> <p>b At SELECT BANK screen, you can see two softkey selections: BANK1 and BANK2</p> <p>c Press BANK1 softkey to select bank 1</p> <p>d Press BANK2 softkey to select bank 2</p>	
2 Select voltage type (only for 11713C)	<p>a At CONFIGURATION MENU screen, press TTL ON/OFF softkey</p> <p>b At TTL MODE ON/OFF screen, scroll to highlight the TTL OPTION or Non TTL (e.g. TTL OPTION)</p> <p>c Press SET softkey to assign highlighted voltage</p> <p>d At the next screen, press OK softkey to confirm decision or press Cancel softkey to cancel</p> <p>e Selection is marked <*></p> <p>f To exit this screen, press BACK softkey</p>	  

Item	Action	Illustration
<p>3 Select voltage type (only for 11713C)</p>	<p>a At CONFIGURATION MENU screen, press Voltage LEVEL softkey</p> <p>b At OUTPUT VOLTAGE screen, scroll to highlight the desired voltage (e.g. +5V)</p> <p>c Press SET softkey to assign highlighted voltage</p> <p>d At the next screen, press OK softkey to confirm decision or press Cancel softkey to cancel</p> <p>e Output voltage assigned is marked <*></p> <p>f To exit this screen, press BACK softkey</p>	 <p>The illustrations show the LXI 11713C configuration process. The first screenshot shows the 'CONFIGURATION MENU' with options: +5V (highlighted), +15V, +24V <*>, and USER. The 'SET' softkey is visible. The second screenshot shows the 'BANK 1 is Off. Press <OK> to set BANK 1 to +5V' screen with 'OK' and 'Cancel' softkeys. The third screenshot shows the 'CONFIGURATION MENU' with '+5V <*>' highlighted and the 'BACK' softkey.</p>

Step Three: Configure 11713B/C connections to attenuators and switches

- 1 Determine interface cable option of the 11713B/C
- 2 Determine DC connector option of the attenuator(s) or switch(es)
- 3 Check for compatibility using [Table 11](#) for programmable attenuators and [Table 12](#) for switches:

Table 11 Connection between 11713B/C and programmable attenuators

11713B/C	Attenuators (Option)
Option 001	8494G/H, 8495G/H, 8496G/H, 8495K, 8497K (Option 016) 84904K/L/M, 84905M, 84906K/L, 84907K/L, 84908M (No option)
Option 101	8494G/H, 8495G/H, 8496G/H, 8495K, 8497K (Option 060)

Table 12 Connection between 11713B/C and switches

11713B/C	Switches (Option)
Option 001	8766K, 8767K/M, 8768K/M (Option 016)
Option 101	8766K, 8767K/M, 8768K/M, 8769K/M (Option 060)
Option 201	8763A/B/C, 8764A/B/C, 8761A/B, 8762A/B/C/F (No option) 8765A/B/C/D/F (Option 305/310/315/324) N1810UL/TL, N1811TL, N1812UL (Option * 202) 87104A/B/C/D, 87204A/B/C, 87106A/B/C/D, 87206A/B/C (Option 100) L7104A/B/C, L7204A/B/C, L7106A/B/C, L7206A/B/C (Option 100) 87406B, 87606B (Option 100) 87222C/D/E, L7222C (Option 100)
Option 301	8765A/B/C/D/F (Option 005/010/015/024)
Option 401	87106A/B/C/D, 87206A/B/C (Option 161) L7106A/B/C, L7206A/B/C (Option 161) 87406B, 87606B (Option 161)
Option 501	N1810UL/TL, N1811TL, N1812UL (Option * 201)
Option 601	87104A/B/C/D, 87204A/B/C (Option 161) L7104A/B/C, L7204A/B/C (Option 161)
Option 701	8769K/M (Option 016)
Option 801	87222C/D/E, L7222C (Option 161)

* If TTL is required, include Option 401. Must order switch with Option 403 (current interrupt) as switch cannot withstand continuous current supplied by 11713B/C

- 4 For more details, refer to 11713B/C Configuration Guide, literature number 5989-7277EN.

Main Menu of 11713B/C

The main menu can be displayed on the LCD screen by pressing the **Menu/Enter** button. The six submenus, each with their own functionality, are described in the subsequent sections.

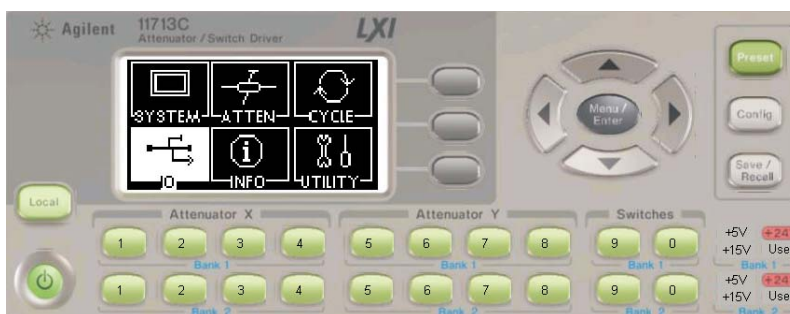

SYSTEM Menu

Function	Action	Illustration
Display attenuator type(s) configured for 11713B/C	<ol style="list-style-type: none"> a Navigate to the SYSTEM icon using the navigation keys b Press Menu/Enter button when SYSTEM icon is highlighted c On display are attenuator models assigned to ATTEN X and ATTEN Y for each bank (e.g. 8494G/H, 8496G/H, N/A, N/A) d Press Menu/Enter button again to return to main menu 	<p>The illustration shows the SYSTEM menu screen. The LCD displays the following text: 'SYSTEM' at the top, followed by 'BANK 1: TTL mode on', 'ATTEN X: 8494G/H', 'ATTEN Y: 8496G/H', 'BANK 2: TTL mode off', 'ATTEN X: N/A', and 'ATTEN Y: N/A'. Below the screen, the numeric keypad for Attenuator X is visible, with buttons 1 through 7.</p>

ATTEN Menu

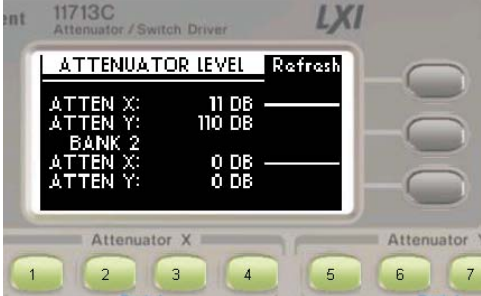
Function	Action	Illustration
Display attenuation levels of each bank	<p>a Navigate to the ATTEN icon using the navigation keys</p> <p>b Press Menu/Enter button when ATTEN icon is highlighted</p> <p>c On display are attenuation level for ATTEN X and ATTEN Y (e.g. 11 dB, 110 dB, 0, 0)</p> <p>d Press Menu/Enter button again to return to main menu</p>	

Attenuation value on display changes according to input from front panel pushbuttons or through the virtual web interface:

- Pushbutton LED ON - attenuation card selected (attenuation applied) on corresponding attenuator section
- Pushbutton LED OFF - thru path selected (attenuation lifted) on corresponding attenuator section

CYCLE Menu

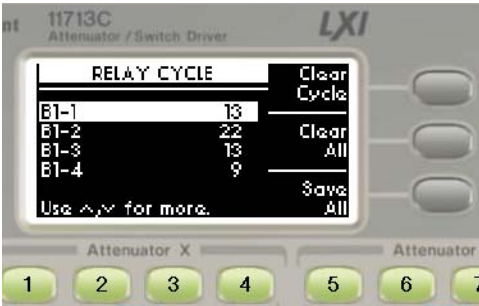
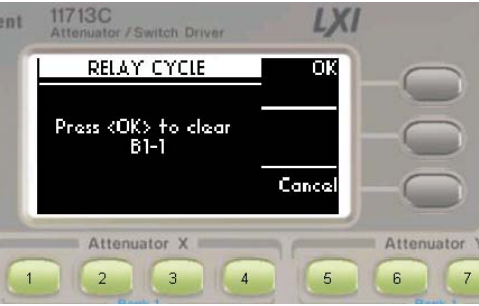
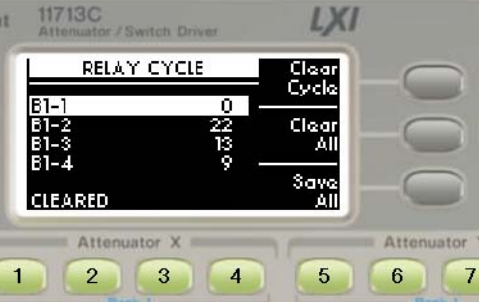
Function	Action	Illustration
<p>Display number of cycles of switching path for each channel</p> <ul style="list-style-type: none"> • 10 channels for 11713B (CH1 to CH9, CH0) • 20 channels for 11713C (B1-1 to B1-10, B2-1 to B2-10) 	<p>a Navigate to the CYCLE icon using the navigation keys</p> <p>b Press Menu/Enter button when CYCLE icon is highlighted</p> <p>c On display are number of relay cycles for each channel</p> <p>d Press Menu/Enter button again to return to main menu</p>	
<p>Clear cycle for selected channel(s)</p>	<p>a Scroll to the desired bank-channel (e.g. B1-1) using the navigation keys</p> <p>b Press CLEAR CYCLE</p> <p>c At the next screen, press OK softkey to confirm decision or press Cancel softkey to cancel</p> <p>d Note that relay cycle for B1-1 is 0 and below screen indicates CLEARED.</p>	 

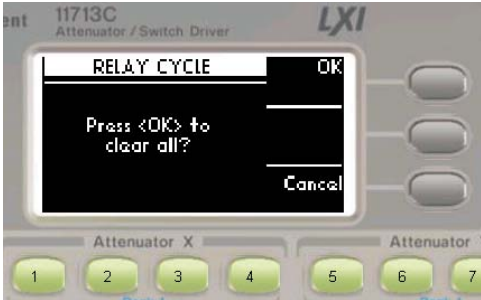
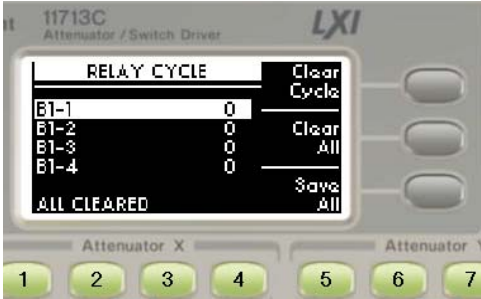
Function	Action	Illustration
Clear cycle for all channels	a Press Clear All	
	b At the next screen, press OK softkey to confirm decision or press Cancel softkey to cancel. c Note that relay cycle for all channels is 0	
Save cycle for all channels	a Press Save All	
	b At the next screen, Cycles saved. appears and this confirms all channels' cycles are saved.	

IO Menu

Refer to [Chapter 7](#), “Remote Interface Configurations.”

INFO Menu

Function	Action	Illustration
Display system info for 11713B/C <ul style="list-style-type: none"> • Model • Serial number • Firmware revision • GPIB address • LAN IP • USB address • MAC address 	<ol style="list-style-type: none"> a Navigate to the INFO icon using the navigation keys b Press Menu/Enter button when INFO icon is highlighted c Press Menu/Enter button again to return to main menu 	

UTILITY Menu

Function	Action	Illustration
Display system utility settings for 11713B/C and adjust beep volume Beep volume range from 0 (mute) to 8 (loudest)	<ol style="list-style-type: none"> a Navigate to the UTILITY icon using the navigation keys b Press Menu/Enter button when UTILITY icon is highlighted c Scroll to highlight Beep volume using the navigation keys d Adjust beep volume using Volume up and Volume down softkey e Press Menu/Enter button again to return to main menu 	

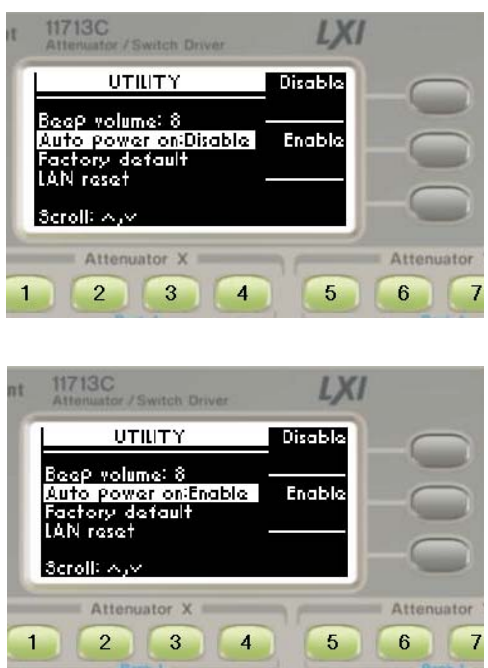
Function	Action	Illustration
To enable Auto-Power on	<p>a Scroll to highlight Auto-Power on using the navigation keys, then press Enable softkey.</p> <p>b Factory default is set as Disable for this feature.</p> <p>c The status shows Enable.</p> <p>d There are 3 possible outcomes for standby mode as following:</p> <ul style="list-style-type: none"> • Selects unit on standby, the unit will remain on standby. • When unit is on standby, unplugging the unit <i>within 5s</i> and then replugging it will cause the unit remain on standby mode. • When unit is on standby, unplugging the unit <i>after 5s</i> and then replugging it will cause the unit to auto power on. <p>e Recommendation: To enable the auto power on, it is recommended to use "Save Cycles" (via LCD display or SCPI remote command) to save the cycle count before powering the unit off.</p>	 <p>The illustration consists of two screenshots of the LXI utility menu. The top screenshot shows the menu with 'Auto power on: Disable' and 'Enable' as a softkey. The bottom screenshot shows the menu with 'Auto power on: Enable' and 'Enable' as a softkey. The menu also includes options for 'Beep volume: 8', 'Factory default', and 'LAN reset'. The device model '11713C' and 'Attenuator / Switch Driver' are visible at the top of the screen.</p>

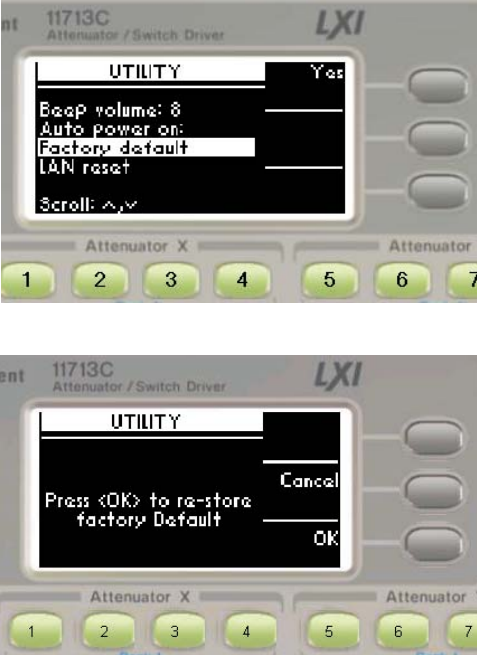
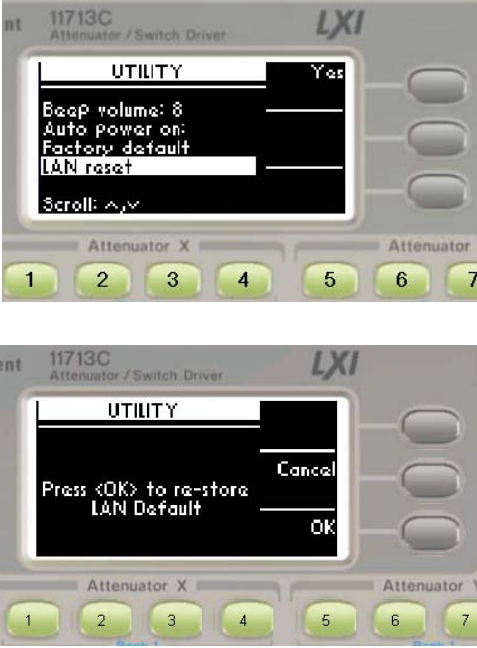
Function	Action	Illustration
Set factory default <ul style="list-style-type: none"> For more information: "List of Default Values" on page 61 	<ol style="list-style-type: none"> Scroll to highlight Factory default using the navigation keys, then press Yes softkey At the next screen, press OK softkey to confirm decision or press Cancel softkey to cancel. 	
Reset LAN	<ol style="list-style-type: none"> Scroll to highlight LAN RESET using the navigation keys, then press Yes softkey At the next screen, press OK softkey to confirm decision or press Cancel softkey to cancel. 	

Preset Menu

The preset function is used to apply full attenuation or open all switching paths (all LEDs light ON). For more information: "List of Default Values" on page 61.

Save/Recall State Menu

The save state function is important to enable user to store up to four different configurations and the recall state function allows user to reinstate one of the four saved states for use. This greatly helps to minimize the amount of works required to make “standard” configuration changes.

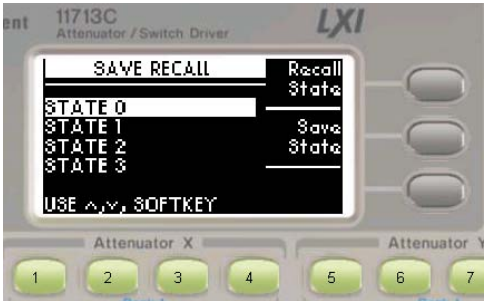
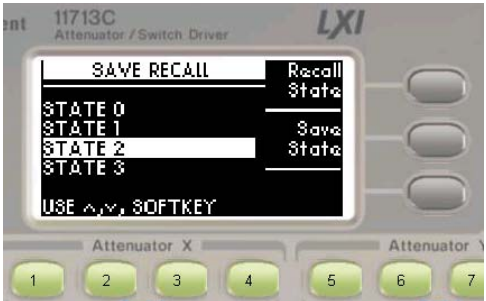
Function	Action	Illustration
To save state	<ol style="list-style-type: none"> a Press Save/Recall button b Scroll to the desired state to store configuration (e.g. STATE 0) using the navigation keys c Press Save State softkey to store configuration d Press Menu/Enter button again to return to main menu 	
To recall state	<ol style="list-style-type: none"> a Press Save/Recall button b Scroll to the desired state to recall configuration (e.g. STATE 2) using the navigation keys c Press Recall State softkey to reinstate configuration a Press Menu/Enter button again to return to main menu 	

List of Default Values

Key Operation	Factory-shipped setting	Factory Default Key	Preset (*RST)	Backup	Save/Recall	Available means of defining a setting
Channel	All Lights ON [*]	<< [†]	<<	*	*	K/C [‡]
Attenuator Type	N/A	<<		*	*	K/C
Supply Voltage	+24V	<<		*	*	K/C
TTL	OFF	<<		*	*	K/C
Beep Volume	8	<<		*		K
GPIB Address	28	<<		*		K
IP Config	AUTO	<<		*		K
Manual IP Addr	"192.168.1.101"	<<		*		K
Manual Gateway	"0.0.0.0"	<<		*		K
Manual Subnet Mask	"255.255.255.0"	<<		*		K

* When channel light is ON, it means attenuation is being applied (when attenuator is connected) or switch path is open (when switch is connected)

† "<<" symbol shows that the setup is the same as that in the box to the left.

‡ K = Using front panel. C = Using SCPI command.

Definition

Factory Default All data that the user can set are cleared. Relay cycle count is not cleared.

Preset Status when you press Preset key

***RST** Status when you execute *RST in your program

Backup Settings that are backed up (set state not affected by turning power ON/OFF)

In the table, a setting that is automatically backed up is denoted in the following manner:

*: Backup operation performed

Blank: Backup operation not performed

Save/Recall Settings that permit Save/Recall of a setup state

In the table, states that can be saved/recalled are denoted in the following manner:

*: Save/Recall can be performed

Blank: Save/Recall cannot be performed



6 Remote Operations

Configuring Remote Interface	64
"Interface Selection	
"GPIB Configuration	
"USB Configuration	
"LAN Configuration	
Control over telnet server	66
Conversational control using telnet (using port 5024)	66
Control from a program (using port 5025)	68
Control using C or Visual Basic	69
Control using Agilent VEE	69
Control using Agilent I/O	70
Programming Guide (SCPI)	71
"SCPI Command Syntax	
"Rules for Using a Channel or Scan List	
"Commands Relevant to Attenuators	
"Commands Relevant to Switches	
Programming Guide (Legacy)	76
"Data Message Input Format	
SCPI and Legacy Commands Compatibility	77

This chapter provides the programming guide for 11713B/C in SCPI commands and legacy command.



Configuring Remote Interface

This section briefly describes how to configure the GPIB, USB and LAN remote interfaces.

NOTE

For more detailed information on remote interface connectivity configuration refer to the *Agilent Technologies USB/LAN/GPIB Interfaces Connectivity Guide*. If you have installed the IO Libraries Suite, you can access the Connectivity Guide via the Agilent IO Libraries Control icon. Alternatively, you can access the Connectivity Guide via the Web at www.agilent.com/find/connectivity.

Interface Selection

You can choose to control the 11713B/C remotely using the GPIB, USB or LAN interfaces.

For information on selecting and configuring the remote interface manually from the driver front panel or remotely via virtual front panel, refer to [Chapter 5](#), “Local Operations.

NOTE

It is expected that most users will use the front panel keys to set up the remote interfaces. The remote interface commands are provided for completeness (for front panel operation).

GPIB Configuration

Each device on the GPIB (IEEE-488) interface must have a unique address. You can set the 11713B/C's address to any value between 0 and 30. The attenuator/switch driver is shipped with a default address set to 28. The GPIB address is stored in non-volatile memory and does not change when the driver is switched off or after a remote interface reset.

For information on setting the GPIB address manually from the front panel, refer to [“Connecting Over GPIB”](#) on page 80.

USB Configuration

The USB interface requires no front panel or remote configuration. The USB cannot be changed - it is set at the factory and is unique for each 11713B/C.

NOTE

For further information on USB configuration, refer to [“Connecting Over USB”](#) on page 82.

NOTE

Before connecting the USB cable, make sure that I/O software is installed on your computer.

NOTE

For more information about *Agilent IO Libraries* software refer to the [Connectivity Guide](#). If you have installed other I/O software refer to documentation that accompanies the software.

LAN Configuration

The 11713B/C has three LAN operating modes:

- Dynamic mode (Dynamic Host Configuration Protocol or DHCP)
- Auto IP mode (Local PC Control or isolated LAN)
- Static mode (Manual mode)

Refer to [“Connecting Over LAN”](#) on page 83 to configure the above LAN operating modes.

Control over telnet server

In a control system that operates over the telnet server, communications are performed through connection between the sockets provided by the processes of the external controller and the 11713B/C to establish a network path between them.

A socket is an endpoint for network connection; port 5024 and port 5025 are provided for the sockets for the 11713B/C. Port 5024 is provided for conversational control using telnet (user interface program for the TELNET protocol) and port 5025 for control from a program.

Preparing the external controller

As in the case of the SICL-LAN server, you need to set the I/O interface for the external controller in advance to establish communication to the 11713B/C using the TCP/IP protocol.

Conversational control using telnet (using port 5024)

You can use telnet to perform conversational control by sending SCPI commands to the 11713B/C on a message-by-message basis. For telnet, the socket of port 5024 is used for communications.

NOTE

For port 5024, service requests are asynchronous. Also, use Ctrl+C to clear the device.

In this example, to show you the control procedure using telnet, in a Windows environment you control the 11713C (IP address: 141.183.220.172) from the external controller.

- 1 Open the MS-DOS command prompt screen.
- 2 At the MS-DOS prompt, type “telnet 141.183.220.172 5024” and press Enter.
- 3 The telnet screen opens.
- 4 Type a command and press Enter; it is sent to the 11713C and executed. If you enter a command that queries some data, the query response is displayed below the line in which you entered the command. Figure 6-1 shows the screen displaying 11713C control via telnet. Command used to open all channels on bank 1 and close channel 1 on bank 1. The setting check is made with the query after channel 1 on bank 1 is closed.

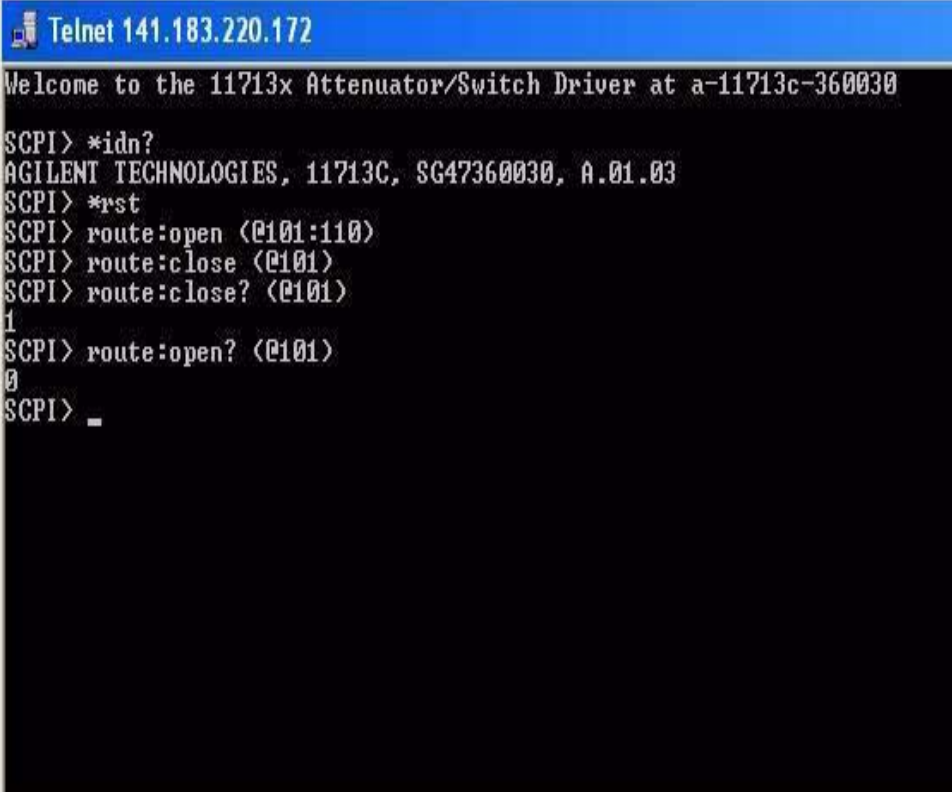

```
Telnet 141.183.220.172
Welcome to the 11713x Attenuator/Switch Driver at a-11713c-360030
SCPI> *idn?
AGILENT TECHNOLOGIES, 11713C, SG47360030, A.01.03
SCPI> *rst
SCPI> route:open (0101:110)
SCPI> route:close (0101)
SCPI> route:close? (0101)
1
SCPI> route:open? (0101)
0
SCPI> _
```

Figure 6-1 Example of control using telnet

- 5 Press] while holding down Ctrl in the telnet screen to break the connection to the 11713C. The telnet prompt appears. Type “quit” at the telnet prompt and press Enter to finish using telnet.

Control from a program (using port 5025)

When controlling the 11713B/C from a program on the external controller, use the socket of port 5025 for connection. Figure 6-2 shows example of control 11713C via a program.

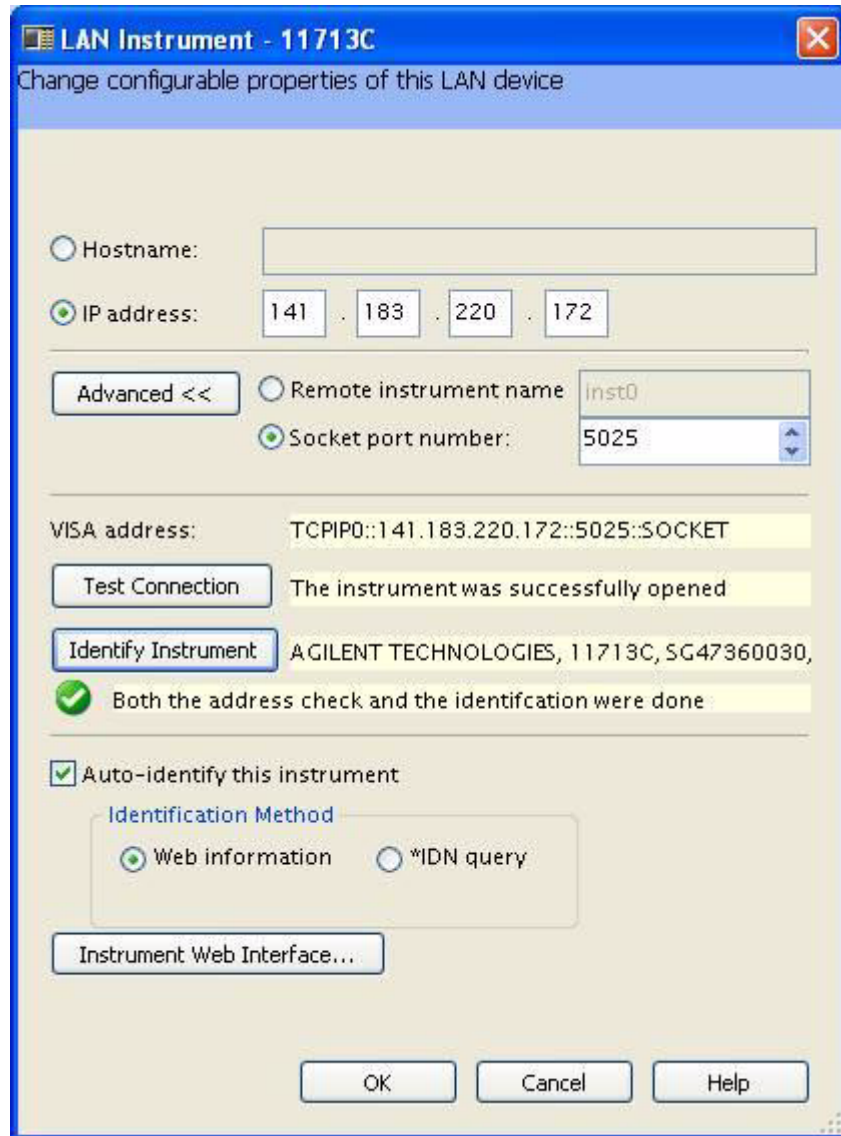

Figure 6-2 Example of control from a program

Control using C or Visual Basic

You can control the 11713B/C by socket programming using C language in a UNIX environment, or Visual C++ or Visual Basic in a Windows environment.

For socket programming, the library for network connection on TCP/IP protocol is required. For a UNIX environment, WinSock (WinSock1.1 and WinSock2.0), created by posting BSD Sockets to Windows and expanding it, is available.

Control using Agilent VEE

Agilent VEE allows you to control the 11713B/C through the connection to the socket of port 5025 using the To/From Socket. Figure 6-3 shows an example (when the IP address of the 11713C is 141.183.220.200). Enter "5025" in the field to specify the port of connection and enter IP address of the 11713C in the field to specify the host name.

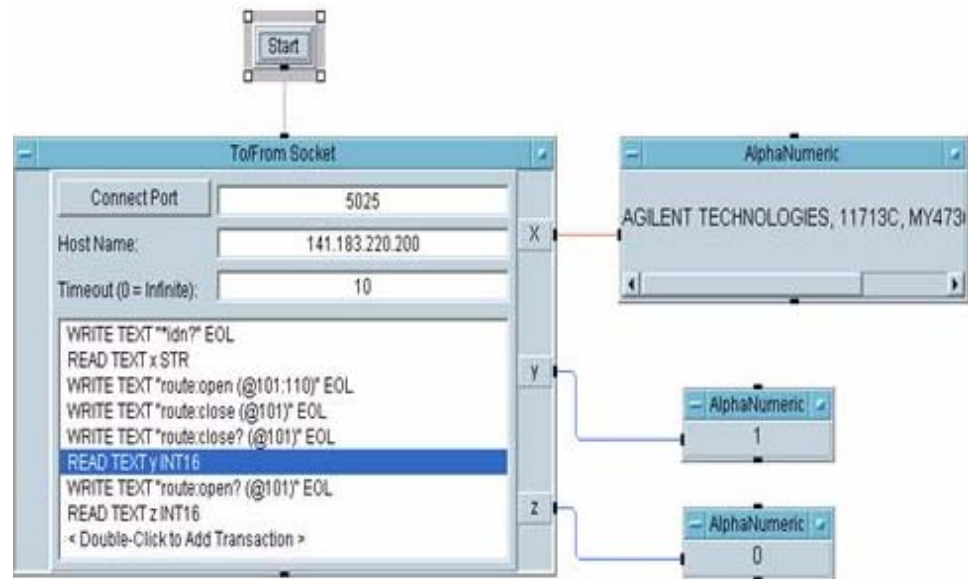

Figure 6-3 Example of control using Agilent VEE

Control using Agilent I/O

The Agilent I/O Libraries Suite is a collection of libraries that provides you the ability to use your instruments from a test and measurement program. Figure 6-4 shows an example of controlling via Agilent I/O (when the I/P address of 11713C is 141.183.220.172). Please ensure remote instrument name is check.

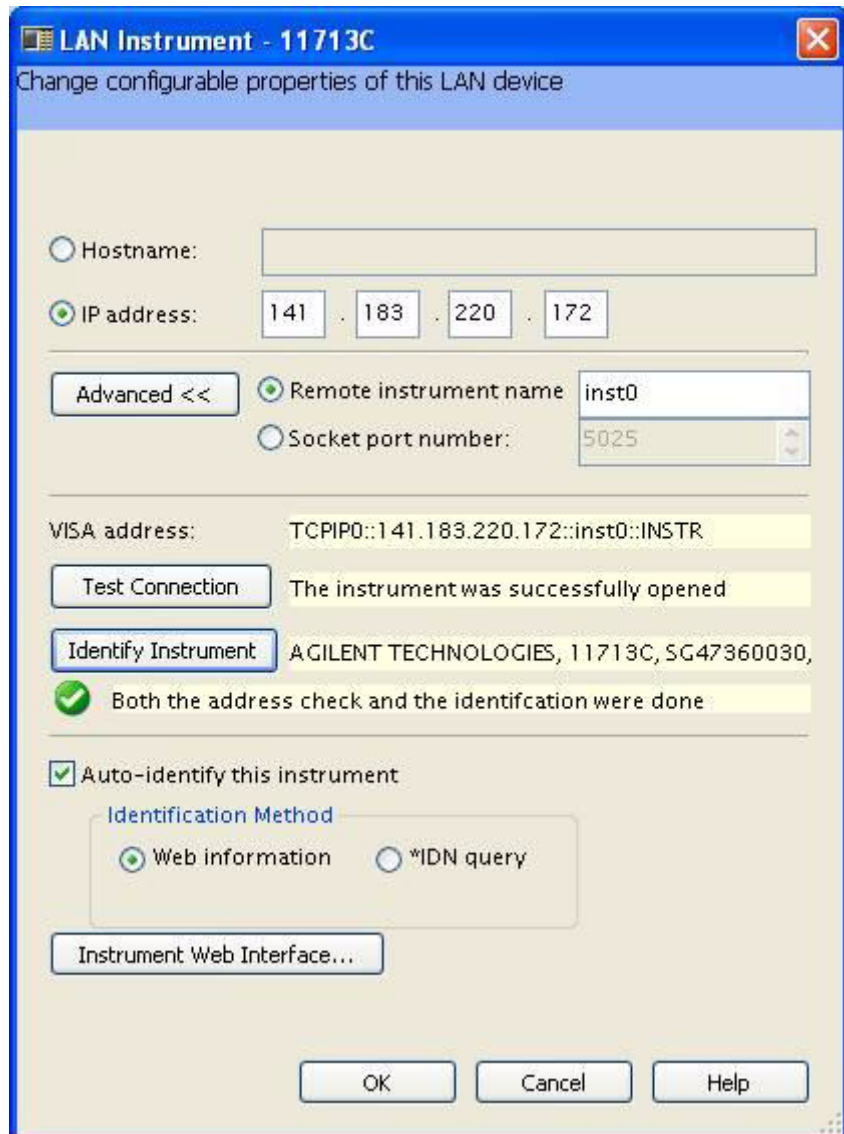

Figure 6-4 Example of control using Agilent I/O

Programming Guide (SCPI)

SCPI Command Syntax

The following conventions are used for SCPI command syntax for remote interface programming.

- Square brackets ([]) indicate optional keywords or parameters
- Braces ({}) enclose parameter choices within a command string
- Angle brackets (<>) enclose parameters for which you must specify a value
- A vertical bar (|) separates multiple parameters

Rules for Using a Channel or Scan List

Many of the SCPI commands include a channel list or scan list parameter which allows you to specify one or more channels. The channel number has the form (@*bnn*), where *b* is the bank number and *nn* is the channel number.

Channel list is from 101 to 110 for bank 1 and 201 to 210 for bank 2.

NOTE

11713B has only one bank. Therefore, by default, *b* = 1.

You can specify a bank, a single channel, multiple channels or a range of channels as describe below.

- The following command closes a single channel (channel 4) on bank 1:

```
ROUTE:CLOSE (@104)
```

- The following command closes multiple channels on modules in banks 1 and 2:

```
ROUTE:CLOSE (@104,107, 201, 206)
```

- The following command closes a range of channels. When you specify a range of channels, the range may contain invalid channels (they are ignored), but the first and last channel in the list must be valid:

```
ROUTE:CLOSE (@101:109)
```

Commands Relevant to Attenuators

To Configure Attenuator Type

The commands below set the attenuator type (model number) for corresponding attenuators.

- :CONFigure:[BANK1]:X
{NA|AG8494g|AG8495g|AG8495k|AG8496g|AG8497k|AG84904k|AG84905m|AG84906k|AG84907k|AG84908m}
- :CONFigure:[BANK1]:Y
{NA|AG8494g|AG8495g|AG8495k|AG8496g|AG8497k|AG84904k|AG84905m|AG84906k|AG84907k|AG84908m}
- :CONFigure:BANK2:X
{NA|AG8494g|AG8495g|AG8495k|AG8496g|AG8497k|AG84904k|AG84905m|AG84906k|AG84907k|AG84908m}
- :CONFigure:BANK2:Y
{NA|AG8494g|AG8495g|AG8495k|AG8496g|AG8497k|AG84904k|AG84905m|AG84906k|AG84907k|AG84908m}

NOTE

For AG849xh, use AG849xg. For AG84904l/m, use AG84904k. For 84906l, use AG84906k. For AG84907l, use AG849907k.

To Set Attenuation Level

The commands below are used to set the attenuation level of corresponding attenuator(s).

- ATTenuator:[BANK1]:X <attenuation value in dB>
- ATTenuator:[BANK1]:Y <attenuation value in dB>
- ATTenuator:BANK2:X <attenuation value in dB>
- ATTenuator:BANK2:Y <attenuation value in dB>

To Query Attenuation Level

The commands below return the current attenuation value for corresponding attenuator(s).

- ATTenuator:[BANK1]:X?
- ATTenuator:[BANK1]:Y?
- ATTenuator:BANK2:X?
- ATTenuator:BANK2:Y?

To Set Supply Voltage

The commands below set the supply voltage for each bank.

- CONFigure:Bank1 {OFF|P5v|P15v|P24v|USER}
- CONFigure:Bank2 {OFF|P5v|P15v|P24v|USER}

To Query Supply Voltage

The commands below query the supply voltage set for each bank.
Value to be returned: OFF, P5, P15, P24 or USER.

- CONFigure:Bank1?
- CONFigure:Bank2?

To Query Number of Relay Cycles

The command below query the number of relay cycles for each channel. Value to be returned: number of cycles.

- DIAGnostic:RELAy:CYCles? <channel list>

To Clear Relay Cycles

The commands below clear relay cycle for selected or all channels.

- DIAGnostic:RELAy:CLEAr <channel list>
- DIAGnostic:RELAy:CLEAr:ALL

Commands Relevant to Switches

To Open/Close Switch

The commands below close/open switching path(s).

- [:ROUte]:CLOSE <channel list>
- [:ROUte]:OPEN <channel list>
- [:ROUte]:CLOSE:ALL
- [:ROUte]:OPEN:ALL

To Query Switch Status

The commands below query the status of switching path(s). Value to be returned: “1” if true and “0” if false.

- [:ROUte]:CLOSE? <channel list>
- [:ROUte]:OPEN? <channel list>

To Set Supply Voltage

The commands below set the supply voltage for each bank.

- CONFigure:BaNK1 {OFF|P5v|P15v|P24v|USER}
- CONFigure:BaNK2 {OFF|P5v|P15v|P24v|USER}

To Query Supply Voltage

The commands below query the supply voltage set for each bank. Value to be returned: OFF, P5, P15, P24 or USER.

- CONFigure:BaNK1?
- CONFigure:BaNK2?

To Set TTL ON/OFF

The commands below set TTL ON/OFF for each bank.

- CONFigure:BaNK1:TTL {OFF|ON}
- CONFigure:BaNK2:TTL {OFF|ON}

To Query TTL status

The commands below query the supply voltage status for each bank. Value to be returned: “1” if true and “0” if false.

- CONFigure:BaNK1:TTL?
- CONFigure:BaNK2:TTL?

To Query Number of Relay Cycles

The command below query the number of relay cycles for each channel. Value to be returned: number of cycles.

- DIAGnostic:RELAy:CYCLes? <channel list>

To Clear Relay Cycles

The commands below clear relay cycle for selected or all channels.

- DIAGnostic:RELAy:CLEAr <channel list>
- DIAGnostic:RELAy:CLEAr:ALL

Programming Guide (Legacy)

Data Message Input Format

NOTE

Legacy commands cannot be utilize to control Bank 2 of 11713C.

The programming data string for the driver consists of a string of ASCII coded characters composed of one or both of the following fields:

[Adm] [Bdn]

where: A or a = general ON command; B or b = general OFF command

dm = any digits 0 through 9 (excluding dn)

dn = any digits 0 through 9 (excluding dm)

The driver responds to an alphanumeric data string such as "A12B34" when the driver is in the remote state and addressed to listen.

NOTE

The alpha characters in the data string can be either upper or lower case.

NOTE

The maximum number of character in a data string is 12.

The data string is further defiined as follows:

- Ax Bx = data string for ATTEN X (x can be none, one or more of digits 1, 2, 3 or 4)
- Ay By = data string for ATTEN Y (y can be none, one or more of digits 5, 6, 7 or 8)

NOTE

If Ax (Ay) uses a digit, then that digit may not be used in Bx (By).

- A/B 9 = legacy command for switch S9
- A/B 0 = legacy command for swtich S0

SCPI and Legacy Commands Compatibility

Front Panel		Rear Panel Connector	Connector Pin Number	Command Result	
Pushbutton Number	Pushbutton LED*			(Legacy) A (SCPI) [:ROUte]:CLOSe: <channel list>	(Legacy) B (SCPI) [:ROUte]:OPEn: <channel list>
1	ON	ATTEN X	5	H	L
	OFF		6	L	H
2	ON		7	H	L
	OFF		8	L	H
3	ON		9	H	L
	OFF		10	L	H
4	ON		11	H	L
	OFF		12	L	H
5	ON	ATTEN Y	5	H	L
	OFF		6	L	H
6	ON		7	H	L
	OFF		8	L	H
7	ON		9	H	L
	OFF		10	L	H
8	ON		11	H	L
	OFF		12	L	H
9	ON	S9	A (3)		+Vcc
	OFF			G	
	ON		B (4)	+Vcc	
	OFF				G
0	ON	S0	A (3)		+Vcc
	OFF			G	
	ON		B (4)	+Vcc	
	OFF				G

* Note:

LED lights on = attenuation applied (for attenuators)/switching path opened (for switches).

LED lights off = no attenuation (for attenuators)/switching path closed.

Legends

H = Open (Low)

L = Closed (High)

G = Connected to ground

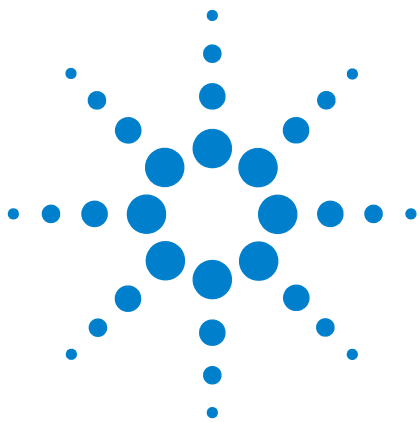

7 Remote Interface Configurations

Connecting the 11713B/C to Your Computer 80

“Connecting Over GPIB

“Connecting Over USB

“Connecting Over LAN

Exploring the 11713B/C Web Interface Over LAN 89

“Launching the Web Interface

“Displaying the Browser Web Control Page

This chapter provides you information and steps to achieve remote operations of Agilent 11713B/C attenuator/switch drivers via GPIB, USB and LAN. You will also be introduced to 11713B/C web interface over LAN.



Connecting the 11713B/C to Your Computer

NOTE

To easily connect the 11713B/C to your PC, configure and verify your connection, you can use the Agilent IO Library Suite, the E2094M Agilent IO Libraries for Windows, or an equivalent.

- Agilent IO Libraries Suite for Windows 98/2000/ME/XP. For information and to install, use the *Automation Ready CD with the Agilent IO Libraries Suite*, which is shipped with the 11713B/C.
- E2094M Agilent IO Libraries Suite for Windows 98/NT/2000/ME/XP. You can find information and install this application via the Web at www.agilent.com/find/iolib.
- You can also access other information about Agilent IO Libraries at www.agilent.com/find/iolib.

NOTE

The procedures in this section refer to the *Agilent Technologies USB/LAN/GPIB Interfaces Connectivity Guide*. If you have installed the IO Libraries Suite, you can access the Connectivity Guide via the Agilent IO Libraries Control icon. Or, you can access the Connectivity Guide via the Web at www.agilent.com/find/connectivity.

Connecting Over GPIB

- 1 Make sure you have installed the required I/O software on your computer.
- 2 Follow the instructions included with your GPIB interface card to install the GPIB hardware in your computer.
- 3 Connect the GPIB cable (not provided) between the computer and the 11713B/C.
- 4 Make sure power is applied to your computer and verify that the operating system is fully booted. Then apply power to 11713B/C.
- 5 Configure your GPIB hardware as instructed by the documentation provided by the hardware vendor.
- 6 Use the *Connection Expert* utility of the Agilent IO Libraries Suite to add the 11713B/C and verify a connection.

NOTE

If you have installed any other I/O software, refer to documentation included with that software.

- 7 The 11713B/C is shipped from the factory with a default GPIB address of **28**. To change the address, refer to table below:

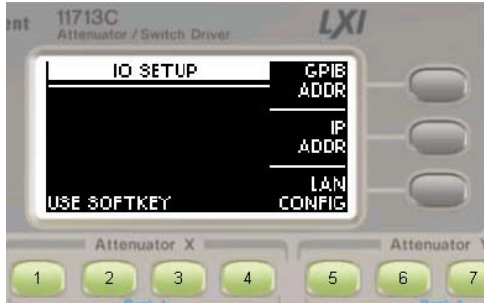
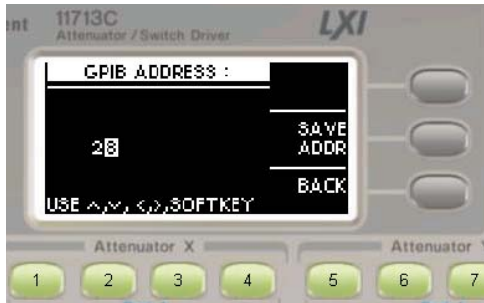
Step	Action	Illustration
1	<p>Changing GPIB address (integer between 0 to 30)</p> <p>a At IO SETUP screen, press GPIB ADDR softkey</p> <p>b Current GPIB address is display on screen (default address is 28)</p> <p>c Use navigation key to change value</p> <p>d Press SAVE ADDR to save and GPIB ADDR SAVED is displayed at the bottom of LCD</p> <p>e Press BACK soffkey to return to IO SETUP</p>	 

- 8** Now you can use various programming environments to control the 11713B/C. For an overview on programming instruments via GPIB, refer to the *Connectivity Guide*.

Connecting Over USB

The USB interface requires no front panel configuration.

NOTE

Before connecting the USB cable, make sure that I/O software is installed on your computer. See “[Connecting the 11713B/C to Your Computer](#)” on page 80 for more information on installing the Agilent IO Libraries software.

- 1 After I/O software is installed on your computer, connect a 11713B/C to your computer using a Type Mini-B 5 pin USB cable.
- 2 Make sure power is applied to your computer and verify that the operating system is fully booted. Then apply power to the 11713B/C.
- 3 The *Found New Hardware Wizard* will automatically start and guide you through configuring the 11713B/C as a USB device. To install the software automatically, accept all defaults.

NOTE

If you have installed the Agilent I/O Libraries Software, this also install the required low-level software drivers. Therefore you do not need to insert the CD when the Found New Hardware Wizard instructs you to do so.

NOTE

If you have installed any other I/O interface software, refer to documentation included in that software.

- 4 Use the *Connectivity Expert* utility of the Agilent I/O Libraries Suite to verify that the 11713B/C is displayed under the USB interface.
- 5 Now you can use various programming environments to control the 11713B/C. For an overview on programming instructions via USB, refer to the *Connectivity Guide*.

Connecting Over LAN

The 11713B/C has two LAN operating modes:

- Auto mode
- Manual mode

Selecting the LAN Network Type

You can connect and configure your 11713B/C for Site LAN or isolated (non-site) LAN operation.

- A *Site LAN* network is defined as a local area network (LAN) in which computers and LAN-enabled instruments are connected to a site LAN (workgroup LAN, Intranet, or enterprise LAN) via optional routers, hubs, and/or switches.
- An *Isolated LAN* network is defined as a local area network (LAN) in which computers and LAN-enabled instruments are not connected to a site LAN.

Auto Mode

This mode is used when you are connecting 11713B/C via site LAN. In auto mode, the IP Address, Subnet Mask, and Default Gateway values are obtained from the DHCP server or automatically assigned and the values cannot be configured from the front panel.

To prepare 11713B/C for auto mode,

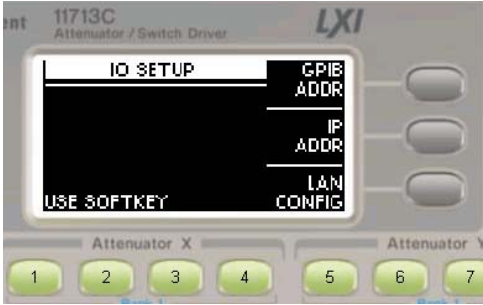
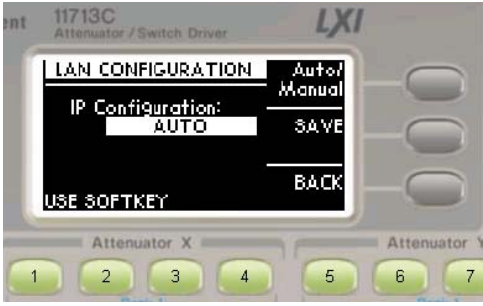
Step	Action	Illustration
1	<p>Ensure your computer and 11713B/C are turned on and connected to LAN</p> <ol style="list-style-type: none"> Connect your computer and 11713B/C to LAN outlets using standard LAN cable Make sure power is applied to your computer and verify that the operating system is fully booted Apply power to 11713B/C and background LED color turns red, indicating standby mode. Allow 11713B/C to warm up for 15 seconds, then press the ON button (LED turn from red to green) 	
2	<p>Verify 11713B/C LAN configuration is ready for auto mode</p> <ol style="list-style-type: none"> Press Menu/Enter button on the front panel of 11713B/C Select IO using navigation keys and press Menu/Enter At IO SETUP screen, press LAN CONFIG softkey At LAN CONFIGURATION screen, ensure IP Configuration is AUTO If needed, press Auto/Manual softkey until AUTO is displayed and SAVE Press BACK softkey to go back to IO SETUP screen 	 

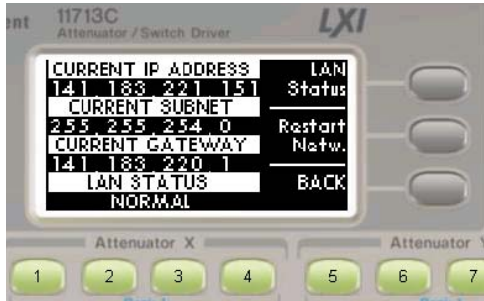
Step	Action	Illustration
3	<p>Verify LAN status on 11713B/C</p> <p>a At IO SETUP screen, select IP ADDR softkey</p> <p>b At IP ADDRESS screen, select LAN STAT softkey</p> <p>c Verify values CURRENT IP ADDRESS, CURRENT SUBNET and CURRENT GATEWAY are valid</p> <p>d Ensure LAN STATUS is NORMAL</p> <p>e If LAN STATUS is FAULT, check your LAN connection and then press Restart Netw softkey and wait</p> <p>f Press BACK softkey to go back to IP ADDRESS screen</p>	 

Now you can use the 11713B/C Web Browser Interface to access and control the instrument. See [“Exploring the 11713B/C Web Interface Over LAN”](#) on page 89.

If you plan to program the instrument over LAN or use such programs, make sure you have installed the required I/O software on your computer.

Use the *Connectivity Expert* utility of the Agilent IO Libraries Suite to add the 11713B/C and verify a connection. When identifying the instrument, it is easiest if you use the IP address noted in step 3 above.

NOTE

If you have installed any other I/O software, refer to documentation included with that software.

Now you can use various programming environments to control the 11713B/C. For an overview on programming instructions via USB, refer to the *Connectivity Guide*.

Manual Mode

In a manual mode, you must set up the IP Address, Subnet Mask and Default Gateway that is compatible with your network infrastructure. If it is not correctly setup, 11713B/C will not be visible on your network.

To prepare 11713B/C for manual mode,

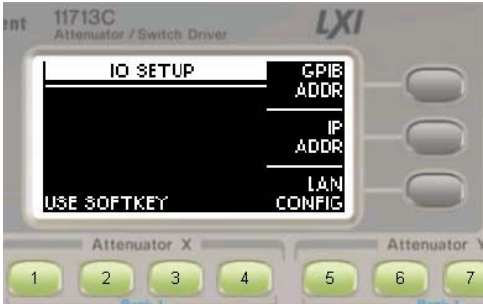
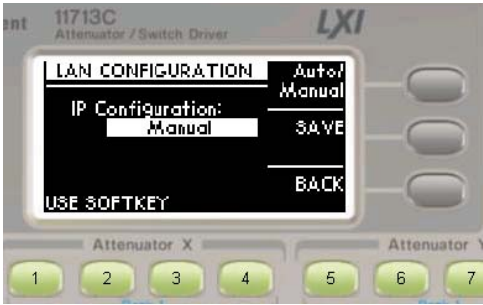
Step	Action	Illustration
1	<p>Ensure your computer is connected to 11713B/C and turned on.</p> <ol style="list-style-type: none"> Connect your computer to 11713B/C using CAT5 crossover cable Make sure power is applied to your computer and verify that the operating system is fully booted Apply power to 11713B/C and background LED color turns red, indicating standby mode. Allow 11713B/C to warm up for 15 seconds, then press the ON button (LED turn from red to green) 	
2	<p>Verify 11713B/C LAN configuration is ready for manual mode</p> <ol style="list-style-type: none"> Press Menu/Enter button on the front panel of 11713B/C Select IO using navigation keys and press Menu/Enter At IO SETUP screen, press LAN CONFIG softkey At LAN CONFIGURATION screen, ensure IP Configuration is Manual If needed, press Auto/Manual softkey until Manual is displayed and SAVE Press BACK softkey to go back to IO SETUP screen 	 

Step	Action	Illustration
<p>3 Manually enter IP ADDRESS, SUBNET and GATEWAY</p>	<p>a At IO SETUP screen, press IP ADDR softkey</p> <p>b At IP ADDRESS screen, press MANUAL IP softkey</p> <p>c At MANUAL IP ADDRESS screen, enter IP ADDRESS, SUBNET and GATEWAY (scroll using NEXT ITEM softkey)</p> <p>d Then SAVE.</p> <p>e Press BACK softkey to go back to IP ADDRESS screen</p>	
<p>4 Verify LAN status on 11713B/C.</p>	<p>a At IO SETUP screen, select IP ADDR softkey</p> <p>b At IP ADDRESS screen, select LAN STAT softkey</p> <p>c Verify values CURRENT IP ADDRESS, CURRENT SUBNET and CURRENT GATEWAY are valid</p> <p>d Ensure LAN STATUS is NORMAL</p> <p>e If LAN STATUS is FAULT, check your LAN connection and then press Restart Netw softkey and wait</p> <p>f Press BACK softkey to go back to IP ADDRESS screen</p>	

Now you can use the 11713B/C Web Browser Interface to access and control the instrument. See [“Exploring the 11713B/C Web Interface Over LAN”](#) on page 89.

If you plan to program the instrument over LAN or use such programs, make sure you have installed the required I/O software on your computer.

Use the *Connectivity Expert* utility of the Agilent IO Libraries Suite to add the 11713B/C and verify a connection. When identifying the instrument, it is easiest if you use the IP address noted in step 3 above.

NOTE

If you have installed any other I/O software, refer to documentation included with that software.

Now you can use various programming environments to control the 11713B/C. For an overview on programming instructions via USB, refer to the *Connectivity Guide*.

Exploring the 11713B/C Web Interface Over LAN

You can use the 11713B/C's Web Browser Interface for remote access and control of the instrument via a Java™-enabled Web browser, such as Microsoft® Internet Explorer. Using the Web Interface, you can configure, troubleshoot and monitor your system remotely. This section provides an overview of the 11713B/C Web Interface.

NOTE

The following tasks assume you have configured the 11713B/C for LAN communication and have verified connection to a LAN network. See "[Connecting Over LAN](#)" on page 83 for more information.

Launching the Web Interface

- 1 Open your Internet browser from your computer
- 2 From the **Tools>Internet Options** menu, navigate to **Connections** (exact navigation depends on your browser), and then select **LAN Settings**
- 3 From the LAN Settings dialog, select/activate bypass proxy server for local addresses (exact terminology depends on your browser)
- 4 Exit the Options window
- 5 Enter the IP address of the 11713B/C in the Address field and press return. Use the 11713B/C's front panel utility menu to read the IP address
- 6 After entering the appropriate IP address, the 11713B/C Web Interface's Welcome Window should appear

NOTE

The procedure in this section will help you understand tasks commonly performed using the 11713B/C Web Interface. For additional help on using the interface, click the **?Help with the Page** tab on the lower-left corner of the Web Interface window.

7 Remote Interface Configurations

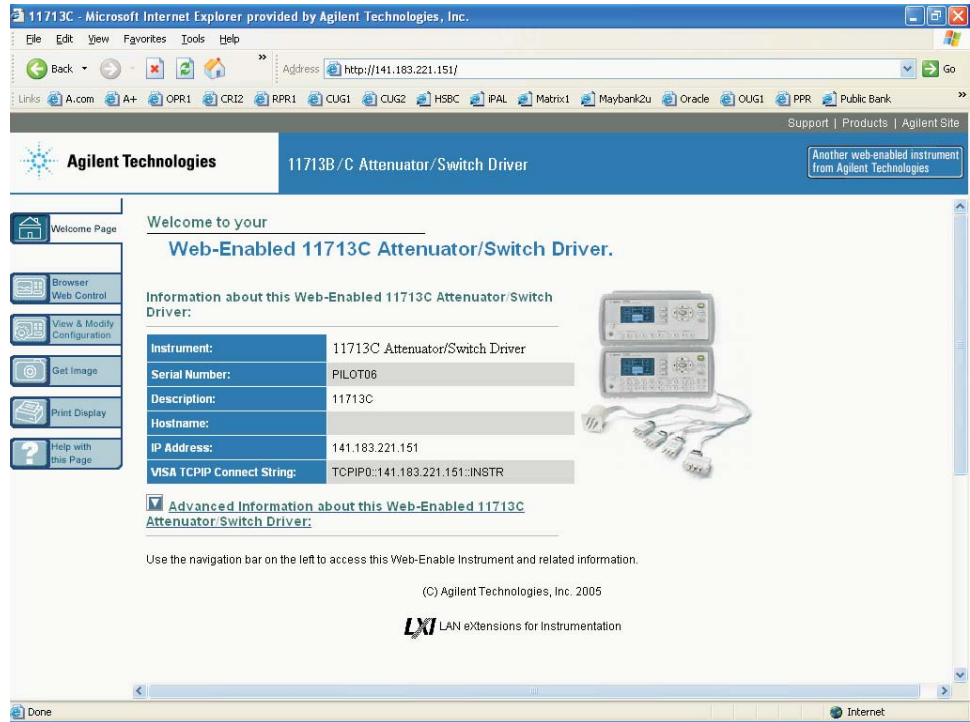

Figure 1 11713B/C Web Interface's Welcome Window

Navigation Bar



Welcome page Display various setting information

Browser Web Control Virtual front panel and sending/reading SCPI commands

View & Modify Configuration Displays and modifies various setting information

Get Image Receives image

Print Display Calls the printing function of the browser

Help with this Page Displays the Help file

Displaying the Browser Web Control Page

- 1 From the Welcome Window, click the **Browser Web Control** tab on the left side of the window
- 2 You will notice a pop-up window, requesting for password
- 3 Enter password (default password is “agilent”) and click submit



- 4 You can view the virtual front panel of 11713B/C
- 5 Now, you can control the switching devices remotely, similar to the front panel of the actual instrument

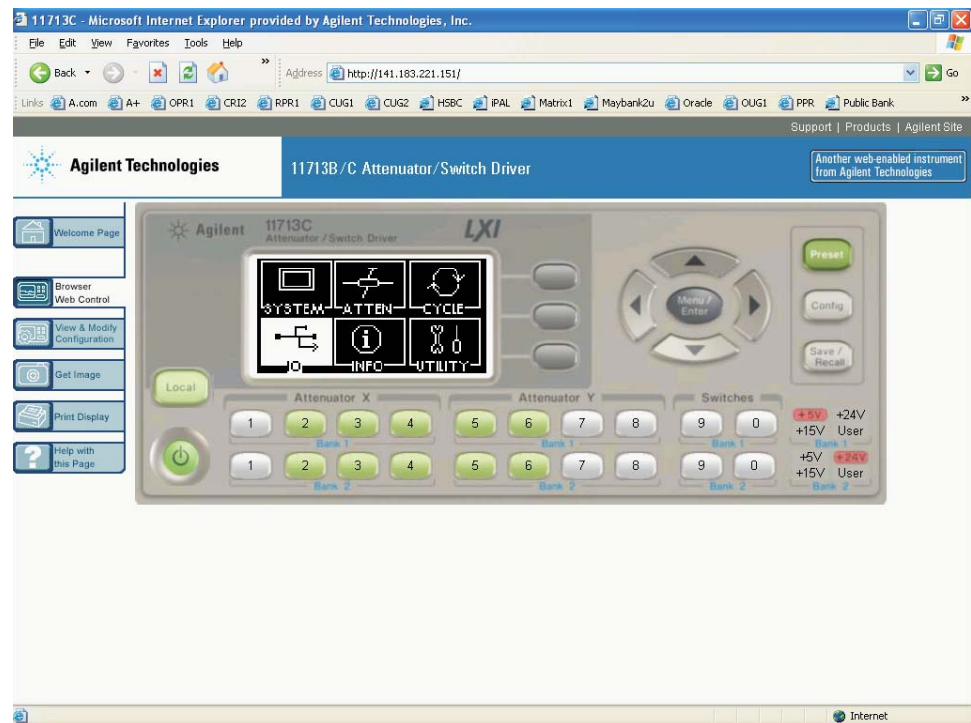
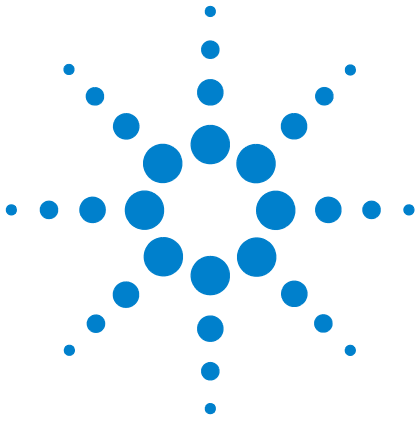

Figure 2 11713B/C Browser Web Control Interface

7 Remote Interface Configurations



8 Servicing the Attenuator/Switch Driver

Preparing a Static-Safe Workstation 94

“Reducing ESD Damage

Maintenance and Adjustments 96

“Fuse Removal/Replacement

“Adjustment

In this chapter, you will procedures for removal and replacement of major assemblies in 11713B/C and list of replaceable parts.



Preparing a Static-Safe Workstation

Electrostatic discharge (ESD) can damage or destroy electronic components. All works performed on assemblies consisting of electronic components should be done at a static-safe workstation.

An example of a static-safe workstation is shown below using two types of ESD protection:

- conductive table mat and wrist strap combination, and
- conductive floor mat and heel strap combination

The methods may be used together or separately. A list of static-safe accessories and their part numbers is given in table below.

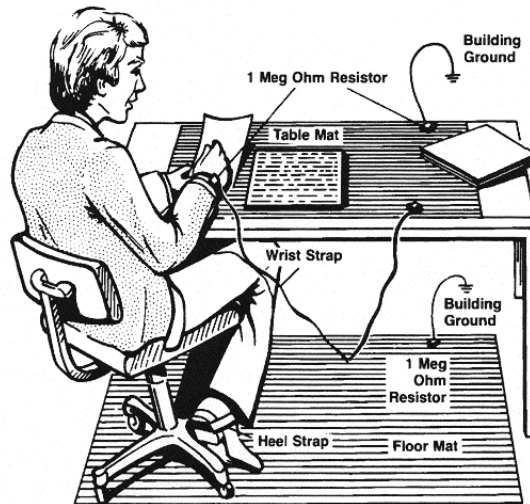

Agilent Part Number	Description
9300-0797	Set includes: <ul style="list-style-type: none"> • 3M static control mat 0.6 m x 1.2 m (2 ft x 4 ft) • 4.6 m x (115 ft) ground wire The wrist-strap and wrist-strap cord are no included. They must be ordered separately.
9300-0865	Ground-wire, 4.6 m (15 ft)
9300-0980	Wrist-strap cord, 1.5 m (5 ft)
9300-1367	Wrist-strap, color black, stainless steel, without cord, has four adjustable links and a 7 mm post-type connection.
9300-1308	ESD heel-strap (reusable 6 to 12 months)

The above can be ordered by contacting any Agilent Sales Office.

Reducing ESD Damage

To help reduce the amount of ESD damage that occurs during installation, testing, or servicing instruments use the following guidelines:

- Be sure that all instruments are properly earth-grounded to prevent buildup of static charge.
- Personnel should be grounded with a resistor-isolated wrist-strap before touching the center pin of any connector and before removing any assembly from the instrument.
- Before connecting any coaxial cable to an instrument connector for the first time each day, momentarily ground the center and outer conductor of the cable.
- Handle all PC board assemblies and electronic components only at static-safe workstations.
- Store or transport PC board assemblies and electronics components only in static-shielding containers.
- PC board assembly edge-connector contacts may be cleaned by using a lintfree cloth with a solution of 80% electronics-grade isopropyl alcohol and 20% deionized water. This should be performed at a static-safe workstation.

Maintenance and Adjustments

Fuse Removal/Replacement

User maintenance is limited to replacement of the rear panel fuse. The main ac line fuse is located on the rear panel in the line power module. *Please ensure that the fuse is 250V, T3.15A.*

Use the following procedure to replace fuse.

- 1 Remove fuse holder using a tweezer.
- 2 You will see two fuses - the one on the left is the active fuse and the other is backup.



- 3 Remove fuse and replace with one of the correct rating and type for your selected input ac line voltage.

NOTE

Be sure to select the correct fuse rating for the selected line voltage. Do not use repaired fuses or short circuited fuse-holders. To do so could cause a shock or fire hazard.

Adjustment

The 11713B/C attenuator/switch driver has no internal electrical or mechanical adjustments.