

Errata

Title & Document Type: 1411A Sampling Vertical Amplifier Operating and Service Manual

Manual Part Number: 01411-90902

Revision Date: August 1968

About this Manual

We've added this manual to the Agilent website in an effort to help you support your product. This manual provides the best information we could find. It may be incomplete or contain dated information, and the scan quality may not be ideal. If we find a better copy in the future, we will add it to the Agilent website.

HP References in this Manual

This manual may contain references to HP or Hewlett-Packard. Please note that Hewlett-Packard's former test and measurement, life sciences, and chemical analysis businesses are now part of Agilent Technologies. The HP XXXX referred to in this document is now the Agilent XXXX. For example, model number HP8648A is now model number Agilent 8648A. We have made no changes to this manual copy.

Support for Your Product

Agilent no longer sells or supports this product. You will find any other available product information on the Agilent Test & Measurement website:

www.agilent.com

Search for the model number of this product, and the resulting product page will guide you to any available information. Our service centers may be able to perform calibration if no repair parts are needed, but no other support from Agilent is available.

OPERATING AND SERVICE MANUAL

**SAMPLING
VERTICAL
AMPLIFIER
1411A**

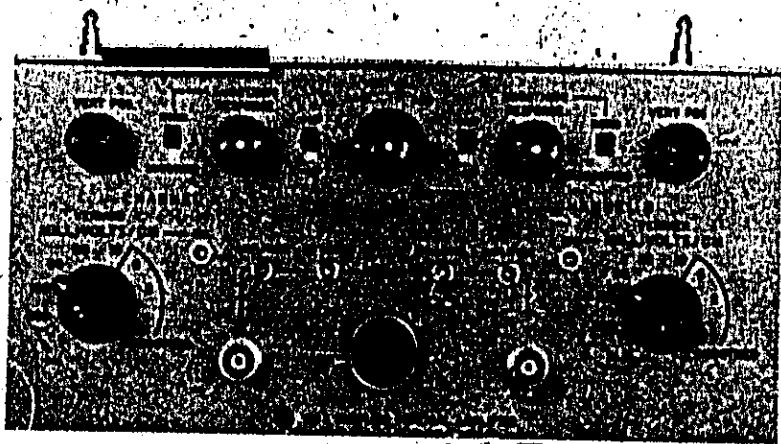

HEWLETT  PACKARD

CERTIFICATION

The Hewlett-Packard Company certifies that this instrument was thoroughly tested and inspected and found to meet its published specifications when it was shipped from the factory. The Hewlett-Packard Company further certifies that its calibration measurements are traceable to the U.S. National Bureau of Standards to the extent allowed by the Bureau's calibration facility.

WARRANTY AND ASSISTANCE

All Hewlett-Packard products are warranted against defects in materials and workmanship. This warranty applies for one year from the date of delivery, or, in the case of certain major components listed in the operating manual, for the specified period. We will repair or replace products which prove to be defective during the warranty period provided they are returned to Hewlett-Packard. No other warranty is expressed or implied. We are not liable for consequential damages.

Service contracts or customer assistance agreements are available for Hewlett-Packard products that require maintenance and repair on-site.

For any assistance, contact your nearest Hewlett-Packard Sales and Service Office. Addresses are provided at the back of this manual.

hp MANUAL CHANGES

MODEL 1411A

SAMPLING VERTICAL AMPLIFIER

Manual Serials Prefixed: 749-
Manual Printed: AUG 1968

Make all changes in this manual according to the Errata below. Also check the following table for your instrument serial prefix (3 digits) and/or serial number (8 digits) and make any listed change(s) in the manual:

Serial Prefix or Number	Make Manual Changes	Serial Prefix or Number	Make Manual Changes
851-	1		

ERRATA

△ Throughout this manual, measurements and adjustments are often made to derive indications of value per centimeter of display. When this unit is used with an oscilloscope where the divisions on the CRT are in other than centimeters, selections are per CRT division.

△ In certain places throughout this manual, a 10-centimeter vertical display is specified for some adjustments. When using this plug-in with oscilloscopes having CRT grid heights less than 10 divisions, select a reduced vertical sensitivity to derive the full display specified.

Page 6-5, Table 6-2.

Add: Q515, HP Part No. 1853-0020, Q: si pnp.

CHANGE 1

Table 6-2.

R203, R403: Change to HP Part No. 2100-2488; R: var comp 10k ohms ±20%.

R202, R402: Change to HP Part No. 2100-2823; R: var 50k ohms 10 cc log w/detent.

Delete: R201, R401; R: factory selected value.

Figures 8-9 and 8-12,

Change schematic. See Figure 1.

14 MAY 1969

Supplement A for
01411-90902

△ = Indicates latest addition to this change sheet.

Instrument Serial Prefix	Make Manual Changes
851-	1

Instrument Serial Prefix	Make Manual Changes

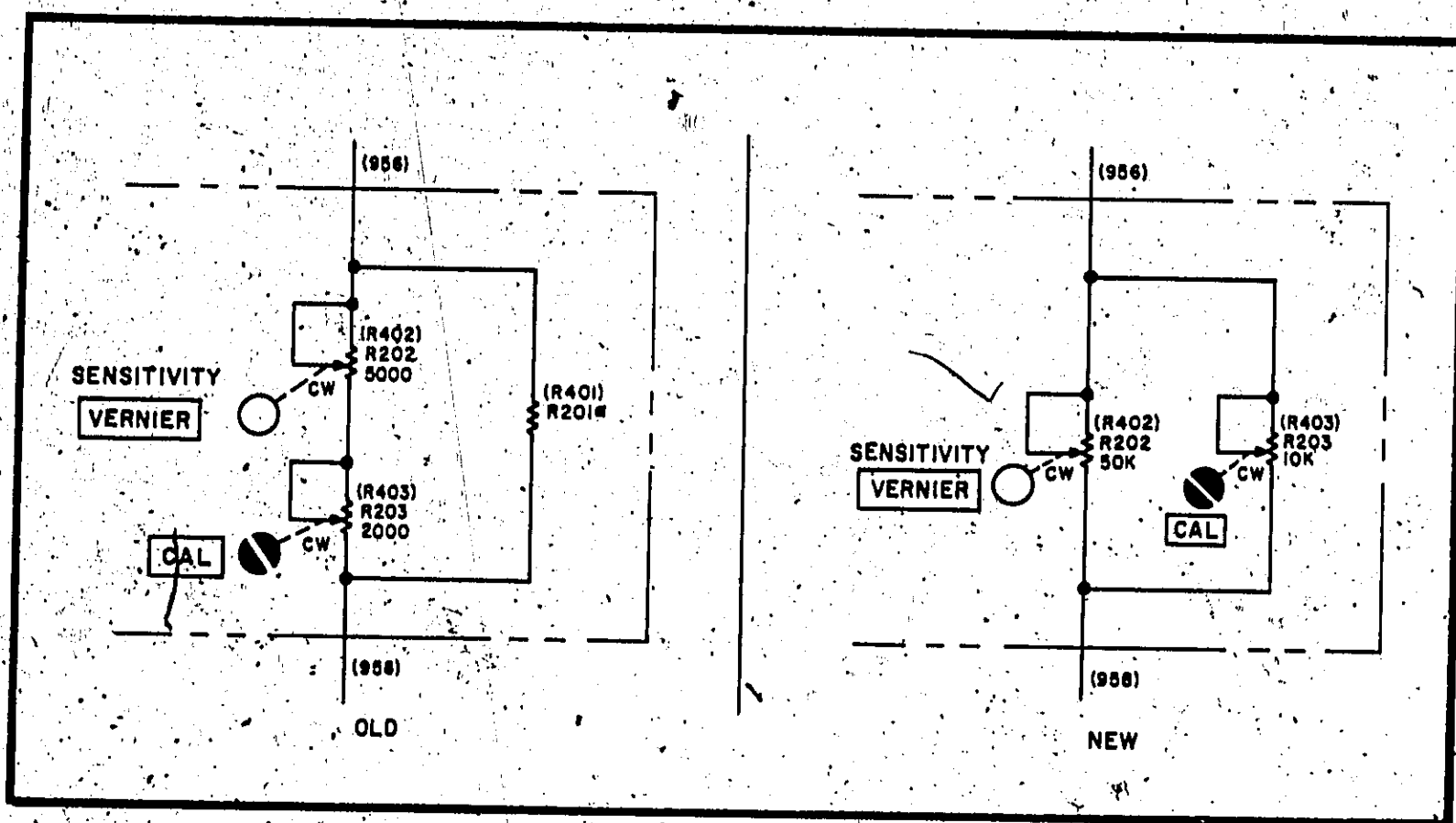

FIGURE 1

14 MAY 1969



OPERATING AND SERVICE MANUAL

MODEL 1411A
SAMPLING VERTICAL AMPLIFIER

SERIALS PREFIXED: 749-

See Section VIII For Instruments With Other Serial Prefixes

Two cutout overlays are provided inside the rear cover of the manual. These cutouts permit direct readout of ρ/cm (reflection coefficient) when a Model 1411A and 1430-series Sampler are used for TDR applications. Instructions are included on the overlay envelope.

Copyright HEWLETT-PACKARD COMPANY/COLORADO SPRINGS DIVISION 1967
1900 GARDEN OF THE GODS ROAD, COLORADO SPRINGS, COLORADO, U. S. A.

TABLE OF CONTENTS

Section	Page	Section	Page
I GENERAL INFORMATION	1-1	V PERFORMANCE CHECK AND	
1-1. Scope of Manual	1-1	ADJUSTMENTS	5-1
1-3. Description	1-1	5-1. Introduction	5-1
1-9. Manual Identification	1-1	5-3. Performance Check	5-1
II INSTALLATION	2-1	5-4. Test Equipment Required	5-1
2-1. Initial Inspection	2-1	5-6. Procedures	5-1
2-4. Preparation for Use	2-1	5-8. Power Supply Voltages	5-1
2-7. Claims	2-1	5-11. Modes of Operation	5-2
2-9. Repackaging for Shipment	2-1	5-12. Attenuator Accuracy	5-2
III OPERATION	3-1	5-13. Vernier	5-2
3-1. Introduction	3-1	5-14. Noise	5-2
3-4. Front Panel Controls	3-1	5-15. Recorder Outputs	5-3
3-14. Modes of Operation	3-1	5-16. Adjustments	5-3
3-21. Sampling Efficiency	3-2	5-18. +12.6V Supply	5-3
3-22. Definition	3-2	5-20. Stretcher Pulse Width Adjust	5-3
3-26. Optimizing Sampling Efficiency	3-2	5-21. Stretcher Gain and Balance	5-3
3-31. Operating Procedures	3-3	5-22. Vertical Balance	5-3
IV PRINCIPLES OF OPERATION	4-1	5-23. Frequency Response	5-3
4-1. Introduction	4-1	5-24. Sensitivity Calibration	5-4
4-3. General Theory	4-1	VI REPLACEABLE PARTS	6-1
4-6. Vertical Sampling	4-1	6-1. Introduction	6-1
4-9. Horizontal Sampling	4-1	6-4. Ordering Information	6-1
4-15. Model 1411A Over-all Description	4-2	VII MANUAL CHANGES AND OPTIONS	7-1
4-19. Block Diagram Description	4-3	7-1. Manual Changes	7-1
4-32. Model 1411A Circuit Details	4-4	7-3. Older Instruments	7-1
4-34. Pulse Generator	4-4	7-5. Newer Instruments	7-1
4-37. AC Amplifiers	4-4	7-7. Options	7-1
4-39. Stretcher Gate	4-4	7-9. Special Instruments	7-1
4-42. DC Amplifiers	4-4	VIII SCHEMATICS AND TROUBLESHOOTING	8-1
4-44. Signal Feedback	4-4	8-1. Introduction	8-1
4-46. Differential Amplifier	4-4	8-3. Component Identification	8-1
4-48. Switching Multivibrator	4-4	8-5. Repair and Replacement	8-1
4-51. Input Current Isolator	4-5	8-7. Servicing Etched Circuit Boards	8-1
4-54. Emitter Follower	4-5	8-10. Replacing Reed Relay	8-1
4-56. Output Cascode Amplifier	4-5	8-13. Troubleshooting	8-1
4-58. Y Record Output	4-5		
4-60. +12.6V Power Supply	4-5		

LIST OF ILLUSTRATIONS

Number	Title	Page	Number	Title	Page
1-1.	Model 1411A Sampling Vertical Amplifier	1-0	8-1.	Detailed Block Diagram	8-3
2-1.	Procedure for Locking Plug-ins Together	2-0	8-2.	Location of Adjustments	8-4
3-1.	Controls and Connectors	3-0	8-3.	Component Identification, MILLIVOLTS/CM Switch	8-4
3-2.	Risetime Adj Setup	3-3	8-4.	Component Identification, A104 Assembly	8-4
3-3.	Optimizing Sampling Efficiency	3-3	8-5.	Pulse Generator and Supply Schematic	8-5
3-4.	MILLIVOLTS/CM CAL and VERT CAL Adjustments	3-5	8-6.	Chassis Component Identification, Top View	8-6
3-5.	Single and Dual Channel Operation	3-6	8-7.	Chassis Component Identification, Bottom View	8-6
3-6.	Algebraic Addition and Differential Operation	3-7	8-8.	Component Identification, A105 Assembly	8-6
4-1.	Sampling Technique	4-0	8-9.	Channel A Stretcher Schematic	8-7
4-2.	Basic Sampler	4-0	8-10.	Rear Panel Connector	8-8
4-3.	Basic Sampler with Vertical Amplifier	4-0	8-11.	Vertical/Horizontal Connector	8-8
4-4.	Entire Sampling System	4-0	8-12.	Channel B Stretcher Schematic	8-9
4-5.	Horizontal Deflection Signal	4-1	8-13.	+12.6V Supply	8-10
4-6.	Model 1411A and Sampler	4-2	8-14.	Component Identification, A501 Assembly	8-10
5-1.	Sampling Efficiency	5-3	8-15.	Amplifier and Multivibrator Schematic	8-11

LIST OF TABLES

Number	Title	Page
1-1.	Specifications	1-0
1-2.	Samplers Available for the Model 1411A	1-1
2-1.	Shipping Carton Test Strength	2-1
3-1.	Summary of Front-panel Adjustments	3-4
5-1.	Recommended Test Equipment	5-1
5-2.	Attenuator Accuracy	5-2
5-3.	Sensitivity Calibration	5-4
	Performance Test Record	5-4a/h
6-1.	Reference Designators and Abbreviations	6-1
6-2.	Replaceable Parts	6-2
7-1.	Manual Changes	7-1
8-1.	Schematic Notes	8-3

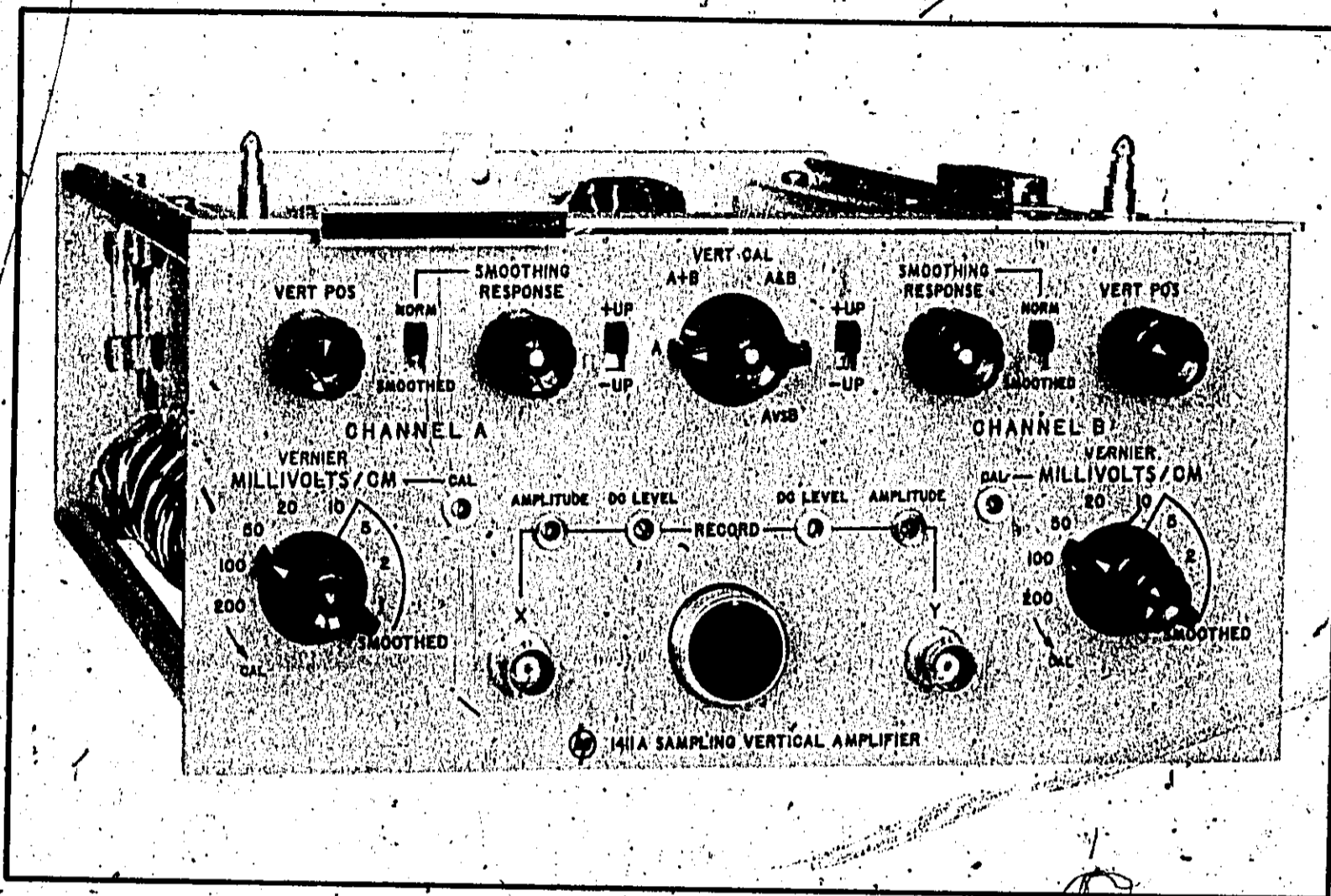

Figure 1-1. Model 1411A Sampling Vertical Amplifier

Table 1-1. Specifications

(When used with 1430A, 1431A, or 1432A)

MODES OF OPERATION:

1. Channel A only.
2. Channel B only.
3. Channel A and Channel B.
4. Channel A and Channel B added algebraically.
5. Channel A vs. Channel B.

POLARITY: Either channel may be displayed either positive or negative up in any mode.

DEFLECTION FACTOR: 1 mV/cm to 200 mV/cm in a 1, 2, 5 sequence; accuracy $\pm 3\%$; Vernier provides continuous adjustment between ranges and increases maximum sensitivity to greater than 0.4 mV/cm.

ATTENUATOR ACCURACY: $\pm 3\%$; $\pm 5\%$ Smoothed

ISOLATION BETWEEN CHANNELS: Greater than 40 dB over bandwidth of sampler.

RECORDER OUTPUTS: Front panel outputs provide 0.1 V/cm from a 500-ohm source. Gain adjustable from approx. 0.05 V/cm to 0.2 V/cm. DC level adjustable from approx. -1.5V to +0.5V.

WEIGHT: Net, 10 lbs. (4,5 kg). Shipping, 15 lbs. (6,8 kg).

SECTION I GENERAL INFORMATION

1-1. SCOPE OF MANUAL.

1-2. This manual provides operating and service information for the Hewlett-Packard Model 1411A Sampling Vertical Amplifier. The information in this manual supplements that presented in the Model 1430 Series Samplers and Model 140 Series Oscilloscope manuals. For information on other instruments, refer to the manual for those particular instruments.

1-3. DESCRIPTION.

1-4. The HP Model 1411A Sampling Vertical Amplifier (Figure 1-1) is a two-channel plug-in designed for use in Model 140 Series Oscilloscopes. The instrument must be used with a compatible sampling horizontal plug-in and a wide-band remote sampler device. At present, three remote samplers are available for the Model 1411A (refer to Table 1-2).

1-5. The Model 1411A and remote sampler offer several advantages over conventional sampling devices. By placing the remote sampler right at the test point, losses caused by long probe leads are eliminated. A maximum calibrated sensitivity of 1 mV/cm with automatic smoothing allows measurement of very small signals at a low-noise level. Simultaneous sampling of two channels permits accurate time measurements to be made between channel A and B signals. In general, sampling presents almost none of the problems afflicting the usual high-frequency oscilloscopes, yet offers most of the advantages of conventional oscilloscopes, exemplified by multiple trace capability.

1-6. The Model 1411A remote sampler combination permits observation of several display functions. A single trace from either channel A or B may be observed. Separate traces from channel A and channel B may be selected simultaneously to check time relationships. X-Y patterns (channel A versus channel B) are available. A single trace representing the algebraic sum of channel A and channel B may also be obtained. Either channel may be displayed as positive or negative polarity up in any mode.

1-7. Eight calibrated ranges of vertical sensitivity are provided, ranging from 1 mV/cm to 200 mV/cm in a 1, 2, and 5 sequence. A vernier control provides continuous adjustment between ranges and increases maximum sensitivity to greater than .4 mV/cm.

1-8. Front-panel recorder outputs with both amplitude and dc level controls are provided. Risetime adjustments for each channel are located on the front panel for optimum compromise between risetime, overshoot, and noise.

1-9. MANUAL IDENTIFICATION.

1-10. Information in this manual applies directly to Model 1411A instruments with the serial prefix listed on the title page. The serial prefix is the first three digits of the eight-digit serial number used to identify each HP instrument. If the serial prefix is not the same as listed on the title page, a Manual Changes sheet supplied with the manual will define the differences between that instrument and the one described in this manual. Corrections to a manual due to errors that existed when it was printed are called Errata and will appear only on a change sheet, (if any). For information pertaining to change sheets, contact the nearest HP Sales/Service Office.

Table 1-2. Samplers Available for the Model 1411A*

Model	Features
1430A	dc to 12.4 GHz, 28 ps risetime, 1 mV/cm
1431A	dc to 12.4 GHz, low VSWR, flat response
1432A	dc to 4 GHz, 90 ps risetime, 1 mV/cm
* Check latest literature for additional new samplers.	

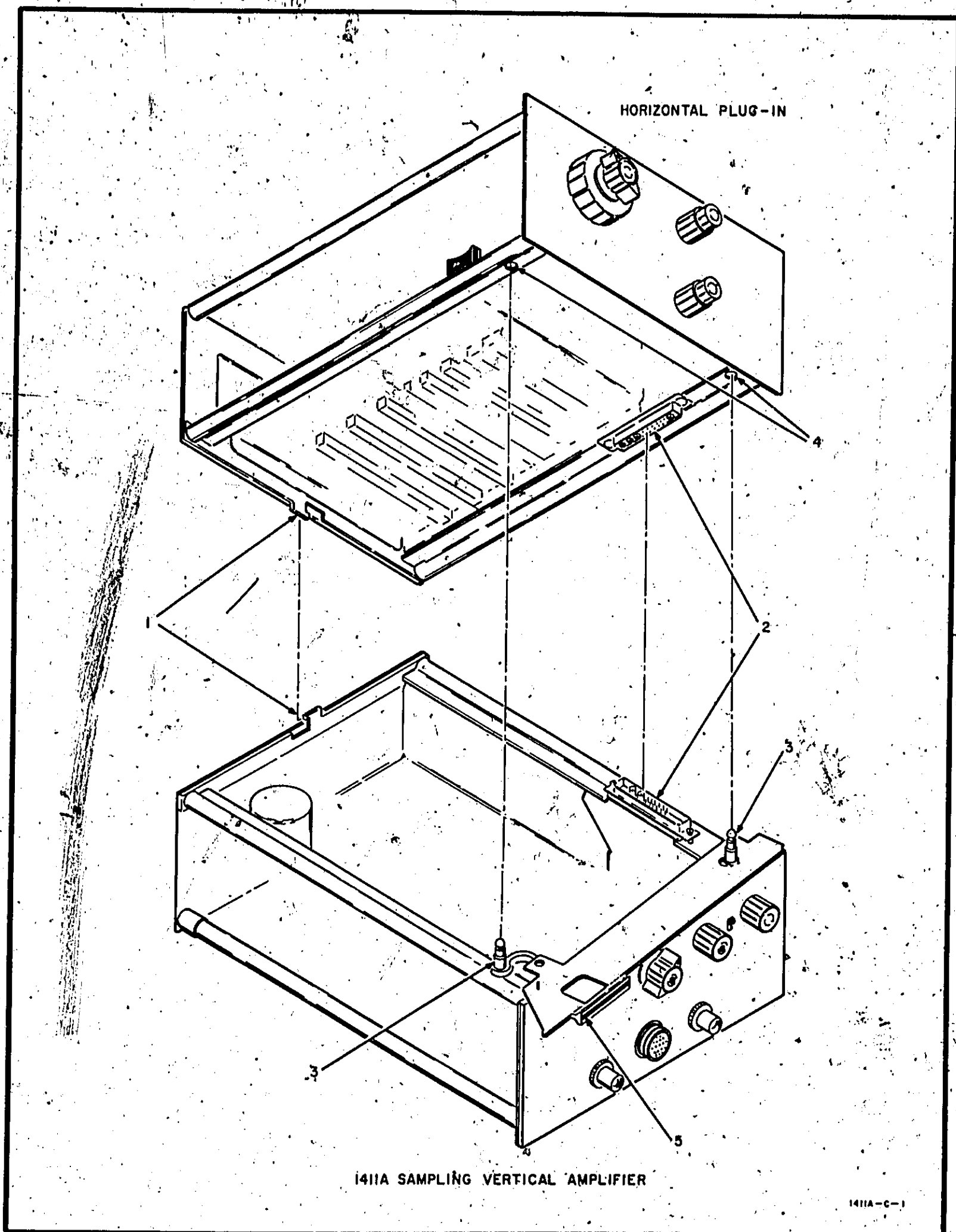

Figure 2-1. Procedure for Locking Plug-ins Together.

SECTION II INSTALLATION

2-1. INITIAL INSPECTION.

2-2. **MECHANICAL CHECK.** Inspect the Model 1411A upon receipt for any damage which may have occurred in transit. Check for external damage such as broken knobs, bent or broken connectors, and dents or scratches on the panel surface. If damage is found, refer to Paragraph 2-7 for recommended claim procedure. Retain packing material for possible future use.

2-3. **ELECTRICAL CHECK.** Check the electrical performance of the Model 1411A as soon as possible after receipt. Refer to Paragraph 5-3 for recommended performance checks. These checks verify that the Model 1411A is operating within the specifications listed in Table 1-1. The performance checks are good test procedures for incoming quality-control inspection. Initial performance and accuracy of the instrument are certified as stated on the inside front cover of this manual. If the Model 1411A does not operate as specified, refer to Paragraph 2-7 for claim procedure.

2-4. PREPARATION FOR USE.

2-5. The Model 1411A Sampling Vertical Amplifier must first be locked to the sampling time base unit. To fasten the two units together, place the time base unit above the Model 1411A and with a slight twisting action fasten the two rear interlocks together (see Figure 2-1, item 1). Press the time base down, being careful to properly align the jack and plug (item 2). The two guide pins at the front of the Model 1411A (item 3) should mate with their respective guide holes in the time base (item 4) and snap together.

2-6. To install the horizontal/vertical combination in the oscilloscope, first remove the dividing shield between the upper and lower compartments by pulling it straight out. Next, pull the locking lever outwards (item 5), and slide the combination into the oscilloscope. Pressing the locking lever in will secure the two units to the oscilloscope.

Note

The deflection plate sensitivity of CRT's will differ slightly from one oscilloscope to another. For this reason, when the Model 1411A and sampler combination is installed in an oscilloscope for the first time, or when changed from one oscilloscope to another, the VERTICAL adjustment must be performed to calibrate the amplifier gain to the deflection sensitivity of that particular oscilloscope. (See Figure 3-4 for procedure.)

2-7. CLAIMS.

2-8. The warranty statement applicable to all Hewlett-Packard Company instruments and products is provided inside the front cover of this manual. If physical damage is found or if operation is not as specified when the instrument is first received, notify the carrier and the nearest Hewlett-Packard Sales/Service Office immediately (see list in back of manual for addresses). The Sales/Service Office will arrange for repair or replacement without waiting for settlement of the claim with the carrier.

2-9. REPACKAGING FOR SHIPMENT.

2-10. If the Model 1411A is to be shipped to a Hewlett-Packard Sales/Service Office for service or repair, attach a tag showing owner (with address), instrument model number, full serial number of the instrument (all eight digits) and description of the service or repair required.

2-11. The original shipping carton and packaging material may be reusable. The Sales/Service Office will provide information and recommendations on materials to be used if the original packaging material is not available. Materials used for shipping an instrument should include the following:

a. A double-walled carton, refer to Table 2-1 for test strength required.

Table 2-1. Shipping Carton Test Strength

Gross Weight (lbs)	Carton Strength (test lbs)
up to 10	200
10 to 30	275
30 to 120	350
120 to 140	500
140 to 160	600

b. Heavy paper or sheets of cardboard to protect all instrument surfaces; use a nonabrasive material such as polyurethane or cushioned paper such as Kim-Pak around all projecting parts.

c. At least 4 inches of tightly-packed, industry-approved, shock-absorbing material such as extra-firm polyurethane foam.

d. Heavy-duty shipping tape for securing outside of carton.

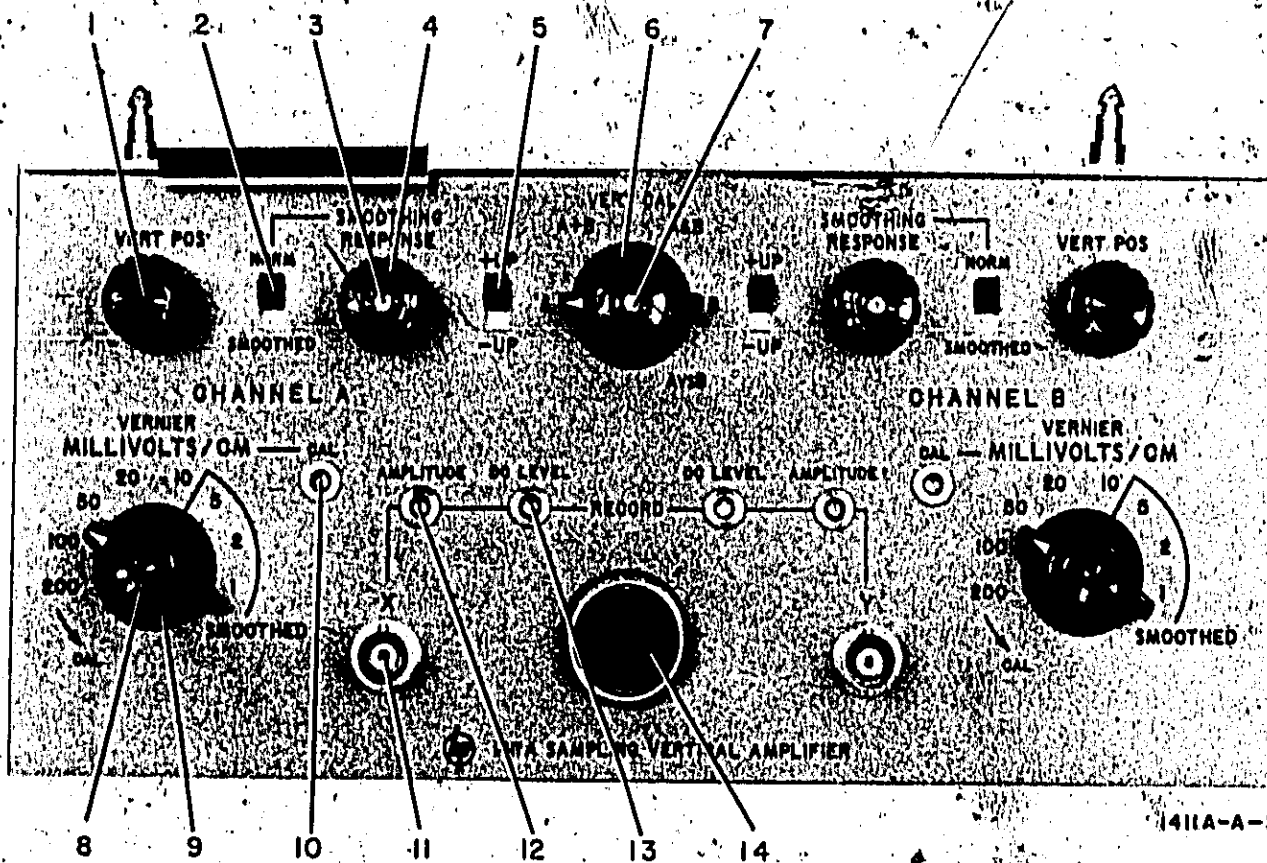

- | | |
|--|---|
| <ol style="list-style-type: none"> 1. Adjusts vertical position of Channel A trace. 2. Selects either normal or smoothed response. 3. Adjusts over-all sampling efficiency of Channel A. 4. Adjusts risetime of Channel A. 5. Determines polarity of Channel A signal presentation. 6. Selects mode of presentation. 7. Calibrates vertical sensitivity of main vertical amplifier (both A and B Channels). | <ol style="list-style-type: none"> 8. Adjusts vertical deflection factor between calibrated ranges. 9. Changes vertical deflection factor in calibrated ranges. 10. Calibrates vertical deflection factor of Channel A. 11. Output connector for X-axis output signals. 12. Adjusts amplitude of X-axis output signals. 13. Adjusts dc level of X-axis output signals. 14. Jack for connecting remote sampler. |
|--|---|

Figure 3-1. Controls and Connectors

SECTION III OPERATION

3-1. INTRODUCTION.

3-2. This section includes explanations of instrument controls, front-panel adjustments, available modes of operation, operating considerations regarding smoothing and risetime, and step-by-step operating instructions. Since the Model 1411A, remote sampler and horizontal plug-in are closely interdependent during high-frequency sampling, the instructions presented in this section are supplemented by the operating instructions given in the sampler and sampling time base manuals.

3-3. The Model 1411A, remote sampler and sampling time base combination enables the oscilloscope to synthesize and display repetitive waveforms at frequencies up to 12.4 GHz (depending upon choice of sampler). The Model 1411A Sampler provides two separate vertical channels, enabling time comparisons to be made between channel A and channel B signals. Outputs are provided for driving X-Y or strip chart recorders. Front-panel controls allow risetime, overshoot and noise to be optimized for state-of-the-art measurements. The extremely fast risetime of the instrument combination permits unsurpassed signal measurement accuracy.

3-4. FRONT PANEL CONTROLS.

3-5. Front-panel controls and connectors are briefly described by function in Figure 3-1. Only the controls of Channel A and controls common to both channels are described in the figure. Channel B controls perform the same functions as those for Channel A. Additional information on some of the controls is given in Paragraphs 3-6 through 3-13.

3-6. **NORM-SMOOTHED.** The **NORM-SMOOTHED** switch selects the type of response desired. **NORM** response should be selected to view detailed waveforms and fast-rise pulses. When noise and jitter are presented on a signal and are not desired on the observed waveform, select **SMOOTHED** response.

3-7. **SMOOTHING-RESPONSE.** The **SMOOTHING** control (screwdriver adjust) controls the over-all sampling efficiency by adjusting the gain of the sampling loop. The **RESPONSE** control adjusts risetime to compensate for changes in ambient temperature, or when changes in risetime (bandwidth) are desired. Proper setting of these two controls is an absolute necessity if accurate displays are to be obtained. Paragraphs 3-21 through 3-30 explain the procedures for making these adjustments.

3-8. **-UP, +UP.** This switch determines the polarity of the displayed signal. In the **+UP** position, positive signals are presented as a positive-up display. In the **-UP** position, negative signals are displayed as a positive-up display.

3-9. **Mode Selector.** The position of this switch determines which channel or combination of channels is

displayed on the CRT. Five displays are available: A, A+B, A & B, B, and A vs B. Refer to Paragraph 3-14 for detailed application of each of these modes.

3-10. **MILLIVOLTS/CM.** This control selects the sensitivity for the input signal and is calibrated in millivolts/centimeter of vertical deflection. In the 5, 2, and 1 **MILLIVOLTS/CM** positions, random changes in input signal amplitude are attenuated within the amplifier and the signal is automatically smoothed, reducing noise level on the display. The **VERNIER** control permits the displayed waveform to be adjusted to any convenient height. When **VERNIER** is set to the detent (**CAL**) position, the vertical display can be read directly in **MILLIVOLTS/CM**. With the **VERNIER** set fully clockwise, and sensitivity set to 1 **MILLIVOLT/CM**, vertical sensitivity is increased to at least .4 mV/cm.

3-11. **MILLIVOLTS/CM CAL.** These adjustments calibrate gain of the individual channels. If the sensitivities of Channel A and Channel B are not equal, these adjustments should be checked for both channels. These adjustments should be checked when the remote sampler is connected for the first time, or whenever different samplers are used with the Model 1411A.

3-12. **VERT CAL.** This front-panel adjustment controls gain of the final amplifier stage (common to both A and B channels). This adjustment should be checked each time the Model 1411A is changed from one oscilloscope to another, or when installed for the first time, to calibrate the sensitivity of the instrument to the deflection plate characteristics of each particular oscilloscope.

3-13. **X-Y RECORD.** These BNC connectors provide recorder outputs for both the X and Y axis with separate **AMPLITUDE** and **DC LEVEL** controls.

3-14. MODES OF OPERATION.

3-15. As previously noted, five modes of presentation are available. Each mode is described briefly by the following paragraphs.

3-16. **A.** In this position, only signals applied to Channel A are displayed. The polarity (**+UP**, **-UP**) switch permits the signal to be displayed as either a **(+)A** or **(-)A** signal.

3-17. **A + B.** In this position, Channel A and Channel B signals are algebraically summed. If both polarity switches are in the same relative position (both **+UP** or both **-UP**), the displayed signal will represent the algebraic sum of the two inputs [e. g. **(+)A + (+)B** or **(-)A + (-)B**]. If the polarity switches are in dissimilar positions (one **-UP** and one **+UP**), the displayed signal will represent the algebraic difference of the two inputs [e. g. **(+)A + (-)B** or **(-)A + (+)B**], resulting in differential operation.

3-18. A & B. With the mode switch in this position, two separate displays are provided, completely independent of each other. This enables accurate time and/or amplitude comparisons to be made between the two signals. The polarity switches may be used to present a (+)A & (+)B, (-)A & (-)B, (+)A & (-)B or (-)A & (+)B display.

3-19. B. In this position, only Channel B signals are displayed. The polarity switch enables the B signal to be observed as either a (+)B or (-)B.

3-20. A vs B. This mode provides an X-Y axis display. Channel A signals are amplified and sent to the vertical deflection plates in the usual manner as a Y-axis display. Channel B signals are amplified and routed to the horizontal amplifier in the time base plug-in and presented on the CRT as an X-axis display. Since both polarity switches remain operative in the mode, any combination of polarities may be selected for the X-Y presentation.

3-21. SAMPLING EFFICIENCY.

3-22. DEFINITION.

3-23. Sampling efficiency of the Model 1411A is a measure of its ability to follow any change of input signal level from sample to sample. Efficiency is optimum when, within the risetime limits of the instrument, the vertical position of each sample on the CRT corresponds exactly to the amplitude of the input signal at the time of the sample. If efficiency is low, more than one sample is required to respond to a change. If efficiency is too high, sample-to-sample overshoot and ringing occurs.

3-24. The Model 1411A provides two types of response (sampling efficiency), normal and smoothed. Either type of response can be selected by the front panel NORM-SMOOTHED switch. Normal response is intended for use when viewing detailed waveforms and fast rise pulses. Smoothed response provides filtering of the input signal and reduces the effects of noise and jitter by about 4:1 compared to the effects seen on normal response. Use smoothed response when noise and jitter in a signal are not desired in the observed waveform.

3-25. In addition to the SMOOTHED operation that is selected by the switch, the input signal is automatically smoothed when the MILLIVOLTS/CM switch is set to any of its three highest sensitivity ranges (5, 2, or 1). The automatic smoothing is progressive, being greatest on the 1 mV/cm range.

Note

When using the 5, 2, or 1 MILLIVOLTS/CM ranges, the NORM-SMOOTHED switch should always be in the NORM position.

3-26. OPTIMIZING SAMPLING EFFICIENCY.

3-27. INITIAL ADJUSTMENT. If a Model 1411A and sampler are purchased together, they will be calibrated together at the factory. Upon receiving the Model 1411A and sampler, if the sampling efficiency is not 100%, use the RESPONSE control to reset the loop gain to 100% efficiency (as shown in Figure 3-3, waveform a).

The Model 1411A/sampler system will be optimized (100% sampling efficiency with a risetime of < 28 ps using Model 1430A or 1431A Sampler or < 90 ps using a Model 1432A Sampler) and under normal circumstances, neither of these controls (RESPONSE or SMOOTHING) should require readjustment.

3-28. If the Model 1411A and sampler are purchased separately, or if the Model 1411A sampler combination is changed, or when adjusting to correct for extreme ambient temperatures (Paragraph 3-29), optimize the system as follows:

a. Turn system on and allow at least 1 hour for instruments to reach ambient temperature.

b. Connect a fast risetime pulse generator, such as the HP Model 1105A/1106A, to the system as shown in Figure 3-2. Use the 6-ft. cable that is supplied with the pulse generator. To prevent random triggering, when optimizing the Model 1432A, use ≈ 20 cm of air line between the pulse generator and the sampler INPUT.

c. Set controls as follows:

SMOOTHING switch	SMOOTHED
MILLIVOLTS/CM	50
VERNIER	set for 10 cm of deflection
Polarity	+UP
Sweep Magnifier	X1
Mode	Main Sweep (1425A) or Normal (1424A)
SCAN DENSITY	maximum cw
TIME/CM	1 nSEC/CM

d. Adjust Model 1105A SENSITIVITY control for a stable display of pulse.

e. Using the magnifier, set time base for a sweep speed of 10 ps/cm and adjust magnified position to display leading edge of pulse.

f. Adjust RESPONSE for desired risetime. For the Models 1430A and 1431A, 35 ps (observed) is optimum. For the Model 1432A, 90 ps (observed) is optimum.

g. Set NORM-SMOOTHED switch to NORM and adjust SMOOTHING (screwdriver adj) for 100% sampling efficiency as shown in Figure 3-3, waveform a.

3-29. TEMPERATURE EXTREMES. Each channel of the sampling system should be set for 100% sampling efficiency at an ambient temperature of 25° C (77° F). Whenever the ambient temperature exceeds 40° C (104° F), sampling efficiency decreases and risetime becomes faster. If the ambient temperature falls below 15° C (59° F), sampling efficiency increases and risetime becomes slower. If the system is operated at either temperature extreme, risetime and sampling efficiency should be reset as outlined in Paragraph 3-28.

3-30. CHANGING RISE TIME. Observed risetime with the RESPONSE control at midrange should be approximately 35 picoseconds (using a Model 1430A or 1431A Sampler). Counterclockwise rotation of RESPONSE control decreases risetime, however overshoot greater than 5% and low-frequency distortion can be expected. Faster risetime will result in some smoothing of the input signal, but if the horizontal scan density and sweep speed controls are set so that

the vertical distance between the dots is small compared to the the amplitude of the signal under test, there will be no loss of detail. When risetime is changed from normal setting, it may be desirable to recheck sampling efficiency as outlined in Figure 3-3.

3-31. OPERATING PROCEDURES.

3-32. Common operating setups and procedures for performing the MILLIVOLTS/CM CAL and VERT CAL adjustments are given in Figures 3-4 through 3-6. Each figure includes a front-panel illustration of the Model 140A, Model 1411A and a horizontal time base plug-in. Whenever a control or connector is used in a procedural step of the instruction, the step number is called out from the control on the illustration. Table 3-1

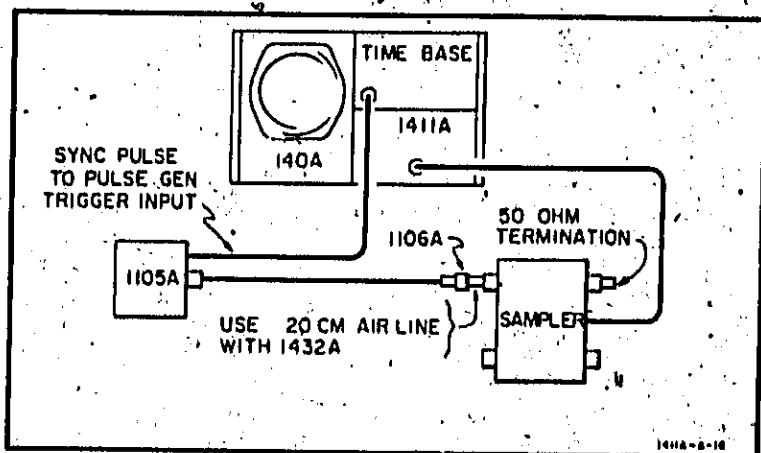
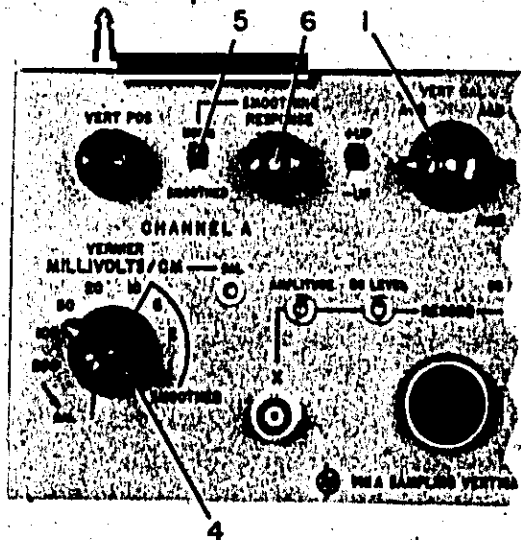

Figure 3-2. Risetime Adj Setup



1. Select channel to be adjusted.
2. Connect signal to INPUT of channel selected (signal should produce an amplitude difference between beginning and end of display).
3. Adjust horizontal plug-in to obtain presentation. Adjust SCANDENSITY so that dot density is shown as in Figure 3-2. (min)
4. Adjust MILLIVOLTS/CM for display 5 to 6 cm high.
5. Set SMOOTHING to NORM.
6. Adjust SMOOTHING so that second sample from left is part of waveform as shown in waveform a. Waveform b indicates response adjusted too high; waveform c indicates response adjusted too low.)

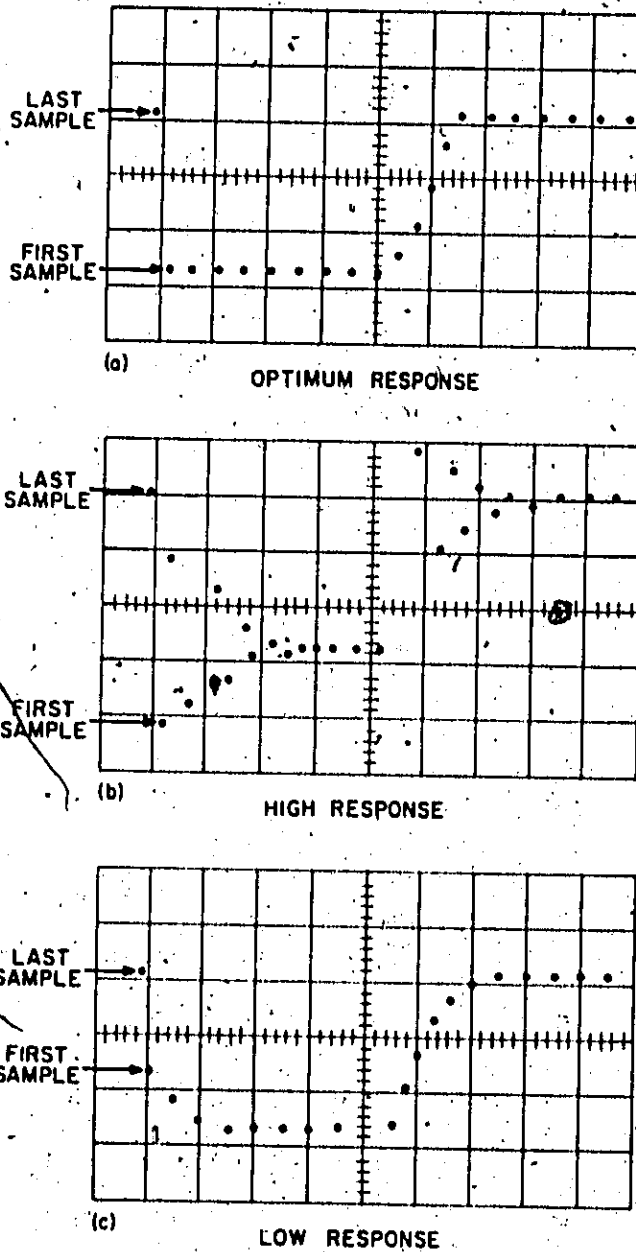

Figure 3-3. Optimizing Sampling Efficiency

lists and describes the adjustment controls on the front-panel.

3-33. LOW FREQUENCY RESPONSE. If the information to be viewed is greater than 100 ns in width, response of the sampling system can be improved by slowing down the risetime. Set NORM-SMOOTHED switch to SMOOTHED and turn RESPONSE control clockwise (increasing or slowing the risetime). Sampling efficiency will be slightly less than 100% but will not appreciably affect the accuracy of the measurements. Do not adjust SMOOTHING. When it is desired to reset the risetime to 28 ps, rotate RESPONSE control counterclockwise until sampling efficiency returns to 100%. The system will now be optimized; risetime of 28 ps (Models 1430A and 1431A), 90 ps (1432A), and 100% sampling efficiency.

3-34. GROUND LOOPS. Ground loops can cause undesirable noise and jitter on the observed waveform. To keep these ill-effects to a minimum, connect all equipment to the same power source or as close together as possible.

3-35. ATTENUATORS. Signals in excess of the maximum safe input for the samplers (± 3 volts, Models 1430A and 1431A and ± 5 volts, Model 1432A) may be observed if the signal is first attenuated to the safe input level by use of a 50-ohm coaxial attenuator. The HP Models 8491A and 8492A coaxial attenuators may be obtained in several sizes (3, 6, 10, 20 dB or higher). A variable attenuator is also available (HP Model 354A) providing 0 to 60 dB in 10 dB steps. Refer to an HP catalog or consult an HP Sales/Service Office for information on attenuators to meet any requirements.

Table 3-1. Summary of Front-panel Adjustments

Adjustments	Purpose	When Required	Ref. Par.
MILLIVOLTS/CM CAL	Equalize or balance gain of Channel A to Channel B	<ol style="list-style-type: none"> 1. Initial calibration when Model 1411A and sampler are purchased separately 2. When system combination is changed 3. After repairs or periodic calibration 	<p>3-11</p> <p>3-11</p>
VERT CAL	Calibrates gain of entire vertical sampling system to the particular deflection plate sensitivity of the CRT	<ol style="list-style-type: none"> 1. When system is installed in oscilloscope for first time 2. When changed from one oscilloscope to another 3. After performing MILLIVOLTS/CM CAL Adj 4. After repairs or periodic calibration 	<p>3-12</p> <p>3-12</p> <p>Figure 3-4</p>
RESPONSE	Adjusts risetime to desired value, or to compensate for extreme temperatures.	<ol style="list-style-type: none"> 1. When ambient temperature exceeds 40° C (104° F) or drops below 15° C (59° F) 2. When risetime faster or slower than normal is desired 3. To improve low-frequency response 4. To optimize response when units are purchased together (SMOOTHING is calibrated at factory) 5. Initial calibration when units are purchased separately or when unit combination is changed 6. After repairs or periodic calibration 	<p>3-29</p> <p>3-30</p> <p>3-33</p> <p>3-27</p> <p>3-28</p>
SMOOTHING	Adjusts loop gain of the vertical sampling system for 100% sampling efficiency	<ol style="list-style-type: none"> 1. Part of initial calibration procedure when units are purchased separately 2. When risetime has been changed from normal 3. When compensating for temperature extremes 4. After repairs or periodic calibration. 	<p>3-28</p> <p>3-30</p> <p>3-29</p>

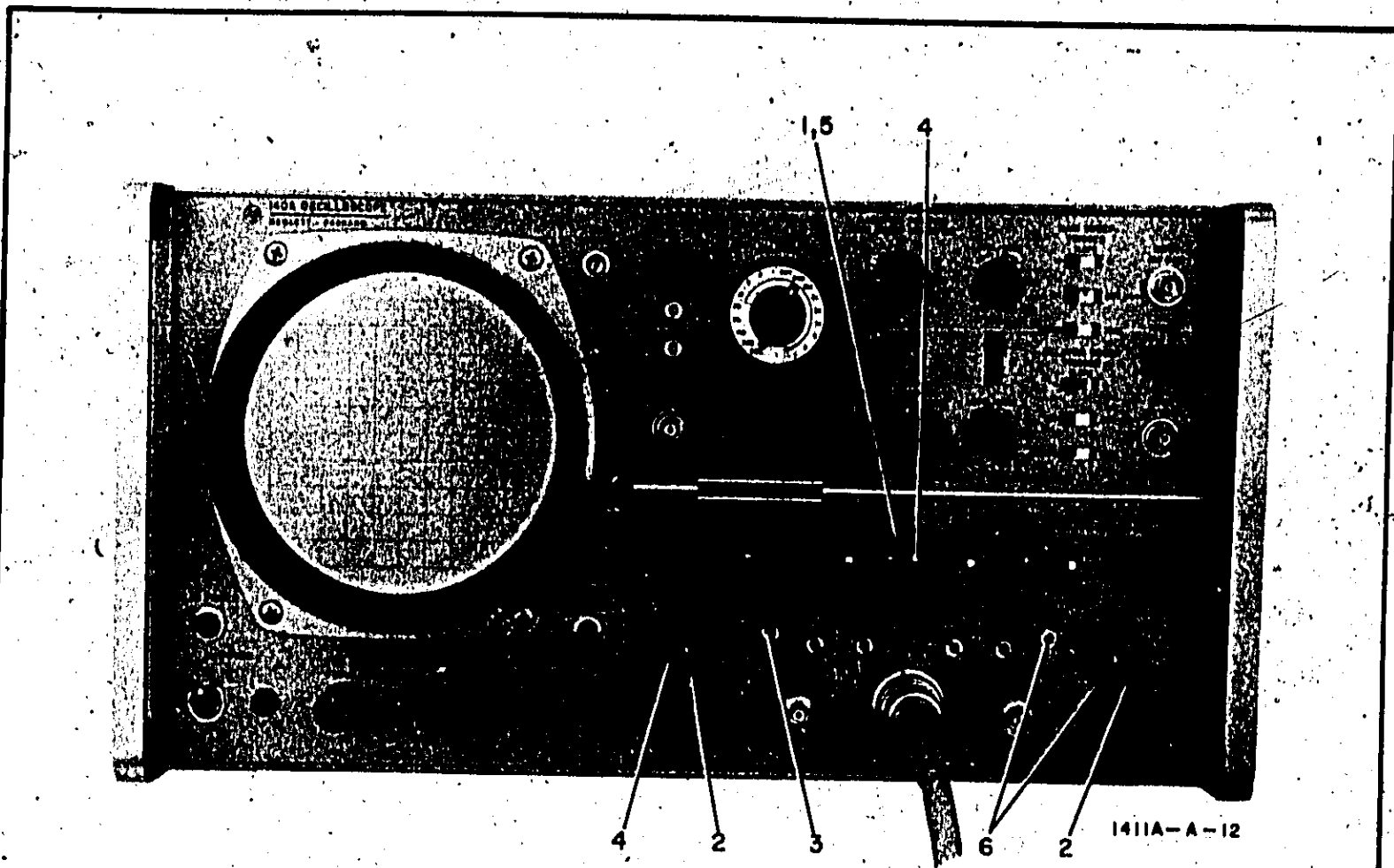

MILLIVOLTS/CM CAL AND VERT CAL

1. Set mode selector to A.
2. Set both Channel A and B VERNIER to CAL.
3. Mechanically center Channel A MILLIVOLTS/CM CAL adjustment.

CAUTION

Use a power supply with a low output impedance (<1 ohm) such as the HP Model 6111A in step 4. Do not use a power supply with a high output impedance as damage to the sampler and/or power supply may result. If a power supply with low output impedance (<1 ohm) is not available, use the 1V CALIBRATOR output on the oscilloscope. Remove the 50-ohm termination from the sampler before connecting the 1V CALIBRATOR signal.

4. Observe a 1-volt pulse or dc voltage on Channel A and adjust VERT CAL for exactly 10 cm of deflection on the 100 mV/cm range.
5. Change mode selector to B and connect the known voltage to Channel B INPUT of the sampler.
6. Adjust B MILLIVOLTS/CM CAL for exactly 10 cm of deflection on the 100 mV/cm range.

Note

After performing the MILLIVOLTS/CM CAL and VERT CAL adjustment, check sensitivity accuracy on the 5, 2, and 1 mV/cm ranges. If deflection is not within $\pm 5\%$ on these ranges, perform the stretcher gain adj described in Section 5.

Figure 3-4. MILLIVOLTS/CM CAL and VERT CAL Adjustments

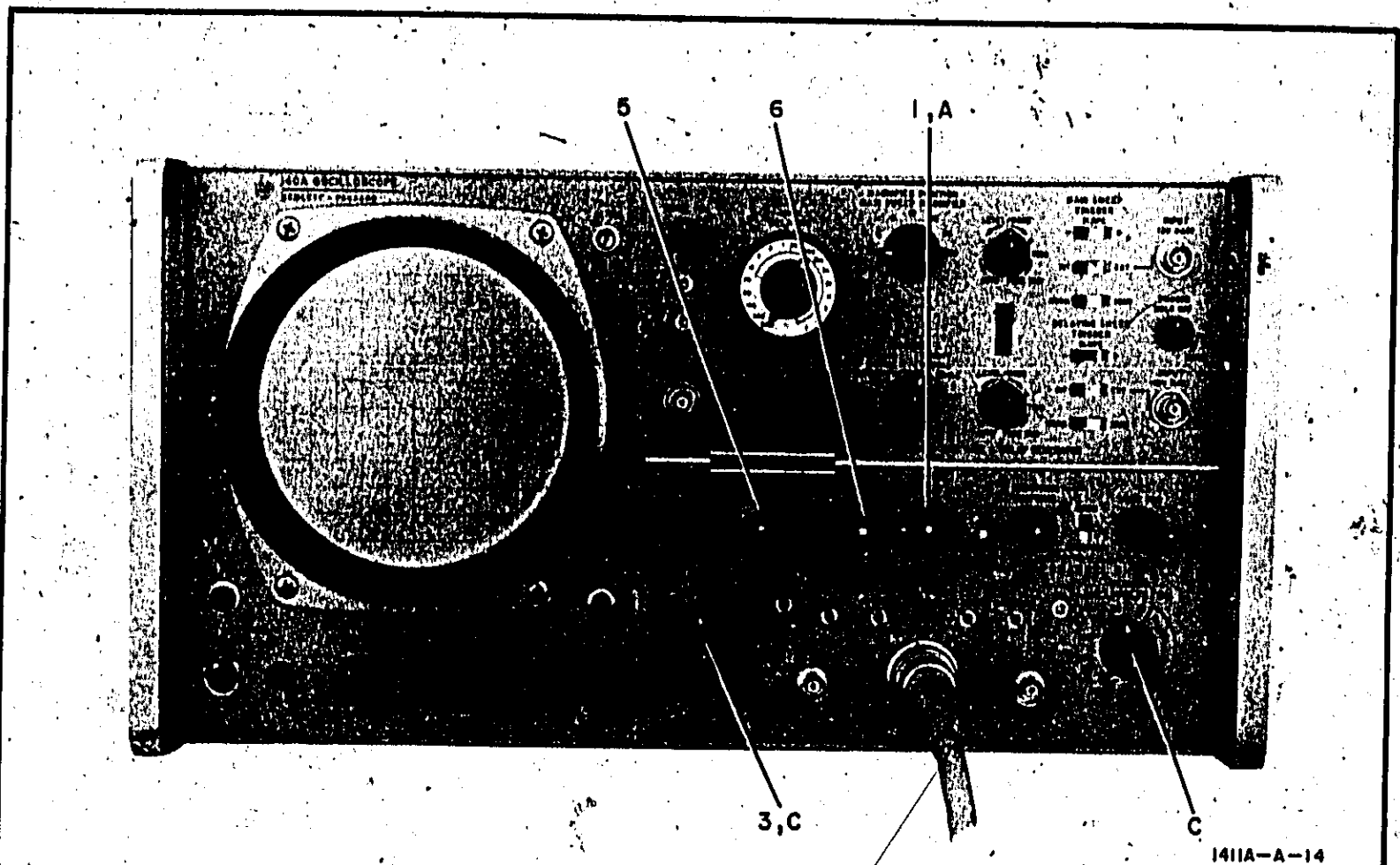

SINGLE CHANNEL

1. Set mode selector to A or B as desired.
2. Connect the signal to appropriate INPUT of the remote sampler.

CAUTION

Do not exceed the maximum safe input for the sampler.

Models 1430A and 1431A ±3 V pk-pk
Model 1432A ±5 V pk-pk

3. Set MILLIVOLTS/CM and VERNIER as required.
4. Set horizontal controls as required to obtain display (refer to horizontal plug-in manual).
5. If noise and/or jitter is present on signal and is not desired, set NORM-SMOOTHED switch to SMOOTHED.
6. Set polarity switch of appropriate channel to desired position.

Note

If the RESPONSE, SMOOTHING, or VERT PQS controls of the unused channel are maladjusted, the Model 1411A/sampler may have spurious oscillations that will degrade the operation of the channel being used.

DUAL CHANNEL

- A. Set mode selector to A & B.
- B. Connect signals to the INPUTS of the remote sampler. Observe maximum voltage ratings of sampler in use.
- C. Set MILLIVOLTS/CM and VERNIER as required.
- D. Set horizontal controls as required to obtain display (refer to horizontal plug-in manual).
- E. Two completely independent displays will be presented enabling amplitude and time comparisons to be made.

Figure 3-5. Single and Dual Channel Operation

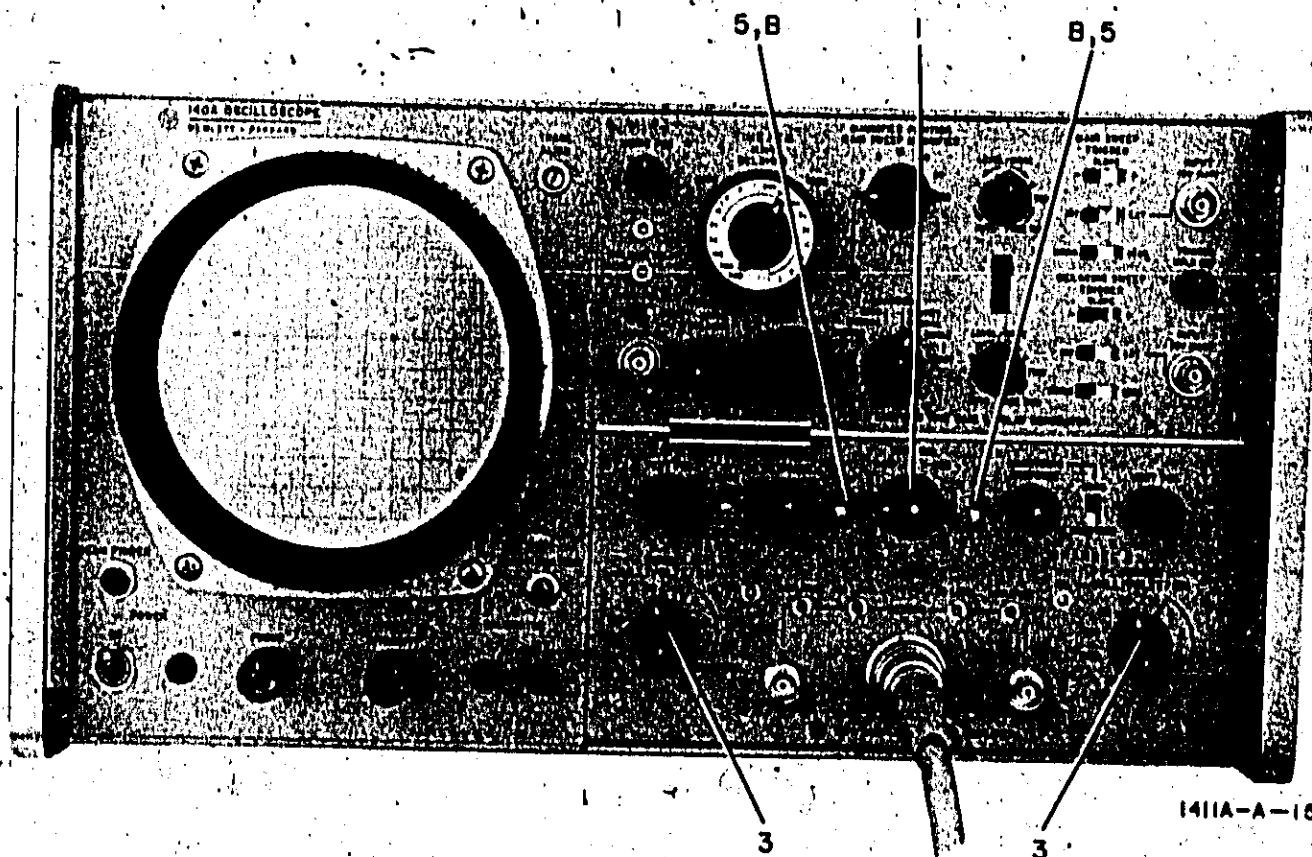

ALGEBRAIC ADDITION

1. Set mode selector to A + B.
2. Connect signals to INPUTS of remote sampler. Observe maximum input limits.
3. For a meaningful display, set both MILLIVOLTS/CM and VERNIER controls to same setting.
4. Set horizontal controls as required to obtain desired display.
5. Set both polarity switches to same position (both +UP or both -UP).
6. The trace represents the algebraic sum of channel A and B signals.

DIFFERENTIAL OPERATION

- A. Perform steps 1 through 4 of algebraic addition operation.
- B. Set one polarity switch to +UP and the other polarity switch to -UP.
- C. The trace will represent the algebraic difference between channel A and B input signals.

Figure 3-6. Algebraic Addition and Differential Operation

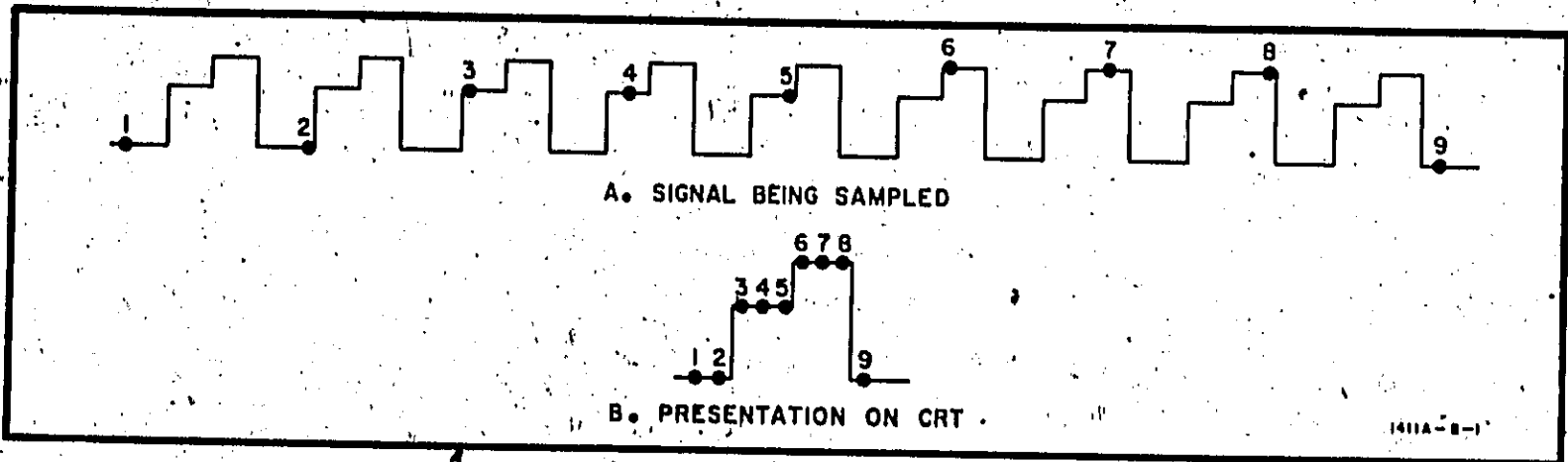

Figure 4-1. Sampling Technique

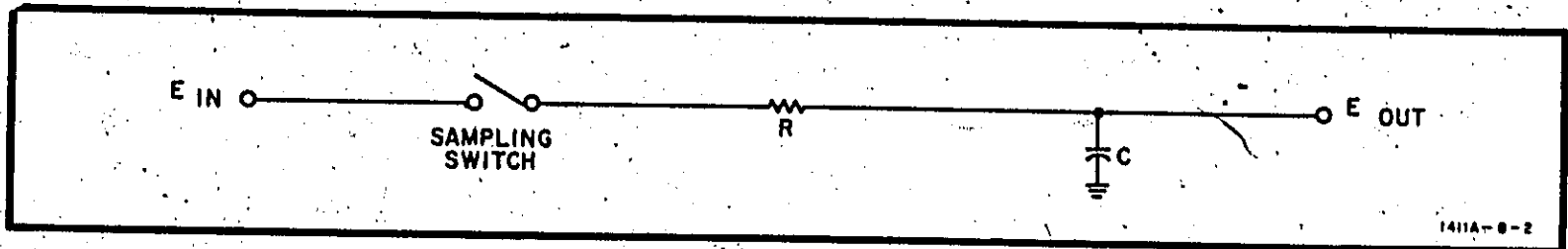

Figure 4-2. Basic Sampler

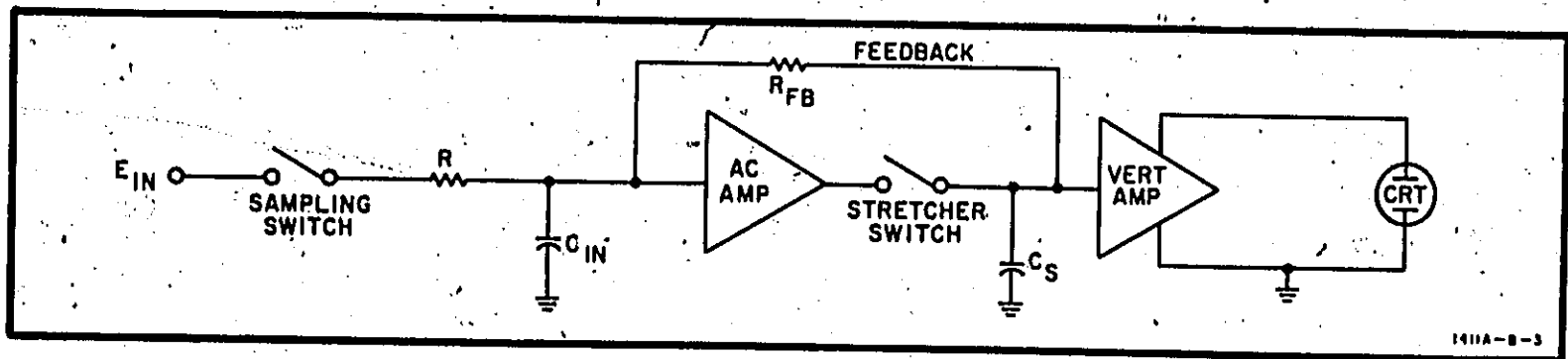

Figure 4-3. Basic Sampler with Vertical Amplifier

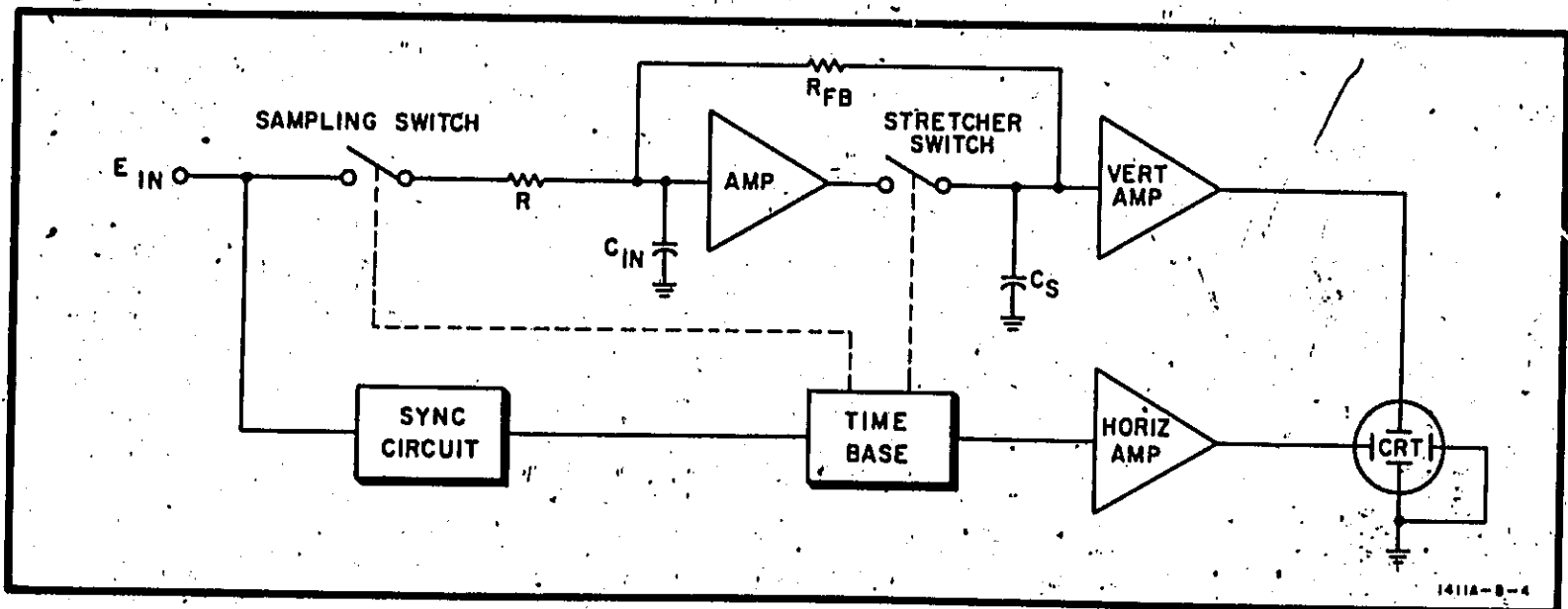

Figure 4-4. Entire Sampling System

SECTION IV PRINCIPLES OF OPERATION

4-1. INTRODUCTION.

4-2. This section provides circuit theory analysis of the Model 1411A Sampling Vertical Amplifier. An explanation of general sampling theory is presented before covering the specific theory of the Model 1411A.

4-3. GENERAL THEORY.

4-4. Sampling oscilloscopes differ from conventional oscilloscopes in that instead of continuously monitoring the signal under test, the sampling device samples the signal amplitude at regulated intervals and in this manner, synthetically reproduces the sampled signal. These samples are presented on the CRT as a series of dots. (See Figure 4-1.)

4-5. Changing the Scan Density control of the sampling time base plug-in enables one to see a minimum of approximately 50 samples in 10 cm to a maximum of more than 1000 samples (dots) in 10 cm. When Scan Density is at or near maximum setting, the series of dots will appear as a continuous line.

4-6. VERTICAL SAMPLING.

4-7. A basic sampling circuit is shown in Figure 4-2. It consists of a sampling switch, a series resistor, and a shunt capacitor to ground. At the instant that the switch is closed, the capacitor begins to charge. The switch is closed for such a brief period that the capacitor only charges to approximately 5% of the actual signal amplitude.

4-8. Figure 4-3 shows a sampler circuit with a vertical amplifier and feedback circuit added. Sampling is accomplished by momentarily closing the sampling switch. Some voltage, determined by the RC time constant of the input resistance and capacitance, is transferred to the input capacitor, C_{in} . This voltage

is amplified and sent to the stretcher switch. The stretcher switch is closed at the same time that the sampling switch is closed, but remains closed for a much longer period of time. As a result, the stretcher capacitor has time to charge to the full voltage output of the ac amplifier. This voltage is applied to the vertical amplifier where it is amplified sufficiently to

drive the vertical deflection plates of the CRT. This new level is also fed back through a reverse attenuator, represented as R_{fb} , to the input capacitor. Gain of the ac amplifier and reverse attenuation are designed so that the voltage sent back to the input capacitor will represent 100% of the sampled signal voltage.

4-9. HORIZONTAL SAMPLING.

4-10. The horizontal circuitry of a sampling oscilloscope differs greatly from that of a conventional oscilloscope. The primary function of the sampling time base is to generate a sampling command trigger for the vertical circuits and to move the dots across the screen in uniform increments of time. Figure 4-4 shows an entire sampling system.

4-11. The horizontal scanner circuit consists of a sync circuit, time base, and horizontal amplifier. The sync circuit determines the sampling rate and establishes a reference point from which the sampling command trigger is given. The function of the time base circuit is to relay the sample command to the sampling and stretcher switches and "step" the dots across the CRT.

4-12. A conventional time base produces a linear sawtooth sweep to continuously move the beam horizontally across the CRT. The sampling time base also moves the beam across the screen, but not as a continuous movement. It positions the beam horizontally when a sample is taken and holds the beam at this location until the next sample is taken. The beam is then repositioned to a point slightly later in time on the CRT and remains there until the next sample.

4-13. Figure 4-5 shows the horizontal deflection signals for both a conventional and sampling oscilloscope. The staircase ramp advances one step after each sample is taken.

4-14. When the staircase potential reaches full-screen deflection, it is automatically reset (by discharging the staircase voltage) to start the next sweep. The net result of sampling a high-frequency signal and plotting it vertically against a horizontal staircase ramp is a reproduction in dot pattern of the original signal under test.

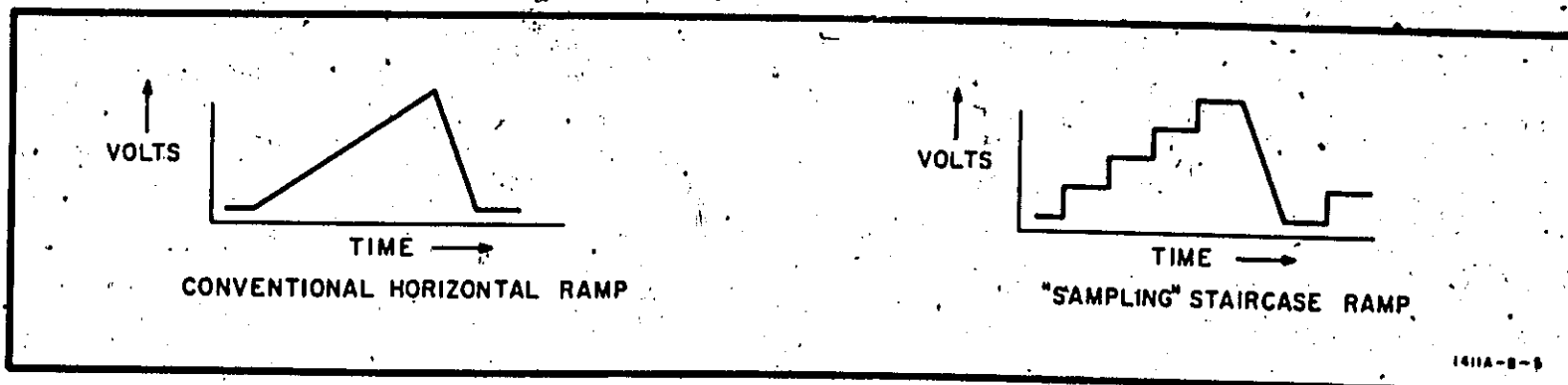

Figure 4-5. Horizontal Deflection Signal

4-15. MODEL 1411A OVER-ALL DESCRIPTION.

4-16. The primary function of the 1411A is to receive the sampled signal from the remote sampler and amplify the signal to sufficient amplitude to drive the vertical deflection plates of the CRT. Figure 4-6 shows the Model 1411A, remote sampler, the main signal inputs and outputs of the vertical system.

4-17. The sampling trigger from the horizontal plug-in, coupled through the Model 1411A to the remote sampler, initiates the sampling process. The sampled signal is amplified in the remote sampler and sent to the Model 1411A. It is stored and presented on the CRT as a dot of some particular amplitude. At the same time that the sample is taken, the staircase trigger is sent to the horizontal plug-in to advance the horizontal staircase one step, repositioning the dot horizontally.

4-18. During the period of presentation, signal feedback is sent to the remote sampler to charge the input capacitance to 100% of the sampled value. When the next sample is taken, only a change from the previous amplitude will be detected. If no change is detected, the previous amplitude level will be held for another sampling cycle.

4-19. BLOCK DIAGRAM DESCRIPTION.

4-20. The following explanation is referenced to Figure 8-1, detailed block diagram. Refer to the diagram while reading the applicable text. Since this explanation will pertain only to Channel A, only Channel A blocks and blocks common to both channels are shown in the diagram. Channel B theory is identical to that of Channel A.

4-21. Blocks common to both channels are the remote sampler, pulse generator and switching multivibrator. The basic function of each is described briefly in the following paragraphs.

4-22. REMOTE SAMPLER. The remote sampler is the device that actually performs the sampling. Contained within the sampler are the sampling diodes, sampling capacitors, emitter followers and preamplifiers for both A and B Channels. Operating voltages for the sampler are provided by the Model 1411A. Signal inputs (excluding the signal feed-throughs)

are Channels A and B inputs, signal feedback, and sampling pulses. The sampling pulses initiate the sampling process by gating the diodes on for a brief instant, permitting the sampling capacitors to start charging toward the signal level. The feedback is used between samples to charge the sampling capacitors the remaining 95% of the tested signal amplitude. The sampled signal is coupled through a differential emitter follower stage to a dc amplifier. The amplified sample is sent to the Model 1411A.

4-23. PULSE GENERATOR. Upon receipt of a sampling trigger from the horizontal plug-in, the pulse generator circuit of the Model 1411A generates three signals. The sampling trigger input is amplified and shaped, and sent to the remote sampler to gate the sampling diodes. The trigger is amplified and sent to the Channel A and B stretcher gate amplifiers as the stretcher pulse. This stretcher pulse is also sent to the switching multivibrator. The pulse generator provides the staircase generator trigger used in the horizontal plug-in.

4-24. SWITCHING MULTIVIBRATOR. The switching multivibrator controls the input to the main vertical amplifier stage (common to both A and B Channels). This is accomplished by applying bias to the switching diodes in A and B Channels. With the mode selector switch in A position, the diodes in A Channel are biased on and the diodes in B Channel are biased off. This allows Channel A signals to pass to the output stage and be presented on the CRT. With the mode selector switch to position B, the Channel A diodes are off and Channel B diodes are on, resulting in a display of Channel B signals. In the A+B mode, both Channel A and B switching diodes are biased on simultaneously; resulting in the summation of signals (algebraic addition). In the A & B mode, the diodes of Channels A and B are alternately biased on and off, resulting in a dual-trace display. In the A vs B mode, Channel A diodes are biased on and Channel B diodes are biased off. Channel A signals are sent to the output amplifier and the vertical deflection plates. Channel B signals are sent to the horizontal amplifier in the horizontal plug-in, resulting in an X-Y axis display.

4-25. AC AMPLIFIERS. When the sampled signal from the remote sampler reaches the Model 1411A, it is fed through a forward attenuator and sent to the

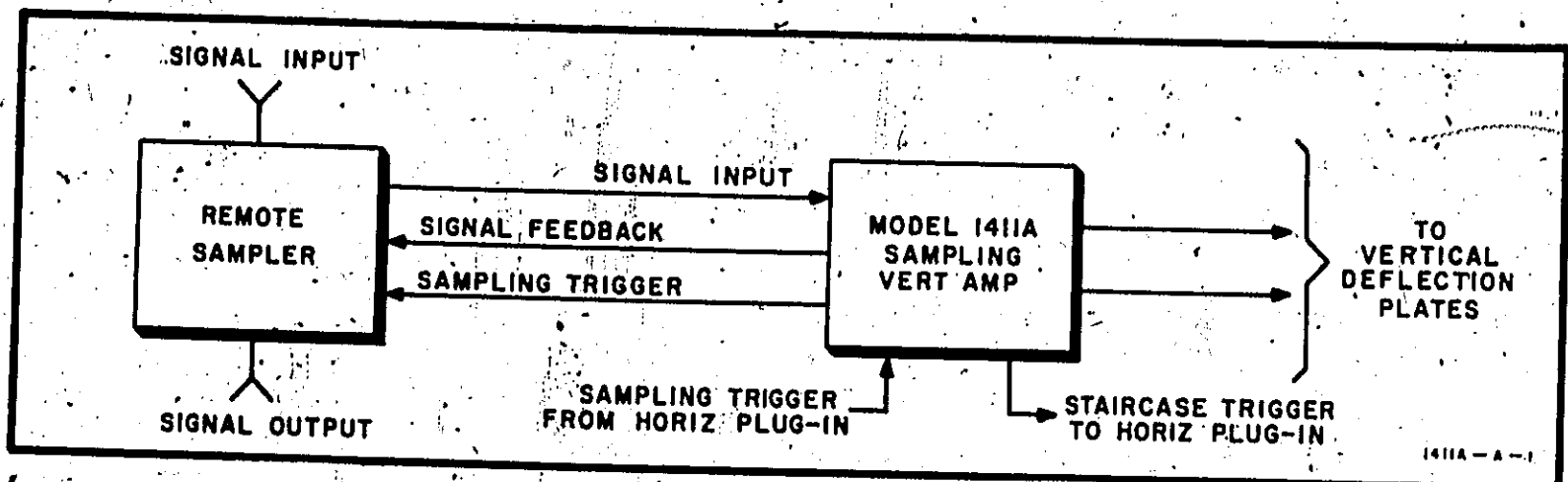

Figure 4-6. Model 1411A and Sampler

ac amplifiers. The sampled signal voltage is amplified and ac coupled to an emitter-follower stage.

4-26. STRETCHER GATE. The output signal from the emitter follower is ac coupled to the stretcher gate circuit. The stretcher gate receives two inputs (the signal input and the stretcher pulse from the pulse generator). The stretcher gate is turned on by the stretcher pulse at the same time that the sample is taken in the remote sampler, but the sample pulse keeps the stretcher gate on for a much longer period of time. This time interval is long enough for the voltage across the stretcher capacitor to charge to the full amount of the signal from the ac amplifier. When the stretcher pulse ends, the gate turns off. The stretcher capacitor has no discharge path so its voltage level remains essentially constant. The voltage level upon the stretcher capacitor represents the vertical signal amplitude and will determine the vertical displacement of the dot for this particular sampling period. Since the sampling rate (function of the horizontal plug-in) is adjustable between 50 Hz and 100 kHz, each sampling cycle is stretched between 10 μ sec and 20 ms.

4-27. DC AMPLIFIERS. The signal level placed on the stretcher capacitor is the input to the dc amplifiers. Output from the dc amplifiers is sent to the differential preamplifiers. The single-ended signal is converted to a differential signal.

4-28. Output of the dc amplifiers is also used for feedback purposes. Feedback is sent back through the emitter-follower stage to the ac-amplifier coupling capacitor. Feedback is also coupled through a reverse attenuator to the remote sampler to charge (or discharge) the sampling capacitor to 100% of the sampled signal level.

4-29. SWITCHING DIODES. The switching diodes determine which signal channel is connected to the main vertical amplifier. Bias on the diodes is controlled by the switching multivibrator (Paragraph 4-24). When the Channel A diodes are biased on, the Channel A signal is coupled to the main vertical amplifier.

4-30. MAIN VERTICAL AMPLIFIER. The output stage consists of differential current isolators, dual emitter followers, a differential amplifier and output current isolator. The differential signal, coupled through the current isolator and emitter follower stages, is amplified and sent through the output current isolator to the vertical deflection plates of the CRT.

4-31. The signal from the input current isolator is also sent to the record differential amplifier. The differential signal is converted to a single-ended signal and sent through an emitter follower to the RECORD output jack.

4-32. MODEL 1411A CIRCUIT DETAILS.

4-33. Circuit details are referenced to the schematics located in Section VIII.

4-34. PULSE GENERATOR.

4-35. The pulse generator (p/o Figure 8-5) provides the sampling pulses for the sampling diodes. Input

to the pulse generator is a positive trigger from the horizontal plug-in. The signal is amplified and inverted by Q110 and its negative collector signal is coupled to the base of Q108. Q108 is normally off. When the negative pulse is applied to its base, it begins to conduct. The positive-going signal at its collector appears on the base of Q109, causing it to start conducting also. The negative-going collector of Q109 appears on the base of Q108, causing it to conduct even harder. The net result of this regenerative (bootstrap) action is that Q108 turns on rapidly with its collector voltage rising from -27 volts to approximately 0 volt. This fast-rising positive pulse is coupled from the junction of C123 and R131 to the base of pulse amplifier Q111. The negative collector signal (stretcher pulse) is sent to the Channel A and B stretcher gate circuits, and to the switching multivibrator. It is also sent through C129 to the horizontal plug-in as the staircase generator trigger signal.

4-36. The positive pulse from Q108 is also coupled through C123 to J4 on the Model 1411A front panel. This pulse is sent to the remote sampler to initiate the sampling cycle.

4-37. AC AMPLIFIERS.

4-38. The sampled signal, coupled from the remote sampler, is sent to forward attenuator S101. The signal is attenuated on all ranges except the 1, 2, and 5 millivolt/cm ranges. The signal is applied to ac amplifier Q115 and Q116. Gain of this stage is variable between 6 and 60. The exact amount of gain is controlled by the front-panel SMOOTHING adjustment. The sampled signal change is again amplified and inverted by both Q115 and Q116 and the output is ac coupled through emitter follower Q117 to stretcher gate Q119.

4-39. STRETCHER GATE.

4-40. The stretcher gate, Q119 (normally off), is turned on by the stretcher pulse. The negative stretcher pulse from the pulse generator, amplified and inverted by Q125, results in a positive pulse being applied to the gate of Q119. This positive pulse turns on Q119 and allows stretcher capacitor C139 to start charging to the incoming signal level. Since the stretcher gate is held on for a relatively long period of time (250 nanoseconds), the stretcher capacitor has time to charge to the full amount of the input level.

4-41. When the stretcher pulse ends, Q119 turns off. Both Q119 and Q120 are FETs, offering high impedance. The stretcher capacitor has no discharge path and the potential placed on it will remain constant. The voltage stored on the stretcher capacitor acts as the input to the dc amplifiers.

4-42. DC AMPLIFIERS.

4-43. DC amplifiers Q120 and Q121 generate the output of the sampling loop. The feedback from Q121 collector, through R195 to Q120 source, maintains unity gain in this stage. The same voltage stored on the stretcher capacitor will appear on the collector of Q121. This voltage represents the output of the sampling loop.

4-44. SIGNAL FEEDBACK.

4-45. Feedback from from Q121 collector is applied to emitter followers Q117 and Q118 to charge ac amplifier coupling capacitor C137 to the new signal level. Feedback is also coupled through reverse attenuator S101 to the remote sampler to charge the sampling capacitor and diodes to 100% of the input signal amplitude.

4-46. DIFFERENTIAL AMPLIFIER.

4-47. The signal at Q121 collector is also coupled through S103 to differential amplifier Q123 and Q124. The polarity switch determines whether the signal will be presented as a positive-up or negative-up signal on the CRT. At this stage, the single-ended signal is converted to a differential signal. Gain is controlled by the sensitivity VERNIER and the CAL settings. Preamp balance adjust R205 is provided to balance the amplifier.

4-48. SWITCHING MULTIVIBRATOR.

4-49. The amplified differential signals from Q123 and Q124 collectors are sent to switching diodes CR501 through CR504. The switching multivibrator controls bias on diodes CR501 through CR508. By forward or reverse biasing these diodes, Channel A, B or combinations of both may be passed to input current isolators Q501 and Q502. With the mode selector switch set for Channel A presentation, diodes CR506 and CR507 are forward biased, reverse biasing CR505 and CR508 to block Channel B signals. In the same manner Channel A diodes CR502 and CR503 are reverse biased, keeping CR501 and CR504 forward biased and allowing Channel A signals to pass to the input current isolators. When the mode selector is in B position, the above biasing conditions are reversed, permitting Channel B signals to be displayed.

4-50. In the A+B mode, diodes CR502, CR503, CR506 and CR507 are all reverse biased, keeping CR501, CR504, CR505 and CR508 forward biased. This allows signals from both channels to be algebraically added. In the A&B mode, the negative stretcher pulse is applied to the base of trigger amplifier Q515. The positive collector signal of Q515 is used to trigger the switching multivibrator, alternately changing biasing conditions so that Channel A signals are displayed for one sampling cycle and Channel B signals are displayed on the next sampling cycle. In the A vs B mode, the Channel A diodes are biased on, and Channel B signals are routed through S501 to the horizontal plug-in for an X-Y display.

4-51. INPUT CURRENT ISOLATOR.

4-52. Depending on the mode of presentation selected, the appropriate signal or combination of signals is applied to the emitters of input current isolators Q501 and Q502. Since the preceding stages of Channel A and B each draw approximately 1 ma of current from

this stage, an additional current source is provided (+12.6V to junction of R501 and R502) to keep current through Q501 and Q502 constant when in the A+B mode, (both channels connected).

4-53. The signals at Q501/Q502 collectors are applied to the bases of emitter followers Q503/Q504.

4-54. EMITTER FOLLOWER.

4-55. Emitter followers Q503/Q504 couple the signal to differential amplifiers Q505/Q506. Differential signal difference can be greatly reduced by pressing the BEAM FINDER switch. This causes relay amplifier Q509 to conduct, energizing K501. When K501 energizes, it places R505 in parallel with resistor divider network R507 through R512. This greatly reduces the voltages applied to Q503/Q504 bases. The difference in deflection plate voltages become small enough to locate the trace regardless of signal amplitude or the setting of the VERT POS control.

4-56. OUTPUT CASCODE AMPLIFIER.

4-57. The emitter follower outputs are sent to differential amplifier Q505/Q506. The amplified and inverted signal is coupled to output current isolator Q507/Q508. Gain of this stage is calibrated with VERT CAL R524. Frequency adjust C506 is used to adjust high-frequency gain.

4-58. Y RECORD OUTPUT.

4-59. A portion of the signal voltage developed across resistor network R507 through R512 is applied to the bases of record differential amplifier Q510/Q511. Gain is controlled by front-panel Y AMPLITUDE adjustment R535. The single-ended output from Q510 collector is sent through emitter-follower Q512 to the front-panel Y RECORD jack. Y DC LEVEL R537 adjusts the dc level of the recorder output signal.

4-60. +12.6V POWER SUPPLY.

4-61. All required operating voltages are provided by the oscilloscope except for the +12.6V supply shown in Figure 8-13. The 6.3 Vac input is stepped-up, rectified, filtered and regulated. Sensor amplifier Q578 will sense any variation of output voltage and apply an error signal through Q575 to the base of series regulator Q576 to increase or decrease current, compensating for voltage fluctuations. Current limiter Q577 is normally biased off. If a short occurs across the output, the base of Q577 goes positive, turning Q577 on. The negative-going collector voltage coupled through Q575 to the base of the series regulator biases off Q576. The current that will flow through the external circuit is limited to the current required to keep Q577 on. Additional overload protection is provided by fuse F575. Potentiometer R80 adjusts the output for exactly +12.6V.

SECTION V

PERFORMANCE CHECK AND ADJUSTMENTS

5-1. INTRODUCTION.

5-2. This section includes adjustment procedures and a performance check. The performance check may be used as incoming inspection or after repairs or adjustments have been made to verify that the instrument meets the specifications listed in Table 1-1. When the initial performance check is made, record the indications in the enclosed Performance Check Record so that checks made at a later date can be compared to the original indications. If adjustment is required, refer to Paragraph 5-16.

5-3. PERFORMANCE CHECK.

5-4. TEST EQUIPMENT REQUIRED.

5-5. Test equipment recommended for the performance check and adjustments is listed in Table 5-1. Similar instruments having the listed characteristics may be substituted.

5-6. PROCEDURES:

5-7. Install the Model 1411A sampling time base combination in the oscilloscope and allow 10 minutes for warm-up. Perform the following checks and adjustments in the same sequence as they are listed since control settings are all referenced to prior settings.

CAUTION

Do not connect the remote sampler (1430A, 1431A, or 1432A) to the Model 1411A at this time.

5-8. POWER SUPPLY VOLTAGES:

5-9. Using a dc voltmeter, check the +82.5V and -82.5V supplies in the Model 1411A. These two supplies can vary $\pm 5\%$ from the stated amount, however the two voltages must be within 1-volt of each other (absolute values). Damage to the sampling diodes

Table 5-1. Recommended Test Equipment

Instrument		Characteristics	Ref Para	Required for
Type	Model			
DC Voltmeter	HP 412	100 Vdc 1%	5-9, 5-10 5-18	+82.5V Supply Check +12.6V Supply Adj
Variable Power Supply	HP Harrison 6111A	0.05V to 2V $\pm 0.01\%$ < 1 ohm output impedance	5-12 5-24	Attenuator Accuracy Check Sensitivity Calibration
Variable Pulse Generator	HP 222A	2V 50 kHz	5-13	Vernier Check
Fast Risetime Pulse Generator	HP 1105A/1106A	28 ps risetime	5-15 5-20 5-21	Recorder Output Check Stretcher Pulse Width Adj Stretcher Gain and Balance
High Frequency Oscilloscope	HP 180A HP 1801A HP 1821A	20 MHz	5-15 5-20	Recorder Output Check Stretcher Pulse Width Adj
10:1 Divider Probe	HP 10004A		5-20	Stretcher Pulse Width Adj

may occur if these voltages are out of tolerance. Check the +82.5-volt supply at the white-brown-gray lead (918) from the pulse generator and supply board. Check the -82.5-volt supply at the white-orange-green (935) lead. If the ±82.5-volt supplies are not within the specified tolerances and the ±100-volt supplies from the Model 140A are good, replace diodes VR101 and VR102 (matched pair).

5-10. Connect the voltmeter to the output of the +12.6-volt supply (positive lead of electrolytic capacitor C577 on main vertical amplifier board). Adjust R580 for +12.6 ±0.1V. Connect sampler to Model 1411A.

Note

If the Model 1411A and sampler have been purchased together, perform the VERT CAL adjustment (Figure 3-4, step 4) prior to the following checks.

If the Model 1411A and sampler have been purchased separately or if a different sampler is being used with the Model 1411A, perform the entire adjustment procedure described in this section prior to the following checks.

5-11. MODES OF OPERATION.

a. Set sampling time base controls as follows (if time base is a Model 1425A, settings will apply to MAIN SWEEP):

SYNC PULSE ON
TIME/CM 1 μSEC/CM
VERNIER CAL
MAGNIFIER XI
SCANNING NORMAL
Trigger MODE FREE RUN
Trigger SLOPE +
Trigger Source INT
Trigger Sensitivity SENS

b. Set Model 1411A controls as follows:

Channel A and B MILLIVOLTS 50
Channel A and B SMOOTHING NORM
(adjust for optimum response)
Channel A and B Polarity +UP
Model Selector A

c. Rotate Channel A VERT POS. Trace should move vertically.

d. Change mode selector to A + B. Both Channel A and B VERT POS controls should move trace vertically.

e. Set mode selector to A & B. Two traces should appear. Channel A VERT POS should move one trace vertically, and Channel B VERT POS should move the other trace.

f. Switch mode selector to Channel B. Channel B VERT POS should move trace vertically.

g. Switch mode selector to A vs B. Channel A VERT POS should move dot vertically and Channel B VERT POS should move dot horizontally.

5-12. ATTENUATOR ACCURACY.

a. Connect the HP Model 6111A Power Supply to Channel A INPUT of the remote sampler. Set mode selector to A.



If similar equipment is substituted for the HP Harrison 6111A Power Supply, it must have an extremely low output impedance (less than 1 ohm). If a power supply or voltmeter calibrator with a high output impedance is used, damage to the sampler and/or power supply may occur.

In substituted equipment, voltage transients may be present that exceed the maximum safe input of the sampler. These transients will occur between switch positions on the voltage or multiplier range switches. To avoid damage to the sampler, disconnect the input before changing voltage or multiplier settings.

b. Set Model 1411A MILLIVOLTS/CM and Power Supply outputs as outlined in Table 5-2 and check for indicated centimeters of deflection.

c. Repeat steps a and b for Channel B.

Table 5-2. Attenuator Accuracy

MILLIVOLTS/CM	Power Supply Output (volts)	Deflection
200	1	5 cm ±1.5 mm
100	1	10 cm ±3 mm
50	0.5	10 cm ±3 mm
20	0.2	10 cm ±3 mm
10	0.1	10 cm ±3 mm
5	.05	10 cm ±5 mm
2	.02	10 cm ±5 mm
1	.01	10 cm ±5 mm

5-13. VERNIER.

a. Set Channel A and B MILLIVOLTS/CM to 200.

b. Connect a variable Pulse Generator (Model 222A) to Channel A INPUT. Adjust amplitude for a 1-cm pulse at 10 kHz. Do not exceed 1V amplitude.

c. Rotate VERNIER fully cw. Pulse height should increase to at least 2.5 cm.

d. Repeat steps a, b, and c for Channel B.

e. Disconnect pulse generator.

5-14. NOISE.

a. Center trace on screen.

b. Switch Channel A MILLIVOLTS/CM through 200 to 5 ranges. With Models 1430A or 1431A Samplers, noise should be less than 7 mV; with Model 1432A, noise should be less than 3 mV.

c. Switch NORM-SMOOTHED to SMOOTHED and repeat step b. Noise should be less than 1/4 of that observed in NORM position.

d. Repeat steps a, b, and c for Channel B.

5-15. RECORDER OUTPUTS.

a. Connect variable Pulse Generator to Channel A probe, terminated in 50 ohms.

b. Connect trigger output from Pulse Generator to the external trigger input of the sampling time base plug-in. Set Trigger Source to EXT, Trigger SLOPE to -, and adjust Trigger LEVEL and Trigger MODE for stable display.

c. Connect the high-frequency oscilloscope to X RECORD output.

d. Adjust the X RECORD AMPLITUDE control over its range and check that the X output can be varied from 0.05 to 0.2 volt/cm approximately. Check that the DC LEVEL control will vary the X output level from -1.5 to +0.5 volts approximately.

e. Connect the high-frequency oscilloscope to Y RECORD output.

f. Adjust the Y RECORD AMPLITUDE control over its range and check that the Y output can be varied from 0.05 to 0.2 volt/cm approximately. Check that the DC LEVEL control will vary the Y output level from -1.5 to +0.5 volts approximately.

5-16. ADJUSTMENTS.

5-17. Calibration procedures for the Model 1411A are given in Paragraphs 5-18 through 5-24. To calibrate, remove the bottom cover of the oscilloscope and set the oscilloscope on its side. Check and adjust the power supply voltages in the oscilloscope mainframe. Calibrate the sampler with which the 1411A is to be used before making adjustments in the 1411A. Equipment required to perform the adjustments is listed in Table 5-1.

5-18. +12.6V SUPPLY.

5-19. Connect the DC Voltmeter to the output of the +12.6V supply (positive lead of electrolytic capacitor C577 on main amplifier board). Adjust R580 for $+12.6 \pm 0.1V$.

5-20. STRETCHER PULSE WIDTH ADJUST.

a. Connect a Fast Risettime Pulse Generator (HP Model 1105A/1106A) to sampler INPUT. If using a 1432A, use either a 1105A/1106A or Model 213B and isolate the pulse generator from the sampler input with 20 cm of air line. Free-run the Time Base and use the SYNC PULSE to trigger the pulse generator.

b. Adjust time base for a stable display. Set SCAN DENSITY to minimum. Using RESPONSE control, over-optimize the sampling efficiency (see Figure 5-1).

c. Adjust Stretcher Gate Width adj. R183 for maximum vertical separation of dots (over-optimized sampling efficiency).

d. Readjust RESPONSE for 100% sampling efficiency (see Figure 5-1).

5-21. STRETCHER GAIN AND BALANCE.

a. Set time base SCAN DENSITY fully clockwise, and other controls as described in Paragraph 5-20.

b. Switch SMOOTHED-NORM switch alternately between NORM and SMOOTHED. Adjust stretcher balance adjust R189 for no shift in display and stretcher gain adj R194 for no change in size. Make adjustments in SMOOTHED position using NORM for reference.

5-22. VERTICAL BALANCE.

a. Remove pulse generator input.

b. Set Channel A and B MILLIVOLTS/CM to 1.

c. Adjust baseline with VERT POS over CRT face and locate point where no trace shift occurs when polarity is changed from +UP to -UP.

d. Adjust preamp bal adj R205 until trace is centered. Check +UP and -UP for trace shift. If shift occurs, repeat steps c and d.

e. Change mode selector to Channel B and repeat Paragraphs 5-20, 5-21, and 5-22 for Channel B using stretcher pulse width adjust R383, stretcher balance adjust R389, stretcher gain adjust R394, and preamp bal adjust R405.

5-23. FREQUENCY RESPONSE.

a. Remove input.

b. Set mode selector to A & B.

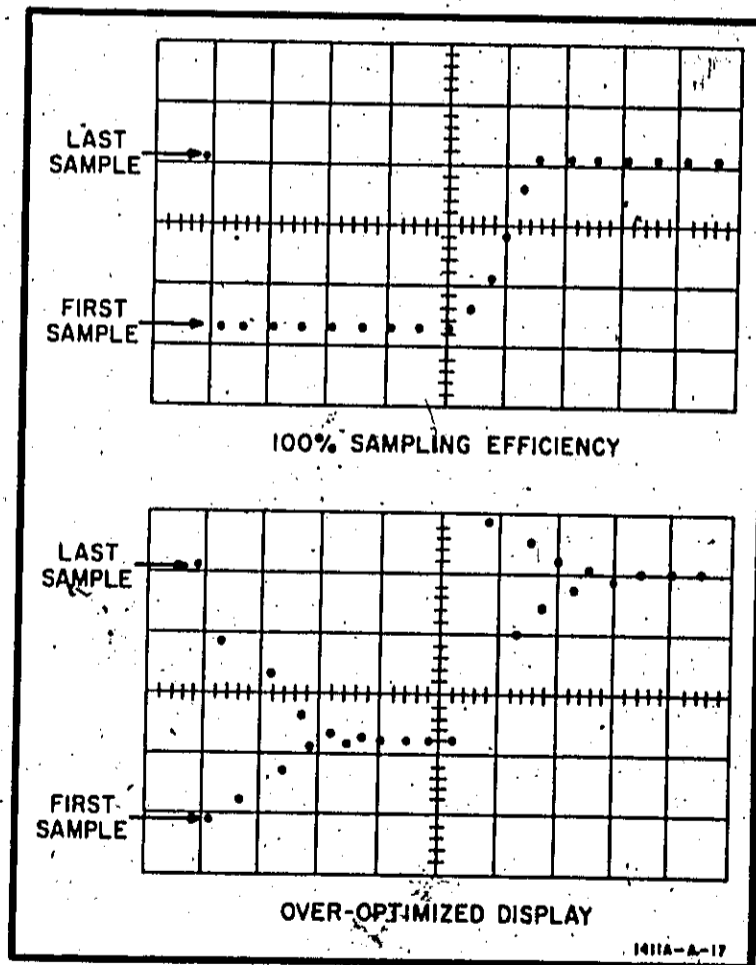

Figure 5-1. Sampling Efficiency

c. Set horizontal SCAN DENSITY to minimum. Using VERT. POS controls, position Channel A trace at top of CRT and Channel B trace at bottom of CRT. Adjust C504 to eliminate the tails on the dots. Reverse the trace positions and check to see that the tails have been eliminated.

5-24. SENSITIVITY CALIBRATION.

a. Remove the 50-ohm loads from sampler and perform the MILLIVOLTS/CM and VERT CAL adjustments to both channels as outlined in Figure 3-4.

b. Connect the variable Power Supply to the sampler Channel A INPUT.



If substitute equipment is used in place of the recommended HP Model 6111A, observe the precautions as previously outlined in Paragraph 5-12.

c. Connect a 1 μ F, 200V capacitor from each CRT vertical deflection plate to ground in the oscilloscope. Connect one capacitor to the green wire and other capacitor to the white wire on the CRT.

d. Set sensitivity to 1 MILLIVOLTS/CM and alternately connect and disconnect the power supply. Adjust stretcher gain R194 for exactly 10 cm of deflection.

e. Perform the MILLIVOLTS/CM CAL for Channel A, and repeat steps c through e until no interaction occurs between these two adjustments.

Note

If the gain from MILLIVOLTS/CM CAL is not correct for this adjustment, readjust VERT CAL. The VERT CAL potentiometer is located in the center of the mode switch and controls the gain of both channels.

f. Change mode selector to B and repeat steps c through e, adjusting Channel B stretcher gain adj R394.

g. Disconnect the capacitors which were connected in step c.

h. Check accuracy on all ranges for both Channel A and B, setting controls as indicated in Table 5-3.

Table 5-3. Sensitivity Calibration

MILLIVOLTS/CM	Power Supply Output	Deflection
100	1V	Adjust MILLI-VOLTS/CM CAL for 10 cm
200	1V	5 cm \pm 1.5 mm
50	0.5V	10 cm \pm 3 mm
20	0.2V	10 cm \pm 3 mm
10	0.1V	10 cm \pm 3 mm
1	.01V	Adjust R194 (R394) for 10 cm
.2	.02V	10 cm \pm 5 mm
5	.05V	10 cm \pm 5 mm

Model 1411A Performance Test Record
Instrument Serial Number _____

Ref Para	Check	Limit																												
5-8, 9, 10	POWER SUPPLY VOLTAGES	+82.5V _____ -82.5V _____ +12.6V _____																												
5-11	MODES OF OPERATION	A _____ A+B _____ A&B _____ B _____ A vs B _____																												
5-12	ATTENUATOR ACCURACY	<table border="1"> <thead> <tr> <th></th> <th>Channel A</th> <th>Channel B</th> </tr> </thead> <tbody> <tr> <td>200</td> <td>9.7 cm _____ 10.3 cm</td> <td>9.7 cm _____ 10.3 cm</td> </tr> <tr> <td>100</td> <td>9.7 cm _____ 10.3 cm</td> <td>9.7 cm _____ 10.3 cm</td> </tr> <tr> <td>50</td> <td>9.7 cm _____ 10.3 cm</td> <td>9.7 cm _____ 10.3 cm</td> </tr> <tr> <td>20</td> <td>9.7 cm _____ 10.3 cm</td> <td>9.7 cm _____ 10.3 cm</td> </tr> <tr> <td>10</td> <td>9.7 cm _____ 10.3 cm</td> <td>9.7 cm _____ 10.3 cm</td> </tr> <tr> <td>5</td> <td>9.5 cm _____ 10.5 cm</td> <td>9.5 cm _____ 10.5 cm</td> </tr> <tr> <td>2</td> <td>9.5 cm _____ 10.5 cm</td> <td>9.5 cm _____ 10.5 cm</td> </tr> <tr> <td>1</td> <td>9.5 cm _____ 10.5 cm</td> <td>9.5 cm _____ 10.5 cm</td> </tr> </tbody> </table>		Channel A	Channel B	200	9.7 cm _____ 10.3 cm	9.7 cm _____ 10.3 cm	100	9.7 cm _____ 10.3 cm	9.7 cm _____ 10.3 cm	50	9.7 cm _____ 10.3 cm	9.7 cm _____ 10.3 cm	20	9.7 cm _____ 10.3 cm	9.7 cm _____ 10.3 cm	10	9.7 cm _____ 10.3 cm	9.7 cm _____ 10.3 cm	5	9.5 cm _____ 10.5 cm	9.5 cm _____ 10.5 cm	2	9.5 cm _____ 10.5 cm	9.5 cm _____ 10.5 cm	1	9.5 cm _____ 10.5 cm	9.5 cm _____ 10.5 cm	
	Channel A	Channel B																												
200	9.7 cm _____ 10.3 cm	9.7 cm _____ 10.3 cm																												
100	9.7 cm _____ 10.3 cm	9.7 cm _____ 10.3 cm																												
50	9.7 cm _____ 10.3 cm	9.7 cm _____ 10.3 cm																												
20	9.7 cm _____ 10.3 cm	9.7 cm _____ 10.3 cm																												
10	9.7 cm _____ 10.3 cm	9.7 cm _____ 10.3 cm																												
5	9.5 cm _____ 10.5 cm	9.5 cm _____ 10.5 cm																												
2	9.5 cm _____ 10.5 cm	9.5 cm _____ 10.5 cm																												
1	9.5 cm _____ 10.5 cm	9.5 cm _____ 10.5 cm																												
5-13	VERNIER	>2.5 cm _____	>2.5 cm _____																											
5-14	NOISE	<table border="1"> <tbody> <tr> <td>1430A</td> <td><7 mV _____</td> <td><7 mV _____</td> </tr> <tr> <td>1431A</td> <td><7 mV _____</td> <td><7 mV _____</td> </tr> <tr> <td>1432A</td> <td><3 mV _____</td> <td><3 mV _____</td> </tr> </tbody> </table>	1430A	<7 mV _____	<7 mV _____	1431A	<7 mV _____	<7 mV _____	1432A	<3 mV _____	<3 mV _____																			
1430A	<7 mV _____	<7 mV _____																												
1431A	<7 mV _____	<7 mV _____																												
1432A	<3 mV _____	<3 mV _____																												
5-15	RECORDER OUTPUTS	_____																												

CUT ALONG DOTTED LINE

SECTION VI REPLACEABLE PARTS

6-1. INTRODUCTION.

6-2. This section contains information for ordering replacement parts. Table 6-2 lists the parts in alphabetical order by reference designation. All chassis-mounted parts (assemblies, and parts not mounted on assemblies) appear first, followed by each assembly with sub-assemblies (if any) and components mounted on that assembly. Reference designations for groups of identical items may be shown as TP1 through TP9 followed by a single part number and description indicating that TP1 through TP9 are separate but identical parts.

6-3. Parts consisting of several smaller, yet separately replaceable parts such as relays or jacks have all sub-parts listed so that partial replacement of these items can be accomplished. Miscellaneous parts which are not assigned reference designations appear at the end of the chassis parts listing and at the end of each assembly listing.

6-4. ORDERING INFORMATION.

6-5. Many parts used in Hewlett-Packard equipment are manufactured by HP or are selected by HP under

specifications more rigid than the manufacturer's standard specifications. These parts must be ordered directly from Hewlett-Packard Company. Information concerning standard replaceable parts will be supplied upon request to allow procurement directly from the manufacturers. Contact the local HP Sales/Service Office for details.

6-6. To obtain replacement parts from HP, address order or inquiry to the nearest Hewlett-Packard Sales/Service Office (names and addresses in rear of manual), and supply the following information:

- a. HP Part Number of item(s).
- b. Model number and eight-digit serial number of instrument.
- c. Quantity of part(s) desired.

6-7. To order a part not listed in the table, provide the following information:

- a. Model number and eight-digit serial number of the instrument.
- b. Description of the part including function and location in the instrument.

Table 6-1. Reference Designators And Abbreviations

REFERENCE DESIGNATORS							
A	= assembly	F	= fuse	M	= meter	TB	= terminal board
B	= motor	FL	= filter	MP	= mechanical part	TP	= test point
C	= capacitor	H	= hardware	P	= plug	V	= vacuum tube, neon bulb, photocell, etc.
CP	= coupling	IC	= integrated circuit	Q	= transistor	VR	= voltage regulator (diode)
CR	= diode	J	= jack	R	= resistor	W	= cable
DL	= delay line	K	= relay	RT	= thermistor	X	= socket
DS	= device signaling (lamp)	L	= inductor	S	= switch	Y	= crystal
E	= misc. electronic part	LS	= speaker	T	= transformer		

ABBREVIATIONS							
amp	= amperes	gl	= glass	mtg	= mounting	rf	= radio frequency
ampl	= amplifier	grd	= ground(ed)	ny	= nylon	s-b	= slow-blow
bp	= bandpass	H	= henries	n	= nano (10 ⁻⁹)	Se	= selenium
car	= carbon	hg	= mercury	n/c	= normally closed	sect	= section(s)
ccw	= counter-clockwise	hr	= hour(s)	nc	= neon	semicon	= semiconductor
cer	= ceramic	HP	= Hewlett-Packard	n/o	= normally open	Si	= silicon
coef	= coefficient	if	= intermediate freq.	npo	= negative positive zero (zero temperature coefficient)	sil	= silver
com	= common	imp	= impregnated	nsr	= not separately replaceable	sl	= slide
comp	= composition	incd	= incandescent	obd	= order by description	spl	= special
conn	= connector	incl	= include(s)	ox	= oxide	Ta	= tantalum
crt	= cathode-ray tube	ins	= insulation(ed)	pc	= printed circuit	td	= time delay
cw	= clockwise	int	= internal	pf	= picofarads = 10 ⁻¹² farads	tgl	= toggle
depc	= deposited carbon	k	= kilo (10 ³)	piv	= peak inverse voltage	Ti	= titanium
elect	= electrolytic	lin	= linear taper	p/o	= part of	tol	= tolerance
encap	= encapsulated	log	= logarithmic taper	porc	= porcelain	trim	= trimmer
ext	= external	lpf	= low pass filter	pos	= position(s)	u	= micro (10 ⁻⁶)
F	= farads	m	= milli (10 ⁻³)	pk-pk	= peak-to-peak	var	= variable
fet	= field effect transistor	meg	= mega (10 ⁶)	rect	= rectifier	w	= watts
fxd	= fixed	metfilm	= metal film			w/	= with
Ge	= germanium	met ox	= metal oxide			w/o	= without
		mfr	= manufacturer			wvdc	= dc working volts
		minat	= miniature			ww	= wirewound
		mom	= momentary				

Table 6-2. Replaceable Parts

Ref Desig	HP Part No.	TQ	Description (Refer to Table 6-1.)
A104	01411-66501	1	A: supply board
A105	01410-66505	1	A: stretcher board (see Note below)
A106	01411-63401	2	A: attenuator switch, channel A
A107	01411-63401		A: attenuator switch, channel B
A501	01410-66506	1	A: vertical amp
C120	0180-0091	2	C: fxd elect 10 μ F 100vdcw
C121	0180-0091		C: fxd elect 10 μ F 100vdcw
C122	0180-0161	1	C: fxd ta 3.3 μ F 20% 35vdcw
C123	0140-0197	1	C: fxd mica 180 pF 5% 500vdcw
C124	0140-0178	1	C: fxd mica 560 pF 2% 300vdcw
C125	0160-0051	3	C: fxd cer 100 pF 600vdcw
C126	0160-0161	5	C: fxd my 0.01 μ F 10%
C127	0160-0161		C: fxd my 0.01 μ F 10%
C128	0150-0051		C: fxd cer 100 pF 600vdcw
C129	0150-0051		C: fxd cer 100 pF 600vdcw
C130	0180-0155	8	C: fxd ta 2.2 μ F 20% 200vdcw
C131	0180-0155		C: fxd ta 2.2 μ F 20% 200vdcw
C132	0180-0155		C: fxd ta 2.2 μ F 20% 200vdcw
C133	0160-0161		C: fxd my 0.01 μ F 10%
C134	0180-1735	3	C: fxd ta 0.22 μ F 35vdcw
C135	0160-0153	2	C: fxd my 1000 pF 10%
C137	0160-0407	6	C: fxd mica 1000 pF 5% 300 vdcw
C138	0180-0155		C: fxd ta 2.2 μ F 20% 200vdcw
C139	0140-0200		C: fxd mica 390 pF 5% 300vdcw
C141	0140-0200		C: fxd mica 390 pF 5% 300vdcw
C331	0180-0155		C: fxd ta 2.2 μ F 20% 200vdcw
C332	0180-0155		C: fxd ta 2.2 μ F 20% 200vdcw
C333	0160-0161		C: fxd my 0.01 μ F 10%
C334	0180-1735		C: fxd ta 0.22 μ F 35vdcw
C335	0160-0153		C: fxd my 1000 pF 10%
C337	0160-0407		C: fxd mica 1000 pF 5% 300vdcw
C338	0180-0155		C: fxd ta 2.2 μ F 20% 200vdcw
C339	0140-0200		C: fxd mica 390 pF 5% 300vdcw
C341	0140-0200		C: fxd mica 390 pF 5% 300vdcw
C501	0140-0194	2	C: fxd mica 110 pF 5% 300vdcw
C502	0140-0194		C: fxd mica 110 pF 5% 300vdcw
C503	0140-0199	1	C: fxd mica 240 pF 5% 300vdcw
C504	0130-0016	1	C: var cer 5 - 25 pF npo

Note

A105 stretcher board, HP Part No. 01410-66505 is common to both the HP Model 1410A and HP Model 1411A. If this board is replaced on the Model 1411A, R201 and R401 (shown in Figure 8-8) must be removed.

Table 6-2. Replaceable Parts (Cont'd)

Ref. Desig	HP Part No.	TQ	Description (Refer to Table 6-1.)
C506	0180-1735	2	C: fxd ta 0.22 μ F 35vdcw
C507	0140-0193		C: fxd mica 82 pF 5% 300vdcw
C508	0140-0193		C: fxd mica 82 pF 5% 300vdcw
C509	0140-0191		C: fxd mica 56 pF 5% 300vdcw
C510	0180-0155		C: fxd ta 2.2 μ F 20% 20vdcw
C575	0180-1783	1	C: fxd al elect 1000 μ F -10 +75% 35vdcw
C576	0160-0161	1	C: fxd my 0.01 μ F 10%
C577	0180-0097		C: fxd elect 47 μ F 10% 35vdcw
C580	0150-0052	28	C: fxd cer 0.05 μ F 20% 400vdcw
CR109	1901-0040		CR: sl
CR110	1901-0040		CR: sl
CR112	1901-0040		CR: sl
CR113	1901-0040		CR: sl
CR114	1901-0040		CR: sl
CR115	1901-0040		CR: sl
CR116	1901-0040		CR: sl
CR118	1901-0040		CR: sl
CR119	1901-0040		CR: sl
CR120	1901-0040		CR: sl
CR316	1901-0040	CR: sl	
CR318	1901-0040	CR: sl	
CR319	1901-0040	CR: sl	
CR320	1901-0040	CR: sl	
CR501	1901-0040	CR: sl	
CR502	1901-0040	CR: sl	
CR503	1901-0040	CR: sl	
CR504	1901-0040	CR: sl	
CR505	1901-0040	CR: sl	
CR506	1901-0040	CR: sl	
CR507	1901-0040	CR: sl	
CR508	1901-0040	CR: sl	
CR510	1901-0040	CR: sl	
CR511	1901-0040	CR: sl	
CR512	1901-0040	CR: sl	
CR575	1901-0026	4	CR: sl
CR576	1901-0026		CR: sl
CR577	1901-0026		CR: sl
CR578	1901-0026		CR: sl
CR579	1901-0040		CR: sl
F575	2110-0033	1	F: 3/4 amp 250V

Table 6-2. Replaceable Parts (Cont'd)

Ref Deslg	HP Part No.	TQ	Description (Refer to Table 6-1.)
J4	1251-1444	1	J: 18 contact
J501	1250-0118	2	J: rf BNC bulkhead mount
J602	1250-0118		J: rf BNC bulkhead mount
K501	0490-0191	1	L: relay coil
	0490-0189	1	S: relay reed
P1	1251-0055	1	P: panel plug, 24 contact
P3	1251-1285	1	P: panel plug, 12 contact, 5 coaxial
Q108	1853-0010	5	Q: si pnp
Q109	1854-0035	1	Q: si npn
Q110	1854-0019	5	Q: si npn
Q111	1854-0071	11	Q: si npn 2N3391
Q115	1853-0020	6	Q: si pnp
Q116	1854-0071		Q: si npn
Q117	1853-0010		Q: si pnp
Q118	1854-0019		Q: si npn
Q119	1855-0022	9	Q: si
Q120	1855-0022		Q: si
Q121	1853-0020		Q: si pnp
Q123	1854-0071		Q: si npn 2N3391
Q124	1854-0071		Q: si npn 2N3391
Q125	1853-0020	2	Q: si pnp
Q315	1853-0020		Q: si pnp
Q316	1854-0071		Q: si npn
Q317	1853-0010		Q: si pnp
Q318	1854-0019		Q: si pnp
Q319	1855-0022		Q: si
Q320	1855-0022		Q: si
Q321	1853-0020		Q: si pnp
Q323	1854-0071		Q: si npn 2N3391
Q324	1854-0071		Q: si npn 2N3391
Q325	1853-0020		Q: si pnp
Q501	1854-0071		Q: si npn 2N3391
Q502	1854-0071		Q: si npn 2N3391
Q503	1854-0022		Q: si npn
Q504	1854-0022		Q: si npn
Q505	1854-0022		Q: si npn
Q506	1854-0022		Q: si npn
Q507	1854-0232		Q: si npn
Q508	1854-0232		Q: si npn
Q509	1854-0071		Q: si npn 2N3391
Q510	1853-0020		Q: si pnp

Table 6-2. Replaceable Parts (Cont'd)

Ref. Desig	HP Part No.	TQ	Description (Refer to Table 6-1.)
Q511	1853-0020		Q: si pnp
Q512	1854-0022		Q: si pnp
Q513	1853-0010		Q: si pnp
Q514	1853-0010		Q: si pnp
Q575	1854-0039	1	Q: si 2N3053
Q576	1854-0084	1	Q: si npn 2N3232
Q577	1854-0039		Q: si 2N3053
Q578	1854-0071		Q: si npn 2N3391
R103	0757-0458		R: fxd metflm 51.1k ohms 1% 1/8W
R104	0757-0458		R: fxd metflm 51.1k ohms 1% 1/8W
R105	2100-1943	3	R: var comp 5k & 100k ohms 20% lin (includes R210)
R106	2100-1943		R: var comp 5k & 100k ohms 20% lin (includes R210)
R110	0758-0010	2	R: fxd met ox 3300 ohms 5% 1/2W
R111	0758-0010		R: fxd met ox 3300 ohms 5% 1/2W
R113	0757-0419	6	R: fxd metflm 681 ohms 1% 1/8W
R114	0757-0408	6	R: fxd metflm 243 ohms 1% 1/8W
R115	0757-0419		R: fxd metflm 681 ohms 1% 1/8W
R116	0757-0415		R: fxd metflm 475 ohms 1% 1/8W
R120	0757-0463	2	R: fxd metflm 82k ohms 1% 1/8W
R121	2100-0820	2	R: var ww 50k ohms 3% lin 2W
R122	0757-1108	4	R: fxd metflm 300 ohms 1% 1/8W
R123	0757-1102	2	R: fxd metflm 180 ohms 1% 1/8W
R124	0757-1104	2	R: fxd metflm 60 ohms 1% 1/8W
R125	0757-1107	8	R: fxd metflm 30 ohms 1% 1/8W
R126	0757-1107		R: fxd metflm 30 ohms 1% 1/8W
R131	0757-0401	2	R: fxd metflm 100 ohms 1% 1/8W
R132	0757-0280	11	R: fxd metflm 1k ohms 1% 1/8W
R133	0757-0416	9	R: fxd metflm 511 ohms 1% 1/8W
R134	0757-0394	1	R: fxd metflm 51.1 ohms 1% 1/8W
R135	0757-0190	3	R: fxd metflm 20k ohms 1% 1/2W
R136	0757-0843	2	R: fxd metflm 15k ohms 1% 1/2W
R137	0757-0843		R: fxd metflm 15k ohms 1% 1/2W
R138	0757-0442	11	R: fxd metflm 10k ohms 1% 1/8W
R139	0683-0475	1	R: fxd comp 4.7 ohms 5% 1/4W
R140	0757-0283	3	R: fxd metflm 2k ohms 1% 1/8W
R145	0757-0408		R: fxd metflm 243 ohms 1% 1/8W
R146	0757-0419		R: fxd metflm 681 ohms 1% 1/8W
R147	0757-0415		R: fxd metflm 475 ohms 1% 1/8W
R148	0757-0419		R: fxd metflm 681 ohms 1% 1/8W
R149	0757-0280		R: fxd metflm 1k ohms 1% 1/8W

Table 6-2. Replaceable Parts (Cont'd)

Ref Desig	HP Part No.	TQ	Description (Refer to Table 6-1.)
R150 R151	0757-0463 2100-0820		R: fxd metflm 82k ohms 1% 1/8W R: var ww 50k ohms 32% 1W
R156 R158 R157 R158 R159	0757-1108 0757-1102 0757-1104 0757-1107 0757-1107		R: fxd metflm 300 ohms 1% 1/8W R: fxd metflm 180 ohms 1% 1/8W R: fxd metflm 60 ohms 1% 1/8W R: fxd metflm 30 ohms 1% 1/8W R: fxd metflm 30 ohms 1% 1/8W
R170 R171 R172 R173 R174	0757-0410 0757-0410 0757-0430 0757-0451 0757-0280	5 2 2	R: fxd metflm 301 ohms 1% 1/8W R: fxd metflm 301 ohms 1% 1/8W R: fxd metflm 2.21k ohms 1% 1/8W R: fxd metflm 24.3k ohms 1% 1/8W R: fxd metflm 1k ohms 1% 1/8W
R175 R176	0757-0419 0757-0428	2	R: fxd metflm 681 ohms 1% 1/8W R: fxd metflm 1.62k ohms 1% 1/8W
R178 R179 R180 R181 R182	0757-0415 0757-0417 0757-0283 0757-0442 0757-0442	2	R: fxd metflm 475 ohms 1% 1/8W R: fxd metflm 562 ohms 1% 1/8W R: fxd metflm 2k ohms 1% 1/8W R: fxd metflm 10k ohms 1% 1/8W R: fxd metflm 10k ohms 1% 1/8W
R183 R184 R185 R186	2100-1773 0757-0422 0757-0280 0757-0435	2	R: var ww 1k ohms 10% 1/2W R: fxd metflm 909 ohms 1% 1/8W R: fxd metflm 1k ohms 1% 1/8W R: fxd metflm 3.92k ohms 1% 1/8W
R188 R189 R190	0757-0341 2100-0944 0757-0178	2 2	R: fxd metflm 30.1k ohms 1% 1/4W R: var metflm 200k ohms 5% R: fxd metflm 100 ohms 1% 1/8W
R193 R194 R195	0757-0442 2100-0944 0757-0280	3	R: fxd metflm 10k ohms 1% 1/8W R: var metflm 200k ohms 5% R: fxd metflm 1k ohms 1% 1/8W
R197 R198 R199 R200 R201	0757-0190 0757-0416 0757-0416 0757-0416	2	R: fxd metflm 20k ohms 1% 1/8W R: fxd metflm 511 ohms 1% 1/8W R: fxd metflm 511 ohms 1% 1/8W R: fxd metflm 511 ohms 1% 1/8W R: factory selected value
R202 R203 R204 R205 R206	2100-2115 2100-1715 0757-0464 2100-1777 0757-0464	2 2 4 2	R: var car. comp 5k ohms 1/2W R: var comp 2k ohms 20% 1/2W R: fxd metflm 90.9k ohms 1% 1/8W R: var ww 20k ohms 10% 1/2W R: fxd metflm 90.9k ohms 1% 1/8W
R209 R210 R211	0757-0405 0757-0438	2	R: fxd metflm 162 ohms 1% 1/8W NSR: p/o R105 R: fxd metflm 5.11k ohms 1% 1/8W

Table 6-2. Replaceable Parts (Cont'd)

Ref Desig	HP Part No.	TQ	Description (Refer to Table 6-1.)
R212	0757-1094	2	R: fxd metflm 1.47k ohms 1% 1/8W
R213	0757-1107		R: fxd metflm 30 ohms 1% 1/8W
R214	0757-1095	2	R: fxd metflm 1.44k ohms 1% 1/8W
R215	0757-1107		R: fxd metflm 30 ohms 1% 1/8W
R216	0757-1096	2	R: fxd metflm 1.36k ohms 1% 1/8W
R217	0757-1103	2	R: fxd metflm 90 ohms 1% 1/8W
R218	0757-1097	2	R: fxd metflm 1.2k ohms 1% 1/8W
R219	0757-0284	1	R: fxd metflm 150 ohms 1% 1/8W
R220	0757-1098	2	R: fxd metflm 945 ohms 1% 1/8W
R221	0757-1108		R: fxd metflm 300 ohms 1% 1/8W
R222	0757-1101	2	R: fxd metflm 360 ohms 1% 1/8W
R223	0757-1099	2	R: fxd metflm 900 ohms 1% 1/8W
R224	0757-0427	4	R: fxd metflm 1.5k ohms 1% 1/8W
R225	0757-0427		R: fxd metflm 1.5k ohms 1% 1/8W
R226	0757-1093	2	R: fxd metflm 3k ohms 1% 1/8W
R370	0757-0410		R: fxd metflm 301 ohms 1% 1/8W
R371	0757-0410		R: fxd metflm 301 ohms 1% 1/8W
R372	0757-0430		R: fxd metflm 2.21k ohms 1% 1/8W
R373	0757-0451		R: fxd metflm 24.3k ohms 1% 1/8W
R374	0757-0280		R: fxd metflm 1k ohms 1% 1/8W
R375	0757-0419		R: fxd metflm 681 ohms 1% 1/8W
R376	0757-0428		R: fxd metflm 1.62k ohms 1% 1/8W
R378	0757-0415		R: fxd metflm 475 ohms 1% 1/8W
R379	0757-0417		R: fxd metflm 562 ohms 1% 1/8W
R380	0757-0283		R: fxd metflm 2k ohms 1% 1/8W
R381	0757-0442		R: fxd metflm 10k ohms 1% 1/8W
R382	0757-0442		R: fxd metflm 10k ohms 1% 1/8W
R383	2100-1773		R: var ww 1k ohms 10% 1/2W
R384	0757-0422		R: fxd metflm 909 ohms 1% 1/8W
R386	0757-0435		R: fxd metflm 3.92k ohms 1% 1/8W
R388	0757-0341		R: fxd metflm 30.1k ohms 1% 1/4W
R389	2100-0944		R: var metflm 200k ohms 5%
R390	0757-0178		R: fxd metflm 100 ohms 1% 1/8W
R393	0757-0442		R: fxd metflm 10k ohms 1% 1/8W
R394	2100-0944		R: var metflm 200k ohms 5%
R395	0757-0280		R: fxd metflm 1k ohms 1% 1/8W
R396	0757-0283		R: fxd metflm 2k ohms 1% 1/8W
R397	0757-0190		R: fxd metflm 20k ohms 1% 1/8W
R398	0757-0416		R: fxd metflm 511 ohms 1% 1/8W
R399	0757-0416		R: fxd metflm 511 ohms 1% 1/8W
R400	0757-0416		R: fxd metflm 511 ohms 1% 1/8W
R401			R: factory selected value
R402	2100-2115		R: var car. comp 5k ohms 1/2W
R403	2100-1715		R: var comp 2k ohms 20% 1/2W
R404	0757-0464		R: fxd metflm 90.9k ohms 1% 1/8W
R405	2100-1777		R: var ww 20k ohms 10% 1/2W
R406	0757-0464		R: fxd metflm 90.9k ohms 1% 1/8W

Table 6-2. Replaceable Parts (Cont'd)

Ref Desig	HP Part No.	TQ	Description (Refer to Table 6-1.)
R409	0757-0405		R: fxd metflm 162 ohms 1% 1/8W
R410			NSR: p/o R106
R411	0757-0438		R: fxd metflm 5.11k ohms 1% 1/8W
R412	0757-1094		R: fxd metflm 1.47k ohms 1% 1/8W
R413	0757-1107		R: fxd metflm 30 ohms 1% 1/8W
R414	0757-1095		R: fxd metflm 1.44k ohms 1% 1/8W
R415	0757-1107		R: fxd metflm 30 ohms 1% 1/8W
R416	0757-1096	1	R: fxd metflm 1.36k ohms 1% 1/8W
R417	0757-1103		R: fxd metflm 90 ohms 1% 1/8W
R418	0757-1097		R: fxd metflm 1.2k ohms 1% 1/8W
R419	0757-0284	1	R: fxd metflm 150 ohms 1% 1/8W
R420	0757-1098		R: fxd metflm 945 ohms 1% 1/8W
R421	0757-1108		R: fxd metflm 300 ohms 1% 1/8W
R422	0757-1101		R: fxd metflm 360 ohms 1% 1/8W
R423	0757-1099		R: fxd metflm 900 ohms 1% 1/8W
R424	0757-0427		R: fxd metflm 1.5k ohms 1% 1/8W
R425	0757-0427		R: fxd metflm 1.5k ohms 1% 1/8W
R426	0757-1093		R: fxd metflm 3k ohms 1% 1/8W
R501	0757-0440	3	R: fxd metflm 7.5k ohms 1% 1/8W
R502	0757-0440		R: fxd metflm 7.5k ohms 1% 1/8W
R503	0757-0421	1	R: fxd metflm 825 ohms 1% 1/8W
R504	0757-0280		R: fxd metflm 1k ohms 1% 1/8W
R505	0757-0438	1	R: fxd metflm 5.11k ohms 1% 1/8W
R506	0757-0410		R: fxd metflm 301 ohms 1% 1/8W
R507	0757-0762	2	R: fxd metflm 24.3k ohms 1% 1/4W
R508	0757-0445	2	R: fxd metflm 13k ohms 1% 1/8W
R509	0757-0433	3	R: fxd metflm 3.32k ohms 1% 1/8W
R510	0757-0433		R: fxd metflm 3.32k ohms 1% 1/8W
R511	0757-0445		R: fxd metflm 13k ohms 1% 1/8W
R512	0757-0762		R: fxd metflm 24.3k ohms 1% 1/4W
R513	0757-0444	2	R: fxd metflm 12.1k ohms 1% 1/8W
R514	0757-0444		R: fxd metflm 12.1k ohms 1% 1/8W
R517	0757-0749	4	R: fxd metflm 6.19k ohms 1% 1/4W
R518	0757-0749		R: fxd metflm 6.19k ohms 1% 1/4W
R519	0757-0433		R: fxd metflm 3.32k ohms 1% 1/8W
R520	0757-0749		R: fxd metflm 6.19k ohms 1% 1/8W
R521	0757-0749		R: fxd metflm 6.19k ohms 1% 1/8W
R522	0757-0416		R: fxd metflm 511 ohms 1% 1/8W
R523	0757-0280		R: fxd metflm 1k ohms 1% 1/8W
R524	2100-1716	1	R: var wy 5k ohms 5% 1.5W
R525	0757-0416		R: fxd metflm 511 ohms 1% 1/8W
R528	0757-0845	2	R: fxd metflm 18.2k ohms 1% 1/2W
R529	0757-0845		R: fxd metflm 18.2k ohms 1% 1/2W
R531	0757-0461	1	R: fxd metflm 68.1k ohms 1% 1/8W

Table 6-2. Replaceable Parts (Cont'd)

Ref Desig	HP Part No.	TQ	Description (Refer to Table 6-1.)
R532	0757-0479	1	R: fxd metflm 392k ohms 1% 1/8W
R533	0757-0775	2	R: fxd metflm 90.9k ohms 1% 1/4W
R534	0757-0442		R: fxd metflm 10k ohms 1% 1/8W
R535	2100-1734	2	R: var comp 20k ohms 10% 1/2W
R536	0757-0775		R: fxd metflm 90.9k ohms 1% 1/4W
R537	2100-1717	2	R: var comp 50k ohms 20% 1/2 W
R538	0757-0465	3	R: fxd metflm 100k ohms 1% 1/8 W
R539	0757-0440		R: fxd metflm 7.5k ohms 1% 1/8 W
R540	0757-0159	1	R: fxd metflm 1k ohms 1% 1/2 W
R541	0757-0416	1	R: fxd metflm 511 ohms 1% 1/8 W
R545	0757-0422		R: fxd metflm 909 ohms 1% 1/8 W
R546	0757-0281		R: fxd metflm 2.74k ohms 1% 1/8W
R547	0757-0454	2	R: fxd metflm 33.2k ohms 1% 1/8W
R548	0757-0280		R: fxd metflm 1k ohms 1% 1/8W
R549	0757-0280		R: fxd metflm 1k ohms 1% 1/8W
R550	0757-0454		R: fxd metflm 33.2k ohms 1% 1/8W
R551	0757-0281		R: fxd metflm 2.74k ohms 1% 1/8W
R552	0757-0458	2	R: fxd metflm 51.1k ohms 1% 1/8W
R553	0757-0458		R: fxd metflm 51.1k ohms 1% 1/8W
R555	0757-0281		R: fxd metflm 2.74k ohms 1% 1/8W
R556	0757-0281		R: fxd metflm 2.74k ohms 1% 1/8W
R557	0757-0281		R: fxd metflm 2.74k ohms 1% 1/8W
R575	0811-0929	1	R: fxd ww 0.51 ohms 5% 2 W
R576	0757-0401		R: fxd metflm 100 ohms 1% 1/8 W
R577	0757-0465		R: fxd metflm 100k ohms 1% 1/8W
R578	0757-0480	1	R: fxd metflm 432k ohms 1% 1/8W
R579	0757-0447	1	R: fxd metflm 16.2k ohms 1% 1/8W
R580	2100-1774	1	R: var ww 2k ohms 10% 1/2 W
R581	0757-0465		R: fxd metflm 100k ohms 1% 1/8 W
R582	0757-0449		R: fxd metflm 20k ohms 1% 1/8W
R585	2100-1734		R: var comp 20k ohms 10% 1/2 W
R586	2100-1717		R: var comp 50k ohms 20% 1/2 W
S101			NSR: p/o A106
S102	3101-0199	4	S: slide
S103	3101-0199		S: slide
S301			NSR: p/o A107
S302	3101-0199		S: slide
S303	3101-0199		S: slide
S501	01410-61901	1	S: function selector, includes CR512 and R524
T575	9100-1104	1	T: power

Table 6-2. Replaceable Parts (Cont'd)

Ref Desig	HP Part No.	TQ	Description (Refer to Table 6-1.)
VR101 } VR102 } VR103 } VR104 } VR105 }	5080-0456 1902-0578 1902-0578 1902-0590	1 2 2	VR: avalance 82.5V matched pair VR: avalanche 27.4V 5% 1W VR: avalanche 27.4V 5% 1W VR: avalanche 4.42V 5% 1W
VR305	1902-0590		VR: avalanche 4.42V 5% 1W
VR501 VR502 VR503	1902-0199 1902-0199 1902-3356	2 2 1	VR: avalanche 10V 8.8% VR: avalanche 10V 8.8% VR: si avalanche 56V 10% 400mW
MISCELLANEOUS			
	0370-0099 0370-0134 0370-0308 0370-0309 0370-0310	2 2 1 2 2	Knob: sensititivity Knob: vernier Knob: mode Knob: smoothing Knob: vert pos
	0510-0054 01410-00101 01410-00203 01410-23701 01410-23702	2 1 1 2 1	Ring: grip Deck Panel: rear Rod: lower support Rail: upper right
	01410-23703 01410-64901 01411-00201 01411-00202 01411-61608	1 1 1 1 1	Rail: upper left Handle: assy Panel: front Panel: sub Main cable assy

SECTION VII MANUAL CHANGES AND OPTIONS

7-1. MANUAL CHANGES.

7-2. This manual applies directly to the standard Model 1411A Sampling Vertical Amplifier having a serial prefix as listed on the manual title page. The following paragraphs provide instructions for modifying this manual to cover older or newer instruments. Refer to the separate Manual Changes sheet supplied with this manual for Errata.

7-3. OLDER INSTRUMENTS:

7-4. Table 7-1 contains information on changes required to adapt this manual to an older instrument (lower serial prefix number). Check Table 7-1 for the applicable instrument serial prefix and make the changes indicated. Note that these changes adapt the manual to cover a particular instrument as manufactured and do not apply to an instrument subsequently modified in the field.

Table 7-1. Manual Changes

Serial Prefixed	Make Changes
735-	1
724-	2
705-	1, 3
616-	1, 3, 4

7-5. NEWER INSTRUMENTS.

7-6. As changes are made in the Model 1411A, newer instruments may have serial prefixes higher than listed on the manual title page. The manual for these newer instruments will be supplied with a Manual Changes sheet which contains all necessary updating information. If the serial prefix of a particular instrument is higher than the one listed at the front of this manual and no Manual Changes sheet has been provided, contact the nearest Hewlett-Packard Sales/Service Office.

7-7. OPTIONS.

7-8. Options for an HP instrument are standard modifications installed at the factory. At the present time, no options are offered for the Model 1411A.

7-9. SPECIAL INSTRUMENTS.

7-10. Modified versions (per customer's specifications) of any HP instrument are available on special order. The manual for these special instruments (having electrical modifications) will include a separate insert sheet that describes the modification and any special manual changes in addition to the Manual Changes sheet (if applicable). Contact the nearest HP Sales/Service Office if either of these sheets is missing from the manual of a special instrument. Be sure to

refer to the instrument by its full specification name and number.

CHANGE 1

Section VI, Replaceable Parts,
Q318: Change to HP Part No. 1853-0019.
Cable Assy: Change to HP Part No. 01411-61601.
Delete: R396.
Page 8-9, Figure 8-12,
Delete R396 and connection from +12.6V supply.

CHANGE 2

Section VI, Replaceable Parts,
Q318: Change to HP Part No. 1853-0019.
Cable Assy: Change to HP Part No. 01411-61601.
Delete: R396.
R179 and R379: Change to HP Part No. 0757-0411;
R: fxd metflm 332 ohms 1% 1/8W.
R178 and R378: Change to HP Part No. 0757-0419;
R: fxd metflm 681 ohms 1% 1/8W.
R114 and R145: Change to HP Part No. 0757-0415;
R: fxd metflm 243 ohms 1% 1/8W.
Page 8-5, Figure 8-5,
R114 and R145: Change value to 475 ohms.
Page 8-7, Figure 8-9,
R178: Change value to 681 ohms.
R179: Change value to 332 ohms.
Page 8-9, Figure 8-12,
R378: Change value to 681 ohms.
R379: Change value to 332 ohms.
Delete R396 and connection from +12.6V supply.

CHANGE 3

Section VI, Replaceable Parts,
Add: R112 and R141, HP Part No. 0757-0442; R:
fxd metflm 10k ohms 1% 1/8W.
R114 and R145: Change to HP Part No. 0757-0415;
R: fxd metflm 243 ohms 1% 1/8W.
Q503 and Q504: Change to HP Part No. 1854-0071;
Q: si npn 2N3391.
Page 8-5, Figure 8-5,
Add: R112 10k ohms between pin B and the junction
of diodes CR109 and CR110.
Add: R141 10k ohms between pin D and the junction
of diodes CR114 and CR115.
R114 and R145: Change value to 475 ohms.

CHANGE 4

Section VI, Replaceable Parts,
Delete: C580.
Page 8-8, Figure 8-10,
Delete: C580.

SECTION VIII SCHEMATICS AND TROUBLESHOOTING

8-1. INTRODUCTION

8-2. This section contains schematic diagrams, information regarding repair and replacement, component identification, and troubleshooting tips. Table 8-1 provides general schematic notes, defining the symbols and conventions used on the schematics.

8-3. COMPONENT IDENTIFICATION.

8-4. Components located on etched circuit boards are identified in photos adjacent to the applicable schematic except for the Channel B stretcher circuit. Channel B stretcher components are identified on the same photo as Channel A stretcher components. Components located on the chassis are identified in Figure 8-6 and 8-7. Adjustment location is shown in Figure 8-2.

8-5. REPAIR AND REPLACEMENT.

8-6. Most all electrical components are accessible for replacement from the component side of the etched circuit board. Section VI provides a detailed parts list to allow ordering of replacement parts. Mechanical and miscellaneous parts are listed at the end of the table. If satisfactory repair or operation cannot be accomplished, contact the nearest Hewlett-Packard Sales/Service Office (addresses at rear of this manual). If shipment for repair is recommended, refer to Section II for recommended repackaging information.

8-7. SERVICING ETCHED CIRCUIT BOARDS.

8-8. The Model 1411A has etched circuit boards which are plated-through type. When servicing this type of board, components may be removed or replaced by unsoldering from either side of the board. When replacing large components, such as potentiometers, rotate the soldering iron tip from lead to lead while applying pressure to the part to lift it from the board. HP Service Note M-20D contains additional information on the repair of the etched circuit boards. The important considerations are as follows:

- a. Do not apply excessive heat.
- b. Apply heat to component lead and remove lead with a straight pull from the board.
- c. Use a toothpick or wooden splinter to clean holes.
- d. Do not force leads of replacement component into holes.

8-9. If the plated metal surface (conductor) lifts from the board, it may be cemented back with a quick-drying acetate base cement (use sparingly) having good insulating properties. An alternate method of repair is to solder a good conducting wire along the damaged area.

8-10. REPLACING REED RELAY.

8-11. The reed relay consists of two separately-replaceable parts, the coil and the reed. To replace the reed:

- a. Unsolder both reed leads from the circuit board.
- b. Bend one end of one lead so it can be removed from the opposite end of the coil.



Hold the lead of the reed with long-nosed pliers when bending the lead. Bend only the flexible lead to avoid cracking glass capsule.

- c. Remove the reed.
- d. Insert the new reed through coil.
- e. Using long-nosed pliers, bend the reed leads to fit into the circuit board holes.
- f. Solder reed leads into place.

8-12. To replace a coil:

- a. Remove the reed according to the above procedure.
- b. Unsolder and remove the coil.
- c. Replace and resolder the coil.
- d. Replace the reed.

8-13. TROUBLESHOOTING.

8-14. The first and most important prerequisite for successful troubleshooting is an understanding of how the instrument is designed to operate and correct usage of front-panel controls. Often, suspected malfunctions are simply caused by improper control settings or circuit hook-ups such as: low intensity, maladjusted horizontal trigger level or mode, sampler output not terminated into 50 ohms, mode selector in wrong position, etc. Section III (Operation), including explanation of controls and connectors and general operating considerations and Section IV (Principles of Operation) which explains circuit theory, are intended to satisfy this information requirement.

8-15. The following paragraphs outline procedures for locating and clearing problems in the Model 1411A and sampler. Since the Model 1411A and the sampler function as one system, troubleshooting tips will include both instruments.

8-16. DC voltages are indicated on the schematics for most active components (transistors, FET's, etc.). Typical waveform test points (Δ with a number enclosed) are also placed on the schematics at various points along main signal paths. The numbers inside the test point symbols are keyed to a corresponding waveform adjacent to the schematic. These voltages and waveforms provide an invaluable aid when troubleshooting the instrument. Applications include: checking gain of a particular stage, locating a differential amplifier unbalance, or pinpointing a faulty transistor, etc. When using these voltages and/or waveforms

Section VIII
Paragraphs 8-17 to 8-25

Model 1411A

for troubleshooting, always refer to the specific conditions outlined for the measurements, also listed adjacent to the schematics.

8-17. If trouble is suspected, first perform a visual inspection of the instrument. Look for loose or burned components that might suggest a source of trouble. If no obvious trouble is found, check the power supply voltages in the oscilloscope main chassis. Refer to the oscilloscope manual for specific voltages and tolerances. In addition to the voltages provided by the oscilloscope, the Model 1411A provides both a +82.5 and -82.5-volt supply and a regulated +12.6-volt supply. Prior to any extensive troubleshooting, check these supplies. The ± 82.5 -volt supplies provide the bias voltages for the sampling diodes. If these voltages are out of the $\pm 1V$ tolerance, (refer to Section V) the sampler will not operate correctly. If all voltages are correct, refer to the following paragraphs for the indicated trouble.

8-18. NO VERTICAL DISPLAY, EITHER CHANNEL. Trouble of this nature is most likely caused by some function that is common to both channels; such as the pulse generator, switching multivibrator or main vertical amplifier. First check to see that the positive sampling trigger from the horizontal plug-in is present at the base of Q110. This pulse initiates the entire vertical sampling process and if the time base has malfunctioned, the vertical system may also be inoperative. If this pulse is present, check the pulse generator, etc., using the typical waveforms and dc voltages.

8-19. NO DISPLAY, ONE CHANNEL. First, determine that the sampler is operating (refer to sampler manual). Apply a square wave from a pulse generator, as outlined in the Conditions for Typical Waveforms, to the defective channel and monitor signal from sampler, through each successive stage until the malfunction is found. Also check the switching multivibrator and switching diodes.

8-20. LOW AMPLIFIER GAIN. When over-all amplifier gain is too low to be properly adjusted with the MILLIVOLTS/CM or VERT CAL controls, the typical waveforms can be used to trace the problem. By checking the relative gain of each stage, the faulty stage can usually be found. Also check for a faulty attenuator switch.

8-21. TRACE OFF SCREEN. Change mode switch and input signal to the opposite channel. If the problem

still exists, the trouble is most likely an unbalanced condition in the main vertical amplifier. The stage that is unbalanced can be identified by shorting together like elements in both halves of a stage (emitter-to-emitter, etc.). The stage that causes the trace to return on-screen, when common elements are shorted, is the one with the faulty component. DC voltage and/or resistance checks can be used to positively identify the faulty part.

8-22. MODE SWITCHING. If the proper mode of operation cannot be obtained, check the switching diodes CR501 through CR508 and CR510 through CR512. If these diodes are good, check the switching multivibrator Q513 and Q514 and associated circuitry. If the problem arises only in the A & B mode, check trigger amplifier Q515 and its input, the stretcher pulse from Q111.

8-23. EXCESSIVE NOISE. If the noise amplitude varies with settings of the MILLIVOLTS/CM switch, trouble is most likely within the sampler. Check the sampling diodes and diode bias (refer to sampler manual). If noise does not vary with sensitivity settings, the problem is probably in the stretcher loop.

8-24. DISTORTION. Signal distortion can be caused by several things; faulty sampling diodes, improper diode bias, low frequency compensation adjustments set wrong, faulty stretcher loop or signal level exceeding dynamic range of sampler.

8-25. TROUBLESHOOTING THE STRETCHER LOOP. Problems such as low gain, distortion, no display, etc., will usually be caused either by the sampler or the stretcher loop in the Model 1411A. To check the stretcher loop; check the stretcher pulse width at Q125 collector. If the pulse is not $0.3 \mu\text{sec}$ wide, adjust R183 in accordance with the procedures outlined in Section V. Next locate R180 on the circuit board and ground the end that is common to the MILLIVOLTS/CM switch. On the circuit board, this is the end of R180 closest to the rear of the instrument. Also connect the gate of Q120 to ground. Set controls as outlined in the DC Voltage Measurement Conditions adjacent to the schematic and check the dc voltages. If the voltages are correct (within $\pm 15\%$), the problem is most likely in the remote sampler. To check the sampler, refer to the sampler manual.

Table 8-1. Schematic Notes

Refer to MIL-STB-15-1A for schematic symbols not listed in this table.

Unless otherwise indicated:
 capacitance in picofarads
 inductance in microhenries
 resistance in ohms

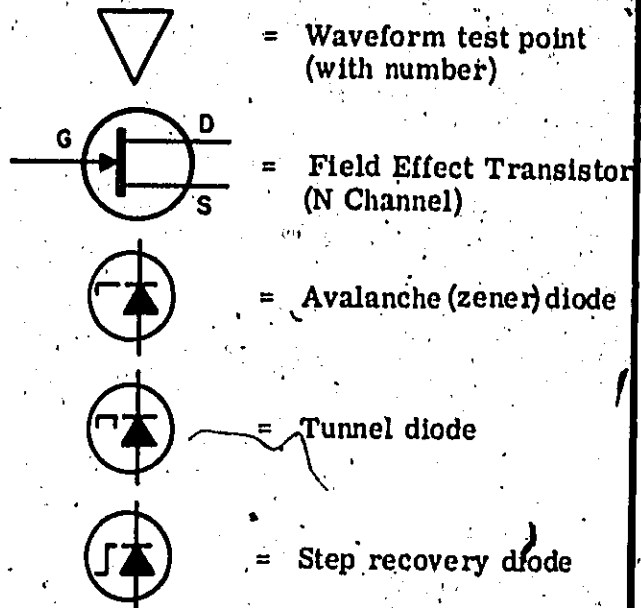
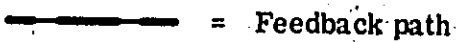
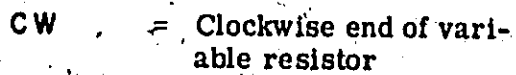
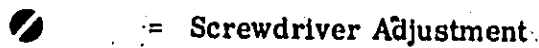
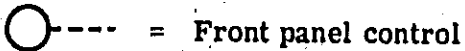
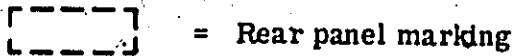
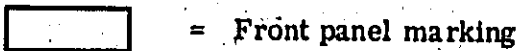
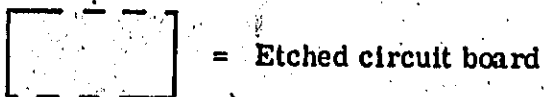

Numbers in parentheses indicate wire color using resistor color code, e. g. WHT-RED-GRN is (9-2-5).

- | | |
|------------|------------|
| 0 - Black | 5 - Green |
| 1 - Brown | 6 - Blue |
| 2 - Red | 7 - Violet |
| 3 - Orange | 8 - Gray |
| 4 - Yellow | 9 - White |

P/O = Part of

* = Optimum value selected at factory, average value shown; part may have been omitted.

N.C. = No connection

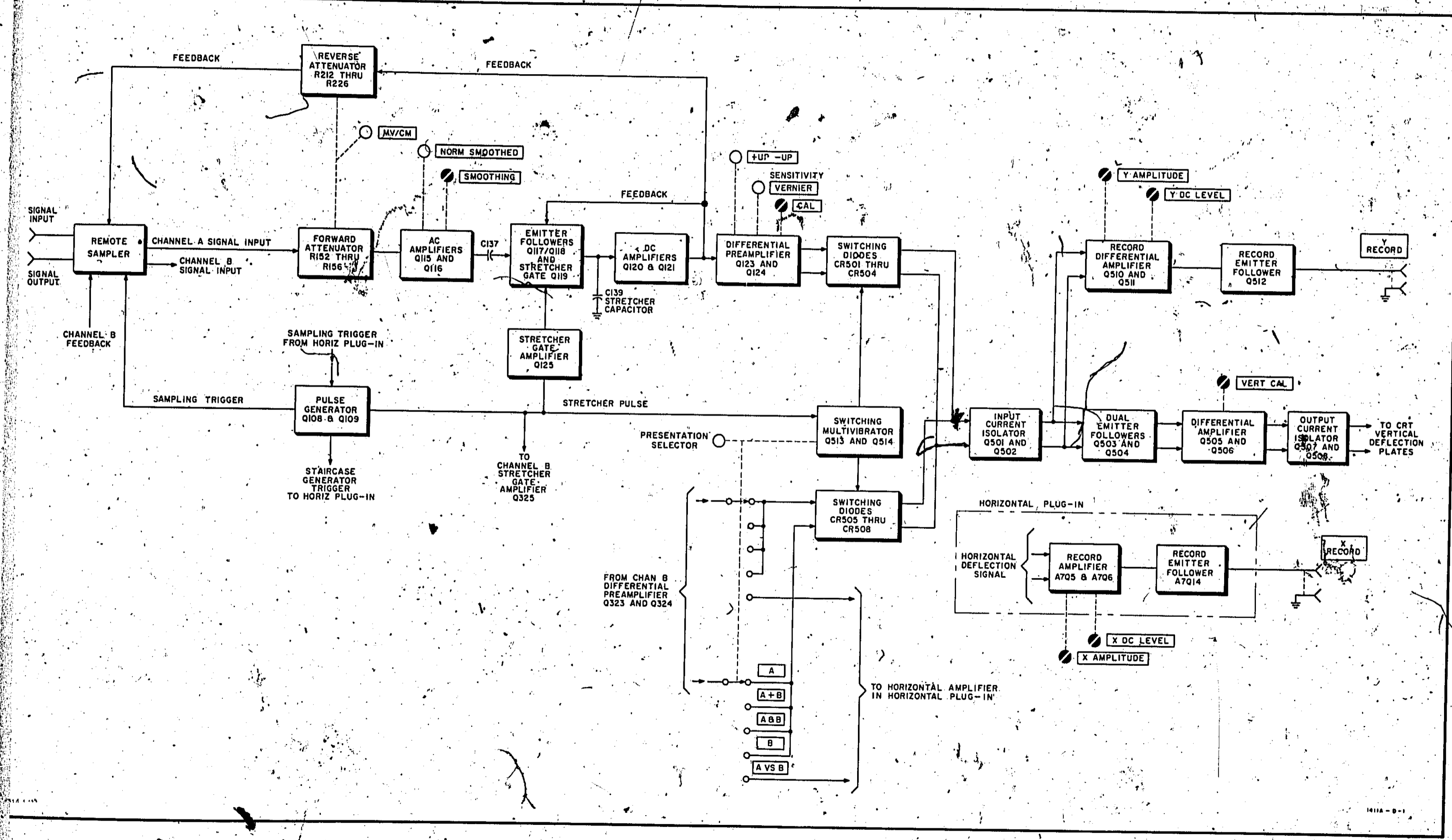

Figure 8-1. Detailed Block Diagram

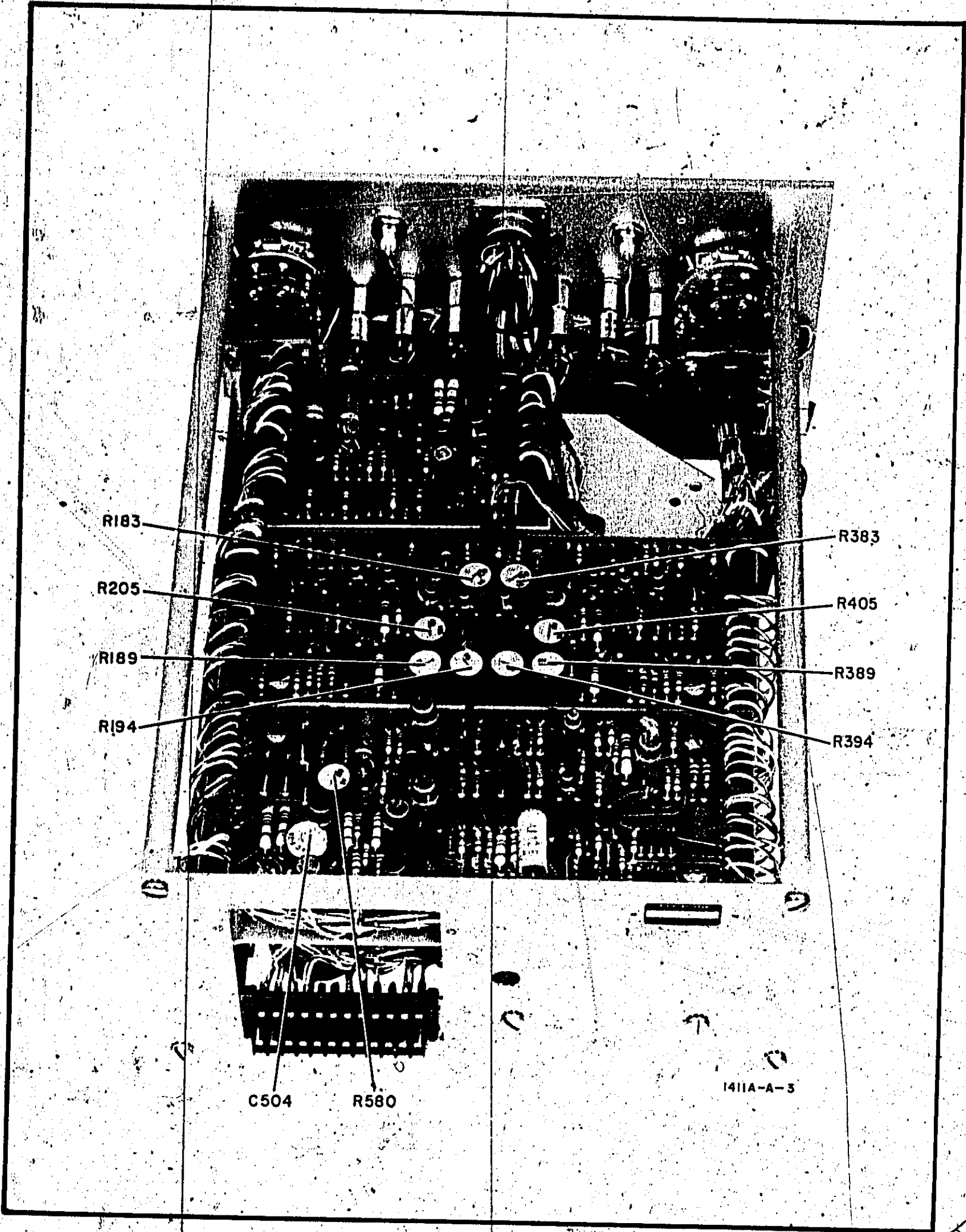
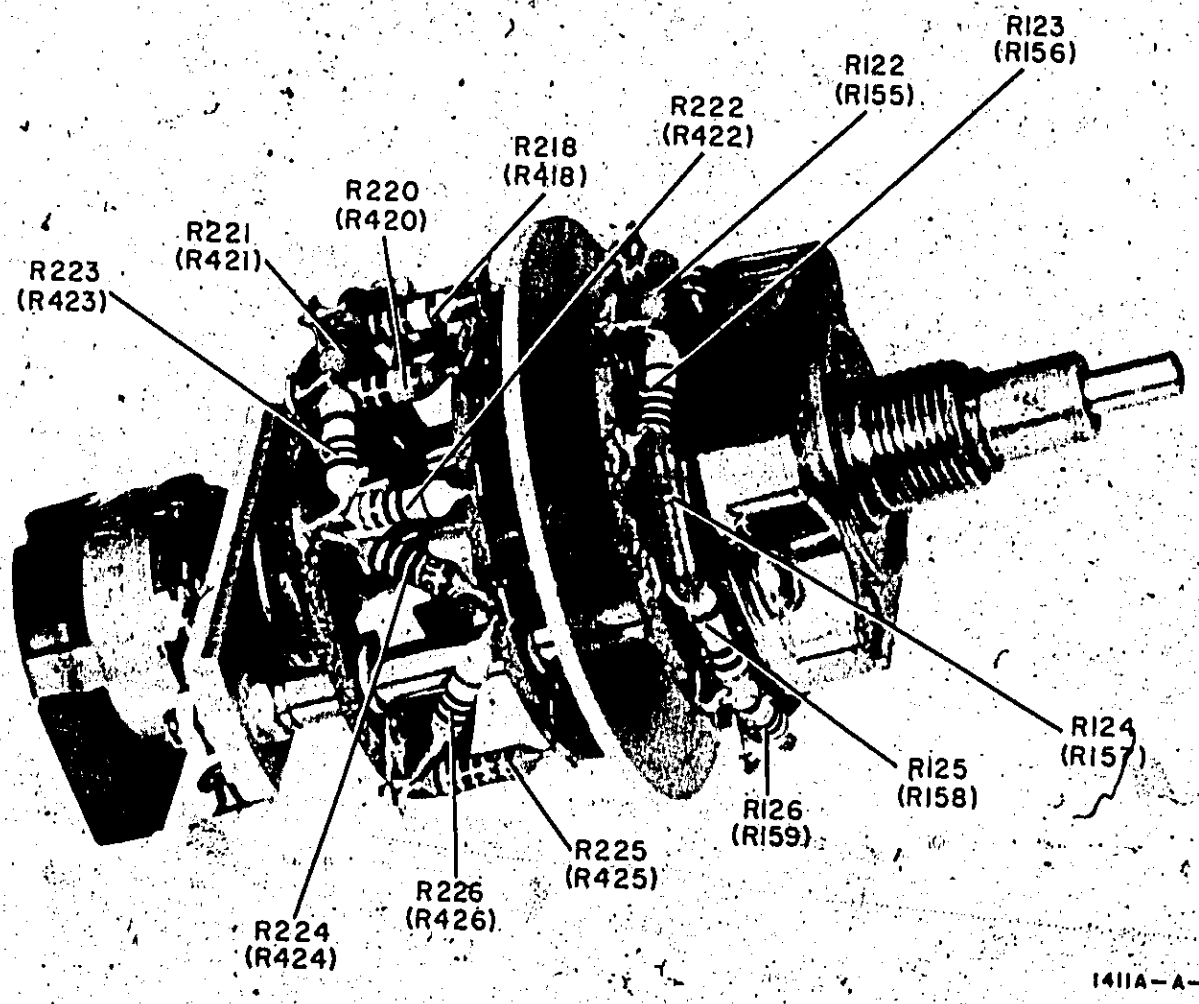
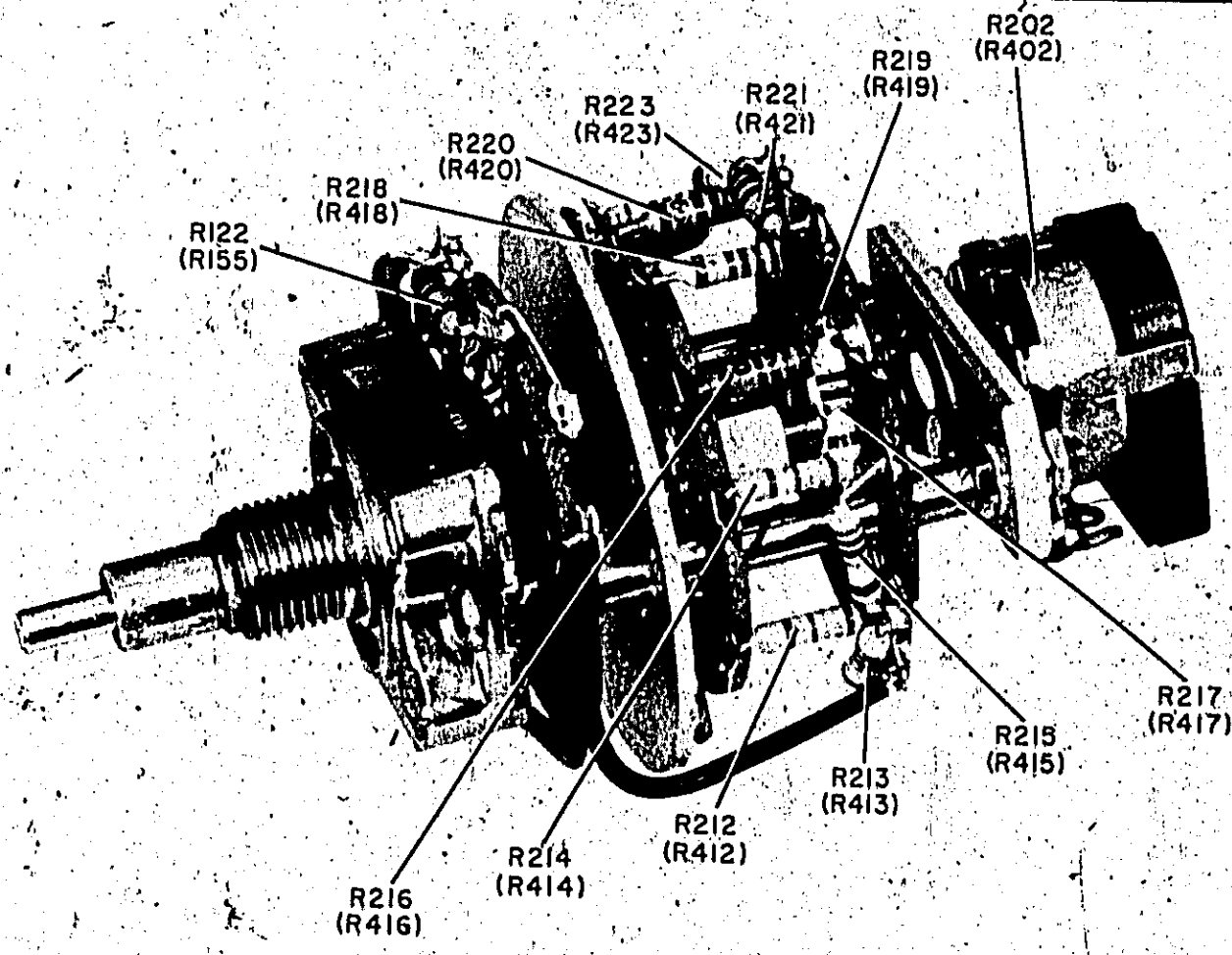
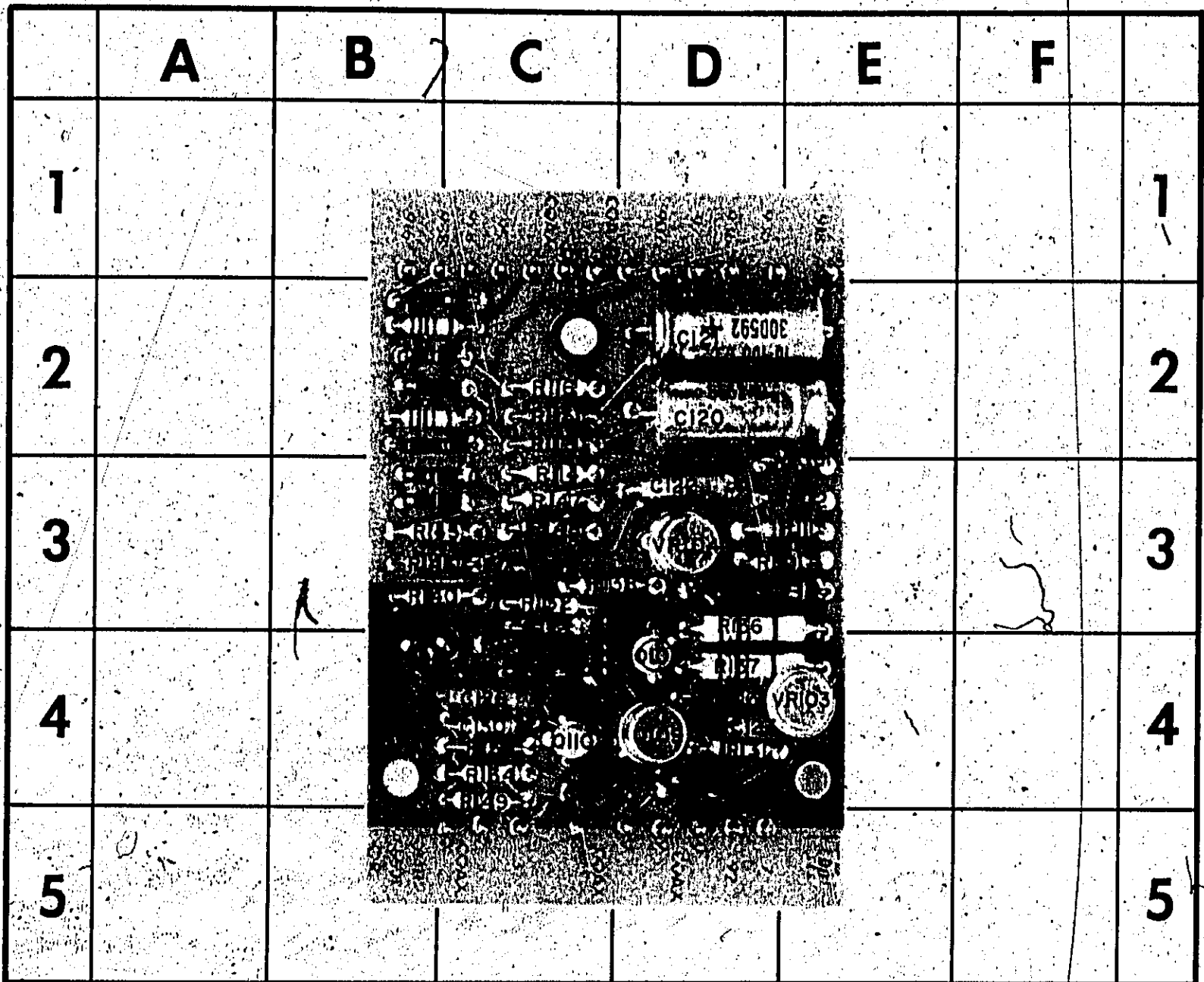

Figure 8-2. Location of Adjustments



1411A-A-6

Figure 8-3: Component Identification, Millivolts/cm Switch



REF DESIG	GRID LOC	REF DESIG	GRID LOC	REF DESIG	GRID LOC	REF DESIG	GRID LOC	REF DESIG	GRID LOC	REF DESIG	GRID LOC	REF DESIG	GRID LOC	REF DESIG	GRID LOC
C120	D-2	C127	D-4	CR113	D-4	Q111	B-4	R115	C-2	R134	C-4	R140	B-3	R149	C-4
C121	D-2	C128	C-3	CR114	B-3	R110	D-3	R116	C-2	R135	D-3	R145	B-3	R150	B-2
C122	D-3	C129	C-4	CR115	B-3	R111	E-3	R120	B-2	R136	D-3	R146	B-3	VR101	E-2
C123	D-4	C130	C-4	Q108	D-4	R113	C-2	R131	D-4	R137	D-4	R147	C-3	VR102	E-3
C124	C-4	CR109	B-2	Q109	D-4	R114	C-3	R132	C-3	R138	C-3	R148	C-3	VR103	E-4
C125	C-4	CR110	B-2	Q110	C-4			R138	C-4	R139	C-4			VR104	D-3
C126	C-4	CR112	C-3												

1411A-A-9A

Figure 8-4. Component Identification, A104 Assembly.

DC VOLTAGE MEASUREMENT CONDITIONS

- a. Connect sampler to Model 1411A.
- b. Set both the MODE and LEVEL controls of time base plug-in to 12 o'clock and disconnect all external trigger signals.
- c. DC voltages may vary slightly from one instrument to another (up to 15% is permissible). All voltages are referenced to ground.

WAVEFORM MEASUREMENT CONDITIONS

- a. Connect a 10 kHz square wave at 0.5 pk-pk to channel A INPUT of sampler; terminated with a 50-ohm load. Use the pulse generator trigger output to externally trigger the time base.
- b. Set time base controls as follows:
- | | |
|----------------------------|-----------------|
| LEVEL | 12 o'clock |
| MODE | 12 o'clock |
| MAGNIFIER | X1 |
| SCAN DENSITY | fully ccw |
| TRIGGER HOLD-OFF | NORMAL |
| TIME/CM | 10 μ SEC/CM |
| Trigger SLOPE | - |
| Trigger Source | EXT |
| SCANNING | NORMAL |
| NORM-SENS | SENS |
| SWEEP | MAIN |
- c. Set Model 1411A controls as follows:
- | | |
|------------------------------|--------------------------|
| Mode Selector | A |
| both MILLIVOLTS/CM | 100 |
| both VERNIER | CAL |
| both VERT. POS | pulse or trace centered. |
| both NORM-SMOOTHED | NORM |
| both RESPONSE | optimized |
| both SMOOTHING | optimized |
- d. Waveforms were observed on an HP Model 180A Oscilloscope with Model 1801A and 1820A plug-ins.

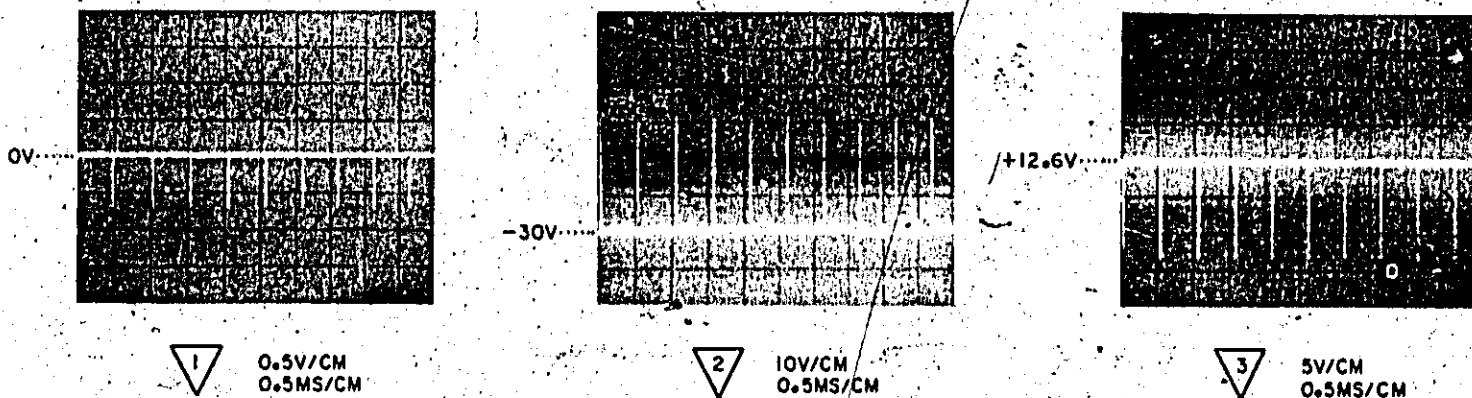

1411A-B-10

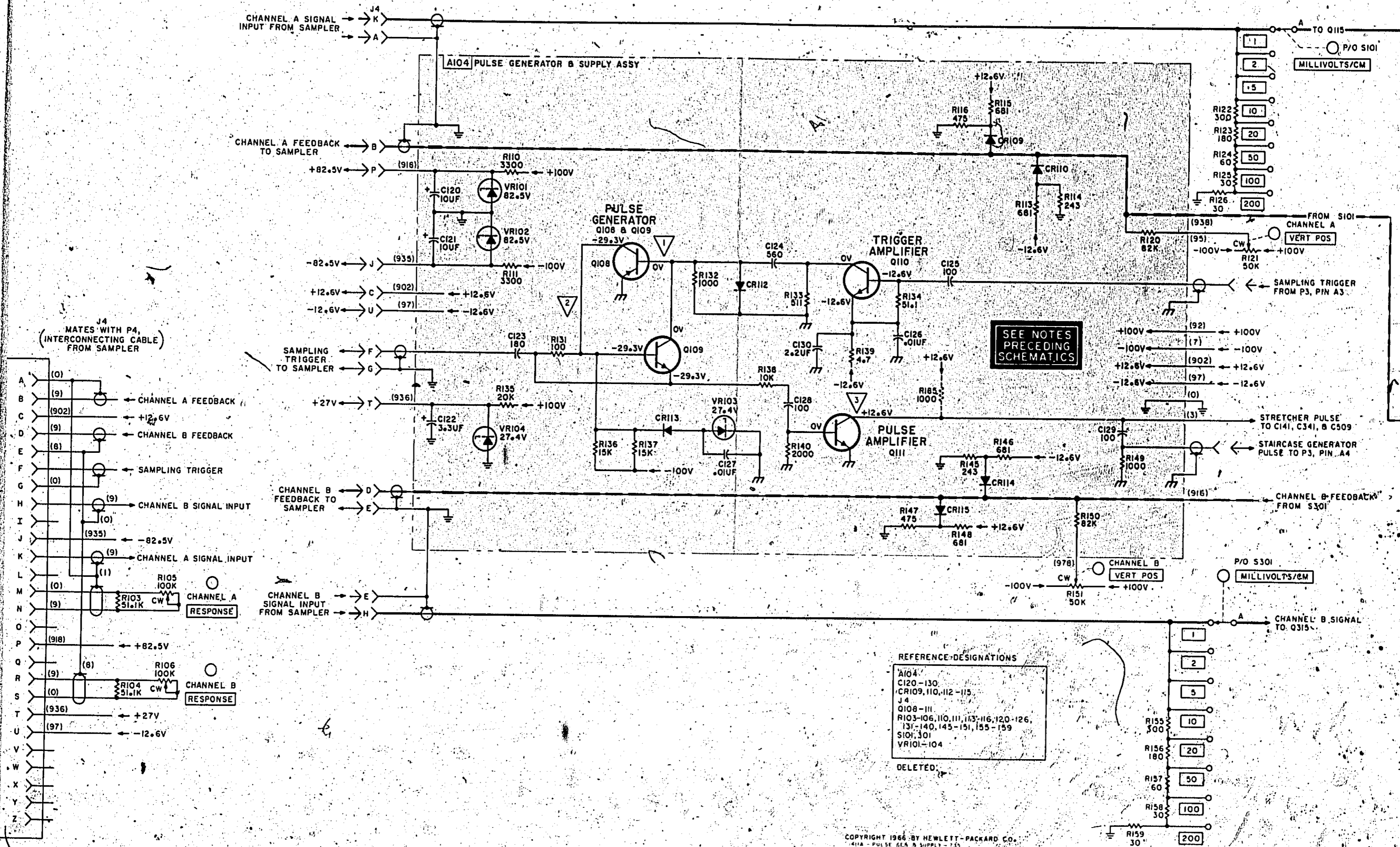

COPYRIGHT 1966 BY HEWLETT-PACKARD CO.
411A - PULSE GEN. & SUPPLY - 735

Figure 8-5: Pulse Generator and Supply Schematic.

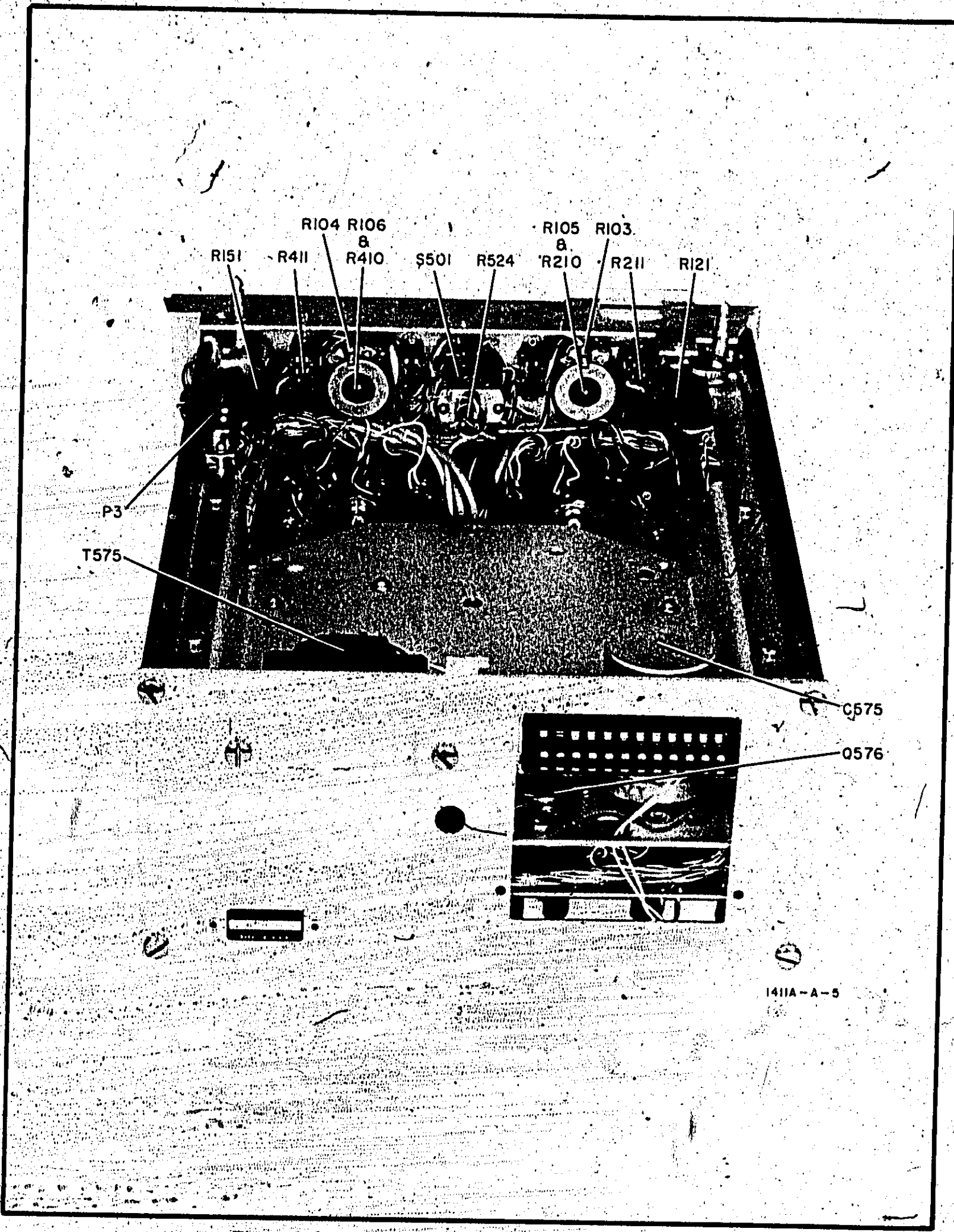

Figure 8-6. Chassis Component Identification, Top View

1411A-A-5

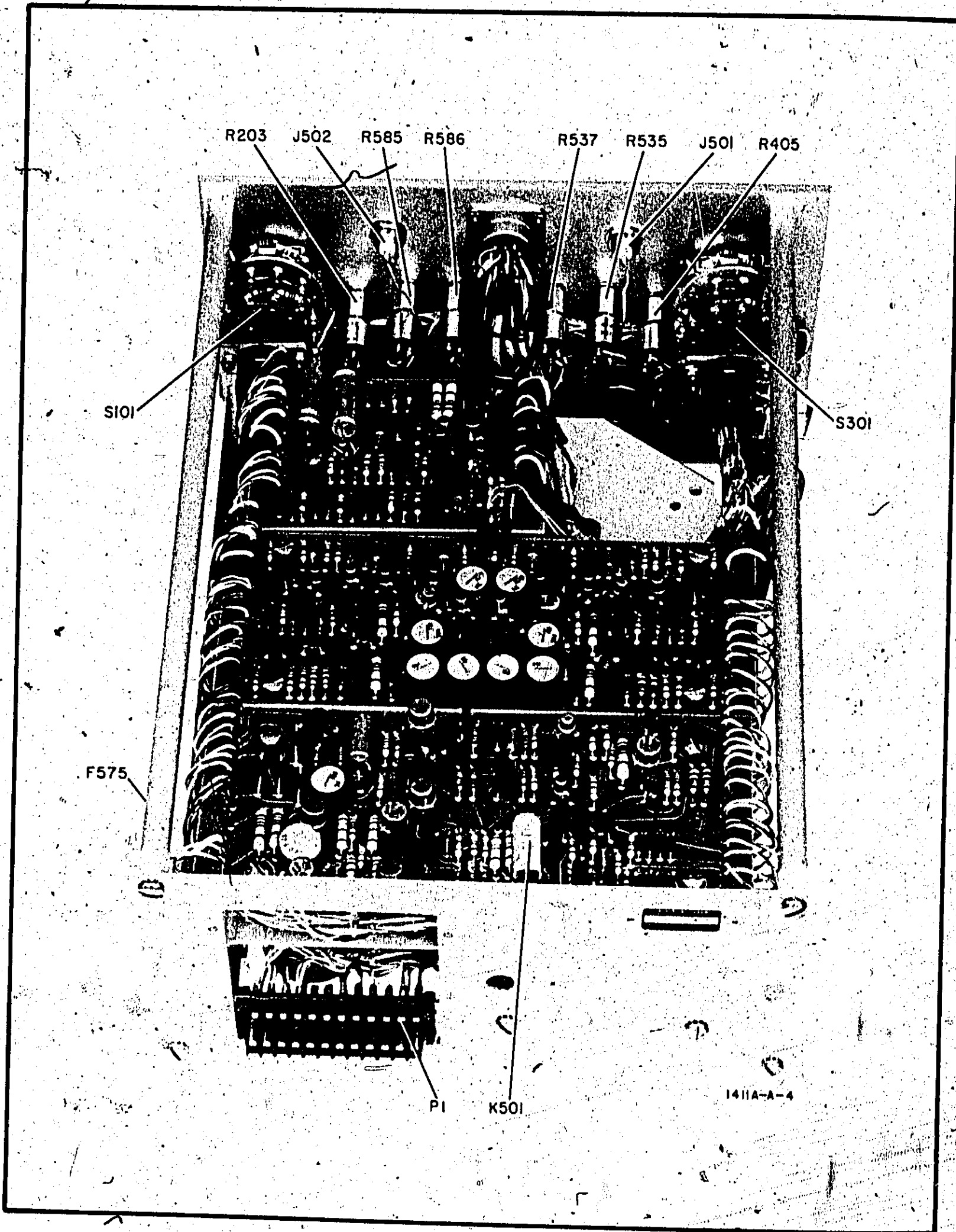

Figure 8-7. Chassis Component Identification, Bottom View

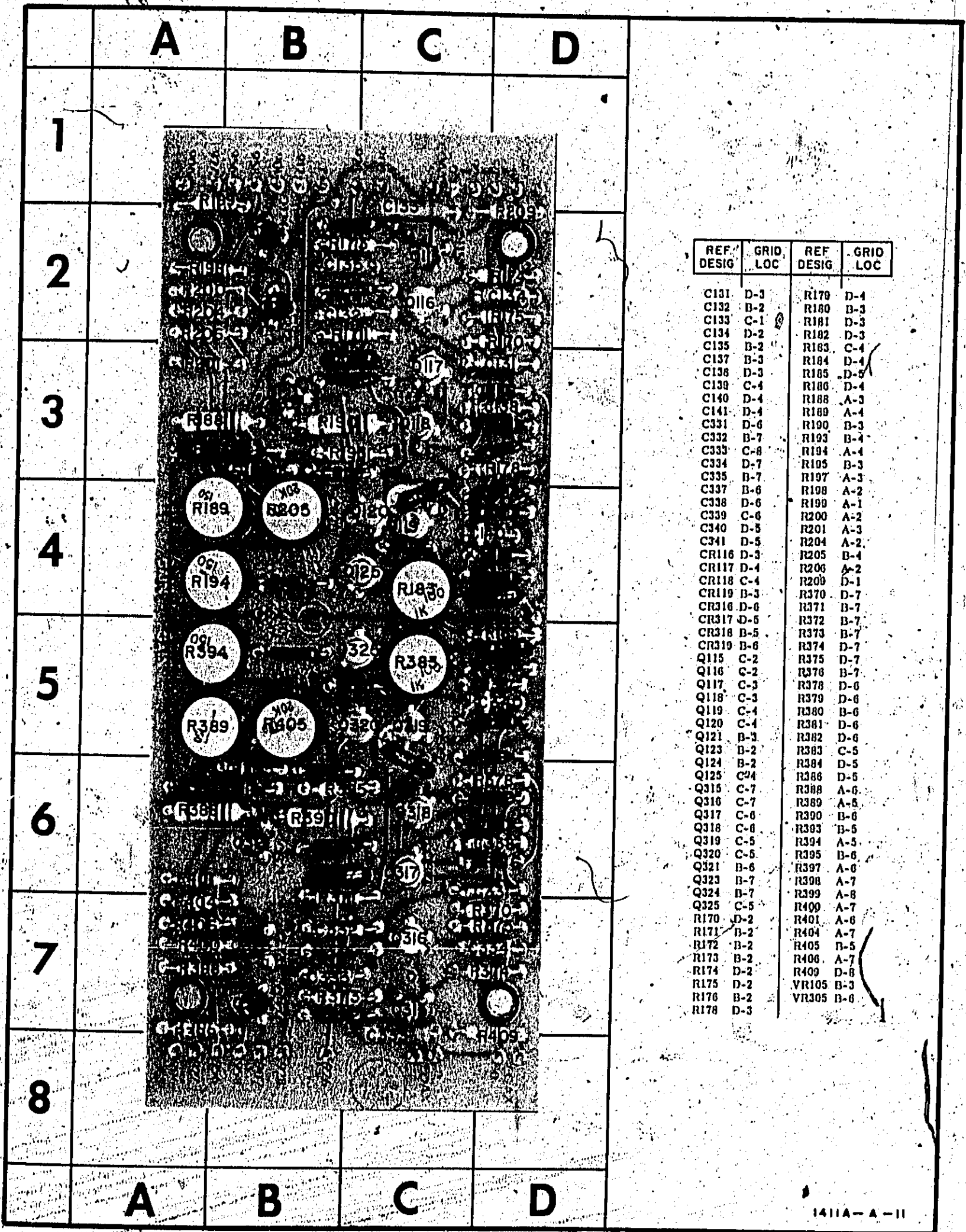

Figure 8-8. Component Identification, A105 Assembly

DC VOLTAGE MEASUREMENT CONDITIONS

a. Connect sampler to Model 1411A. Set both the MODE and LEVEL control to 12 o'clock. Disconnect any incoming signals from the sampler and time base.

b. Set Model 1411A controls as follows:

- Mode Selector A
- both MILLIVOLTS/CM 100
- both VERNIER CAL
- both Polarity +UP
- both NORM-SMOOTHED NORM
- both RESPONSE optimized
- both SMOOTHING optimized
- both VERT. POS traces centered

c. Set time base controls as follows:

- TIME/CM 10 μSEC/CM
- VERNIER CAL
- SCAN DENSITY fully ccw
- SCANNING NORMAL

d. Locate R180 on circuit board and ground the end common to S101 (end closest to rear of instrument). Connect the gate of Q120 to ground also. (R380 and Q320 if checking channel B.)

e. Voltages may vary somewhat from the values shown, depending upon the setting of SMOOTHING and RESPONSE controls. All voltages are referenced to ground.

WAVEFORM MEASUREMENT CONDITIONS

a. Test setup and control settings remain the same as previously described on Figure 8-5 except for the following:

1. When observing TP 4 or TP 5, ground R180 (R380 if checking channel B) as shown on schematic.

2. Remove ground from R180 for checking TP 6 and all successive test points.

b. Relative gain of stages may vary somewhat from that shown in waveforms, depending upon setting of SMOOTHING and RESPONSE controls.

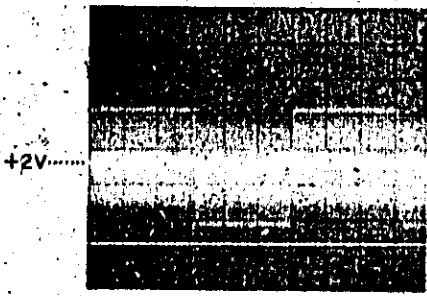

4 0.2V/CM
5MS/CM
(R180 GROUNDED)

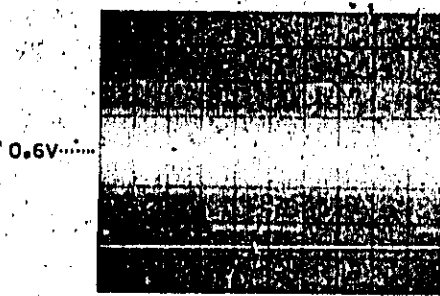

5 0.2V/CM
5MS/CM
(R180 GROUNDED)

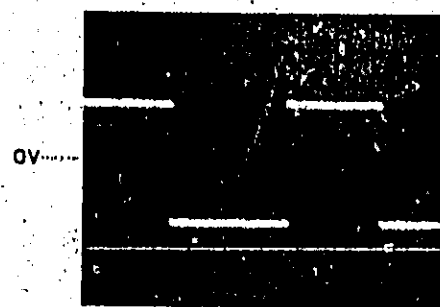

6 0.5V/CM
5MS/CM

1411A-8-11

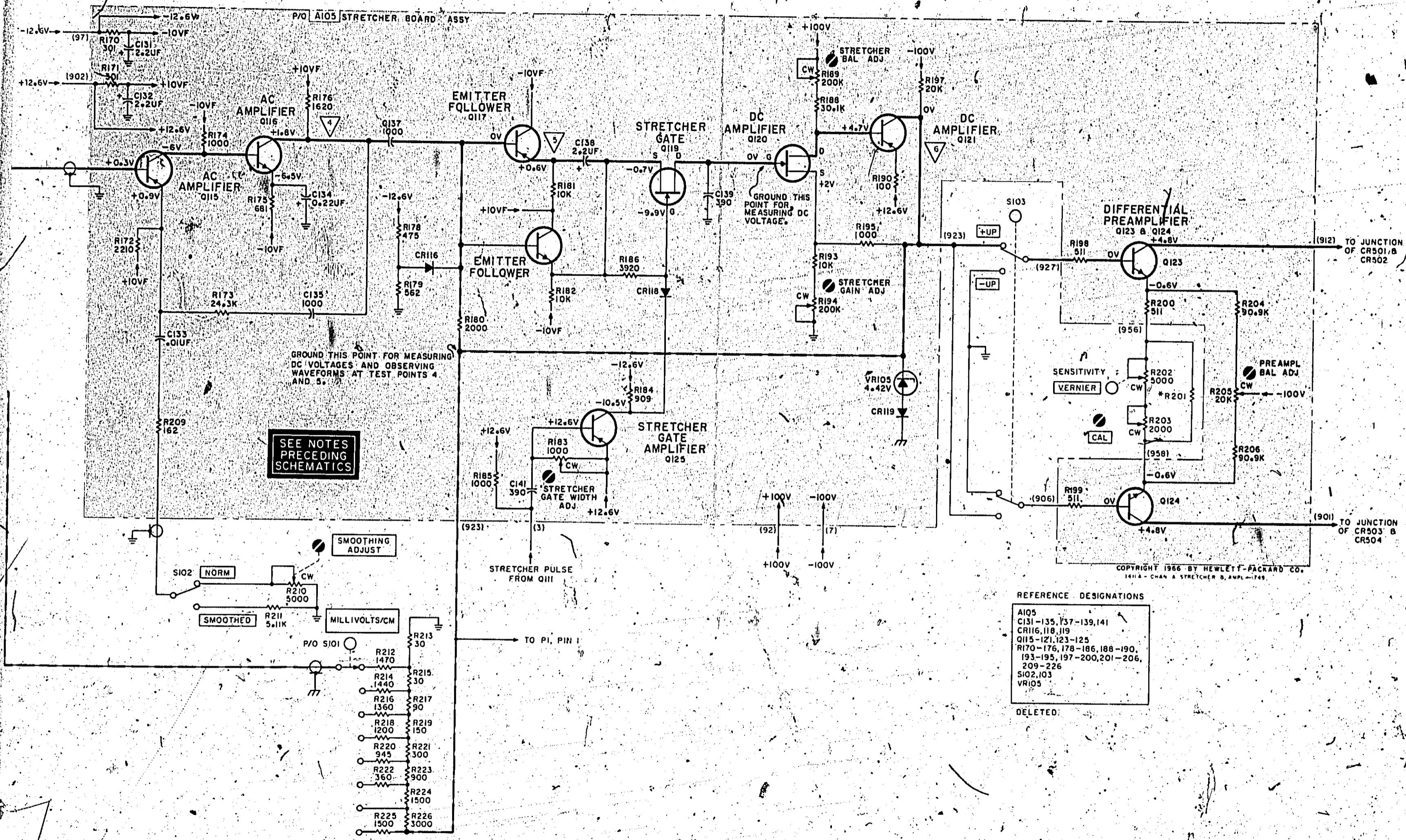
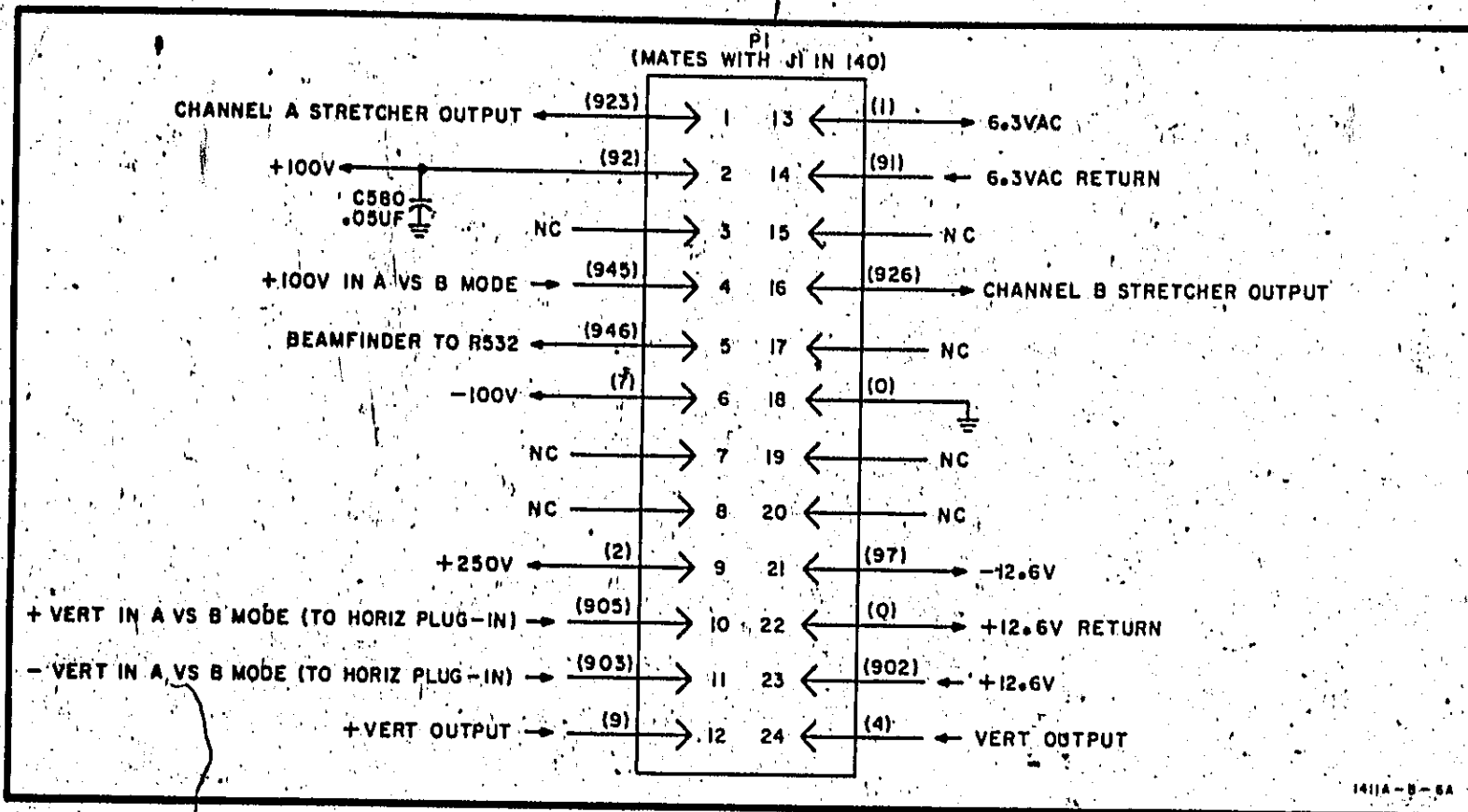
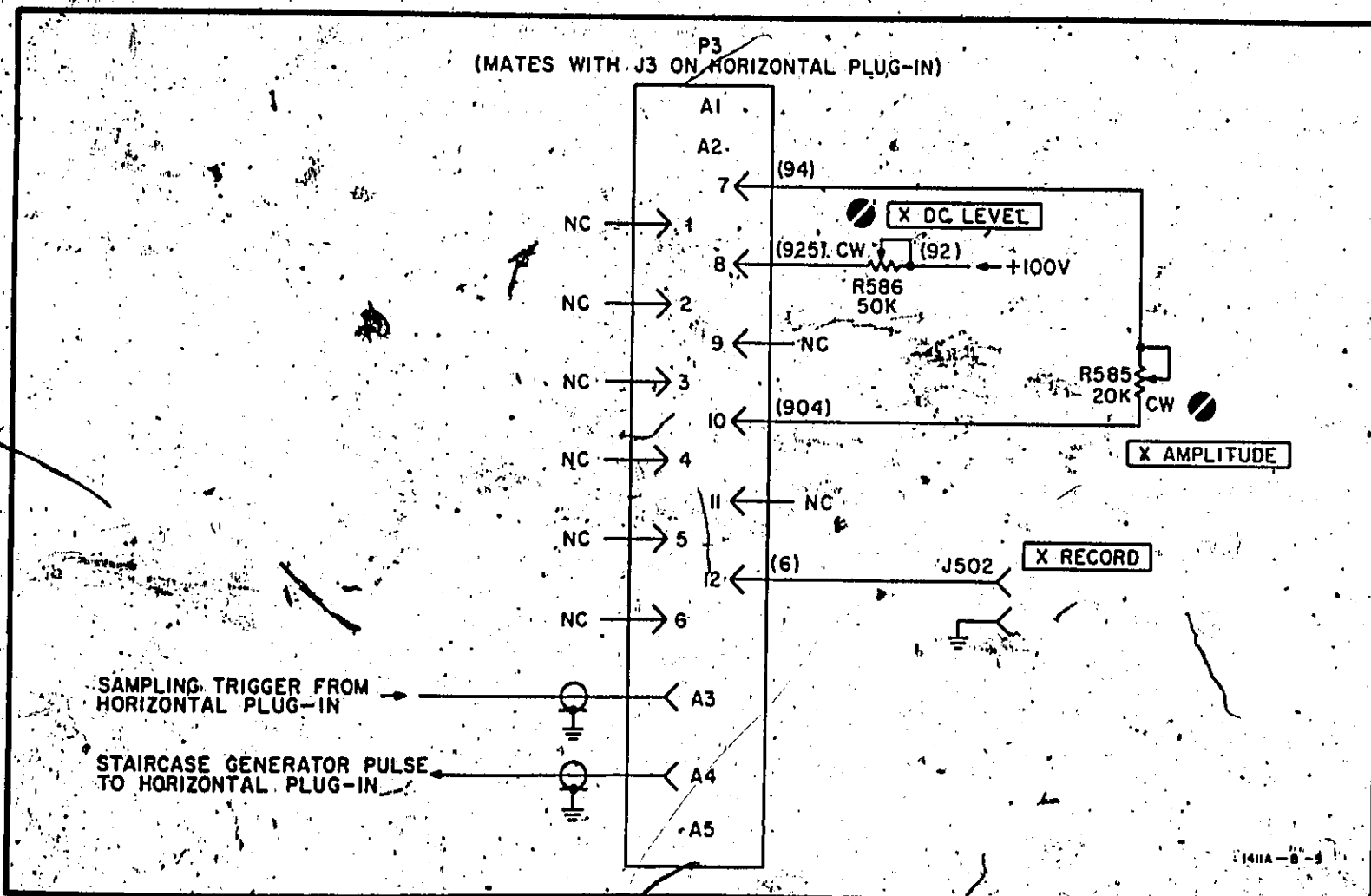

Figure 8-9. Channel A Stretcher Schematic.



1411A-B-5A

Figure 8-10. Rear Panel Connector



1411A-B-5

Figure 8-11. Vertical/Horizontal Connector

Model 1411A

Channel B components are identified in Figure 8-8.

Refer to Figure 8-9 for dc voltages, waveforms and conditions for measurements.

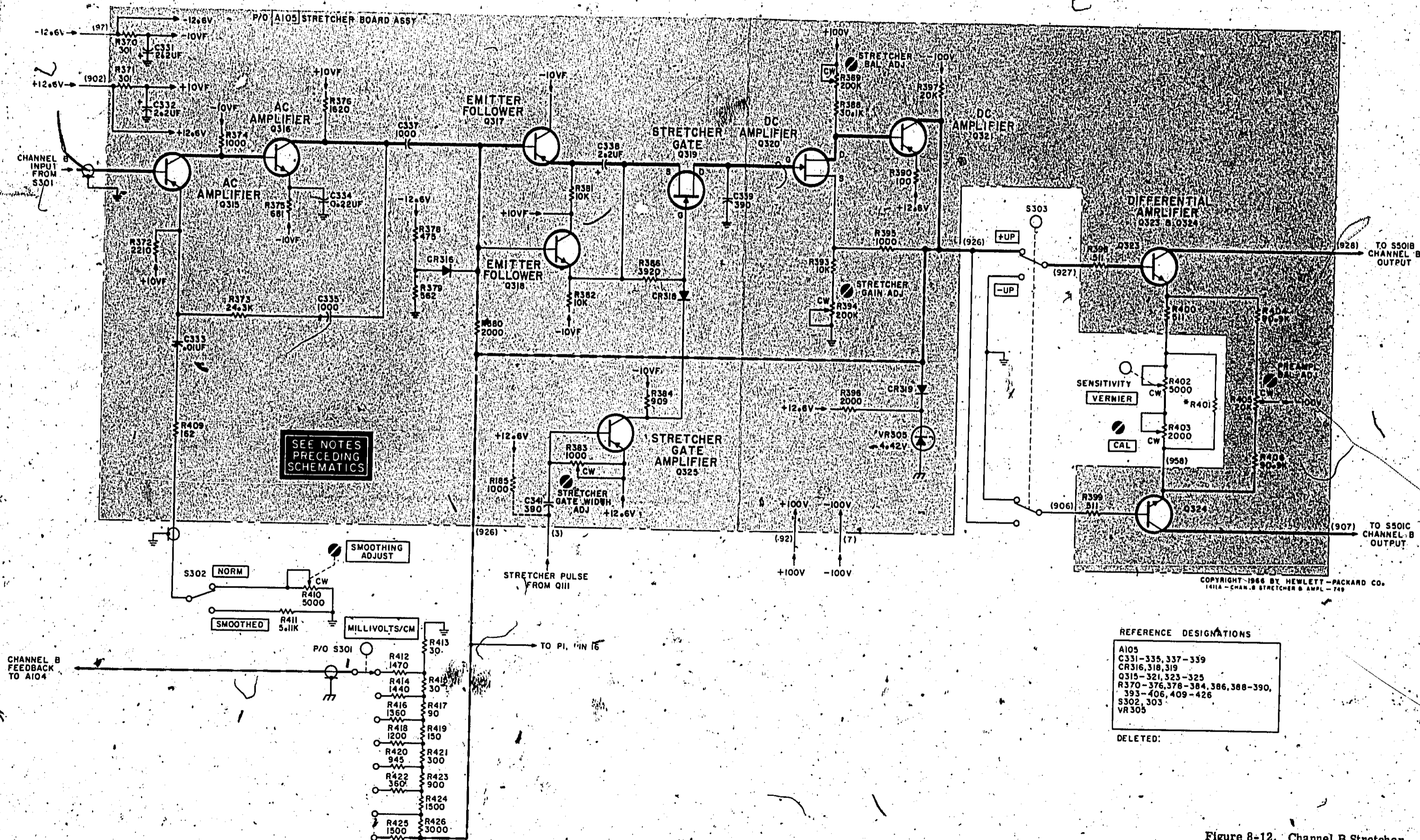

COPYRIGHT 1966 BY HEWLETT-PACKARD CO.
1411A - CHAN. B STRETCHER & AMPL - 749

REFERENCE DESIGNATIONS

A105
C331-335, 337-339
CR316, 318, 319
Q315-321, 323-325
R370-376, 378-384, 386, 388-390, 393-406, 409-426
S302, 303
VR305

DELETED:

Figure 8-12. Channel B Stretcher Schematic.

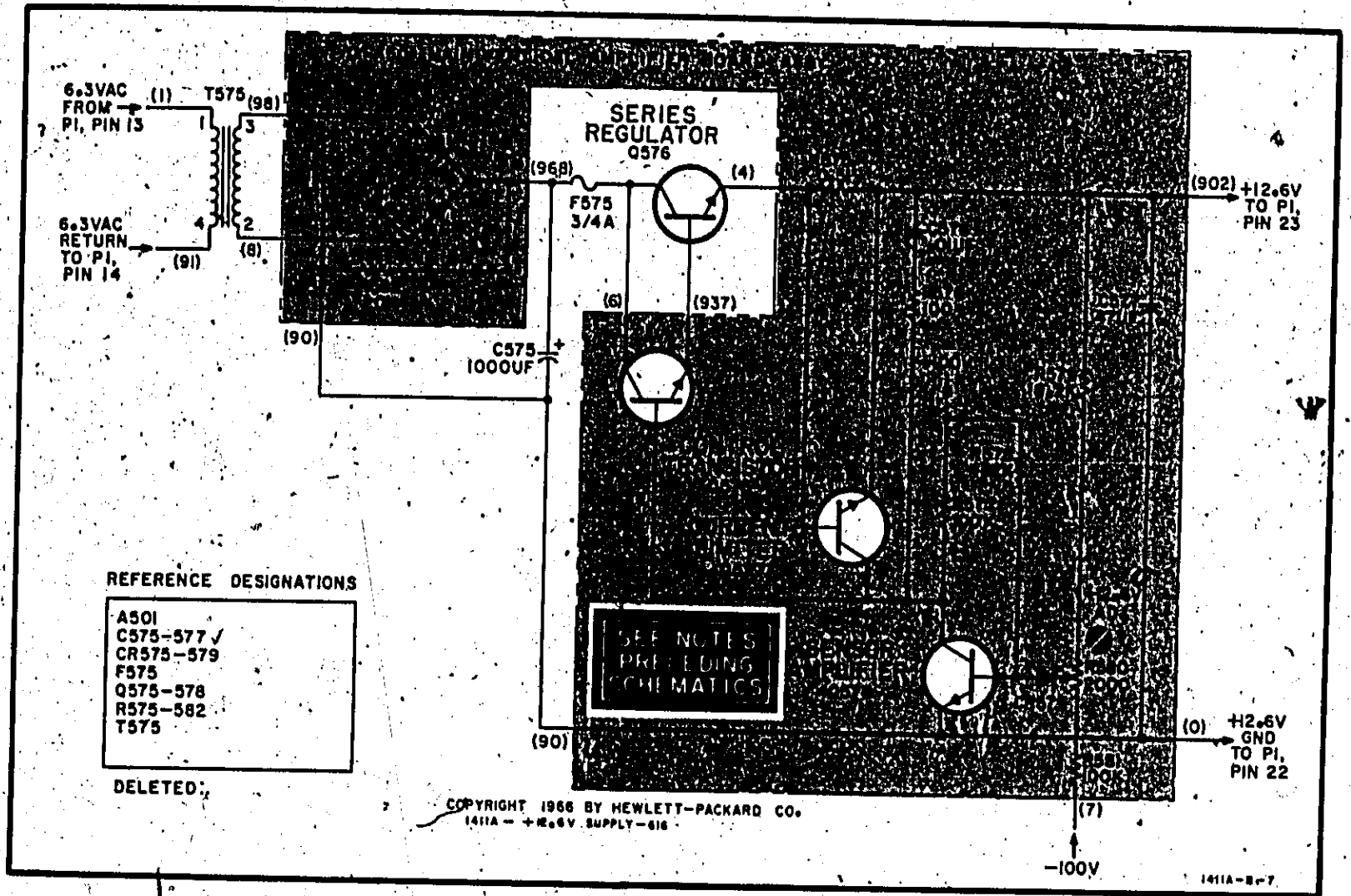

Figure 8-13. +12.6v Supply

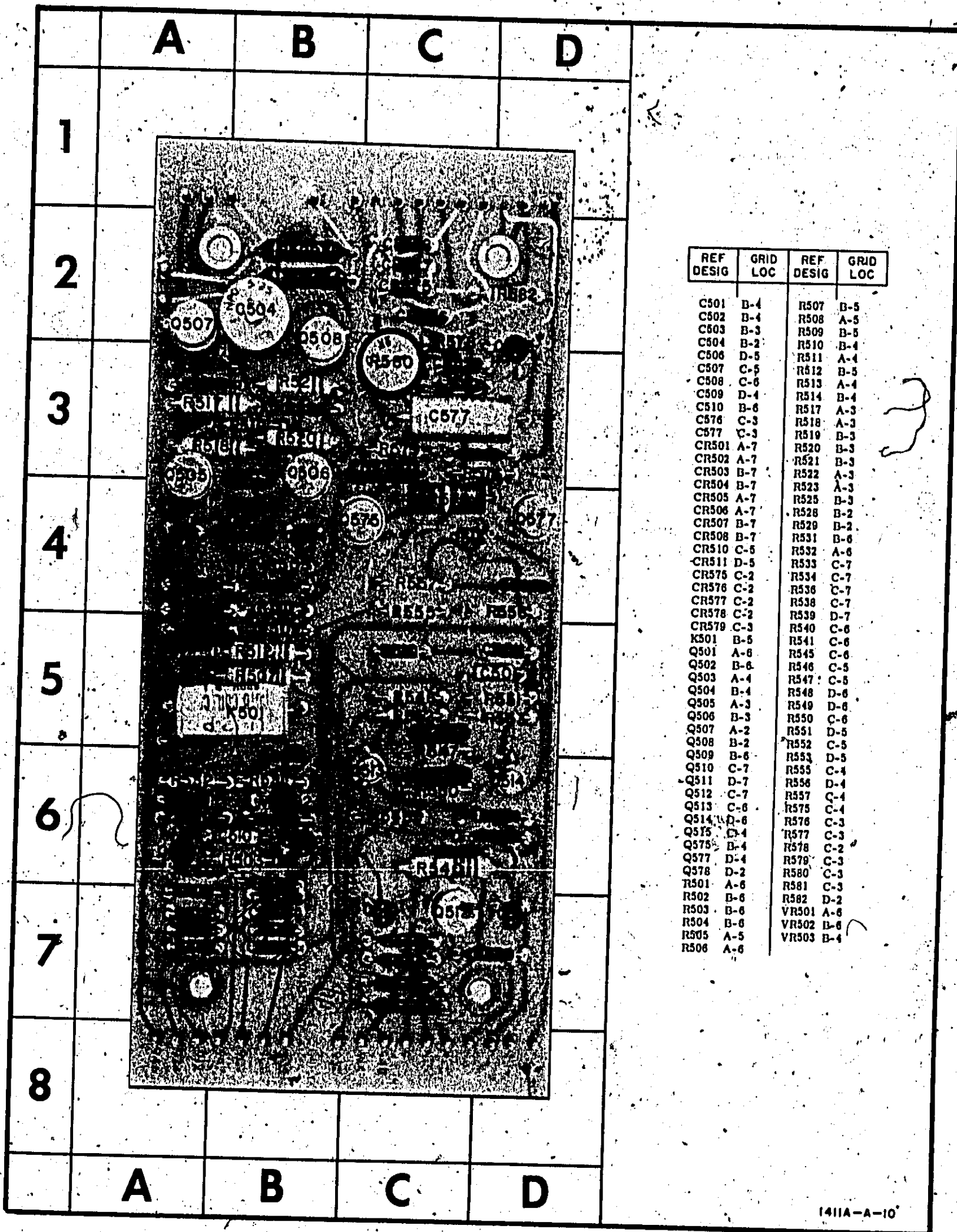

Figure 8-14. Component Identification, A501 Assembly.

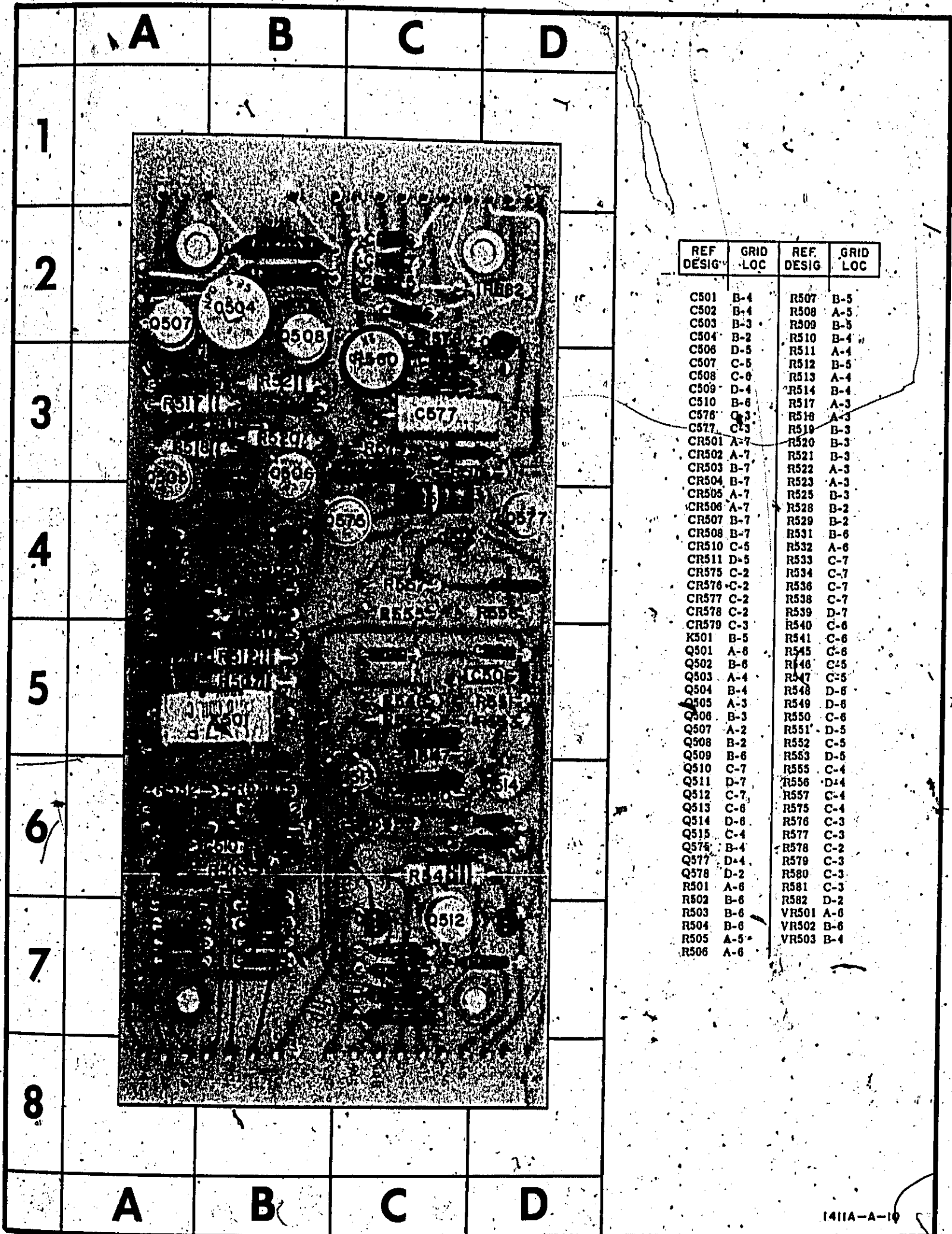

Figure 8-14. Component Identification, A501 Assembly

DC VOLTAGE MEASUREMENT CONDITIONS

Test setup and control settings remain the same as described on Figure 8-9 (R180 and Q120 gate grounded).

WAVEFORM MEASUREMENT CONDITIONS

Test setup and control settings remain the same as described on Figure 8-5 except for the following:

set Mode Selector to A & B when observing waveforms at TP 12 and TP 13.

Note

1. R180 is NOT grounded for these waveforms.
2. Relative gain of stages may vary somewhat from that shown in these waveforms, depending on setting of the SMOOTHING and RESPONSE controls:

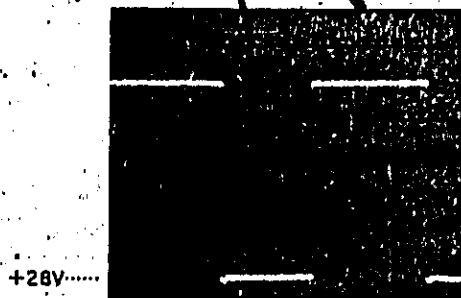

7 1V/CM
5MS/CM

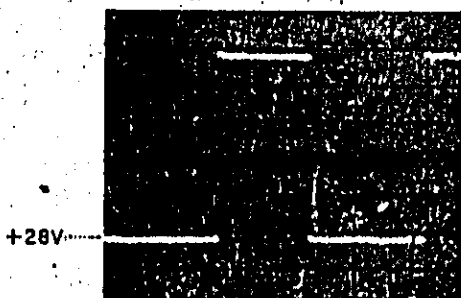

8 1V/CM
5MS/CM

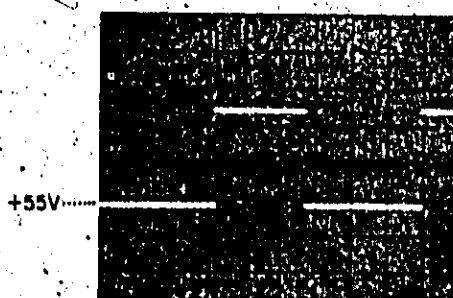

9 5V/CM
5MS/CM

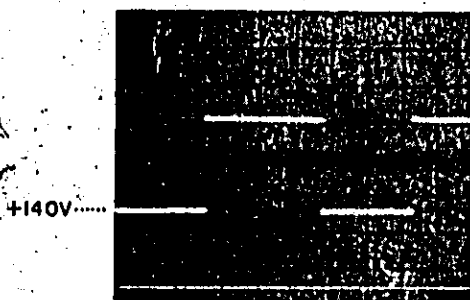

10 10V/CM
5MS/CM

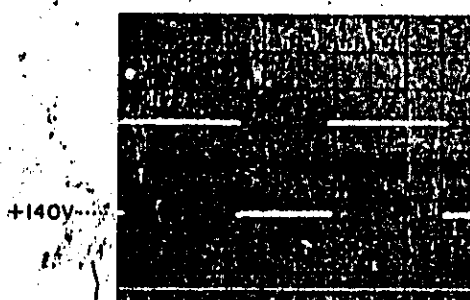

11 10V/CM
5MS/CM

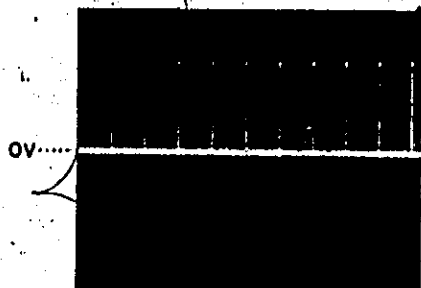

12 5V/CM
0.5MS/CM
(A & B MODE)

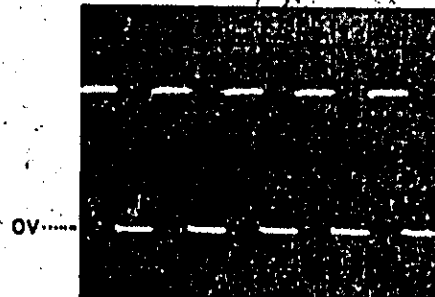

13 2V/CM
0.5MS/CM
(A & B MODE)

1411A-8-12

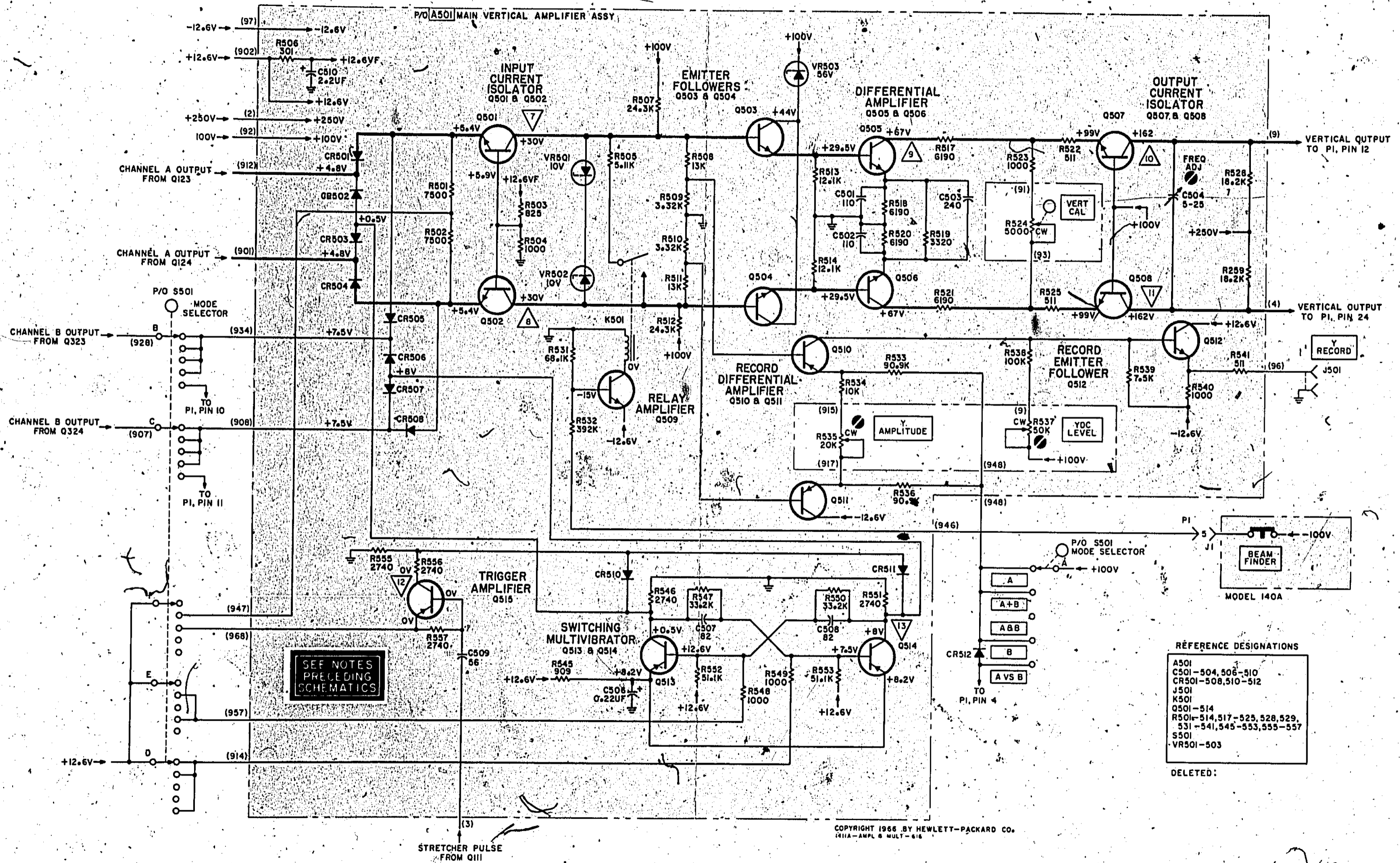
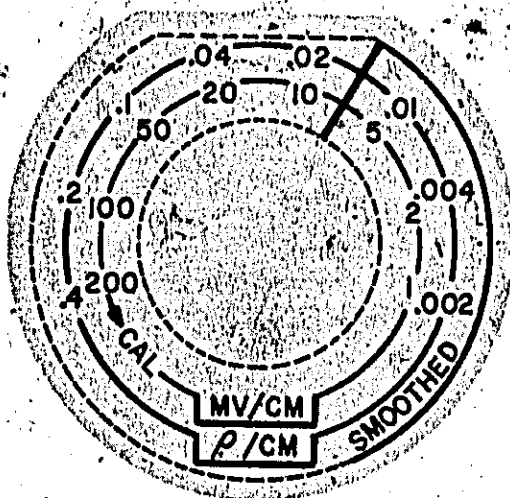

Figure 8-15. Amplifier and Multi-vibrator Schematic

NOTE:

FULL SIZE CALIBRATION OVERLAY INCLUDED IN ENVELOPE



TRIM OUT ALONG
DOTTED LINES 1411A-A-18

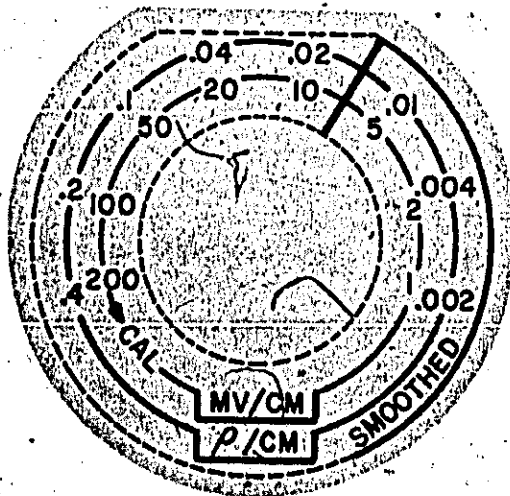

TRIM OUT ALONG
DOTTED LINES 1411A-A-18

TIME DOMAIN REFLECTOMETRY

When the HP Model 1430A Sampler is used in T. D. R. applications, the HP Model 1411A Vertical Amplifier can be recalibrated to read out directly in ρ (reflection co-efficient). See T. D. R. system hookup and calibration procedure below:

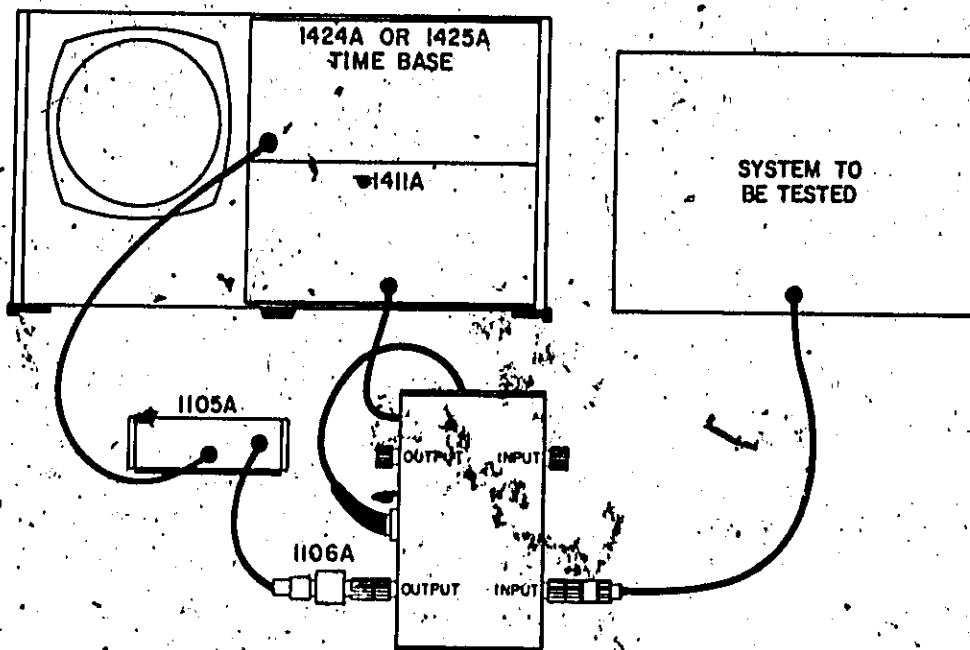

Calibration Procedure:

1. Trim out enclosed ρ/cm calibration overlay.
2. Remove protective backing from overlay and carefully position over mV/cm control knobs on 1411A so that control arrows line up with overlay settings.
3. Position control to 0.1 ρ/cm (50 mV/cm) and get a step of 10 cm vertical deflection using the front-panel vertical CAL of the 1411A and the T. D. R. system hookup as shown above.

hp Model 1411A Sampling Vertical Amplifier
All Serial Numbers

This Service Note provides an easier method of adjusting the 1mv/cm vertical gain.

The sensitivity is so great on the 1mv/cm range that power supply ripple and 60 cycle pick up may make it difficult to adjust the gain in this position. If this condition occurs, place a 1 μ f 200v capacitor from each CRT vertical deflection plate to ground. This will eliminate the trace bounce due to ripple so the gain may be easily adjusted. These capacitors can be easily installed at the CRT by connecting one capacitor from the green wire to ground and the other capacitor from the white wire to ground.

The capacitors are strictly for calibration and should be removed after the adjustment is made.

5/67-8

hp Model 1411A Sampling Vertical Amplifier
Serial Numbers 705-00300 and Below

Improved Transistor for Output Amplifier

The preferred replacement for Q503 and Q504 in the subject instruments is:

Q503, Q504 Transistor, NPN 1854-0022

Enter the above information in the parts list of the Operating and Service Manual.

6/67-8

HP Model 1411A Sampling Vertical Amplifier

Serial Numbers 705-00300 and Below

This Service Note provides a method for improving the low frequency distortion when the subject instruments are used with the 1432A 4GHz Sampler Head. * This modification should be made whenever the 1432A is to be used with the subject 1411A s. 1430A and 1431A operation will not be affected.

The only change required is the replacement of R112 and R141, the 10K resistors in the feedback loop to the samplers, with a #22 gauge wire jumper.

Recalibration according to paragraphs 5-21, 5-22 and 5-24 of the Operating and Service Manual is required after this change.

When this change is made, correct the parts list and schematics of the Operating and Service Manual.

*Area of change

8/67-8



-hp- Model 1411A Sampling Vertical Amplifier
Serial Numbers 724-00375 and below

Lock-up or Compression Problems

This Service Note obsoletes Service Note 1411A-4.

In Service Note 1411A-4, dated 8-67, it was suggested that if a "lock-up" problem occurred in the Model 1411A, to change values of R178/R179 and R378/R379. It has since been learned that this suggested change may cause "compression" (amplitude of display changes with VERT POS) with some samplers. To correct this subsequent problem, the four resistors should be changed back to their original values (R178 and R378 should be 475 Ω , -hp- Part No. 0757-0415, 1%, 1/8w and R179 and R379 should be 562 Ω , -hp- Part No. 0757-0417, 1%, 1/8w) and the following changes be made:

1. Change both R114 and R145 from 475 Ω to 243 Ω , -hp- Part No. 0757-0408, 1%, 1/8w.
2. Check calibration of system; slight adjustment of stretcher circuitry may be necessary. Calibrate the model 1411A with the particular sampler with which it will be used.
3. Change schematics and parts list accordingly in the Operating and Service Manual.

12/67-8

1900 Garden of the Gods Road, Colorado Springs, Colorado, U.S.A. Tel. (303) 636-5111



Europe: 54 Route Des Acacias, Geneva, Switzerland, Cable: "HEWPACKSA" Tel. (022) 42.81.50