

Errata

Title & Document Type: 180F Ruggedized Oscilloscope Operating and Service Manual

Manual Part Number: 00180-90001

Revision Date: November 1969

About this Manual

We've added this manual to the Agilent website in an effort to help you support your product. This manual provides the best information we could find. It may be incomplete or contain dated information, and the scan quality may not be ideal. If we find a better copy in the future, we will add it to the Agilent website.

HP References in this Manual

This manual may contain references to HP or Hewlett-Packard. Please note that Hewlett-Packard's former test and measurement, life sciences, and chemical analysis businesses are now part of Agilent Technologies. The HP XXXX referred to in this document is now the Agilent XXXX. For example, model number HP8648A is now model number Agilent 8648A. We have made no changes to this manual copy.

Support for Your Product

Agilent no longer sells or supports this product. You will find any other available product information on the Agilent Test & Measurement website:

www.agilent.com

Search for the model number of this product, and the resulting product page will guide you to any available information. Our service centers may be able to perform calibration if no repair parts are needed, but no other support from Agilent is available.



Agilent Technologies

HP 180F

OPERATING AND SERVICE MANUAL

**RUGGEDIZED
OSCILLOSCOPE
180F
AND
OS-189A(P)/USM-281**

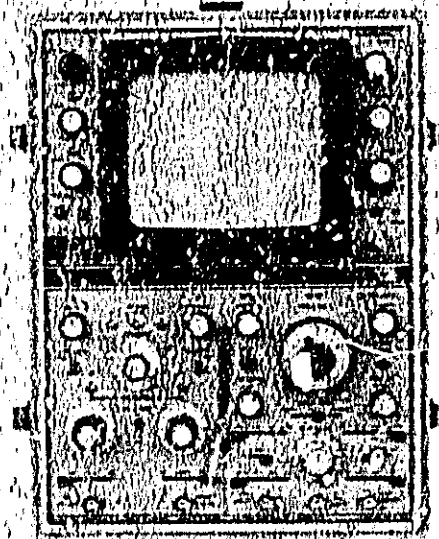

HEWLETT  PACKARD

HP 180F

CERTIFICATION

Hewlett-Packard Company certifies that this instrument met its published specifications at the time of shipment from the factory. Hewlett-Packard Company further certifies that its calibration measurements are traceable to the United States National Bureau of Standards, to the extent allowed by the Bureau's calibration facility, and to the calibration facilities of other International Standards Organization members.

WARRANTY AND ASSISTANCE

This Hewlett-Packard product is warranted against defects in materials and workmanship for a period of one year from the date of shipment. The cathode-ray tube (CRT) in the instrument and any replacement CRT purchased from HP are also warranted against electrical failure for a period of one year from the date of shipment from Colorado Springs. **BROKEN TUBES AND TUBES WITH PHOSPHOR OR MESH BURNS, HOWEVER, ARE NOT INCLUDED UNDER THIS WARRANTY.** Hewlett-Packard will, at its option, repair or replace products which prove to be defective during the warranty period provided they are returned to Hewlett-Packard, and provided the preventive maintenance procedures in this manual are followed. Repairs necessitated by misuse of the product are not covered by this warranty. **NO OTHER WARRANTIES ARE EXPRESSED OR IMPLIED, INCLUDING, BUT NOT LIMITED TO, THE IMPLIED WARRANTIES OF MERCHANTABILITY AND FITNESS FOR A PARTICULAR PURPOSE. HEWLETT-PACKARD IS NOT LIABLE FOR CONSEQUENTIAL DAMAGES.**

Service contracts or customer assistance agreements are available for Hewlett-Packard products.

For any assistance, contact your nearest Hewlett-Packard Sales and Service Office. Addresses are provided at the back of this manual.



OPERATING AND SERVICE MANUAL

**MODEL 180F
AND
OS-189A(P)/USM-281
RUGGEDIZED OSCILLOSCOPE**

Serials Prefixed: 901-

See Section I for instruments with other serial prefixes.

See Section VII for Instruments with Options.

**HEWLETT-PACKARD COMPANY/COLORADO SPRINGS DIVISION
1900 GARDEN OF THE GODS ROAD, COLORADO SPRINGS, COLORADO, U.S.A.**

TABLE OF CONTENTS

Section	Page	Section	Page
I GENERAL INFORMATION	1-1	V PERFORMANCE CHECK AND ADJUSTMENTS	5-1
1-1. Description	1-1	5-1. Introduction	5-1
1-8. Cathode-ray Tube	1-1	5-3. Test Equipment	5-1
1-10. Warranty	1-1	5-5. Performance Check	5-1
1-12. Instrument Identification	1-1	5-9. Preliminary Set-up	5-2
1-14. Manual Changes	1-1	5-11. Calibrator	5-2
1-16. Accessories Furnished	1-1	5-12. Magnifier	5-2
1-18. Available Accessories	1-1	5-13. Bandwidth	5-2
		5-14. Beam Finder	5-2
		5-15. Cover Removal	5-2
II INSTALLATION	2-1	5-17. Adjustments	5-2
2-1. Initial Inspection	2-1	5-20. Preliminary Set-up	5-2
2-4. Claims	2-1	5-22. Low-voltage Power Supply	5-2
2-7. Repackaging for Shipment	2-1	5-23. High-voltage Power Supply	5-3
2-10. Preparation for Use	2-1	5-24. Astigmatism	5-3
2-11. Power Requirements	2-1	5-25. Intensity Limit	5-3
2-13. Three-conductor Power Cable	2-1	5-26. Flood Gun	5-3
2-15. Instrument Cooling	2-2	5-27. Trace Alignment	5-3
		5-28. Gate Amplifier Response	5-3
		5-29. Horizontal Amplifier	5-3
III OPERATION	3-1	VI REPLACEABLE PARTS	6-1
3-1. Introduction	3-1	6-1. Introduction	6-1
3-3. Controls and Connectors	3-1	6-4. Ordering Information	6-1
3-5. Front Panel	3-1	6-8. Option 21 Replaceable Parts	6-2
3-13. Rear Panel	3-1	6-9. Maintenance Parts List	6-3
3-17. Internal	3-1	6-12. List of Manufacturers	6-3
3-19. Plug-in Units	3-3	6-14. Stock Number Identification	6-3
IV PRINCIPLES OF OPERATION	4-1	VII MANUAL CHANGES AND OPTIONS	7-1
4-1. Introduction	4-1	7-1. Manual Changes	7-1
4-3. Functional Description	4-1	7-5. Options	7-1
4-12. Circuit Details	4-1	7-9. Special Instruments	7-1
4-14. Gate Amplifier	4-1	VIII SCHEMATICS AND TROUBLESHOOTING	8-1
4-18. Horizontal Amplifier	4-2	8-1. Introduction	8-1
4-24. High-voltage Power Supply (HVPS)	4-3	8-3. Schematic Diagrams	8-1
4-28. Low-voltage Power Supply (LVPS)	4-3	8-6. Component Identification	8-1
4-41. Calibrator	4-4	8-8. Troubleshooting	8-1
4-43. Output Amplifiers	4-4	8-12. Repair and Replacement	8-1
		8-14. High-voltage Supply Repair	8-1
		8-16. CRT Removal and Replacement	8-2
		8-18. Servicing Etched Circuit Boards	8-2

LIST OF ILLUSTRATIONS

Figure	Title	Page	Figure	Title	Page
1-1.	Model 180F Oscilloscope	1-0	6-1.	Model 180F Mechanical Parts Identification	6-0
1-2.	Instrument Identification	1-3	8-1.	Component Identification	8-5
2-1.	HP Model 180F with Plug-ins	2-0	8-2.	Over-all Troubleshooting Tree	8-6
3-1.	Front and Rear-panel Controls and Connectors	3-2	8-3.	Component Identification, A1 and A2	8-6
3-2.	Accessory Cover, HP Model 10164B, Opt 21	3-3	8-4.	Component Identification, A9	8-7
4-1.	Model 180F Overall Block Diagram	4-0	8-5.	Waveforms and Measurement Conditions, A1	8-7
4-2.	Gate Amplifier Block Diagram	4-1	8-6.	Gate Amplifier, Schematic	8-7
4-3.	Horizontal Amplifier Block Diagram	4-2	8-7.	Component Identification, A3	8-8
4-4.	HVPS Block Diagram	4-3	8-8.	Waveform and Measurement Conditions, A3	8-9
4-5.	Basic Regulated Power Supply	4-3	8-9.	Horizontal Amplifier, Schematic	8-9
5-1.	Cover Removal	5-5	8-10.	Component Identification, A4, A5 and A8	8-10
5-2.	Adjustment Locations	5-9	8-11.	Waveform and Measurement Conditions, A5	8-11
			8-12.	High Voltage Power Supply, Schematic	8-11
			8-13.	Component Identification, A6 and A7	8-12
			8-14.	Jack Connections	8-13
			8-15.	Low-voltage Power Supply, Schematic	8-13

LIST OF TABLES

Table	Title	Page
1-1.	Specifications	1-2
2-1.	Shipping Carton Test Strength	2-1
4-1.	LVPS Current Capabilities	4-4
5-1.	Required Test Equipment	5-1
5-2.	Low-voltage Adjustments	5-3
5-3.	Gain Adjust	5-4
	Performance Check Record	5-7/5-8
6-1.	Reference Designators and Abbreviations	6-1
6-2.	Replaceable Parts	6-3
6-3.	Option 21 Replaceable Parts	6-17
6-4.	List of Manufacturers	6-37
7-1.	Manual Changes	7-1
8-1.	Schematic Diagram Notes	8-4

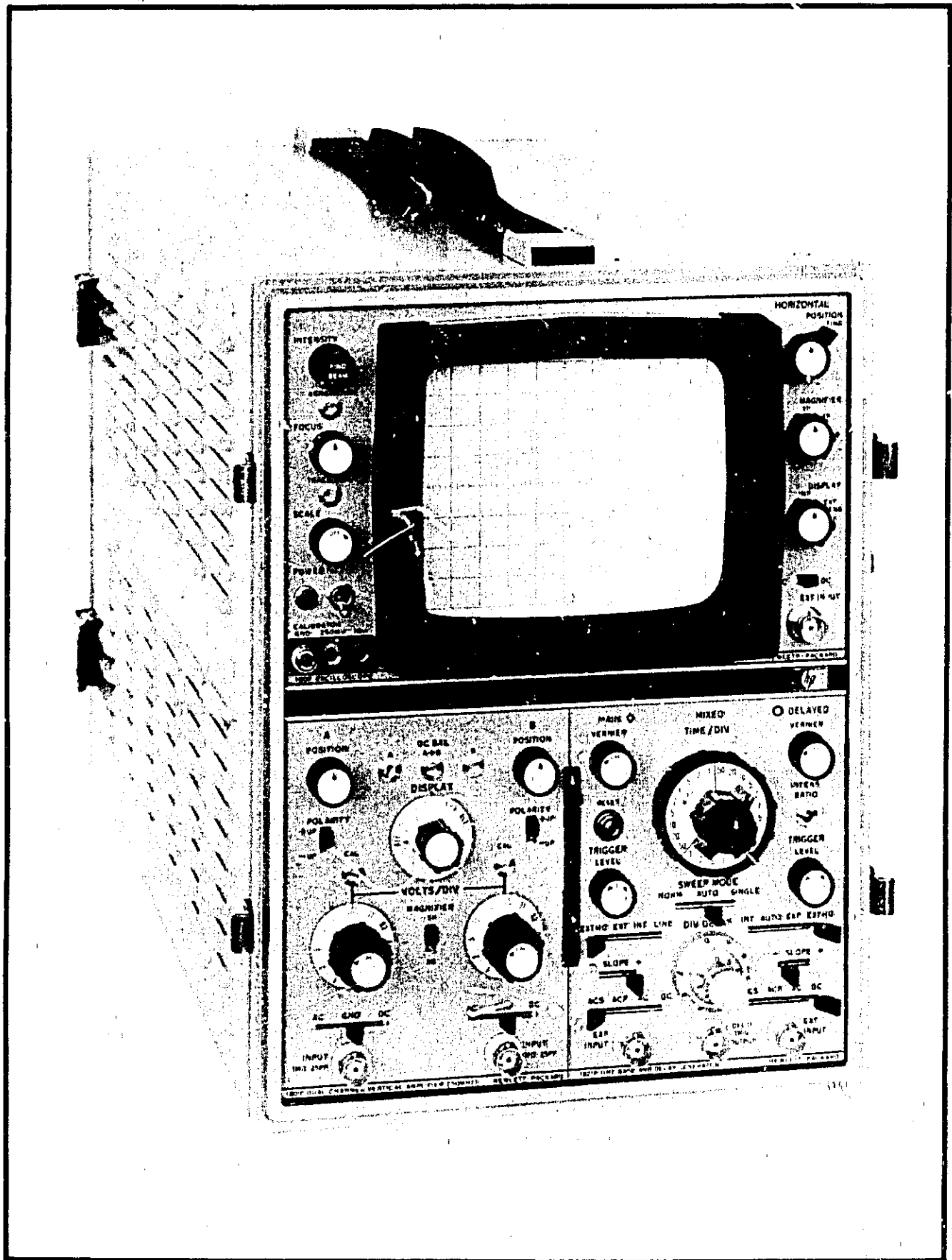

Figure 1-1. Model 180F Oscilloscope

SECTION I

GENERAL INFORMATION

1-1. DESCRIPTION.

1-2. The Model 180F, Figure 1-1, is a highly accurate, light weight general purpose ruggedized oscilloscope using plug-in vertical and horizontal modules. It meets military specifications for electrical performance.

1-3. Solid state circuitry is used throughout; all active components are solid state devices with no vacuum tubes except for the CRT. The oscilloscope is convection cooled and operates within specifications at ambient temperatures from -28°C to $+65^{\circ}\text{C}$.

1-4. The horizontal amplifier bandwidth is dc to 5 MHz with direct coupling and 5 Hz to 5 MHz with capacitive coupling. A BNC connector is provided to attach an external deflection signal. The amplifier's dynamic range is ± 5 V. The deflection factor is adjustable between 0.1 V/div to 1 V/div.

1-5. A BNC connector is provided to connect an external intensity modulation signal. The input resistance is 5100 ohms. A pulse of approximately +2V having a width of at least 50 nanoseconds or a +2V cw input of 10 MHz or lower will blank a trace of normal intensity.

1-6. Four other BNC connectors are provided to couple signals from the plug-ins to external equipment. Since these outputs are dependent upon the specific plug-ins, refer to applicable plug-in manuals for identification. The outputs can supply 3 mA and will drive impedances as low as 1 Kilohm without distortion.

1-7. A 1 kHz square wave signal at two amplitudes, 250 mV and 10V, is available at the front panel. Amplitude is accurate to 2% and risetime is 3 usec. The signal may be used to adjust horizontal and vertical deflection factors and to compensate divider probes.

1-8. CATHODE-RAY TUBE.

1-9. The Model 180F uses an internal graticule CRT which eliminates display parallax. The CRT is furnished with P31 aluminized phosphor and is equipped with a safety faceplate. Other phosphors are also available.

1-10. WARRANTY.

1-11. This instrument is certified and warranted as stated on the inside front cover of this manual. The CRT however, is covered by a warranty separate from the rest of the instrument. The CRT warranty and warranty claim forms are located at the rear of this manual. Should the CRT fail within the time specified on the warranty, return the CRT with the warranty form completed.

1-12. INSTRUMENT IDENTIFICATION.

1-13. Hewlett-Packard uses a two-section eight-digit serial number to identify instruments. The first three digits (preceding the dash) are the serial prefix which identifies a series of instruments; the last five digits identify a particular instrument in the series. The serial number appears on a plate located on the rear panel. All correspondence with a Hewlett-Packard Sales/Service Office in regard to an instrument should reference the complete serial number.

1-14. MANUAL CHANGES.

1-15. This manual provides operating and service information for the HP Model 180F Oscilloscope. Information in this manual applies directly to instruments (as manufactured) with serial numbers prefixed by the three digits indicated on the title page. If the serial prefix of the instrument is different from that on the title page, a MANUAL CHANGES sheet supplied, or Section VII of this manual, will describe changes which will adapt this manual to provide correct coverage. Technical corrections (if any) to this manual, due to known errors in print, are called Errata and are shown on the change sheet. For information on manual coverage for any HP instrument, contact the nearest HP Sales/Service Office (addresses are listed at the rear of this manual).

1-16. ACCESSORIES FURNISHED.

1-17. The Model 180F Oscilloscope is equipped with a mesh contrast filter. The mesh contrast filter snaps into place under the light shield and provides increased display visibility and RFI shielding.

1-18. AVAILABLE ACCESSORIES.

1-19. For ease of calibration and maintenance an HP Model 10407A Plug-in Extender can be obtained. It provides for removal of the plug-ins from the frame and exposes components and adjustments for servicing.

1-20. The HP Model 10164B Oscilloscope Cover and Accessory Kit provides a protective cover for the oscilloscope when not in use, and provides storage space for the test probes, test cables, adapters and connectors which are supplied with the cover.

1-21. Cameras, probes, viewing hoods, terminations, and other accessory items are available for specialized requirements. Information on these and the above described accessories may be obtained from HP Sales/Service Offices listed in the rear of this manual.

Table 1-1. Specifications

CATHODE-RAY TUBE AND CONTROLS

Type: Post accelerator, 12 kV accelerating potential; aluminized P31 phosphor (other phosphors available) NESA coated safety glass face plate.

Graticule: 8 x 10 cm parallax-free internal graticule.

Display Area: Meets MIL-0-24311(EC) for 10 cm horizontal and 6 cm vertical display area, ± 3 cm about the center horizontal graticule line. The additional centimeter at the top and bottom of the graticule provides additional viewing area.

Beam Finder: FIND BEAM control brings trace to CRT screen regardless of horizontal, vertical, or intensity control settings.

Intensity Modulation: Approximately +2V, ≥ 50 ns pulse width (≤ 10 MHz cw), blanks trace of normal intensity. Input resistance approximately 5100 ohms.

Intensity Control: Adjusts beam intensity from extinguished to a point that overrides the unblanking gate.

Focus Control: Adjusts spot for minimum size within the 6 x 10 cm CRT graticule area.

Astigmatism: A front-panel screwdriver control provides circular adjustment of spot.

Trace Align: A front-panel screwdriver control to align the trace with the graticule $\pm 2^\circ$ about the graticule horizontal centerline.

Calibrator: 1 kHz square wave, < 3 us risetime, 10V and 250 mV amplitude, $\pm 2\%$.

HORIZONTAL AMPLIFIER

Bandwidth: DC to 5 MHz dc-coupled; 5 Hz to 5 MHz ac-coupled.

Risetime: < 175 ns with $< 2\%$ overshoot, ringing, or spurious response.

Deflection Factor: Continuously adjustable from 0.1 V/div to 1.0 V/div.

Input Impedance: 1 megohm $\pm 2\%$ shunted by < 35 pF.

Positioning Controls: Coarse and fine positioning controls position the start of a trace over any horizontal point on the screen.

Horizontal Magnifier: X1, X5, X10, $\pm 5\%$, (for 3% accuracy time base plug-ins).

Outputs: Four rear-panel emitter follower outputs for main and delayed gates, main and delayed sweeps; maximum current available ± 3 mA. Will drive impedances as low as 1000 ohms without distortion.

Accessories Furnished: Mesh Contrast Filter.

GENERAL

Weight: 28 lbs 8 oz without plug-ins; (12,9 kg). Shipping 43 lbs (19,5 kg).

Power: 115V or 230V $\pm 10\%$, 50 to 400 Hz, 125 watts max.

Case: Instrument is enclosed in a removable, louvered, drip-proof combination cover and case.

Dimensions: See outline drawing.

NOTES
DIMENSIONS IN INCHES AND MILLIMETERS

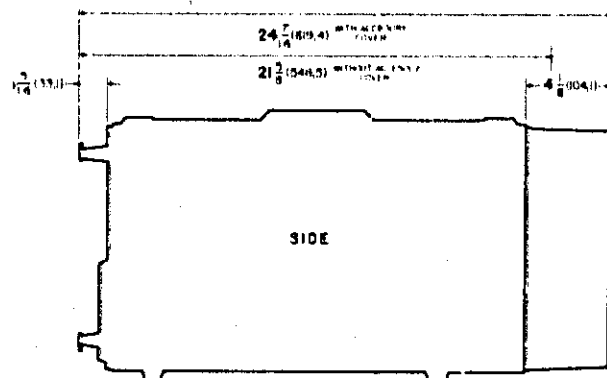
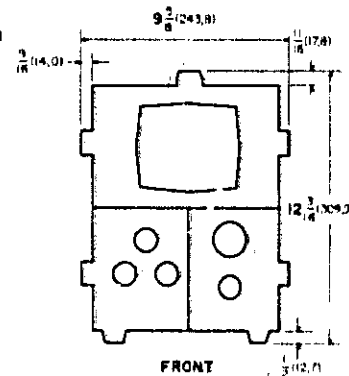

Table 1-1. Specifications (Cont'd)

ENVIRONMENTAL	
Meets all environmental requirements of MIL-0-24311(EC)	
Temperature: Non-operating -62°C to $+75^{\circ}\text{C}$ (storage). Operating -28°C to $+65^{\circ}\text{C}$.	Electromagnetic Interference: Per MIL-STD-462 performed by MIL-STD-461 for the following test:
Humidity: Operating 0 to 95% RH over entire specified temperature range. Non-operating — same as above.	a. CE01 30 Hz to 20 kHz power leads
Altitude: Non-operating — Sea level to 50,000 ft. Operating — Sea level to 25,000 ft.	b. CE03 0.02 Hz to 50 MHz power leads
Vibration: Operating -5 Hz to 15 Hz $.030 \pm 0.006$ inches, 16 Hz to 25 Hz $.020 \pm 0.004$ inches, 26 Hz to 33 Hz 0.10 ± 0.002 inches.	c. CS01 0.03 Hz to 50 kHz power leads
Shock: Operating 1 ft, 3 ft, and 5 ft, 400 pound hammer blows in vertical, horizontal and longitudinal axis. Per MIL-STD-901, Grade A, Class 1, Type A for lightweight equipment.	d. CS02 0.05 Hz to 400 MHz power leads
Inclination: Operating — Per MIL-E-16400.	e. CS06 Spike Power leads
Dripproof: Non-operating — Per MIL-STD-108.	f. RE01 0.03 Hz to 30 kHz, Mag. Field
Salt Spray: Non-operating — Per MIL-E-16400.	g. RE02 14 kHz to 10 gHz, Elect. Field
	h. RS01 0.03 Hz to 30 kHz, Mag. Field
	i. RS03 14 kHz to 10 gHz, Elect. Field
	Reliability: Tested per MIL-0-23411(EC). 8 instruments operated for total of 2630 operating hours at 40°C . and vibrated at 25 Hz with an amplitude of 0.020 inch for 10 minutes of each hour of "on" time during each day of the eight hour manned cycle. The input power was removed for 10 minutes of each 4 hours during the same manned test schedule. Proven MTBF of 600 hours with 99% confidence level.

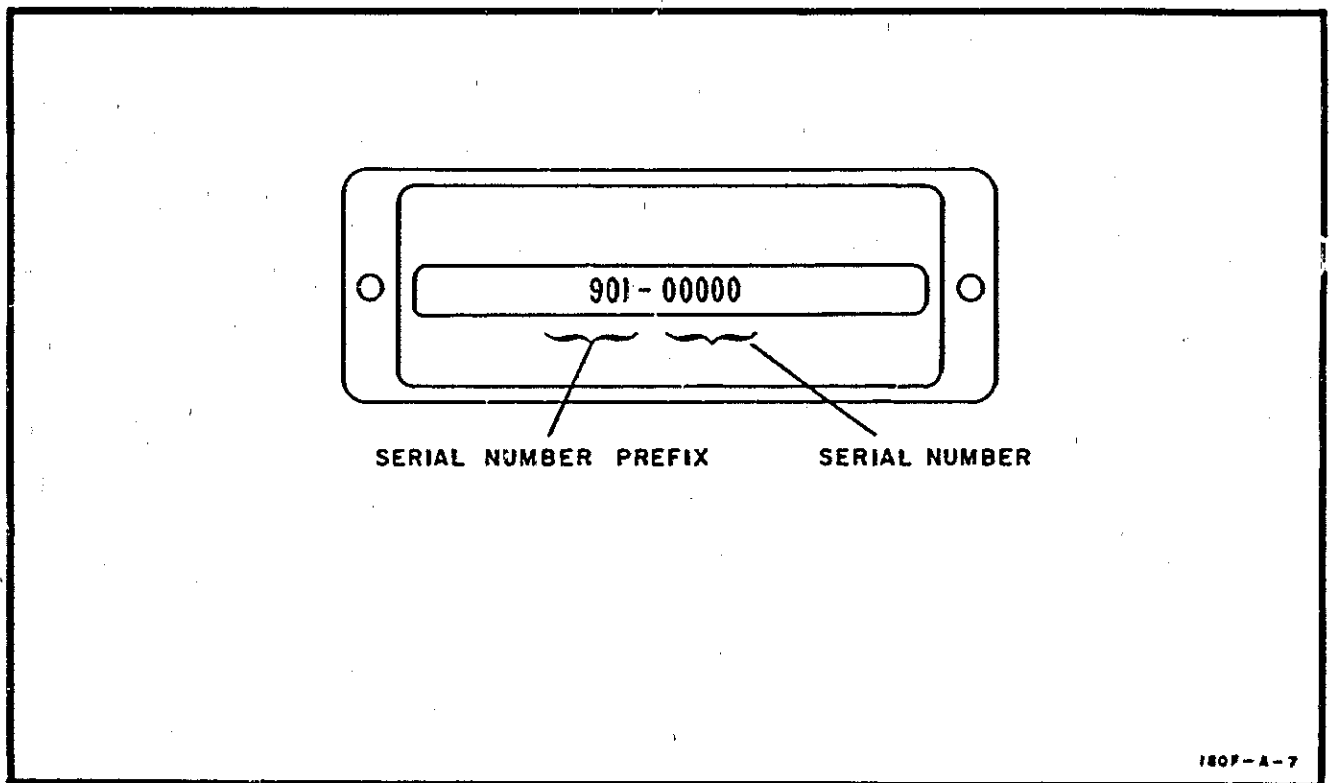

Figure 1-2. Instrument Identification

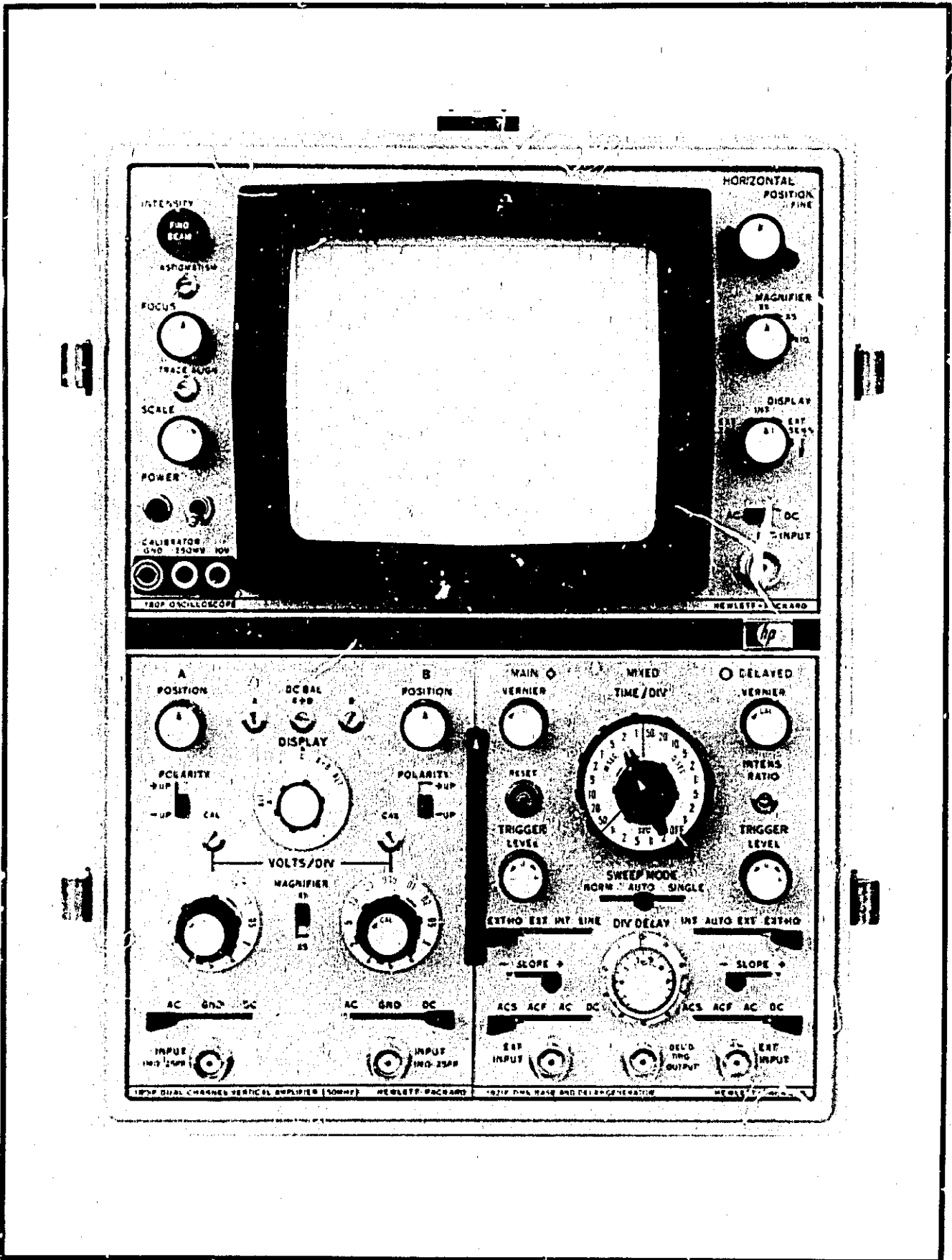

Figure 2-1. HP Model 180F with Plug-ins

SECTION II

INSTALLATION

2-1. INITIAL INSPECTION.

2-2. MECHANICAL CHECK. Check the shipping carton for damage immediately after receipt. If it is damaged, ask the carrier's agent to be present when the instrument is unpacked. Inspect the Model 180F for physical damage such as bent or broken parts and dents or scratches. If damage is found, refer to Paragraph 2-4 for recommended claim procedure. If the Model 180F appears undamaged, perform the electrical check (Paragraph 2-3). Retain the packaging material for possible future use.

2-3. ELECTRICAL CHECK. The performance check is given in Paragraphs 5-5 through 5-14. This check will determine whether or not the instrument is operating within its specifications as listed in Table 1-1. The initial performance and accuracy of this instrument are certified as stated on the inside front cover of this manual. If the Model 180F does not operate as specified, refer to Paragraph 2-4 for the recommended claim procedure.

2-4. CLAIMS.

2-5. If physical damage is found or if the instrument is not within specifications when received, notify the carrier and the nearest Hewlett-Packard Sales/Service Office immediately. The Sales/Service Office will arrange for repair or replacement of the instrument without waiting for a claim to be settled with the carrier.

2-6. The warranty statement for all Hewlett-Packard products is on the inside front cover of this manual. Contact the nearest Sales/Service Office for information about warranty claims.

2-7. REPACKAGING FOR SHIPMENT.

2-8. If the instrument is to be shipped to a Hewlett-Packard Sales/Service Office, attach a tag to it showing owner's name and address, instrument's model number and eight-digit serial number, and a description of service required.

2-9. The original shipping carton and packaging materials should be used for reshipment. If they are not available or reusable, the instrument should be repackaged with the following materials:

a. A double-walled carton (refer to Table 2-1 for test strength required).

Table 2-1. Shipping Carton Test Strength

Gross Weight (lbs)	Carton Test Strength (lbs)
up to 10	200
10 to 30	275
30 to 120	350
120 to 140	500
140 to 160	600

b. Heavy paper or sheets of cardboard to protect all instrument surfaces (use a nonabrasive material such as polyurethane or a cushioned paper such as Kimpak around all projecting parts).

c. At least four inches of tightly-packed, industry-approved, shock-absorbing material such as extra-firm polyurethane foam.

d. Heavy duty shipping tape to secure outside of carton.

2-10. PREPARATION FOR USE.

2-11. POWER REQUIREMENTS.

2-12. The standard Model 180F requires either a 115 or 230V $\pm 10\%$, single phase, 50 to 400 Hz power source that can deliver 125 watts.

a. **115 V OPERATION.** This instrument, as shipped, is ready for operation on 115 Vac. Refer to the following paragraph for 230 Vac operation.



Before applying power, check the rear-panel slide switch for proper position (115 or 230).

b. **230V OPERATION.** If the instrument is to be operated on 230 Vac, set the rear-panel switch to 230 and replace the four 1.6 ampere fuses (rear panel) with 0.8 ampere fuses. The 115/230 switch selects the proper transformer setting for the desired voltage. This switch and the fuses should always be checked before connecting the instrument to a power source to avoid damage to the unit.

2-13. THREE-CONDUCTOR POWER CABLE.

2-14. The National Electrical Manufacturers' Association (NEMA) recommends that the instrument panel and cabinet be grounded to protect the operating personnel. The Model 180F is equipped with a three-conductor power cord which, when plugged into an appropriate outlet, grounds the instrument through the round offset pin. When operating the Model 180F from a two-contact outlet, use a three conductor to two-conductor adapter. Preserve the safety feature by grounding the adapter lead.

2-15. INSTRUMENT COOLING.

2-16. The Model 180F does not require forced-air cooling when operated in an ambient temperature of -28 to $+65$ degrees centigrade. Normal air circulation will maintain a reasonable temperature within the instrument. When choosing a location for the instrument, select an area that provides several inches of space around the cabinet to allow adequate ventilation.

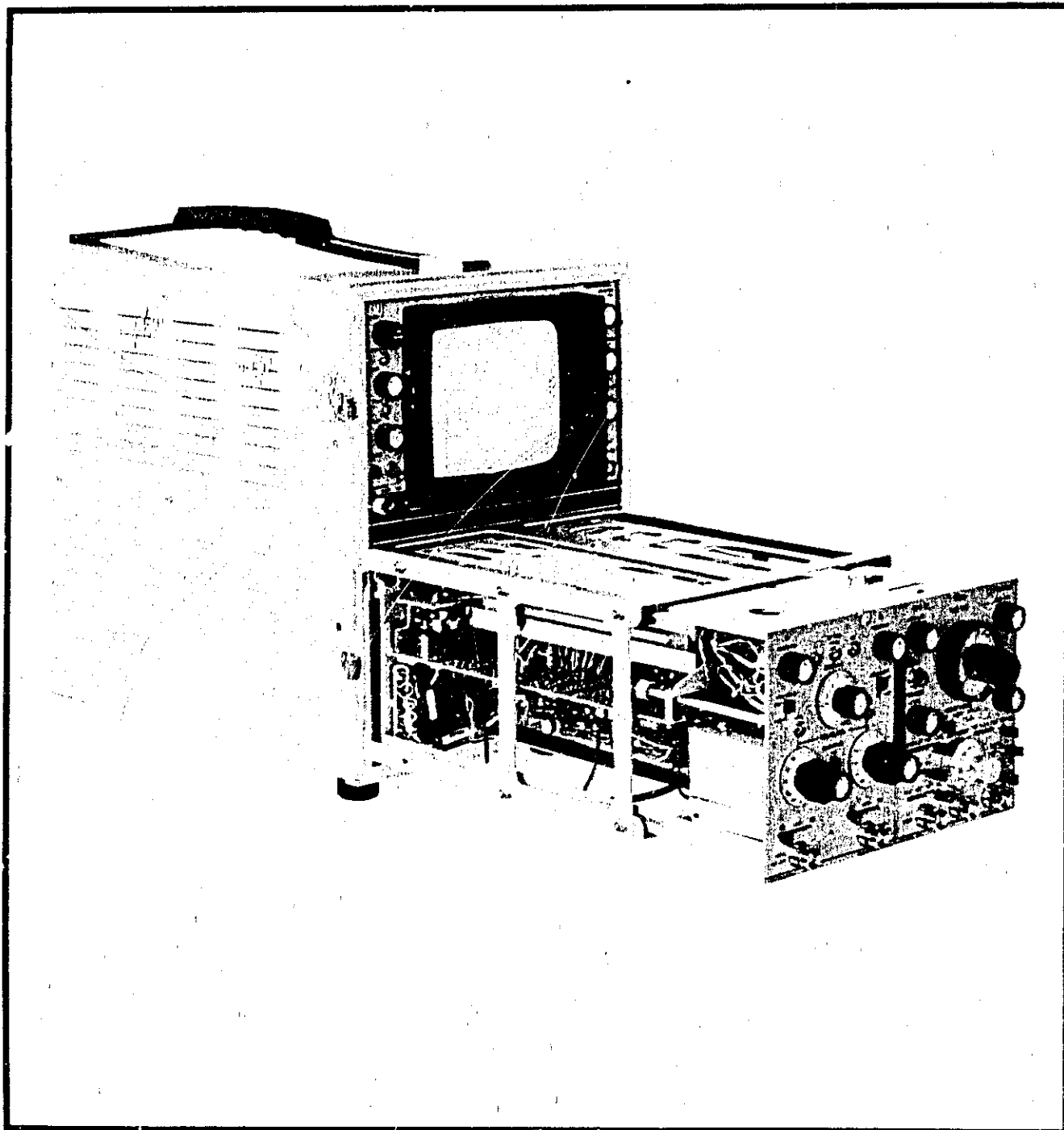

Available accessory, HP Model 10407A Plug-in Extender, exposes components and adjustments for servicing.

OPERATION

SECTION III
OPERATION**3-1. INTRODUCTION.**

3-2. The Model 180F is a light-weight, general-purpose oscilloscope with plug-in capabilities. The plug-in compartment is located below the CRT in the Model 180F. The horizontal plug-in goes into the right side of the compartment and the vertical into the left. The plug-ins must be locked together before being inserted into the compartment (see plug-in manuals).

3-3. CONTROLS AND CONNECTORS.

3-4. Location of controls and connectors is shown in Figure 3-1 along with a brief description of their functions. The following paragraphs explain some functions in more detail.

3-5. FRONT PANEL.

3-6. **CALIBRATOR.** The 10V and 250 mV, 1-kHz square wave outputs of the CALIBRATOR may be used for vertical and horizontal sensitivity calibration, and for divider probe compensation. The amplitude is accurate to $\pm 2\%$ from -28°C to $+65^{\circ}\text{C}$ (-18°F to 149°F). Risettime of the signal is 3 μsec .

3-7. **SCALE.** This control adjusts the over-all brightness of the CRT face. It should be adjusted for good contrast between the background and the graticule. The SCALE control is especially useful when using a hood to view the display or when photographing waveforms. Rotate SCALE to OFF when scale illumination is not needed.

3-8. **TRACE ALIGN.** The TRACE ALIGN adjustment compensates for external magnetic fields that may affect the alignment of the horizontal trace with the graticule. The alignment should be checked when the instrument is moved to a new location and adjustment made whenever necessary.

3-9. **FOCUS AND ASTIGMATISM.** Both of these controls are used to obtain the sharpest display. Normally, once set, ASTIGMATISM will not need to be readjusted. It may need readjustment however, when the vertical plug-in is changed.

3-10. **FIND BEAM.** Occasionally the CRT beam may be driven off screen by large dc input levels or by improper control settings. The beam may be brought back on screen by depressing the FIND BEAM control and adjusting the horizontal and vertical (see vertical plug-in manual) position controls to center the beam. If INTENSITY is

properly set, the beam will remain visible when FIND BEAM is released.

3-11. **MAGNIFIER.** This control varies the gain of the horizontal amplifier. When switched from X1 to X5 or X10 the gain increases five or ten times respectively. For example, one volt into the vertical amplifier plug-in Ext Input jack produces 1 div of deflection in X1, 5 div of deflection in X5, and 10 div of deflection in X10.

3-12. **DISPLAY.** This control determines the origin of the input signal applied to the horizontal amplifier. With the DISPLAY control positioned to EXT CAL, the external horizontal input signal is coupled directly to the horizontal amplifier. As DISPLAY is rotated ccw, the external signal is increasingly attenuated. When DISPLAY is fully ccw (INT), the external input signal is disconnected and the internal sweep is coupled directly to the horizontal amplifier.

3-13. REAR PANEL.

3-14. **OUTPUTS.** Main and delayed sweep and gate signals are available at rear-panel BNC connectors of the Model 180F, and supply signals from the plug-ins to external equipment. These outputs are provided from separate isolation amplifiers which can supply 3 mA and will drive impedances as low as 1000 ohms without distortion. The plug-ins used in the Model 180F and the control settings employed determine the output signals available. Refer to the Operating and Service Manual for the plug-in to determine signal identification.

3-15. **Z-AXIS INPUT.** An external signal can be utilized to control the CRT intensity. A rear-panel mounted BNC connector allows application of an external intensity modulation signal directly to the CRT intensity gate amplifier. A pulse of approximately +2V amplitude and a width of at least 50 nanoseconds or a +2V cw input of 10 MHz or lower will blank a trace of normal intensity. Input of a negative signal can be used for beam intensification.

3-16. **AC LINE INPUT.** A three-conductor ac input power cord is provided for ac input. Also located on the rear panel is the 115/230V selector slide switch, and the operating and spare line fuses. Both sides of the ac input line are fused.

3-17. INTERNAL.

3-18. Positioning the PHASE/BANDWIDTH switch to PHASE causes the horizontal input signal to be delayed the same amount of time as the vertical input signal. This delay allows the Model 180F to be used for phase

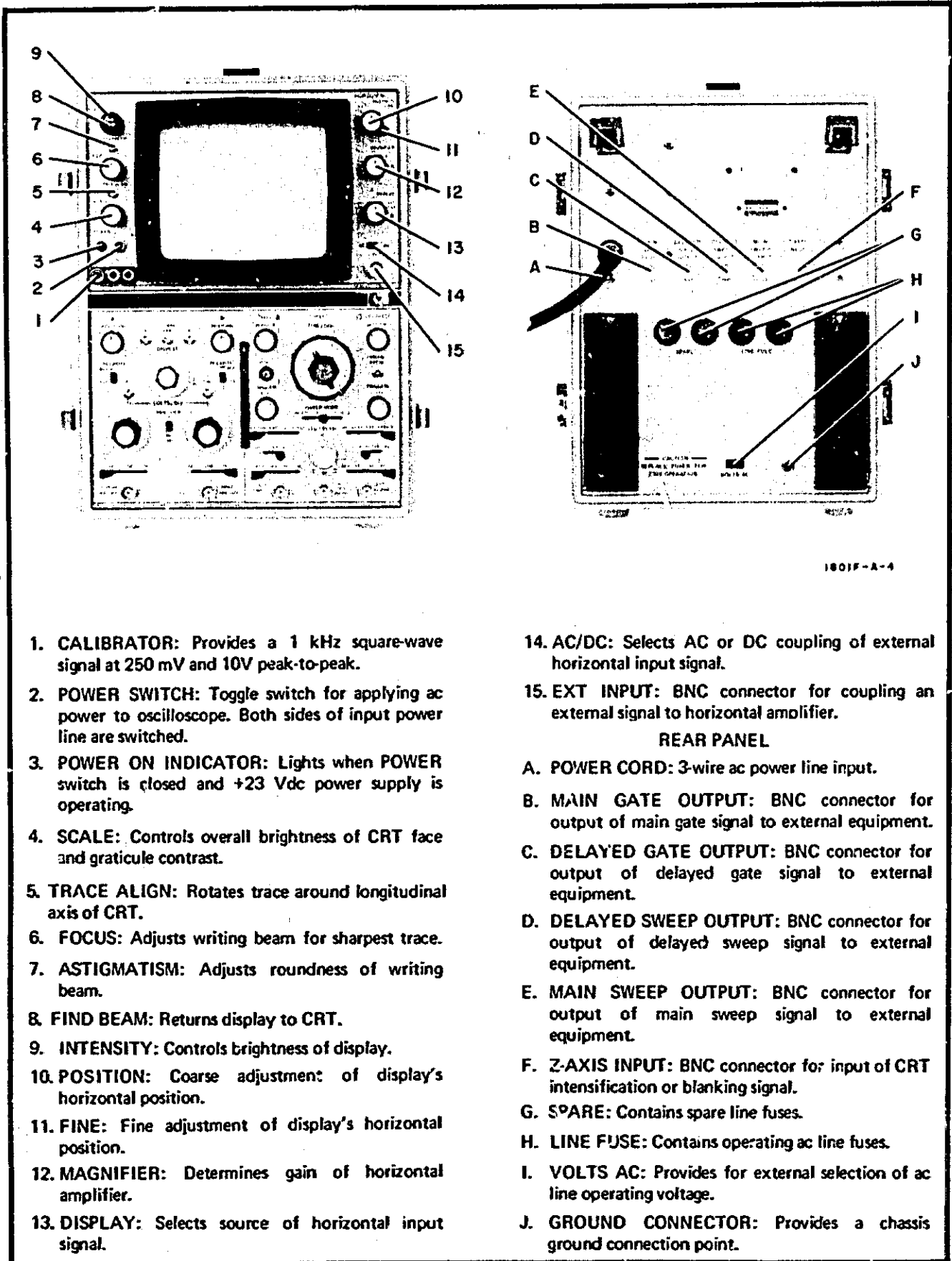

Figure 3-1. Front and Rear-panel Controls and Connectors

measurements. Channel A of multi-channel vertical plug-ins should be used when making phase measurements. Refer to Paragraph 5-29e for calibration procedures when a different channel (other than A) is to be used, or when changing from one vertical plug-in to another.

Note

Make certain that the switch is placed to BANDWIDTH after making phase measurements. This will allow normal operation.

3-19. PLUG-IN UNITS.

3-20. The Model 180F Oscilloscope requires horizontal and vertical plug-in units. The deflection sensitivity of the CRT may vary slightly with different units. Plug-ins should be calibrated when first installed or when shifted between oscilloscopes. The horizontal and vertical plug-in units must be locked together prior to insertion into the Model 180F. Consult the respective plug-in Operating and Service Manual for operation and capability information.

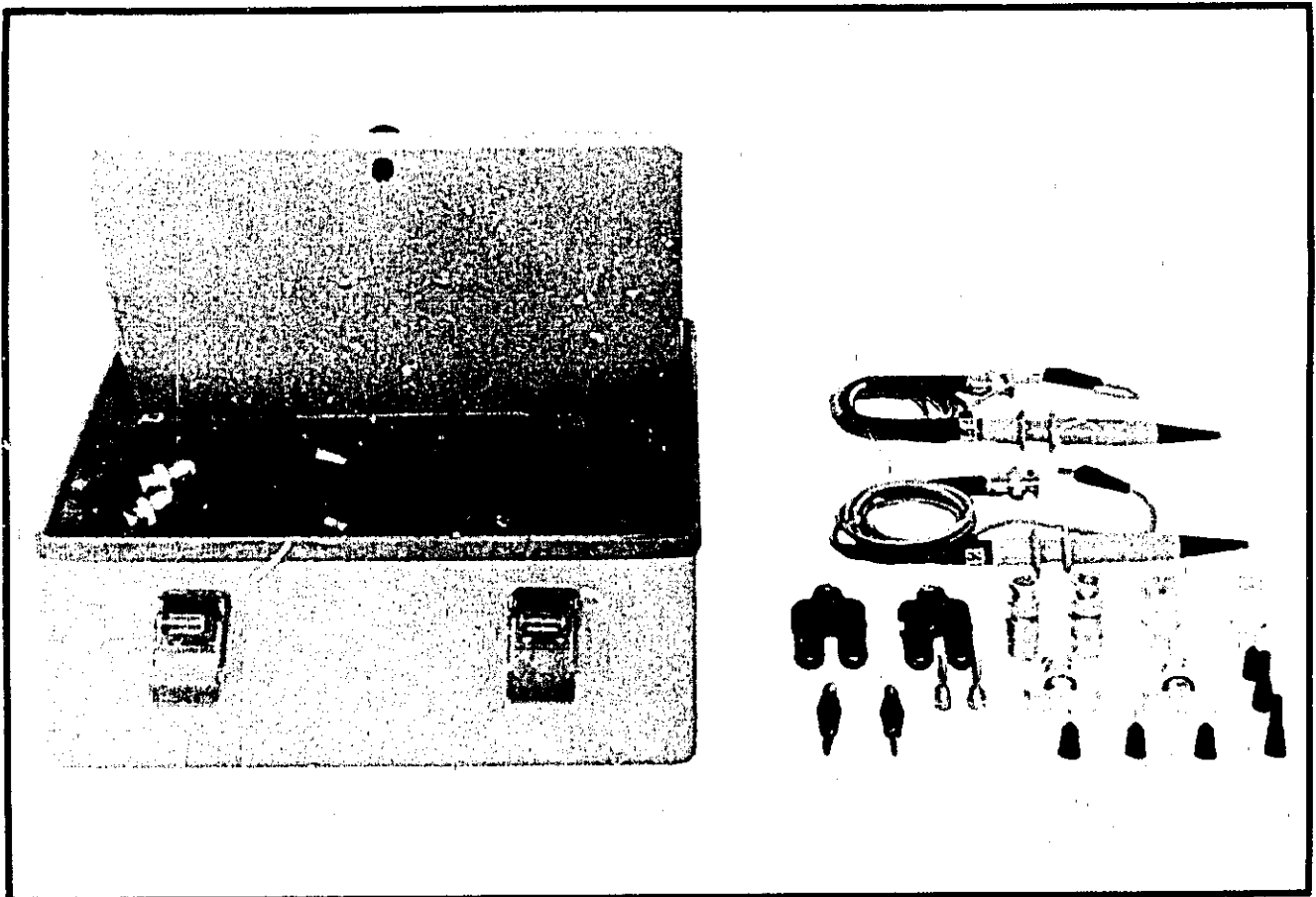

Figure 3-2. Accessory Cover, HP Model 101648 Opt 21

THEORY

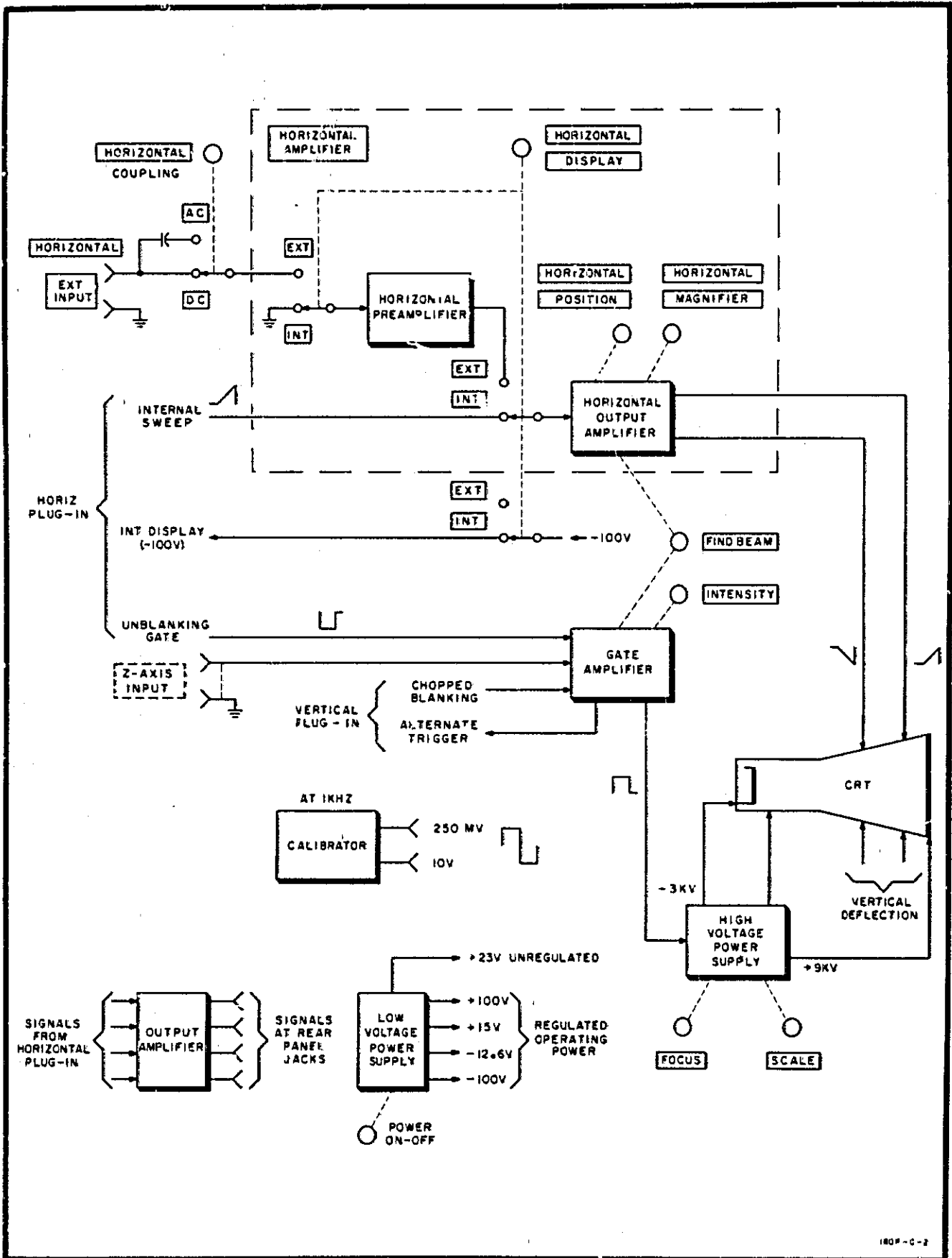

Figure 4-1. Model 180F Overall Block Diagram

SECTION IV PRINCIPLES OF OPERATION

4-1. INTRODUCTION.

4-2. The Model 180F Oscilloscope is comprised of four basic circuits. These are: a gate amplifier, a horizontal amplifier, a high-voltage power supply, and a low-voltage power supply. Two associated circuits, also contained, are a calibrator and an output amplifier. Figure 4-1 shows the interrelationship of these circuits.

4-3. FUNCTIONAL DESCRIPTION.

4-4. Three input signals; intensity, horizontal deflection, and vertical deflection; are necessary to obtain a usable display on the CRT. The circuitry for the intensity and horizontal deflection signals is explained in the following paragraphs which are referenced to Figure 4-1. The vertical deflection signal is coupled directly to the CRT from the Vertical Plug-in.

4-5. **INTERNAL.** Positioning the HORIZONTAL DISPLAY switch to INT applies -100 volts to the Horizontal Plug-in. This voltage allows the plug-in to operate normally and to produce the unblanking gate and the internal sweep signal.

4-6. The unblanking gate is coupled from the Horizontal Plug-in to the gate amplifier where it is summed with the Z-axis input and chopped blanking signals (if they are applied). The resulting signal is amplified, and coupled through the high voltage power supply to the control grid of the CRT to control the intensity of the display.

4-7. The alternate trigger signal is a negative pulse produced by the gate amplifier at the end of each unblanking gate. It is coupled directly to the Vertical Plug-in (refer to Vertical Plug-in manual for signal function).

4-8. The internal sweep signal from the Horizontal Plug-in is coupled through the HORIZONTAL DISPLAY switch to the output amplifier. Here it is converted to a differential signal, amplified, and applied to the CRT horizontal deflection plates.

4-9. **EXTERNAL.** Positioning the HORIZONTAL DISPLAY switch to EXT removes the internal display voltage from the Horizontal Plug-in, eliminating both the unblanking gate and the internal sweep signal.

4-10. The gate amplifier operates as it did when INT was selected. There are; however, only two inputs to the gate amplifier: an externally applied intensity modulation signal (Z-axis input) and the chopped blanking signal from the Vertical Plug-in. The alternate trigger signal will be produced only if the externally applied signal is similar to the normal unblanking gate.

4-11. The externally applied deflection signal is coupled through the horizontal preamplifier to the output amplifier where it is amplified and converted to a differential signal and then applied to the CRT horizontal deflection plates.

4-12. CIRCUIT DETAILS.

4-13. The following paragraphs contain a detailed explanation of each circuit in the Model 180F.

4-14. GATE AMPLIFIER.

4-15. The inputs to the gate amplifier (refer to Figure 4-2) are the unblanking gate, the chopped blanking signal, and the Z-axis input signal. These three signals may be present either singly or simultaneously, depending upon control

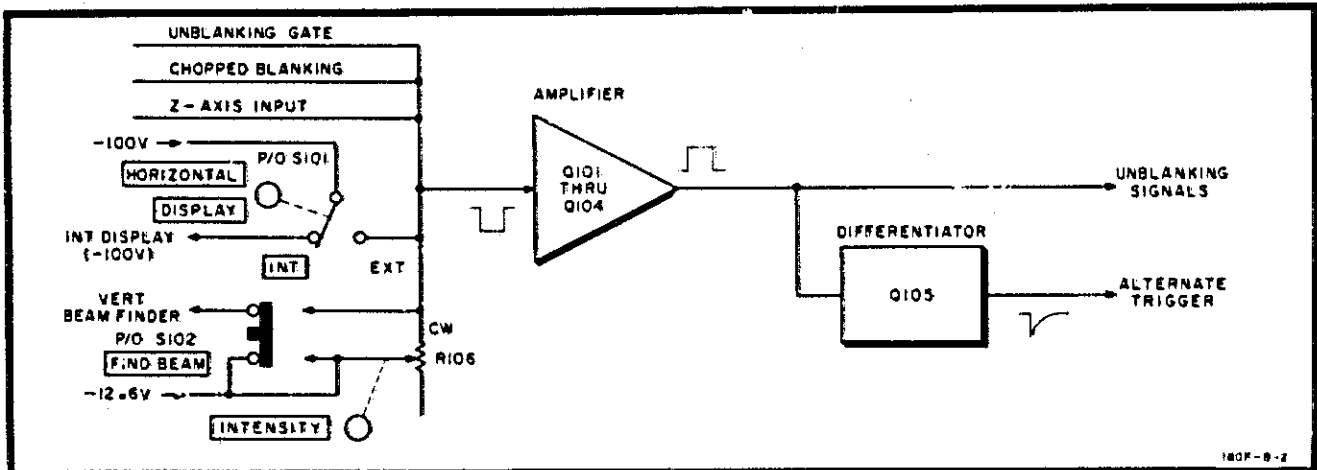

Figure 4-2. Gate Amplifier Block Diagram

settings. These inputs are combined with a current established by three front-panel controls: FIND BEAM, INTENSITY, and HORIZONTAL DISPLAY. Depressing FIND BEAM shunts the normally adjustable INTENSITY potentiometer and supplies maximum current from this source. Setting HORIZONTAL DISPLAY to EXT supplies additional current to brighten the beam.

4-16. The input current to amplifier Q101 through Q104 is converted to a voltage, amplified, and coupled to the control grid of the CRT. The output signal is also differentiated, clipped, and coupled to the Vertical Plug-in.

4-17. The input currents to the gate amplifier (refer to Figure 8-6, schematic) are summed in the low impedance emitter circuit of Q101. The resulting current is coupled to the complementary feedback amplifier (a current-fed operational amplifier) Q102/Q103/Q104, where it is converted to a voltage, and coupled to the control grid circuit of the CRT. The output voltage is approximately:

$$\Delta E_{Q104 \text{ COLLECTOR}} \approx (\Delta I_{CR101}) (R_{R119} \& R_{R121})$$

The large negative feedback from the collectors of Q103 and Q104 to the base of Q102 provides the complementary feedback amplifier with a very stable gain. C110 and C113 adjust the high-frequency feedback. CR108 provides temperature compensation for Q103. CR109 and CR110 protect Q103 and Q104 from voltage breakdown. CR112 and CR113 isolate Q103 and Q104 from the high voltage in the control grid circuit of the CRT in the event of a grid or cathode short. The output from Q103 and Q104 is differentiated by C116, R128, and R130, and coupled through Q105 to the Vertical Plug-in. CR111 is a positive clipper.

4-18. HORIZONTAL AMPLIFIER.

4-19. The inputs to the horizontal amplifier (refer to Figure 4-3) are the internal sweep signal and an external signal applied to the HORIZONTAL EXT INPUT jack. Positioning HORIZONTAL DISPLAY to INT disconnects the external signal and grounds the input of the preamplifier. The internal sweep signal is connected through the HORIZONTAL DISPLAY switch to the output amplifier.

4-20. Selecting either EXT SENS or EXT CAL disconnects the internal sweep signal and connects the external signal through the preamplifier to the output amplifier. With EXT SENS selected, the amplitude of the signal from the preamplifier is adjustable by rotating HORIZONTAL DISPLAY between the extreme positions. In EXT CAL, R211 is shorted and the output amplitude is determined only by the input amplitude.

4-21. The selected signal is applied to the output amplifier and summed with a current established by the HORIZONTAL POSITION control. The resulting current is converted to a differential signal, amplified, and applied to the horizontal deflection plates of the CRT.

4-22. The external signal applied to the preamplifier (refer to Figure 8-9, schematic) is coupled through Q201 and Q202 to the HORIZONTAL DISPLAY switch, S101. The high input impedance of Q201 prevents loading the external circuit. Q202 provides the low impedance necessary to drive Q203. CR201 protects Q201 from voltage breakdown. C203 and C204, when switched in, decrease the bandwidth of the preamplifier. The decreased bandwidth compensates for the signal delay in the Vertical Plug-in and allows more accurate X-Y phase measurements to be made. R207 is adjusted for 0 Vdc across R211, eliminating horizontal dc shift as HORIZONTAL DISPLAY is rotated.

4-23. The input signal to Q203 is summed in the low impedance emitter circuit with a current established by the POSITION controls. The resulting signal is coupled from the emitter of Q206 through emitter follower Q204 to differential amplifier Q206/Q207. Q204 provides the low impedance necessary to drive Q206. The input signal to Q206 is coupled through the MAGNIFIER switch, S203, to Q207. S203 selects the amount of emitter degeneration between Q206 and Q207, and therefore controls the gain; as degeneration decreases, gain increases. R250, R248, and R246 adjust the gain in the X1, X5, and X10 positions, respectively, of S203. R253 adjusts the emitter potentials of Q206 and Q207 to be equal, preventing horizontal dc shift as the MAGNIFIER control is switched. Q205 provides a low impedance voltage source for the base of Q207. The differential signal at the collectors of Q206 and Q207 is applied to complementary feedback amplifiers (current-fed operational amplifiers)

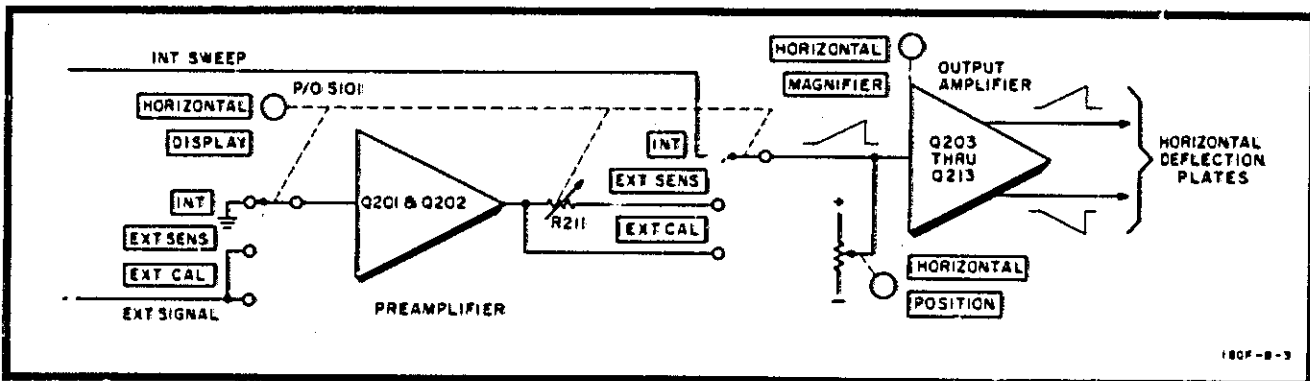

Figure 4-3. Horizontal Amplifier Block Diagram

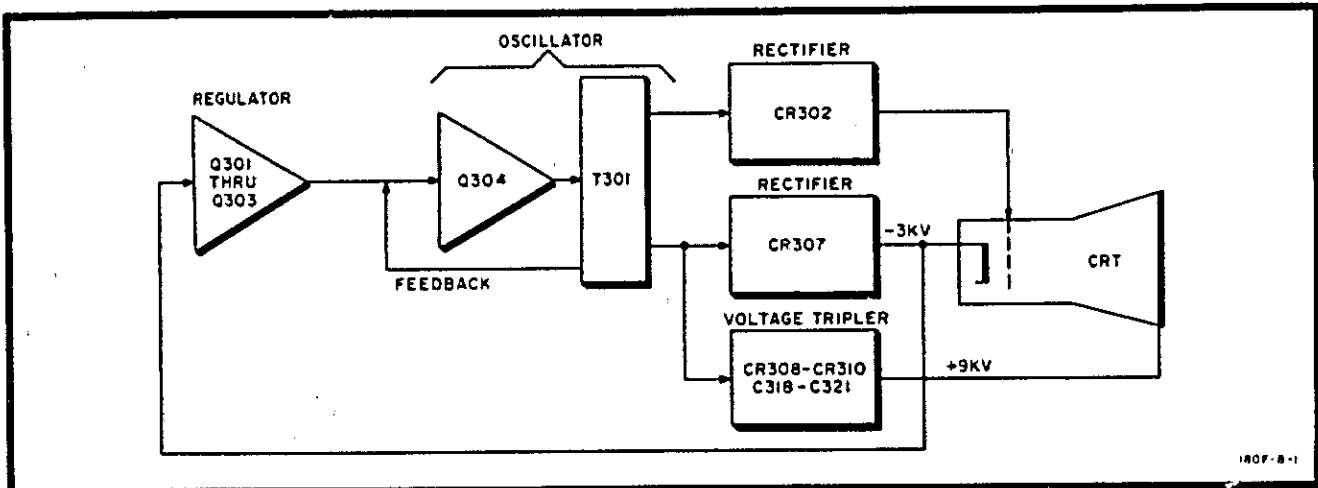

Figure 4-4. HVPS Block Diagram

Q208/Q209/Q210 and Q211/Q212/Q213, converted to a voltage, and coupled to the horizontal deflection plates of the CRT. CR203 and CR206 prevent Q206 and Q207, respectively, from saturating. Diodes CR202/CR204 and CR207/CR208 limit the output to the deflection plates between +6 and +94 volts regardless of the input amplitude. Depressing the FIND BEAM control disables limiter CR207/CR208 and blocks the signal to Q211. The differential gain is effectively cut in half and the electron beam is confined to the horizontal limit of the CRT screen. The gain of the complementary feedback amplifier is very stable because of the large negative feedback from the collectors of Q209/Q210 and Q212/Q213 to the bases of Q208 and Q211, respectively. C210 and C229 adjust the high frequency feedback of each amplifier individually while C213 adjusts the feedback for both. CR205 and CR209 provide temperature compensation for Q210 and Q213.

4-24. HIGH-VOLTAGE POWER SUPPLY (HVPS).

4-25. The high voltage power supply (refer to Figure 4-4) produces three regulated voltages: -2950 V, ≈+9 kV, and a control grid bias voltage. All three voltages are regulated by sampling the -2950 volt supply.

4-26. The 50 kHz output from oscillator Q304/T301 (refer to Figure 8-12, schematic) is coupled to two half-wave rectifiers, CR302 and CR307, and to a voltage tripler circuit. The pulsating dc from CR302 is filtered and applied to the control grid of the CRT. R326 adjusts the dc potential on the grid. The pulsating dc from CR307 is filtered and applied to the cathode of the CRT. V301 and V302 limit the potential difference between the cathode and the control grid to 140 volts. The ac voltage applied to CR307 is also coupled to a voltage tripler, CR308-CR310 and C318-C321. The +9 kV output from the tripler is applied to the post-accelerator of the CRT.

4-27. Changes in the cathode voltage are coupled through the regulator Q301-Q303 to the oscillator Q304/T301.

Assume the cathode voltage decreases (goes positive); a positive-going signal is applied through the regulator to the base of Q304; Q304 conducts for a greater portion of the input cycle and causes a greater voltage change across the primary of T301, thus increasing the voltage across the secondary. R302 adjusts the quiescent dc on the base of Q304 and controls the CRT cathode potential. L301 prevents the oscillator from running at 1 MHz. C308 provides an ac ground so that the oscillator's feedback is felt on the base of Q304.

4-28. LOW-VOLTAGE POWER SUPPLY (LVPS).

4-29. The low-voltage power supply produces five dc voltages. The -100, -12.6, +15, and +100 volt supplies are regulated and used throughout the Model 180F and plug-ins. The unregulated +23V supply is used only by the HVPS and the pilot lamp. A regulated +105 volt supply is also produced, however it is used only within the LVPS.

4-30. Figure 4-5 shows a basic regulated power supply. It is like a voltage divider in that the entire applied voltage must be dropped across the series regulator and the parallel combination of the load and the sensing device. If the voltage across the load were to change, the sensing device would detect the change and cause the resistance of the series regulator to change and correct the output.

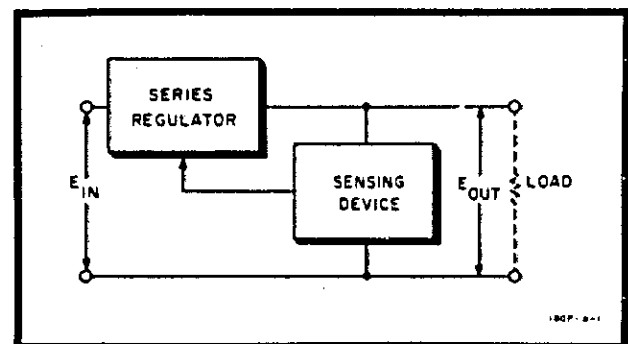

Figure 4-5. Basic Regulated Power Supply

4-31. Refer to the LVPS schematic diagram, Figure 8-15. Closing S401 supplies power through rear-panel switch S402 to the primary of T401. S402 connects the primary windings in either series or parallel for 230-volt or 115-volt operation, respectively.

4-32. AC voltages from the secondary windings of T401 are full-wave rectified by bridge circuits. The resulting dc voltages are filtered and applied to the regulating circuits described in the following paragraphs.

4-33. The -100V supply output is used as a reference for the other regulating circuits. It must be adjusted first since its amplitude will affect the other outputs.

4-34. -100-VOLT SUPPLY. The level of the -100 V supply output voltage is controlled by a series regulator, Q414, in the supply ground path. Any change in output voltage is sensed by Q415 and Q416 which are connected in a differential amplifier configuration. The adjustable tap of R449 provides a sample of the supply output voltage which is used to control the conduction of Q416. Voltage regulator V402 maintains a constant voltage drop of 82 volts, and in conjunction with R444 divides the supply output voltage so that the total variation in output voltage will be sensed by Q415. If an increase in the load current requirement occurs, a decrease in output voltage will be observed, resulting in a positive-going (less negative) signal on the base of Q416, with a larger change being sensed by Q415. This causes Q415 to conduct more positive. Thus, the variation in output voltage is sensed and amplified. The positive-going change is coupled from the single-ended output of Q416 to the base of Q413. Driver Q413 controls the base bias level of Q414. The series regulator will therefore compensate for the change in output voltage by decreasing its series resistance to return the supply output voltage to the desired level. Temperature compensation for Q416 is provided by Q415. High-frequency variations in the driver input signal are filtered by C425 and R442 to prevent oscillation. Transistors Q415 and Q416 are protected by CR433 and CR434, while CR432 prevents voltage breakdown from the base of Q413 to the emitter of Q414. Overload current protection is furnished by F406, and CR430 protects against possible reverse charging of C427 in the event F406 opens.

4-35. +100-VOLT SUPPLY. The operation of the +100 V supply is similar to the -100 V supply. Q403 and Q404 operate as a differential amplifier, with Q404 sensing any variation in output or change in relation to the regulated -100 V supply. Voltage regulator V401 and R407 divide the supply output voltage, and Q403 senses the total variation in output voltage. Protection against excessive current is provided by F403, and CR412 prevents the output filter capacitor, C408, from reverse charging if the fuse opens. Temperature compensation for Q404 is provided by Q403.

4-36. +105-VOLT SUPPLY. A dc voltage from rectifier CR401-CR404 is applied across R401 and breakdown diode VR401. Zener action keeps the top of VR401 five volts more positive than the bottom, which is at +100 V.

This +105-volt potential at the top of VR401 provides bias current for Q402 and Q404.

4-37. -12.6-VOLT SUPPLY. Part of the voltage from the -12.6 V rectifier filter is dropped across the series regulator and R430, the rest is dropped across the load. Any variation in the output will be coupled through Q412 and Q409 to the base of the series regulator. Q412 provides a voltage gain, while Q409 provides a current gain. C419 and R428 shunt high frequencies to prevent oscillation. CR425 provides temperature compensation for Q412. CR420 protects Q412 from base to emitter voltage breakdown.

4-38. Current limiter, Q411, and R430 form a protective circuit for the series regulator. If the output is shorted, the voltage drop across R430 turns Q411 on. The resulting negative signal from the collector of Q411 is coupled through the driver to the series regulator, turning it off. The output current is limited to the current necessary to keep Q411 turned on.

4-39. +15-VOLT SUPPLY. The +15 V supply is similar to the -12.6 V supply. Changes in output voltage are applied to the base of Q408, amplified, and coupled through Q405 to series regulator Q406. Current limiting action is provided by R419 and Q407.

4-40. SUPPLY CURRENT AVAILABLE. Table 4-1 lists the current available from each power supply. There is no minimum current requirement for any supply.

Table 4-1. LVPS Current Capabilities

Power Supply	Maximum Safe Current Available
+100 VDC	160 mA
+15 VDC	420 mA
-12.6 VDC	725 mA
-100 VDC	80 mA

4-41. CALIBRATOR.

4-42. The schematic diagram of the calibrator is in Figure 8-6. Q106 and Q107 comprise a free-running multivibrator whose output is a 1 kHz square wave at two amplitudes, 250 mV and 10 V. CR116 and CR117 protect Q106 and Q107 from voltage breakdown. CR115 disconnects the collector of Q107 from C122 as Q107 turns off, providing a faster risetime. The two outputs are supplied to front-panel connectors and may be used for probe compensation and sensitivity calibration.

4-43. OUTPUT AMPLIFIERS.

4-44. The output amplifiers (refer to Figure 8-6, schematic) are four emitter followers (Q108-Q111) that couple signals from the Horizontal plug-in to rear-panel connectors. Check the specific plug-in manual to determine what signals are actually applied to the rear panel connectors.

PERFORMANCE CHECK

ADJUSTMENTS

SECTION V

PERFORMANCE CHECK AND ADJUSTMENTS

5-1. INTRODUCTION.

5-2. This section provides the performance check (Paragraph 5-5) and the adjustment procedure (Paragraph 5-17) for the Model 180F. Troubleshooting information, schematic diagrams, and component identification are located in Section VIII.

5-3. TEST EQUIPMENT.

5-4. Test equipment required for maintaining and checking the performance of the Model 180F is listed in Table 5-1. Test equipment having characteristics similar to those listed in the table may be used for the performance check and adjustments.

5-5. PERFORMANCE CHECK.

5-6. The performance check verifies whether or not the Model 180F is operating within the specifications as stated in Table 1-1. This check may be used as part of an incoming quality control inspection, as a periodic operational check, or after repair and/or adjustments have been made. Recently calibrated test equipment should be used when performing the check.

5-7. A Performance Check Record form is included in this manual on Page 5-5/5-6. As the initial performance check is accomplished, the actual readings should be entered on the form. The form should then be removed

Table 5-1. Required Test Equipment

Recommended Test Equipment		Required Characteristics	Reference Paragraph
Type	Model		
Voltmeter Calibrator	HP Model 738AR, 6920B, or E02-7388R	1, 2, and 10 V pk-pk $\pm 0.2\%$	5-11, step b; 5-12, steps b and d
Monitor Oscilloscope	HP Model 180A/AR w/1801A and 1820A plug-ins	Sensitivity 1 V/div sweep speed 1 usec/div risetime < 3 usec sweep output	5-11, step g; 5-28, step b 5-29, step d, 1
10:1 Divider Probe	HP Model 10004A	$\pm 3\%$	5-28, step c
Constant Amplitude Signal Generator	Tektronix Type 190B/191	50 kHz – 50 MHz @ 10 V pk-pk	5-13, step a; 5-29, step d, 7
Digital Voltmeter	HP Model 3440A w/3441A or 3444A plug-in	± 100 Vdc $\pm 0.05\%$	5-22, step a;
DC Voltmeter	HP Model 410B	30 Vdc $\pm 2\%$	5-23, step a
100:1 Divider Probe	HP Model 11044A	3000 Vdc	5-23, step a
Ammeter	HP Model 3440A w/3444A Plug-in	0.20 mA – 2.5 mA $\pm 0.2\%$	5-29, step c, 3
DC Power Supply	HP Model 6204B	2.5 mA $\pm 0.3\%$	5-29, step c, 3
Square Wave Generator	HP Model 211A/B	200 kHz 1 V pk-pk risetime ≤ 30 nsec	5-29, step d, 3
Oscillator	HP Model 200CD	100 kHz @ 10 V pk-pk	5-29, step e, 2

from the manual and filed in a safe place so that readings taken at a later date can be compared with the original readings.

5-8. The performance check must be done in the sequence given below. Do not attempt to start the procedure in mid-sequence, as succeeding steps are dependent upon control settings and results of previous steps.

5-9. PRELIMINARY SET-UP.

5-10. Apply power to the Model 180F and allow a fifteen minute warm-up. Do not install plug-ins.

5-11. CALIBRATOR.

a. Set controls as follows:

MAGNIFIER X5
HORIZONTAL DISPLAY EXT CAL
HORIZONTAL Coupling AC

b. Connect a 10 V pk-pk signal from Voltmeter Calibrator output to HORIZONTAL EXT INPUT.

c. Obtain a horizontal trace by adjusting INTENSITY and POSITION controls.

d. Adjust HORIZONTAL DISPLAY for 10 div of deflection.

e. Disconnect Voltmeter Calibrator and connect CALIBRATOR 10 V output to HORIZONTAL EXT INPUT.

f. Trace is 10 div ± 1 minor div long.

g. Observe CALIBRATOR 10 V output using the Monitor Oscilloscope.

h. Risetime of calibrator waveform should be less than 3 usec.

5-12. MAGNIFIER.

a. Set MAGNIFIER to X1 and HORIZONTAL DISPLAY to EXT CAL.

b. Connect a 10 V pk-pk signal from Voltmeter Calibrator output to HORIZONTAL EXT INPUT.

c. Deflection is 10 div $\pm 1/2$ div.

d. Repeat above procedure setting MAGNIFIER to X5 with 2 V pk-pk signal, and X10 with a 1 V pk-pk signal. Deflection is 10 div $\pm 1/2$ div. in each case.

5-13. BANDWIDTH.

a. Connect a 50 kHz signal from Constant Amplitude Signal Generator to HORIZONTAL EXT INPUT.

b. Set MAGNIFIER to X1. Adjust Signal Generator amplitude for 10 div of deflection.

c. Increase frequency to 5 MHz. Deflection is 7.1 div or greater. (If deflection is less than 2 div check that Phase/Bandwidth switch is in Bandwidth.)

5-14. BEAM FINDER.

a. Rotate INTENSITY and HORIZONTAL POSITION fully ccw.

b. Depress FIND BEAM.

c. Intensified beam appears on screen.

5-15. COVER REMOVAL.

5-16. To gain access to the adjustments and test points, the oscilloscope cover must be removed. Remove the cover as follows:

a. Insure that power switch is off.

b. Disconnect power plug from ac line.

c. Set oscilloscope on rear end.

d. Release 4 latches (Figure 5-1) at rear of oscilloscope.

e. Lift oscilloscope cover straight up to remove.

5-17. ADJUSTMENTS.

5-18. Procedures for adjusting the Model 180F are given in Paragraphs 5-19 through 5-29. Required test equipment is listed in Table 5-1. Test equipment with similar characteristics may be substituted if necessary. Figure 5-2 shows the location of adjustments in the Model 180F.

5-19. The adjustment procedure must be done in the sequence given below. Do not attempt to start the procedure in mid-sequence, as succeeding steps are dependent upon control settings of previous steps.

5-20. PRELIMINARY SET-UP.

5-21. Install plug-ins in Model 180F. Turn power on and allow a fifteen minute warm-up. Make certain that Phase/Bandwidth switch is in Bandwidth position.

5-22. LOW-VOLTAGE POWER SUPPLY.

a. Connect the Digital Voltmeter to each test point in Table 5-2.

b. Make the proper adjustment to obtain the indicated voltage.

Table 5-2. Low Voltage Adjustments

Test Point	Measure	Adjust
TP404	-100 V ±0.1 V	R449
TP401	+100 V ±0.1 V	R412
TP403	-12.6V ±0.1V'	R434
TP402	+15V ±0.1V	R423

5-23. HIGH-VOLTAGE POWER SUPPLY.

- a. Monitor the -100 Vdc at TP404 with the DC Voltmeter using a 100:1 Divider Probe.
- b. Observe and note the voltage reading, which will be approximately -1.000 volt. Accuracy in noting the obtained voltage is essential for proper adjustment.
- c. Multiply the reading obtained in step b by 29.50.
- d. Monitor the High Voltage at TP301 with the DC Voltmeter using a 100:1 Divider Probe.

WARNING

This voltage is dangerous to life.

- e. Adjust R302 to obtain a voltage reading exactly equivalent to the result obtained in step c, (approximately -29.50V)
- f. The required high-voltage output of the supply is -2950 V ±0.5%.

5-24. ASTIGMATISM.

- a. Set HORIZONTAL DISPLAY to EXT CAL and Vertical Display to A.
- b. Center spot with Horizontal and Vertical POSITION controls.
- c. Adjust FOCUS and ASTIGMATISM for the smallest round spot.

5-25. INTENSITY LIMIT.

- a. Set HORIZONTAL DISPLAY to EXT CAL and rotate INTENSITY to 10 o'clock position.
- b. Adjust R326 until spot disappears.

5-26. FLOOD GUN.

- a. Rotate INTENSITY fully ccw and SCALE fully cw.
- b. Rotate R348 fully cw and then slowly ccw until entire screen is at a uniform intensity.
- c. Rotate SCALE fully ccw.

5-27. TRACE ALIGNMENT.

- a. Set HORIZONTAL MAGNIFIER to X1 and HORIZONTAL Coupling to AC.
- b. Connect CALIBRATOR 10 V output to HORIZONTAL EXT INPUT.
- c. Rotate INTENSITY cw to view trace.
- d. Adjust TRACE ALIGN to make trace parallel with center graticule line.
- e. Connect CALIBRATOR 10 V output to Channel A Input.
- f. Set Vertical Plug-in controls as follows:
 - Channel A Polarity +UP
 - Channel A Volts/div 1
 - Channel A Vernier CAL
 - Channel A Coupling AC
- g. Adjust R336 to align trace parallel with center graticule line.
- h. Disconnect CALIBRATOR from Vertical INPUT.

5-28. GATE AMPLIFIER RESPONSE.

- a. Set following controls as applicable:
 - HORIZONTAL DISPLAY INT
 - Main Time/div 0.1 uSEC
 - Main Vernier CAL
 - Sweep Mode AUTO
 - Sweep Display MAIN
 - Delayed Time/div OFF
- b. Set Monitor Oscilloscope controls as follows:
 - Volts/div 1
 - Time/div 0.1 uSEC
 - Trigger Source INT
 - Slope +
 - Coupling DC
- c. Observe signal on collector of Q103 using a 10:1 Divider Probe. Adjust INTENSITY control to cause observed signal to shift upwards by 2 minor div.
- d. Adjust C110 and C113 for optimum fast risetime and a flat response.

5-29. HORIZONTAL AMPLIFIER.

- a. DC BALANCE.
 - 1. Set MAGNIFIER to X10 and HORIZONTAL DISPLAY to EXT CAL. Center spot with HORIZONTAL POSITION.

2. Set MAGNIFIER to X1 and recenter spot with R253.

3. Repeat steps 1 and 2 until spot does not shift position when MAGNIFIER is switched from X10 to X1.

b. VERNIER BALANCE.

1 Set MAGNIFIER to X10.

2. Rotate HORIZONTAL DISPLAY fully ccw (not into INT) and center spot with HORIZONTAL POSITION.

3. Rotate HORIZONTAL DISPLAY to EXT CAL and adjust R207 to recenter spot.

4. Repeat Steps 2 and 3 until spot does not shift when HORIZONTAL DISPLAY is rotated from fully ccw (not in INT) to EXT CAL.

c. GAIN.

1. Set HORIZONTAL MAGNIFIER to X1 and HORIZONTAL DISPLAY to EXT CAL.

2. Adjust Horizontal and Vertical POSITION to center spot on left edge of graticule.

Note

Table 5-3 lists the currents necessary to calibrate the horizontal gain. They should be accurate to 0.3% if plug-in interchangeability is desired.

3. Inject the current specified in Table 5-3 into the emitter of Q203. Spot should be at right edge of graticule.

Table 5-3. Gain Adjust

MAGNIFIER	INJECT	ADJUST
X1	2.5 mA	R250
X5	0.5 mA	R248
X10	0.25 mA	R246

4. Perform the adjustment specified in Table 5-3 to take up half of the difference between the spot and the right edge of the graticule.

Note

If 10 div of deflection can not be obtained by adjusting R250 and the CRT has been replaced, it may be necessary to select a new value for R251.

5. Repeat steps 2 through 4 until spot deflects 10 div.

6. Set HORIZONTAL MAGNIFIER to X5 and repeat steps 2 through 5 using applicable information in Table 5-3.

7. Set HORIZONTAL MAGNIFIER to X10 and repeat steps 2 through 5 using applicable information in Table 5-3.

d. TRANSIENT RESPONSE.

1. Connect a 1 usec/div sweep signal from the Monitor Oscilloscope to the Channel A Input of the Vertical Plug-in.

2. Adjust Channel A Volts/div and Vernier controls for an 8 div display.

3. Connect a 200 kHz 1 V pk-pk, square wave from the Square Wave Generator to the Model 180A/AR HORIZONTAL EXT INPUT.

4. Synchronize the Monitor Oscilloscope with the 200 kHz signal.

5. Observe the waveform on the Model 180A/AR and adjust C210, C213, and C229 for best response on lower right-hand corner of the waveform.

Note

C210 and C229 should be adjusted so their slugs are almost equally extended.

6. Set controls as follows:

HORIZONTAL DISPLAY INT
 Channel A Volts/div 1
 Channel A Vernier CAL

7. Connect a 50 MHz sine wave at approximately 4 V pk-pk from the Constant Amplitude Signal Generator to Channel A Input.

8. Select the fastest sweep speed and obtain a display. (.1 usec/div, HORIZONTAL MAGNIFIER: X10).

9. Readjust C210, C213 and C229 for best overall linearity of the center 80 divisions of available display, using the HORIZONTAL POSITION control to permit viewing the left, center and right portions of the display. C210 affects the left portion, C213 the center and C229 the right portion of the sweep.

e. PHASE.

1. Set controls as follows:

Phase/Bandwidth Phase
 HORIZONTAL MAGNIFIER X1
 HORIZONTAL DISPLAY EXT CAL

2. Connect a 100 kHz sine wave from the Oscillator to HORIZONTAL EXT INPUT and to Channel A Input.

Note

Under normal conditions, only Channel A should be used (when using a multi-channel Vertical Plug-in). If another channel must be used, perform this procedure for that channel instead of A.

3. Adjust Oscillator amplitude for an 8 div display.

4. Adjust C203 for a single diagonal line on the CRT (no phase shift).

5. Return Phase/Bandwidth switch to Bandwidth position before replacing cover.

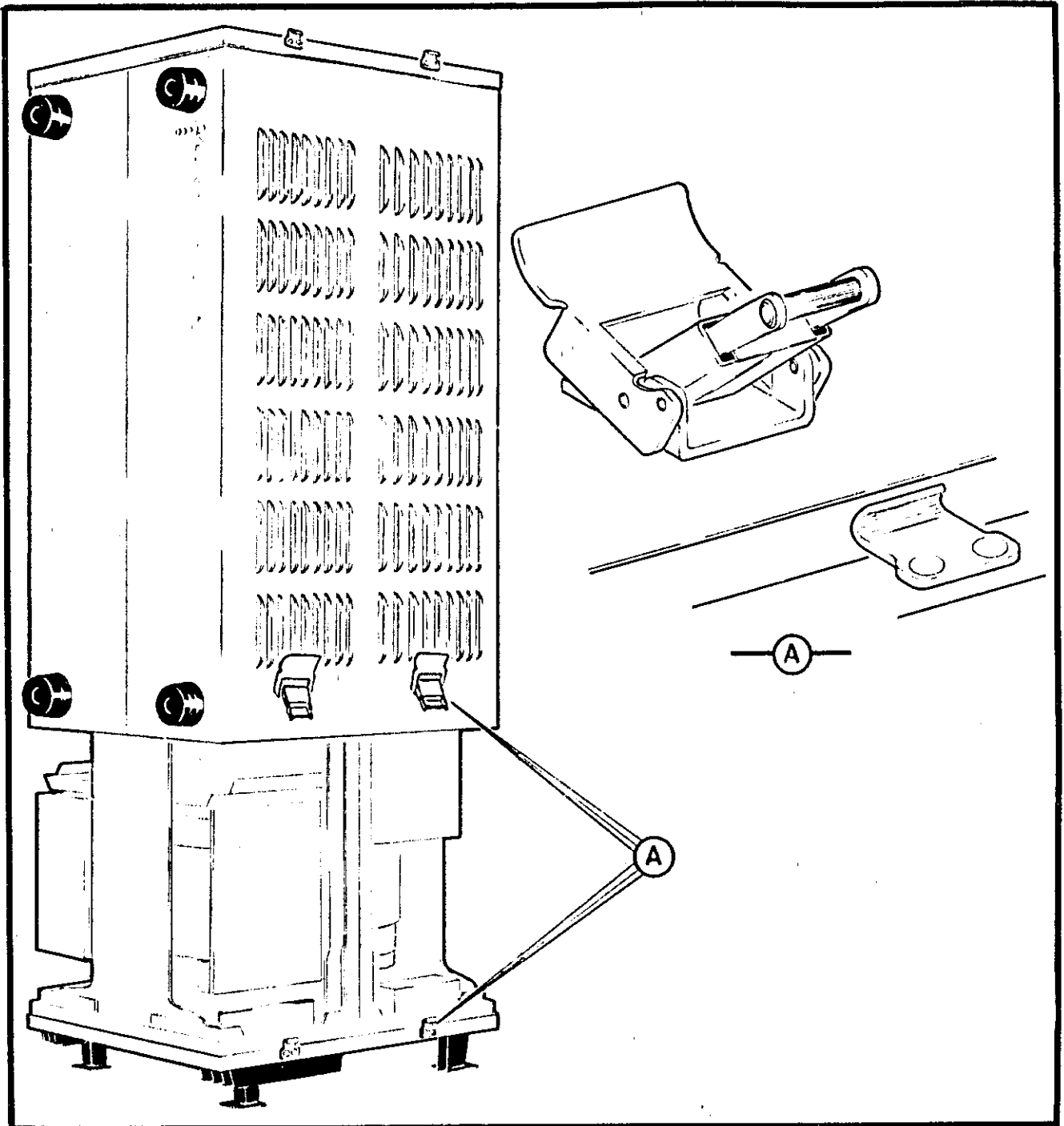

Figure 5-1. Cover Removal

HP MODEL 180F

Serial Number: _____

_____ Date

PERFORMANCE CHECK RECORD

Paragraph	Check	Minimum	Reading	Maximum
5-11 step f step h	<u>Calibrator</u>		_____	
	amplitude	9.8 div	_____	10.2 div
	risetime	none	_____	3 usec
5-12 step c step d	<u>Magnifier</u>		_____	
	X1	9.5 div	_____	10.5 div
	X5	9.5 div	_____	10.5 div
	X10	9.5 div	_____	10.5 div
5-13 step c	<u>Bandwidth</u> AC coupling	7.1 div	_____	none
5-14 step c	Beam Finder	Intensified beam	_____	yes or no

HP MODEL 180F

Serial Number: _____

_____ Date

PERFORMANCE CHECK RECORD

Paragraph	Check	Minimum	Reading	Maximum
5-11 step f step h	<u>Calibrator</u>		_____	
	amplitude	9.8 div	_____	10.2 div
	risetime	none	_____	3 usec
5-12 step c step d	<u>Magnifier</u>		_____	
	X1	9.5 div	_____	10.5 div
	X5	9.5 div	_____	10.5 div
	X10	9.5 div	_____	10.5 div
5-13 step c	<u>Bandwidth</u> AC coupling	7.1 div	_____	none
5-14 step c	Beam Finder	Intensified beam	_____	yes or no

CUT ALONG DOTTED LINE

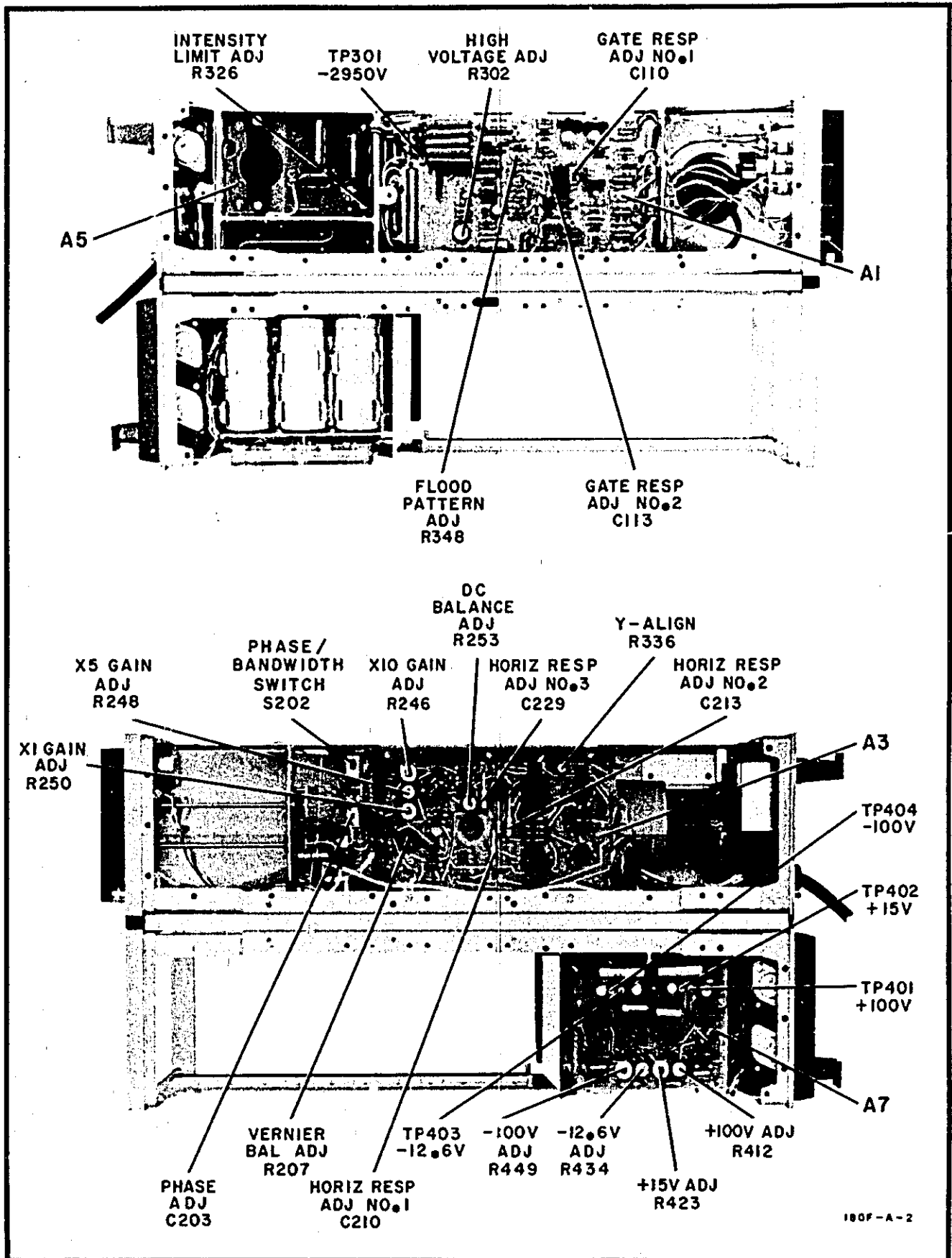

Figure 5-2. Adjustment Locations

PARTS LIST

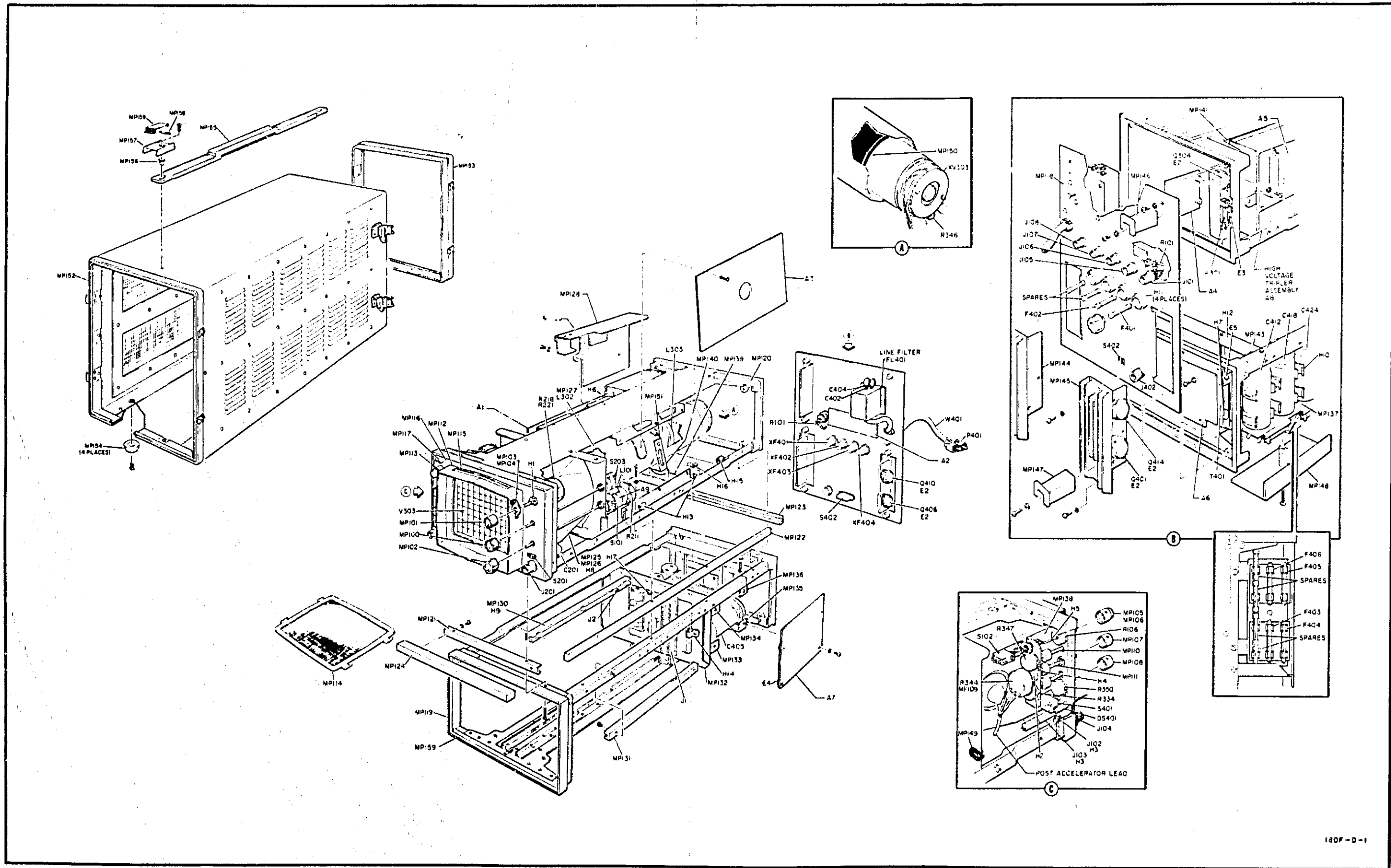

Figure 6-1. Model 180F Mechanical Parts Identification

SECTION VI

REPLACEABLE PARTS

6-1. INTRODUCTION.

6-2. This section contains information for ordering replaceable parts for the instrument. Table 6-2 lists the parts in alpha-numerical order of their reference designations and provides the following information for each item:

- a. HP Part Number.
- b. Total quantity (TQ) used in instrument; given only first time a part number is listed.
- c. Description of part; see Table 6-1 for list of reference designators and abbreviations.

6-3. Mechanical parts are listed by reference designation in Table 6-2, and identified in Figure 6-1.

6-4. ORDERING INFORMATION.

6-5. To order a replacement part from the Hewlett-Packard Company, address the order or inquiry to the nearest Hewlett-Packard Sales/Service Office (list in rear of manual) and supply the following information:

- a. HP Part Number of item(s).
- b. Model number and eight-digit serial number of instrument.
- c. Quantity of parts desired.

6-6. To order a part not listed in Table 6-2, provide the following information:

- a. Model number and eight-digit serial number of the instrument.

Table 6-1. Reference Designators And Abbreviations

REFERENCE DESIGNATORS					
<p>A = assembly</p> <p>AT = attenuator, resistive termination</p> <p>B = motor, fan</p> <p>C = capacitor</p> <p>CP = coupling</p> <p>CR = diode</p> <p>DL = delay line</p> <p>DS = device signaling (lamp)</p>	<p>E = misc. electronic part</p> <p>F = fuse</p> <p>FL = filter</p> <p>H = hardware</p> <p>IC = integrated circuit</p> <p>J = jack</p> <p>K = relay</p> <p>L = inductor</p> <p>LS = speaker</p>	<p>M = meter</p> <p>MP = mechanical part</p> <p>P = plug</p> <p>PS = power supply</p> <p>Q = transistor</p> <p>R = resistor</p> <p>RT = thermistor</p> <p>S = switch</p> <p>T = transformer</p>	<p>TB = terminal board</p> <p>TP = test point</p> <p>U = microcircuit(non-repairable)</p> <p>V = vacuum tube, neon bulb, photocell, etc.</p> <p>VR = voltage regulator (diode)</p> <p>W = cable</p> <p>X = socket</p> <p>Y = crystal</p>		
ABBREVIATIONS					
<p>A = ampere(s)</p> <p>ampl = amplifier(s)</p> <p>assy = assembly</p> <p>bd = board(s)</p> <p>bp = bandpass</p> <p>c = centi (10^{-2})</p> <p>car = carbon</p> <p>ccw = counterclockwise</p> <p>cer = ceramic</p> <p>coax. = coaxial</p> <p>coef = coefficient</p> <p>com = common</p> <p>comp = composition</p> <p>conn = connector(s)</p> <p>CRT = cathode-ray tube</p> <p>cw = clockwise</p> <p>d = deci (10^{-1})</p> <p>depc = deposited carbon</p> <p>dp = double pole</p> <p>dt = double throw</p> <p>elect. = electrolytic</p> <p>encap = encapsulated</p> <p>ext = external</p> <p>F = farad(s)</p> <p>fet = field-effect transistor(s)</p> <p>fxd = fixed</p>	<p>Ge = germanium</p> <p>G = giga (10^9)</p> <p>gl = glass</p> <p>grd = ground(ed)</p> <p>H = henry(ies)</p> <p>Hg = mercury</p> <p>hr = hour(s)</p> <p>HP = Hewlett-Packard</p> <p>Hz = hertz</p> <p>if. = intermediate freq</p> <p>impg = impregnated</p> <p>incd = incandescent</p> <p>incl = include(s)</p> <p>ins = insulation(ed)</p> <p>int = internal</p> <p>k = kilo (10^3)</p> <p>lb = pound(s)</p> <p>lev = lever</p> <p>lin = linear taper</p> <p>log. = logarithmic taper</p> <p>lpf = low-pass filter(s)</p> <p>m = milli (10^{-3})</p> <p>M = mega (10^6)</p> <p>metfilm = metal film</p> <p>metox = metal oxide</p>	<p>minat = miniature</p> <p>nom. = momentary</p> <p>mtg = mounting</p> <p>my. = mylar</p> <p>n = nano (10^{-9})</p> <p>n/c = normally closed</p> <p>Ne = neon</p> <p>n/o = normally open</p> <p>npo = negative positive zero (zero temperature coefficient)</p> <p>nsr = not separately replaceable</p> <p>obd = order by description</p> <p>ox = oxide</p> <p>p = pico (10^{-12})</p> <p>pc = printed/etched circuit(s)</p> <p>PGM = program</p> <p>piv = peak inverse voltage(s)</p> <p>p/o = part of</p> <p>poly = polystyrene</p> <p>porc = porcelain</p> <p>pos = position(s)</p> <p>pot. = potentiometer(s)</p> <p>pk-pk = peak-to-peak</p> <p>rect = rectifier(s)</p> <p>rf = radio frequency</p>	<p>s-b = slow-blow</p> <p>Se = selenium</p> <p>sect = section(s)</p> <p>semicon = semiconductor(s)</p> <p>Si = silicon</p> <p>sil = silver</p> <p>sl = slide</p> <p>sp = single pole</p> <p>spl = special</p> <p>st = single throw</p> <p>std = standard</p> <p>Ta = tantalum</p> <p>td = time delay</p> <p>TD = tunnel diode(s)</p> <p>tgl = toggle</p> <p>Ti = titanium</p> <p>tol = tolerance</p> <p>trim. = trimmer</p> <p>u = micro (10^{-6})</p> <p>V = volt(s)</p> <p>var = variable</p> <p>W = watt(s)</p> <p>w/ = with</p> <p>w/o = without</p> <p>wVdc = dc working volt(s)</p> <p>ww = wirewound</p>		

b. Description of part including function and location.

6-7. Component descriptions given in Table 6-2 are as complete as possible to assist in obtaining replacement parts from manufacturers other than HP. However, many parts are manufactured only by HP, or are produced by other manufacturers to HP proprietary specifications, and are therefore available only from HP. Actual manufacturer and manufacturer's part number for non-HP parts will be supplied upon request. Contact the nearest HP Sales/Service Office.

6-8. OPTION 21 REPLACEABLE PARTS.

a. REFERENCE DESIGNATIONS. The unit numbering method of assigning reference designations has been used to identify assemblies and sub-assemblies. The block numbering system has been used to identify detail parts. This method has been expanded as much as necessary to adequately cover the various degrees of subdivision of the equipment. An example of this numbering method is illustrated by the following:

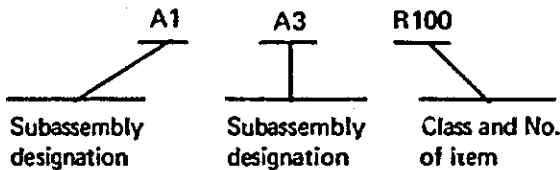

Read as: First (100) resistor (R) of third (3) subassembly (A) of first (1) subassembly (A).

b. REFERENCE DESIGNATION PREFIX. Partial reference designations are used on the illustrations. The partial reference designations consist of the class letter(s) and the identifying item number. The complete reference designations may be obtained by placing the proper subassembly prefix(es) before the partial reference

designations. The main subassembly prefix is identified in the figure title or notes accompanying the illustration. Secondary subassemblies are enclosed in broken lines with the subassembly prefix listed in the upper left-hand corner of the box. Components not mounted on an assembly have only the basic reference designation.

6-9. MAINTENANCE PARTS LIST.

6-10. Table 6-3 lists those parts not mounted on an assembly, all subassemblies and their maintenance parts. The subassemblies are listed in numerical sequence. Maintenance parts for each subassembly are listed alphabetically-numerically by class of part. Table 6-3 provides the following information: (1) The complete reference designation of each subassembly or part; (2) noun name and brief description.

6-11. Printed circuit boards, assembly boards, modules, etc., are listed first as individual items in the maintenance parts list. The individual circuit board, assembly board, module etc., is then broken down by components into separate parts listings. When there is a redundancy of components on a subsequent subassembly, reference is made to the previously listed description.

6-12. LIST OF MANUFACTURERS.

6-13. Table 6-4 lists the manufacturers of parts used in the equipment. The table includes the manufacturer's code used in Table 6-3 to allow identification of the manufacturers.

6-14. STOCK NUMBER IDENTIFICATION.

6-15. Allowance Parts List (APL) issued by the Electronic Supply office (ESO) includes Federal Stock Numbers and Source Maintenance and Recoverability Codes. Therefore, reference should be made to the APL prepared for the equipment for stock numbering information.

Table 6-2. Replaceable Parts

Ref Desig	HP Part No.	TQ	Description (Refer to Table 6-1.)
A1	00180-66536	1	A: calibrator, gate amplifier and high voltage regulator
A2	00180-66533	1	A: output amplifier
A3	00180-66531	1	A: horizontal amplifier
A4	00180-66535	1	A: high voltage oscillator
A5	00180-66534	1	A: high voltage rectifier
A6	00180-66532	1	A: low voltage rectifier
A7	00180-66513	1	A: low voltage power supply
A8	00180-61101	1	A: high voltage rectifier tripler
A9	00180-61902	1	A: display switch
C101	0160-0168	5	C: fxd my 0.1 uF 10% 20 wVdc
C102	0160-0207	1	C: fxd my .01 uF 5% 200 wVdc
C103	0160-0162	12	C: fxd my .022 uF 10% 200 wVdc
C104	0160-0162		C: fxd my .022 uF 10% 200 wVdc
C105	0160-0162		C: fxd my .022 uF 10% 200 wVdc
C106	0160-0162		C: fxd my .022 uF 10% 200 wVdc
C110	0132-0004	1	C: var poly 0.7-3 pF 350 wVdc
C111	0150-0059	1	C: fxd cer 3.3 pF 500 wVdc
C112	0140-0180	1	C: fxd mica 2000 pF 2% 300 wVdc
C113	0121-0168	1	C: var teflon 0.2-15 pF 600 wVdc
C114	0160-0162		C: fxd my .022 uF 10% 200 wVdc
C115	0180-0039	1	C: fxd elect 100 uF -10 +75% 12 wVdc
C116	0150-0061	1	C: fxd cer 20 pF 10% 100 wVdc
C120	0180-0155	3	C: fxd Ta 2.2 uF 20% 20 wVdc
C121	0140-0189	2	C: fxd mica 5825 pF 2% 300 wVdc
C122	0140-0189		C: fxd mica 5825 pF 2% 300 wVdc
C123	0180-0089	1	C: fxd elect 10 uF -10 +100% 150 wVdc
C127	0180-0155		C: fxd Ta 2.2 uF 20% 20 wVdc
C128	0180-0155		C: fxd Ta 2.2 uF 20% 20 wVdc
C201	0170-0022	1	C: fxd my 0.1 uF 20% 600 wVdc
C202	0150-0075	1	C: fxd cer 4700 pF -20 +100% 500 wVdc
C203	0131-0004	1	C: var mica 16-150 pF 175 wVdc
C204	0140-0231	1	C: fxd mica 440 pF 1% 300 wVdc
C205	0160-0162		C: fxd my .022 uF 10% 200 wVdc
C206	0160-0162		C: fxd my .022 uF 10% 200 wVdc
C210	0132-0007	3	C: var gl .7-3 pF 350 wVdc
C211	0160-0162		C: fxd my .022 uF 10% 200 wVdc
C212	0170-0040	2	C: fxd my .047 uF 10% 200 wVdc
C213	0132-0007		C: var gl .7-3 pF 350 wVdc
C214	0160-2235	1	C: fxd cer .75 pF 500 wVdc
C218	0160-0162		C: fxd my .022 uF 10% 200 wVdc
C219	0160-0162		C: fxd my .022 uF 10% 200 wVdc
C220	0180-0197	4	C: fxd Ta elect 2.2 uF 10% 20 wVdc
C221	0180-0197		C: fxd Ta elect 2.2 uF 10% 20 wVdc

Ref Desig	HP Part No.	TQ	Description (Refer to Table 6-1.)
C222	0160-0162		C: fxd my .022 uF 10% 200 wVdc
C226	0180-0197		C: fxd Ta elect 2.2 uF 10% 20 wVdc
C227	0180-0197		C: fxd Ta elect 2.2 uF 10% 20 wVdc
C228	0180-0218	1	C: fxd Ta elect .15 uF 35 wVdc
C229	0132-0007		C: var gl .7-3 pF 350 wVdc
C230	0160-0162		C: fxd my .022 uF 10% 200 wVdc
C231	0170-004C		C: fxd my .047 uF 10% 200 wVdc
C301	0180-0076	1	C: fxd elect 20 uF 25 wVdc
C302	0160-2486	1	C: fxd cer .0045 uF 3500 wVdc
C303	0170-0019	1	C: fxd my .1 uF 200 wVdc
C307	0180-0097	2	C: fxd elect 47 uF 10% 35 wVdc
C308	0160-0380	1	C: fxd my .22 uF 10% 200 wVdc
C309	0160-0907	3	C: fxd cer .01 uF 5000 wVdc
C310	0160-0907		C: fxd cer .01 uF 5000 wVdc
C311	0160-2320	3	C: fxd cer .01 uF 5000 wVdc
C315	0160-2320		C: fxd cer .01 uF 5000 wVdc
C316	0160-0907		C: fxd cer .01 uF 5000 wVdc
C317	0160-2320		C: fxd cer .01 uF 5000 wVdc
C318			NSR: p/o A8
C319			NSR: p/o A8
C320			NSR: p/o A8
C321			NSR: p/o A8
C401	0180-1811	1	C: fxd elect 100 uF -10 +75% 20 wVdc
C402	0160-0151	2	C: fxd cer .0047 uF 4000 wVdc
C404	0160-0151		C: fxd cer .0047 uF 4000 wVdc
C405	0180-1808	1	C: fxd elect 430 uF -10 +50% 200 wVdc
C406	0160-0168		C: fxd my .1 uF 10% 200 wVdc
C407	0180-0100	2	C: fxd Ta elect 4.7 uF 10% 35 wVdc
C408	0180-1810	2	C: fxd elect 18 uF -10 +50% 150 wVdc
C412	0180-1865	1	C: fxd elect 2100 uF -10 +75% 40 wVdc
C413	0160-0168		C: fxd my .1 uF 10% 200 wVdc
C414	0180-0097		C: fxd elect 47 uF 10% 35 wVdc
C418	0180-1809	1	C: fxd elect 3400 uF -10 +75% 25 wVdc
C419	0160-0168		C: fxd my .1 uF 10% 200 wVdc
C420	0180-0097	1	C: fxd elect 47 uF 10% 35 wVdc
C424	0180-1807	1	C: fxd elect 290 uF -10 +50% 200 wVdc
C425	0160-0168		C: fxd my .1 uF 10% 200 wVdc
C426	0180-0100		C: fxd Ta elect 4.7 uF 10% 35 wVdc
C427	0180-1810		C: fxd elect 18 uF 150 wVdc
CR101	1901-0179	1	CR: Si (special)
CR102	1901-0040	20	CR: Si (Special)
CR103	1901-0040		CR: Si (special)
CR104	1901-0040		CR: Si (special)
CR106	1901-0040		CR: Si (special)

Ref Desig	HP Part No.	TQ	Description (Refer to Table 6-1.)
CR109	1901-0029	2	CR: Si (special)
CR110	1901-0029		CR: Si (special)
CR111	1901-0040		CR: Si (special)
CR112	1901-0436	2	CR: Si (special)
CR113	1901-0436		CR: Si (special)
CR115	1901-0096	4	CR: Si (special)
CR116	1901-0096		CR: Si (Special)
CR117	1901-0096		CR: Si (special)
CR201	1901-0096		CR: Si (special)
CR202	5080-0464	4	CR: Si (special)
CR203	1901-0040		CR: Si (special)
CR204	5080-0464		CR: Si (special)
CR205	1901-0040		CR: Si (special)
CR206	1901-0040		CR: Si (special)
CR207	5080-0464		CR: Si (special)
CR208	5080-0464		CR: Si (special)
CR209	1901-0040		CR: Si (special)
CR301	1901-0049	5	CR: Si (speical)
CR302	1901-0341	2	CR: Si (special)
CR303	1901-0040		CR: Si (special)
CR307	1901-0341		CR: Si (special)
CR308			NSR: p/o A8
CR309			NSR: p/o A8
CR310			NSR: p/o A8
CR401	1901-0049		CR: Si (special)
CR402	1901-0049		CR: Si (special)
CR403	1901-0049		CR: Si (special)
CR404	1901-0049		CR: Si (special)
CR405	1901-0040		CR: Si (special)
CR406	1901-0040		CR: Si (special)
CR407	1901-0040		CR: Si (special)
CR408	1901-0028	7	CR: Si (special)
CR409	1901-0028		CR: Si (special)
CR410	1901-0028		CR: Si (special)
CR411	1901-0028		CR: Si (special)
CR412	1901-0026	2	CR: Si (special)
CR413	1901-0415	8	CR: Si (speical)
CR414	1901-0415		CR: Si (special)
CR415	1901-0415		CR: Si (special)
CR416	1901-0415		CR: Si (special)
CR417	1901-0040		CR: Si (special)
CR419	1901-0040		CR: Si (special)
CR420	1901-0040		CR: Si (special)
CR421	1901-0415		CR: Si (special)

Table 6-2. Replaceable Parts (Cont'd)

Ref Desig	HP Part No.	TQ	Description (Refer to Table 6-1.)
CR422	1901-0415		CR: Si (special)
CR423	1901-0415		CR: Si (special)
CR424	1901-0415		CR: Si (special)
CR425	1901-0040		CR: Si (speical)
CR426	1901-0028		CR: Si (special)
CR427	1901-0028		CR: Si (special)
CR428	1901-0028		CR: Si (speical)
CR429	1901-0028		CR: Si (special)
CR430	1901-0026		CR: Si (special)
CR432	1901-0040		CR: Si (special)
CR433	1901-0040		CR: Si (special)
CR434	1901-0040		CR: Si (special)
DS401	1450-0359	1	DS: incandescent, 28V
E1	3100-1580	8	Spacer: ceramic
E2	1200-0043	5	Insulator: transistor
E3	1400-0076	1	Clip: fuse
E4	00180-05401	1	Insulator: L. V. Board
E5	0340-0114	4	Insulator: bushing
E6	0340-0039	2	Insulator: teflon (on A5)
F301	2110-0012	2	F: 0.5A 250V (1 spare)
F401	2110-0005	4	F: 1.6A 125V slow blow (2 spares)
F402	2110-0005		F: 1.6A 125V slow blow
F403	2110-0065	2	F: 0.375A 250V (1 spare)
F404	2110-0002	4	F: 2A 250V (2 spares)
F405	2110-0002		F: 2A 250V
F406	2110-0067	2	F: 0.3A 250V (1 spare)
FL401	9100-2483	1	FL: line
H1	00180-25703	1	Nut: Horizontal Position Pot
H2	00180-45404	1	Insulator: Focus
H3	00180-45403	3	Insulator: bushing
H4	00180-45402	1	Insulator: bushing
H5	00180-23701	1	Shaft: beam finder
H6	00180-24702	5	Standoff: A1 board
H7	00180-24701	4	Standoff: transformer
H8	00180-09105	1	Clip: dag ground
H9	00180-09104	1	Clip: ground
H10	1400-0439	8	Clip: component
H11	1400-0090	4	Washer: neoprene
H12	0380-0724	2	Spacer: Post type
H13	1400-0325	2	Clamp: cable
H14	1400-0018	1	Clamp: cable
H15	1400-0025	1	Clamp: cable

Table 6-2. Replaceable Parts (Cont'd)

Ref Desig	HP Part No.	TQ	Description (Refer to Table 6-1.)
H16	1400-0093	1	Clamp: cable
H17	1400-0116	1	Clamp: cable
H18	5020-0495	109	Pin: interconnection, square
H19	0362-0063	109	Clip: square pin
J1	1251-0137	1	J: female 32 pin
J2	0363-0006	2	J: spring contact
J101	1250-0083	6	J: BNC female
J102	1251-0229	2	J: banana female
J103	1251-0229		J: banana female
J104	00180-61001	1	J: binding post
J105	1250-0083		J: BNC female
J106	1250-0083		J: BNC female
J107	1250-0083		J: BNC female
J108	1250-0083		J: BNC female
J201	1250-0083		J: BNC female
J402	1510-0038	1	J: binding post
L101	9140-0047	1	L: fxd 20 uH 10%
L102	9140-0179	6	L: fxd 22 uH 10%
L105	9140-0179		L: fxd 22 uH 10%
L107	9140-0179		L: fxd 22 uH 10%
L108	9140-0179		L: fxd 22 uH 10%
L200	9140-0179		L: fxd 22 uH 10%
L202	9140-0179		L: fxd 22 uH 10%
L203	9170-0029	1	L: bead
L301	9140-0071	1	L: fxd 22 uH 10%
L302	5060-0435	1	L: trace align
L303	00180-65601	1	L: Y align
MP100	00180-67404	2	Knob: horizontal magnifier
MP101	00180-67402	1	Knob: horizontal position
MP102	00180-67404		Knob: horizontal display
MP103	00180-05002	1	Lever: horizontal position, fine
MP104	0370-0432	1	Knob: lever
MP105	0370-0350	1	Pushbutton: find beam
MP106	0370-0348	1	Knob: intensity
MP107	00180-67401	1	Knob: focus
MP108	00180-67403	1	Knob: scale
MP109	5040-0453	1	Insulator: control
MP110	00180-23202	2	Coupler: short
MP111	00180-23201	1	Coupler: focus
MP112	0905-0331	1	Gasket: CRT
MP113	5040-0444	1	Shield: light
MP114	10178A	1	Filter: mesh contrast

Ref Desig	HP Part No.	TQ	Description (Refer to Table 6-1.)
MP115	5020-0476	1	Bezel: CRT
MP116	00180-00227	1	Panel: front
MP116	00180-00228	1	Panel: front (Option 21 only)
MP117	00180-00226	1	Panel: sub
MP118	00180-00225	1	Panel: rear
MP119	00180-60111	1	Chassis assembly: power cabinet
MP120	00180-60112	1	Chassis assembly: diplay cabinet
MP121	00180-24720	1	Spacer: front
MP122	00180-24715	2	Spacer: side
MP123	00180-24713	1	Spacer: rear
MP124	00180-24711	1	Bar: identification
MP124	00180-24717	1	Bar: identification (Option 21 only)
MP125	00180-00602	1	Shield: CRT
MP126	4320-0201	1	Ring: rubber
MP127	00180-01218	1	Bracket: trace align coil
MP128	00180-64108	1	Cover plate: high voltage supply
MP129	00180-25401	1	Insulator: cover plate
MP130	00180-43101	1	Guide: left plug-in
MP131	00180-43102	1	Guide: right plug-in
MP132	00180-01209	1	Bracket: connector
MP133	00180-01210	1	Bracket: transformer: front, bottom
MP134	00180-01222	1	Bracket: transformer: front, top
MP135	00180-01215	1	Bracket: transformer: rear, bottom
MP136	00180-01223	1	Bracket: transformer: rear, top
MP137	00180-01227	1	Bracket: capacitor
MP138	00180-01208	1	Bracket: control mounting
MP139	00180-01241	1	Bracket: shock mounting
MP140	1520-0071	2	Shock mount: CRT
MP141	00180-01243	1	Bracket: cabinet top
MP142	00180-01206	1	Bracket: transistor
MP143	00180-04703	1	Support: transformer
MP144	00180-61103	1	Heat sink assembly: transistor
MP145	00180-61104	1	Heat sink assembly: transistor
MP146	5040-0447	2	Foot: rear, long
MP147	5040-0446	2	Foot: rear, short
MP148	00180-44106	1	Cover: fuse
MP149	0400-0010	1	Grommet: .250 I. D.
MP150	4320-0007	1	Extrusion: rubber
MP151	00180-61203	1	Clamp: shock mount assembly
MP152	00180-64401	1	Cover assembly: oscilloscope
MP153	00180-62002	1	Casting: rear
MP154	0403-0019	4	Foot: bottom
MP155	5040-0459	1	Handle: case
MP156	00180-24718	2	Spacer: handle
MP157	00180-22301	2	Keeper: handle
MP158	1205-0063	3	Heat Sink: dual transistor
MP159	4320-0231	1	Gasket: RFI

Ref Desig	HP Part No.	TO	Description (Refer to Table 6-1.)
P401	1251-0037	1	Connector, power plug (p/o W401)
Q101	1854-0019	5	Q: Si npn (special)
Q102	1854-0019		Q: Si npn (special)
Q103	1853-0038	3	Q: Si pnp (special)
Q104	1854-0271	1	Q: Si npn (special)
Q105	1853-0009	3	Q: Si pnp (special)
Q106	1854-0234	2	Q: Si npn 2N3440
Q107	1854-0234		Q: Si npn 2N3440
Q108	1854-0071	10	Q: Si npn (special)
Q109	1854-0071		Q: Si npn (special)
Q110	1853-0016	2	Q: Si pnp (special)
Q111	1853-0016	2	Q: Si pnp (special)
Q201	1855-0020	1	Q: Si field-effect n channel (special)
Q202	1854-0083	1	Q: Si npn (special)
Q203	1850-0158	1	Q: Si pnp 2N2635
Q204	1854-0019		Q: Si npn (special)
Q205	1854-0071		Q: Si npn (special)
Q206	1854-0019		Q: Si npn (special)
Q207	1854-0019		Q: Si npn (special)
Q208	1853-0009		Q: Si pnp (special)
Q209	1854-005E	2	Q: Si npn 2N3119
Q210	1853-0038		Q: Si pnp (special)
Q211	1853-0009		Q: Si pnp (special)
Q212	1854-0056		Q: Si npn 2N3119
Q213	1853-0038		Q: Si pnp (special)
Q301	1854-0023	1	Q: Si npn (special)
Q302	1854-0071		Q: Si npn (special)
Q303	1854-0039	3	Q: Si npn 2N3053
Q304	1854-0291	1	Q: Si npn (special)
Q401	1854-0063	4	Q: Si npn 2N3055
C402	1854-0090	2	Q: Si npn (special)
Q403	1854-0087	2	Q: Si npn (special)
Q404	1854-0071		Q: Si npn (special)
Q405	1854-0039		Q: Si npn 2N3053
Q406	1854-0063		Q: Si npn 2N3055
Q407	1854-0071		Q: Si npn (special)
Q408	1854-0071		Q: Si npn (special)
Q409	1854-0039		Q: Si npn 2N3053
Q410	1854-0063		Q: Si npn 2N3055
Q411	1854-0071		Q: Si npn (special)
Q412	1854-0071		Q: Si npn (special)
Q413	1854-0090		Q: Si npn (special)
Q414	1854-0063		Q: Si npn 2N3055
Q415	1854-0087		Q: Si npn (special)
Q416	1854-0071		Q: Si npn (special)

Ref Desig	HP Part No.	TQ	Description (Refer to Table 6-1.)
R101	0757-0438	8	R: fxd metflm 5.11k ohms 1% 1/8W
R102	0757-0407	6	R: fxd metflm 200 ohms 1% 1/8W
R103	0757-0407		R: fxd metflm 200 ohms 1% 1/8W
R104	0757-0401	8	R: fxd metflm 100 ohms 1% 1/8W
R105	0757-0458	1	R: fxd metflm 51.1k ohms 1% 1/8W
R106	2100-1904	1	R: var comp 10k ohms 20% 1/4W
R107	0757-0281	3	R: fxd metflm 2.74k ohms 1% 1/8W
R111	0757-0401		R: fxd metflm 100 ohms 1% 1/8W
R112	0757-0401		R: fxd metflm 100 ohms 1% 1/8W
R113	0757-0401		R: fxd metflm 100 ohms 1% 1/8W
R114	0757-0290	1	R: fxd metflm 6.19k ohms 1% 1/8W
R115	0757-0724	1	R: fxd metflm 392 ohms 1% 1/8W
R116	0757-0461	1	R: fxd metflm 68.1k ohms 1% 1/8W
R117	0757-0727	1	R: fxd metflm 562 ohms 1% 1/4W
R118	0757-0407		R: fxd metflm 200 ohms 1% 1/8W
R119	0757-0756	2	R: fxd metflm 13k ohms 1% 1/4W
R120	0757-0469	1	R: fxd metflm 150k ohms 1% 1/8W
R121	0757-0756		R: fxd metflm 13k ohms 1% 1/4W
R122	0687-1011	1	R: fxd car comp 100 ohms 10% 1/2W
R125	0757-0280	10	R: fxd metflm 1000 ohms 1% 1/8W
R126	0757-0760	3	R: fxd metflm 20k ohms 1% 1/4W
R127	0757-0416	1	R: fxd metflm 511 ohms 1% 1/8W
R128	0757-0441	2	R: fxd metflm 8250 ohms 1% 1/8W
R129	0757-0438		R: fxd metflm 5110 ohms 1% 1/8W
R130	0757-0434	5	R: fxd metflm 3650 ohms 1% 1/8W
R131	0757-0283	6	R: fxd metflm 2000 ohms 1% 1/8W
R132	0757-0421	1	R: fxd metflm 825 ohms 1% 1/8W
R133	0761-0083	1	R: fxd metox flm 68k ohms 5% 1W
R136	0757-0760		R: fxd metflm 20k ohms 1% 1/4W
R137	0757-0468	3	R: fxd metflm 130k ohms 1% 1/8W
R138	0757-0468		R: fxd metflm 130k ohms 1% 1/8W
R139	0683-0275	5	R: fxd comp 2.7 ohms 5% 1/4W
R140	0757-0283		R: fxd metflm 2000 ohms 1% 1/8W
R141	0757-0407		R: fxd metflm 200 ohms 1% 1/8W
R142	0757-0760		R: fxd metflm 20k ohms 1% 1/4W
R143	0698-5418	1	R: fxd metflm 50 ohms 0.1% 1/8W
R144	0698-5419	1	R: fxd metflm 1950 ohms 0.1% 1/8W
R145	0698-5421	1	R: fxd metflm 17.82k ohms 0.1% 1/2W
R149	0757-0451	2	R: fxd metflm 24.3k ohms 1% 1/8W
R150	0757-0438		R: fxd metflm 5110 ohms 1% 1/8W
R151	0757-0436	3	R: fxd metflm 4320 ohms 1% 1/8W
R152	0757-0451		R: fxd metflm 24.3k ohms 1% 1/8W
R153	0757-0438		R: fxd metflm 5110 ohms 1% 1/8W
R154	0757-0436		R: fxd metflm 4320 ohms 1% 1/8W
R155	0757-0431	2	R: fxd metflm 2430 ohms 1% 1/8W

Ref Desig	HP Part No.	TQ	Description (Refer to Table 6-1.)
R156	0757-0283		R: fxd metflm 2000 ohms 1% 1/8W
R157	0757-0438		R: fxd metflm 5110 ohms 1% 1/8W
R158	0757-0431		R: fxd metflm 2430 ohms 1% 1/8W
R159	0757-0283		R: fxd metflm 2000 ohms 1% 1/8W
R160	0757-0438		R: fxd metflm 5110 ohms 1% 1/8W
R161	0683-0275		R: fxd comp 2.7 ohms 5% 1/4W
R162	0683-0275		R: fxd comp 2.7 ohms 5% 1/4W
R201	0757-0465	7	R: fxd metflm 100k ohms 1% 1/8W
R202	0757-0344	1	R: fxd metflm 1 meg ohms 1% 1/4W
R203	0757-0401		R: fxd metflm 100 ohms 1% 1/8W
R204	0761-0076	1	R: fxd metflm 18k ohms 5% 1W
R205	0757-0282	1	R: fxd metflm 221 ohms 1% 1/8W
R206	0757-0347	1	R: fxd metflm 27.4k ohms 1% 1/2W
R207	2100-1418	1	R: var comp 50k ohms 20% 1/5W
R208	0757-0440	2	R: fxd metflm 7500 ohms 1% 1/8W
R209	0698-5420	1	R: fxd metflm 3874 ohms 0.1% 1/8W
R210	0757-0463	2	R: fxd metflm 82.5k ohms 1% 1/8W
R211	2100-2089	1	R: var comp 50k ohms 3% 1/2W
R215	0757-0441		R: fxd metflm 8250 ohms 1% 1/8W
R216	0757-0792	1	R: fxd metflm 681k ohms 1% 1/4W
R217	0757-0401		R: fxd metflm 100 ohms 1% 1/8W
R218	2100-2076	1	R: var comp 100k ohms 20% (Includes R221)
R219	0757-0460	4	R: fxd metflm 61.9k ohms 1% 1/8W
R220	0757-0401		R: fxd metflm 100 ohms 1% 1/8W
R221			NSR: p/o R218
R222	0757-0283		R: fxd metflm 2000 ohms 1% 1/8W
R223	0757-0764	3	R: fxd metflm 33.2k ohms 1% 1/4W
R225	0757-0741	2	R: fxd metflm 2430 ohms 1% 1/4W
R226	0757-0401		R: fxd metflm 100 ohms 1% 1/8W
R229	0757-0281		R: fxd metflm 2740 ohms 1% 1/8W
R230	0757-0443	2	R: fxd metflm 11k ohms 1% 1/8W
R231	0757-0434		R: fxd metflm 3650 ohms 1% 1/8W
R232	0757-0736	2	R: fxd metflm 1500 ohms 1% 1/4W
R234	0757-0846	2	R: fxd metflm 22.1k ohms 1% 1/2W
R235	0757-0413	2	R: fxd metflm 392 ohms 1% 1/8W
R237	0757-0407		R: fxd metflm 200 ohms 1% 1/8W
R238	0757-0841	2	R: fxd metflm 12.1k ohms 1% 1/2W
R239	0757-0448	1	R: fxd metflm 18.2k ohms 1% 1/8W
R244	0683-0275		R: fxd comp 2.7 ohms 5% 1/4W
R245	0757-0388	5	R: fxd metflm 30.1 ohms 1% 1/8W
R246	2100-1770	1	R: var ww 100 ohms 10% 1/2W
R247	0757-0284	1	R: fxd metflm 150 ohms 1% 1/8W

Ref Desig	HP Part No.	TQ	Description (Refer to Table 6-1.)
R248	2100-1771	1	R: var ww 200 ohms 10% 1/2W
R249	0757-0411	1	R: fxd metflm 332 ohms 1% 1/8W
R250	2100-1773	2	R: var ww 1000 ohms 10% 1/2W
R251	0757-0428	1	R: fxd metflm 1620 ohms 1% 1/8W
R252	0698-3416	2	R: fxd metflm 21.5k ohms 1% 1/2W
R253	2100-0741	1	R: var ww 5000 ohms 5% 1W
R254	0698-3416		R: fxd metflm 21.5k ohms 1% 1/2W
R257	0757-0468		R: fxd metflm 130k ohms 1% 1/8W
R258	0757-0440		R: fxd metflm 7500 ohms 1% 1/8W
R259	0757-0427	1	R: fxd metflm 1500 ohms 1% 1/8W
R261	0757-0741		R: fxd metflm 2430 ohms 1% 1/4W
R262	0757-0281		R: fxd metflm 2740 ohms 1% 1/8W
R263	0757-0200	1	R: fxd metflm 5620 ohms 1% 1/8W
R264	0757-0443		R: fxd metflm 11k ohms 1% 1/8W
R268	0757-0434		R: fxd metflm 3650 ohms 1% 1/8W
R269	0757-0736		R: fxd metflm 1500 ohms 1% 1/4W
R270	0757-0413		R: fxd metflm 392 ohms 1% 1/8W
R271	0757-0846		R: fxd metflm 22.1k ohms 1% 1/2W
R273	0757-0407		R: fxd metflm 200 ohms 1% 1/8W
R275	0757-0841		R: fxd metflm 12.1k ohms 1% 1/2W
R301	0683-0275		R: fxd comp 2.7 ohms 5% 1/4W
R302	2100-0944	1	R: var metflm 200k ohms 20% 3/4W
R303	0757-0138	1	R: fxd metflm 909k ohms 1% 1/2W
R304	0757-0442	2	R: fxd metflm 10k ohms 1% 1/8W
R305	0698-7182	1	R: fxd car flm 30 megohms 1% 2W
R310	0686-1025	1	R: fxd comp 1000 ohms 5% 1/2W
R313	0757-0442		R: fxd metflm 10k ohms 1% 1/8W
R314	0757-0438		R: fxd metflm 5110 ohms 1% 1/8W
R315	0698-3553	1	R: fxd metflm 2.49 megohm 1% 1/2W
R316	0757-0283		R: fxd metflm 2000 ohms 1% 1/8W
R317	0757-0280		R: fxd metflm 1000 ohms 1% 1/8W
R318	0757-0465		R: fxd metflm 100k ohms 1% 1/8W
R319	0757-0401		R: fxd metflm 100 ohms 1% 1/8W
R320	0757-0814	1	R: fxd metflm 511 ohms 1% 1/2W
R321	0757-0465		R: fxd metflm 100k ohms 1% 1/8W
R325	0683-2235	1	R: fxd metflm 22k ohms 5% 1/4W
R316	2100-1618	1	R: var comp 1 megohm 30% 1/2W
R327	0836-0003	1	R: fxd depc 29 megohm 10% 1W
R328	0683-1055	1	R: fxd comp 1 megohm 5% 1/4W
R330	0757-0456	3	R: fxd metflm 43.2k ohms 1% 1/8W

Ref Desig	HP Part No.	TQ	Description (Refer to Table 6-1.)
R331	0757-0460		R: fxd metflm 61.9k ohms 1% 1/8W
R332	0757-0456		R: fxd metflm 43.2k ohms 1% 1/8W
R333	0757-0460		R: fxd metflm 61.9k ohms 1% 1/8W
R334	2100-1903	1	R: var ww 5000 ohms 10% 2W
R335	0757-0280		R: fxd metflm 1000 ohms 1% 1/8W
R336	2100-2030	1	R: var metflm 20k ohms 30% 1/2W
R337	0757-0280		R: fxd metflm 1000 ohms 1% 1/8W
R341	0683-5125	1	R: fxd comp 5100 ohms 1% 1/4W
R342			NSR: p/o A8 (220 kilohms 1/4W)
R343	0698-5677	1	R: fxd comp 8.25 megohm 5% 1W
R344	2100-1906	1	R: var comp 5 megohms 10% 1/2W
R345	0698-5678	1	R: fxd comp 16.25 megohms 5% 1W
R346	0683-1045	1	R: fxd comp 100k ohms 5% 1/4W
R347	2100-1905	1	R: fxd comp 50k ohms 20% 1/2W
R348	2100-2031	1	R: var metflm 50k ohms 30% 1/2W
R349	0757-0454	1	R: fxd metflm 33.2k ohms 1% 1/8W
R350	2100-1901	1	R: var ww 100 ohms 10% 2W
R351	0757-0280		R: fxd metflm 1000 ohms 1% 1/8W
R35	0757-0280		R: fxd metflm 1000 ohms 1% 1/8W
R353	0757-0460		R: fxd metflm 61.9k ohms 1% 1/8W
R354	0757-0456		R: fxd metflm 43.2k ohms 1% 1/8W
R401	0757-0280		R: fxd metflm 1000 ohms 1% 1/8W
R402	0811-1788	1	R: fxd ww 15 ohms 5% 2W
R403	0757-0465		R: fxd metflm 100k ohms 1% 1/8W
R404	0757-0280		R: fxd metflm 1000 ohms 1% 1/8W
R405	0757-0399	2	R: fxd metflm 82.5 ohms 1% 1/8W
R406	0757-0848	3	R: fxd metflm 30.1k ohms 1% 1/2W
R407	0757-0200	3	R: fxd metflm 5620 ohms 1% 1/8W
R408	0757-0438		R: fxd metflm 5110 ohms 1% 1/8W
R409	0757-0764		R: fxd metflm 33.2k ohms 1% 1/4W
R410	0757-0388		R: fxd metflm 30.1 ohms 1% 1/8W
R411	0757-0200		R: fxd metflm 5620 ohms 1% 1/8W
R412	2100-1774	1	R: var ww 2000 ohms 10% 1/2W
R413	0757-0855	1	R: fxd metflm 68.1k ohms 1% 1/2W
R417	0757-0388		R: fxd metflm 30.1 ohms 1% 1/8W
R418	0757-0044	1	R: fxd metflm 33.2k ohms 1% 1/2W
R419	0811-1746	2	R: fxd ww 0.36 ohms 5% 2W
R420	0757-0463		R: fxd metflm 82.5k ohms 1% 1/8W
R421	0757-0480	1	R: fxd metflm 432k ohms 1% 1/8W
R422	0757-0434		R: fxd metflm 3650 ohms 1% 1/8W
R423	2100-1772	2	R: var ww 500 ohms 10% 1/2W

Ref Desig	HP Part No.	TQ	Description (Refer to Table 6-1.)
R424	0757-0060	2	R: metflm 24.3k ohms 1% 1/2W
R428	0757-0388		R: fxd metflm 30.1 ohms 1% 1/8W
R429	0757-0848		R: fxd metflm 30.1k ohms 1% 1/2W
R430	0811-1746		R: fxd ww 0.36 ohms 5% 2W
R431	0757-0465		R: fxd metflm 100k ohms 1% 1/8W
R432	0757-0477	1	R: fxd metflm 332k ohms 1% 1/8W
R433	0757-0434		R: fxd metflm 3650 ohms 1% 1/8W
R434	2100-1772		R: var ww 500 ohms 10% 1/2W
R435	0757-0060		R: fxd metflm 24.3k ohms 1% 1/2W
R439	0811-1678	1	R: fxd ww 10 ohms 5% 2W
R440	0757-0465		R: fxd metflm 100k ohms 1% 1/8W
R441	0757-0280		R: fxd metflm 1000 ohms 1% 1/8W
R442	0757-0399		R: fxd metflm 82.5 ohms 1% 1/8W
R443	0757-0848		R: fxd metflm 30.1k ohms 1% 1/2W
R444	0757-0200		R: fxd metflm 5620 ohms 1% 1/8W
R445	0757-0465		R: fxd metflm 100k ohms 1% 1/8W
R446	0757-0764		R: fxd metflm 33.2k ohms 1% 1/4W
R447	0757-0388		R: fxd metflm 30.1 ohms 1% 1/8W
R448	0757-0436		R: fxd metflm 4320 ohms 1% 1/8W
R449	2100-1773		R: var ww 1000 ohms 10% 1/2W
R450	0698-3416	1	R: fxd metflm 21.5k ohms 1% 1/2W
S101	3100-1344	1	S: rotary (includes R211)
S102	3101-0977	1	S: pushbutton dpdt
S201	3101-0070	1	S: slide dpdt
S202	3101-0982	1	S: slide spdt
S203	3100-1345	1	S: rotary 3 position
S401	3101-0995	1	S: toggle, power
S402	3101-0109	1	S: slide dpdt
T301	00180-60801	1	T: high voltage
T401	9100-1129	1	T: power
TP301	1251-0206	5	TP: female
TP401	1251-0206		TP: female
TP402	1251-0206		TP: female
TP403	1251-0206		TP: female
TP404	1251-0206		TP: female
V301	2140-0018	2	V: neon (NE-2E1)
V302	2140-0018		V: neon (NE-2E1)
V303	5083-9023	1	V: CRT
V401	1940-0013	2	V: voltage reference 82V
V402	1940-0013		V: voltage reference 82V
VR301	1902-0045	1	VR: zener 7.32V
VR302	1902-0025	1	VR: zener 10V
VR401	1902-3096	1	VR: zener 5.23V
VR402	1902-3354	2	VR: zener 54.9V
VR403	1902-3354		VR: zener 54.9V

Ref Desig	HP Part No.	TO	Description (Refer to Table 6-1.)
W1	00180-61616	1	W: assy coax J1 to S101
W2	00180-61625	1	W: assy vertical deflection
W3	00180-61650	1	W: assy sweep gate output
W4	00180-61651	1	W: assy horizontal deflection
W5	00180-61653	1	W: assy low-voltage power supply
W6	00180-61657	1	W: assy horizontal magnifier
W7	00180-61658	1	W: assy (T401) low-voltage transformer
W8	00180-61664	1	W: assy main harness
W9	00180-61646	1	W: assy, coax J1 to R158 (p/o W3)
W10	00180-61647	1	W: assy, coax J1 to R155 (p/o W3)
W11	00180-61648	1	W: assy, coax J1 to R152 (p/o W3)
W12	00180-61649	1	W: assy, coax J1 to R149 (p/o W3)
W13	00180-61609	1	W: assy, coax S101 to S201 (p/o W8)
W14	00180-61639	1	W: assy, coax R101 to R103 (p/o W8)
W15	00180-61642	1	W: assy, coax J1 to R132 (p/o W8)
W16	00180-61643	1	W: assy coax J1 to Q101 (p/o W8)
W17	00180-61644	1	W: assy coax J1 to R102 (p/o W8)
W18	00180-61645	1	W: assy coax calibrator (p/o W8)
W19	00180-61663	1	W: assy shielded power (p/o W8)
W101	00180-61652	1	W: assy, coax display switch
W401	00180-61674	1	W: power (includes P401)
XF401	1400-0084	4	Holder: fuse, cartridge
XF402	1400-0084		Holder: fuse, cartridge
XF403	1400-0084		Holder: fuse, cartridge
XF404	1400-0084		Holder: fuse, cartridge
XV303	---		Consists of:
	1200-0037	1	Socket: CRT
	1200-0050	7	Pin: CRT socket
	1200-0408	1	Cover: CRT socket

Table 6-3. Option 21 Replaceable Parts

REF DESIG	DESCRIPTION
A1	CIRCUIT BOARD, CALIBRATOR, GATE, AND HIGH VOLTAGE CONTROL: Printed circuit board w/all components assembled for operation; mfr 28480, P/N 00180-66536.
A1C100	Not Used.
A1C101	Not Used.
A1C102	CAPACITOR, FIXED, MYLAR: 0.01 uF ±5% 200 wVdc;
A1C103	CAPACITOR, FIXED, MYLAR: 0.022 uF ±10%; mfr 56289, P/N 192P10352 PTS.
A1C104	CAPACITOR: Same as A1C103.
A1C105	CAPACITOR: Same as A1C103.
A1C106	CAPACITOR: Same as A1C103.
A1C107	Not Used.
to	
A1C109	
A1C110	CAPACITOR, VARIABLE, POLYSTYRENE: 0.7 to 3 pF 350 wVdc;
A1C111	CAPACITOR: MIL type CC20CJ3R3C
A1C112	CAPACITOR: MIL type CM06FD202G03
A1C113	CAPACITOR, VARIABLE, TEFLON: 0.2 to 1.5 pF 600 wVdc;
A1C114	CAPACITOR: Same as A1C103.
A1C115	CAPACITOR, FIXED, ELECTROLYTIC: 100 uF, 12 wVdc;
A1C116	CAPACITOR, FIXED, CERAMIC: 20 pF 100 wVdc;
A1C117	Not Used.
to	
A1C119	
A1C120	CAPACITOR, FIXED, TANTALUM: 2.2 uF ±20% 20 wVdc;
A1C121	CAPACITOR, FIXED, MICA: 5825 pF ±2% 300 wVdc;
A1C122	CAPACITOR: Same as A1C121.
A1C123	CAPACITOR, FIXED, ELECTROLYTIC: 10 uF -10+100% 150 wVdc;
A1C300	Not Used.
A1C301	CAPACITOR, FIXED, ELECTROLYTIC: 20 uF 25 wVdc;
A1C302	CAPACITOR, FIXED, CERAMIC: 4500 pF 3500 wVdc;
A1C303	CAPACITOR, FIXED, MYLAR: 0.1 uF ±5% 200 wVdc;
A1C304	Not Used.
to	
A1C309	

Table 6-3. Option 21 Replaceable Parts (Cont'd)

REF DESIG	DESCRIPTION
A1C310	CAPACITOR, FIXED, CERAMIC: 0.01 uF 5000 wVdc; mfr 71590, P/N DA938-000J.
A1C311	CAPACITOR, FIXED, CERAMIC: 0.01 uF 5000 wVdc; mfr 28480, P/N 0160-2320.
A1C312 to A1C315	Not Used.
A1C316	CAPACITOR: Same as A1C310.
A1C317	CAPACITOR: Same as A1C311
A1CR100	Not Used.
A1CR101	DIODE, SILICON: Mfr 07263, P/N FD7018.
A1CR102	DIODE, SILICON: JAN 1N914.
A1CR103	DIODE: Same as A1CR102.
A1CR104	DIODE: Same as A1CR102.
A1CR105 to A1CR107	Not Used
A1CR108	DIODE: Same as A1CR102.
A1CR109	DIODE, SILICON: Mfr 04713, P/N SR1358-10.
A1CR110	DIODE: Same as A1CR109
A1CR111	DIODE: Same as A1CR102.
A1CR112	DIODE, SILICON: Mfr 04713, P/N SR1356.
A1CR113	DIODE: Same as A1CR112.
A1CR114	Not Used.
A1CR115	DIODE, SILICON: Mfr 07263, P/N FD2225.
A1CR116	DIODE: Same as A1CR115.
A1CR117	DIODE: Same as A1CR115.
A1L100	Not Used.
A1L101	Not Used.
A1L102	INDUCTOR, FIXED: 22 uH \pm 10% mfr 28480, P/N 9140-0179.
A1L103 to A1L104	Not Used.
A1L105	INDUCTOR: Same as A1L102.
A1Q100	Not Used.
A1Q101	TRANSISTOR, SILICON, NPN: MIL type 2N2369.
A1Q102	TRANSISTOR: Same as A1Q101.
A1Q103	TRANSISTOR, SILICON, PNP: Mfr 04713, P/N SS2123.
A1Q104	TRANSISTOR, SILICON, NPN: Mfr 28480, P/N 1854-0271.
A1Q105	TRANSISTOR, SILICON, PNP: Mfr 04713, P/N SS2111.
A1Q106	TRANSISTOR, SILICON, NPN: MIL type 2N3440.
A1Q107	TRANSISTOR: Same as A1Q106.
A1Q300	Not Used
A1Q301	TRANSISTOR, SILICON, NPN: Mfr 07263, P/N S3620.
A1Q302	TRANSISTOR, SILICON, NPN: Mfr 01295, P/N SK1124.
A1Q303	TRANSISTOR, SILICON, NPN: MIL type 2N3053.

Table 6-3. Option 21 Replaceable Parts (Cont'd)

REF DESIG	DESCRIPTION
A1R100 A1R101 A1R102 A1R103 A1R104	Not Used. Not Used. RESISTOR: MIL type RN60C2000F. RESISTOR: Same as A1R102. RESISTOR: MIL type RN60C1000F.
A1R105 A1R106 A1R107 A1R108 to A1R110	RESISTOR: MIL type RN60C5112F. Not Used. RESISTOR: MIL type RN60C2741F. Not Used.
A1R111 A1R112 A1R113 A1R114 A1R115	RESISTOR: Same as A1R104. RESISTOR: Same as A1R104. RESISTOR: Same as A1R104. RESISTOR: MIL type RN60C6191F. RESISTOR: MIL type RN65C3920F.
A1R116 A1R117 A1R118 A1R119 A1R120	RESISTOR: MIL type RN60C6812F. RESISTOR: MIL type RN65C5620F. RESISTOR: Same as A1R102. RESISTOR: MIL type RN65C1302F. RESISTOR: MIL type RN60C1503F.
A1R121 A1R122	RESISTOR: Same as A1R119. RESISTOR, FIXED, COMPOSITION: 100 ohms $\pm 10\%$ 1/2W; mfr 28480, P/N 0687-1011.
A1R123 to A1R124	Not Used.
A1R125 A1R126 A1R127 A1R128 A1R129	RESISTOR: MIL type RN60C1001F. RESISTOR: MIL type RN65C2002F. RESISTOR: MIL type RN60C5110F. RESISTOR: MIL type RN60C8251F. RESISTOR: MIL type RN60C5111F.
A1R130 A1R131 A1R132 A1R133 A1R134 to A1R135	RESISTOR: MIL type RN60C3651F. RESISTOR: MIL type RN60C2001F. RESISTOR: MIL type RN60C8250F. RESISTOR: MIL type RL32S683J. Not used.
A1R136 A1R137 A1R138 A1R139 A1R140	RESISTOR: Same as A1R126. RESISTOR: MIL type RN60C1303F. RESISTOR: Same as A1R137. RESISTOR: MIL type RC07GF2R7J. RESISTOR: Same as A1R131.
A1R141 A1R142 A1R143 A1R144	RESISTOR: Same as A1R102. RESISTOR: Same as A1R126. RESISTOR: MIL type RN60C50R0B. RESISTOR: MIL type RN60C1951B.

Table 6-3. Option 21 Replaceable Parts (Cont'd)

REF DESIG	DESCRIPTION
A1R145	RESISTOR, FIXED, METAL FILM: 17.82k ohms $\pm 0.1\%$ 1/2W; mfr 19701, P/N MF7CT217821B.
A1R300	Not Used.
A1R301	RESISTOR: Same as A1R139.
A1R302	RESISTOR, VARIABLE, METAL FILM: 200k ohms $\pm 20\%$; mfr 28480, P/N 2100-0944.
A1R303	RESISTOR, FIXED, METAL FILM: 909k ohms $\pm 1\%$ 1/2W; mfr 28480, P/N 0757-0138.
A1R304	RESISTOR: MIL type RN60C1002F.
A1R305	RESISTOR, FIXED, METAL FILM: 30 megohms $\pm 1\%$ 1W; mfr 28480, P/N 0698-7182.
A1R306 to A1R309	Not Used.
A1R310	RESISTOR, FIXED, COMPOSITION: 1k ohms $\pm 5\%$ 1/2W; mfr 01121, P/N EB1025.
A1R311 to A1R312	Not Used.
A1R313	RESISTOR: Same as A1R304.
A1R314	RESISTOR: Same as A1R129.
A1R315	RESISTOR: MIL type RN70D2494F.
A1R316	RESISTOR: Same as A1R131.
A1R317	RESISTOR: Same as A1R125.
A1R318	RESISTOR: MIL type RN60C1003F.
A1R319	RESISTOR: Same as A1R104.
A1R320	RESISTOR: MIL type RN70C5110F.
A1R321	RESISTOR: Same as A1R318.
A1R322	Not Used.
to A1R327	
A1R328	RESISTOR: MIL type RC07GF 105J.
A1R329	Not Used.
A1R330	RESISTOR: MIL type RN60C4322F.
A1R331	RESISTOR: MIL type RN60C6192F.
A1R332	RESISTOR: Same as A1R330.
A1R333	RESISTOR: Same as A1R331.
A1R334	Not Used.
to	
A1R340	
A1R341	RESISTOR, FIXED, COMPOSITION: 5.1k ohms $\pm 5\%$ 1/4W; mfr 28480, P/N 0683-5125.
A1R342	Not Used.
A1R343	RESISTOR, FIXED, CARBON FILM: 8.25 megohms $\pm 5\%$ 1W; mfr 77764, P/N B8FW8254J.
A1R344	Not Used.
A1R345	RESISTOR, FIXED, CARBON FILM: 16.25 megohms $\pm 5\%$ 1W; mfr 77764, P/N B8FW 6254J.

Table 6-3. Option 21 Replaceable Parts (Cont'd)

REF DESIG	DESCRIPTION
A1R346 A1R347 A1R348	Not Used. Not Used. RESISTOR, VARIABLE, METAL FILM: 50k ohms \pm 30%; mfr 73138, P/N 62P-R50K.
A1R349 A1R350 A1R351 A1R352 A1R353	RESISTOR: MIL type RN60C3322F. Not Used. RESISTOR: Same as A1R125. RESISTOR: Same as A1R125. RESISTOR: Same as A1R331.
A1R354	RESISTOR: Same as A1R330.
A1TP300 A1TP301	Not Used. JACK, TEST, FEMALE: Mfr 98291, P/N SKT400.
A1V300 A1V301 A1V302	Not Used. LAMP, NEON: Mfr 24455, P/N NE2E1. LAMP: Same as A1V301.
A1VR300 A1VR301 A1VR302	Not Used. DIODE, ZENER: 7.2V, 400 mW mfr 01281, P/N PS18247B. DIODE, ZENER: 10V 400 mW mfr 01281, P/N PS18260A.
A2	CIRCUIT BOARD, MAIN AND DELAYED SWEEP AND GATE OUTPUT AMPLIFIER: Printed circuit board w/all components assembled for operation; mfr 28480, P/N 00180-66533.
A2C100 to A2C126 A2C127 A2C128	Not Used. CAPACITOR: Same as A1C120. CAPACITOR: Same as A1C120.
A2L100 to A2L106 A2L107 A2L108	Not Used. INDUCTOR: Same as A1L102. INDUCTOR: Same as A1L102.
A2Q100 to A2Q107 A2Q108 A2Q109 A2Q110	Not Used. TRANSISTOR: Same as A1Q302. TRANSISTOR: Same as A1Q302. TRANSISTOR, SILICON, PNP: MIL type 2N3638.
A2Q111 A2R100 to A2R148 A2R149	TRANSISTOR: Same as A2Q110. Not Used. RESISTOR: MIL type RN60C2432F.
A2R150 A2R151	RESISTOR: Same as A1R129. RESISTOR: MIL type RN60C4321F.

Table 6-3. Option 21 Replaceable Parts (Cont'd)

REF DESIG	DESCRIPTION
A2R152	RESISTOR: Same as A2R149.
A2R153	RESISTOR: Same as A2R129.
A2R154	RESISTOR: Same as A2R151.
A2R155	RESISTOR: MIL type RN60C2431F.
A2R156	RESISTOR: Same as A1R131.
A2R157	RESISTOR: Same as A1R129.
A2R158	RESISTOR: Same as A1R155.
A2R159	RESISTOR: Same as A1R131.
A2R160	RESISTOR: Same as A1R129.
A2R161	RESISTOR: Same as A1R139.
A2R162	RESISTOR: Same as A1R139.
A3	CIRCUIT BOARD, HORIZONTAL AMPLIFIER: Printed circuit board w/all components assembled for operation mfr 28480, P/N 00180-66531.
A3C200	Not Used.
A3C201	Not Used.
A3C202	CAPACITOR, FIXED, CERAMIC: 4700 pF -20+100% 500 wVdc; mfr 72982, P/N 851-000X5U0-472Z.
A3C203	CAPACITOR, VARIABLE, MICA: 16 to 150 pF 175 wVdc; mfr 28480, P/N 0131-0004.
A3C204	CAPACITOR, FIXED, MICA: 440 pF ±1% 300 wVdc; mfr 28480, P/N 0140-0231.
A3C205	CAPACITOR: Same as A1C103.
A3C206	CAPACITOR: Same as A1C103.
A3C207 to A3C209	Not Used.
A3C210	CAPACITOR, VARIABLE, GLASS: 0.7 to 3 pF 350 wVdc; mfr 72982, P/N 535-033-4R.
A3C211	CAPACITOR: Same as A1C103.
A3C212	CAPACITOR, FIXED, MYLAR: 0.047 uF ±10% 200 wVdc; mfr 56289, P/N 192P47392PTS.
A3C213	CAPACITOR: Same as A3C210.
A3C214	CAPACITOR: MIL type CC20CKR75C.
A3C215 to A3C217	Not Used.
A3C218	CAPACITOR: Same as A1C103.
A3C219	CAPACITOR: Same as A1C103.
A3C220	CAPACITOR: MIL type CS13BE225K.
A3C221	CAPACITOR: Same as A3C220.
A3C222	CAPACITOR: Same as A1C103.
A3C223 to A3C225	Not Used.

Table 6-3. Option 21 Replaceable Parts (Cont'd)

REF DESIG	DESCRIPTION
A3C226 A3C227 A3C228 A3C229 A3C230 A3C231	CAPACITOR: Same as A3C220. CAPACITOR: Same as A3C220. CAPACITOR: MIL type CS13BF154K. CAPACITOR: Same as A3C210. CAPACITOR: Same as A1C103. CAPACITOR: Same as A3C212.
A3CR200 A3CR201 A3CR202 A3CR203 A3CR204	Not Used. DIODE: Same as A1CR115. DIODE, SILICON: Mfr 28480, P/N 5080-0464. DIODE: Same as A1CR102. DIODE: Same as A3CR202.
A3CR205 A3CR206 A3CR207 A3CR208 A3CR209	DIODE: Same as A1CR102. DIODE: Same as A1CR102. DIODE: Same as A3CR202. DIODE: Same as A3CR202. DIODE: Same as A1CR102.
A3L200 A3L201 A3L202 A3L203	INDUCTOR: Same as A1L102. Not Used. INDUCTOR: Same as A1L102. INDUCTOR, BEAD, FERRITE: Mfr 02114, P/N 56-590-65/4A.
A3Q200 A3Q201 A3Q202 A3Q203	Not Used. TRANSISTOR, SILICON, FIELD-EFFECT, N CHANNEL: Mfr 05397, P/N F1151. TRANSISTOR, SILICON, NPN: Mfr 01295, P/N SM6924. TRANSISTOR, GERMANIUM, PNP: MIL type 2N2635.
A3Q204 A3Q205 A3Q206 A3Q207 A3Q208	TRANSISTOR: Same as A1Q101. TRANSISTOR: Same as A1Q302. TRANSISTOR: Same as A1Q101. TRANSISTOR: Same as A1Q101. TRANSISTOR: Same as A1Q105.
A3Q209 A3Q210 A3Q211 A3Q212 A3Q213	TRANSISTOR: MIL type 2N3119. TRANSISTOR: Same as A1Q103. TRANSISTOR: Same as A1Q105. TRANSISTOR: Same as A3Q209. TRANSISTOR: Same as A1Q103.
A3R200 A3R201 A3R202 A3R203 A3R204	Not Used. RESISTOR: Same as A1R318. RESISTOR: MIL type RN65C1004F. RESISTOR: Same as A1R104. RESISTOR, FIXED, METAL FILM: 18k ohms \pm 5% 1W; mfr 28480, P/N 0761-0076.
A3R205 A3R206 A3R207 A3R208	RESISTOR: MIL type RN60C2210F. RESISTOR: MIL type RN70C2742F. RESISTOR, VARIABLE, COMPOSITION: 50k ohms \pm 20% 1/5W; mfr 28480, P/N 2100-1418. RESISTOR: MIL type RN60C7501F.

Table 6-3. Option 21 Replaceable Parts (Cont'd)

REF DESIG	DESCRIPTION
A3R209	RESISTOR, FIXED, METAL FILM: 3874 ohms $\pm 0.1\%$, 1/8W; mfr 07716, P/N CEAT238740B.
A3R210	RESISTOR; MIL type RN60C8252F.
A3R211	Not Used.
to	
A3R214	
A3R215	RESISTOR: Same as A1R128.
A3R216	RESISTOR: MIL type RN65C6813F.
A3R217	RESISTOR: Same as A1R104.
A3R218	Not Used.
A3R219	RESISTOR: Same as A1R331.
A3R220	RESISTOR: Same as A1R104.
A3R221	Not Used.
A3R222	RESISTOR: Same as A1R131.
A3R223	RESISTOR: MIL type RN65C3322F.
A3R224	Not Used.
A3R225	RESISTOR: MIL type RN65C2431F.
A3R226	RESISTOR: Same as A1R104
A3R227	Not Used.
A3R228	Not Used.
A3R229	RESISTOR: Same as A1R107.
A3R230	RESISTOR: MIL type RN60C1102F.
A3R231	RESISTOR: Same as A1R130.
A3R232	RESISTOR: MIL type RN65C1501F.
A3R233	Not Used.
A3R234	RESISTOR: MIL type RN70C2212F.
A3R235	RESISTOR: MIL type RN60C3920F.
A3R236	Not Used.
A3R237	RESISTOR: Same as A1R102.
A3R238	RESISTOR: MIL type RN70C1212F.
A3R239	RESISTOR: MIL type RN60C1822F.
A3R240	Not Used.
to	
A3R243	
A3R244	RESISTOR: Same as A1R139.
A3R245	RESISTOR, FIXED, METAL FILM: 30.1 ohms $\pm 1\%$ 1/8W; mfr 07716, P/N CEAT030R1F.
A3R246	RESISTOR, VARIABLE, WIRE WOUND: 100 ohms $\pm 5\%$ 1W; mfr 28480, P/N 2100-1770.
A3R247	RESISTOR: MIL type RN60C1500F.
A3R248	RESISTOR, VARIABLE, WIRE WOUND: 200 ohms $\pm 5\%$ 1W; mfr 28480, P/N 2100-1771.
A3R249	RESISTOR: MIL type RN60C3320F.
A3R250	RESISTOR, VARIABLE, WIRE WOUND: 1k ohms $\pm 10\%$ 1/2W; mfr 28480, P/N 2100-1773.

Table 6-3. Option 21 Replaceable Parts (Cont'd)

REF DESIG	DESCRIPTION
A3R251 A3R252 A3R253	RESISTOR: MIL type RN60C1621F. RESISTOR: MIL type RN70C2152F. RESISTOR, VARIABLE, WIRE WOUND: 5k ohms $\pm 5\%$ 1W; mfr 28480, P/N 2100-0741.
A3R254 A3R255 A3R256 A3R257 A3R258	RESISTOR: Same as A3R252. Not Used. Not Used. RESISTOR: Same as A1R137. RESISTOR: Same as A3R208.
A3R259 A3R260 A3R261 A 262 A3R263	RESISTOR: MIL type RN60C1501F. Not Used. RESISTOR: Same as A3R225. RESISTOR: Same as A1R107. RESISTOR: MIL type RN60C5621F.
A3R264 A3R265 to A3R267 A3R268	RESISTOR: Same as A3R230. Not Used. RESISTOR: Same as A1R130.
A3R269 A3R270 A3R271 A3R272 A3R273	RESISTOR: Same as A3R232. RESISTOR: Same as A3R235. RESISTOR: Same as A3R234. Not Used. RESISTOR: Same as A1R102.
A3R274 A3R275	Not Used. RESISTOR: Same as A3R238.
A3R300 to A3R334 A3R335 A3R336	Not Used. RESISTOR: Same as A1R125. RESISTOR, VARIABLE, METAL FILM: 20k ohms $\pm 30\%$; mfr 73138, P/N 62P-R20K.
A3R337	RESISTOR: Same as A1R125.
A3S200 A3S201 A3S202	Not Used. Not Used. SWITCH, SLIDE: SPDT, mfr 79727, P/N 6938.
A4	CIRCUIT BOARD, HIGH VOLTAGE OSCILLATOR: Printed circuit board w/all components assembled for operation; mfr 28480, P/N 00180-66535.
A4C300 to A4C306 A4C307 A4C308	Not Used. CAPACITOR: MIL type CS138F476K. CAPACITOR, FIXED, MYLAR: 0.22 μ F $\pm 10\%$ 200 wVdc; mfr 56289, P/N 192P22492 PTS.

Table 6-3. Option 21 Replaceable Parts (Cont'd)

REF DESIG	DESCRIPTION
A4CR300 A4CR301	Not Used. DIODE, SILICON: Mfr 04713, P/N SR13F3-6.
A4L300 A4L301	Not Used. INDUCTOR, FIXED: 22 uH, mfr 95265, P/N QB22-1.
A5	CIRCUIT BOARD, HIGH VOLTAGE RECTIFIER: Printed circuit board w/all components assembled for operation; mfr 28480, P/N 00180-66534.
A5C300 to A5C308 A5C309 A5C310 to A5C314	Not Used. CAPACITOR: Same as A1C310. Not Used.
A5C315	CAPACITOR: Same as A1C311.
A5CR300 A5CR301 A5CR302 A5CR303 to A5CR306	Not Used. Not Used. DIODE, SILICON; Mfr 28480, P/N 1901-0341. Not Used.
A5CR307	DIODE: Same as A5CR302.
A5R300 to A5R324 A5R325 A5R326	Not Used. RESISTOR: MIL type RC07GF223J. RESISTOR, VARIABLE, COMPOSITION: 1 megohm \pm 20% linear 1/5W; mfr 28480, P/N 2100-161a.
A5R327	RESISTOR, FIXED, DEPOSITED CARBON: 29 megohms \pm 10% 1W; mfr 28480, P/N 0836-0003.
A5T300 A5T301	Not Used. TRANSFORMER, HIGH VOLTAGE: Mfr 28480, P/N 00180-60801.
A6	CIRCUIT BOARD, LOW VOLTAGE RECTIFIER: Printed circuit board w/all components assembled for operation; mfr 28480, P/N 00180-66532.
A6C400 A6C401	Not Used. CAPACITOR, FIXED, ELECTROLYTIC: 100 uF 20 wVdc; mfr 56289, P/N 600D107G020DD4.
A6CR400 A6CR401 A6CR402 A6CR403 A6CR404	Not Used. DIODE: Same as A4CR301. DIODE: Same as A4CR301. DIODE: Same as A4CR301. DIODE: Same as A4CR301.

Table 6-3. Option 21 Replaceable Parts (Cont'd)

REF DESIG	DESCRIPTION
A6CR405 to A6CR407 A6CR408 A6CR409	Not Used. DIODE, SILICON: Mfr 28480, P/N 1901-0028. DIODE: Same as A6CR408.
A6CR410 A6CR411 A6CR412 A6CR413 A6CR414	DIODE: Same as A6CR408. DIODE: Same as A6CR408. Not Used. DIODE, SILICON: Mfr 28480, P/N 1901-0415. DIODE: Same as A6CR413.
A6CR415 A6CR416 A6CR417 to A6CR420	DIODE: Same as A6CR413. DIODE: Same as A6CR413. Not Used.
A6CR421 A6CR422 A6CR423 A6CR424 A6CR425	DIODE: Same as A6CR413. DIODE: Same as A6CR413. DIODE: Same as A6CR413. DIODE: Same as A6CR413. Not Used.
A6CR426 A6CR427 A6CR428 A6CR429	DIODE: Same as A6CR408. DIODE: Same as A6CR408. DIODE: Same as A6CR408. DIODE: Same as A6CR408.
A6E1	SPACER, CERAMIC: Mfr 28480, P/N 3100-1580.
A6R400 A6R401 A6R402	Not Used. Not Used. RESISTOR, FIXED, WIRE WOUND: 15 ohms $\pm 5\%$ 2W; mfr 28480, P/N 0811-1788.
A6R403	RESISTOR: Same as A1R318.
A6R404 to A6R438 A6R439	Not Used. RESISTOR, FIXED, WIRE WOUND: 10 ohms $\pm 5\%$ 2W; mfr 75042, P/N BWH 10.
A6R440	RESISTOR: Same as A1R318.
A7	CIRCUIT BOARD, LOW VOLTAGE POWER SUPPLY: Printed circuit board w/all components assembled for operation; mfr 28480, P/N 00180-66513.
A7C400 to A7C405 A7C406 A7C407	Not Used. CAPACITOR, FIXED, MYLAR: 0.1 μ F $\pm 10\%$ 200 wVdc; mfr 56289, P/N 192P10492 PTS. CAPACITOR: MIL type CS138F475K.

Table 6-3. Option 21 Replaceable Parts (Cont'd)

REF DESIG	DESCRIPTION
A7C408	CAPACITOR, FIXED, ELECTROLYTIC: 18 uF 150 wVdc; mfr 56289, P/N 600D186F150DG4.
A7C409 to A7C412	Not Used.
A7C413 A7C414	CAPACITOR: Same as A7C406. CAPACITOR: Same as A4C307.
A7C415 to A7C418	Not Used.
A7C419 A7C420	CAPACITOR: Same as A7C406. CAPACITOR: Same as A4C307.
A7C421 to A7C424	Not Used.
A7C425 A7C426	CAPACITOR: Same as A7C406. CAPACITOR: Same as A7C407.
A7C427	CAPACITOR: Same as A7C408.
A7CR400 to A7CR404	Not Used.
A7CR405 A7CR406 A7CR407	DIODE: Same as A1CR102. DIODE: Same as A1CR102. DIODE: Same as A1CR102.
A7CR408 to A7CR411	Not Used.
A7CR412 A7CR413 to A7CR416	DIODE, SILICON: Mfr 04713, P/N SR1358-8. Not Used.
A7CR417 A7CR418	DIODE: Same as A1CR102. Not Used.
A7CR419 A7CR420	DIODE: Same as A1CR102. DIODE: Same as A1CR102.
A7CR421 to A7CR424	Not Used.
A7CR425 A7CR426 to A7CR429	DIODE: Same as A1CR102. Not Used.
A7CR430 A7CR431	DIODE: Same as A7CR412. Not Used.
A7CR432 A7CR433 A7CR434	DIODE: Same as A1CR102. DIODE: Same as A1CR102. DIODE: Same as A1CR102.

Table 6-3. Option 21 Replaceable Parts (Cont'd)

REF DESIG	DESCRIPTION
A7Q400 A7Q401 A7Q402 A7Q403 A7Q404	Not Used. Not Used. TRANSISTOR, SILICON, NPN: Mfr 04713, P/N SM8158. TRANSISTOR, SILICON, NPN: Mfr 04713, P/N MPS3417. TRANSISTOR: Same as A1Q302.
A7Q405 A7Q406 A7Q407 A7Q408 A7Q409	TRANSISTOR: Same as A1Q303. Not Used. TRANSISTOR: Same as A1Q302. TRANSISTOR: Same as A1Q302. TRANSISTOR: Same as A1Q303.
A7Q410 A7Q411 A7Q412 A7Q413 A7Q414	Not Used. TRANSISTOR: Same as A1Q302. TRANSISTOR: Same as A1Q302. TRANSISTOR: Same as A7Q402. Not Used.
A7Q415 A7Q416	TRANSISTOR: Same as A7Q403. TRANSISTOR: Same as A1Q302.
A7R400 A7R401 A7R402 to A7R403	Not Used. RESISTOR: Same as A1R125. Not Used.
A7R404 A7R405 A7R406 A7R407 A7R408	RESISTOR: Same as A1R125. RESISTOR: MIL type RN60C82R5F. RESISTOR: MIL type RN70C3012F. RESISTOR: Same as A3R263. RESISTOR: Same as A1R129.
A7R409 A7R410 A7R411 A7R412	RESISTOR: Same as A3R223. RESISTOR: Same as A3R245. RESISTOR: Same as A3R263. RESISTOR, VARIABLE, WIRE WOUND: 2k ohms $\pm 10\%$ 1/2W; mfr 28480, P/N 2100-1774.
A7R413 A7R414 to A7R416 A7R417 A7R418	RESISTOR: MIL type RN70C6812F. Not Used. RESISTOR: Same as A3R245. RESISTOR: MIL type RN70C3322F.
A7R419	RESISTOR: FIXED, WIRE WOUND: 0.36 ohms $\pm 5\%$ 2W; mfr 75042, P/N BWHR36J.
A7R420 A7R421 A7R422 A7R423	RESISTOR: Same as A3R210. RESISTOR: MIL type RN60C4323F. RESISTOR: Same as A1R130. RESISTOR, VARIABLE, WIRE WOUND: 500 ohms $\pm 10\%$ 1/2W; mfr 28480, P/N 2100-1772.

Table 6-3. Option 21 Replaceable Parts (Cont'd)

REF DESIG	DESCRIPTION
<p>A7R424 A7R425 to A7R427 A7R428 A7R429</p>	<p>RESISTOR: MIL type RN70C2432F. Not Used.</p> <p>RESISTOR: Same as A3R245. RESISTOR: Same as A7R406.</p>
<p>A7R430 A7R431 A7R432 A7R433 A7R434</p>	<p>RESISTOR: Same as A7R419. RESISTOR: Same as A1R318. RESISTOR: MIL type RN60C3323F. RESISTOR: Same as A1R130. RESISTOR: Same as A7R423.</p>
<p>A7R435 A7R436 to A7R440 A7R441</p>	<p>RESISTOR: Same as A7R424. Not Used.</p> <p>RESISTOR: Same as A1R125.</p>
<p>A7R442 A7R443 A7R444 A7R445 A7R446</p>	<p>RESISTOR: Same as A7R405. RESISTOR: Same as A7R406. RESISTOR: Same as A3R263. RESISTOR: Same as A1R318. RESISTOR: Same as A3R223.</p>
<p>A7R447 A7R448 A7R449 A7R450</p>	<p>RESISTOR: Same as A3R245. RESISTOR: Same as A2R151. RESISTOR: Same as A3R250. RESISTOR: Same as A3R252.</p>
<p>A7TP400 A7TP401 A7TP402 A7TP403 A7TP404</p>	<p>Not Used. JACK, TEST: Same as A1TP301. JACK, TEST: Same as A1TP301. JACK, TEST: Same as A1TP301. JACK, TEST: Same as A1TP301.</p>
<p>A7V400 A7V401 A7V402</p>	<p>Not Used. TUBE, VOLTAGE REFERENCE: 82 volts; mfr 74276, P/N Z82R7. TUBE: Same as A7V401.</p>
<p>A7VR400 A7VR401 A7VR402 A7VR403</p>	<p>Not Used. DIODE, ZENER: 5.23V, 400 mW; mfr 01281, P/N PS18233A. DIODE, ZENER: 54.6V, 400 mW; mfr 04713, P/N SZ10939-395. DIODE: Same as A7VR402.</p>
<p>A8</p>	<p>TRIPLER ASSEMBLY, HIGH VOLTAGE: Box w/all components assembled for operation; mfr 28480, P/N 00180-61101.</p>
<p>C100 C101</p>	<p>Not Used. CAPACITOR: Same as A7C406.</p>
<p>C200 C201</p>	<p>Not Used. CAPACITOR, FIXED, MYLAR: 0.1 uF ±20% 600 wVdc; mfr 56289, P/N148P175A.</p>

Table 6-3. Option 21 Replaceable Parts (Cont'd)

REF DESIG	DESCRIPTION
C400	Not Used.
C401	Not Used.
C4J2	CAPACITOR, FIXED, CERAMIC: 4700 pF -20+80%, 4000 wVdc; mfr 28480, P/N 0160-0151.
C403	Not Used.
C404	CAPACITOR: Same as C402.
C405	CAPACITOR, FIXED, ELECTROLYTIC: 430 uF 200 wVdc; mfr 56289, P/N 32D431F200AB2A.
C406 to C411	Not Used.
C412	CAPACITOR, FIXED, ELECTROLYTIC: 2100 uF 40 wVdc; mfr 56289, P/N 32D212G040AB5A.
C413 to C417 C418	Not Used.
	CAPACITOR, FIXED, ELECTROLYTIC: 3400 uF 25 wVdc; mfr 56289, P/N 32D342G025AB2A.
C419 to C423 C424	Not Used
	CAPACITOR, FIXED, ELECTROLYTIC: 290 uF 200 wVdc; mfr 56289, P/N 32D291F200 AB2A.
CR303	DIODE: Same as A1CR102.
DS400 DS401	Not Used. LIGHT INDICATOR: Mfr 08717, P/N 102SR-G-FB13.
E1	SPACER, CERAMIC: 8 required; mfr 28480, P/N 3100-1580.
E2	INSULATOR, TRANSISTOR: 5 Required mfr 28480, P/N 1200-0043.
E3	CLIP, FUSE: Mfr 28480, P/N 1400-0076.
E4	INSULATOR, LOW VOLTAGE BOARD: Mfr 28480, P/N 00180-05401.
E5	INSULATOR, BUSHING: 4 Required; mfr 28480, P/N 0340-0114.
E6	INSULATOR, TEFLON: 2 Required; mfr 28480, P/N 0340-0039.
F300 F301	Not Used. FUSE: MIL type MS90078-7.
F400 F401	Not Used. FUSE, SLOW BLOW: 3AG, 125V, 1-6/10 amp; mfr 28480, P/N 2110-0005.
F402 F403	FUSE: Same as F401. FUSE: 3 AG, 250V, 3/8 amp; mfr 28480, P/N 2110-0065.
F404 F405 F406	FUSE: MIL type MS90078-9. FUSE: Same as F404. FUSE: 3AG, 250V, 3/10 amp; mfr 71400, P/N AGC 3/10.
FL400 FL401	Not Used. FILTER, LINE: Mfr 28480, P/N 9100-2483.

Table 6-3. Option 21 Replaceable Parts (Cont'd)

REF DESIG	DESCRIPTION
H1	NUT, HORIZONTAL POSITION POT: Mfr 28480, P/N 00180-25703.
H2	INSULATOR, FOCUS: Mfr 28480, P/N 00180-45404.
H3	INSULATOR, 1/4 INCH BUSHING: 3 Required; mfr 28480, P/N 00180-45403.
H4	INSULATOR, BUSHING: Mfr 28480, P/N 00180-45402.
H5	SHAFT, BEAM FINDER: Mfr 28480, P/N 00180-23701.
H6	STANDOFF, GATE BOARD: Mfr 28480, P/N 00180-24702.
H7	STANDOFF, TRANSFORMER: 4 Required; mfr 28480, P/N 00180-24701.
H8	CLIP, DAG GROUND: Mfr 28480, P/N 00180-09105.
H9	CLIP, GROUND: Mfr 28480, P/N 00180-09104.
H10	CLIP, COMPONENT: 8 Required; mfr 28480, P/N 1400-0439.
H11	WASHER, NEOPRENE: .625 Outside diameter, 4 required; mfr 28480, P/N 1400-0090.
H12	SPACER, POST TYPE: 2 Required; mfr 28480, P/N 0380-0724.
H13	CLAMP, CABLE: .125 Diameter, 2 required; mfr 28480, P/N 1400-0325.
H14	CLAMP, CABLE: .437 Diameter; mfr 28480, P/N 1400-0018.
H15	CLAMP, CABLE: .500 Diameter; mfr 28480, P/N 1400-0025.
H16	CLAMP, CABLE: .438 Diameter; mfr 28480, P/N 1400-0093.
H17	CLAMP, CABLE: .250 Diameter; mfr 28480, P/N 1400-0116.
J1	CONNECTOR, RECEPTACLE: 32-contact, female; mfr 02660, P/N 264200-32S.
J2	CONNECTOR, CONTACT: 2 pin; mfr 28480, P/N 0363-0006.
J100	Not Used.
J101	CONNECTOR, BNC, FEMALE: 6 Required; Mfr 95712, P/N 30624-1.
J102	JACK, BANANA: Mfr 83330, P/N 219-2.
J103	JACK: Same as J102.
J104	POST, BINDING: Mfr 28480, P/N 00180-61001.
J105	CONNECTOR: Same as J101.
J106	CONNECTOR: Same as J101.
J107	CONNECTOR: Same as J101.
J108	CONNECTOR: Same as J101.
J200	Not Used.
J201	CONNECTOR: Same as J101.
J400	Not Used.
J401	Not Used.
J402	POST, BINDING: Mfr 28480, P/N 1510-0038.
L100	Not Used.
L101	INDUCTOR, FIXED: 20 uh \pm 10% mfr 28480, P/N 9140-0047.
L300	Not Used.
L301	Not Used.
L302	COIL, ALIGNMENT: Trace align; mfr 28480, P/N 5060-0435.
L303	COIL, ALIGNMENT: Y align; mfr 28480, P/N 00180-65601.

Table 6-3. Option 21 Replaceable Parts (Cont'd)

REF DESIG	DESCRIPTION
MP100 MP101	KNOB ASSEMBLY: Horizontal magnifier; mfr 28480, P/N 00180-67404. KNOB ASSEMBLY: Horizontal position, coarse; mfr 28480, P/N 00180-67402.
MP102 MP103	KNOB ASSEMBLY: Horizontal display; Same as MP100. LEVER: Horizontal position, Fine; mfr 28480, P/N 00180-05002.
MP104 MP105 MP106 MP107 MP108	KNOB LEVER: Mfr 28480, P/N 0370-0432. PUSHBUTTON: Find beam; mfr 28480, P/N 0370-0350. KNOB ASSEMBLY: Intensity; mfr 28480, P/N 0370-0348. KNOB ASSEMBLY: Focus; mfr 28480, P/N 00180-67401. KNOB ASSEMBLY: Scale; mfr 28480, P/N 00180-67403.
MP109 MP110 MP111 MP112 MP113	INSULATOR, CONTROL: Mfr 28480, P/N 5040-0453. COUPLER, SHORT: 2 Required; mfr 28480, P/N 00180-23202. COUPLER, FOCUS: Mfr 28480, P/N 00180-23201. GASKET, SHOCK MOUNTING: Mfr 28480, P/N 0905-0331. SHIELD, LIGHT: Mfr 28480, P/N 5040-0444.
MP114 MP115 MP116 MP117 MP118	FILTER, MESH CONTRAST: Mfr 28480, P/N 10178A. BEZEL: Mfr 28480, P/N 5020-0476. PANEL, FRONT: Mfr 28480, P/N 00180-00228. PANEL, SUB: Mfr 28480, P/N 00180-00226. PANEL, REAR: Mfr 28480, P/N 00180-00225.
MP119	CHASSIS ASSEMBLY, POWER CABINET: Mfr 28480, P/N 00180-60111.
MP120	CHASSIS ASSEMBLY, DISPLAY CABINET: Mfr 28480, P/N 00180-60112.
MP121 MP122 MP123 MP124 MP125	SPACER, FRONT: Mfr 28480, P/N 00180-24720. SPACER, SIDE: 2 Required; mfr 28480, P/N 00180-24715. SPACER, REAR: Mfr 28480, P/N 00180-24713. BAR IDENTIFICATION: Mfr 28480, P/N 00180-24711. SHIELD, CRT: Mfr 28480, P/N 00180-00602.
MP126 MP127 MP128	RING, RUBBER: Mfr 28480, P/N 4320-0201. BRACKET, TRACE ALIGN COIL: Mfr 28480, P/N 00180-01218. COVER PLATE, HIGH VOLTAGE SUPPLY: Mfr 28480, P/N 00180-04108.
MP129 MP130	INSULATOR, COVER PLATE: Mfr 28480, P/N 00180-25401. GUIDE, LEFT PLUG-IN: Mfr 28480, P/N 00180-43101.
MP131 MP132 MP133	GUIDE, RIGHT PLUG-IN: Mfr 28480, P/N 00180-43102. BRACKET, CONNECTOR: Mfr 28480, P/N 00180-01209. BRACKET, TRANSFORMER, FRONT, BOTTOM: Mfr 28480, P/N 00180-01210.
MP134	BRACKET, TRANSFORMER, FRONT, TOP: Mfr 28480, P/N 00180-01222.
MP135	BRACKET, TRANSFORMER, REAR, BOTTOM: Mfr 28480, P/N 00180-01215.
MP136	BRACKET, TRANSFORMER, REAR, TOP: Mfr 28480, P/N 00180-01223.

Table 6-3. Option 21 Replaceable Parts (Cont'd)

REF DESIG	DESCRIPTION
MP137 MP138 MP139	BRACKET, CAPACITOR: Mfr 28480, P/N 00180-01227. BRACKET, CONTROL MOUNTING: Mfr 28480, P/N 00180-01208. BRACKET, SHOCK MOUNTING: Mfr 28480, P/N 00180-01241.
MP140 MP141 MP142 MP143 MP144	SHOCK MOUNT: 2 Required; mfr 28480, P/N 1520-0071. BRACKET, CABINET TOP: Mfr 28480, P/N 00180-01243. BRACKET, TRANSISTOR: Mfr 28480, P/N 00180-01206. SUPPORT, TRANSFORMER: Mfr 28480, P/N C0180-04703. HEAT SINK ASSEMBLY, RIGHT TRANSISTOR: Mfr 28480, P/N 00180-61103.
MP145	HEAT SINK ASSEMBLY, LEFT TRANSISTOR: Mfr 28480, P/N 00180-61104.
MP146 MP147 MP148	FOOT, REAR, LONG: 2 Required; mfr 28480, P/N 5040-0447. FOOT, REAR, SHORT: 2 Required; mfr 28480, P/N 5040-0446. COVER, FUSE: Mfr 28480, P/N 00180-44106.
MP149 MP150 MP151 MP152 MP153	GROMMET: .250 Inside diameter; mfr 28480, P/N 0400-0010. EXTRUSION, RUBBER: 6 inch; mfr 28480, P/N 4320-0007. CLAMP, SHOCK MOUNT ASSEMBLY: Mfr 28480, P/N 00180-61203. COVER ASSEMBLY: Mfr 28480, P/N 00180-64401. CASTING, REAR: Mfr 28480, P/N 00180-62002.
MP154 MP155 MP156 MP157 MP158 MP159	FOOT, BOTTOM: 4 Required; mfr 28480, P/N 0403-0019. HANDLE: Mfr 28480, P/N 5040-0459. SPACER, HANDLE: 2 Required; mfr 28480, P/N 00180-24718. KEEPER, HANDLE: 2 Required; mfr 28480, P/N 00180-22301. HEAT SINK, DUAL TRANSISTOR: mfr 28480, P/N 1205-0063. GASKET, RFI: Mfr 07700, P/N 85-90053.
P400 P401	Not Used. CONNECTOR, PLUG, POWER: Mfr 28480, P/N 1251-0037.
Q300 to Q303 Q304	Not Used TRANSISTOR, SILICON, NPN: Mfr 04713, P/N SJ1266.
Q400 Q401 Q402 to Q405	Not Used. TRANSISTOR, SILICON, NPN: MIL type 2N3055. Not Used.
Q406 Q407 to	TRANSISTOR: Same as Q401. Not Used.
Q409 Q410	TRANSISTOR: Same as Q401.
Q411 to Q413 Q414	Not Used. TRANSISTOR: Same as Q401.

Table 6-3. Option 21 Replaceable Parts (Cont'd)

REF DESIG	DESCRIPTION
R100 R101 R102 to R105 R106	Not Used. TRISISTOR: Same as A1R129. Not Used. RESISTOR, VARIABLE, COMPOSITION: 10k ohms $\pm 20\%$ 1/4W; mfr 28480, P/N 2100-1904.
R200 to R210 R211	Not Used. RESISTOR, VARIABLE, COMPOSITION: 50k ohms $\pm 30\%$ 1/2W; Special slot; mfr 28480, P/N 2100-2089.
R212 to R217 R218	Not Used. RESISTOR, VARIABLE, COMPOSITION: 100k ohms $\pm 20\%$ (includes R221); mfr 28480, P/N 2100-2076.
R219 R220 R221	Not Used. NOT SEPARATELY REPLACEABLE - Part of R218.
R300 R333 R334	Not Used. Not Used. RESISTOR, VARIABLE, WIRE WOUND: 5k ohms $\pm 10\%$ 2W; mfr 28480, P/N 2100-1903.
R335 to R343 R344	Not Used. RESISTOR, VARIABLE, COMPOSITION: 5 megohms $\pm 10\%$ 1/2W; mfr 28480, P/N 2100-1906.
R345 R346 R347	Not Used. RESISTOR: MIL type RC07GF104J. RESISTOR, VARIABLE, COMPOSITION: 50k ohms $\pm 20\%$ 1/2W; mfr 28480, P/N 2100-1905.
R348 R349	Not Used. Not Used.
R350	RESISTOR, VARIABLE, WIRE WOUND: 100 ohms $\pm 10\%$ 2W; mfr 28480, P/N 2100-1901.
S100 S101 S102	Not Used. SWITCH, ROTARY: Mfr 28480, P/N 3100-1344 (Includes R211). SWITCH, PUSHBUTTON: DPDT; mfr 82389, P/N 12S1-032.
S200 S201 S202 S203	Not Used. SWITCH, SLIDE: DPDT, 1/2 amp, 12 Vac; mfr 79727, P/N G126. Not Used. SWITCH, ROTARY: 3-position; mfr 28480, P/N 3100-1345.

Table 6-3. Option 21 Replaceable Parts (Cont'd)

REF DESIG	DESCRIPTION
S400 S401	Not Used. SWITCH, TOGGLE: DPDT, 5 amp 115 Vac; mfr 09353, P/N 7201-WHT-GW.
S402	SWITCH, SLIDE: DPDT, VOLTS AC; mfr 82389, P/N 11A-1037.
T400 T401	Not Used. TRANSFORMER, Power: 50/1000 Hz at 115/230 Vac input, 108.2/106/23.3/18.8/9.4/6 9/4.9 Vac output, solder type terminals; mfr 28480, P/N 9100-1129
V300 to V302 V303	Not Used.
W400 W401	TUBE, CATHODE RAY; Mfr 28480, P/N 5083-9083.
XF400 XF401 XF402	Not Used. CABLE, POWER: 98-1/2 in. long; mfr 28480, P/N 00180-61674 (Includes P401).
XV300 to XV302 XV303	Not Used. POST, FUSE: Mfr 75915, P/N 342014. POST, FUSE: Same as XF401.
	Not Used. SOCKET, CRT: Mfr 72825, P/N 9709-4.

Table 6-4. List of Manufacturers

MFR CODE	NAME	ADDRESS	
00213	Sage Electronic Corp.	Rochester, N. Y.	14610
00853	Sangamo Electric Co., Pickens Div	Pickens, S.C.	29671
01121	Allen Bradley Co.	Milwaukee, Wis.	53204
01281	TRW Semiconductors, Inc.	Lawndale, Calif.	90260
01295	Texas Instruments, Inc., Transistor Products Div.	Dallas, Texas	75231
02114	Ferroxcube Corp. of America	Saugerties, N. Y.	12477
02660	Amphenol Corp.	Broadview, Ill.	60153
03877	Transitron Electronic Corp.	Wakefield, Mass.	01880
03888	Pyrofilm Resistor Co., Inc.	Cedar Knolls, N. J.	07927
04713	Motorola, Semiconductor Products, Inc.	Phoenix, Arizona	85008
05397	Union Carbide Corp, Linde Division	Cleveland, Ohio	45246
06090	Raychem Corp.	Redwood City, Calif.	94063
07263	Fairchild Camera & Inst. Corp., Semiconductor Div.	Mountain View, Calif.	94040
07700	Technical Wire Products	Cranford, N. J.	07016
08717	Sloan Company	Sun Valley, Calif.	91353
09353	C & K Components, Inc.	Newton, Mass.	02158
14655	Cornell-Dubilier Electric Corp.	Newark, N. J.	07100
14674	Corning Glass Works	Corning, N. Y.	16701
14830	Micro State Electronic Corp.	Murray Hill, N. J.	07971
19701	Electra Mfg. Co.	Independence, Kansas	67301
24455	General Electric, Lamp Div.	Nela Park, Cleveland, Ohio	44112
28480	Hewlett-Packard Co.	Palo Alto, Calif.	94304
56289	Sprague Electric Co.	North Adams, Mass.	01247
71400	Bussmann Mfg. Division of McGraw-Edison Co.	St. Louis, Mo.	63107
71590	Centralab, Div. of Globe Union, Inc.	Milwaukee, Wis.	52300
71707	Coil Coil Co., Inc.	Providence, R. I.	02905
71785	Cinch Mfg. Co., Howard B. Jones Div.	Chicago, Ill.	60624
72825	Eby, Hugh H., Inc.	Philadelphia, Pa.	19100
72912	Erie Technological Products, Inc.	Erie, Pa.	16512
73133	Beckman Instruments, Inc., Helipot Div.	Fullerton, Calif.	92634
74276	Signalite, Inc.	Neptune, N. J.	07753
75042	IRC, Inc.	Philadelphia, Pa.	19108
75915	Littlefuse, Inc.	Des Plaines, Ill.	60016
79727	Continental-Wirt Electronics Corp.	Philadelphia, Pa.	19100
80294	Bourns, Inc.	Riverside, Calif.	92506
81073	Grayhill, Inc.	LaGrange, Ill.	60525
82142	Jeffers Electronics Div. of Speer Carbon Co.	DuBois, Pa.	15801
82389	Switchcraft, Inc.	Chicago, Ill.	60630
83330	Smith, Herman H., Inc.	Brooklyn, N. Y.	11207
95265	National Coil Company	Sheridan, Wyo.	82801
95348	Gordos Corp.	Bloomfield, N. J.	07003
95712	Dage Electric Co., Inc.	Franklin, Ind.	46131
98291	Sealectro Corp.	Mamaroneck, N. Y.	10544
99800	Delevan Electronics Corp.	East Aurora, N. Y.	14052
99848	Wilco Corp.	Indianapolis, Ind.	46222

**BACK DATING
MANUAL
CHANGES**

SECTION VII

MANUAL CHANGES AND OPTIONS

7-1. MANUAL CHANGES.

7-2. This manual applies directly to the Model 180F Oscilloscope (as manufactured) with serials prefixed 901-. The following paragraphs explain how to adapt this manual to apply to later instruments (higher serial prefix), or earlier instruments (lower serial prefix). Technical corrections to this manual (if any) are called Errata and are listed on the separate MANUAL CHANGES sheet supplied with this manual.

7-3. **LATER INSTRUMENTS.** If the serial prefix of your Model 180F is above 901-, refer to the separate MANUAL CHANGES sheet supplied with this manual. Locate the serial prefix of your instrument and make the indicated changes.

7-4. **EARLIER INSTRUMENTS.** If the serial prefix of your Model 180F is below 901-, refer to Table 7-1 for the changes necessary to adapt this manual to your particular instrument. Locate the serial prefix of your instrument in the table and make the indicated changes.

7-5. OPTIONS.

7-6. Options are standard modifications performed on HP instruments at the factory. There are two options available for the Model 180F.

7-7. **OPTION 20.** This instrument is identical to the Model 180F with the assigned nomenclature

Table 7-1. Manual Changes

Serial Prefix	Changes Required
No backdating changes required at this time.	

(AN/USM-281A) on the front divider, and a Navy serial tag on the cover. When using an OPTION 20 instrument use the Technical Manuals prepared for that instrument (NAVSHIPS 0969-125-0110 and 0969-125-0120).

7-8. **OPTION 21.** This instrument is identical to the Model 180F with Navy nomenclature (OS-189A(P)/USM-281) on the front panel. In all other respects the OPTION 21 instrument is identical to the Model 180F and the information in this Operating and Service Manual applies. The replaceable parts for the Model 180F Option 21 are listed in Table 6-3.

7-9. SPECIAL INSTRUMENTS.

7-10. "Specials" are standard HP instruments that are modified at the factory according to customer specifications. A separate insert sheet is included with the manual for special instruments having electrical changes. Make the changes specified in addition to any other changes that are necessary per the MANUAL CHANGES sheet.

SCHEMATIC

DIAGRAMS

TROUBLE-

SHOOTING

SECTION VIII

SCHEMATICS AND TROUBLESHOOTING

8-1. INTRODUCTION.

8-2. This section provides schematic diagrams, component identification, and troubleshooting and repair information for the Model 180F.

8-3. SCHEMATIC DIAGRAMS.

8-4. Schematic diagrams appear on right hand pages that unfold outside the right edge of the manual. These "throw-clear" pages allow viewing the schematics while referring to other sections.

8-5. Schematics are drawn primarily to show electronic function. A given schematic may include all or part of several assemblies. Information about symbols and conventions used in the schematics is provided by Table 8-1. Schematics also provide dc voltages and waveform test points. DC voltage measurement conditions, waveform measurement conditions, and waveform applicable to each schematic are shown next to that schematic.

8-6. COMPONENT IDENTIFICATION.

8-7. Whenever possible, components appearing on a schematic are identified on the page opposite that schematic. When components on a given assembly appear on more than one schematic, all components on that assembly are identified opposite the first schematic showing that assembly. Adjustments, assemblies, and chassis mounted electrical components are identified in Figure 8-1. Mechanical components are identified in Figure 6-1.

8-8. TROUBLESHOOTING.

8-9. The first and most important prerequisite for successful troubleshooting is a through understanding of instrument operation and function. Often, suspected malfunctions are caused by improper control settings such as: intensity set too low, display selector or mode switch in wrong position, trigger level maladjusted, etc. Read Section III, Operation, and Section IV, Principles of Operation, for this information.

8-10. DC voltages for most active components (transistors, FET's, etc) are indicated on the schematics. Waveform test points (∇ with an enclosed number) are also placed on the schematic at various points along the main signal path. The numbers inside the test point symbols are keyed to the proper waveform adjacent to the schematic. These voltages and waveforms are invaluable for troubleshooting the instrument. Applications include:

checking stage gain, locating unbalance in differential amplifiers, locating faulty transistors, etc. Always refer to the specific measurement conditions before using dc voltages or waveforms. Allow the level to stabilize before noting dc voltages. Small dots are etched on the circuit board assemblies next to the emitter lead of transistors, the source leads of FET's, the cathode end of diodes, and the positive end of electrolytic capacitors as an aid to locating test points.



When taking waveform or dc voltage measurements, use extreme care to avoid shorting supply voltages or components.

8-11. If a malfunction occurs, Figure 8-2 may help isolate the trouble to a particular circuit in the Model 180F, or to a particular plug-in. Always begin troubleshooting with a visual inspection. Check for burned or loose components, loose wire connections, faulty switch contacts or any similar conditions suggesting a source of trouble.

8-12. REPAIR AND REPLACEMENT.

8-13. Almost all electrical components are accessible for replacement from the component side of the etched circuit boards. Section VI provides a detailed parts list to allow ordering replacement parts from either Hewlett-Packard or a typical manufacturer. If satisfactory operation or repair cannot be accomplished, contact the nearest Hewlett-Packard Sales/Service Office (addresses at rear of this manual). If shipment for repairs is required, see Section II for recommended packaging information.

8-14. HIGH-VOLTAGE SUPPLY REPAIR.

8-15. The following procedure should be used in replacing the high voltage supply assembly (A8), the high voltage rectifier assembly (A5), or the high voltage transformer (T301):

- a. Remove two screws and remove cover.
- b. Remove rear instrument cover and unsolder five wires from small etched circuit board mounted to T301.
- c. Remove four screws from corners of rectifier assembly, A5. Remove two screws from ends of T301.
- d. Unsolder leads at cathode end of CR302 and CR307.

e. Unsolder lead at junction of C309 and R325.

f. Raise the rectifier assembly (including T301) from compartment in the HV supply assembly. T201 should be completely disconnected (small pc board is part of transformer).

WARNING

The post accelerator lead may hold a high-voltage charge. Use a screwdriver and carefully lift the insulator cap. Ground the screwdriver and the post accelerator lead as the lead is loosened and disconnected from the CRT.

8-16. CRT REMOVAL AND REPLACEMENT.

8-17. To remove the CRT, proceed as follows:

WARNING

To prevent possible injury, always wear a face mask or goggles, and gloves. Handle the CRT with extreme care.

- a. Remove the plug-ins.
- b. Remove oscilloscope cover. (See Paragraph 5-15 and Figure 5-1.)

WARNING

The post accelerator lead may hold a high-voltage charge. Use a screwdriver and carefully lift the insulator cap. Ground the screwdriver and the post accelerator lead as the lead is loosened and disconnected from the CRT.

c. Remove post accelerator lead from CRT. The lead is held in place by a spring wire clip. To remove it from the CRT, compress the clip by pressing against one side of the spring wire with the screwdriver blade while gently lifting the same side of the insulator cap.

d. Remove the connections from the nine neck pins on the CRT (use long-nose pliers through access holes in CRT shield).

e. Squeeze plastic light shield at mid-point at top and bottom, and remove it.

f. Remove screws holding metal bezel on front panel.

g. Carefully pry the socket from the CRT base.

h. Place one hand on the CRT face and, with the other hand, slide the CRT forward and out of the instrument.

i. To replace the CRT, reverse the procedure.

j. After replacing the CRT, check the following adjustments: Intensity Limit, Paragraph 5-25; Flood Gun, Paragraph 5-26; Trace Alignment, Paragraph 5-27; and Horizontal Amplifier Gain, Paragraph 5-29, step c.

8-18. SERVICING ETCHED CIRCUIT BOARDS.

8-19. Etched circuit boards in this instrument have components mounted on one side of the board, conductive surfaces on both sides, and plated-through component mounting holes. Hewlett-Packard Service Note M-20E contains useful information on servicing etched circuit boards. Some important considerations are as follows:

a. Use a 37 to 47.5 watt chisel tip soldering iron with a tip diameter of 1/16 to 1/8 inch, and a small diameter rosin core solder.

b. Components may be removed by placing the soldering iron on the component leads on either side of the board and pulling the component straight away from the board. If heat is applied to the component side of the board, greater care is required to avoid damage to the components, especially semi-conductors. Heat damage may be minimized by gripping the lead with long nose pliers between the soldering iron and the component, thereby forming a heat sink.

c. If a component is obviously damaged or faulty, clip the leads close to the component and then unsolder the leads from the board.

d. Large components, such as potentiometers, may be removed by rotating the soldering iron from lead to lead and applying steady pressure to lift the part free. The alternative is to clip the leads of the damaged part and remove them individually.

e. Excessive heat or force will destroy the laminate bond between the metal plated surface (conductor) and the board. If this problem should occur, the lifted conductor may be cemented down with a small amount of quick-drying acetate-base cement having good insulating properties. Another method of repair is to solder a section of good conducting wire along the damaged area.

f. Before replacing a component, heat the remaining solder in the component hole and clean it out with a toothpick or "solder sucker". Sharp pointed metallic tools are not recommended since they may loosen eyelets in boards or remove plating from the inside of holes on plated-through etched circuit boards.

g. Tin and shape replacement component leads to fit existing holes.















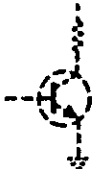

h. Install the replacement component in the same position as the original.

8-20. Component boards used in this instrument have been treated with a special coating for improved performance under extreme moisture conditions. Component replacement should be followed by complete

removal of any fluxing material and renewal of the protective treatment. Spray, brush or dip repaired boards with General Electric Co. DRI-FILM 88. Allow to dry thoroughly before using the instrument.

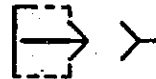
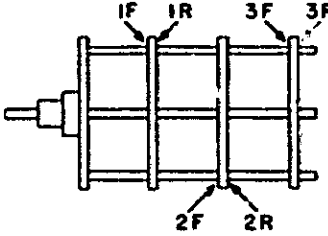
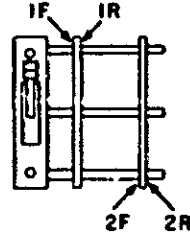
Table 8-1. Schematic Diagram Notes

Refer to MIL-STD-15-1A for schematic symbols not listed in this table.

	= Etched circuit board		= Field effect transistor (N-channel)
	= Front panel marking		= Breakdown diode
	= Rear panel marking		= Tunnel diode
	= Front panel control		= Step recovery diode
	= Screwdriver adjustment		= Circuits or components drawn with dashed lines (phantom) show function only and are not intended to be complete. The circuit or component is shown in detail on another schematic.
P/O	= Part of	Unless otherwise indicated: resistance in ohms capacitance in picofarads inductance in microhenries	
CW	= Clockwise end of variable resistor		
N C	= No connection	Wire colors are given by numbers in parentheses using the resistor color code [(925) is wht-red-grn]. 0 - Black 5 - Green 1 - Brown 6 - Blue 2 - Red 7 - Violet 3 - Orange 8 - Gray 4 - Yellow 9 - White	
	= Waveform test point (with number)		
	= Common electrical point (with letter) not necessarily ground	Switch wafers are identified as follows:	
	= Single pin connector on board		
	= Pin of a plug-in board (with letter or number)		
	= Main signal path		
	= Primary feedback path		
	= Secondary feedback path		
*	= Optimum value selected at factory, average value shown; part may have been omitted.		

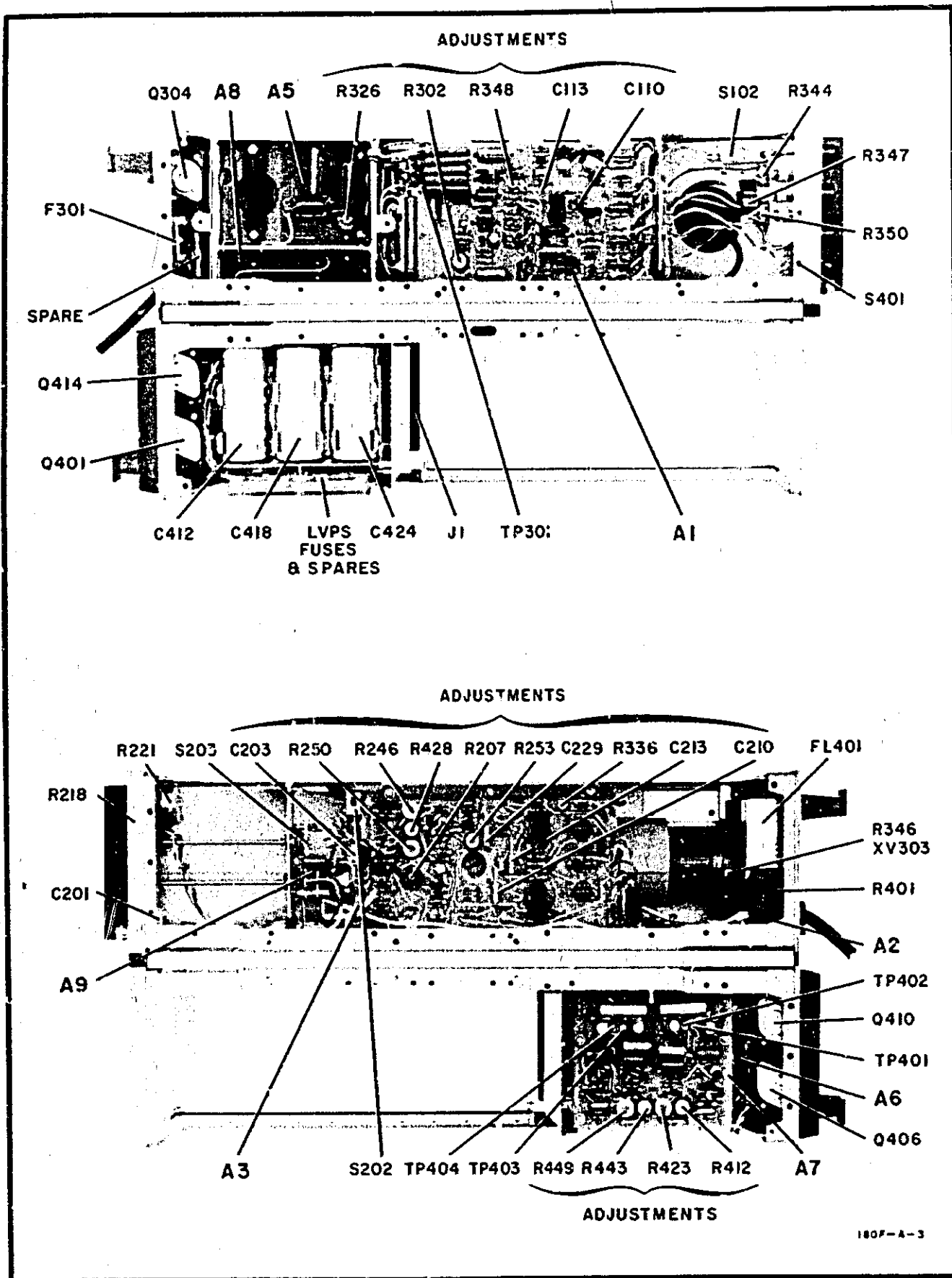

Figure 8-1. Component Identification

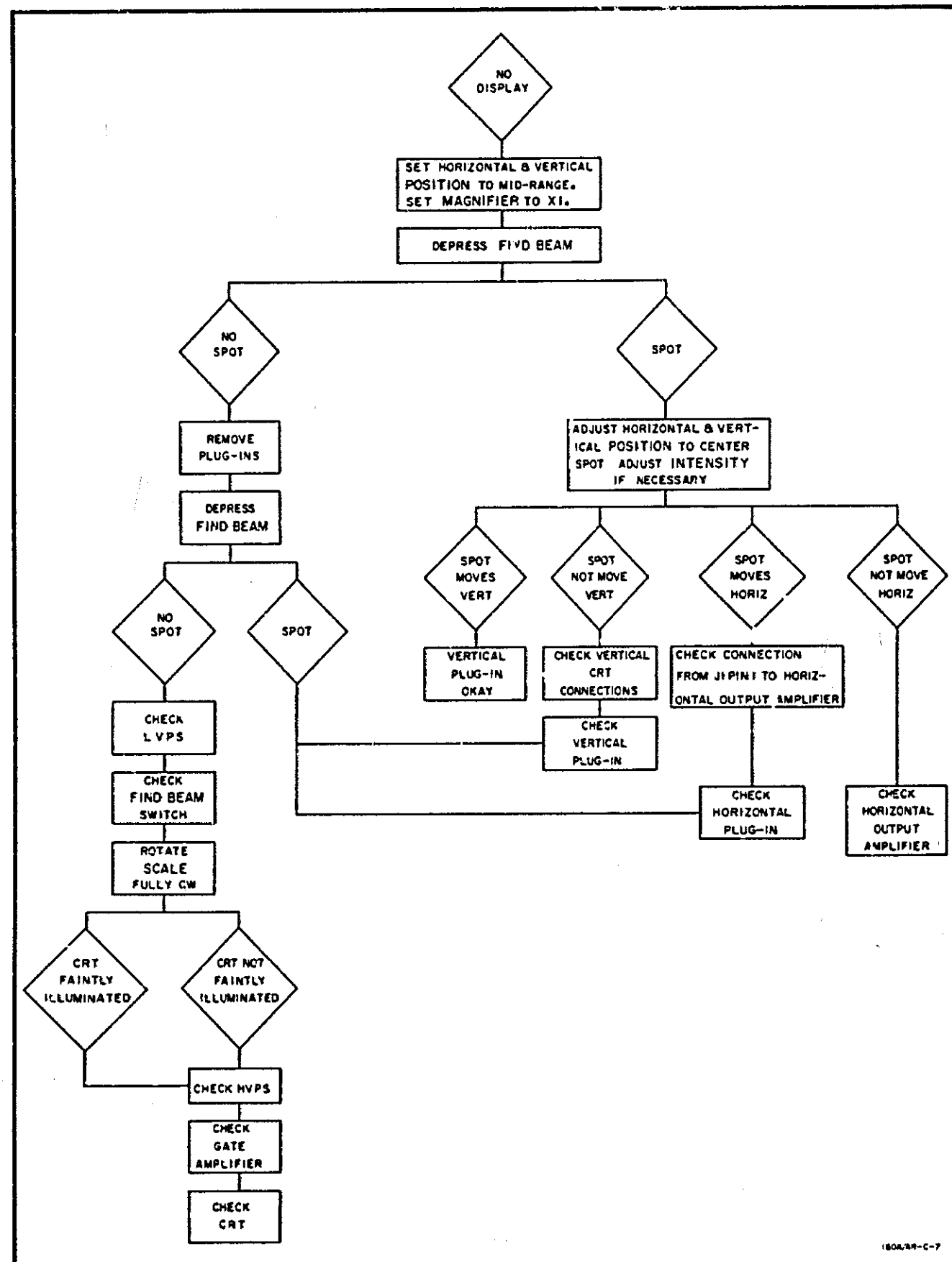

Figure 8-2. Over-all Troubleshooting Tree

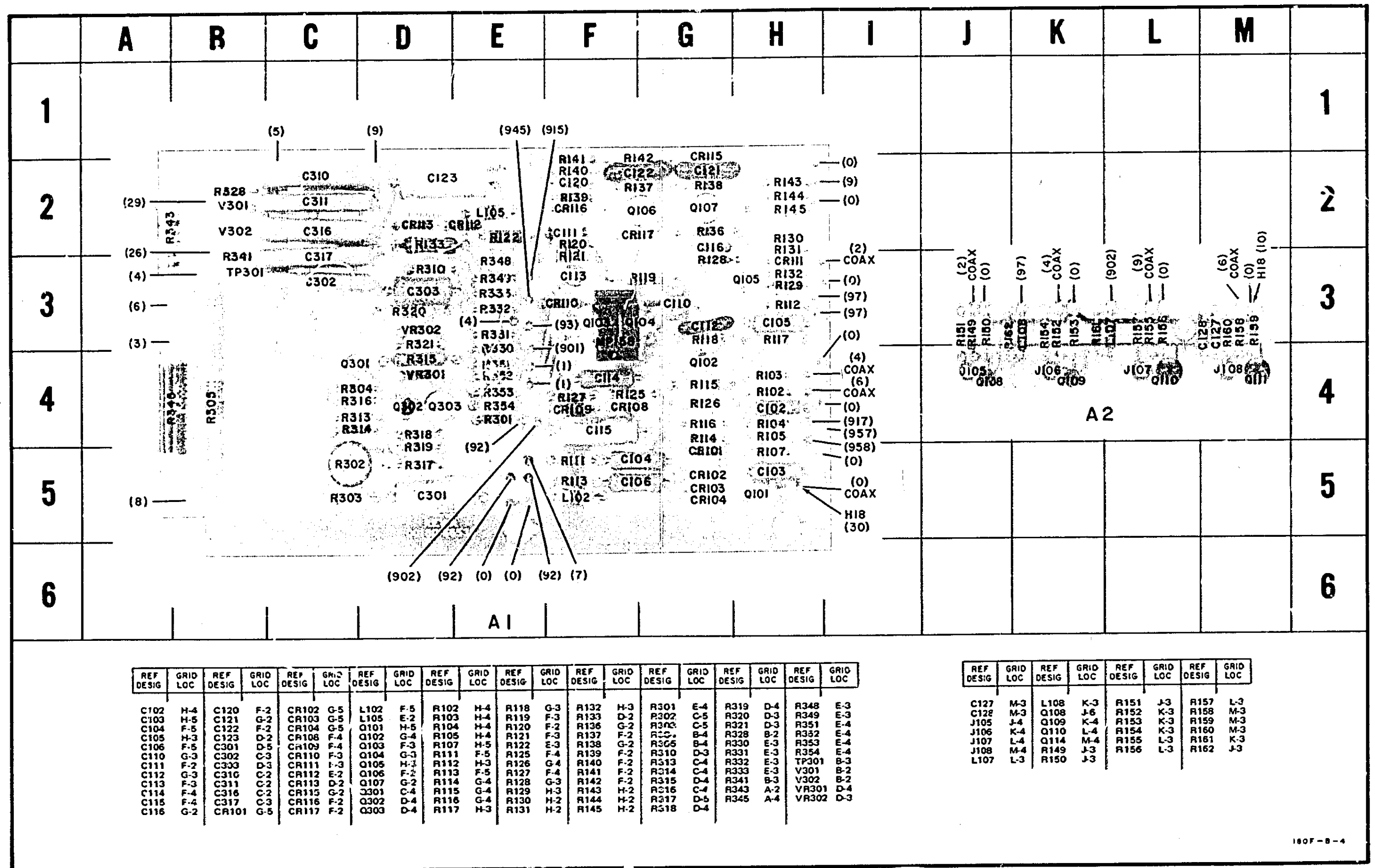

Figure 8-3. Component Identification, A1 and A2

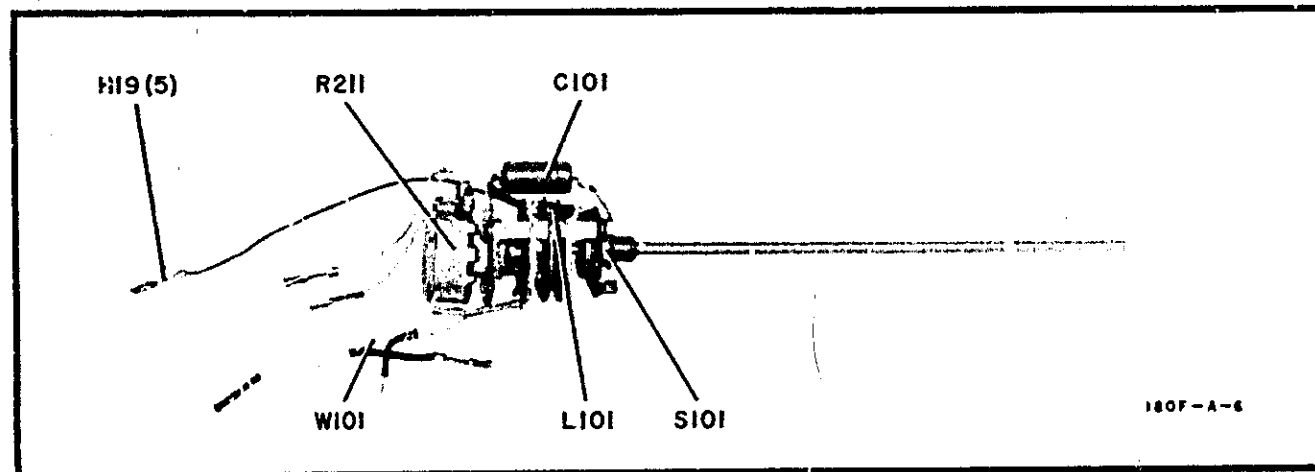

Figure 8-4. Component Identification, A9

DC VOLTAGE MEASUREMENT CONDITIONS

- Set HORIZONTAL DISPLAY to EXT CAL.
- Set Vertical Display to A.
- Adjust INTENSITY for +57 Vdc on collectors of Q103 and Q104.

WAVEFORM MEASUREMENT CONDITIONS

- Set HORIZONTAL DISPLAY to EXT CAL.
- Set Vertical Display to A.
- Rotate HORIZONTAL POSITION fully cw to move spot off screen.
- Adjust INTENSITY for +30 Vdc on collector of Q103.
- Connect a 100 kHz, 5 V pk-pk, negative, square wave with a risetime of less than 30 nsec to Z-axis Input.

WAVEFORMS ARE TIME RELATED

1 5V/DIV 2USEC/DIV

2 1V/DIV 2USEC/DIV

Figure 8-5. Waveforms and Measurement Conditions

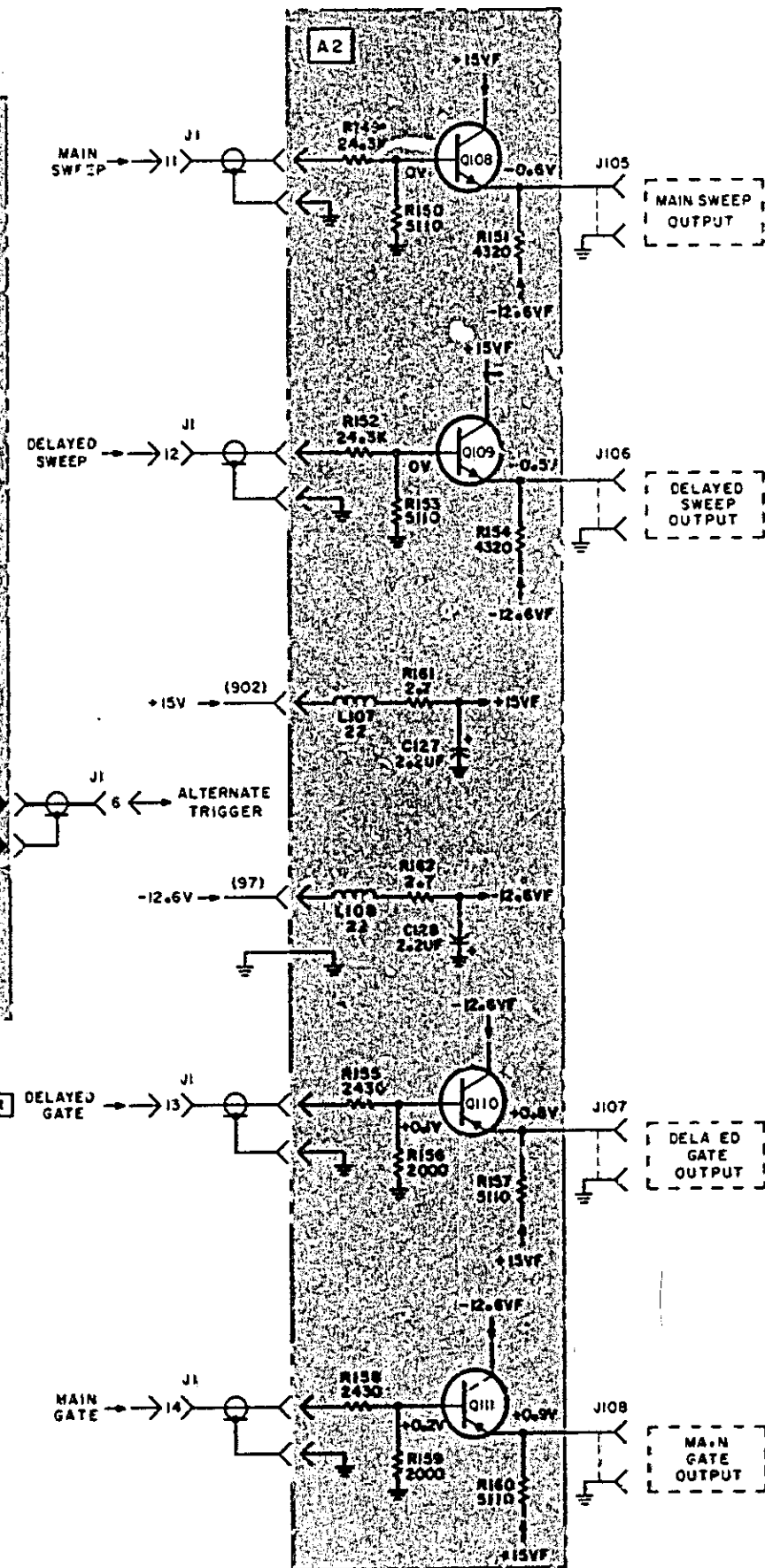
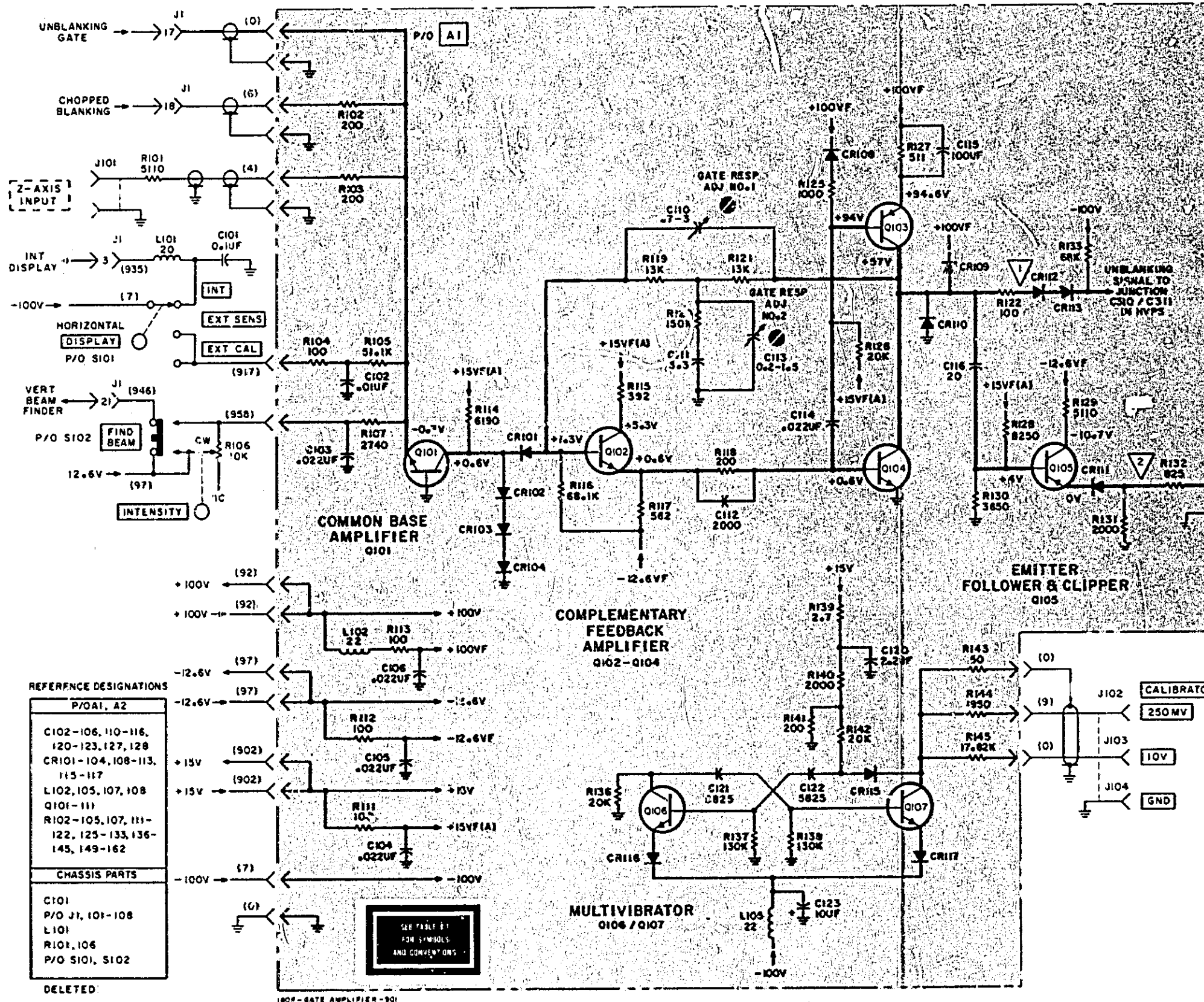

Figure 8-6. Gate Amplifier

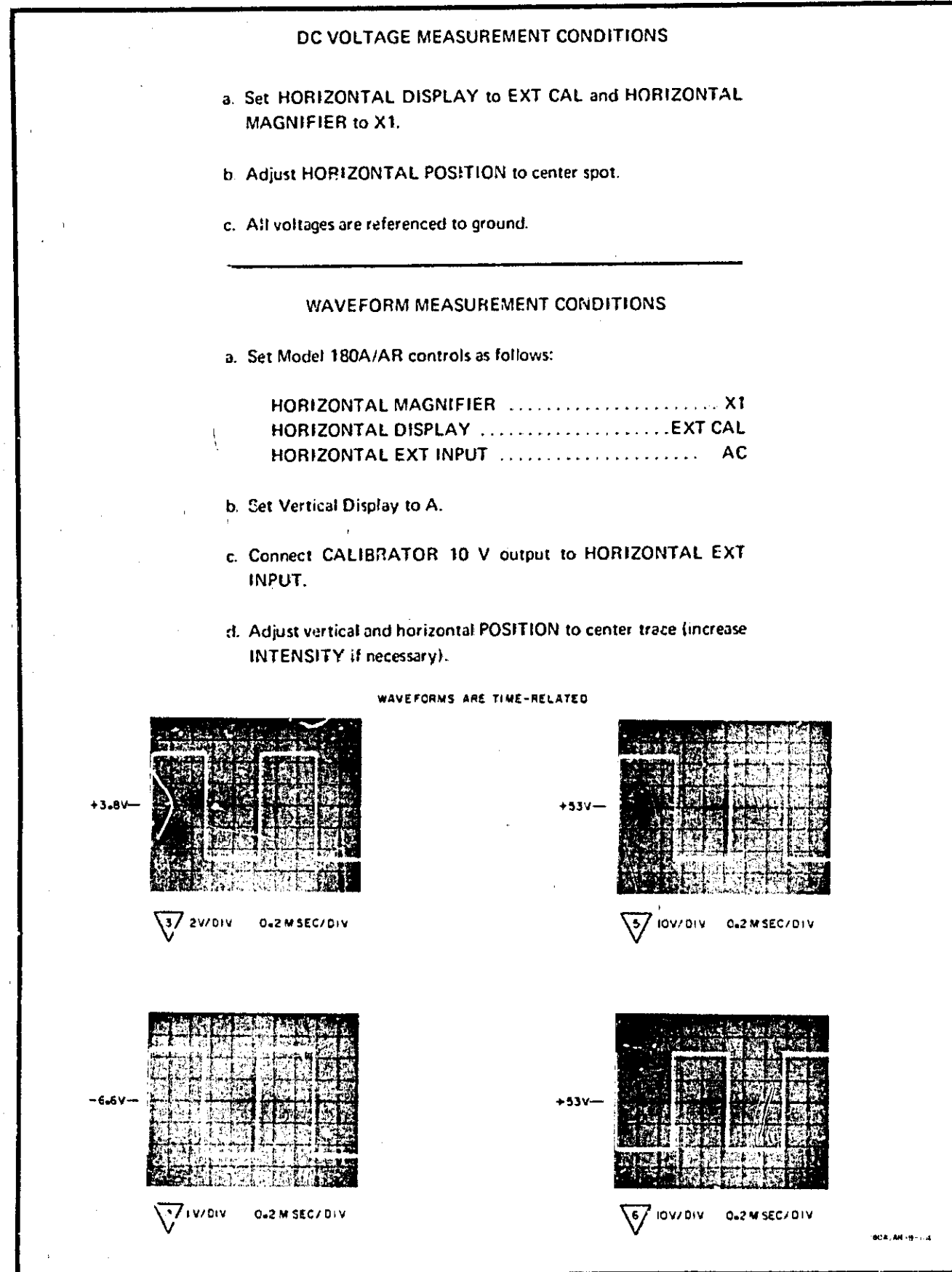

Figure 8-8. Waveform and Measurement Conditions

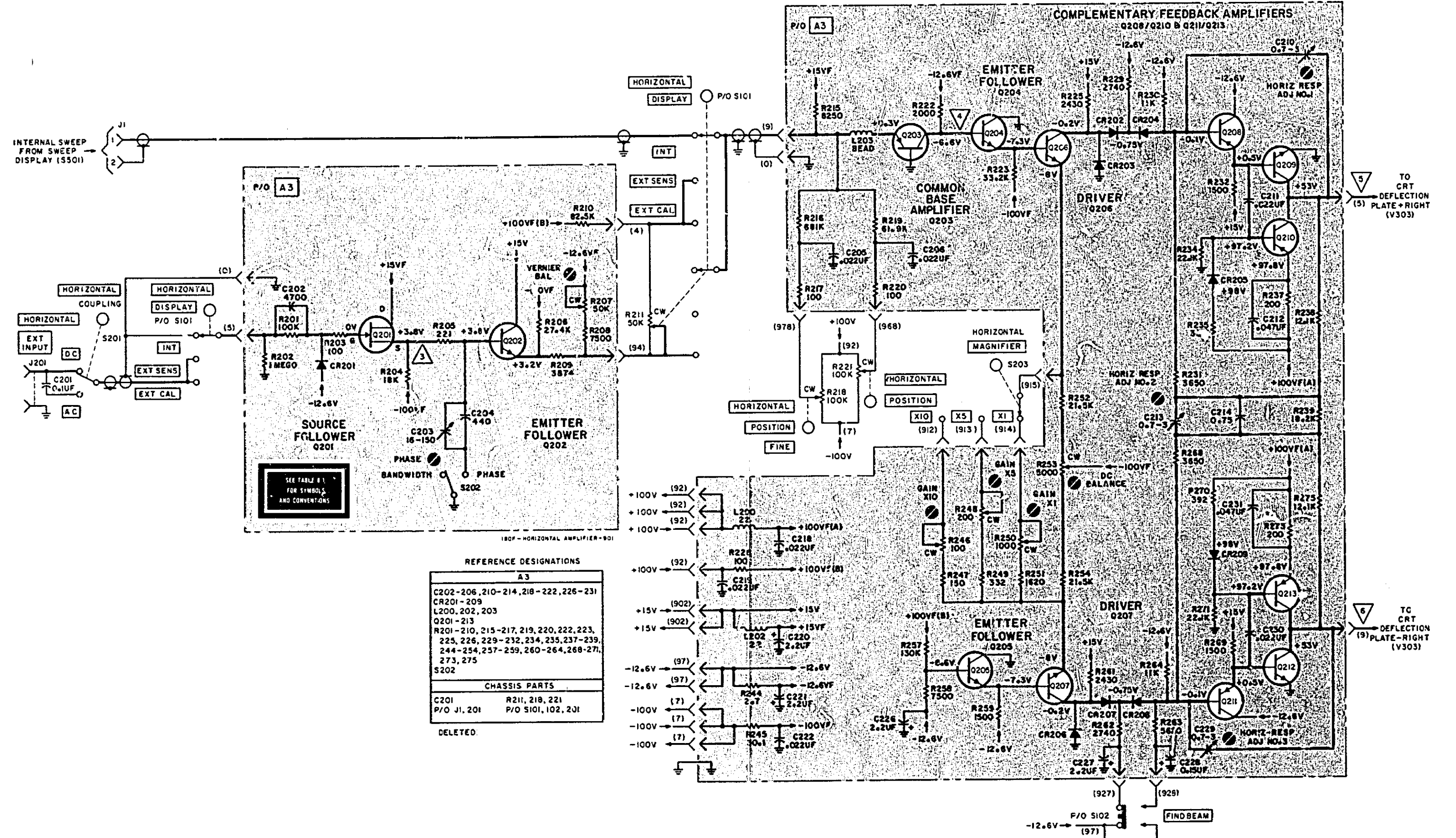

Figure 8-9. Horizontal Amplifier

See Figure 8-3 for A1 Component Identification

See Figure 8-7 for A3 Component Identification

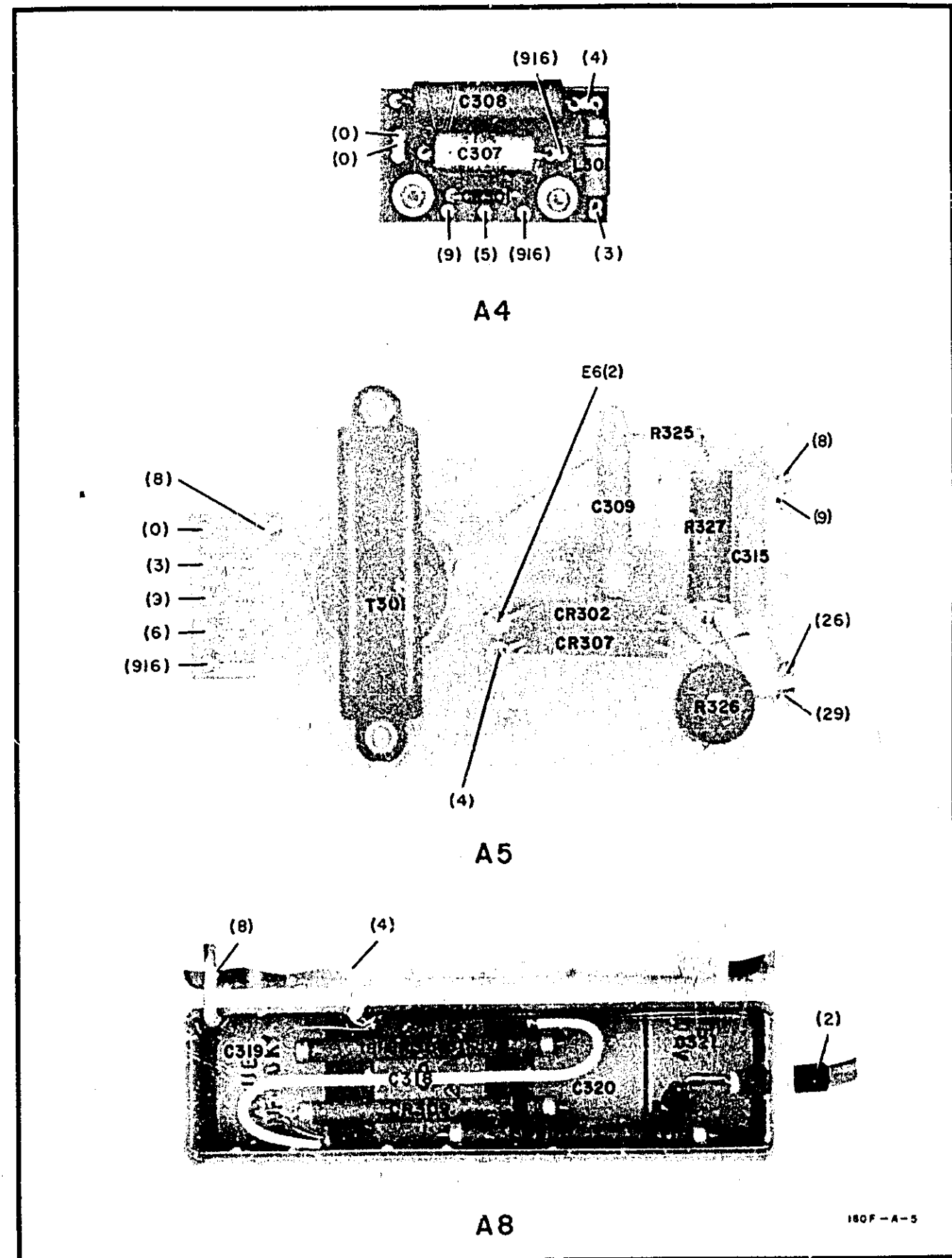

Figure 8-10. Component Identification, A4, A5 and A8

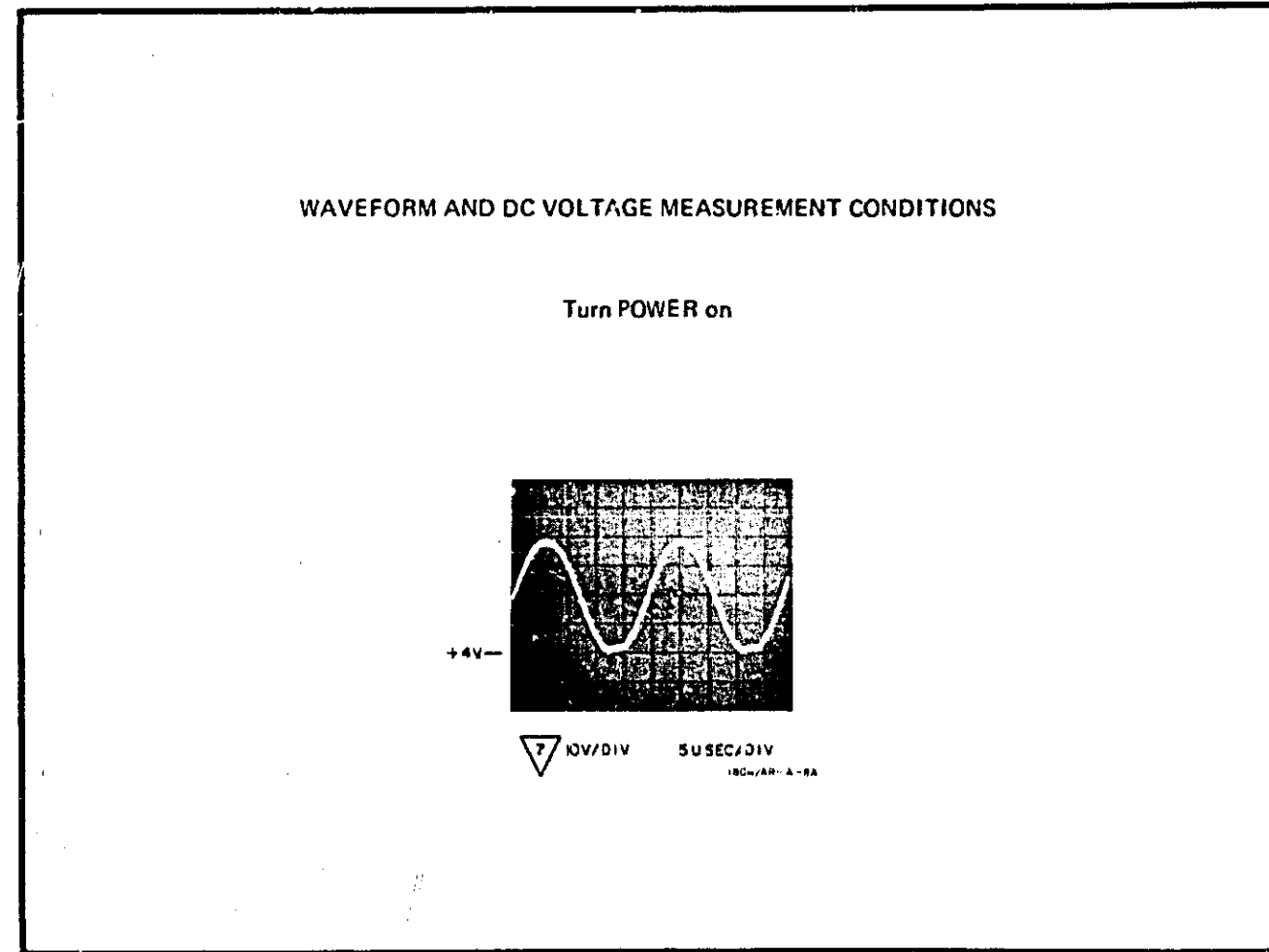

Figure 8-11. Waveform and Measurement Conditions

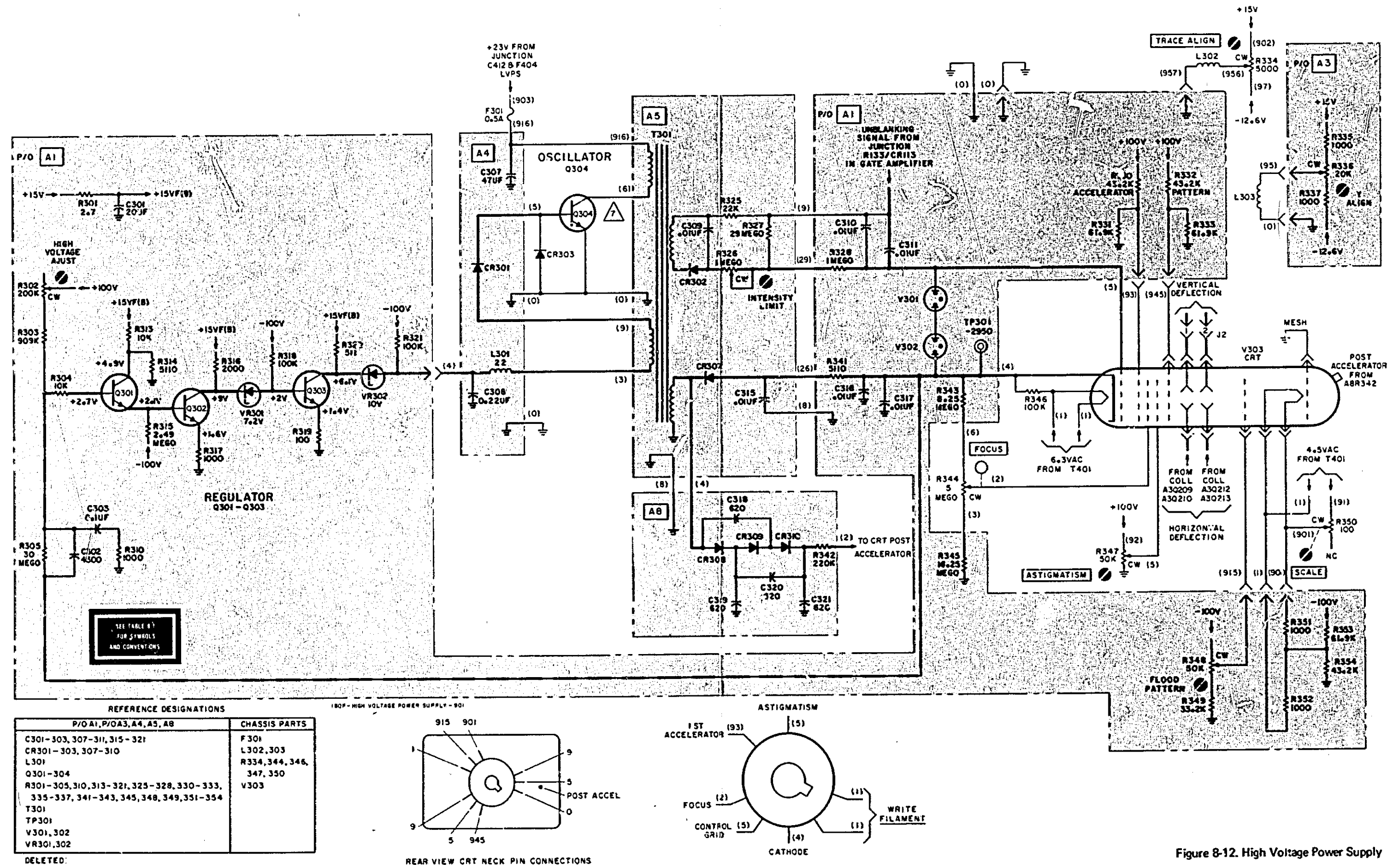
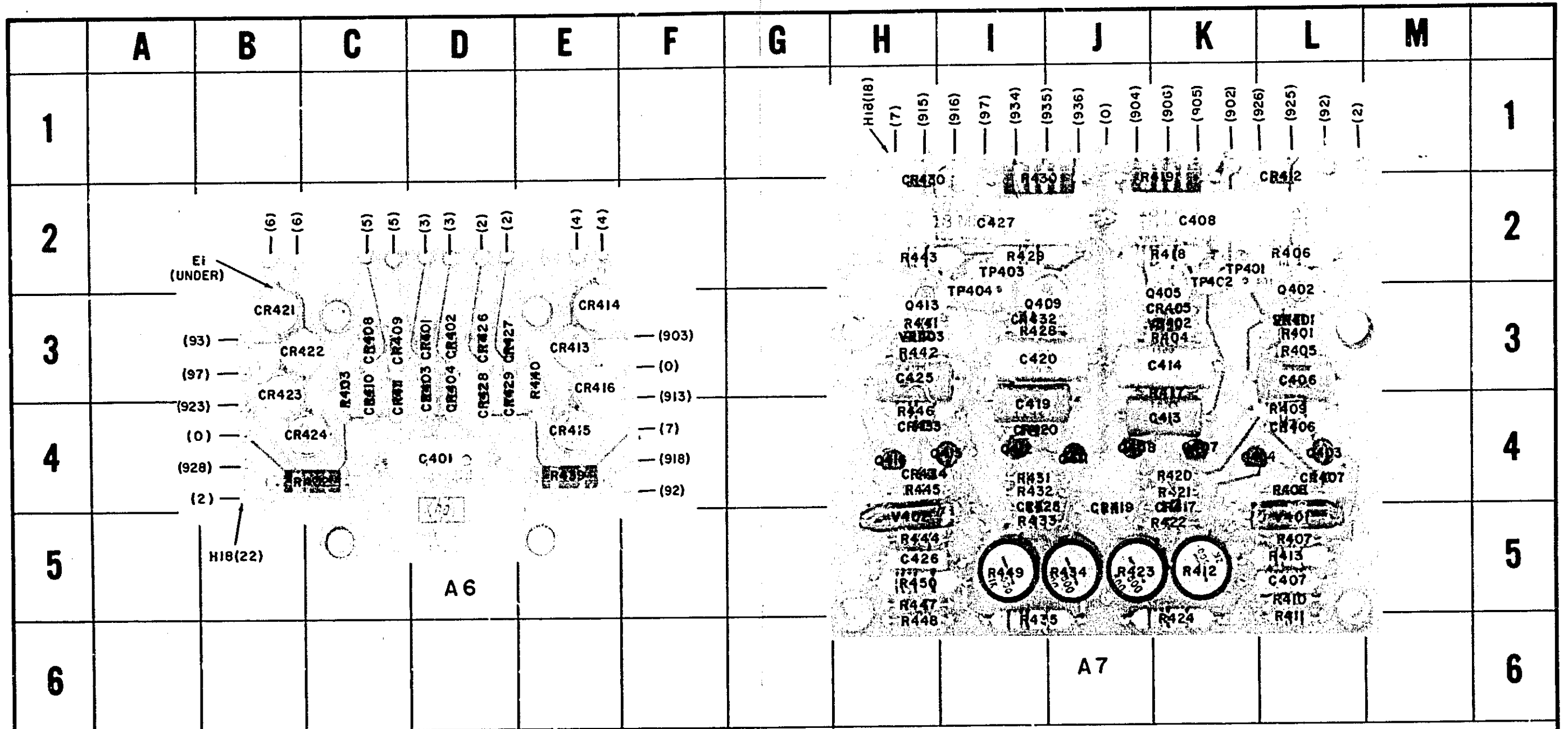

Figure 8-12. High Voltage Power Supply



REF DESIG	GRID LOC	REF DESIG	GRID LOC	REF DESIG	GRID LOC
C401	D-4	CR411	C-4	CR424	B-4
CR401	D-3	CR413	E-3	CR426	D-3
CR402	D-3	CR414	E-3	CR427	D-3
CR403	D-4	CR415	E-4	CR428	D-4
CR404	D-4	CR416	E-3	CR429	D-4
CR408	C-3	CR421	B-3	R402	B-4
CR409	C-3	CR422	B-3	R403	C-4
CR410	C-4	CR423	B-3	R439	E-4
				R440	E-4

REF DESIG	GRID LOC	REF DESIG	GRID LOC	REF DESIG	GRID LOC	REF DESIG	GRID LOC	REF DESIG	GRID LOC	REF DESIG	GRID LOC	REF DESIG	GRID LOC	REF DESIG	GRID LOC
C406	L-3	CR405	K-3	CR433	H-4	Q412	I-4	R409	L-4	R422	K-5	R435	I-5	R450	H-5
C407	L-5	CR406	L-4	CR434	H-4	Q413	H-3	R410	L-5	R423	J-5	R441	H-3	TP401	K-2
C408	K-2	CR407	L-4	Q402	L-3	Q415	H-4	R411	L-6	R424	K-5	R442	H-3	TP402	K-2
C413	K-4	CR412	L-2	Q403	L-4	Q416	H-4	R412	K-5	R428	I-3	R443	H-2	TP403	I-2
C414	K-3	CR417	K-5	Q404	K-4	R401	L-3	R413	L-5	R429	I-2	R444	H-5	TP404	I-3
C419	I-4	CR419	J-4	Q405	K-3	R404	K-3	R417	K-3	R430	I-2	R445	H-4	V401	L-5
C420	I-3	CR420	I-4	Q407	K-4	R405	L-3	R418	K-2	R431	I-4	R446	H-4	V402	H-5
C425	H-3	CR425	I-4	Q408	J-4	R406	L-2	R419	J-2	R432	I-4	R447	H-5	VR401	L-3
C426	H-5	CR430	H-2	Q409	I-3	R407	L-5	R420	K-4	R433	I-5	R448	H-6	VR402	K-3
C427	I-2	CR432	I-3	Q411	J-4	R408	L-4	R421	K-4	R434	J-5	R449	I-5	VR403	H-3

Figure 8-13. Component Identification, A6 and A7

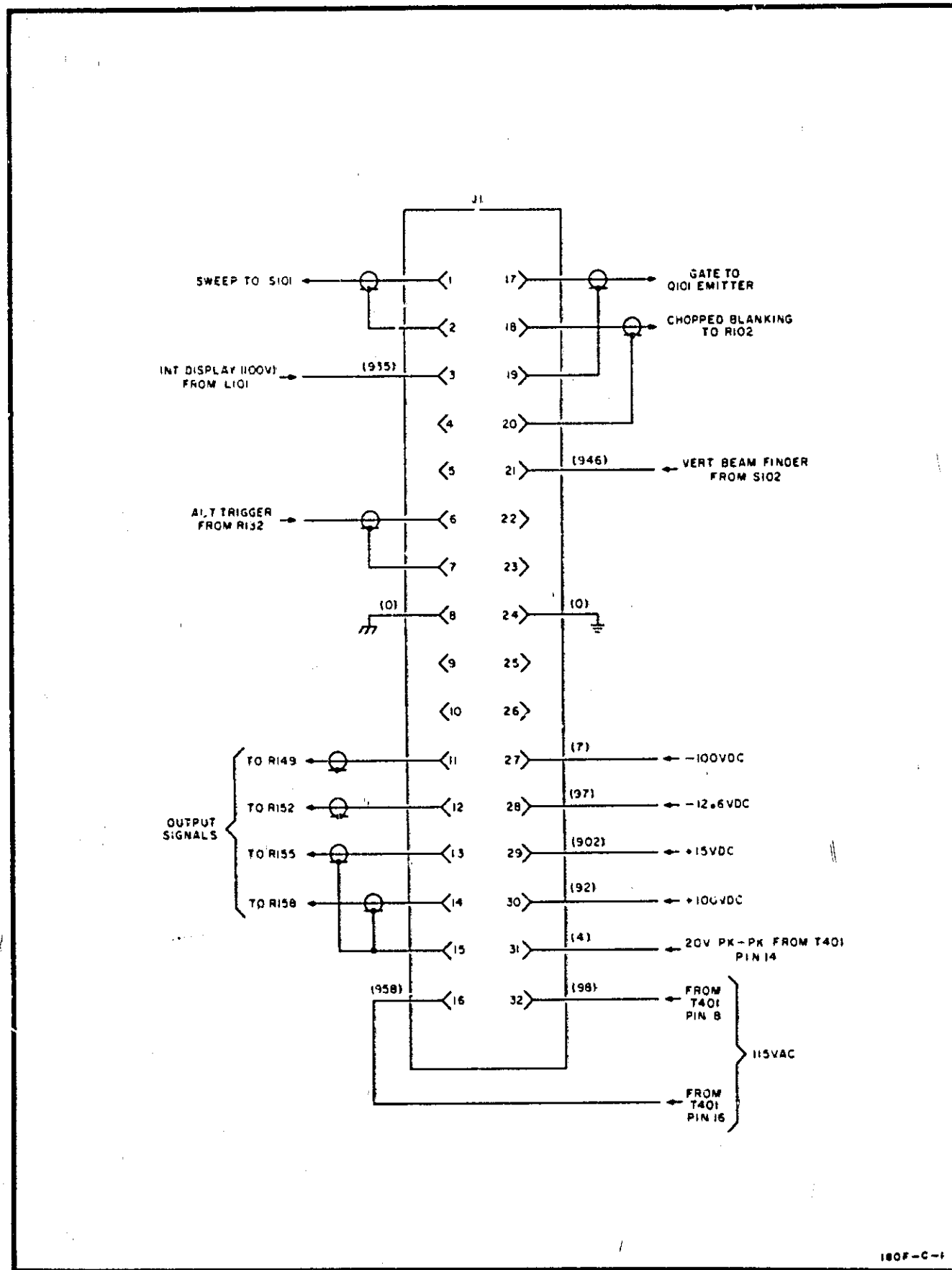

Figure 8-14. Jack Connections

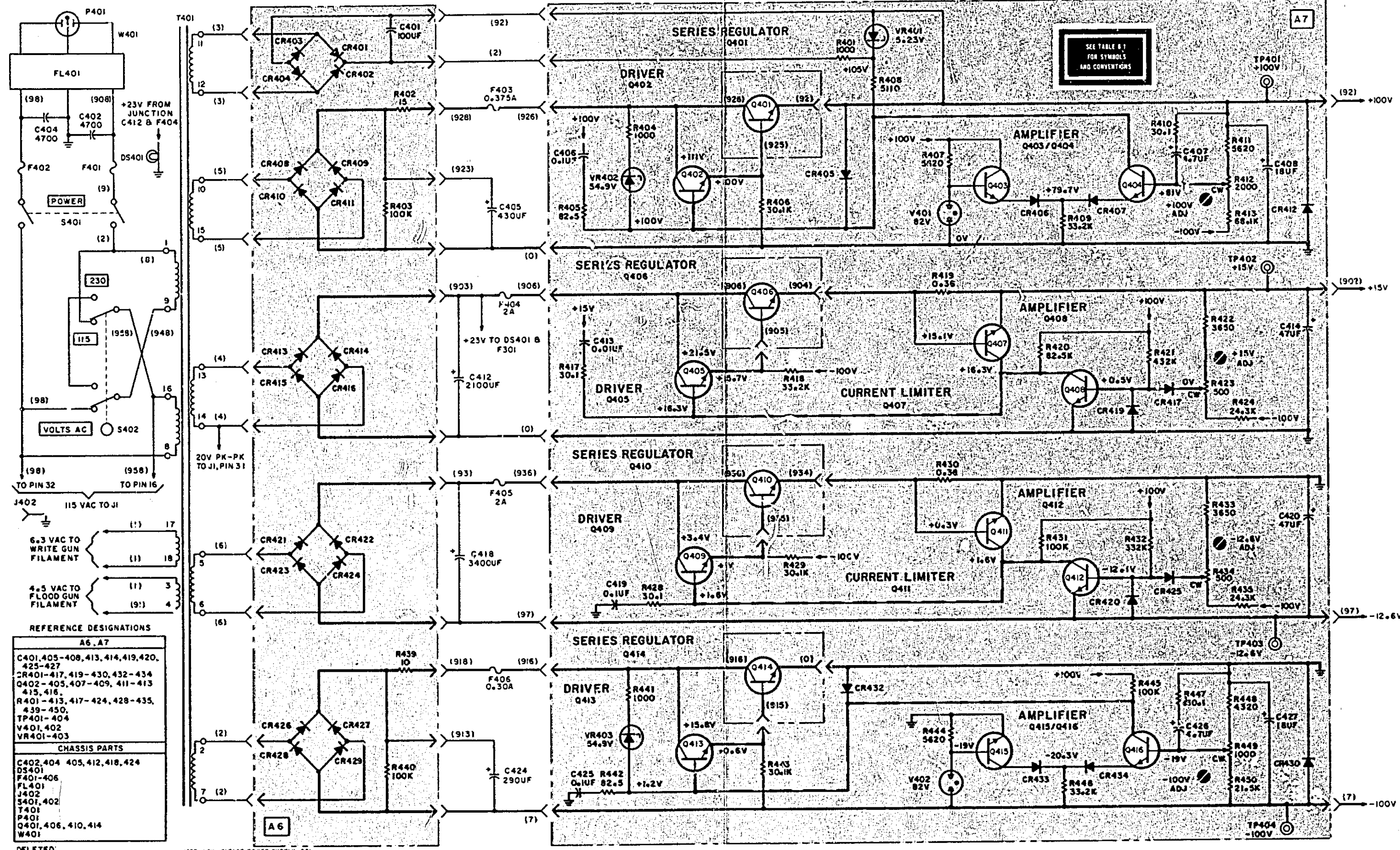

Figure 8-15. Low Voltage Power Supply



CATHODE-RAY TUBE WARRANTY

The cathode-ray tube (CRT) supplied in your Hewlett-Packard Oscilloscope and replacement CRT's purchased from hp are warranted by the Hewlett-Packard Company against electrical failure for a period of one year from the date of sale. Broken tubes and tubes with phosphor or mesh burns are not included under this warranty. If the CRT is broken when received, a claim should be made with the responsible carrier.

Your nearest Hewlett-Packard Sales/Service Office (listed at rear of instrument manual) maintains a stock of replacement tubes and will assist in processing the warranty claim.

We would like to evaluate every defective CRT. This engineering evaluation helps us to provide a better product for you. Please fill out the CRT Failure Report on the reverse side of this sheet and return it with the defective CRT to:

Hewlett-Packard Company
1900 Garden of the Gods Road
Colorado Springs, Colorado 80907

Attention: CRT QA

To avoid damage to the tube while in shipment, please follow the shipping instructions below; warranty credit is not allowed on broken tubes.

SHIPPING INSTRUCTIONS

It is preferable that the defective CRT be returned in the replacement CRT carton. If the carton or packaging material is not available, pack the CRT according to the instructions below:

1. Carefully wrap the tube in 1/4 inch thick cotton batting or other soft padding material.
2. Wrap the above in heavy kraft paper.
3. Pack wrapped tube in a rigid container which is at least 4 inches larger than the tube in each dimension.
4. Surround the tube with at least 4 inches of packed excelsior or similar shock absorbing material; be sure the packing is tight all around the tube.

Thank you,

CRT Department



CATHODE-RAY TUBE FAILURE REPORT

DATE _____

FROM:

NAME _____

COMPANY _____

ADDRESS _____

1. hp INSTRUMENT MODEL NO. _____

2. hp INSTRUMENT SERIAL NO. _____

3. CRT SERIAL NO. _____

4. Please describe the failure and, if possible, show the trouble on the appropriate CRT face below.

CUT ALONG DOTTED LINE

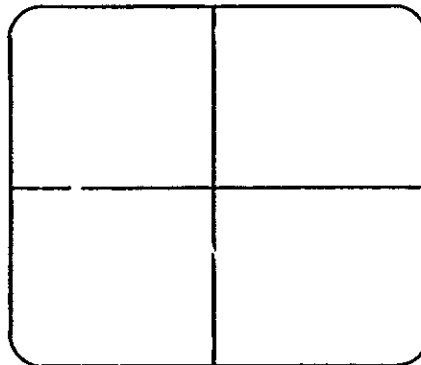
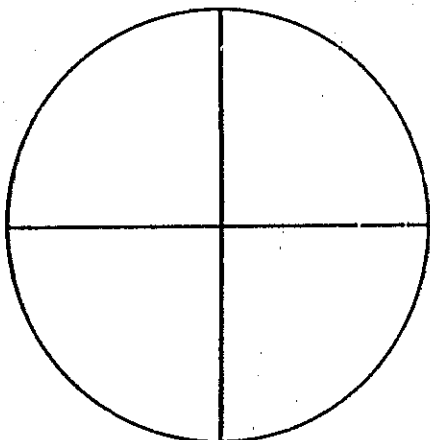

5. Is the CRT within warranty? Yes _____ No _____

6. hp Sales/Service Office _____ Repair Order No. _____

MANUAL CHANGES



MANUAL CHANGES

MODEL 180F

and

OS-189A (P)/USM-281

RUGGEDIZED OSCILLOSCOPE

Manual Serials Prefixed: 901--

Manual Printed: NOV 1969

Make all changes listed below as Errata. Check the following table for your instrument serial prefix and/or serial number and make listed change(s) to the manual:

Serial Prefix or Number	Make Changes	Serial Prefix or Number	Make Changes
1221A	1		
2002A	1, 2		
2119A	1, 2, 3		
2321A	1, 2, 3, 4		

ERRATA

Table 1-1,

Weight: Change to read: 29 lb 8 oz without plug-ins (13,38 kg).

Figure 6-1,

Delete: MP158, MP159 shown in exploded view of case handle assembly.

Table 6-2, Replaceable Parts,

C115: Change HP Part No. to 0160-0303, C: fxd my 0.15 uF 200 wVac.

C121: Change HP Part No. to 0160-2961.

C122: Change HP Part No. to 0160-2961.

C301: Change to HP Part No. 0180-0049, C: fxd elect 20 uF 50 wVdc.

C309: Change HP Part No. to 0160-2320.

C315: Change HP Part No. to 0160-0907.

CR201: Change to HP Part No. 1901-0374, CR: Si (Special).

CR202, 204, 207, 208: Change to HP Part No. 5081-7536.

DS401: Change to HP Part No. 2140-0253, DS: incandescent, 28V.

E1: Change to HP Part No. 0380-0744, Spacer: ceramic.

Add: F401, F402, HP Part No. 2110-0020, F: 0.8A 250V slow-blow (230V operation only).

H18: Change to HP Part No. 0360-1514, Terminal: pin.

J1: Change to HP Part No. 00180-27601, J: female 32-pin modified.

MP130: Change to HP Part No. 0403-0128, Guide: left plug-in.

MP131: Change to HP Part No. 0403-0129, Guide: right plug-in.

MP158: Change to HP Part No. 00180-09103, TQ2, Spring: insert.

R203: Change to HP Part No. 0757-0407, R: fxd metfilm 200 ohms 1% 1/8W.

Table 6-2 (Cont'd),

R253: Change to HP Part No. 2100-1775, R: var ww 5000 ohms 5% 1W.

R305: Change to HP Part No. 0698-8018, R: fxd film 30 megohms 1% 3W.

R316: Listed twice. Correct second appearance to read R326.

R325: Change to HP Part No. 0687-2231, R: fxd comp 22k ohms 10% 1/2W.

R328: Change to HP Part No. 0687-1051, R: fxd comp 1 megohm 10% 1/2W.

R341: Change to HP Part No. 0687-4721, R: fxd comp 4700 ohms 10% 1/2W.

R343: Change to HP Part No. 0698-5356, R: fxd comp 8.25 megohms 5% 1W.

R345: Change to HP Part No. 0698-6580, R: fxd car film 16.25 megohms 5% 1W.

R448: Change to HP Part No. 0757-0435, R: fxd metfilm 3920 ohms 1% 1/8W.

S402: Change HP Part No. to 3101-1234.

V303: Change HP Part No. 5083-9083.

V401, V402: Change HP Part No. to 1940-0025, V: voltage reference 83V.

Add: XDS401, HP Part No. 1450-0359, Lampholder.

Table 6-3,

A1C115: Change description to CAPACITOR, FIXED, MYLAR: 0.15 uF 10% 200 wVdc, Mfr 56289, P/N 192P15492-PTS.

A1R305: Change description to RESISTOR, FIXED, CONDUCTIVE PLASTIC: 30 megohms ± 1% 3W; Mfr 03888, P/N PVC-175-3-TO-3004-F.

A1R328: Change description to RESISTOR, FIXED COMPOSITION: 1 megohm ± 10% 1/2W; Mfr 01121, P/N EB1051.

A1R341: Change description to RESISTOR, FIXED, COMPOSITION: 4700 ohms ± 10% 1/2W; Mfr 01121, P/N EB4721.

8 August 1983

▲ = Latest additions to this change sheet.

This change sheet supersedes all prior change sheets for this manual.

Supplement A for
00180-90910

ERRATA (Cont'd)

Table 6-3 (Cont'd),

- A1R343: Change description to RESISTOR, FIXED, CARBON FILM: 8.25 megohms $\pm 5\%$ 1W; Mfr 28480, P/N 0698-5356.
- A1R345: Change description to RESISTOR, FIXED, CARBON FILM: 16.25 megohms $\pm 5\%$ 1W; Mfr 28480, P/N 0698-6580.
- A3CR202, 204, 207, 208: Change to HP Part No. 5081-7536.
- A3R203: Change description to RESISTOR: Same as A1R102.
- A3R253: Change description to RESISTOR, VARIABLE, WIRE WOUND: 5k ohms $\pm 5\%$ 1W; Mfr 28480, P/N 2100-1775.
- A5C309: Change description to CAPACITOR: Same as A1C311.
- A5C315: Change description to CAPACITOR: Same as A1C310.
- A5R325: Change description to RESISTOR, FIXED, COMPOSITION: 22k ohms $\pm 10\%$ 1/2W; Mfr 01121, P/N EB2231.
- A6E1: Change description to SPACER, CERAMIC: mfr 76854, P/N 15523-001.
- A7R448: Change description to MIL type RN60C3921F.
- A7V401: Change description to TUBE, VOLTAGE REFERENCE: 83 volts; Mfr 74276, P/N Z83R4A.
- DS401: Change description to LIGHT INDICATOR: Mfr 71744, P/N CM6839 (ANSI 6839).
- Add: F401, F402, FUSE, SLOW BLOW: 0.8A 250V; Mfr 75915, P/N 313.800S.
- Add: H18, TERMINAL PIN: SQUARE, Mfr 28480, P/N 0360-1514.
- J1: Change description to CONNECTOR, RECEPTACLE: 32-contact, female modified; Mfr 28480, P/N 00180-27601.
- MP124: Change P/N to 00180-24717.
- MP130: Change description to GUIDE, LEFT PLUG-IN: Mfr 28480, P/N 0403-0128.
- MP131: Change description to GUIDE, RIGHT PLUG-IN: Mfr 28480, P/N 0403-0129.
- MP158: Change description to SPRING, INSERT: two required; Mfr 28480, P/N 00180-09103.
- R101: Change description to RESISTOR: Same as A1R129.
- R108: Change description to RESISTOR: VARIABLE, COMPOSITION: 10k ohms $\pm 20\%$ 1/4W; Mfr 28480, P/N 2100-1904.
- XDS401: Change description to LAMPHOLDER: Mfr 06717, P/N 10251K-G-FB13.
- S402: Change description to SWITCH, SLIDE: DPDT, VOLTS AC; Mfr 82380, P/N 11A-1242A.

Page 8-7, Figure 8-8,

Revise schematic as shown in Figure 1 of this change sheet.

- C115: Change value to 0.15 μ F.
- CR109: Disconnect cathode from +100V and reconnect to emitter of Q103.

Page 8-9, Figure 8-9

R203: Change value to 200 ohms.

Page 8-11, Figure 8-12,

R341: Change value to 4700 ohms.

Page 8-13, Figure 8-15,

Q415: Show emitter on CR433 side.

R448: Change value to 3920 ohms.

V401, V402: Change value to 83V.

Reverse connections of C425 and R442. Ground one end of R442 and connect one end of C425 to junction of VR403 and Q413.

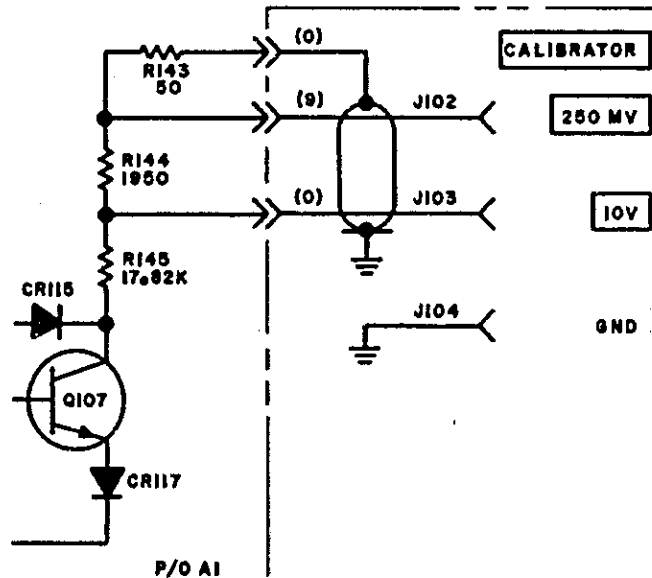

Figure 1

Table 6-2. Replaceable Parts,

- Change: MP155, HP Part No. to 1440-0152.
- Change: Q209, HP Part No. to 1845-0820.
- Change: Q212, HP Part No. to 1845-0820.
- Change: R106, HP Part No. to 2100-3720.
- Change: R302, HP Part No. to 2100-3213.
- Change: R327, HP Part No. to 0698-8427, R.fxd 29M 10% 1W C TC=0 \pm 250.
- Change: R343, HP Part No. to 0698-8994.
- Change: S401, HP Part No. to 3101-1508.
- Delete: XF401.
- Add: XF401A, HP Part No. 2110-0564, FUSE POST.
- Add: XF401B, HP Part No. 2110-0565, FUSE CARRIER.
- Add: XF401C, HP Part No. 2110-0569, NUT PLASTIC.
- Delete: XF402.
- Add: XF402A, HP Part No. 2110-0564, FUSE POST.
- Add: XF402B, HP Part No. 2110-0565, FUSE CARRIER.
- Add: XF402C, HP Part No. 2110-0569, NUT PLASTIC.
- Delete: XF403.
- Add: XF403A, HP Part No. 2110-0564, FUSE POST.
- Add: XF403B, HP Part No. 2110-0565, FUSE CARRIER.

ERRATA (Cont'd)

Table 6-2 (Cont'd).

Add: XF403C, HP Part No. 2110-0569, NUT PLASTIC.
Delete: XF404.
Add: XF404A, HP Part No. 2110-0564, FUSE POST.
Add: XF404B, HP Part No. 2110-0565, FUSE CARRIER.
Add: XF404C, HP Part No. 2110-0569, NUT PLASTIC.

CHANGE 1

Table 6-2. Replaceable Parts.

H1: Change to HP Part No. 00180-24301.
R218: Change to HP Part No. 00180-61501; R: var comp 100k ohms ±20%. (Includes R221 and all mounting parts.)

Table 6-3,

H1: Change description to: NUT, HORIZONTAL POSITION POT: Mfr 28480; P/N 00180-24301.
R218: Change description to: RESISTOR, VARIABLE, COMPOSITION: 100k ohms ±20% (Includes R221 and all mounting parts); Mfr 28480; P/N 00180-61501.

CHANGE 2

Table 6-2. Replaceable Parts,

Change: L303, HP Part No. to 01336-66002.
Change: MP125, HP Part No. to 00180-60603.

CHANGE 3

Page 4-4, Paragraph 4-33,

Change the paragraph to read as follows:

The +100V supply output is used as a reference for the -100V supply and the -100V supply is used as a reference for the +15V and -12.6V supplies. The +100V must be adjusted first, then the -100V, then the +15V and -12.6V supplies.

Page 5-3, Table 5-2 Low Voltage Adjustments,

Change the order of supply adjustment as follows:

Test Point	Measure	Adjust
TP401	+100V ± .1V	R412
TP404	-100V ± .1V	R449
No Change		
No Change		

Table 6-2. Replaceable Parts,

C407: Change to HP Part No. 0180-0269, C:FXD ELECT 1µF 150 wVdc
Add: C428, C429, HP Part No. 0140-0176 C:FXD MICA 100pf 300 wVdc.
Q403 Change to HP Part No. 1854-0071.
Delete: R407.

R411: Change to HP Part No. 0757-0436, R:FXD METFLM 4320 OHMS 1% 1/8W.

R412: Change to HP Part No. 2100-1773, R:VAR WW 1000 OHMS 1W.

R413: Change to HP Part No. 0757-0767, R:FXD METFLM 43 2K 1% 1/4W.

R444: Change to HP Part No. 0757-0770, R:FXD METFLM 56 2K 1% 1/4W.

R448: Change to HP Part No. 0757-0436, R:FXD METFLM 4320 OHMS 1% 1/8W.

Add: R451, R452 HP Part No. 0757-0435 R:FXD METFLM 24 3K 1% 1/4W.

Add: R453, HP Part No. 0757-0766, R:FXD METFLM 39.2K 1% 1/4W.

Delete: V401, V402.

Page 6-27, Table 6-3,

A7C407: Change description to CAPACITOR, FIXED, ELECTROLYTIC: 1µf 150 wVdc; Mfr 28480, P/N J180-0269.

Page 6-28, Table 6-3,

Add: A7C428, C429 CAPACITOR FIXED MICA 100pf 300V Mfr 28480, P/N 0140-0176

Page 6-29, Table 6-3,

A7Q403: Change description to TRANSISTOR: SAME AS A1Q302.

Delete: A7R407.

A7R411: Change description to RESISTOR: MIL TYPE RN60C4321F.

A7R412: Change description to RESISTOR, VARIABLE, WIREWOUND: 1K OHMS 1W Mfr 28480 P/N 2100-1773.

A7R413: Change description to RESISTOR: MIL TYPE RN65C4322F.

Page 6-30, Table 6-3,

A7R444: Change description to RESISTOR: MIL TYPE RN65C5622F.

A7R448: Change description to RESISTOR: MIL TYPE RN60C4321F.

Add: A7R451 RESISTOR: MIL TYPE RN65C2432F.

Add: A7R452 RESISTOR: SAME AS A7R451.

Add: A7R453 RESISTOR: MIL TYPE RN65C3922F.

Delete: A7V401, A7V402

Page 8-12, Figure 8-13,

Replace A7 Component Locator and table with Figure 2 of this change sheet.

Page 8-13, Figure 8-15,

In the Reference Designator table in the lower left corner of Figure 8-15, change the designators in A6, A7 as follows: Delete R407, V401, V402; Add C428, C429, R451, R452, R453

Make changes shown in Figure 3 of this change sheet

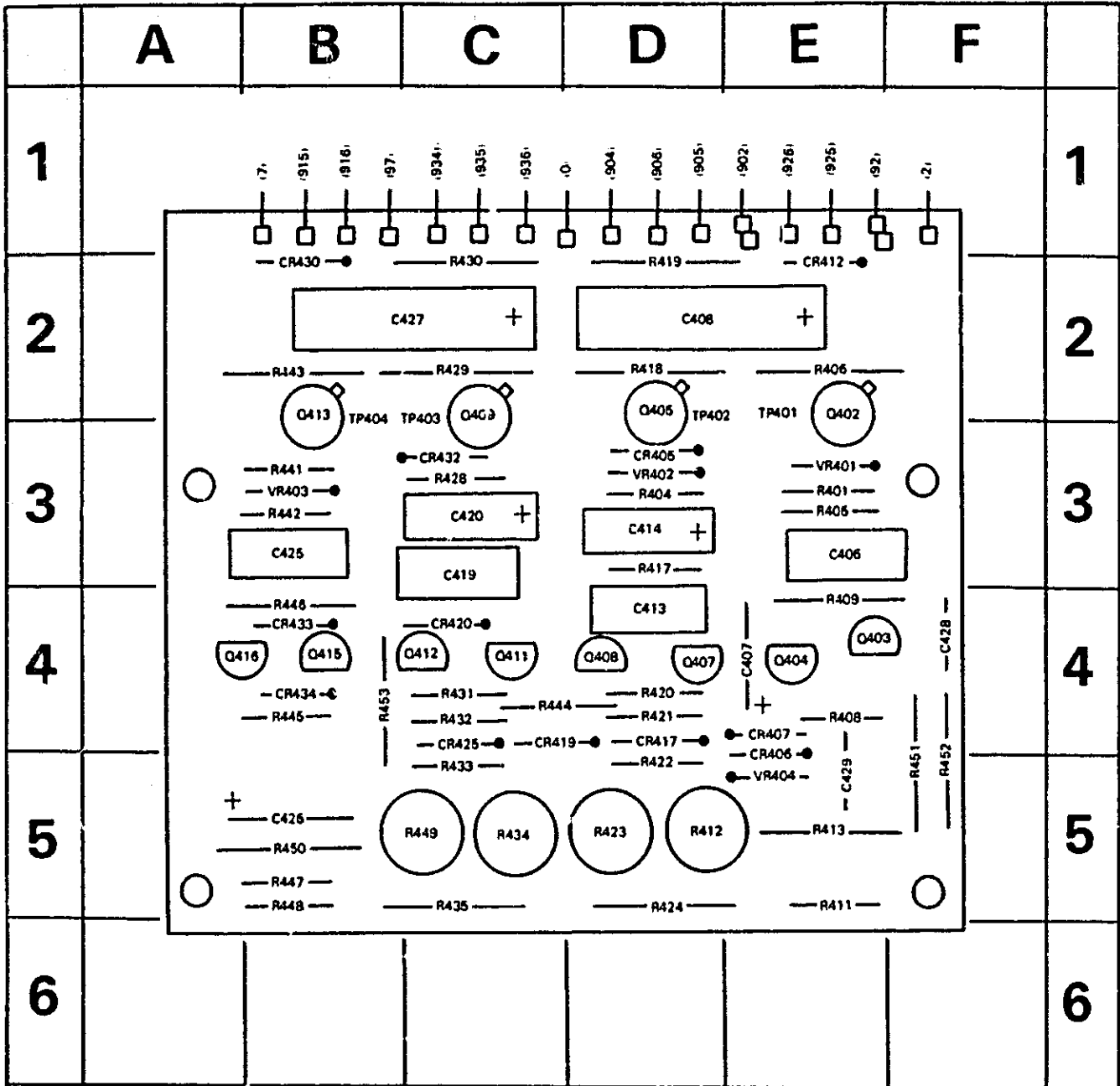

REF DESIG	GRID LOC	REF DESIG	GRID LOC	REF DESIG	GRID LOC	REF DESIG	GRID LOC	REF DESIG	GRID LOC	REF DESIG	GRID LOC	REF DESIG	GRID LOC
C406	E-3	CR405	D-3	Q402	E-2	R401	E-3	R420	D-4	R435	C-5	R452	F-5
C407	E-4	CR406	E-5	Q403	E-4	R404	D-3	R421	D-4	R441	B-3	R453	B-4
C408	D-2	CR407	E-4	Q404	E-4	R405	E-3	R422	D-5	R442	B-3	TP401	E-2
C413	D-4	CR412	E-2	Q405	D-2	R406	E-2	R423	D-5	R443	B-2	TP402	D-2
C414	D-3	CR417	D-4	Q407	D-4	R408	E-4	R424	D-5	R444	C-4	TP403	C-2
C419	C-3	CR419	C-4	Q408	D-4	R409	E-4	R428	C-3	R445	B-4	TP404	B-2
C420	C-3	CR420	C-4	Q409	C-2	R411	E-5	R429	C-2	R446	B-4	VR401	E-3
C425	B-3	CR425	C-4	Q411	C-4	R412	D-5	R430	C-2	R447	B-5	VR402	D-3
C426	B-5	CR430	B-2	Q412	C-4	R413	E-5	R431	C-4	R448	B-5	VR403	B-3
C427	C-2	CR432	C-3	Q413	B-2	R417	D-3	R432	C-4	R449	C-5	VR404	E-5
C428	F-4	CR433	B-4	Q415	B-4	R418	D-2	R433	C-5	R450	B-5		
C429	E-5	CR434	B-4	Q416	B-4	R419	D-2	R434	C-5	R451	F-5		

Figure 2. Replacement for A7 Component Identification

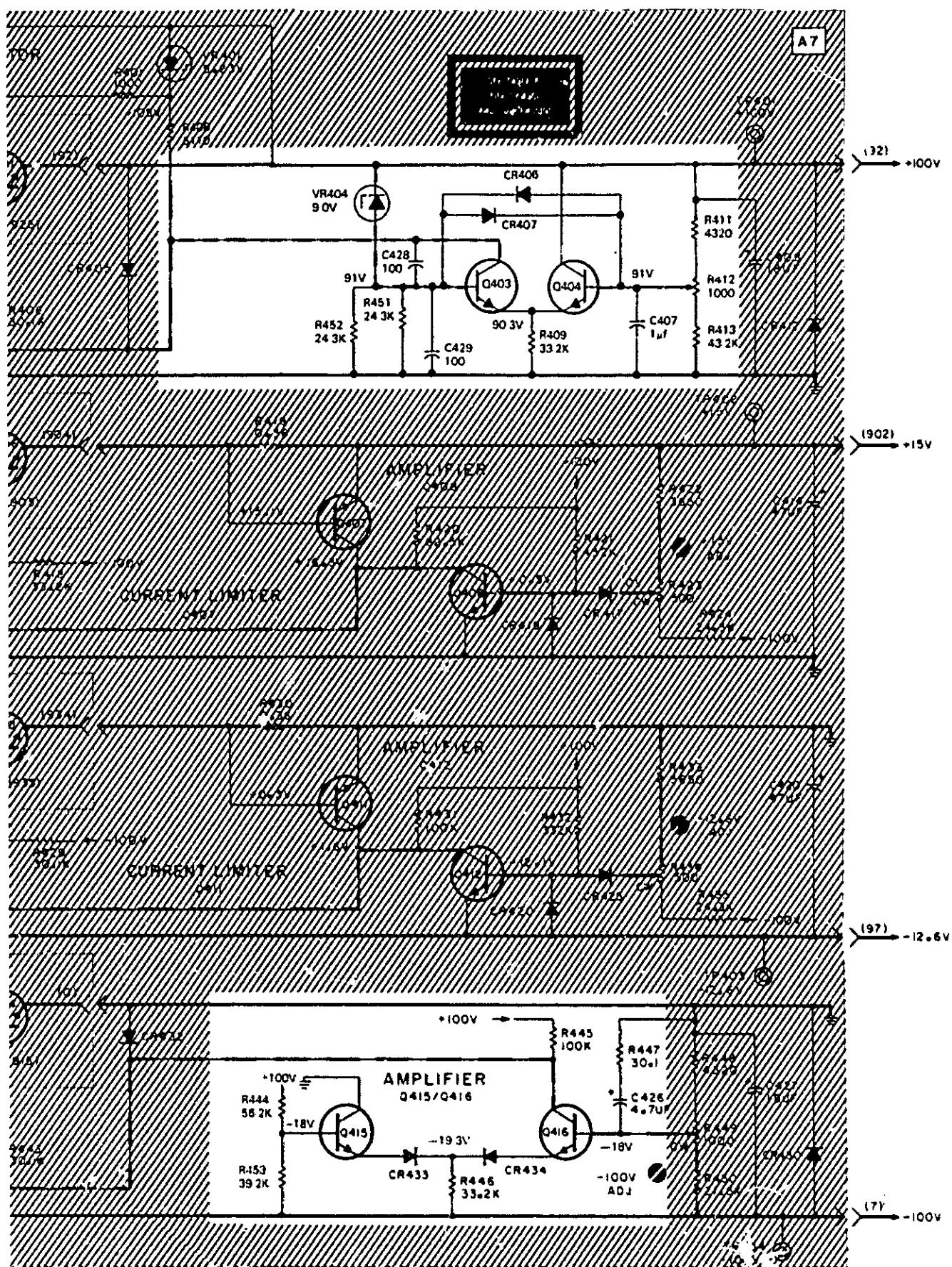

Figure 3. Modifications to Low Voltage Power Supply

▲ CHANGE 4

Table 6-2. Replaceable Parts,

- Add: A10 00180-63201, Qty 1, LINE FILTER ASSY.
- Change: C402, 404 HP Stock Number to 0160-3007.
- Add: C430, 0160-4323, TQ1 C:FXD .047 μ F 20%.
- Change: FL401 NSR: P/O A10.

Page 6-30, Table 6-3,

- Add: A10 LINE FILTER ASSEMBLY BRACKET WITH LINE FILTER, C402, C404, AND C430.
- Add: A10C402 CAPACITOR FIXED CERAMIC 4700 pf \pm 20%, 4000WVDC; Mfr 28480, 0160-3007.
- Add: A10C404, same as A10C402.
- Add: A10C430, CAPACITOR, FIXED .047 μ F \pm 20% 250 VAC, Mfr 28480, 0160-4323.
- Add: A10FL401 NSR P/O A10.

Page 6-31, Table 6-3,

- Delete: C402 and C404.
- Delete: FL400 and FL401.

Page 8-13, Figure 8-15,

Make the changes shown in Figure 4 of this change sheet.

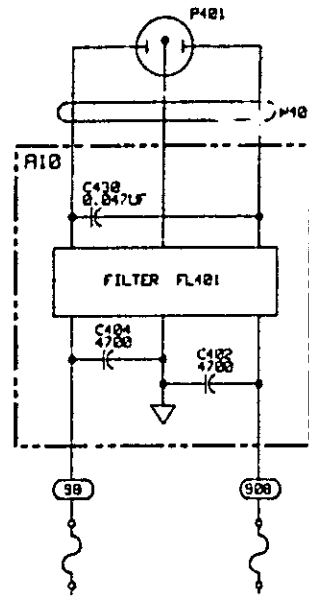

Figure 4. Modification to low voltage power supply.