

PULSE GENERATOR (MAINFRAME) 1900A

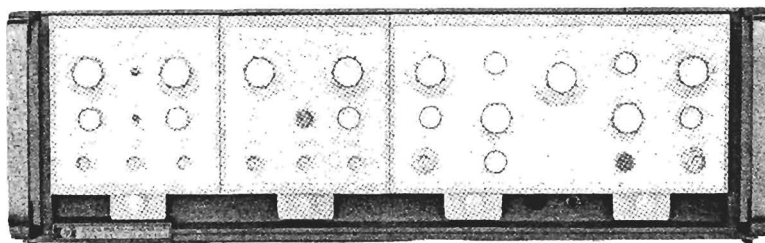

HEWLETT  PACKARD

CERTIFICATION

The Hewlett-Packard Company certifies that this instrument was thoroughly tested and inspected and found to meet its published specifications when it was shipped from the factory. The Hewlett-Packard Company further certifies that its calibration measurements are traceable to the U.S. National Bureau of Standards to the extent allowed by the Bureau's calibration facility.

WARRANTY AND ASSISTANCE

This Hewlett-Packard product is warranted against defects in materials and workmanship. This warranty applies for one year from the date of delivery, or, in the case of certain major components listed in the operating manual, for the specified period. We will repair or replace products which prove to be defective during the warranty period provided they are returned to Hewlett-Packard. No other warranty is expressed or implied. We are not liable for consequential damages.

Service contracts or customer assistance agreements are available for Hewlett-Packard products that require maintenance and repair on-site.

For any assistance, contact your nearest Hewlett-Packard Sales and Service Office. Addresses are provided at the back of this manual.



OPERATING AND SERVICE MANUAL

**MODEL 1900A
PULSE GENERATOR
(MAINFRAME)**

SERIALS PREFIXED: 1148A

Refer to Section VII for instruments with the following serial prefix numbers: 831-, 924-, 931-, 938-, 955-, 971-, 1101A, 1120A, 1140A.

Refer to Section VII for instruments with the following standard options: 001, 002, 007, X95.

HEWLETT-PACKARD COMPANY/COLORADO SPRINGS DIVISION
1900 GARDEN OF THE GODS ROAD, COLORADO SPRINGS, COLORADO, U.S.A.

Manual Part Number 01900-90903
Microfiche Part Number 01900-90803

PRINTED: SEPT 1972

TABLE OF CONTENTS

Section	Title	Page	Section	Title	Page
I	GENERAL INFORMATION	1-1	5-10.	Measurement Information.....	5-1
	1-1. Introduction	1-1	5-13.	A2 Variable Power Supply Check	5-1
	1-4. Description	1-1	5-14.	A3 Variable Power Supply Check	5-2
	1-16. Warranty	1-1	5-15.	+25V Power Supply Check.....	5-2
	1-18. Accessories Furnished	1-2	5-16.	-10V Power Supply Check.....	5-2
	1-20. Available Accessories	1-2	5-17.	+10V Power Supply Check....	5-3/5-4
	1-26. Instrument and Manual Identification	1-2	5-18.	Adjustments	5-5
	1-30. Inquiries.....	1-2	5-21.	Preliminary Setup	5-5
II	INSTALLATION	2-1	5-23.	Variable Power Supply A2 Adjustment	5-5
	2-1. Introduction	2-1	5-24.	Variable Power Supply A3 Adjustment	5-5
	2-3. Initial Inspection	2-1	5-25.	+25V Power Supply Adjustment	5-5
	2-6. Preparation for Use	2-1	VI	REPLACEABLE PARTS	6-1
	2-8. Rack Mounting	2-1	6-1.	Introduction	6-1
	2-11. Cooling	2-2	6-3.	Ordering Information	6-1
	2-15. Power	2-2	VII	MANUAL CHANGES AND OPTIONS	7-1
	2-19. Three-conductor Power Cable	2-2	7-1.	Introduction	7-1
	2-21. Claims.....	2-2	7-3.	Manual Changes.....	7-1
	2-23. Repacking for Shipment	2-2	7-4.	Special Options	7-2
III	OPERATION.....	3-1	7-9.	Standard Options	7-2
	3-1. Introduction	3-1	7-11.	Option 001	7-2
	3-3. Controls	3-1	7-14.	Option 002	7-2
	3-6. External Program Option	3-1	7-17.	Option 007	7-3
	3-8. Operating Considerations	3-1	7-19.	Option X95	7-4
	3-9. Plug-in Unit Interconnection	3-1	VIII	SCHEMATICS AND TROUBLESHOOTING	8-1
	3-12. Plug-in Capability	3-1	8-1.	Introduction	8-1
	3-15. Cooling	3-1	8-3.	Schematics	8-1
IV	PRINCIPLES OF OPERATION.....	4-1	8-7.	Reference Designations	8-1
	4-1. Introduction	4-1	8-11.	Component Locations	8-1
	4-3. Block Diagram Discussion	4-1	8-13.	Preventive Maintenance	8-1
	4-9. Circuit Details	4-1	8-14.	Cooling Blower	8-1
	4-10. Input Power Circuit.....	4-1	8-16.	Filter Maintenance.....	8-1
	4-14. +25-volt Power Supply.....	4-1	8-18.	Repair and Replacement	8-2
	4-21. Variable Power Supplies	4-2	8-19.	Semiconductor Replacement.....	8-2
	4-31. Crowbar Protection Circuit.....	4-3	8-21.	Board Connections.....	8-2
	4-35. Plug-in Connections.....	4-3	8-23.	Servicing Etched Circuit Boards.....	8-2
V	PERFORMANCE CHECK AND ADJUSTMENTS	5-1	8-25.	Troubleshooting	8-3
	5-1. Introduction	5-1	8-28.	DC Voltages	8-3
	5-3. Test Equipment	5-1	8-30.	Waveforms	8-3
	5-5. Performance Check	5-1			
	5-8. Preliminary Check	5-1			

LIST OF ILLUSTRATIONS

Figure	Title	Page	Figure	Title	Page
1-1.	Model 1900A Pulse Generator (Mainframe)	1-0	7-1.	Programming Instructions	7-3
1-2.	Plug-in Extender	1-2	8-1.	Semiconductor Terminal Identification	8-2
1-3.	Blank Plug-ins	1-2	8-2.	Parts Location, Top View	8-5
1-4.	Instrument Serial Number	1-2	8-3.	Parts Location, Bottom View	8-6
2-1.	Rack Mounting	2-1	8-4.	Component Identification, A4	8-7
2-2.	Installation	2-3	8-5.	Component Identification, A5	8-8
3-1.	Mother Board Signal Connections	3-0	8-6.	Mother Board, A6, and Internal Cables	8-9
4-1.	Overall Block Diagram	3-2/4-0	8-7.	Low Voltage Power Supply Schematic	8-9
5-1.	Dummy Load for Variable Power Supply	5-5	8-8.	$\pm 25V$ Regulator, A1, Component Identification	8-10
5-2.	Reference Current Source	5-5	8-9.	$\pm 25V$ Regulator Schematic	8-11
5-3.	Dummy Load for $\pm 25V$ Power Supply	5-5	8-10.	Variable Power Supply Waveforms, Loaded	8-12
5-4.	Dummy Load for 10V Power Supply	5-5	8-11.	Variable Power Supply Waveforms, Unloaded	8-12
5-5.	Adjustment Controls	5-5	8-12.	Variable Power Supply, A2 and A3, Component Identification	8-12
6-1.	Mechanical Parts	6-0	8-13.	Variable Power Supply Schematic	8-13
			8-14.	Plug-in Connections	8-14

LIST OF TABLES

Table	Title	Page	Table	Title	Page
1-1.	Model 1900A Specifications	1-0	6-1.	Abbreviations for Replaceable Parts List	6-1
1-2.	Mainframe Accessories	1-2	6-2.	Replaceable Parts	6-2
1-3.	Reference Designators and Abbreviations	1-3	6-3.	List of Manufacturers' Codes	6-5
2-1.	Shipping Carton Test Strength	2-3	7-1.	Manual Changes	7-1
3-1.	Plug-in Combinations	3-0	8-1.	Troubleshooting Guide	8-3
5-1.	Recommended Test Equipment	5-0	8-2.	Schematic Notes	8-4
	Performance Check Record	5-4a/5-4b	8-3.	Voltage Measurement Conditions, Schematic 1	8-9
			8-4.	Voltage Measurement Conditions, Schematic 2	8-11
			8-5.	Voltage Measurement Conditions, Schematic 3	8-13

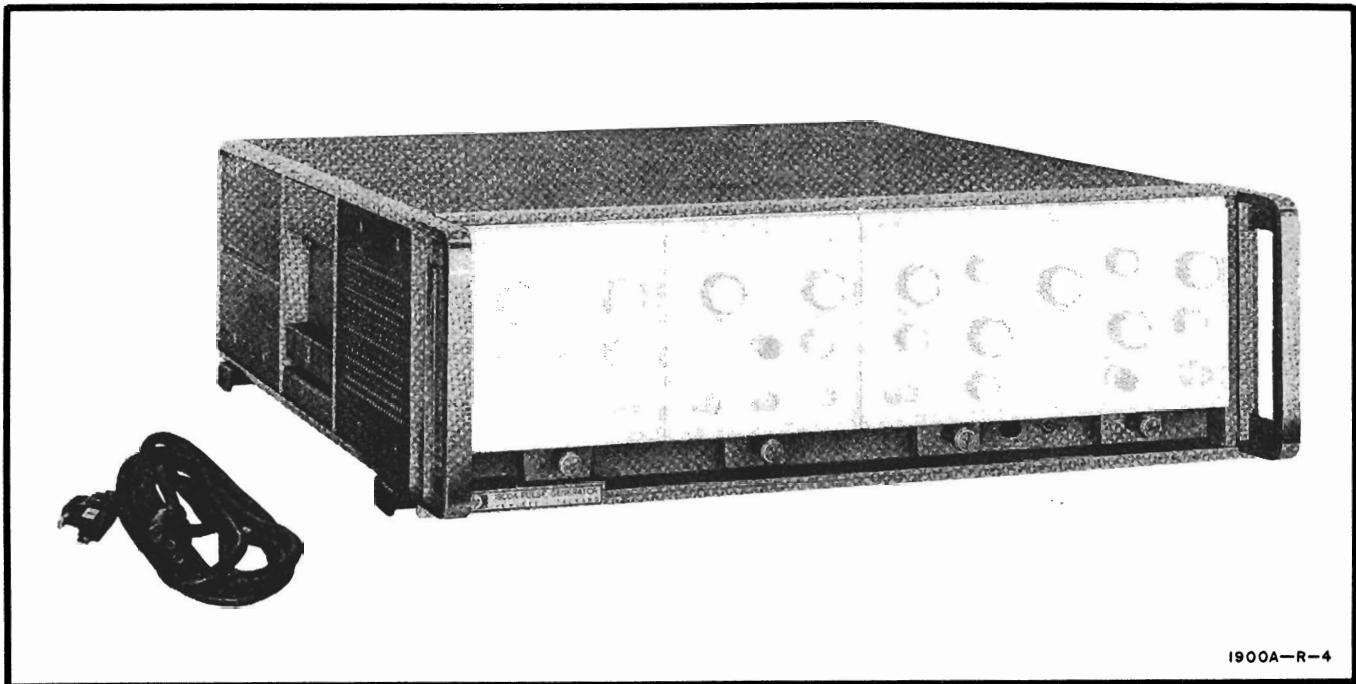

Figure 1-1. Model 1900A Pulse Generator (Mainframe)

Table 1-1. Model 1900A Specifications

GENERAL

Mainframe supplies power for all 1900-series plug-ins.

Electrical: provides power for up to four quarter-size plug-ins or two half-size plug-ins. Refer to table 3-1 for combinations and quantities.

Mechanical: mainframe compartments accept up to four quarter-size plug-ins, two half-size plug-ins, or combinations of quarter and half-size plug-ins.

INTERNAL INTERCONNECTION OF PLUG-INS

Mainframe contains cables that provide internal connections between plug-ins. Internal cables can be changed for any combination of 1900-series plug-ins. Internal or external plug-in connections selected by switches in plug-ins.

DIMENSIONS

See outline drawing.

WEIGHT

Net, 35 lb (16 kg); shipping, 46 lb (21 kg).

POWER

115 or 230 volts $\pm 10\%$, 48 to 66 Hz, 300 watts max. (varies with plug-ins).

ACCESSORIES FURNISHED

Rack mounting kit for 19-inch wide rack. Detachable power cord.

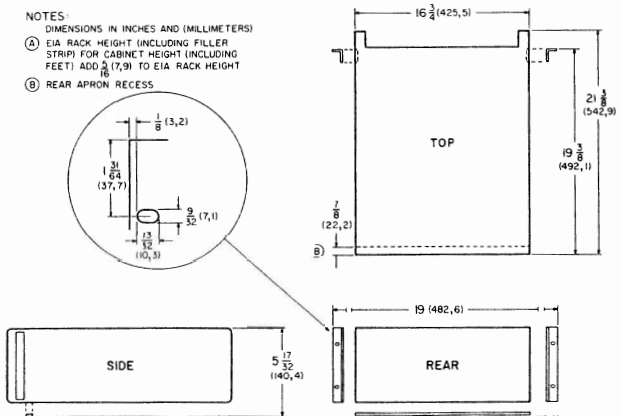

SECTION I

GENERAL INFORMATION

1-1. INTRODUCTION.

1-2. This manual provides operating and servicing information for the Hewlett-Packard Model 1900A Pulse Generator (Mainframe), (figure 1-1). The manual is divided into eight sections, each covering a specific topic or aspect of the instrument. All schematics are located at the rear of the manual and can be unfolded and used for reference while reading any part of the manual.

1-3. This section contains a description of the Model 1900A. The instrument specifications are listed in table 1-1. Table 1-3 lists and describes the abbreviations used in this manual except Section VI. The parts list is a computer readout and uses computer-supplied abbreviations. Standard options available for this instrument are listed and described in Section VII.

1-4. DESCRIPTION.

1-5. Model 1900A contains power supplies and plug-in compartments for operation of 1900-series plug-ins. Power supplies are fuse-protected and provide regulated operating power to each plug-in compartment. Forced air is used for cooling.

1-6. The plug-in compartments hold a combination of quarter-size or half-size plug-ins. Plug-ins are interchangeable and can be internally interconnected if desired. Chassis slide channels are provided for each plug-in location.

1-7. Each plug-in compartment has a fixed nut for firmly holding a plug-in into the mainframe. Each plug-in has a matching screw. Separate connectors in each plug-in compartment furnish regulated operating power to each plug-in.

1-8. The entire mainframe is shielded to reduce electromagnetic radiation and conduction. This shielding includes special double covers, a power line filter, sealing gaskets for plug-ins, and grounded screens over all air inlets and outlets.

1-9. A blower is mounted on the rear-panel. It directs cooling air to each plug-in location to remove heat from the plug-in chassis. The heated exhaust air is expelled through vents located on the sides of Model 1900A.

1-10. Line power input to Model 1900A can be 115 Vac or 230 Vac. A rear-panel switch permits external selection of the desired operating voltage. The input power circuitry

is protected by a line fuse. A main power switch located on the front panel controls operation of the power supplies, and a power-on indicator lamp is lit when the mainframe is operating.

1-11. Four regulated and one unregulated power supplies are contained in Model 1900A and supply all operating power for plug-in operation. Two supplies provide a variable output. The output voltage of a variable supply is controlled by a dc current level from a plug-in installed in the mainframe. The output of each variable supply is monitored by a crowbar which shuts down the supply if the output voltage reaches an unsafe level.

1-12. Distribution of dc voltages from the power supplies is made by a circuit board (the mother board) which connects each supply with each plug-in compartment. The mother board has four connectors, each providing power and signal connectors to the plug-in.

1-13. Coaxial 50-ohm signal connections may also be made between plug-ins. Each plug-in connector has four signal interconnections directly connected to jacks on the mother board. Six coaxial cables of various lengths are installed at the factory. These cables are equipped with quick-disconnect, square-pin, clip-type connectors. They may be readily rearranged to provide any desired signal interconnection between plug-ins.

1-14. Model 1900A, as shipped from the factory, is intended for bench use. It has a built-in tilt stand, convenient carrying handles on the sides and feet mounted on the bottom. The instrument may also be operated in a rack mounted configuration, and a rack mounting kit is provided with the instrument.

1-15. Model 1900A with programming connections (Option 001) is also available. This allows use of an external programmer to control operation of programmable plug-ins. Refer to Section VII for additional information about the programming option.

1-16. WARRANTY.

1-17. The instrument is certified and warranted as stated on the inside front cover of this manual.



The warranty may be void for instruments having a mutilated serial number tag.

1-18. ACCESSORIES FURNISHED.

1-19. A detachable three-conductor power cord is supplied with each instrument. Also included with Model 1900A is a rack mounting kit. Refer to Section II for installation information.

1-20. AVAILABLE ACCESSORIES.

1-21. Several accessories are available for use with Model 1900A. They are listed with their part numbers in table 1-2.

1-22. A plug-in extender, HP Model 10484A, is available (figure 1-2). It provides a rigid support for plug-ins and permits operation outside the mainframe. Since operating power is extended to the plug-in, the extender facilitates maintenance and troubleshooting of a plug-in. The half-size extender accepts one half-size or two quarter-size plug-ins. The extender is equipped with connectors and prewired for plug-ins with the programming option.

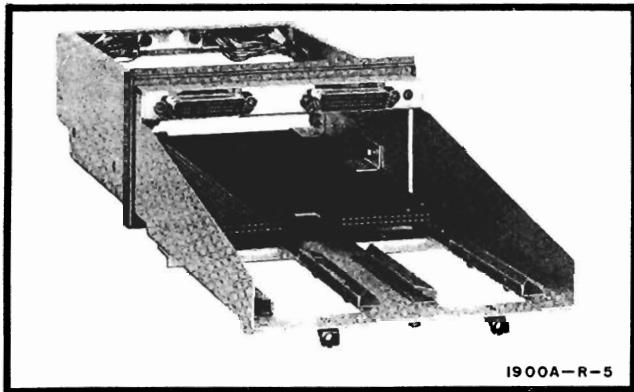

Figure 1-2. Plug-in Extender

1-23. A flexible extender cable, HP Model 10485A, may also be used to facilitate troubleshooting. It extends power to a quarter-size or a half-size plug-in.

1-24. Blank plug-ins are used to load unused compartments of the mainframe. Quarter-size and half-size units are available (figure 1-3). Their use ensures that adequate cooling will be provided for operating plug-ins. The blank plug-ins may also be used as a chassis for installation of user-designed circuits.

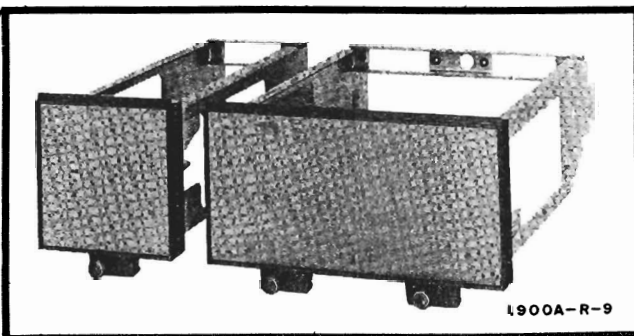

Figure 1-3. Blank Plug-ins

Table 1-2. Mainframe Accessories

Accessory Name	HP Model
Quarter-size blank plug-in	10481A
Half-size blank plug-in	10482A
Half-size extender plug-in	10484A
Extender Cable	10485A

1-25. A complete line of electronic test equipment is available from Hewlett-Packard for use in making test measurements and maintaining Model 1900A. Also available are cables, connectors, adaptors and other accessory items for use in various test and measurement applications. For information on specific items, refer to the HP catalog or contact the nearest Hewlett-Packard Sales/Service Office.

1-26. INSTRUMENT AND MANUAL IDENTIFICATION.

1-27. This manual applies directly to Model 1900A instruments with a serial prefix as listed on the title page of the manual. The serial prefix number is the first group of digits in the instrument serial number (figure 1-4.) The instrument serial number is on a tag located on the rear panel.

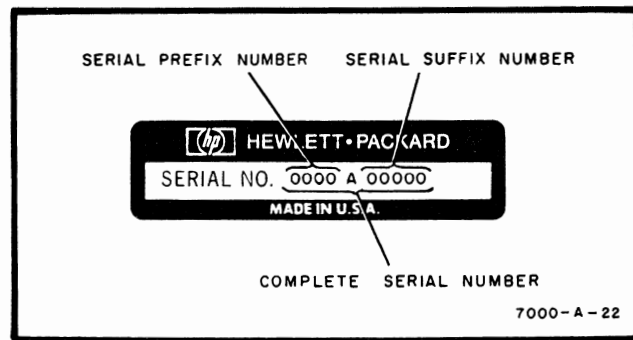

Figure 1-4. Instrument Serial Number

1-28. Check the serial prefix number of the instrument. If the serial prefix number is different from that listed on the title page of this manual, refer to Section VII for instructions to adapt this manual for proper instrument coverage.

1-29. Errors in the manual are listed under errata on an enclosed MANUAL CHANGES sheet (if any).

1-30. INQUIRIES.

1-31. Refer to any questions regarding the manual, the change sheet, or the instrument to the nearest HP Sales/Service Office. Always identify the instrument by model number, complete name, and complete serial number in all correspondence. Refer to the inside rear cover of this manual for a world-wide listing of HP Sales/Service Offices.

Table 1-3. Reference Designators and Abbreviations

REFERENCE DESIGNATORS

A	= assembly	E	= misc. electrical part	P	= plug	U	= integrated circuit (unrepairable)
AT	= attenuator, resistive termination	F	= fuse	PS	= power supply	V	= vacuum tube, neon bulb, photocell, etc.
B	= motor, fan	FL	= filter	Q	= transistor	VR	= voltage regulator (diode)
BT	= battery	H	= hardware	R	= resistor	W	= cable
C	= capacitor	J	= Jack	RT	= thermistor	X	= socket
CP	= coupling	K	= relay	S	= switch	Y	= crystal
CR	= diode	L	= inductor	T	= transformer	Z	= network
DL	= delay line	LS	= speaker	TB	= terminal board		
DS	= device signaling (lamp)	M	= meter	TP	= test point		
		MP	= mechanical part				

ABBREVIATIONS

A	= ampere(s)	FET	= field-effect transistor(s)	n	= nano (10^{-9})	rfl	= radio frequency interference
ampl	= amplifier(s)			nc	= normally closed	rms	= root mean square
assy	= assembly	G	= giga (10^9)	no.	= normally open	rwv	= reverse working voltage
ampltd	= amplitude	gnd	= ground(ed)	nnp	= negative-positive-negative		
bd	= board(s)			ns	= nanosecond	SCR	= silicon controlled rectifier
bp	= bandpass	H	= henry(ies)	p	= pico (10^{-12})	sec	= second(s)
c	= centi (10^{-2})	hr	= hour(s)	pc	= printed (etched) circuit(s)	std	= standard
C	= carbon	HP	= Hewlett-Packard	pk	= peak	trmr	= trimmer
ccw	= counterclockwise	Hz	= hertz	pnp	= positive-negative-positive	u	= micro (10^{-6})
coax.	= coaxial	if.	= intermediate freq.	p/o	= part of	usec	= microsecond
coef	= coefficient	intl	= internal	p-p	= peak-to-peak	V	= volts
com	= common	k	= kilo (10^3)	prgm	= program	var	= variable
CRT	= cathode-ray tube	lb	= pound(s)	prv	= peak inverse voltage(s)	w/	= with
cw	= clockwise	lpf	= low-pass filter(s)	ps	= picosecond	w/o	= without
d	= deci (10^{-1})	m	= milli (10^{-3})	pwv	= peak working voltage	wiv	= working inverse voltage
dB	= decibel	M	= mega (10^6)	rf	= radio frequency		
ext	= external	ms	= millisecond				
F	= farad(s)						

SECTION II

INSTALLATION

2-1. INTRODUCTION.

2-2. This section contains instructions for performing an inspection of Model 1900A. Installation procedures and precautions are presented in step-by-step order. The procedures for making a claim for warranty repairs and for repacking the instrument for shipment are also described in this section.

2-3. INITIAL INSPECTION.

2-4. The instrument was inspected mechanically and electrically before shipment. Upon receipt, inspect it for damage that may have occurred in transit. Check for broken knobs, bent or broken connectors, and dents or scratches. If damage is found, refer to the claims paragraph in this section. Retain the packing material for possible future use.

2-5. Check the electrical performance of the instrument immediately after receipt. Refer to Section V

for the performance check procedure. The performance check will determine whether or not the instrument is operating within the specifications listed in table 1-1. Initial performance and accuracy of the instrument are certified as stated on the inside front cover of this manual. If the instrument does not operate as specified, refer to the claims paragraph in this section.

2-6. PREPARATION FOR USE.

2-7. Model 1900A is designed for use as a bench operated or rack mounted instrument. When shipped from the factory, it is configured for bench use.

2-8. RACK MOUNTING.

2-9. A kit for converting Model 1900A to a rack mount configuration is supplied with each instrument. The kit will mount Model 1900A in a standard

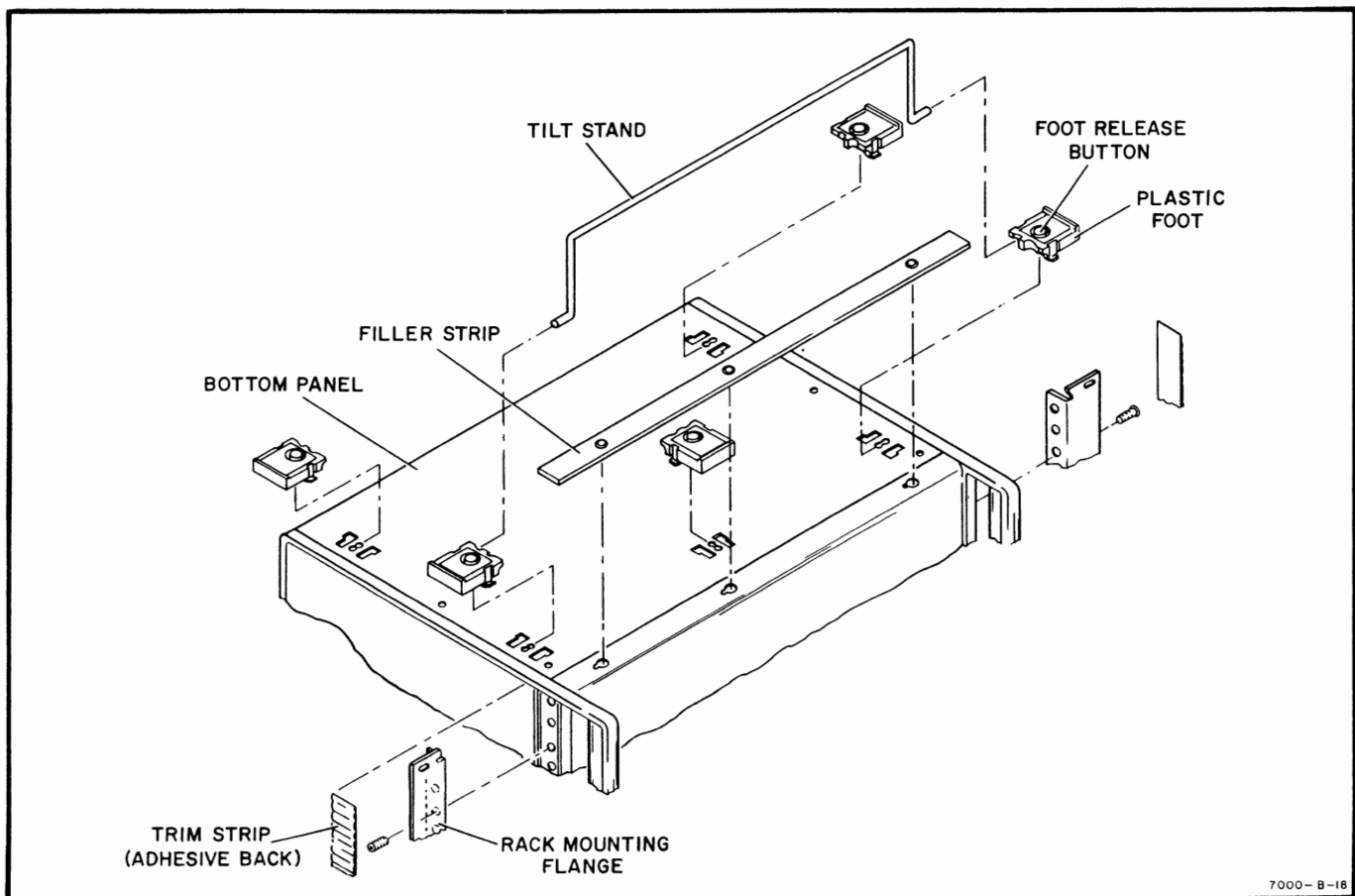

Figure 2-1. Rack Mounting

19-inch rack. Instructions for making the conversion are given below. See figure 2-1 for parts identification.

- a. Detach tilt stand by pressing it away from front feet.
- b. Remove all plastic feet by depressing metal button and sliding feet free.
- c. Remove trim strip from each side of instrument with thin-blade tool.
- d. Attach rack mounting flange in space where trim strip was removed, using screws provided with kit. Large notch of flange should be positioned toward bottom of instrument.

2-10. Rack slides are available from Hewlett-Packard as an optional item. Refer to Section VII for ordering and installation information.

2-11. COOLING.



Improper cooling will cause component failure. Make certain that bench or rack instruments can be properly cooled as described.

2-12. A blower for providing air cooling is mounted on the rear of the instrument. The blower operates when the front-panel power switch is turned on. If it does not, check the rear-panel fuse. The blower should be lubricated and the filter cleaned periodically. Detailed instructions for doing this are in Section VIII.

2-13. When the instrument is installed, select a location which ensures that the rear-panel air intake port and the side-panel exhaust ports are unobstructed. See figure 2-2. If the intake or exhaust ports are blocked, the operating plug-ins may become overheated.

2-14. Unused plug-in compartments should all be closed before operation. Use the quarter-size or half-size blank plug-ins for this purpose. Table 1-2 lists the HP part numbers for these. The distribution of cooling air to operating plug-ins will not be correct if any of the plug-in compartments are left open.

2-15. POWER.

2-16. The standard Model 1900A requires either a 115-Vac or 230-Vac $\pm 10\%$, single-phase, 48-Hz to 66-Hz power source that can deliver at least 450 VA. The actual power consumption depends on the type and quantity of plug-ins installed. A rear-panel

LINE SELECTOR slide switch permits operation on either 115V or 230V. See figure 2-2. When the operating voltage is changed, the line fuses should also be changed to ensure instrument protection. Use a slow-blow fuse if replacement is required.

2-17. 115V OPERATION. The standard instrument, as shipped from the factory, is ready for operation on 115 Vac. The rear-panel LINE SELECTOR switch must display the legend 115 when operation from this voltage is intended. Fuse values for 115V operation are marked on the rear panel.

2-18. 230V OPERATION. If the instrument is to be operated on 230 Vac, set the rear-panel switch to display 230. Change the fuses to the proper value for 230V operation, as marked on the rear panel.

2-19. THREE-CONDUCTOR POWER CABLE.

2-20. For the protection of operating personnel, Hewlett-Packard Company recommends that the instrument panel and cabinet be grounded. This instrument is equipped with a three-conductor power cable that, when connected to an appropriate receptacle, grounds the instrument through the offset pin. The power jack and mating plug of the power cord meet International Electrotechnical Commission (IEC) safety standards. To preserve this protection feature when operating from a two-contact outlet, use a three-conductor adapter, and connect the adapter flexible lead to ground at the power outlet. A suitable three-pin to two-pin adapter is available from Hewlett-Packard. Order HP Part No. 1251-0048.

2-21. CLAIMS.

2-22. The warranty statement applicable to this instrument is printed inside the front cover of this manual. If physical damage is found or if operation is not as specified when the instrument is received, notify the carrier and the HP Sales/Service office immediately (refer to the list in back of this manual for addresses). The HP Sales/Service office will arrange for repair or replacement without waiting for settlement of the claim with the carrier.

2-23. REPACKING FOR SHIPMENT.

2-24. If Model 1900A is to be shipped to a HP Sales/Service office for service or repair, attach a tag showing owner (with address), complete instrument serial number, and a description of the service required.

2-25. Use the original shipping carton and packing material. If the original packing material is not available, the HP Sales/Service office will provide information and recommendations on materials to be

used. Materials used for shipping an instrument normally include the following:

a. A double-walled carton; refer to table 2-1 for test strength required.

b. Heavy paper or sheets of cardboard to protect all instrument surfaces; use a nonabrasive material such as polyurethane or cushioned paper such as Kimpak around all projecting parts.

c. At least 4 inches of tightly-packed, industry-approved, shock-absorbing material such as extra-firm polyurethane foam.

d. Heavy-duty shipping tape for securing outside of carton.

Table 2-1. Shipping Carton Test Strength

Gross Weight (lb)	Carton Test Strength (lb)
up to 10	200
10 to 30	275
30 to 120	350
120 to 140	500
140 to 160	600

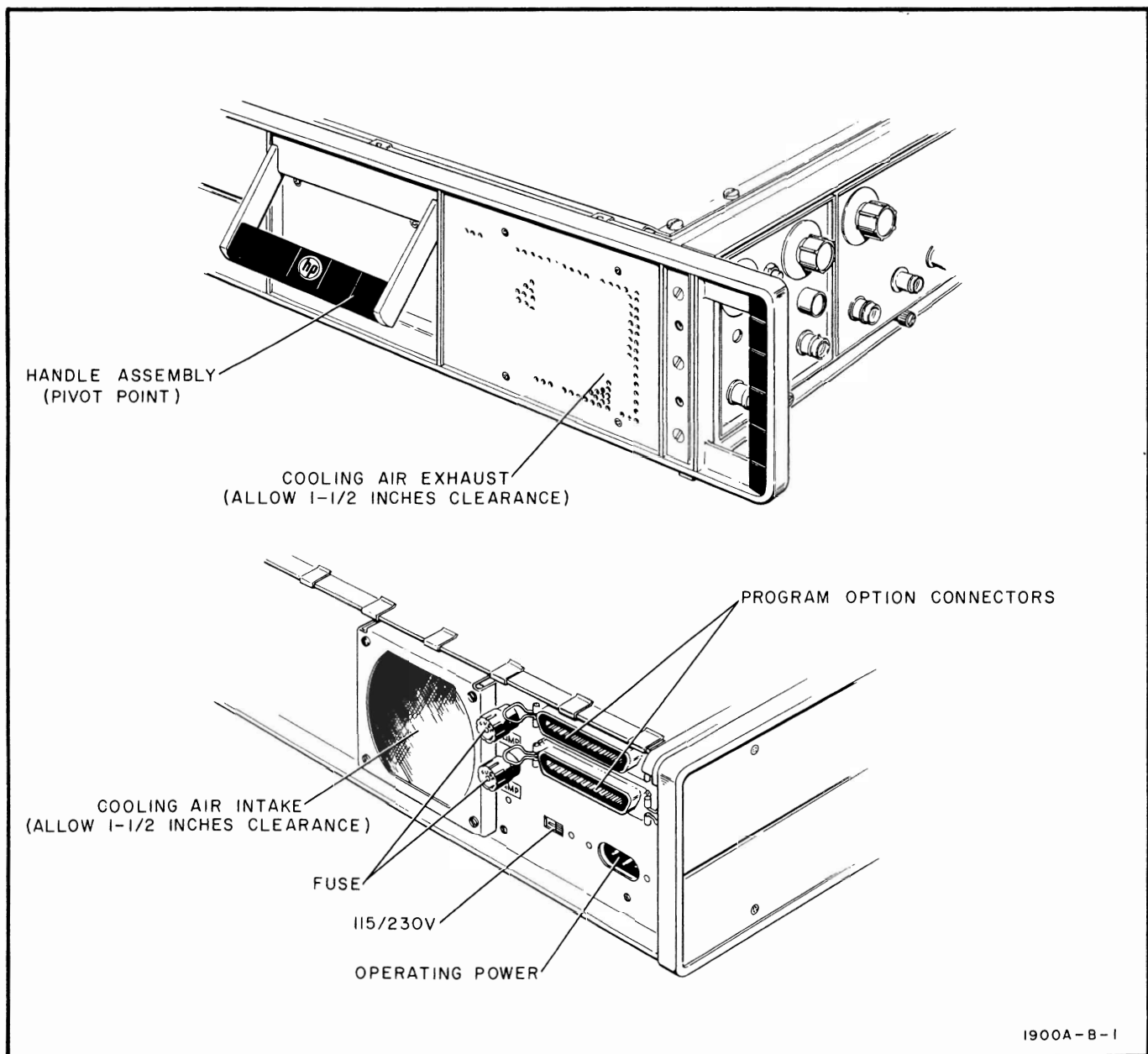

Figure 2-2. Installation

Table 3-1. Plug-in Combinations

Model 1900A Power Supply				
Plug-in	+25V	-25V	+10V	-10V
1905A	9%	9%	0	0
1906A	11%	12%	0	0
1908A	8%	8%	0	0
1909A	21%	9%	0	0
1910A	4%	4%	0	0
*1915A	*27%	*25%	0	0
1917A	40%	38%	0	0
1920A	55%	55%	0	0
1921A	43%	21%	0	0
1922A	26%	38%	0	0
1925A	10%	2%	0	33%
1927A	2%	2%	0	0
1928A	28%	19%	4%	0
1930A	13%	5%	0	42%
1934A	20%	7%	0	25%

*Because the outputs from the variable power supplies are controlled by the Model 1915A plug-ins, only one standard Model 1915A can be used in a Model 1900A. Two Model 1915A plug-ins can be used if certain modifications are made. For instance, a Model 1915A Option 002 (positive output) and a Model 1915A Option 003 (negative output) can be used together (refer to the Model 1915A operating and service manual). For modifications permitting simultaneous use of two Model 1915A plug-ins with the same polarity output, contact your nearest HP Sales/Service Office.

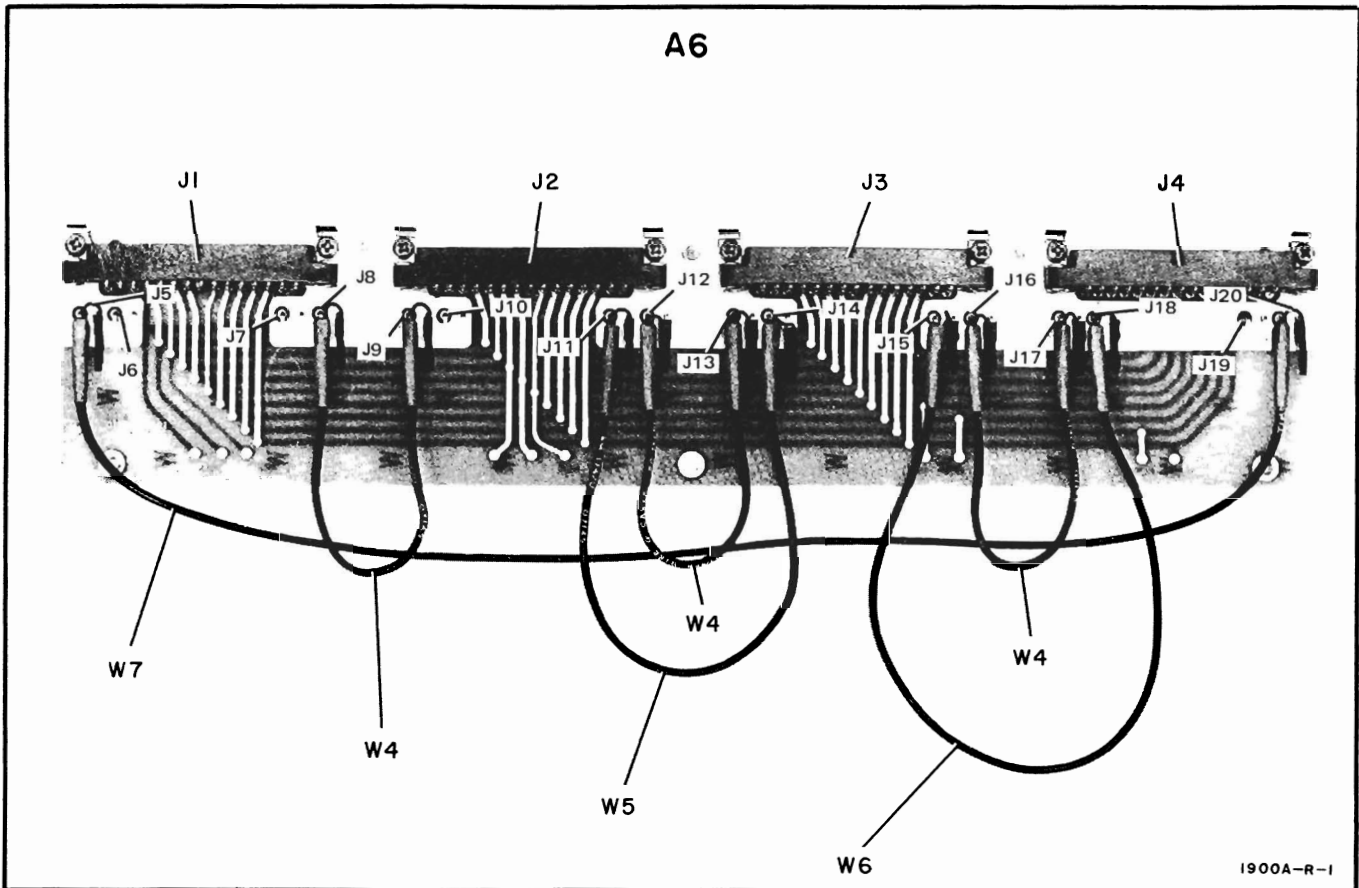

Figure 3-1. Mother Board Signal Connections

SECTION III

OPERATION

3-1. INTRODUCTION.

3-2. This section provides an explanation of the controls and special operating considerations for the mainframe.

3-3. CONTROLS.

3-4. The only front panel operating control on the mainframe is a toggle switch located under the right-hand plug-in compartment. The switch controls application of operating power to the power supplies of the mainframe. An associated indicator lamp lights when power is applied to the mainframe supplies.

3-5. Located on the mainframe rear panel is a slide switch for selecting either 115V or 230V operation. This switch is labeled LINE SELECTOR. Check the position of the switch before connecting the instrument to a power source, and check the fuses for proper value. When the operating line voltage is changed, the line fuses must be changed. Fuse values are labeled on the rear panel. If fuse replacement is required, use a slow-blow fuse of the correct rating.

3-6. EXTERNAL PROGRAM OPTION.

3-7. A programming option is available for Model 1900A. It provides the internal cabling and connectors for programming the plug-ins from the rear panel of the mainframe. Refer to Section VII for additional information concerning this option.

3-8. OPERATING CONSIDERATIONS.

3-9. PLUG-IN UNIT INTERCONNECTION.

3-10. Many of the plug-in units for the 1900 system have inputs and outputs which appear as a front panel connection and may be switched by an interface switch to appear at the rear of the plug-in. Model 1900A provides up to four coaxial connections for each quarter-size plug-in. The individual plug-in manual should be consulted to determine which inputs and outputs are available at the rear connector.

3-11. Figure 3-1 shows cable interconnections of the mainframe as shipped from the factory. In a large number of cases, no rearrangement of the coaxial internal interconnections will be necessary. If, after consulting the individual plug-in manuals, it is determined that a different arrangement is needed, the connections may be rearranged as desired. Care should be taken to ensure that all inputs or outputs which are to be interconnected via the mainframe have their associated plug-in interface switch placed in the internal position. Inputs or outputs to be interconnected via front panel connections should have the interface switch in the external position.

3-12. PLUG-IN CAPABILITY.

3-13. The mainframe will deliver 2 amperes from each of the variable supplies; 2.2 amperes from each 25V supply and 3.6 amperes from each 10V supply. This will provide the required operating power for 1900-series plug-ins as shown in table 3-1.

3-14. The quantity of plug-ins which can be powered from the mainframe may be in any desired combination within the capability of the power supplies. To determine the maximum number of plug-ins that may be operated in a mainframe, total the percentage of each power supply capability required by the desired plug-in combination. The plug-in combination may be safely used if the total for each required power supply does not exceed 100%.

3-15. COOLING.

3-16. Ensure that the air cooling system of the mainframe is operating properly. Check the air intake port located on the rear of the mainframe and the exhaust ports located on both sides. They should be unobstructed and permit a free flow of air.

3-17. All unused module ports should be closed. Section I of this manual lists the blank plug-ins which may be used for this purpose. Improper operation of the cooling system may cause mainframe or plug-in overheating with possible component damage.

3-18. Make periodic inspections of the screen filter associated with the blower. To ensure adequate cooling, the screen filter must always be clean.

must be in place and properly secured during operation.



Air cooling will be improper with either of the inner covers removed. Both covers

3-19. The air intake fan motor requires lubrication about twice a year. Lubrication instructions are provided in Section VIII of this manual.

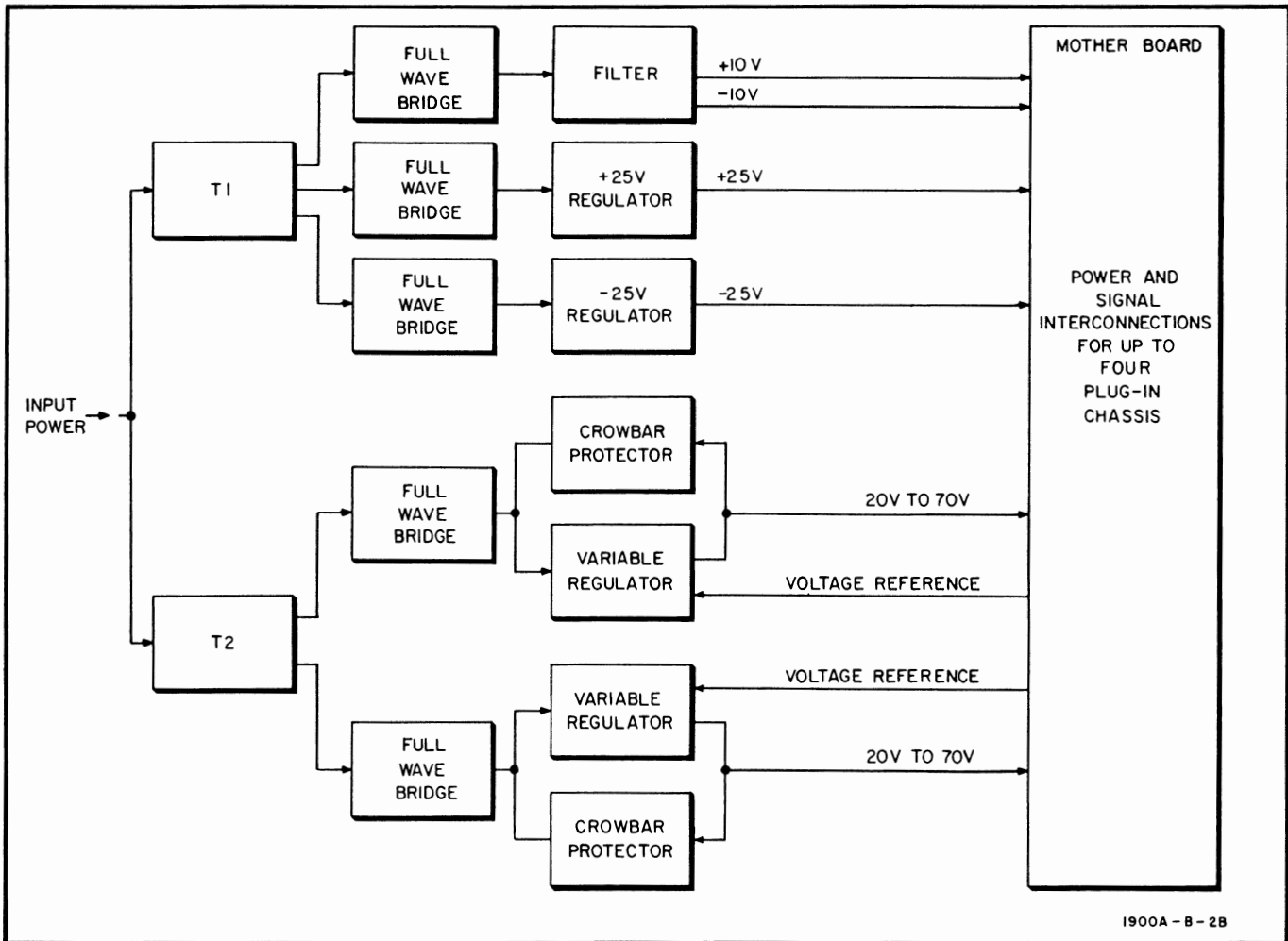

Figure 4-1. Overall Block Diagram

SECTION IV

PRINCIPLES OF OPERATION

4-1. INTRODUCTION.

4-2. This section contains functional descriptions keyed to an overall block diagram of the instrument, and simplified block diagrams of circuit groups. A detailed explanation of circuit functions, keyed to the schematics, is provided after the block discussion. The schematics are located in Section VIII.

4-3. BLOCK DIAGRAM DISCUSSION. (See figure 4-1.)

4-4. Line power is input to transformers T1 and T2. Transformer T1 has three outputs. One of the outputs is full-wave bridge rectified and filtered. This provides unregulated 10-volt power to the mother board.

4-5. The other two outputs of T1 are full-wave bridge rectified and regulated. Positive and negative 25-volt regulated power is provided to the mother board.

4-6. Transformer T2 has two outputs. Each drives a full-wave bridge rectifier. The output voltage of each is set by a variable regulator controlled by a voltage reference from the plug-in instrument connected to the mother board. The output of each regulator can be varied over the range of 20 to 70 volts.

4-7. A crowbar protection circuit operates on the output voltage level of the variable regulated supply. If the output voltage exceeds the minimum operating level, the crowbar circuit operates to provide protection to the circuit by interrupting the regulator output.

4-8. The mother board distributes all operating power to each mainframe plug-in location. The mother board also provides for interconnection of signals for up to four plug-ins.

4-9. CIRCUIT DETAILS.

4-10. INPUT POWER CIRCUIT. (See schematic 1.)

4-11. Line input power is obtained through a polarized, 3-conductor power jack and line filter. Line filter FL1 and power jack J1 are combined in a single component. Switch S1 is the POWER switch used to turn the instrument on or off. The ac line input power for T1 and T2 is fused.

4-12. Switch S2 places the primary windings of transformers T1 and T2 in series or parallel. When set for operation from 230-Vac input power, the windings are placed in series, and when the instrument is set for 115-Vac operation, the windings are in parallel.

4-13. Blower B1 is always connected in parallel with one primary winding of transformer T1. Thus, it always operates on 115V. Power indicator lamp DS1 is similarly powered by being connected in parallel with one winding of T2. DS1 is a neon bulb and resistor R1 is used to limit the current for DS1.

4-14. ±25-VOLT POWER SUPPLY. (See schematics 1 and 2.)

4-15. This power supply has two separately regulated outputs, +25V and -25V. The positive supply regulator and negative supply regulator are identical. Only the +25V supply will be discussed.

4-16. The secondary voltage developed by power transformer T1 at pins 8 and 9 is full-wave bridge rectified by A4CR5 through A4CR8 and filtered by C3. Series regulator Q3 determines the amount of current supplied to the load to maintain the regulated output voltage at +25V.

4-17. Output of the series regulator is dropped across a network consisting of A1R6, A1R7, A1R8 and A1CR7. The variable potentiometer, A1R7, is adjusted to establish a supply output level of +25V. Any changes in output are sensed by A1Q3. Voltage regulating diode A1VR1, with A1R5 and A1C9, maintains the emitter of A1Q3 at a constant potential and provides a reference voltage for sensing amplifier A1Q3.

4-18. Transistor A1Q1 functions as a preregulator. Changes in the rectified output voltage (before regulation) are amplified by A1Q1. The output of A1Q1 is applied to Q4 for control of series regulator Q3. This action tends to smooth any larger changes caused by input power line transients, etc.

4-19. Current drawn from the regulated supply flows through A1R4. The voltage drop across the resistor is used to control A1Q2 which operates as a current limiter. As the current requirements increase up to the limit of supply capability, the increased voltage drop across A1R4 sets A1Q2 into conduction.

4-20. The collector outputs of the preregulator (A1Q1), the current limiter (A1Q2), and the sensing amplifier (A1Q3) are coupled to drive Q4 and control the operation of series regulator Q3. Thus, the amount of current flowing, as well as voltage variations, control the operation of the series regulator to maintain the output of the supply at a regulated +25V.

4-21. VARIABLE POWER SUPPLIES. (See schematics 1 and 3.)

4-22. Model 1900A has two variable regulated supplies. The two supplies (A2 and A3) are identical and only one will be discussed. The output voltage level of the variable supply is controlled by a reference current from a 1900-series plug-in, and can be varied over the range of 20 to 70 volts.

4-23. **BLOCK DIAGRAM DESCRIPTION.** A block diagram of the variable power supply is shown in figure 4-2. The output of a free-running multivibrator is used to control the operation of a transistor switch. Since the switch changes state at the multivibrator operating rate, the current output is pulsating. An averaging network is used to smooth the output.

4-24. A reference current from the controlling plug-in establishes the desired output voltage. Two inputs to an adjustable bias source control its output: the reference current from the plug-in and the output voltage level of the variable power supply. Output of the adjustable bias source sets the operating bias for an inverse current bias source. It is this stage that establishes the operating duty cycle of the multivibrator, causing it to conduct for a greater period of time if a higher regulated output voltage is required.

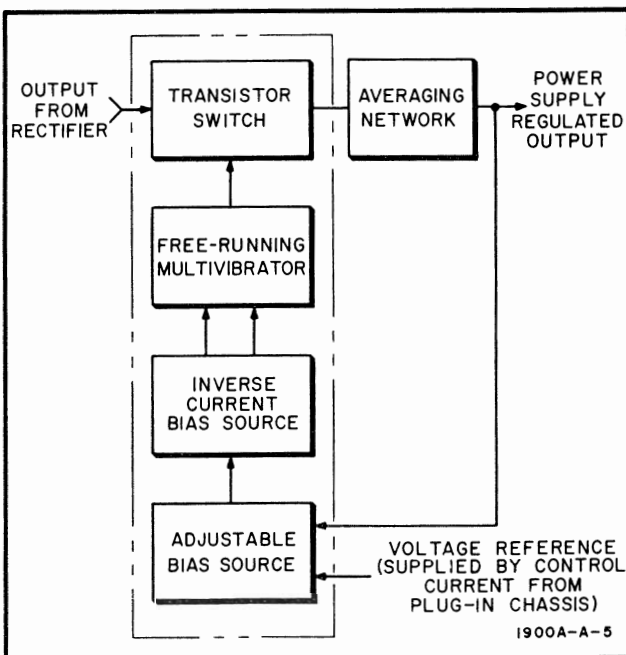

Figure 4-2. Block Diagram, Variable Supply

4-25. **CIRCUIT DETAILS.** Transistors A2Q3 and A2Q5 are used as a free-running, emitter-coupled multivibrator operating at approximately 50 kHz. Current for operation of the multivibrator is controlled by A2Q4 and A2Q6. The duty cycle of the multivibrator square wave output depends on the ratio of current from current sources A2Q4 and A2Q6 and the time constant of multivibrator emitter-coupling capacitor A2C2.

4-26. Multivibrator output is a square wave, and the variable width output at the collector of A2Q5 is used to operate the switch driver, A2Q9. Driven by A1Q9, transistors A2Q10 and A2Q11 are paralleled to provide the necessary current-carrying capability. Operating as saturable voltage switches, A2Q10 and A2Q11 control the unregulated supply voltage used to charge an LC voltage averaging network.

4-27. A series LC network, consisting of L1 with C6 and C7 in parallel, is charged when the voltage switching transistors (A2Q10 and A2Q11) are saturated. The LC network smooths the charging voltage, and the smoothed and regulated voltage is the output of the supply. Diode A2CR8 operates to place the inductor in parallel with C6 and C7 during the time the voltage switching transistors are not conducting. This maintains current flow to the power supply load. When the output switching transistors are turned off, A2Q12 operates to maintain a low impedance path and improve the switching characteristic.

4-28. Output voltage variations are sensed by A2Q8. The base input operating level of this transistor is set by potentiometer A2R17. A series resistor network, A2R15 through A2R18, is across the power supply output, and the wiper of A2R17 is adjustable to provide base bias for A2Q8. A temperature compensating, voltage regulating diode, A2VR5, establishes a reference voltage for the sensing amplifier. The voltage developed at the wiper of A2R17 is combined with the control reference input from the plug-in to control the operation of the power supply over the variable range..

4-29. Transistor A2Q2 operates as a current limiter, protecting the supply against excessive load current. A2Q2 is placed into operation by an increase in voltage developed across A2R23 and A2R24. The limiter effectively short circuits voltage reference A2VR5, causing A2Q8 to reduce the output voltage.

4-30. Diodes A2CR2 through A2CR4 provide protection for A2Q10 and A2Q11 when the power supply is first turned on. Transistor A2Q1 and voltage reference diodes A2VR1 through A2VR3 provide voltage and current biases for the multivibrator and associated control circuitry.

4-31. CROWBAR PROTECTION CIRCUIT. (See schematic 1.)

4-32. Each of the variable power supplies is protected by a crowbar circuit. Since the circuits are identical, only one will be discussed. Both crowbar circuits are located on one assembly, A5.

4-33. A voltage regulating diode, A5VR1, is connected in parallel with the output of the variable regulated supply. If the output voltage exceeds 75 volts, the diode applies forward bias to the trigger of a silicon-controlled rectifier (SCR), A5CR11. The SCR short circuits the unregulated input to the variable

supply. This causes the fuse, A5F1, to open and disables the supply.

4-34. A5CR9 is used for reverse voltage protection. When the crowbar operates, the diode acts to prevent damage to the transistors of the variable supply.

4-35. PLUG-IN CONNECTIONS. (See schematics 1 and 4.)

4-36. All power and signal connections to the plug-ins are made through the jack connections of the mother board assembly A6. Each jack has the same connections. The power and signal connections to a plug-in are shown in schematic 4.

Table 5-1. Recommended Test Equipment

Instrument		Required Characteristics	Required For
Type	Model		
Digital Voltmeter	HP 3439A HP 3441A	10-volt to 70-volt range, 0.1% accuracy.	Measuring power supply outputs.
Reference Current Source		Variable 0 to 12.5 mA dc output capability. 10K output impedance. Provide conventional current flow from the reference node to the negative side of the supply. See figure 5-2 for an alternate current source.	Performance check of variable power supply regulator.
Variable Power Supply Dummy Load		See figure 5-1.	Output load for check of variable power supply tracking and dynamic range.
±25-volt Power Supply Dummy Load		See figure 5-3.	Output load for check of ±25-volt power supply maximum output.
10-volt Power Supply Dummy Load		See figure 5-4.	Output load for check of unregulated 10-volt power supply maximum output.
15-pin Connector	HP Part No. 1251-2090	Male connector, 15-pin.	Connections to power supplies.

SECTION V

PERFORMANCE CHECK AND ADJUSTMENTS

5-1. INTRODUCTION.

5-2. This section contains step-by-step procedures for checking instrument specifications as given in table 1-1 of this manual. A table (performance check record) is provided at the end of the performance check for recording the measurements obtained in the first running of the procedure. This record may be used to compare measurements taken at later dates with the original. The procedures for making all internal adjustments are covered in paragraphs 5-18 through 5-25. A photograph showing the locations of all internal adjustment controls is presented in figure 5-5.

5-3. TEST EQUIPMENT.

5-4. Test equipment required for procedures in this section is listed in table 5-1. Test equipment equivalent to that recommended may be substituted, provided it has the required characteristics listed in the table. For best results, use recently calibrated test equipment.

5-5. PERFORMANCE CHECK.

5-6. The following subparagraphs describe procedures to determine whether or not the instrument is operating within the specifications of table 1-1. This check can be used as part of an incoming inspection, as a periodic operational test, or to check calibration after repairs or adjustments have been made. Any one of the following checks can be made separately if desired.

5-7. A performance check record is included at the end of these checks. As the initial performance check is accomplished, the readings should be entered on the form. The form may be removed from the manual and filed for future reference. Readings taken at a later date can be compared with the original performance check results.

5-8. PRELIMINARY SETUP.

5-9. Set the line voltage selector switch, located on the rear panel, to the desired line operating voltage (115 Vac or 230 Vac). Check that fuses of the proper value are installed in the fuse holders. Values are labeled on the rear panel. Connect instrument to line power source and apply power by turning front-panel power switch on. Allow at least 10 minutes for warm-up. Do not install plug-ins.

5-10. MEASUREMENT INFORMATION.

5-11. Each of the performance checks uses a dummy load to establish the maximum current load when measuring supply voltage. The dummy load resistance values specified will load the supply so that power supply current need not be measured. Instead, the output voltage of the supply, under load, is measured. This facilitates making the measurement.

5-12. Connection of the dummy load for a test may be made to any one of the four plug-in connectors of the mainframe mother board (A6). All connectors are paralleled for supply voltages to the plug-ins. The current source used for checking the variable power supplies may also be connected to any one of the four plug-in connectors.



After warm-up, turn power off before connecting dummy load. This procedure will prevent possible shock and eliminate arcing connectors.

5-13. A2 VARIABLE POWER SUPPLY CHECK.

a. Connect Variable Power Supply Dummy Load, figure 5-1, between pin 6 and pin 7 of 15-pin Connector.

b. Monitor voltage across Variable Power Supply Dummy Load using Digital Voltmeter.

c. Insert 15-pin Connector into any mother board plug-in connector.

d. Turn Model 1900A power ON. Power supply output shall be 20V \pm 1%.

e. Turn Model 1900A power OFF.

f. Connect Reference Current Source, figure 5-2, between pin 7 and pin 9 of 15-pin connector.

g. Turn Model 1900A power ON.



Do not exceed 12.5-mA current or crowbar SCR will fire and open fuse.

h. Slowly vary potentiometer of Reference Current Source. Voltage measurement shall vary from approximately 20 to approximately 70 volts dc.

Note

Output of the variable power supply will change at a constant rate of approximately 4 volts per milliampere of reference current input. Current source variation from 0 to 12.5 mA will change the supply output voltage from 20V to 70V.

i. Turn Model 1900A power OFF.

j. Disconnect Variable Power Supply Dummy Load, Digital Voltmeter, and Reference Current Source by removing 15-pin Connector.

5-14. A3 VARIABLE POWER SUPPLY CHECK.

a. Connect Variable Power Supply Dummy Load, figure 5-1, between pin 3 and pin 4 of 15-pin Connector.

b. Monitor voltage across Variable Power Supply Dummy Load using Digital Voltmeter.

c. Insert 15-pin Connector into any mother board plug-in connector.

d. Turn Model 1900A power ON. Power supply output shall be 20V $\pm 1\%$.

e. Turn Model 1900A power OFF.

f. Connect Reference Current Source, figure 5-2, between pin 4 and pin 5 of 15-pin Connector.

g. Turn Model 1900A power ON.



Do not exceed 12.5-mA current or crowbar SCR will fire and open fuse.

h. Slowly vary potentiometer of Reference Current Source. Voltage measurement shall vary from approximately 20 to approximately 70 volts dc.

Note

Output of the variable power supply will change at a constant rate of approximately 4 volts per milliampere of reference current input. Current source variation from 0 to 12.5 mA will change the supply output voltage from 20V to 70V.

i. Turn Model 1900A power OFF.

j. Disconnect Variable Power Supply Dummy Load, Digital Voltmeter, and Reference Current Source by removing 15-pin Connector.

5-15. $\pm 25V$ POWER SUPPLY CHECK.

a. Connect ± 25 -volt Power Supply Dummy Load, figure 5-3, between pin 8 and pin 13 of 15-pin Connector.

b. Connect Digital Voltmeter to monitor voltage across ± 25 -volt Power Supply Dummy Load.

c. Insert 15-pin Connector into any mother board plug-in connector.

d. Turn Model 1900A power ON. Power supply output shall be $+25V \pm 1\%$.

e. Turn Model 1900A power OFF.

f. Connect ± 25 -volt Power Supply Dummy Load between pin 8 and pin 11 of 15-pin Connector.

g. Connect Digital Voltmeter to monitor voltage across ± 25 -volt Power Supply Dummy Load.

h. Turn Model 1900A power ON. Power supply output shall be $-25V \pm 1\%$.

i. Turn Model 1900A power OFF.

j. Disconnect ± 25 -volt Power Supply Dummy Load and Digital Voltmeter by removing 15-pin Connector.

5-16. $-10V$ POWER SUPPLY CHECK.

a. Connect 10-volt Power Supply Dummy Load, figure 5-4, between pin 8 and pin 10 of 15-pin Connector.

b. Connect Digital Voltmeter to monitor voltage across 10-volt Power Supply Dummy Load.

c. Insert 15-pin Connector into any mother board plug-in connector.

d. Turn Model 1900A power ON. Power supply output shall be $-10V \pm 20\%$.

e. Turn Model 1900A power OFF.

f. Disconnect 10-volt Power Supply Dummy Load and Digital Voltmeter by removing 15-pin Connector.

5-17. +10V POWER SUPPLY CHECK.

a. Connect 10-volt Power Supply Dummy Load, figure 5-4, between pin 8 and pin 12 of 15-pin Connector.

b. Connect Digital Voltmeter to monitor voltage across 10-volt Power Supply Dummy Load.

c. Insert 15-pin Connector into any mother board plug-in connector.

d. Turn Model 1900A power ON. Power supply output shall be $+10V \pm 20\%$.

e. Turn Model 1900A power OFF.

f. Disconnect 10-volt Power Supply Dummy Load and Digital Voltmeter by removing 15-pin Connector.

PERFORMANCE CHECK RECORD

MODEL 1900A

Instrument Serial Number _____

Date _____

Check	Specification	Measured
A2 Variable Power Supply	20V to 70V	_____
A3 Variable Power Supply	20V to 70V	_____
±25V Power Supply		
+25V	±1%	_____
-25V	±1%	_____
-10V Power Supply	±20%	_____
+10V Power Supply	±20%	_____

5-18. ADJUSTMENTS.

5-19. The following paragraphs describe procedures to calibrate the instrument so that it will perform as specified in table 1-1. The entire adjustment procedure can be done in sequence, or any separate adjustment can be calibrated by following the steps outlined in the appropriate paragraph. The locations of adjustment controls are shown in figure 5-5 at the end of this section.

5-20. Use a nonmetallic screwdriver and recently calibrated test equipment with characteristics as specified in table 5-1. After adjustments are complete, check instrument performance by doing the performance check procedure at the beginning of this section.

5-21. PRELIMINARY SETUP.

5-22. Set the line selector switch, located on the rear panel, to desired line operating voltage (115 Vac or 230 Vac). Check that fuses of proper value are installed in the fuse holders. Values are labeled on the rear panel. Remove bottom covers for access to adjustments and measuring points. Connect instrument to line power source and apply power by turning front-panel power switch on.

Allow at least 10 minutes for warm-up. Do not install plug-ins.

5-23. VARIABLE POWER SUPPLY A2 ADJUSTMENT.

- a. Using Digital Voltmeter, measure voltage between J3 pin 9 and J3 pin 10.
- b. Adjust A2R17 to obtain 20 ± 0.01 volts.

5-24. VARIABLE POWER SUPPLY A3 ADJUSTMENT.

- a. Using Digital Voltmeter, measure voltage between J4 pin 9 and J4 pin 10.
- b. Adjust A3R17 to obtain 20 ± 0.01 volts.

5-25. $\pm 25V$ POWER SUPPLY ADJUSTMENT.

- a. Using Digital Voltmeter, measure voltage between J2 pin 5 and J2 pin 10.
- b. Adjust A1R7 to obtain $+25 \pm 0.01$ volts.
- c. Using Digital Voltmeter, measure voltage between J2 pin 6 and J2 pin 10.
- d. Adjust A1R15 to obtain -25 ± 0.01 volts.

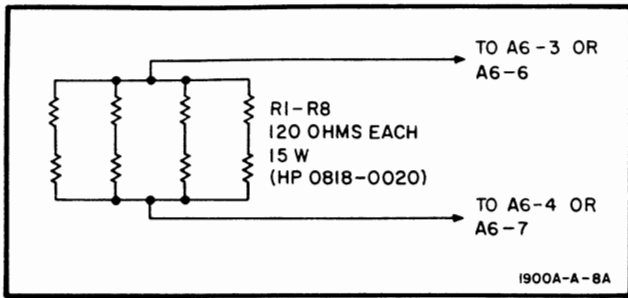

Figure 5-1. Dummy Load for Variable Power Supply

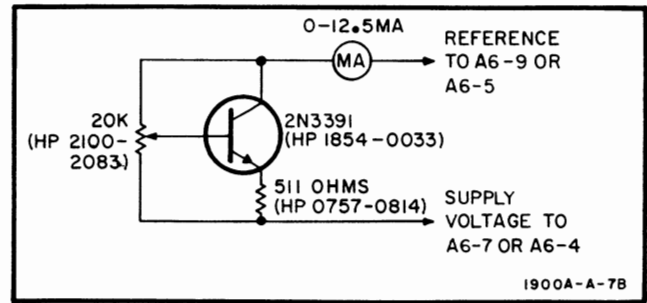

Figure 5-2. Reference Current Source

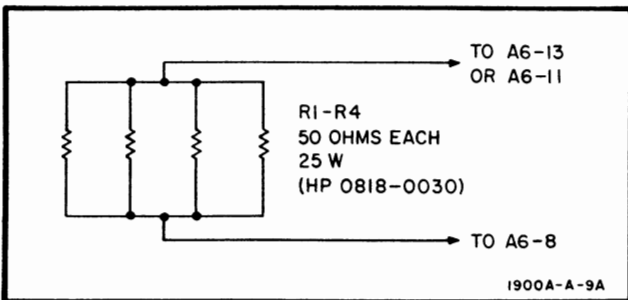

Figure 5-3. Dummy Load for ±25V Power Supply

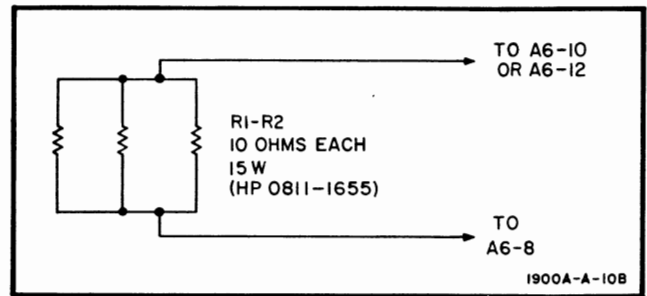

Figure 5-4. Dummy Load for 10V Power Supply

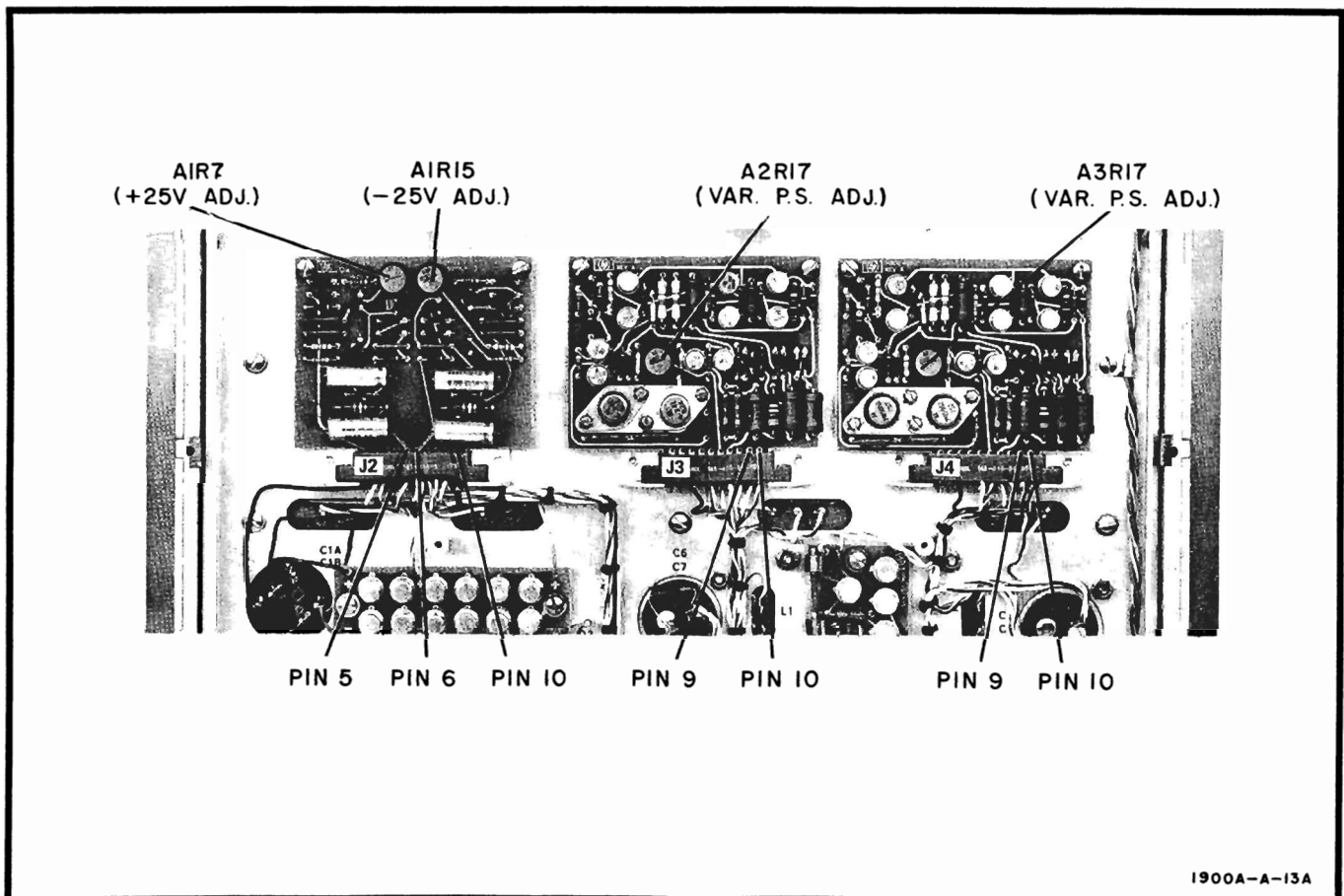
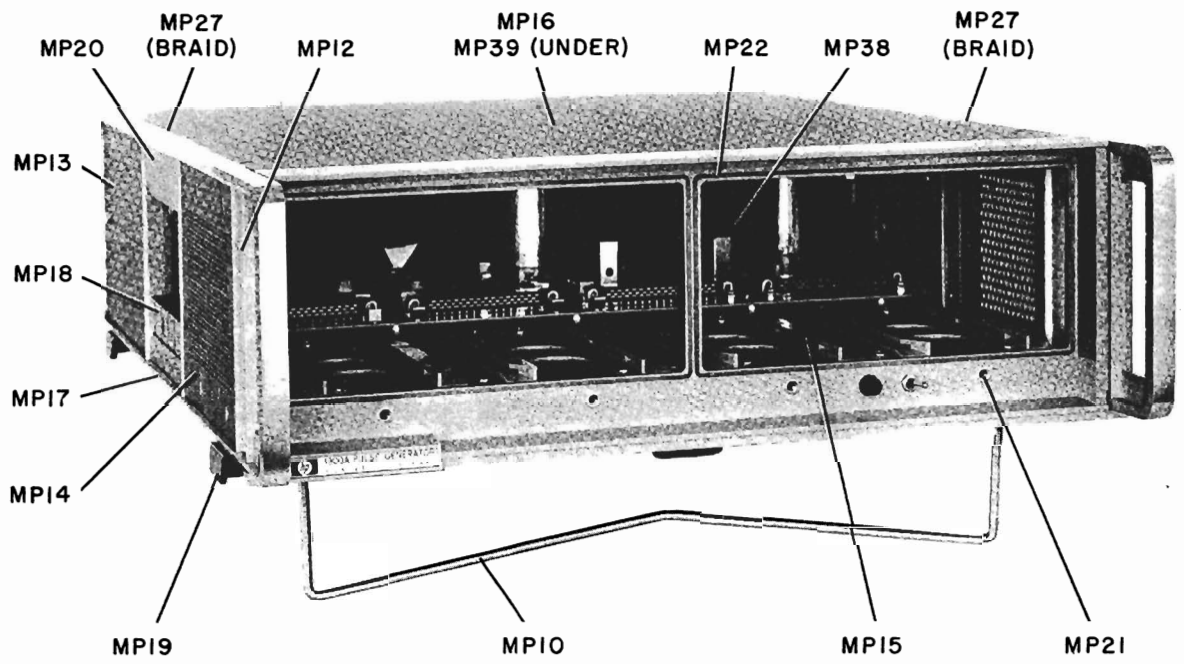
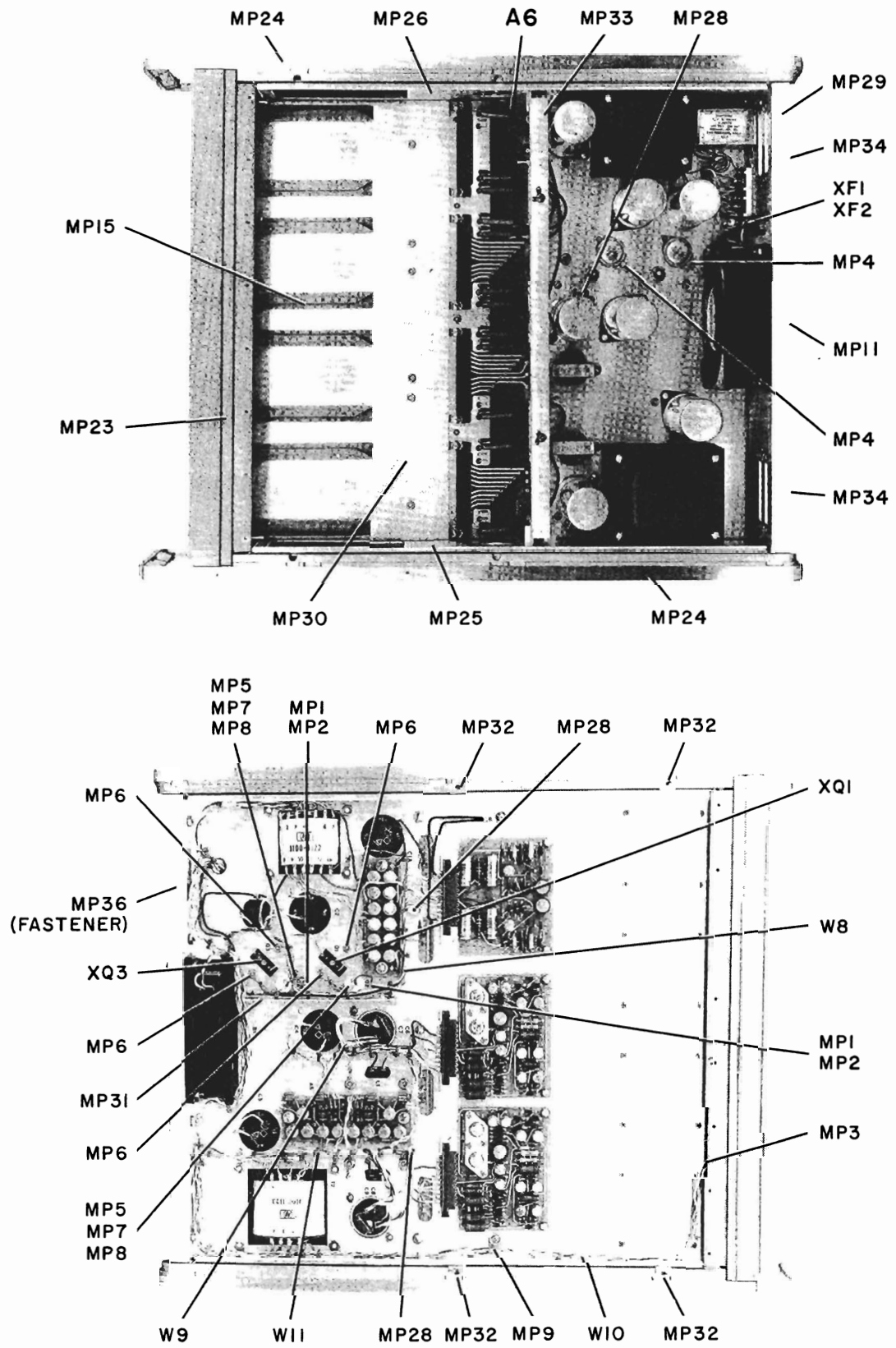

Figure 5-5. Adjustment Controls





1900A-R-6

Figure 6-1. Mechanical Parts

SECTION VI

REPLACEABLE PARTS

6-1. INTRODUCTION.

6-2. This section contains information for ordering replacement parts. The abbreviations used in the parts list are described in table 6-1. Table 6-2 lists the parts in alphanumeric order by reference designator and includes the manufacturer and manufacturer's part number. Table 6-3 contains the list of manufacturers' codes.

6-3. ORDERING INFORMATION.

6-4. To obtain replacement parts from Hewlett-Packard, address order or inquiry to the nearest Hewlett-Packard Sales/Service Office and supply the following information:

- a. Instrument model and serial number.
- b. HP part number of item(s).
- c. Quantity of part(s) desired.
- d. Reference designator of part(s).

6-5. To order a part not listed in the table, provide the following information:

- a. Instrument model and serial number.
- b. Description of the part, including function and location in the instrument.
- c. Quantity desired.

Table 6-1. Abbreviations for Replaceable Parts List

<p>A = ampere(s) ASSY = assembly</p> <p>BD = board(s) BH = binder head BP = bandpass</p> <p>C = centi (10^{-2}) CAR = carbon CCW = counterclockwise CER = ceramic CMO = cabinet mount only COAX = coaxial COEF = coefficient COMP = composition CONN = connector(s) CRT = cathode-ray tube CW = clockwise</p> <p>D = deci (10^{-1}) DEPC = deposited carbon DP = double pole DT = double throw</p> <p>ELECT = electrolytic ENCAP = encapsulated EXT = external</p> <p>F = farad(s) FET = field-effect transistor(s) FH = flat head FIL H = fillister head FXD = fixed</p> <p>G = giga (10^9) GE = germanium GL = glass</p>	<p>GRD = ground(ed)</p> <p>H = henry(ies) HG = mercury HP = Hewlett-Packard HZ = hertz</p> <p>IF = intermediate freq. IMPG = impregnated INCD = incandescent INCL = include(s) INS = insulation(ed) INT = internal</p> <p>K = kilo (10^3) KG = kilogram</p> <p>LB = pound(s) LH = left hand LIN = linear taper LOG = logarithmic taper LPF = low-pass filter(s) LVR = lever</p> <p>M = milli (10^{-3}) MEG = mega (10^6) MET FILM = metal film MET OX = metal oxide MFR = manufacturer MINAT = miniature MOM = momentary MTG = mounting MY = mylar</p> <p>N = nano (10^{-9}) N/C = normally closed NE = neon N/O = normally open</p>	<p>NPO = negative positive zero (zero temperature coefficient) NPN = negative-positive-negative NSR = not separately replaceable</p> <p>OBD = order by description OH = oval head OX = oxide</p> <p>P = peak PC = printed (etched) circuit(s) PF = picofarads PHL = Phillips PIV = peak inverse voltage(s) PNP = positive-negative-positive P/O = part of PORC = porcelain POS = position(s) POT = potentiometer(s) P-P = peak-to-peak PRGM = program PS = polystyrene PWV = peak working voltage</p> <p>RECT = rectifier(s) RF = radio frequency RFI = radio frequency interference RH = round head or right hand RMO = rack mount only RMS = root mean square</p>	<p>RWV = reverse working voltage</p> <p>S-B = slow-blow SCR = silicon controlled rectifier SE = selenium SEC = second(s) SECT = section(s) SI = silicon SIL = silver SL = slide SP = single pole SPL = special ST = single throw STD = standard</p> <p>TA = tantalum TD = time delay TFL = teflon TGL = toggle THYR = thyristor TI = titanium TNLDIO = tunnel diode(s) TOL = tolerance TRIM = trimmer</p> <p>U = micro (10^{-6})</p> <p>V = volts VAR = variable VDCW = dc working volt(s)</p> <p>W = watt(s) W/ = with WIV = working inverse voltage W/O = without WW = wirewound</p>
--	---	---	---

Table 6-2. Replaceable Parts

Reference Designation	HP Part Number	Qty	Description	Mfr Code	Mfr Part Number
A1	01900-66503		BOARD ASSY:-25V POWER SUPPLY	28480	01900-66503
A2	01900-66502		BOARD ASSY:VARIABLE POWER SUPPLY	28480	01900-66502
A3	01900-66502		BOARD ASSY:VARIABLE POWER SUPPLY	28480	01900-66502
A4	01900-66504		BOARD ASSY:25V RECTIFIER	28480	01900-66504
A5	01900-66505		BOARD ASSY:VAR. PWR SUPPLY PROTECTION	28480	01900-66505
A6	01901-66501		BOARD ASSY:MOTHER	28480	01901-66501
B1	3160-0097	1	FAN:TUBE AXIAL	23936	4500A
C1	0180-2377	1	C:FXD AL ELECT 2 X 5000 UF +100-10% 15V	28480	0180-2377
C2	0180-1934	2	C:FXD ELECT 2000 UF +75-10% 50VDCW	56289	D44888-DFP
C3	0180-1934		C:FXD ELECT 2000 UF +75-10% 50VDCW	56289	D44888-DFP
C4	0180-1933	2	C:FXD ELECT 1000 UF +75-10% 150VDCW	56289	D41355
C5	0180-1933		C:FXD ELECT 1000 UF +75-10% 150VDCW	56289	D41355
C6	0180-1983	2	C:FXD AL ELECT 650 UF +100-10% 100VDCW	56289	(32D)D44864-DQB
C7	0160-0168		C:FXD MY 0.1 UF 10% 200VDCW	56289	192P10492-PTS
C8	0180-1983		C:FXD AL ELECT 650 UF +100-10% 100VDCW	56289	(32D)D44864-DQB
C9	0160-0168		C:FXD MY 0.1 UF 10% 200VDCW	56289	192P10492-PTS
DS1	1450-0419	1	LIGHT:INDICATOR SELECTED NE-2H	28480	1450-0419
F1	2110-0303	1	FUSE:CARTRIDGE 2A 250V SLOW-BLOW (FOR 115V OPERATION)	71400	MDX-2A
F1	2110-0007	1	FUSE:CARTRIDGE 1 AMP 250V SLOW BLOW (FOR 230V OPERATION)	75915	313001
F2	2110-0380	1	FUSE:2.5 AMP AT 250 V SLOW-BLOW (FOR 115V OPERATION)	71400	MDA-2-1/2
F2	2110-0338	1	FUSE:1.6A AT 250V (FOR 230V OPERATION)	71400	MDX 1-6/10
FL1	9100-3327	1	FILTER:LINE	28480	9100-3327
J1			NSR P/O FL1		
L1	9100-2730	2	COIL:3.0 UH	28480	9100-2730
L2	9100-2730		COIL:3.0 UH	28480	9100-2730
MP1	0340-0037	1	POST:TERMINAL	28480	0340-0037
MP2	0340-0039	1	INSULATOR:BUSHING	28480	0340-0039
MP3	0510-1074	1	RETAINER:PUSH-ON FOR DS1	78553	C2326-012-24D
MP4	1200-0043	1	INSULATOR:TSTR MOUNTING(TO-3)	71785	293011
MP5	1200-0080	1	INSULATOR:TRANSISTOR MTG.	71785	294834
MP6	1200-0081	1	INSULATOR:BUSHING, NYLON	26365	974 307
MP7	1205-0007	1	HEAT DISSIPATOR:NUT	13103	1101-24-1(SPL)
MP8	1205-0008	1	HEAT DISSIPATOR:BODY	13103	1101-24-2
MP9	1400-0053	1	CLAMP:LOOP CABLE	95987	3/16-4
MP10	1490-0030	1	STAND:TILT	28480	1490-0030
MP11	3160-0205	1	FAN FILTER	28480	3160-0205
MP12	5000-0051	1	TRIM STRIP	28480	5000-0051
MP13	5000-8527	1	COVER:REAR SIDE	28480	5000-8527
MP14	5000-8529	1	COVER:FRONT SIDE	28480	5000-8529
MP15	5040-0483	8	GUIDE:PLUG-IN	28480	5040-0483
MP16	5060-8505	1	COVER:TOP	28480	5060-8505
MP17	5060-8513	1	COVER:BOTTOM	28480	5060-8513
MP18	5060-0222	2	HANDLE ASSY:SH SIDE	28480	5060-0222
MP19	5060-0767	5	FOOT ASSY:FM	28480	5060-0767
MP20	5060-8737	2	HANDLE:RETAINER	28480	5060-8737
MP21	0590-0777	4	INSERT:PULL-IN 10-32 UNF-28 THREAD	00000	08D
MP22	8160-0205	2	GASKET:R.F.I. SHIELD	07700	85-10500
MP23	01900-60505	1	FRAME:PANEL	28480	01900-60505
MP24	01900-60502	1	SIDE FRAME CASTING	28480	01900-60502
MP25	01900-60604	1	RFI SHIELD:RH	28480	01900-60604
MP26	01900-60603	1	RFI SHIELD:LH	28480	01900-60603
MP27	8160-0088		BRAID STRIP	00000	08D
MP28	01900-24701	1	BOTTOM RFI SHIELD, SPACER	28480	01900-24701
MP28	0160-2149	1	CLAMP:CAPACITOR	56289	4586-97A
MP29	01900-60202	1	PANEL ASSY:REAR	28480	01900-60202
MP30	01900-60101	1	DECK ASSY:MAIN	28480	01900-60101
MP31	01900-03101	1	BAFFLE:BOTTOM MAIN DECK	28480	01900-03101
MP32	0590-0053	8	NUT:CAPTIVE 6-32 GOLD CHROMATE	00000	08D
MP33	01900-01201	1	BRACKET:GUIDE PIN	28480	01900-01201
MP34	01900-04102	2	COVER PLATES:REAR PANEL	28480	01900-04102
MP35	01900-23101	3	GUIDE PIN FOR PLUG-IN	28480	01900-23101
MP36	0510-1073	14	FASTENER CLIP:STL	78553	C43294-014-24B
MP37	5060-8740	1	KIT:RACK MOUNT	28480	5060-8740
MP38	01900-63101	1	AIR DUCT ASSY	28480	01900-63101
MP39	01900-64101	1	COVER ASSY:RFI	28480	01900-64101
Q1	1854-0063	2	TSTR:SI NPN	80131	2N3055
Q2	1854-0090	2	TSTR:SI NPN(SIMILAR TO 2N3053)	28480	1854-0090
Q3	1854-0063		TSTR:SI NPN	80131	2N3055
Q4	1854-0090		TSTR:SI NPN(SIMILAR TO 2N3053)	28480	1854-0090
R1	0757-0044	1	R:FXD MET FLM 33.2K OHM 1% 1/2W	28480	0757-0044
S1	3101-0940	1	SWITCH:TOGGLE DPDT	28480	3101-0940

See introduction to this section for ordering information

Table 6-2. Replaceable Parts (Cont'd)

Reference Designation	HP Part Number	Qty	Description	Mfr Code	Mfr Part Number
T1	9100-1122	1	TRANSFORMER	28480	9100-1122
T2	9100-1123	1	TRANSFORMER	28480	9100-1123
W1	8120-1545	1	CABLE ASSY:AC POWER CORD 7.5 FT	70903	KH 7171
W2	01901-61603	3	CABLE ASSY:6 INCH	28480	01901-61603
W3	01901-61603		CABLE ASSY:6 INCH	28480	01901-61603
W4	01901-61603		CABLE ASSY:6 INCH	28480	01901-61603
W5	01901-61604	1	CABLE ASSY:9 INCH	28480	01901-61604
W6	01901-61605	1	CABLE ASSY:12 INCH	28480	01901-61605
W7	01901-61606	1	CABLE ASSY:17 INCH	28480	01901-61606
W8	01900-61601	1	CABLE ASSY:SUPPLY	28480	01900-61601
W9	01900-61602	1	CABLE ASSY:SUPPLY	28480	01900-61602
W10	01900-61614	1	CABLE ASSY:TRANSFORMER	28480	01900-61614
W11	01900-61615	1	CABLE ASSY:POWER	28480	01900-61615
XF1	1400-0084	2	FUSEHOLDER:EXTRACTOR POST TYPE	75915	342014
XF2	1400-0084	2	FUSEHOLDER:EXTRACTOR POST TYPE	75915	342014
XQ1	1200-0044	2	SOCKET-TRANSISTOR	97464	M7(P8)
XQ3	1200-0044		SOCKET-TRANSISTOR	97464	M7(P8)
A1	01900-66503	1	BOARD ASSY:-25V POWER SUPPLY	28480	01900-66503
A1C1	0180-0050	4	C:FXD ELECT 40 UF +75-10% 50VDCW	28480	0180-0050
A1C2	0180-0218	2	C:FXD ELECT 0.15 UF 10% 35VDCW	28480	0180-0218
A1C3	0160-0161	2	C:FXD MY 0.01 UF 10% 200VDCW	56289	192P10392-PTS
A1C4	0180-0050		C:FXD ELECT 40 UF +75-10% 50VDCW	28480	0180-0050
A1C5	0180-0050		C:FXD ELECT 40 UF +75-10% 50VDCW	28480	0180-0050
A1C6	0180-0218		C:FXD ELECT 0.15 UF 10% 35VDCW	28480	0180-0218
A1C7	0160-0161		C:FXD MY 0.01 UF 10% 200VDCW	56289	192P10392-PTS
A1C8	0180-0050		C:FXD ELECT 40 UF +75-10% 50VDCW	28480	0180-0050
A1C9	0180-0374	2	C:FXD TANT. 10 UF 10% 20VDCW	56289	150D106X902082-DYS
A1C10	0180-0374		C:FXD TANT. 10 UF 10% 20VDCW	56289	150D106X902082-DYS
A1CR1	1901-0049	2	DIODE:SILICON 50PIV	28480	1901-0049
A1CR2	1901-0025	20	DIODE:SILICON 100MA/1V	07263	FD 2387
A1CR3	1901-0025		DIODE:SILICON 100MA/1V	07263	FD 2387
A1CR4	1901-0049		DIODE:SILICON 50PIV	28480	1901-0049
A1CR5	1901-0025		DIODE:SILICON 100MA/1V	07263	FD 2387
A1CR6	1901-0025		DIODE:SILICON 100MA/1V	07263	FD 2387
A1CR7	1901-0025		DIODE:SILICON 100MA/1V	07263	FD 2387
A1CR8	1901-0025		DIODE:SILICON 100MA/1V	07263	FD 2387
A1MP1	1200-0185	21	PAD:TRANSISTOR MOUNTING	13103	7717-22N RED
A1Q1	1853-0031	2	TSTR:SI PNP(SELECTED FROM 2N1132)	28480	1853-0001
A1Q2	1854-0039	8	TSTR:SI NPN	80131	2N3053
A1Q3	1854-0071	2	TSTR:SI NPN(SELECTED FROM 2N3704)	28480	1854-0071
A1Q4	1853-0001		TSTR:SI PNP(SELECTED FROM 2N1132)	28480	1853-0001
A1Q5	1854-0039		TSTR:SI NPN	80131	2N3053
A1Q6	1854-0071		TSTR:SI NPN(SELECTED FROM 2N3704)	28480	1854-0071
A1R1	0757-0408	2	R:FXD MET FLM 243 OHM 1% 1/8W	28480	0757-0408
A1R2	0698-4285	2	R:FXD FLM 20K OHM 5% 1/8W	28480	0698-4285
A1R3	0698-4254	2	R:FXD FLM 1K OHM 5% 1/8W	28480	0698-4254
A1R4	0811-1659	2	R:FXD WW 0.27 OHM 5% 2W	28480	0811-1659
A1R5	0757-0431	2	R:FXD MET FLM 2.43K OHM 1% 1/8W	28480	0757-0431
A1R6	0757-0428	2	R:FXD MET FLM 1.62K OHM 1% 1/8W	28480	0757-0428
A1R7	2100-1772	2	R:VAR WW 500 OHM 5% TYPE H 1W	28480	2100-1772
A1R8	0757-0427	2	R:FXD MET FLM 1.5K OHM 1% 1/8W	28480	0757-0427
A1R9	0757-0408		R:FXD MET FLM 243 OHM 1% 1/8W	28480	0757-0408
A1R10	0698-4285		R:FXD FLM 20K OHM 5% 1/8W	28480	0698-4285
A1R11	0698-4254		R:FXD FLM 1K OHM 5% 1/8W	28480	0698-4254
A1R12	0811-1659		R:FXD WW 0.27 OHM 5% 2W	28480	0811-1659
A1R13	0757-0431		R:FXD MET FLM 2.43K OHM 1% 1/8W	28480	0757-0431
A1R14	0757-0428		R:FXD MET FLM 1.62K OHM 1% 1/8W	28480	0757-0428
A1R15	2100-1772		R:VAR WW 500 OHM 5% TYPE H 1W	28480	2100-1772
A1R16	0757-0427		R:FXD MET FLM 1.5K OHM 1% 1/8W	28480	0757-0427
A1VR1	1902-0018	4	DIODE BREAKDOWN:11.7V 5%	04713	1N941
A1VR2	1902-0018		DIODE BREAKDOWN:11.7V 5%	04713	1N941
A2	01900-66502	2	BOARD ASSY:VARIABLE POWER SUPPLY	28480	01900-66502
A2C1	0160-0168	10	C:FXD MY 0.1 UF 10% 200VDCW	56289	192P10492-PTS
A2C2	0160-0301	2	C:FXD MY 0.012 UF 10% 200VDCW	56289	192P12392-PTS
A2C3	0180-0376	2	C:FXD ELECT 0.47 UF 10% 35VDCW	56289	150D474X9035A2-DYS
A2C4	0160-0168		C:FXD MY 0.1 UF 10% 200VDCW	56289	192P10492-PTS
A2C5	0160-0168		C:FXD MY 0.1 UF 10% 200VDCW	56289	192P10492-PTS
A2C6	0140-0149	3	C:FXD MICA 470 PF 5%	72136	DM15F471J3S
A2C7	0160-0168		C:FXD MY 0.1 UF 10% 200VDCW	56289	192P10492-PTS
A2CR1	1901-0025		DIODE:SILICON 100MA/1V	07263	FD 2387
A2CR2	1901-0025		DIODE:SILICON 100MA/1V	07263	FD 2387
A2CR3	1901-0025		DIODE:SILICON 100MA/1V	07263	FD 2387

See introduction to this section for ordering information

Table 6-2. Replaceable Parts (Cont'd)

Reference Designation	HP Part Number	Qty	Description	Mfr Code	Mfr Part Number
A2CR4	1901-0025		DIODE:SILICON 100MA/1V	07263	FD 2387
A2CR5	1901-0025		DIODE:SILICON 100MA/1V	07263	FD 2387
A2CR6	1901-0025		DIODE:SILICON 100MA/1V	07263	FD 2387
A2CR7	1901-0025		DIODE:SILICON 100MA/1V	07263	FD 2387
A2CR8	1901-0507	2	DIODE:SI 200 WIV	28480	1901-0507
A2MP1	1200-0185		PAD:TRANSISTOR MOUNTING	13103	7717-22N RED
A2Q1	1853-0037	2	TSTR:SI PNP	04713	SS 2109
A2Q2	1854-0039		TSTR:SI NPN	80131	2N3053
A2Q3	1854-0039		TSTR:SI NPN	80131	2N3053
A2Q4	1854-0022	6	TSTR:SI NPN	07263	S17843
A2Q5	1854-0022		TSTR:SI NPN	07263	S17843
A2Q6	1854-0022		TSTR:SI NPN	07263	S17843
A2Q7	1854-0232	4	TSTR:SI NPN(SELECTED FROM 2N3440)	28480	1854-0232
A2Q8	1854-0232		TSTR:SI NPN(SELECTED FROM 2N3440)	28480	1854-0232
A2Q9	1853-0240	2	TSTR:SI PNP	04713	SS1139K
A2Q10	1854-0341	4	TSTR:SI NPN	28480	1854-0341
A2Q11	1854-0341		TSTR:SI NPN	28480	1854-0341
A2Q12	1854-0039		TSTR:SI NPN	80131	2N3053
A2K1	0758-0045	2	R:FXD MET OX 3900 OHM 5% 1/2W	28480	0758-0045
A2R2	0757-0920	2	R:FXD FLM 680 OHM 2% 1/8W	28480	0757-0920
A2R3	0757-0927	4	R:FXD FLM 1.3K OHM 2% 1/8W	28480	0757-0927
A2R4	0757-0954	2	R:FXD FLM 18K OHM 2% 1/8W	28480	0757-0954
A2R5	0757-0934	2	R:FXD FLM 2.7K OHM 2% 1/8W	28480	0757-0934
A2R6	0757-0924	4	R:FXD MET FLM 1K OHM 2% 1/8W	28480	0757-0924
A2R7	0757-0943	4	R:FXD FLM 6.2K OHM 2% 1/8W	28480	0757-0943
A2R8	0757-0951	2	R:FXD FLM 13K OHM 2% 1/8W	28480	0757-0951
A2R9	0757-0927		R:FXD FLM 1.3K OHM 2% 1/8W	28480	0757-0927
A2R10	0698-3159	4	R:FXD MET FLM 26.1K OHM 1% 1/8W	28480	0698-3159
A2R11	0757-0943		R:FXD FLM 6.2K OHM 2% 1/8W	28480	0757-0943
A2R12	0698-3159		R:FXD MET FLM 26.1K OHM 1% 1/8W	28480	0698-3159
A2R13	0811-1665	2	R:FXD WW 0.82 OHM 5% 2W	28480	0811-1665
A2R14	0757-0917	2	R:FXD FLM 510 OHM 2% 1/8W	28480	0757-0917
A2R15	0698-4313	4	R:FXD MET FLM 2K OHM 1.0% 1/2W	28480	0698-4313
A2R16	0698-4313		R:FXD MET FLM 2K OHM 1.0% 1/2W	28480	0698-4313
A2R17	2100-1774	2	R:VAR WW 2K OHM 5% TYPE H 1W	28480	2100-1774
A2R18	0757-0438	2	R:FXD MET FLM 5.11K OHM 1% 1/8W	28480	0757-0438
A2R19	0757-0924		R:FXD MET FLM 1K OHM 2% 1/8W	28480	0757-0924
A2R20	0728-0004	4	R:FXD DEPC ALLY FLM 1 OHM 5% 1/2W	28480	0728-0004
A2R21	0728-0004		R:FXD DEPC ALLOY FLM 1 OHM 5% 1/2W	28480	0728-0004
A2R22	0757-0900	2	R:FXD MET FLM 100 OHM 2% 1/8W	28480	0757-0900
A2R23	0698-6743	4	R:FXD FLM 1.37 OHM 1% 1/2W	28480	0698-6743
A2R24	0698-6743		R:FXD FLM 1.37 OHM 1% 1/2W	28480	0698-6743
A2VR1	1902-0556	4	DIODE:BREAKDOWN 20.0V 5% 1W	28480	1902-0556
A2VR2	1902-0556		DIODE:BREAKDOWN 20.0V 5% 1W	28480	1902-0556
A2VR3	1902-0025	2	DIODE:BREAKDOWN:10.0V 5% 400 MW	28480	1902-0025
A2VR4	1902-3171	2	DIODE BREAKDOWN:11.0V 5%	28480	1902-3171
A2VR5	1902-0018		DIODE BREAKDOWN:11.7V 5%	04713	1N941
A3	01900-66502		BOARD ASSY:VARIABLE POWER SUPPLY SAME AS A2; USE PREFIX A3	28480	01900-66502
A4	01900-66504	1	BOARD ASSY:25V RECTIFIER	28480	01900-66504
A4CR1	1901-0200	14	DIODE:SILICON 100 PIV 3A	02735	1N4998
A4CR2	1901-0200		DIODE:SILICON 100 PIV 3A	02735	1N4998
A4CR3	1901-0200		DIODE:SILICON 100 PIV 3A	02735	1N4998
A4CR4	1901-0200		DIODE:SILICON 100 PIV 3A	02735	1N4998
A4CR5	1901-0200		DIODE:SILICON 100 PIV 3A	02735	1N4998
A4CR6	1901-0200		DIODE:SILICON 100 PIV 3A	02735	1N4998
A4CR7	1901-0200		DIODE:SILICON 100 PIV 3A	02735	1N4998
A4CR8	1901-0200		DIODE:SILICON 100 PIV 3A	02735	1N4998
A4CR9	1901-0200		DIODE:SILICON 100 PIV 3A	02735	1N4998
A4CR10	1901-0200		DIODE:SILICON 100 PIV 3A	02735	1N4998
A4CR11	1901-0200		DIODE:SILICON 100 PIV 3A	02735	1N4998
A4CR12	1901-0200		DIODE:SILICON 100 PIV 3A	02735	1N4998
A4MP1	0340-0435	18	INSULATOR:DIODE 0.125" ID	28480	0340-0435
A5	01900-66505	1	BOARD ASSY:VAR. PWR SUPPLY PROTECTION	28480	01900-66505
A5CR1	1901-0416	8	DIODE:SILICON 200PIV 3A	28480	1901-0416
A5CR2	1901-0416		DIODE:SILICON 200PIV 3A	28480	1901-0416
A5CR3	1901-0416		DIODE:SILICON 200PIV 3A	28480	1901-0416
A5CR4	1901-0416		DIODE:SILICON 200PIV 3A	28480	1901-0416
A5CR5	1901-0416		DIODE:SILICON 200PIV 3A	28480	1901-0416
A5CR6	1901-0416		DIODE:SILICON 200PIV 3A	28480	1901-0416
A5CR7	1901-0416		DIODE:SILICON 200PIV 3A	28480	1901-0416
A5CR8	1901-0416		DIODE:SILICON 200PIV 3A	28480	1901-0416
A5CR9	1901-0200		DIODE:SILICON 100 PIV 3A	02735	1N4998
A5CR10	1901-0200		DIODE:SILICON 100 PIV 3A	02735	1N4998
A5CR11	1884-0064	2	THYRISTOR:GE 200 PEAK REVERSE VOLTAGE	03508	C106841

See introduction to this section for ordering information

Table 6-2. Replaceable Parts (Cont'd)

Reference Designation	HP Part Number	Qty	Description	Mfr Code	Mfr Part Number
A5CR12	1884-0064	2	THYRISTOR:GE 200 PEAK REVERSE VOLTAGE	03508	C106841
A5F1	2110-0002		FUSE:CARTRIDGE 2 AMP 3 AG	75915	312.002
A5F2	2110-0002	2	FUSE:CARTRIDGE 2 AMP 3 AG	75915	312.002
A5R1	0757-0093		R:FXD FLM 39K OHM 2% 1/4W	28480	0757-0093
A5R2	0727-0445	2	R:FXD DEPC ALLJY FLM 2 OHM 1% 1/2W	28480	0727-0445
A5K3	0698-4252	2	R:FXD FLM 820 OHM 5% 1/8W	28480	0698-4252
A5R4	0757-0093		R:FXD FLM 39K OHM 2% 1/4W	28480	0757-0093
A5R5	0727-0445	2	R:FXD DEPC ALLJY FLM 2 OHM 1% 1/2W	28480	0727-0445
A5R6	0698-4252		R:FXD FLM 820 OHM 5% 1/8W	28480	0698-4252
A5VR1	1902-3394	2	DIODE BREAKDOWN:75 V 2%	28480	1902-3394
A5VR2	1902-3394	4	DIODE BREAKDOWN:75 V 2%	28480	1902-3394
A5XF1	2110-0269		CLIP:FUSE 0.250" DIA	91506	6008-32CN
A6	01901-66501	1	BOARD ASSY:MOTHER	28480	01901-66501
A6J1	1251-2091	4	CONNECTOR:PC(1 X 15) 15 CONTACT	95354	178-118-181
A6J2	1251-2091	32	CONNECTOR:PC(1 X 15) 15 CONTACT	95354	178-118-181
A6J3	1251-2091		CONNECTOR:PC(1 X 15) 15 CONTACT	95354	178-118-181
A6J4	1251-2091		CONNECTOR:PC(1 X 15) 15 CONTACT	95354	178-118-181
A6J5	0360-1560		TERMINAL PIN:BRASS	28480	0360-1560
A6J6	0360-1560		TERMINAL PIN:BRASS	28480	0360-1560
A6J7	0360-1560		TERMINAL PIN:BRASS	28480	0360-1560
A6J8	0360-1560	TERMINAL PIN:BRASS	28480	0360-1560	
A6J9	0360-1560	TERMINAL PIN:BRASS	28480	0360-1560	
A6J10	0360-1560	TERMINAL PIN:BRASS	28480	0360-1560	
A6J11	0360-1560	TERMINAL PIN:BRASS	28480	0360-1560	
A6J12	0360-1560	TERMINAL PIN:BRASS	28480	0360-1560	
A6J13	0360-1560	TERMINAL PIN:BRASS	28480	0360-1560	
A6J14	0360-1560	TERMINAL PIN:BRASS	28480	0360-1560	
A6J15	0360-1560	TERMINAL PIN:BRASS	28480	0360-1560	
A6J16	0360-1560	TERMINAL PIN:BRASS	28480	0360-1560	
A6J17	0360-1560	TERMINAL PIN:BRASS	28480	0360-1560	
A6J18	0360-1560	TERMINAL PIN:BRASS	28480	0360-1560	
A6J19	0360-1560	TERMINAL PIN:BRASS	28480	0360-1560	
A6J20	0360-1560	TERMINAL PIN:BRASS	28480	0360-1560	
A6MP1	01900-09101	8	SPRING	28480	01900-09101

Table 6-3. List of Manufacturers' Codes

MFR NO.	MANUFACTURER NAME	ADDRESS	ZIP CODE
00000	U.S.A. COMMON	ANY SUPPLIER OF U.S.A.	
02735	RCA SOLID STATE & RECEIVING TUBE DIV.	SOMERVILLE, N.J.	08876
03508	G.E. CO. SEMICONDUCTOR PROD. DEPT.	SYRACUSE, N.Y.	13201
04713	MOTOROLA SEMICONDUCTOR PROD. INC.	PHOENIX, ARIZ.	85008
07263	FAIRCHILD CAMERA & INST. CORP. SEMICONDUCTOR DIV.	MOUNTAIN VIEW, CALIF.	94040
07700	TECHNICAL WIRE PROD. INC.	CRANFORD, N.J.	07016
13103	THERMALLOY CO.	DALLAS, TEX.	75247
26365	GKIES REPRODUCER CORP.	NEW ROCHELLE, N.Y.	10802
28480	HEWLETT-PACKARD COMPANY	PALO ALTO, CALIF.	94304
56289	SPRAGUE ELECTRIC CO.	N. ADAMS, MASS.	01247
70903	BELDEN CORP.	CHICAGO, ILL.	60644
71400	BUSSMANN MFG. DIV. MC GRAW-EDISON CO.	ST. LOUIS, MO.	63017
71785	CINCH MFG. CO. CIV TRW INC.	ELK GROVE VILLAGE, ILL.	
72136	ELECTRO MOTIVE MFG. CO. INC.	WILLIMANTIC, CONN.	06226
75915	LITTELFUSE INC.	DES PLAINES, ILL.	60016
78553	TINNERMAN PROD. INC.	CLEVELAND, OHIO	44129
80131	ELECTRONIC INDUSTRIES ASSOCIATION	WASHINGTON D.C.	20006
91506	AUGAT INC.	ATTLEBURG, MASS.	02703
95354	METHODE MFG. CO.	ROLLING MEADOWS, ILL.	60008
95987	WEKESSEY CO. INC.	CHICAGO, ILL.	60641
97464	INDUSTRIAL RETAINING RING CO.	IRVINGTON, N.J.	07111

See introduction to this section for ordering information

SECTION VII MANUAL CHANGES AND OPTIONS

7-1. INTRODUCTION.

7-2. This section contains information required to back-date or update this manual for a specific instrument. Descriptions of special options and standard options are also in this section.

7-3. MANUAL CHANGES.

7-4. This manual applies directly to the instrument having the same serial prefix shown on the manual title page. If the serial prefix of the instrument is not the same as the one on the title page, find your serial prefix in table 7-1 and make the changes to the manual that are listed for that serial prefix. When making changes listed in table 7-1, make the change with the highest number first. Example: If backdating changes 1, 2, and 3 are required for your serial prefix, do change 3 first, then change 2, and finally change 1. If the serial prefix of the instrument is not listed either in the title page or in table 7-1, refer to an enclosed MANUAL CHANGES sheet for updating information. Also, if a MANUAL CHANGES sheet is supplied, make all indicated ERRATA corrections.

Table 7-1. Manual Changes

Serial Prefix	Make Changes
831, 924	1 through 8
931	2 through 8
938	3 through 8
955	4 through 8
971	5 through 8
1101A	6 through 8
1120A	7 and 8
1140A	8

CHANGE 1

Table 6-2,
A2Q9, A3Q9: Change to HP Part No. 1853-0038.

CHANGE 2

Table 6-2,
A1C2, A1C6: Change to HP Part No. 0160-0161;
C: fxd my .01 uF 10% 200 wVdc.
Figure 8-9,
A1C2, A1C6: Change value to .01 uF.

CHANGE 3

Table 6-2,
Q2, Q4: Change to HP Part No. 1854-0039; Q: Si npn.
A1Q2, A1Q5: Change to HP Part No. 1854-0071;
Q: Si npn.

CHANGE 4

Table 6-2,
S1: Change to HP Part No. 3101-0163; S: Power, toggle.
W10: Change to HP Part No. 01900-61604.
W11: Change to HP Part No. 01900-61603.

CHANGE 5

Table 6-2,
A6: Change to HP Part No. 01900-66501; A: Mother Board Assy.
Add: HP Part No. 01900-61606; TQ2; Cable, coaxial, 6-inch. (Used on A6.)
W2 thru W7: Delete.

CHANGE 6

Table 6-2,
C1A, C1B: Change to HP Part No. 0180-2152; C: fxd elect 2000 uF 15 wVdc and 2000 uF 30 wVdc.
Figure 8-7,
C1A, C1B: Change value to 2000 uF.

CHANGE 7

Table 6-2,
A1Q1, A1Q4: Change to HP Part No. 1853-0036;
Q: Si npn.

CHANGE 8

Table 6-2,
FL1: Change to HP Part No. 9100-2482; Filter: Line.

MP13: Change to HP Part No. 5000-0098; Cover, rear side, blue-gray.
MP14: Change to HP Part No. 5000-0099; Cover, front side, blue-gray.
MP16: Change to HP Part No. 5060-0060; Cover assy, top, blue-gray.
MP17: Change to HP Part No. 5060-0064; Cover assy, bottom, blue-gray.

MP20: Change to HP Part No. 5060-0776; Retainer, handle, blue-gray.
 MP23: Change to HP Part No. 01900-60501; Frame, panel, light gray.
 MP29: Change to HP Part No. 01900-60201; Panel assy, rear.
 MP37: Change to HP Part No. 5060-0775; Kit, rack mount, light gray.
 S2: Change to HP Part No. 3101-0034; S:Slide, 4 pdt.
 W1: Change to HP Part No. 8120-0078; W: Power cord, 7.5 ft.

W14: HP Part No. 01900-61609, CABLE ASSY, Mfr. Code 28480, Mfr. Part No. 01900-61609.
 W15: HP Part No. 01900-61607, CABLE ASSY, Mfr. Code 28480, Mfr. Part No. 01900-61607.
 J2, J3, J4, J5: HP Part No. 1251-0084, PLUG: 36-CONTACT MALE W/HOOD AND CLAMP, Mfr. Code 28480, Mfr. Part No. 1251-0084.

b. Add the following note to Section II between paragraphs 2-2 and 2-3.

Note

Installation instructions for Option 001 are provided in Section VII.

7-5. SPECIAL OPTIONS.

7-6. Most customer special application requirements and/or specifications can be met by factory modification of a standard instrument. A standard instrument modified in this way will carry a special option number, such as Model 0000A/Option C01.

7-7. An operating and service manual and a manual insert are provided with each special option instrument. The operating and service manual contains information about the standard instrument. The manual insert for the special option describes the factory modifications required to produce the special option instrument. Amend the operating and service manual by changing it to include all manual insert information (and MANUAL CHANGES sheet information, if applicable). When these changes are made, the operating and service manual will apply to the special option instrument.

7-8. If you have ordered a special option instrument and the manual insert is missing, notify the nearest Hewlett-Packard Sales/Service Office. Be sure to give a full description of the instrument, including the complete serial number and special option number.

7-9. STANDARD OPTIONS.

7-10. Standard options are modifications installed on HP instruments at the factory and are available on request. Contact the nearest Hewlett-Packard Sales/Service Office for information concerning standard options.

7-11. OPTION 001.

7-12. DIGITAL AND ANALOG PROGRAMMING. Option 001 provides cabling and connectors to permit external programming of programmable plug-ins. See figure 7-1 for details of the programming interconnections. Option 001 is available as a kit (HP Part No. 01900-69502) for field installation. To adapt this manual to cover Model 1900A Option 001, make the following changes to the manual:

- a. Add the following parts to table 6-2:

W12, W13: HP Part No. 01900-61605, CABLE ASSY, Mfr. Code 28480, Mfr. Part No. 01900-61605.

Note

All connectors on cable assemblies must be installed with pins 1 through 18 toward top of mainframe.

- a. Remove top covers from mainframe.
- b. Connect W12 from rear-panel position J5 to center-channel position J9.
- c. Connect W13 from rear-panel position J7 to center-channel position J11.
- d. Connect W15 from rear-panel position J6 to center-channel position J10.
- e. Connect W14 from rear-panel position J8 to center-channel position J12.

7-14. OPTION 002.

7-15. SLIDE MOUNT. Option 002 provides the hardware for slide mounting Model 1900A, permitting quick access for inspection and servicing. Option 002 is available as a kit (HP Part No. 01900-69501) for field installation. To adapt this manual to cover Model 1900A Option 002, make the following changes to the manual:

- a. Add the following parts to table 6-2:

MP40: HP Part No. 1490-0918, SLIDE: NON-PIVOTING RIGHT AND LEFT, Mfr. Code 28480, Mfr. Part No. 1490-0918.

MP41: HP Part No. 01900-01207, BRACKET: MOUNTING RIGHT AND LEFT, Mfr. Code 28480, Mfr. Part No. 01900-01207.

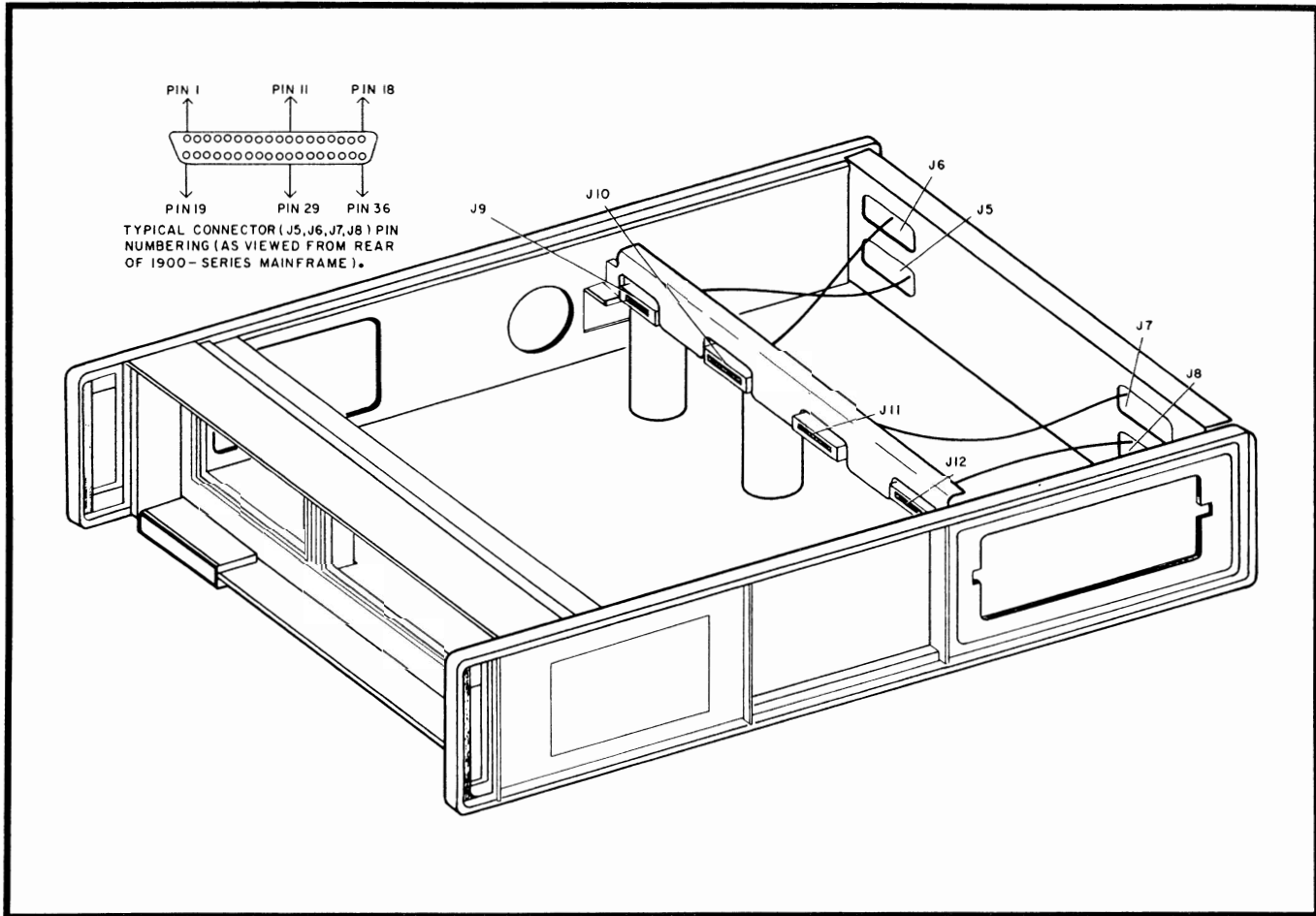

Figure 7-1. Programming Interconnections

b. Add the following note to Section II between paragraphs 2-2 and 2-3.

Note

Installation instructions for Option 002 are provided in Section VII.

7-16. **INSTALLATION.** The slides are mounted onto the cabinet with hardware provided. Details of the installation depend on the type of cabinet used. The brackets are mounted onto the sides of Model 1900A. To install the mounting brackets, proceed as follows:

- a. Remove handles from Model 1900A. Retain mounting screws.
- b. Mount brackets to position previously occupied by handles using handle mounting screws.
- c. Using hardware provided, attach brackets (and Model 1900A) to slides. Provision is made for adjusting position of slides in relation to brackets by providing each bracket with three sets of threaded holes.

Note

The slides should not be lubricated.

7-17. OPTION 007.

7-18. Option 007 provides connections for external input, gate input, trigger output, and pulse output between plug-ins and Model 1900A rear terminal connectors. To adapt this manual to cover Option 007, make the following changes to table 6-2:

- MP29: Change to HP Part No. 01900-60203.
- Add: MP40; HP Part No. 01900-01208, BRACKET: CONNECTOR (MOUNTING FOR MP41), Mfr. Code 28480, Mfr. Part No. 01900-01208.
- Add: MP41; HP Part No. 01900-61616, CABLE ASSY: PULSE OUTPUT, Mfr. Code 28480, Mfr. Part No. 01900-61616.
- Add: MP42, MP43: HP Part No. 01900-61617, CABLE ASSY: EXTERNAL INPUT, GATE INPUT, Mfr. Code 28480, Mfr. Part No. 01900-61617.

Add: MP44; HP Part No. 01928-61601, CABLE ASSY: TRIGGER OUTPUT, Mfr. Code 28480, Mfr. Part No. 01928-61601.

Add: MP45, MP46, MP47; HP Part No. 1250-0083, CONNECTOR: BNC, Mfr. Code 02660, Mfr. Part No. 31-221-1020.

7-19. OPTION X95.

7-20. Option X95 provides blue-gray covers for Model 1900A. To adapt this manual to cover the Model 1900A Option X95, make the following changes to table 6-2:

MP13: Change to HP Part No. 5000-0098, COVER: REAR SIDE BLUE-GRAY. Mfr. Code 28480, Mfr. Part No. 5000-0098.

MP14: Change to HP Part No. 5000-0099, COVER:

FRONT SIDE BLUE-GRAY, Mfr. Code 28480, Mfr. Part No. 5000-0099.

MP16: Change to HP Part No. 5060-0060, COVER ASSY: TOP BLUE-GRAY, Mfr. Code 28480, Mfr. Part No. 5060-0060.

MP17: Change to HP Part No. 5060-0064, COVER ASSY: BOTTOM BLUE-GRAY, Mfr. Code 28480, Mfr. Part No. 5060-0064.

MP20: Change to HP Part No. 5060-0776, RETAINER: HANDLE BLUE-GRAY, Mfr. Code 28480, Mfr. Part No. 5060-0776.

MP23: Change to HP Part No. 01900-60501, FRAME: PANEL LIGHT GRAY, Mfr. Code 28480, Mfr. Part No. 01900-60501.

MP38: Change to HP Part No. 5060-0775, KIT: RACK MOUNT LIGHT GRAY, Mfr. Code 28480, Mfr. Part No. 5060-0775.

SECTION VIII

SCHEMATICS AND TROUBLESHOOTING

8-1. INTRODUCTION.

8-2. This section contains schematics, repair and replacement information, component-identification illustrations, waveforms, test conditions, and preventive maintenance information. Table 8-1 provides a guide to locating possible problems. Table 8-2 defines symbols and conventions used on the schematics.

8-3. SCHEMATICS.

8-4. Schematics are printed on foldout pages for easy reference to the text and figures in other sections. The schematics are drawn to show the electronic function of the circuits. Any one schematic may include all or part of several different physical assemblies. Non MIL-standard symbols and conventions used in the schematics are defined in table 8-2.

8-5. A table on each schematic lists all components shown on the schematic by reference designation. Component reference designators which have been deleted from the schematic are listed below the table.

8-6. All components within the shaded areas of a schematic are physically located on etched circuit boards. Components not physically located on an etched circuit board are shown in the unshaded areas of the schematic.

8-7. REFERENCE DESIGNATIONS.

8-8. The unit system of reference designations used in this manual is in accordance with the provisions of USA Standard Y32.16-1968, Reference Designations for Electrical and Electronics Parts and Equipments, dated March 1, 1968. Minor variations from the standard, due to design and manufacturing practices, may be noted.

8-9. Each electrical component is assigned a class letter and number. This letter-number combination is the basic reference designation. Components which are not part of an assembly have only the basic reference designation. Components which are part of an assembly have in addition to the basic designation, a prefix designation indicating the assembly of which the component is a part (resistor R23 on assembly A1 is called A1R23).

8-10. Assemblies are numbered consecutively. If an assembly reference designation has been assigned and is later deleted, that designation is not reused.

8-11. COMPONENT LOCATIONS.

8-12. Locations of components on assemblies and subassemblies are illustrated in photos adjacent to the schematics. Since the schematics are drawn to show function, portions of a particular assembly may appear on several different schematics. The component-location photo is printed next to the schematic that shows most of the circuitry on the assembly. Components located on the chassis are identified in photographs located in this section and in Section VI. The locations of all adjustments are shown in Section V.

8-13. PREVENTIVE MAINTENANCE.

8-14. COOLING BLOWER.

8-15. About twice a year, place two or three drops of high-grade, light-weight machine oil on the fan blade shaft bearing support. To lubricate the shaft, proceed as follows:

- a. Remove all plug-ins from mainframe.
- b. Locate access hole to fan-motor bearing supports.

Note

A paper label covers fan motor bearing support area.

- c. Using hypodermic syringe containing high-grade, light-weight machine oil, penetrate center of paper label and thin rubber seal beneath.
- d. Inject two or three drops of oil. Do not over-lubricate.
- e. Reinstall plug-ins in mainframe.

8-16. FILTER MAINTENANCE.

8-17. This instrument uses a wire-mesh air filter over the cooling blower. If the filter

becomes clogged with dirt, the blower will not provide adequate cooling for the instrument. Check the filter periodically and clean it when necessary. To clean, remove the filter and use a warm soap and water solution. Rinse the filter in clear water and allow it to dry before re-installing. A brush or pressurized air source may be used to remove excess dust and dirt.

8-18. REPAIR AND REPLACEMENT.

8-19. SEMICONDUCTOR REPLACEMENT.

8-20. Figure 8-1 is included to help identify the leads in the common shapes and sizes of semiconductor devices. When removing a semiconductor, use long-nosed pliers as a heat sink between the device and the soldering iron. When replacing a semiconductor, ensure sufficient lead length to dissipate the soldering heat by using the same length of exposed lead as was used for the original part.

8-21. BOARD CONNECTIONS.

8-22. Square-pin connectors are identified on circuit boards by the color code of the connecting wire. Connector pins on plugs and jacks are identified by a number. Wires soldered for connection are identified by the color code of the connecting wire.

8-23. SERVICING ETCHED CIRCUIT BOARDS.

8-24. This instrument uses etched circuit boards with plated-through component holes. This allows components to be removed or replaced by unsoldering or soldering from either side of the board. When removing large components, such as potentiometers, rotate the soldering iron tip from lead to lead while applying pressure to the part to lift it from the board. HP Service Note M-20E contains additional information on the repair of etched circuit boards.

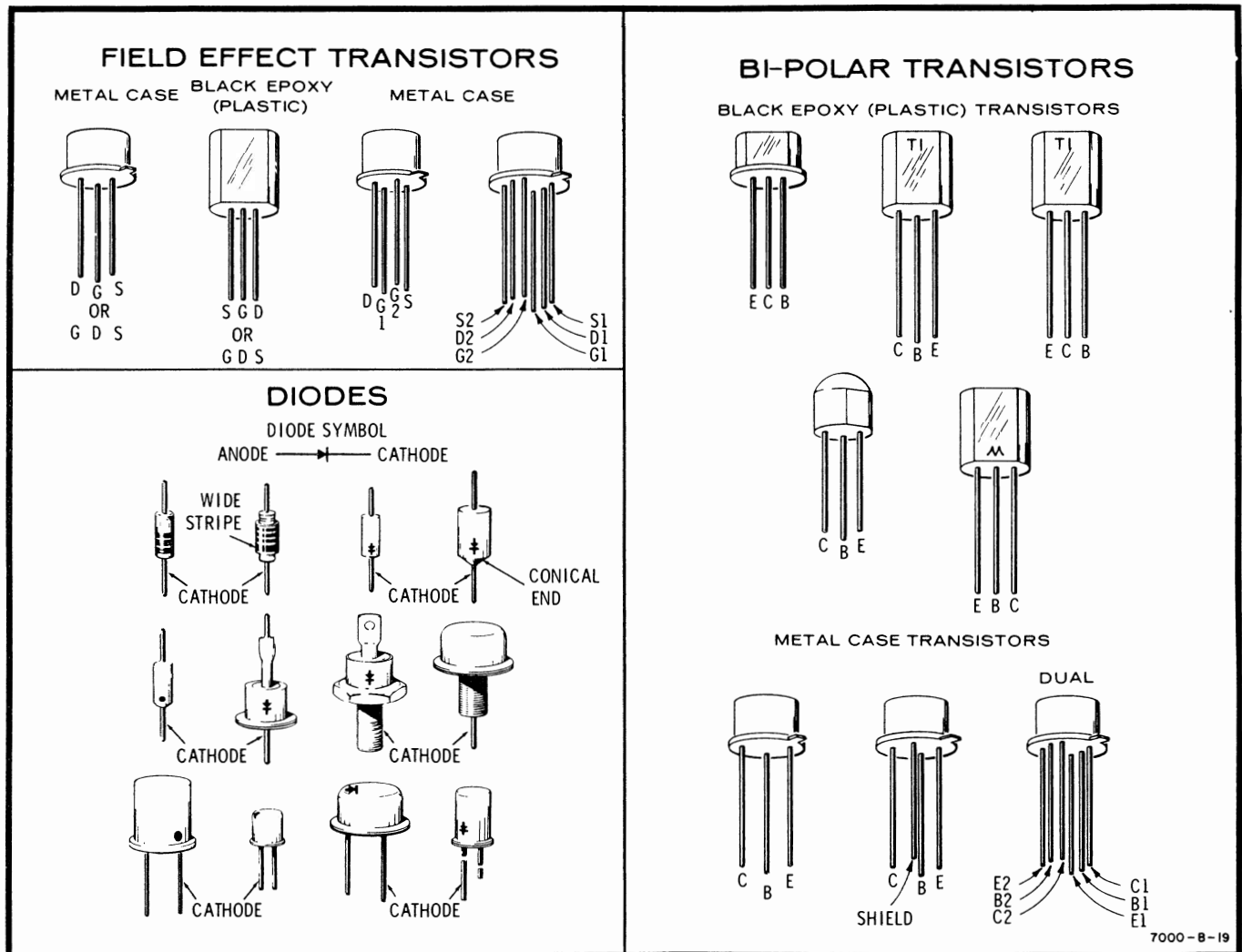

Figure 8-1. Semiconductor Terminal Identification

Table 8-1. Troubleshooting guide

Symptom	Check
Lamp DS1 does not light when power switch S1 is set to on.	Check external power source. check rear-panel fuse F2. Check position of rear-panel switch S2.
Fuse F1 or F2 on assembly A5 opens when ac power is applied.	Check associated power supply circuit (Q2, Q9, Q10, and Q11). Check associated SCR on assembly A5.
No output from either 25-volt power supply.	Check rear-panel fuse F1.
No output from one 25-volt power supply.	Check associated series regulator transistors. Check associated voltage regulator circuit.
Output low or high from one 25-volt power supply.	Check adjustment of power supply. Check associated series regulator transistors on chassis. Check associated reference diode (VR1 and VR2) for correct voltage regulation.
No output from either variable power supply.	Check rear-panel fuse F2.
No output from one variable power supply.	Check associated fuse on assembly A5. Check associated power supply circuit.
Output low or high from one variable power supply.	Check adjustment of power supply. Check reference diode VR5 for correct voltage regulation.
Output square wave at circuit card pin 3 drops to about 7 volts.	Check VR5 using a curve tracer. (Ohmmeter Checks will indicate an open in both directions on a normal VR5.)

8-25. TROUBLESHOOTING.

8-26. The most important prerequisite for successful troubleshooting is understanding how the instrument is designed to operate. Before doing the test and/or troubleshooting procedures, read Section III (Operation) for an explanation of general operating considerations, and Section IV (Principles of Operation) for an explanation of circuit theory.

8-27. If trouble is suspected, visually inspect the instrument. Look for loose or burned components that might suggest a source of trouble. Check to see that all circuit board connections are making good contact. If no obvious trouble is found, check the power supply voltages in the unit. Prior to any extensive troubleshooting, check the external power sources also. Table 8-1 lists some of the most common malfunctions and probable sources of trouble.

8-28. DC VOLTAGES.

8-29. Dc voltages are indicated on the sche-











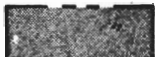
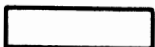
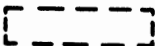
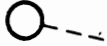

matics for active components (transistors, etc). Conditions for making the voltage measurements are listed adjacent to and on the schematic. Since the conditions for making these measurements may differ from one circuit to another, always check the specific conditions listed. Any measurements made with the circuit energized must be made with care. An accidental shorting of points on the circuit board may destroy circuit components.

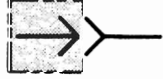

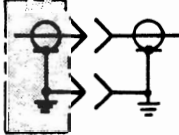

8-39. WAVEFORMS.

8-31. Waveform measurement points are shown on the schematics. The numbers inside the measurement point symbols are keyed to corresponding waveforms adjacent to each schematic. Conditions for making the waveform measurements are also listed with the waveforms. Like the dc voltage measurement conditions, waveform measurement conditions may vary from one circuit to another.

Table 8-2. Schematic Notes

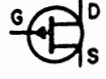
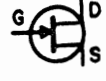
Refer to MIL-S1 15-1A for schematic symbols not listed in this table.

-  = Etched circuit board
-  = Front-panel marking
-  = Rear-panel marking
-  = Front-panel control
-  = Screwdriver adjustment
- P/O** = Part of
- CW** = Clockwise end of variable resistor
- NC** = No connection
-  = Waveform test point (with number)
-  = Common electrical point (with letter) not necessarily ground
-  = Single-pin connector on board
-  = Pin of a plug-in board (with letter or number)
-  = Coaxial cable connected to snap-on jack
-  = Coaxial cable connected directly to board
-  = Wire connected to pressure-fit socket on board
-  = Main signal path
-  = Primary feedback path
-  = Secondary feedback path

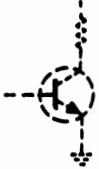
-  = Field-effect transistor (P-type base)
-  = Field-effect transistor (N-type base)
-  = Breakdown diode (voltage regulator)
-  = Tunnel diode
-  = Step-recovery diode
-  = Circuits or components drawn with dashed lines (phantom) show function only and are not intended to be complete. The circuit or component is shown in detail on another schematic.

(925) = Wire colors are given by numbers in parentheses using the resistor color code [(925) is wht-red-grn]

- | | |
|------------|------------|
| 0 - Black | 5 - Green |
| 1 - Brown | 6 - Blue |
| 2 - Red | 7 - Violet |
| 3 - Orange | 8 - Gray |
| 4 - Yellow | 9 - White |

Switch wafers are identified as follows:

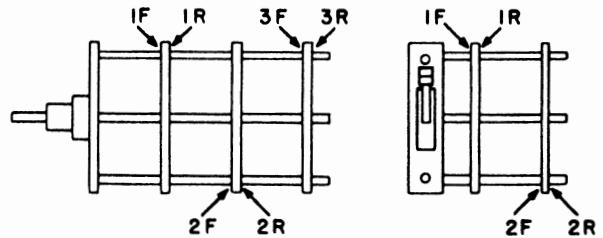

* = Optimum value selected at factory, typical value shown; part may have been omitted.

Unless otherwise indicated:
 resistance in ohms
 capacitance in picofarads
 inductance in microhenries

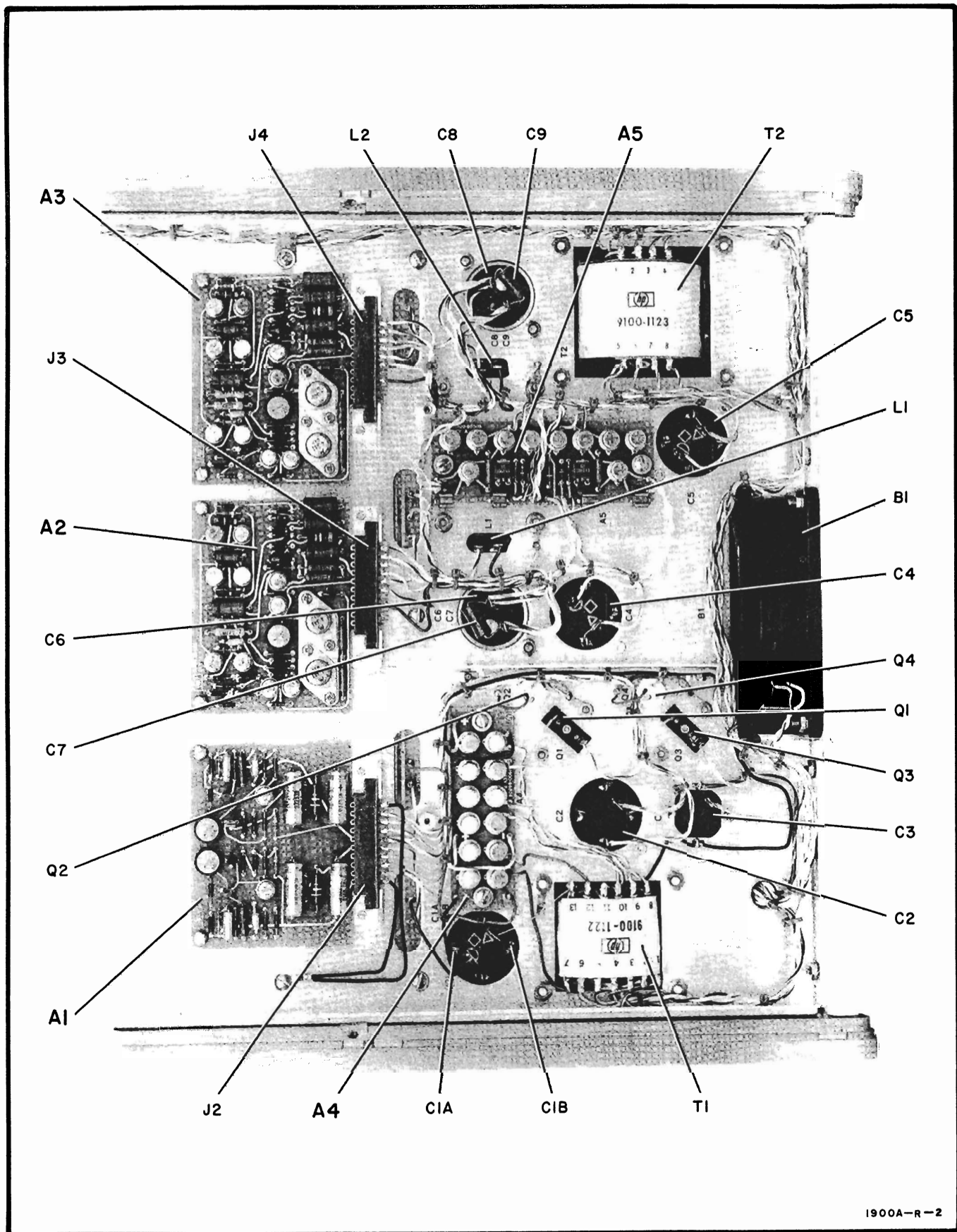

1900A-R-2

Figure 8-2. Parts Location, Top View

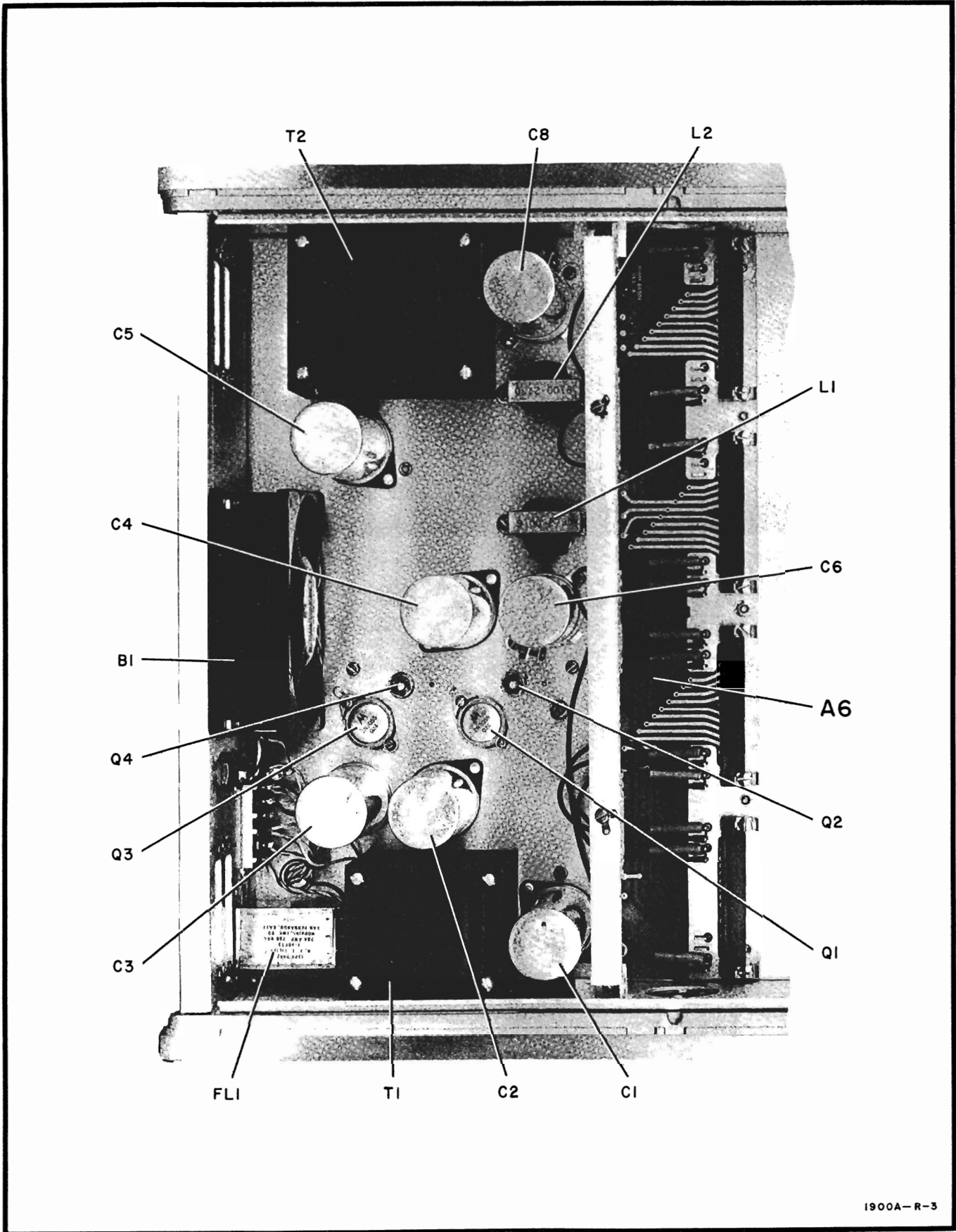
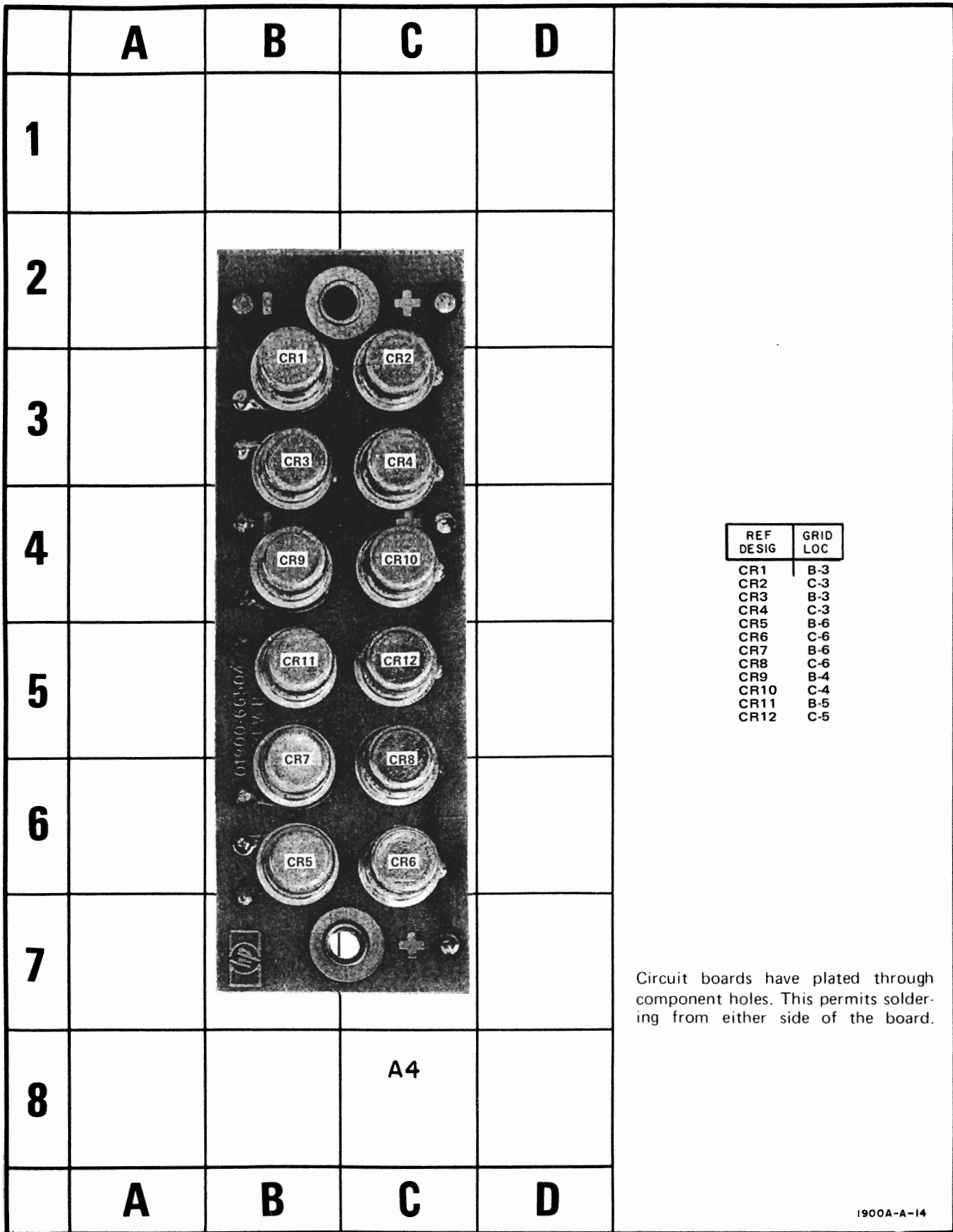

Figure 8-3. Parts Location, Bottom View



1900A-A-14

Figure 8-4. Component Identification, A4

Table 8-3. Voltage measurement Conditions, Schematic 1

Line Voltage 115 or 230 Vac
LINE Power ON
Plug-ins not installed.

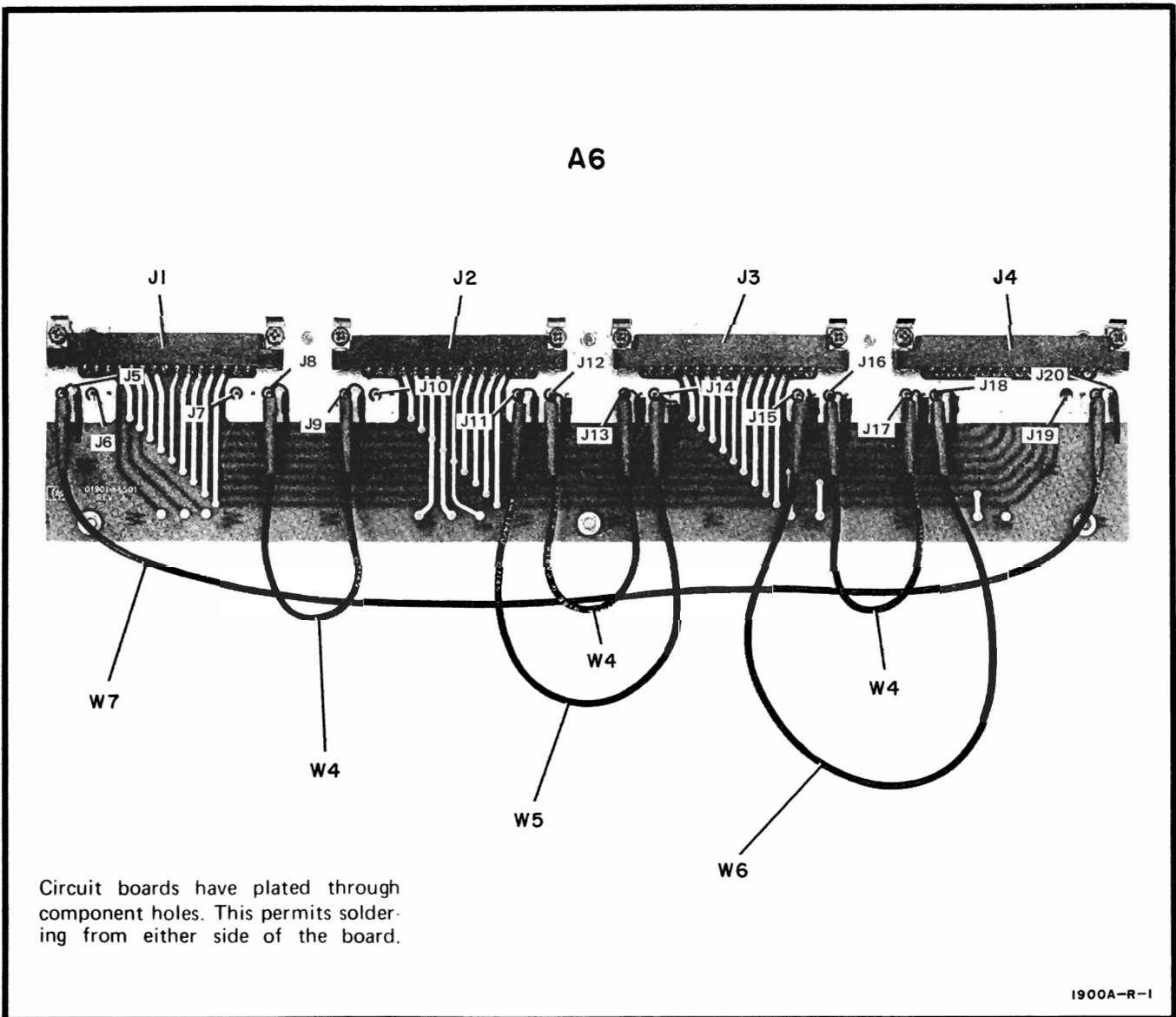
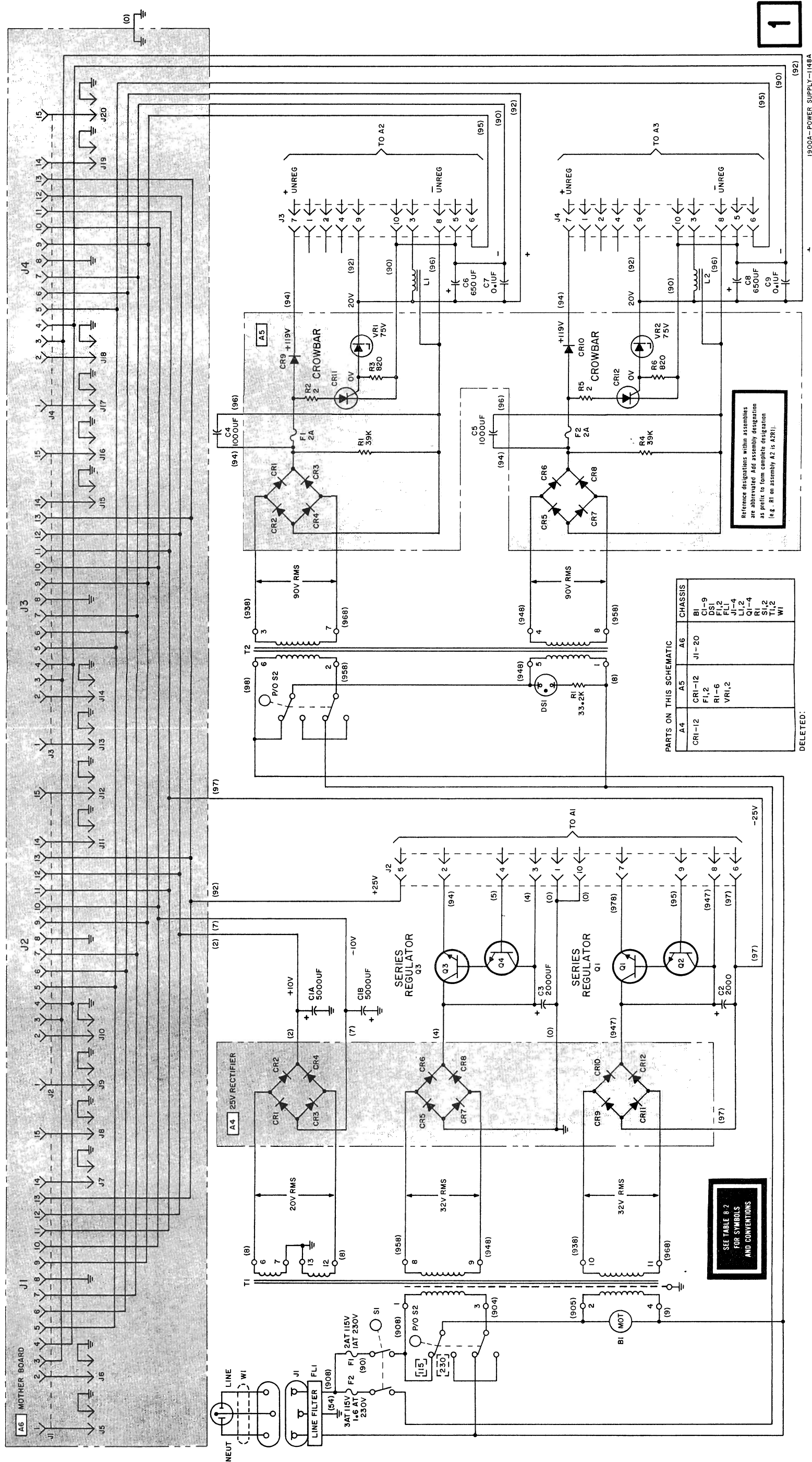

Figure 8-6. Mother Board, A6, and Internal Cables



SEE TABLE 8-2
FOR SYMBOLS
AND CONVENTIONS

PARTS ON THIS SCHEMATIC

A4	A5	A6	CHASSIS
CR1-12	CR1-12	J1-20	BI
	FL1,2		CI-9
	RI-6		DS1
	VR1,2		FL1,2
			FL1
			J1-4
			J1-4
			Q1-4
			Q1
			SI,2
			TI,2
			WI

Reference designations within assemblies are abbreviated. Add assembly designation as prefix to form complete designation (e.g., RI on assembly A2 is A2RI).

DELETED:

1900A-POWER SUPPLY-1148A
1900A-D-1A

Figure 8-7.
Low Voltage Power Supply Schematic
8-9

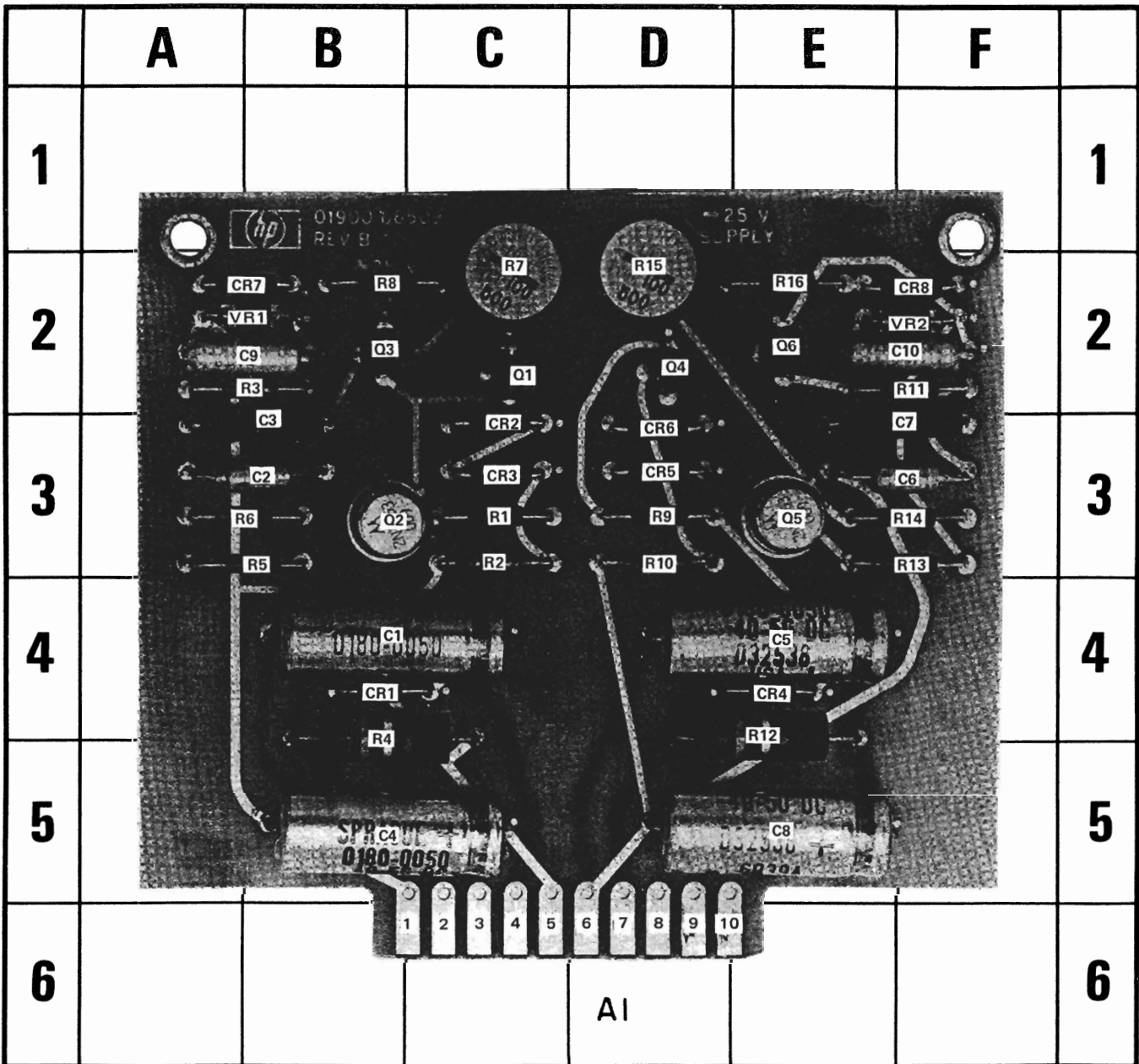

Circuit boards have plated through component holes. This permits soldering from either side of the board.

REF DESIG	GRID LOC	REF DESIG	GRID LOC	REF DESIG	GRID LOC	REF DESIG	GRID LOC	REF DESIG	GRID LOC	REF DESIG	GRID LOC	REF DESIG	GRID LOC
C1	B-4	C7	F-3	CR3	C-3	Q1	C-2	R1	C-3	R7	C-2	R13	F-3
C2	B-3	C8	E-5	CR4	E-4	Q2	B-3	R2	C-3	R8	B-2	R14	F-3
C3	B-3	C9	B-2	CR5	D-3	Q3	B-2	R3	B-2	R9	D-3	R15	D-2
C4	B-5	C10	F-2	CR6	D-3	Q4	D-2	R4	B-4	R10	D-3	R16	E-2
C5	E-4	CR1	B-4	CR7	B-2	Q5	E-3	R5	B-3	R11	F-2	VR1	B-2
C6	F-3	CR2	C-3	CR8	F-2	Q6	E-2	R6	B-3	R12	E-4	VR2	F-2

Figure 8-8. ±25V Regulator, A1, Component Identification

Table 8-4. Voltage Measurement Conditions, Schematic 2

Line Voltage 115 or 230 Vac
LINE Power ON
Plug-ins not installed.

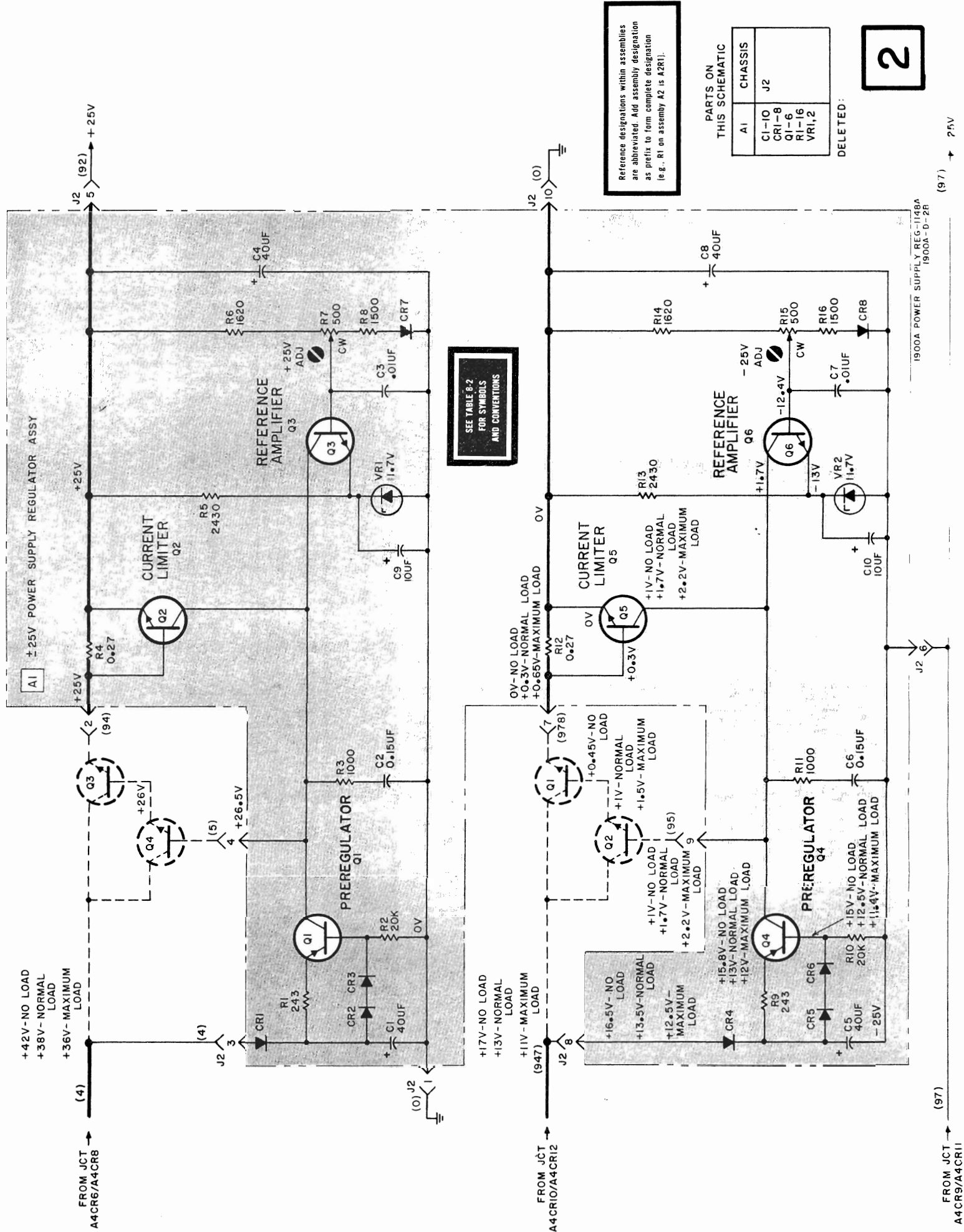
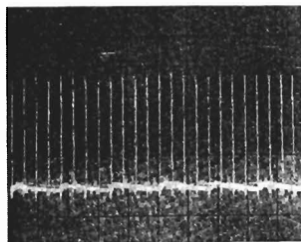
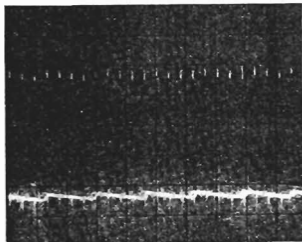

Figure 8-9.
±25V Regulator Schematic
8-11

Waveforms taken with Model 1915A installed, set for 50V output.



1 0.1V/DIV
5 MSEC/DIV



2 0.1V/DIV
5 MSEC/DIV

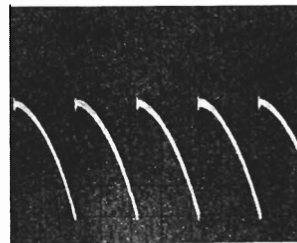

3 0.1V/DIV
1 MSEC/DIV

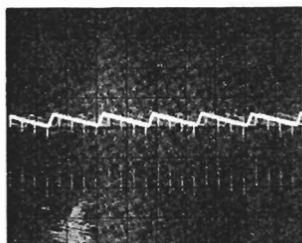

5 0.05V/DIV
5 MSEC/DIV

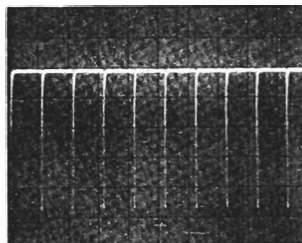

6 0.05V/DIV
2 MSEC/DIV

1900A-B-3

Figure 8-10. Variable Power Supply Waveforms, Loaded

Waveforms taken with no plug-in installed. No power supply load connected.

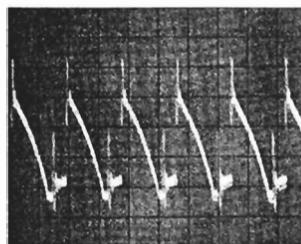

1 0.1V/DIV
20 USEC/DIV

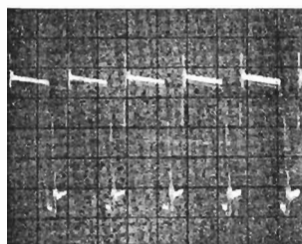

2 0.1V/DIV
20 USEC/DIV

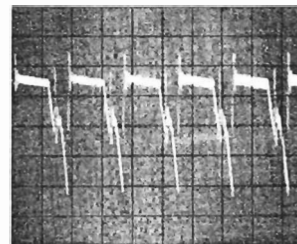

3 0.1V/DIV
20 USEC/DIV

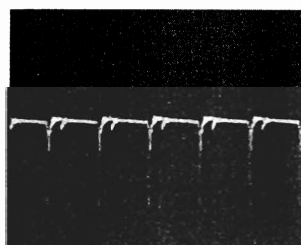

4 0.5V/DIV
20 USEC/DIV

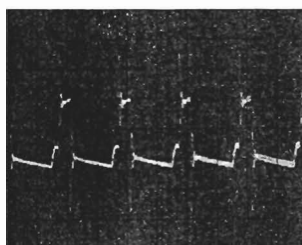

5 0.1V/DIV
20 USEC/DIV

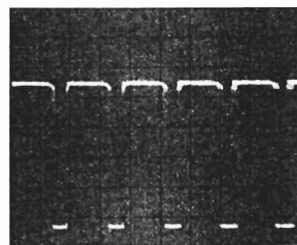

6 2V/DIV
20 USEC/DIV

1900A-B-4

Figure 8-11. Variable Power Supply, Waveforms Unloaded

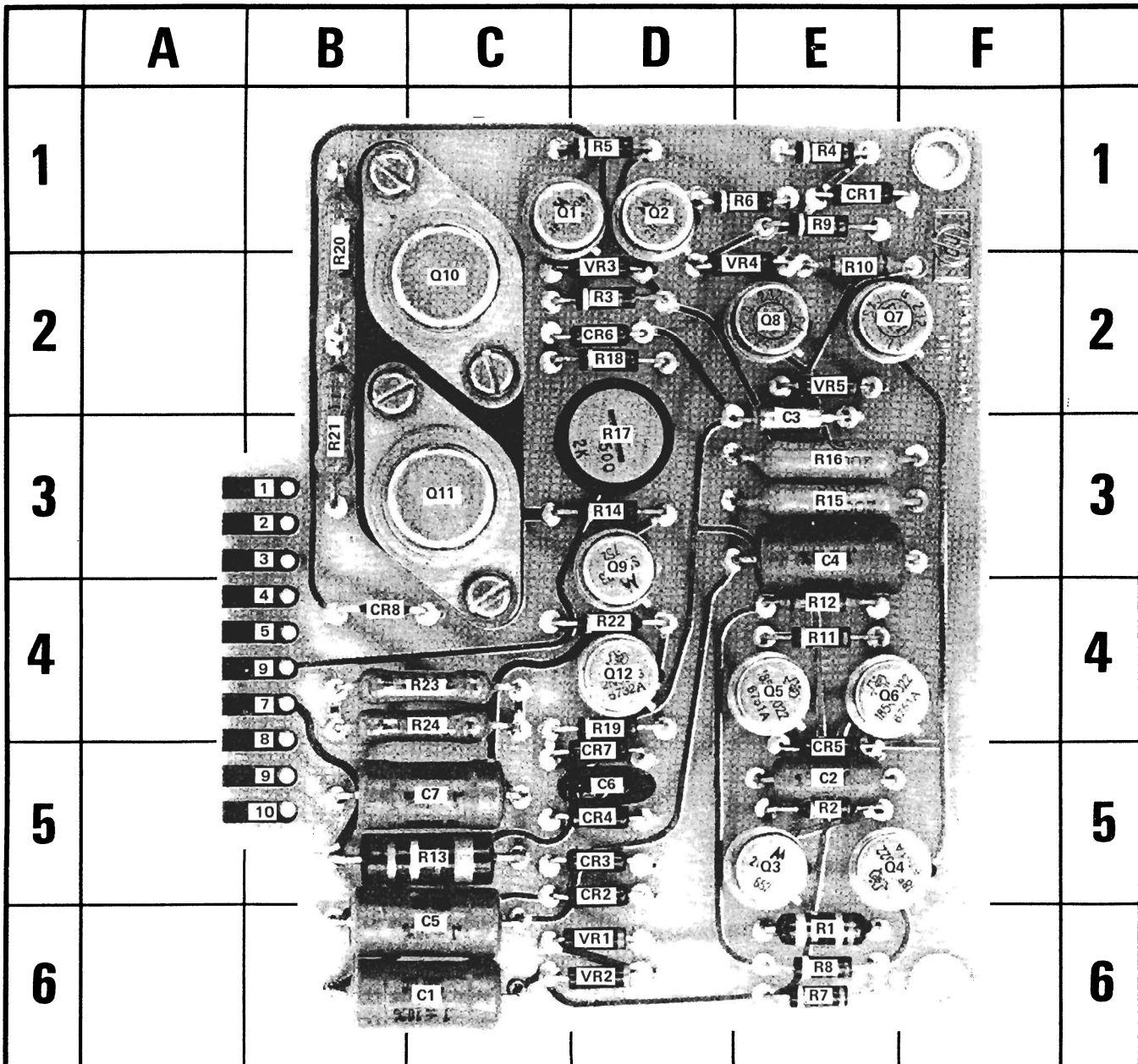

REF DESIG	GRID LOC	REF DESIG	GRID LOC	REF DESIG	GRID LOC	REF DESIG	GRID LOC	REF DESIG	GRID LOC	REF DESIG	GRID LOC	REF DESIG	GRID LOC	REF DESIG	GRID LOC
C1	C-6	CR1	E-1	CR8	B-4	Q7	E-2	R2	E-5	R9	E-1	R16	E-3	R23	C-4
C2	E-5	CR2	D-5	Q1	D-1	Q8	E-2	R3	D-2	R10	E-2	R17	D-3	R24	C-4
C3	E-3	CR3	D-5	Q2	D-1	Q9	D-3	R4	E-1	R11	E-4	R18	D-2	VR1	D-6
C4	E-3	CR4	D-5	Q3	E-5	Q10	C-2	R5	D-1	R12	E-4	R19	D-4	VR2	D-6
C5	C-6	CR5	E-5	Q4	E-5	Q11	C-3	R6	E-1	R13	C-5	R20	B-1	VR3	D-2
C6	D-5	CR6	D-2	Q5	E-4	Q12	D-4	R7	E-6	R14	D-3	R21	B-3	VR4	E-2
C7	C-5	CR7	D-5	Q6	E-4	R1	E-6	R8	E-6	R15	E-3	R22	D-4	VR5	E-2

1900A-R-8

Figure 8-12. Variable Power Supply, A2 and A3, Component Identification

Table 8-5. Voltage Measurement Conditions, Schematic 3

Line Voltage	115 or 230 Vac
LINE Power	ON
Plug-ins not installed.	



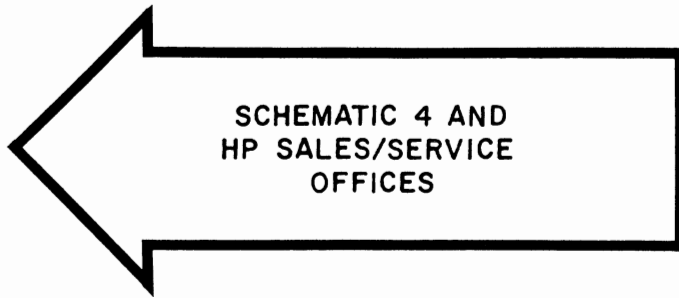

EUROPE

AUSTRIA
Hewlett-Packard Ges.m.b.H.
Handelska 52/3
P.O. Box 7
A-1205 Vienna
Tel: (0222) 33 66 06 to 09
Cable: HEWPAK Vienna
Telex: 75923 hewpak a

BELGIUM
Hewlett-Packard Benelux
S.A./N.V.
Avenue du Col-Vert, 1
B-1170 Brussels
Tel: (02) 72 22 40
Cable: PALOBEN Brussels
Telex: 23 494 paloben bru

DENMARK
Hewlett-Packard A/S
Datavej 38
DK-3460 Birkerød
Tel: (01) 81 66 40
Cable: HEWPAK AS
Telex: 166 40 hp as
Hewlett-Packard A/S
Torvet 9
DK-8600 Silkeborg
Tel: (06) 82-71-66
Telex: 166 40 hp as
Cable: HEWPAK AS

FINLAND
Hewlett-Packard Oy
Bulevardi 26
P.O. Box 12185
SF-00120 Helsinki 12
Tel: (90) 13730
Cable: HEWPAK OY Helsinki
Telex: 12-15363 hel

FRANCE
Hewlett-Packard France
Quartier de Courtaubouef
Boite Postale No. 6
F-91401 Orsay
Tel: (1) 907 78 25
Cable: HEWPAK Orsay
Telex: 60048

Hewlett-Packard France
4 Quai des Etoiles
F-69321 Lyon Cedex 1
Tel: (78) 42 63 45
Cable: HEWPAK Lyon
Telex: 31617
Hewlett-Packard France
29 rue de la Gare
F-31700 Blagnac
Tel: (61) 85 82 29
Telex: 51957

GERMAN FEDERAL REPUBLIC
Hewlett-Packard GmbH
Vertriebszentrale Frankfurt
Bernstrasse 117
Postfach 560 140
D-6000 Frankfurt 56
Tel: (0611) 50 04-1
Cable: HEWPAKSA Frankfurt
Telex: 41 32 49 fra
Hewlett-Packard GmbH
Vertriebsbüro Böblingen
Herrenbergerstrasse 110
D-7030 Böblingen, Württemberg
Tel: (07031) 66 72 87
Cable: HEPAK Böblingen
Telex: 72 65 739 bbn

Hewlett-Packard GmbH
Vertriebsbüro Düsseldorf
Vogelsanger Weg 38
D-4000 Düsseldorf 25
Tel: (0211) 63 80 31/35
Telex: 85/86 533 hppd d
Hewlett-Packard GmbH
Vertriebsbüro Hamburg
Wendenstr. 23
D-2000 Hamburg 1
Tel: (0411) 24 05 51/52
Cable: HEWPAKSA Hamburg
Telex: 21 63 032 hphd d

Hewlett-Packard Italia S.p.A.
Via Amerigo Vespucci 2
I-20124 Milan
Tel: (2) 6251 (10 lines)
Cable: HEWPAKIT Milan
Telex: 32046

Hewlett-Packard Italia S.p.A.
Piazza Marconi
I-00144 Rome - Eur
Tel: (6) 5912544/5, 5915947
Cable: HEWPAKIT Rome
Telex: 61514

Hewlett-Packard GmbH
Vertriebsbüro München
Unterhachinger Strasse 28
ISAR Center
D-8012 Ottobrunn
Tel: (0811) 601 30 61/7
Telex: 52 49 85
Cable: HEWPAKSA München
(West Berlin)
Hewlett-Packard GmbH
Vertriebsbüro Berlin
Wilmerdorfer Strasse 113/114
D-1000 Berlin W. 12
Tel: (0311) 3137046
Telex: 18 34 05 hpbm d

GREECE
Kostas Karayannis
18, Ermou Street
GR-Athens 126
Tel: 3230-303
Cable: RAKAR Athens
Telex: 21 59 62 rkar g

IRELAND
Hewlett-Packard Ltd.
224 Bath Road
GB-Slough, SL1 4 DS, Bucks
Tel: Slough (0753) 33341
Cable: HEWPIE Slough
Telex: 84413
Hewlett-Packard Ltd.
The Graftons
Stamford New Road
Altrincham, Cheshire, England
Tel: (061) 928-8626
Telex: 668068

ITALY
Hewlett-Packard Italia S.p.A.
Via Amerigo Vespucci 2
I-20124 Milan
Tel: (2) 6251 (10 lines)
Cable: HEWPAKIT Milan
Telex: 32046
Hewlett-Packard Italia S.p.A.
Piazza Marconi
I-00144 Rome - Eur
Tel: (6) 5912544/5, 5915947
Cable: HEWPAKIT Rome
Telex: 61514

Hewlett-Packard Italiana S.p.A.
Vicolo Pastori, 3
I-35100 Padova
Tel: (49) 66 40 62
Telex: 32046 via Milan
Hewlett-Packard Italiana S.p.A.
Via Colli, 24
I-10129 Turin
Tel: (11) 53 82 64
Telex: 32046 via Milan

LUXEMBURG
Hewlett-Packard Benelux
S.A./N.V.
Avenue du Col-Vert, 1
B-1170 Brussels
Tel: (03/02) 72 22 40
Cable: PALOBEN Brussels
Telex: 23 494

NETHERLANDS
Hewlett-Packard Benelux, N.V.
Weerdestein 117
P.O. Box 7825
NL-Amsterdam, Z 11
Tel: (020) 42 77 77
Cable: PALOBEN Amsterdam
Telex: 13 216 hepa nl

NORWAY
Hewlett-Packard Norge A/S
Nevsveien 13
Box 149
N-1344 Haslum
Tel: (02) 53 83 60
Telex: 16621 hpnas n

PORTUGAL
Teletra-Empresa Técnica de
Eléctricos S.a.r.l.
Rua Rodrigo da Fonseca 103
P.O. Box 2531
P-Lisbon 1
Tel: (19) 68 60 72
Cable: TELETRA Lisbon
Telex: 1598

SPAIN
Hewlett-Packard Española, S.A.
Jerez No 8
E-Madrid 16
Tel: 458 26 00
Telex: 23515 hpe
Hewlett-Packard Española, S.A.
Milansado 21-23
E-Barcelona 17
Tel: (3) 203 62 00
Telex: 52603 hpbpe e

SWEDEN
Hewlett-Packard Sverige AB
Enighetsvägen 1-3
Fack
S-161 20 Bromma 20
Tel: (08) 98 12 50
Cable: MEASUREMENTS
Stockholm
Telex: 10721

Hewlett-Packard Sverige AB
Hagakergatan 9C
S-431 41 Mölndal
Tel: (031) 27 68 00/01
Telex: 21 312 hpmind s

SWITZERLAND
Hewlett Packard (Schweiz) AG
Zürcherstrasse 20
P.O. Box 64
CH-8952 Schlieren Zurich
Tel: (01) 98 18 21/24
Cable: HPAG CH
Telex: 53933 hpag ch

Hewlett-Packard (Schweiz) AG
9, Chemin Louis-Pictet
CH-1214 Vernier—Geneva
Tel: (022) 41 4950
Cable: HEWPAKSA Geneva
Telex: 27 333 hpsa ch

TURKEY
Telekom Engineering Bureau
Saglik Sok No. 15/1
Ayaspa-Beyoglu
P.O. Box 437 Beyoglu
TR-Istanbul
Tel: 49 40 40
Cable: TELEMATION Istanbul

UNITED KINGDOM
Hewlett-Packard Ltd.
224 Bath Road
GB-Slough, SL1 4 DS, Bucks
Tel: Slough (0753) 33341
Cable: HEWPIE Slough
Telex: 84413
Hewlett-Packard Ltd.
"The Graftons"
Stamford New Road
GB-Altrincham, Cheshire
Tel: (061) 928-8626
Telex: 668068

Hewlett-Packard Ltd's registered
address for V.A.T. purposes
only:
70, Finsbury Pavement
London, EC2A1SX
Registered No: 69057

SOCIALIST COUNTRIES
PLEASE CONTACT:
Hewlett-Packard Ges.m.b.H.
Handelskai 52/3
P.O. Box 7
A-1205 Vienna
Ph: (0222) 33 66 06 to 09
Cable: HEWPAK Vienna
Telex: 75923 hewpak a

ALL OTHER EUROPEAN
COUNTRIES CONTACT:
Hewlett-Packard S.A.
Rue du Bois-du-Lan 7
P.O. Box 85
CH-1217 Meyrin 2 Geneva
Switzerland
Tel: (022) 41 54 00
Cable: HEWPAKSA Geneva
Telex: 2 24 86

AFRICA, ASIA, AUSTRALIA

ANGOLA
Telectra Empresa Técnica
de Equipamentos Eléctricos
SAR
Rua de Barbosa Rodrigues
42-1°
Box 6487
Luanda
Cable: TELETRA Luanda

AUSTRALIA
Hewlett-Packard Australia
Pty. Ltd.
22-26 Weir Street
Glen Iris, 3146
Victoria
Tel: 20-1371 (6 lines)
Cable: HEWPAK Melbourne
Telex: 31 024

Hewlett-Packard Australia
Pty. Ltd.
Corner Bridge & West Streets
Pymble, New South Wales, 2073
Tel: 449 6566
Cable: HEWPAK Sydney
Telex: 21561

Hewlett-Packard Australia
Pty. Ltd.
97 Churchill Road
Prospect 5082
South Australia
Tel: 65-2366
Cable: HEWPAK Adelaide

Hewlett Packard Australia
Pty. Ltd.
2nd Floor, Suite 13
Casablanca Buildings
196 Adelaide Terrace
Perth, W.A. 6000
Tel: 25-6800
Cable: HEWPAK Perth

Hewlett-Packard Australia
Pty. Ltd.
10 Woolley Street
P.O. Box 191
Dickson A.C.T. 2602
Tel: 49-8194
Cable: HEWPAK Canberra ACT
Hewlett-Packard Australia
Pty. Ltd.
2nd Floor, 49 Gregory Terrace
Brisbane, Queensland, 4000
Tel: 29 1544

CEYLON
United Electricals Ltd.
P.O. Box 681
60, Park St.
Colombo 2
Tel: 26696
Cable: HOTPO'INT Colombo

CYPRUS
Kypronic
19 Gregorios & Xenopoulos Road
P.O. Box 1152
CY-Nicosia
Tel: 45628/29
Cable: KYFRONKS PANDEHIS

ETHIOPIA
African Salespower & Agency
Private Ltd., Co.
P. O. Box 718
58/59 Cunningham St.
Addis Ababa
Tel: 12285
Cable: ASACO Addisababa

HONG KONG
Schmidt & Co. (Hong Kong) Ltd.
P.O. Box 297
1511, Prince's Building 15th Floor
10, Chater Road
Hong Kong
Tel: 240168, 232735
Cable: SCHMIDTCO Hong Kong

INDIA
Blue Star Ltd.
Kasturi Buildings
Jamshedji Tata Rd.
Bombay 400 020
Tel: 29 50 21
Telex: 3751
Cable: BLUEFROST

Blue Star Ltd.
Band Box House
Prabhadevi
Bombay 400 025
Tel: 45 73 01
Telex: 3751
Cable: BLUESTAR

Blue Star Ltd.
14/40 Civil Lines
Kampur 208 001
Tel: 6 88 82
Cable: BLUESTAR
Blue Star Ltd.
7 Hare Street
P.O. Box 506
Calcutta 700 001
Tel: 23-0131
Telex: 655
Cable: BLUESTAR

Blue Star Ltd.
Blue Star House,
34 Ring Road
Lajpat Nagar
New Delhi 110 024
Tel: 62 32 76
Telex: 463
Cable: BLUESTAR

Blue Star, Ltd.
Blue Star House
11/11A Magarath Road
Bangalore 560 025
Tel: 51473
Cable: BLUESTAR

Blue Star, Ltd.
1-1-117/1
Sarojini Devi Road
Secunderabad 500 003
Tel: 7 63 91, 7 73 93
Cable: BLUEFROST
Telex: 459

Blue Star, Ltd.
23/24 Second Line Beach
Madras 600 001
Tel: 2 39 55
Telex: 379
Cable: BLUESTAR

Blue Star, Ltd.
18 Kaiser Bungalow
Dindli Road
Jamshedpur 831 001
Tel: 38 04
Cable: BLUESTAR
Telex: 240

INDONESIA
Bah Bolton Trading Coy. N.V.
Djalal Merdeka 29
Bandung
Tel: 4915; 51560
Cable: ILMU
Telex: 08-809

IRAN
Multicorp International Ltd.
Avenue Soraya 130
P.O. Box 1212
IR-Teheran
Tel: 83 10 35-39
Cable: MULTICORP Tehran
Telex: 2893 MCI TN

ISRAEL
Electronics & Engineering
Div. of Motorola Israel Ltd.
17 Aminadav Street
Tel-Aviv
Tel: 36941 (3 lines)
Cable: BASTEL Tel-Aviv
Telex: 33569

JAPAN
Yokogawa-Hewlett-Packard Ltd.
Ohashi Building
1-59-1 Yoyogi
Shibuya-ku, Tokyo
Tel: 03-370-2281/92
Telex: 232-2024YHP
Cable: YHPMARKET TOK 23-724

Yokogawa-Hewlett-Packard Ltd.
Nisei Ibaragi Bldg.
2-2-8 Kasuga
Ibaragi-Shi
Osaka
Tel: (0726) 23-1641
Telex: 5332-385 YHP OSAKA
Yokogawa-Hewlett-Packard Ltd.
Nakamo Building
No. 24 Kamisasazima-cho
Nakamura-ku, Nagoya City
Tel: (052) 571-5171

Yokogawa-Hewlett-Packard Ltd.
Nitto Bldg.
2-4-2 Shinohara-Kita
Kohoku-ku
Yokohama 222
Tel: 045-432-1504
Telex: 382-3204 YHP YOK

Yokogawa-Hewlett-Packard Ltd.
Chuo Bldg.
Rm. 603 3,
2-Chome
IZUMI-CHO,
Mito, 310
Tel: 0292-25-7470

KENYA
Kenya Kinetics
P.O. Box 18311
Nairobi, Kenya
Tel: 57726
Cable: PROTON

KOREA
Amtraco Corporation
Industrial Products Div.
Seoul P.O. Box 1103
8th floor, Daekyung Bldg.
107 Sejong Ro
Chongro-Ku, Seoul
Tel: 73-8924-7
Cable: AMTRACO Seoul

LEBANON
Constantin E. Macridis
P.O. Box 7213
RL-Beirut
Tel: 220846
Cable: ELECTRONUCLEAR Beirut

MALAYSIA
MECOMB Malaysia Ltd.
2 Lorong 13/6A
Section 13
Petaling Jaya, Selangor
Cable: MECOMB Kuala Lumpur

MOZAMBIQUE
A. N. Gonçalves, LDA.
4.1 Apton. 14 Av. D. Luis
P.O. Box 107
Lourenço Marques
Telex: 6-203 NEGON MO
Cable: NEGON

NEW ZEALAND
Hewlett-Packard (N.Z.) Ltd.
94-96 Dixon St.
P.O. Box 9443
Courtenay Place
Wellington, N.Z.
Tel: 56-559
Telex: 6-203 NEGON MU
Cable: HEWPAK Wellington

Hewlett Packard (N.Z.) Ltd.
Box 51092
Pukeranga
Tel: 56-9837
Cable: HEWPAK Auckland

NIGERIA
Telex (MesaCom Division)
25 Moroni St. Suru-Lere,
P.O. Box 5705
Lagos
Cable: THETELI LAGOS

PAKISTAN
Mushko & Company, Ltd.
Oosman Chambers
Abdullah Haroon Road
Karachi 3
Tel: 511027, 512927
Cable: COOPERATOR Karachi
Mushko & Company, Ltd.
38B, Satellite Town
Rawalpindi
Tel: 41924
Cable: FEMUS Rawalpindi

PHILIPPINES
Electromex Inc.
5th Floor, Architects
Center Bldg.
Ayala Ave., Makati, Rizal
C.C.P.O. Box 1028
Makati, Rizal
Tel: 86-18-87, 87-76-77
Cable: ELEMEX Manila

SINGAPORE
Mechanical and Combustion
Engineering Company Ltd.
9, Jalan Kilang
Red Hill Industrial Estate
Singapore, 3
Tel: 642361-3; 632611
Cable: MECOMB Singapore

Hewlett-Packard Far East
Area Office
P.O. Box 87
Alexandra Post Office
Singapore 3
Tel: 633022
Cable: HEWPAK SINGAPORE

SOUTH AFRICA
Hewlett Packard South Africa
(Pty.) Ltd.
P.O. Box 31716
Braamfontein Transvaal
Milnerton
30 De Beer Street
Johannesburg
Tel: 725-2080, 725-2030
Telex: 0226 JH
Cable: HEWPAK Johannesburg

Hewlett Packard South Africa
(Pty.) Ltd.
Bree Street
Cape Town
Tel: 3-6019, 3-6545
Cable: HEWPAK Cape Town
Telex: 5-0006

Hewlett Packard South Africa
(Pty.) Ltd.
641 Ridge Road, Durban
P.O. Box 99
Overport, Natal
Tel: 88-6102
Telex: 567954
Cable: HEWPAK

OTHER AREAS NOT LISTED, CONTACT:
Hewlett-Packard
Export Trade Company
3200 Hillview Ave.
Palo Alto, California 94304
Tel: (415) 326-7000
(Feb. 71 493-1501)
TWX: 910-373-1267
Cable: HEWPAK Palo Alto
Telex: 034-8300, 034-8493

