

3302A TRIGGER/PHASE LOCK PLUG-IN

OPERATING AND SERVICE MANUAL

HEWLETT  PACKARD



CERTIFICATION

The Hewlett-Packard Company certifies that this instrument was thoroughly tested and inspected and found to meet its published specifications when it was shipped from the factory. The Hewlett-Packard Company further certifies that its calibration measurements are traceable to the U.S. National Bureau of Standards to the extent allowed by the Bureau's calibration facility.

WARRANTY AND ASSISTANCE

All Hewlett-Packard products are warranted against defects in materials and workmanship. This warranty applies for one year from the date of delivery, or, in the case of certain major components listed in the operating manual, for the specified period. We will repair or replace products which prove to be defective during the warranty period. No other warranty is expressed or implied. We are not liable for consequential damages.

For any assistance contact your nearest Hewlett-Packard Sales and Service Office. Addresses are provided at the back of this manual.



OPERATING AND SERVICE MANUAL

(HP PART NO. 03302-90001)

MODEL 3302A
TRIGGER/PHASE LOCK
PLUG-IN

SERIALS PREFIXED: 617-

Appendix C, Manual Backdating Changes,
adapts manual to Serials Prefixed:
540- and 536-.

Copyright Hewlett-Packard Company 1965
P. O. Box 301, Loveland, Colorado, 80537 U. S. A.

TABLE OF CONTENTS

<p>Section I GENERAL INFORMATION 1-1 1-1. General 1-1 1-3. Single Cycle 1-1 1-5. Multiple Cycle 1-1 1-7. Free Run 1-1 1-9. Phase Lock 1-1 1-11. Instrument Identification 1-1</p> <p>Section II INSTALLATION 2-1 2-1. Introduction 2-1 2-3. Initial Inspection 2-1 2-5. Installation 2-1 2-7. Repackaging for Shipment 2-1</p> <p>Section III OPERATING INSTRUCTIONS 3-1 3-1. Introduction 3-1 3-3. Controls and Indicators 3-1 3-5. Operating Instructions 3-1 3-7. Single Cycle Mode, External or Manual 3-1 3-9. Multiple Cycle Mode, External or Manual 3-1 3-11. Free Run 3-1 3-13. Phase Lock Mode 3-1 3-15. Applications 3-2 3-17. Single Cycle 3-2 3-18. Multiple Cycle 3-2 3-19. Free Run, with Inputs as Indicated to 3300A Remote Frequency Control Jack 3-2</p> <p>Section IV THEORY OF OPERATION 4-1 4-1. Introduction 4-1 4-3. General Description 4-1 4-5. Input Trigger Circuit 4-1 4-7. Schmitt Trigger 4-1 4-9. Phase Multivibrator 4-1 4-14. Phase Lock Amplifier 4-1 4-16. Meter Amplifier 4-1 4-18. Summing Circuit 4-1</p>	<p>Section IV (Cont'd) 4-26. Schematic Theory 4-2 4-28. Trigger Input Circuit 4-2 4-39. Phase Multivibrator 4-2 4-42. Gating Amplifier 4-3 4-50. Phase Lock Amplifier 4-4 4-57. Meter Amplifier 4-4 4-59. Phase Lock Emitter Follower 4-4 4-61. Emitter Follower, Q15 4-5 4-63. Summing Amplifier 4-5</p> <p>Section V MAINTENANCE 5-1 5-1. Introduction 5-1 5-4. Performance Checks and Preliminary Adjustments 5-1 5-8. Free Run Mode Check 5-1 5-9. Single and Multiple Cycle Mode Check External 5-1 5-10. Single and Multiple Cycle Mode Check Manual 5-2 5-11. Trigger Amplitude Check 5-2 5-12. Phase Lock Mode Check 5-3 5-16. Adjustment and Calibration 5-5 5-19. R5 and R6, Low and High Frequency Dial Adjustments 5-5 5-20. Phase Lock Dial Adjust 5-5 5-21. C28 Adjust 5-6 5-22. Troubleshooting Procedures 5-6</p> <p>Section VI REPLACEABLE PARTS 6-1 6-1. Introduction 6-1 6-4. Ordering Information 6-1 6-6. Non-Listed Parts 6-1</p> <p>Appendix A CODE LIST OF MANUFACTURERS</p> <p>Appendix B SALES AND SERVICE OFFICES</p> <p>Appendix C MANUAL BACKDATING CHANGES</p>
--	--

LIST OF TABLES

<p>Number Page 1-1. Specifications 1-0 5-1. Required Test Equipment 5-0 5-2. Phase Dial Accuracy and Distortion Checks 5-4</p>	<p>Number Page 5-3. Maintenance Correlation 5-5 5-4. Troubleshooting Aid 5-7/5-8 6-1. Replaceable Parts 6-2</p>
--	---

LIST OF ILLUSTRATIONS

<p>Number Page 1-1. 3302A Trigger/Phase Lock Plug-in 1-0 3-1. Front Panel Description 3-0 4-1. Block Diagram 4-0 4-2. Gating Amplifier Partial Block Diagram 4-3 4-3. Effect of START/STOP PHASE Control on 3300A Triangle Integrator 4-3 4-4. Loop Waveform Relationship 4-4</p>	<p>Number Page 5-1. Single Cycle, Frequency Dial Check and Adjustments, Phase Lock Dial Adjust, and C28 Adjust Test Setup 5-0 5-2. Single Cycle Phase Relationship 5-1 5-3. 0 - +1500 MV Power Supply 5-2 5-4. Trigger Amplitude Check Test Setup 5-2 5-5. Distortion Check Test Setup 5-4 5-6. Typical Waveforms and Phase Relationship 5-6 5-7. Schematic Diagram 5-9</p>
---	---



Figure 1-1. 3302A Trigger/Phase Lock Plug-In

Table 1-1. Specifications

<p>3302A Trigger/Phase Lock Plug-in</p> <p>Modes of Operation: Single cycle Multiple cycle Phase lock Free run</p> <p>Trigger Requirements:</p> <p>Single Cycle: Manual or external. Dc coupled. Requires at least 0.5 volt to trigger externally. May be triggered with positive or negative input voltage (± 20 v peak max).</p> <p>Multiple Cycle: Manual or external start/stop. Dc coupled. Requires at least 0.5 volt to start, 0 volts to stop. May be triggered with either positive or negative input voltage (± 20 v peak max).</p>	<p>Phase Lock: (10 Hz to 100 KHz) Dc coupled. Requires at least 0.5 volt peak-to-peak to lock, 10 volts peak-to-peak for specified accuracy with sine wave input. The -hp- 3302A will lock on a fundamental or harmonic of the input signal.</p> <p>Phase Accuracy: $\pm 10^0$ from 10 Hz to 10 KHz. $\pm 20^0$ from 10 KHz to 100 KHz. (Fundamental only.)</p> <p>Introduced Distortion: $< 1\%$ 10 Hz to 10 KHz $< 3\%$ 10 KHz to 100 KHz. (Fundamental only.)</p> <p>Weight:</p> <p>Net: 3 lbs. (1,4 kg).</p> <p>Shipping: 5 lbs. (2,5 kg).</p> <p>Dimensions: 4-3/4" high, 6-1/16" wide, 10-1/4" deep (120,7 x 153,9 x 260,4 mm).</p>
---	---

SECTION I

GENERAL INFORMATION

NOTE

In this manual, the international standard unit of frequency, the Hertz, will be used rather than cycles per second.

1 Hertz (Hz) = 1 cycle per second

1-1. GENERAL.

1-2. The -hp- Model 3302A Trigger/Phase Lock Plug-in is a plug-in unit for the 3300A Function Generator. The Trigger/Phase Lock Plug-in can be triggered over the entire frequency range (0.01 Hz to 100 KHz) of the -hp- Model 3300A Function Generator. When inserted into the Function Generator, the Trigger/Phase Lock Plug-in permits single cycle, multiple cycle, free run, and phase lock modes of operation.

1-3. SINGLE CYCLE.

1-4. In single cycle mode of operation, one cycle of any of the 3300A functions (sine, triangle, or square wave) can be obtained by depressing the MANUAL TRIGGER or applying an external triggering voltage. A series of single cycles of any of the 3300A functions can be obtained by applying a periodic triggering voltage. Each cycle is generated when the input signal reaches approximately + or - 100 mv depending on position of INPUT PHASE switch and off at approximately zero. The starting and stopping phase can be varied through 180°.

1-5. MULTIPLE CYCLE.

1-6. In multiple cycle operation, the input gate voltage to the Trigger/Phase Lock Plug-in gates the 3300A on and off. The external gating voltage when above the triggering level or the time the MANUAL TRIGGER button is held depressed determines the time the 3300A will oscillate. The 3300A frequency dial or

remote frequency control voltage input to the 3300A and the 3300A RANGE switch determines the output frequency. A series of multiple cycle pulses can be obtained by applying a periodic triggering voltage. The starting phase of the first cycle in the series is the same and can be varied through 180°.

1-7. FREE RUN.

1-8. In free run mode of operation, the 3300A operation is the same as with the 3301A Auxiliary Plug-in. Refer to 3300A Operating and Service Manual.

1-9. PHASE LOCK.

1-10. In Phase Lock Operation, the 3300A can be phase locked to any periodic signal with a frequency range from 10 Hz to 100 KHz. Phase lock range is indicated on the 3302A meter. The phase relationship between the 3300A output function and the input signal can be varied through 360 degrees. The 3300A can also be phase locked to harmonics and multiples of the input signal.

1-11. INSTRUMENT IDENTIFICATION.

1-12. Hewlett-Packard uses a two-section eight-digit serial number (000-00000). If the first three digits of the serial number on your instrument do not agree with those on the title page of this manual, change sheets supplied with the manual will define differences between your instrument and the -hp- Model 3302A described in this manual.

SECTION II INSTALLATION

2-1. INTRODUCTION.

2-2. This section contains information and instructions necessary for the installation and shipping of the 3302A Trigger/Phase Lock Plug-in.

2-3. INITIAL INSPECTION.

2-4. This plug-in unit was carefully inspected both mechanically and electrically before shipment. It should be physically free of marks or scratches and in perfect electrical order upon receipt. To confirm this, the instrument should be inspected for physical damage which may have occurred during shipment, and electrically tested using the performance checks outlined in Section V.

2-5. INSTALLATION.

2-6. Install the Trigger/Phase Lock Plug-in unit in the compartment of the 3300A, Function Generator. Make certain the instrument is properly aligned and the front panel locking screw is tightened. The Model 3302A is fully transistorized; therefore, no special cooling is required. However, the instrument should not be operated where the ambient temperature exceeds 55°C (131°F).

2-7. REPACKAGING FOR SHIPMENT.

2-8. The following paragraphs contain a general guide for repackaging of the instrument for shipment. Refer to Paragraph 2-9 if the original container is to be used; 2-10 if it is not. If you have any questions, contact your local -hp- Sales and Service Office. (See Appendix B for office locations.)

NOTE

If the instrument is to be shipped to Hewlett-Packard for service or repair, attach a tag to the instrument identifying the owner and indicating the service or repair to be accomplished; include the model number and full serial number of the instrument. In any correspondence, identify the instrument by model number, serial number and serial number prefix.

2-9. If original container is to be used, proceed as follows:

- a. Place instrument in original container if available. If original container is not available, one can be purchased from your nearest -hp- Sales and Service Office.
- b. Ensure that container is well sealed with strong tape or metal bands.

2-10. If original container is not to be used, proceed as follows:

- a. Wrap instrument in heavy paper or plastic before placing in an inner container.
- b. Place packing material around all sides of instrument and protect panel face with cardboard strips.
- c. Place instrument and inner container in heavy carton or wooden box and seal with strong tape or metal bands.
- d. Mark shipping container with "DELICATE INSTRUMENT," "FRAGILE" etc.

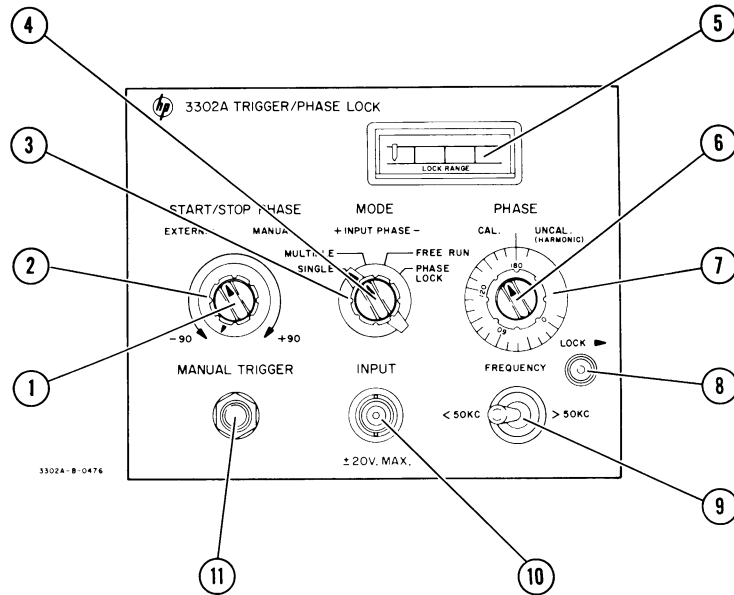

- ① EXTERNAL-MANUAL Switch: An SPST switch which selects input from either the MANUAL TRIGGER ⑪ or INPUT ⑩ triggering voltage.
- ② START/STOP PHASE: A variable resistor for varying the starting and stopping phase of the single cycle of the 3300A output function in single cycle mode or the starting phase of the first cycle and stopping phase of the last cycle in multiple cycle mode.
- ③ MODE Switch: A 4-position rotary switch which selects the desired Mode of Operation.
- ④ INPUT PHASE: A double pole rotary switch which selects a triggering signal in phase or 180° out of phase with the triggering signal at the INPUT connector.
- ⑤ PHASE LOCK RANGE Indicator: A dc meter which indicates phase lock range in PHASE LOCK MODE.
- ⑥ CAL-UNCAL Switch: An SPST switch which, when in CAL position and PHASE LOCK MODE, permits phase lock to the fundamental of the input; in UNCAL position, the 3300A can be phase locked to harmonics. In addition, multiple frequencies of the 3300A can be phase locked to multiple frequencies of the input.
- ⑦ PHASE: A potentiometer that varies the phase relationship of the 3300A output and the INPUT signal.
- ⑧ LOCK: Screw type mechanism for locking the 3302A into the 3300A.
- ⑨ FREQUENCY: A toggle switch which stabilizes the phase lock loop in phase lock mode. Position is dependent upon input frequency.
- ⑩ INPUT: A BNC connector for applying input signal in single, multiple and lock mode of operation. The input is dc coupled.
- ⑪ MANUAL TRIGGER: A pushbutton switch for triggering 3300A in single or multiple cycle manual operation.

Figure 3-1. Front Panel Description

SECTION III

OPERATING INSTRUCTIONS

3-1. INTRODUCTION.

3-2. This section consists of instructions and information necessary for the operation of -hp- Model 3302A Trigger/Phase Lock Plug-in.

3-3. CONTROLS AND INDICATORS.

3-4. Each operating control and connector on the 3302A is identified and described in Figure 3-1. The description of each component is keyed to the illustration.

3-5. OPERATING INSTRUCTIONS.

3-6. Refer to the 3300A Operating and Service Manual for operation of 3300A controls indicated.

3-7. SINGLE CYCLE MODE, EXTERNAL OR MANUAL.

3-8. To operate the 3300A/3302A in single cycle.

- a. Select SINGLE on MODE Switch (3) .
- b. Set 3300A FREQUENCY, function and AMPLITUDE control for desired output. Turn on 3300A.
- c. For manual operation, position EXTERNAL-MANUAL Switch (1) to MANUAL and depress MANUAL TRIGGER button (11) .



DO NOT APPLY ANY TRIGGERING VOLTAGE WITH AMPLITUDE GREATER THAN ± 20 VOLTS PEAK.

- d. For external trigger turn EXTERNAL-MANUAL switch to EXTERNAL and apply a voltage of any wave shape, positive or negative, with a minimum amplitude of 0.5 volt peak to the INPUT (10) connector. Period of triggering voltage should be greater than period of desired 3300A output.
- e. Select triggering phase with the INPUT PHASE Switch (4) . With INPUT PHASE Switch in + position, the 3300A is triggered as input voltage goes positive.
- f. Adjust desired 3300A output phase with START/STOP PHASE Control (2) . For a given setting of START/STOP PHASE Control, each single cycle will start and stop at the same phase.

3-9. MULTIPLE CYCLE MODE, EXTERNAL OR MANUAL.

3-10. To operate the 3300A/3302A in Multiple cycle operation:

- a. Select MULTIPLE on MODE Switch (3) .
- b. Set 3300A frequency, function and OUTPUT controls.
- c. For manual operation, position EXTERNAL-MANUAL Switch to MANUAL and depress and release MANUAL TRIGGER button (11) . 3300A will oscillate during the period button is held depressed.



MAXIMUM TRIGGER VOLTAGE
 ± 20 V PEAK.

- d. For external triggering, position EXTERNAL-MANUAL Switch to EXTERNAL and apply a periodic signal of either polarity with amplitude of 0.5 volt peak to start, and which goes to or through zero to stop.
- e. Adjust START/STOP PHASE (2) . The starting phase of the first cycle and stopping phase of the last cycle in each successive multicycle pulse is constant for a given setting of the START/STOP PHASE Control, but can be varied through 180° .
- f. Select triggering phase with INPUT PHASE Switch (4) .

3-11. FREE RUN.

3-12. When the MODE Switch (3) is in the FREE RUN position, the 3302A has no control over the 3300A. Operation is same as 3300A/3301A.

3-13. PHASE LOCK MODE.

3-14. To operate the 3300A/3302A in PHASE LOCK MODE:

- a. Select PHASE LOCK on MODE Switch (3) .
- b. Set 3300A FREQUENCY, function and AMPLITUDE controls.
- c. Set CAL-UNCAL Switch (6) to desired position. CAL for phase lock to the fundamental of the 3302A input signal. UNCAL phase lock to harmonics of the 3302A input signal.
- d. Set FREQUENCY Switch (9) to correct position as dictated by 3302A input frequency.

- e. With EXTERNAL-MANUAL Switch in EXTERNAL, apply signal to INPUT (10). Input signal must be a minimum of 0.5 volt peak-to-peak to lock, minimum of 10 volts peak-to-peak for specified accuracy with sine wave input. Maximum input ± 20 volts peak, frequency between 10 Hz to 100 KHz.
- f. Adjust PHASE Control until LOCK RANGE Meter (5) indicates phase lock, meter indication off limits and steady. Adjust 3300A FREQUENCY dial to center the meter.

NOTE

On the two lower ranges, a few seconds are required to obtain phase lock due to the large filter capacitors across the phase lock amplifier. The time required can be reduced by positioning PHASE dial to 0° if the RANGE LOCK meter indicates to the left of center and to 180° if RANGE LOCK meter is to the right of center.

NOTE

In the UNCAL position, 3300A output function should be monitored to ensure phase lock to desired harmonic.

- g. Adjust PHASE Control (7) as desired.

3-15. APPLICATIONS.

3-16. The 3302A can be used to obtain many waveform variations of basic 3300A outputs. The sine waveform will be illustrated but the same variations can be obtained on TRIANGLE and SQUARE WAVE functions. All waveforms can be dc offset.

3-17. SINGLE CYCLE.

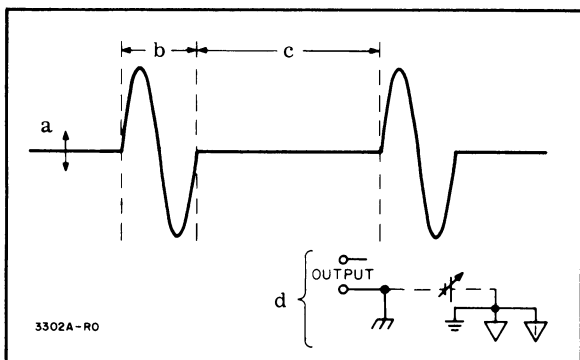

- a. Variable with START/STOP PHASE control through 180° .
- b. Variable with FREQUENCY Dial or Remote Frequency control voltage and Range switch.
- c. Variable with frequency of input trigger.
- d. Dc offset up to ± 250 v by connecting a dc power supply between circuit ground and output ground

(output ground, shield ground and power line ground should be common).

NOTE

The dc level of the waveform is a function of the START/STOP PHASE control in both the SINGLE and MULTIPLE CYCLE modes.

3-18. MULTIPLE CYCLE.

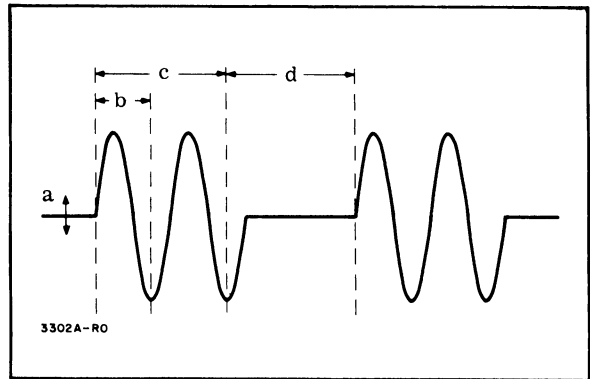

- a. Variable with START/STOP PHASE control.
- b. Variable with 3300A frequency setting.
- c and d. Function of gating voltage at input J1 to 3302A and 3302A INPUT PHASE position.

3-19. FREE RUN, WITH INPUTS AS INDICATED TO 3300A REMOTE FREQUENCY CONTROL JACK.

3-20. RECTANGULAR PULSES.

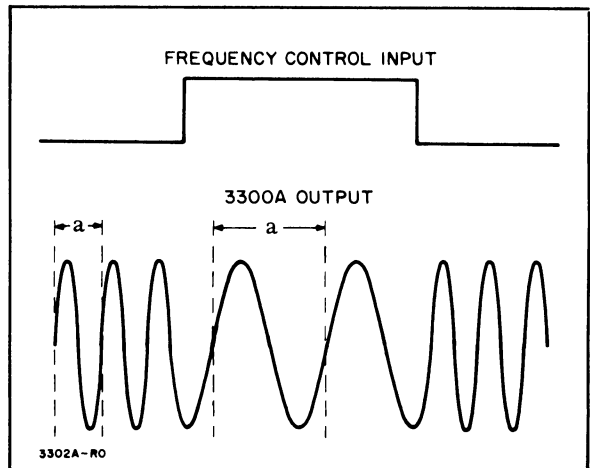

- a. Function of frequency control dc levels and 3300A RANGE switch.

NOTE

Frequency control voltage should be between 0 and -10 volts.

3-21. SINE WAVE INPUT.

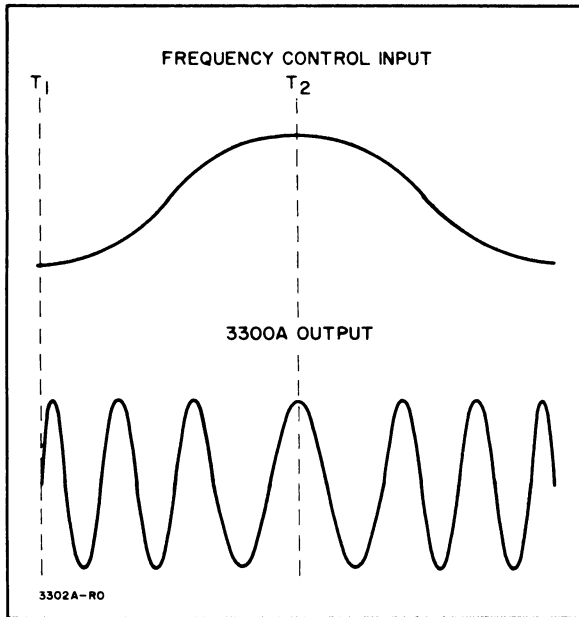

Ratio $\frac{F1}{F2}$ is variable with sine wave amplitude and dc level where:

F1 = variable output frequency between T_1 and T_2 .

F2 = frequency at T_2 .

Both frequencies are variable with range switch.
Dc level determines center frequency.

3-22. TRIANGLE INPUT.

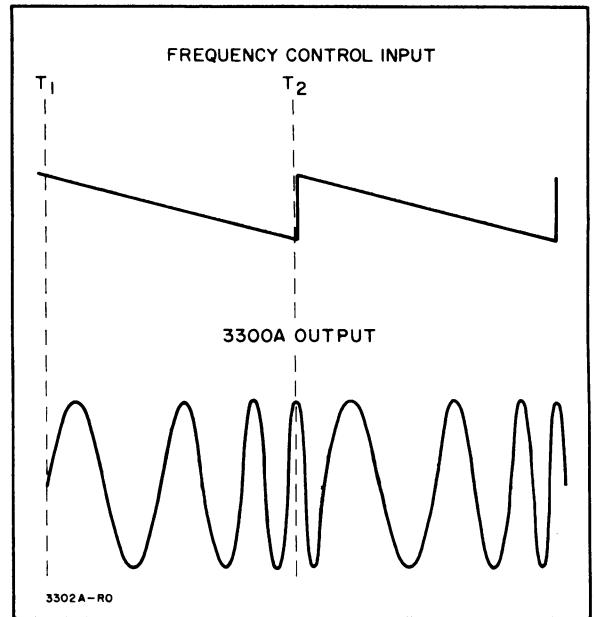

Ratio $\frac{F1}{F2}$ is variable with triangle wave amplitude and dc level where:

F1 = variable output frequency between T_1 and T_2 .

F2 = frequency at T_2 .

Both frequencies are variable with range switch.
Dc level determines center frequency.

SECTION IV

THEORY OF OPERATION

4-1. INTRODUCTION.

4-2. This section contains the theory of operation for the -hp- Model 3302A Trigger/Phase Lock Plug-in.

4-3. GENERAL DESCRIPTION.

4-4. See Figure 4-1, Block Diagram. The Model 3302A consists, basically, of an input trigger circuit, a manual trigger circuit, a Schmitt trigger, a phase multivibrator, a phase lock amplifier, a gating amplifier, a meter amplifier, and a summing circuit.

4-5. INPUT TRIGGER CIRCUIT.

4-6. The electronic input trigger circuit or the manual trigger circuit provides a triggering voltage to the Schmitt trigger. The manual triggering circuit is used in single and multiple cycle modes only. The input triggering circuit is used in single cycles, multiple cycles and phase lock mode of operation. The triggering voltage can be any waveform or pulse with amplitude greater than ± 0.5 volts peak but less than ± 20 volts peak. The INPUT PHASE switch determines if a voltage in phase or out of phase with the input signal is coupled to the Schmitt trigger.

4-7. SCHMITT TRIGGER.

4-8. The Schmitt trigger output, when tripped by the input or manual trigger voltage, is differentiated and clipped to produce a negative pulse. The negative pulse triggers the phase multivibrator.

4-9. PHASE MULTIVIBRATOR.

4-10. The phase multivibrator in single and multiple cycle is initially triggered to the "ON" state by the negative pulse from the Schmitt trigger pulse and returned to the "OFF" state by a trigger developed from the 3300A mainframe inverted square wave. In single cycle, the "OFF" trigger from the inverted square wave occurs at the most negative portion of the 3300A output. In multiple cycle mode, the arrangement of CR6 and CR7 prevents the triggers from the inverted square wave from triggering the phase multivibrator until after the Schmitt trigger returns to the "OFF" state when the gating input signal or manual trigger voltage is removed.

4-11. The output of the gating amplifier in single and multiple cycles gates the 3300A oscillator. The 3300A triangle wave input to the gating amplifier keeps the 3300A on after the phase multivibrator is triggered "OFF" so the 3300A can complete a full cycle in single cycle mode and the last cycle in multiple cycle mode. In phase lock mode, the gating amplifier exerts no control over the 3300A frequency control circuits.

4-12. In single and multiple cycle operation, the frequency of the mainframe is determined by the 3300A

RANGE switch and FREQUENCY dial, or remote control voltage and is independent of the triggering input frequency if the period of the triggering input is greater than the main frame period.

4-13. In Phase Lock mode, the phase multivibrator is triggered "ON" by a trigger developed by differentiating and clipping the input signal and "OFF" by a trigger developed by differentiating and clipping the main frame square wave. The symmetry of the output waveform is directly proportional to the phase difference between the input signal and the 3300A output. The phase difference and thus the symmetry of the phase multivibrator output is a function of the complete phase lock loop. The output of the phase multivibrator is summed with the voltage from the PHASE potentiometer and integrated by the phase lock amplifier. When the setting of the PHASE potentiometer is varied, the phase lock loop becomes temporarily unbalanced. The action of the loop on the frequency control circuits of the 3300A shifts the phase of the 3300A output until the phase relationship is such that the dc component of the phase multivibrator again balances the offset established by the PHASE potentiometer. The PHASE potentiometer can change the phase relationship between the 3302A input and 3300A output 180° for either position of the INPUT PHASE switch; thus the phase relationship between the 3300A and input signal can be varied 360° . When the CAL-UNCAL switch is in the CAL position, the main frame will only phase lock to the fundamental of the input signal. In the UNCAL position, the 3300A can be phase locked to harmonics, and a harmonic of the 3300A output can be phase locked to harmonics of the input signal.

4-14. PHASE LOCK AMPLIFIER.

4-15. The phase lock amplifier consists of a differential amplifier and an integrator capacitor. The value of the integrating capacitor is changed with 3300A range switch settings. The dc output of the integrator (phase lock amplifier) drives the meter amplifier and phase lock emitter follower.

4-16. METER AMPLIFIER.

4-17. The meter amplifier, an emitter follower, controls the current flow through the meter to provide a visual indication of phase lock.

4-18. SUMMING CIRCUIT.

4-19. The summing circuit consists of the phase lock emitter follower, frequency control emitter follower and the summing amplifier. The phase stabilizing circuit between the phase lock emitter follower and summing amplifier introduces a phase lead to stabilize the phase lock loop. As the required phase lead necessary to stabilize the loop varies with frequency, the value of the resistors and capacitors in the phase stabilizing circuit is changed with 3300A range switch settings.

4-20. PHASE LOCK EMITTER FOLLOWER.

4-21. The phase lock emitter follower isolates the phase lock amplifier from the summing amplifier.

4-22. FREQUENCY CONTROL EMITTER FOLLOWER.

4-23. The frequency control emitter follower provides a high input impedance to the 3300A and couples the 3300A frequency control voltage to the summing amplifier.

4-24. SUMMING AMPLIFIER.

4-25. The summing amplifier adds the outputs of the phase lock and frequency control emitter followers. The output of the summing amplifier is connected to the frequency control circuit of the main frame through the MODE switch.

4-26. SCHEMATIC THEORY.

4-27. All components in the 3302A except switches, C1, C2 potentiometers R1 through R4, and Phase Lock Range Meter are located on the A1 board. In the discussion on schematic theory that follows, partial reference designators are used. Refer to Figure 5-7.

4-28. TRIGGER INPUT CIRCUIT.

4-29. The trigger input circuit consists of the input emitter follower, trigger selector amplifier and manual trigger.

4-30. EMITTER FOLLOWER.

4-31. The input emitter follower, Q1, isolates the input from the trigger selector amplifier. The emitter follower output is limited to approximately ± 1 volt by CR1 and CR2 at the input of the trigger selector amplifier.

4-32. TRIGGER SELECTOR AMPLIFIER.

4-33. The trigger selector amplifier is a differential amplifier. The INPUT PHASE switch, S1, selects one of two triggering signals, one in phase with the input signal, at collector of Q3, and the other 180° out of phase, at collector of Q2. With the EXTERNAL-MANUAL Switch in EXTERNAL, the selected triggering signal is coupled to the Schmitt Trigger through S4. The output of the trigger selector amplifier is used in SINGLE, MULTIPLE, and PHASE LOCK MODE.

4-34. MANUAL TRIGGER.

4-35. The MANUAL TRIGGER is used in SINGLE and MULTIPLE MODE. In the MANUAL position, S2 connects a fixed positive bias to the base of Q4. When the MANUAL TRIGGER is depressed, a negative bias is connected to the base of Q4.

4-36. SCHMITT TRIGGER.

4-37. The quiescent state of the Schmitt Trigger, no input signal and MANUAL TRIGGER not depressed,

is Q4 on and Q5 off. The Schmitt Trigger is triggered in the following ways:

- a. With external trigger: when negative slope of triggering signal at base of Q4 goes through approximately -100 mv.
- b. By manual trigger voltage.

4-38. The Schmitt Trigger develops a sharp negative going pulse when the input goes through the on trip point. The input signal going positively back through the off trip point returns Q4 to the "ON" state. The output of the Schmitt Trigger is differentiated and clamped by C12, R27 and CR8 to eliminate a positive trigger. The negative trigger is coupled to the phase multivibrator by C13 and R29.

4-39. PHASE MULTIVIBRATOR.

4-40. The phase multivibrator serves two functions. In single and multiple cycle, the positive going output from the collector of Q6 is coupled to the gating amplifier circuit through the MODE switch S4. In phase lock mode, the output is coupled through S4 to the phase lock amplifier. Q6 in the phase multivibrator is always triggered off by the negative pulse from the Schmitt Trigger which turns Q7 on by normal multivibrator action. Q7 is triggered off by a negative trigger generated from the inverted square wave.

- a. In single cycle, the inverted square wave from the 3300A is connected through S4AR to C16 into the base circuit of Q7.
- b. In multiple cycles, the same inverted square wave is connected to the junction of CR6 and R25. CR7 is on, as the collector of Q5 is approximately at ground potential and the anode of CR7 is positive due to R26. When CR7 is on, CR6 is back biased which prevents the inverted square wave from being coupled to the differentiating network, C16 and R34. CR6 remains back biased until the Schmitt Trigger is again tripped to the quiescent state (Q5 collector +20 volts) by the input signal or the manual trigger release. CR6 now becomes forward biased, and the inverted square wave is coupled through CR6 to C16. The negative trigger developed by C16 and R34 cuts off Q7 which returns Q6 to the on state.

4-41. In phase lock mode, for the same position of the INPUT PHASE Switch used in single or multiple cycle mode, the opposite output of the trigger selector amplifier is used to trip the Schmitt Trigger. The switching is accomplished by S4BF pins 3 and 2 to maintain the proper phase relationship between the on trigger in the phase multivibrator and the off trigger which is now developed from the square wave rather than the inverted square wave. The 3300A square wave is differentiated and clamped by C9, R18 and CR5. The negative going trigger is coupled to the base circuit of Q7. Q7 is cut off which returns Q6 to the on state.

4-42. GATING AMPLIFIER.

4-43. Refer to Figure 4-2 for following discussion of gating amplifier.

4-44. The gating amplifier in free run and phase lock modes disables the negative feedback loop as CR10 in the phase circuit of Q8 is forward biased. When CR10 is forward biased, the basic oscillator in the 3300A can function.

4-45. In single and multiple cycle modes, the gating amplifier turns on the 3300A when CR10 becomes forward biased by the phase multivibrator output. The operation of the gating amplifier is the same in both modes.

4-46. The gating amplifier is cut off by conduction of CR10 which back biases CR11 and CR12. Two types of diodes are used to achieve both fast action and low leakage current. CR11 and CR12, when back biased, open the negative feedback loop from the output of the triangle integrator to the input of the gating amplifier thus enabling the triangle integrator.

4-47. The start/stop phase of the 3300A output functions is determined by the START/STOP PHASE control. The potential at the output of the triangle integrator with the negative feedback loop closed is equal to but

opposite in polarity to that at the wiper of the START/STOP PHASE control. The overall closed loop gain of these amplifiers is -1. As the START/STOP PHASE wiper is moved to a more negative position, the potential at the output of the integrator goes positive. The potential at the output of the triangle integrator, at the instant the 3300A is triggered by CR10 conducting, determines the starting phase of the single cycle or first cycle in the multiple cycle pulse and the stopping phase of the single cycle or last cycle on the multiple cycle pulse.

4-48. The gating amplifier sums three inputs, the output from the collector of Q6, triangle feedback through R50 and the negative dc potential from the START/STOP PHASE control. For a given setting of the START/STOP PHASE control, CR10 will conduct as long as Q6 collector is near ground and the input potential of the gating amplifier has not reached the quiescent state which existed at the starting phase.

4-49. In single cycle, the collector of Q6 goes negative when the 3300A output sine wave reaches a negative crest, but CR11 and 12 do not conduct until the triangle wave input reaches the potential which existed at the start of the cycle. The two extremes are depicted in Figure 4-3. In multiple cycle, the operation

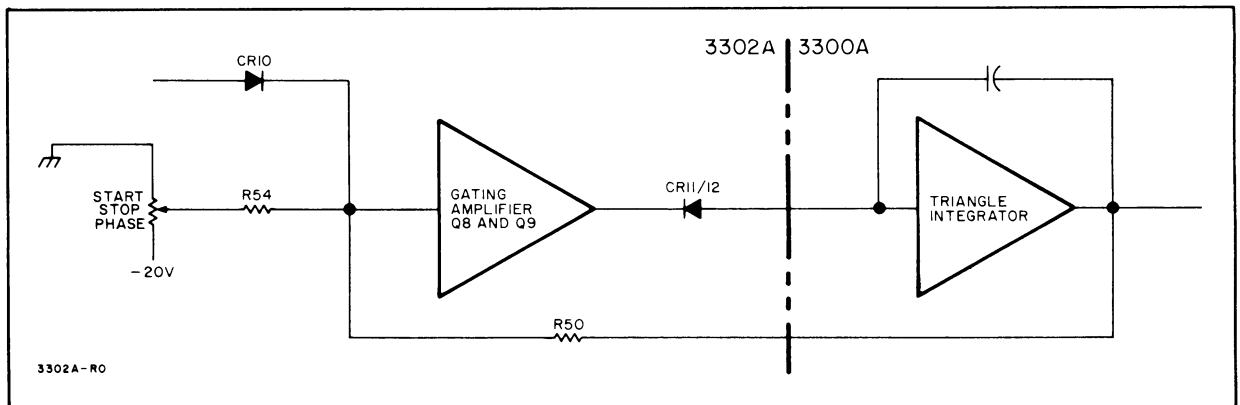

Figure 4-2. Gating Amplifier Partial Block Diagram

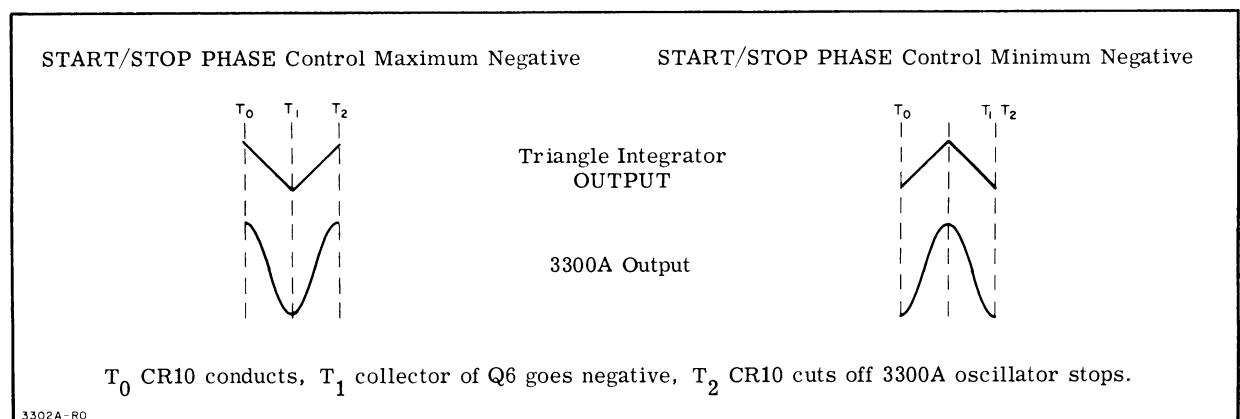

Figure 4-3. Effect of START/STOP PHASE Control on 3300A Triangle Integrator

is the same except the collector of Q6 does not go negative with each output cycle because of the blocking action of CR6 in the input to phase multivibrator.

4-50. PHASE LOCK AMPLIFIER.

4-51. The output of the phase multivibrator is summed with the current established by the PHASE control, R1, at the base of phase lock amplifier, Q10. The 0° position of the PHASE control corresponds to the wiper arm at the ground side of R1. With the CAL-UNCAL switch in UNCAL and the PHASE control at 0°, the current from the phase network to the base of Q10 is minimum and the PHASE control has maximum range for phase locking to harmonics.

5-52. Figure 4-4 depicts the phase relationship of the waveforms and associated triggers which control the phase lock amplifier.

4-53. In both a and b, the -dc component of the phase multivibrator output equals the +dc from the PHASE potentiometer. The symmetry of the phase multivibrator has been changed by the "OFF" trigger developed from the 3300A square wave. Q10 base current is constant and the phase lock loop then maintains the phase difference selected.

4-54. When the PHASE Control is repositioned, the currents to the base of Q10 become unbalanced, and the output of the phase lock amplifier attempts to change the frequency of the 3300A. A frequency change does not occur; the only result is that the phase relationship between the 3302A INPUT and the 3300A OUTPUT is changed until the currents to the base of Q10 are again equal. The phase lock loop then maintains the phase difference selected. At the midpoint of the above

two extremes, 90°, the phase multivibrator output is a symmetrical square wave.

4-55. In the UNCAL position of the CAL-UNCAL switch, with R36 in the circuit, the current limit of the phase control is increased. The positive going pulse (Q6 cutoff) of the phase multivibrator is made narrower for a given setting of the phase control to achieve harmonic lock on.

4-56. C17 through C20 from the collector to the base of Q10 integrates the phase lock amplifier input. The capacitor in the circuit is a function of the 3300A RANGE switch setting. Q10 and Q11 make up a differential amplifier with R40 and R41 degenerating resistors to maintain a constant gain with changing transistor parameters. The 0° Phase Adj, R3, and 180° Phase Adj, R2, vary the current into the base of Q10 to establish the two end points of the PHASE dial.

4-57. METER AMPLIFIER.

4-58. The meter amplifier is an emitter follower. When phase locked, Q10 collector potential is approximately 7.5 volts. The current through Q13 with +7.5 volts on the base is approximately 0.5 ma, and the meter indicator is at the midpoint of the scale as meter M1 is a 1 ma meter movement.

4-59. PHASE LOCK EMITTER FOLLOWER.

4-60. The phase lock emitter follower couples the output of the phase lock amplifier into the emitter circuit of the summing amplifier. The RC networks, R42 - C22 through R46 - C26, one of which is selected by the 3300A RANGE switch, aid in stabilizing the phase lock loop.

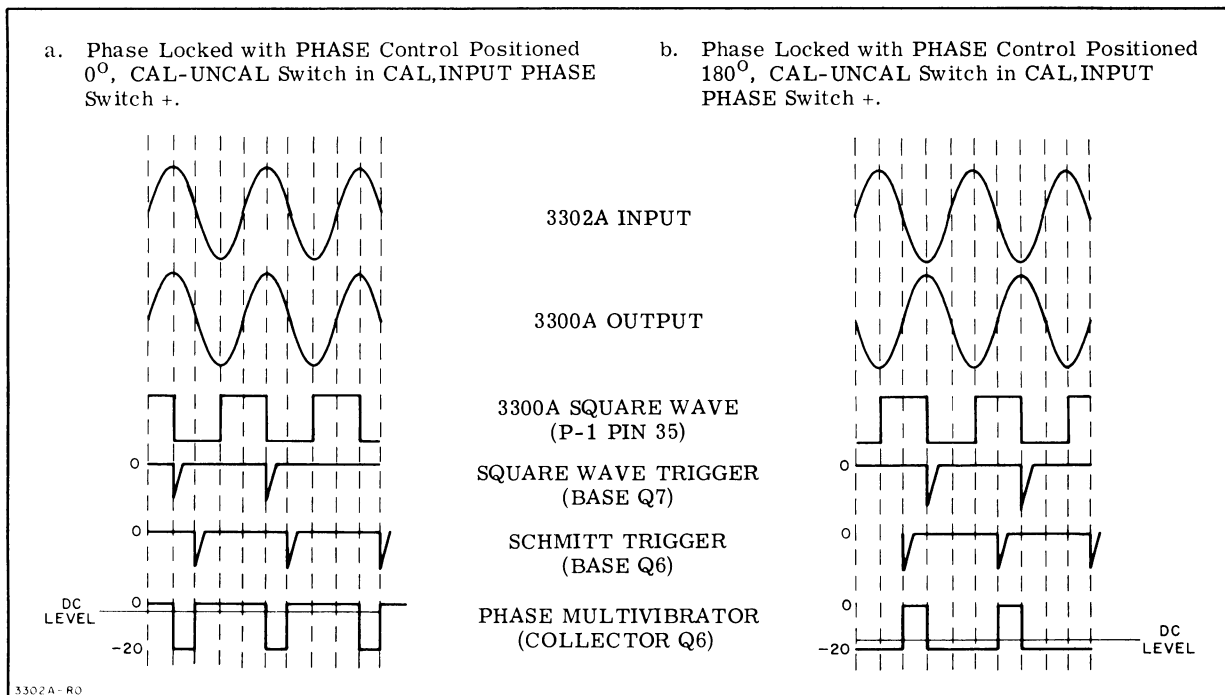

Figure 4-4. Loop Waveform Relationship

4-61. EMITTER FOLLOWER, Q15.

4-62. Q15 functions only in the phase lock mode. In the other three modes, the output from the FREQUENCY dial or remote frequency voltage is routed through the 3302A to the frequency control circuits of the 3300A. In the phase lock mode, the control voltage is coupled through Q15 into the emitter circuit of the summing amplifier.

4-63. SUMMING AMPLIFIER.

4-64. The summing amplifier Q14 sums the 3300A FREQUENCY dial or remote frequency control and the output of the phase lock emitter follower. The

lock range is approximately 10% of the maximum dial setting. Variation of the PHASE dial increases the captive range to that of the lock range. The collector voltage ranges between 0 and -10 volts. The Low Frequency Dial Adjust R5 and the High Frequency Dial Adjust R7 in the emitter circuit of Q14 calibrate the 3302A to the 3300A FREQUENCY dial. CR13 and R64 provide temperature compensation for the summing amplifier. The summing amplifier output is coupled through the MODE switch to the frequency control circuit of the 3300A. The shorting bars on P1 between pins 14 and 39 and between pins 40 and 15 are necessary for 3300A/3302A operation. These pairs of pins will be used with later plug-ins.

SECTION V MAINTENANCE

5-1. INTRODUCTION.

5-2. This section contains information necessary for the proper maintenance of the -hp- Model 3302A Trigger/Phase Lock Plug-in. Included are performance checks, adjustment procedures, troubleshooting procedures, schematics, maintenance correlation table, and location diagrams.

5-3. As all components are mounted on the A1 pc board except C1, C2, the switches, meter and variable resistors R1 through R6, partial reference designators are used throughout this section.

5-4. PERFORMANCE CHECKS AND PRELIMINARY ADJUSTMENTS.

5-5. Test equipment required is listed in Table 5-1. Test equipment with comparable characteristics can be substituted.

5-6. The performance checks presented in this section are designed to compare the 3302A with its specifications. Allow a 30 minute period for the 3300A oven temperature to stabilize before proceeding with checks or adjustments.

5-7. If a performance check cannot be performed, refer to maintenance correlation Table 5-3 for applicable alignment and troubleshooting information.

5-8. FREE RUN MODE CHECK.

- a. Test equipment required: Oscilloscope.
- b. Lock 3302A into 3300A and turn on 3300A.
- c. Connect 3300A CHANNEL B OUTPUT to scope and set scope vertical sensitivity to 5 v/cm.
- d. Set 3302A MODE switch to FREE RUN.
- e. Set 3300A controls as follows:
 FREQUENCY Dial 1
 RANGE Switch X10K
 CHANNEL B Function Switch SINE
- f. Adjust 3300A CHANNEL B AMPLITUDE control for 30 volts peak-to-peak.

NOTE

Retain this setting of CHANNEL B OUTPUT for remaining checks.

- g. Turn FREQUENCY Dial of 3300A to 10.
- h. Check that FREQUENCY Dial is controlling frequency.

5-9. SINGLE AND MULTIPLE CYCLE MODE CHECK EXTERNAL.

NOTE

The letters i, l and o are not used in alphabetical list of procedural steps.

- a. Test equipment required: Oscillator and oscilloscope.
- b. Connect instruments as shown in Figure 5-1.
- c. Set 3302A controls as follows:
 EXTERNAL-MANUAL Switch . . . EXTERNAL
 START/STOP PHASE Knob Centered
 MODE Switch SINGLE
 FREQUENCY Switch >50 Kc
- d. Set oscillator for 10 KHz and adjust output for 12 volts peak-to-peak.
- e. Sync scope with Channel A, oscillator input, and adjust sweep time to display 2 or 3 cycles of the 10 KHz oscillator output. Adjust vertical sensitivity for 2 v/cm.
- f. Set 3300A Frequency to 100 KHz.
- g. Position INPUT PHASE Switch to +.
- h. Check the 3300A output for a single cycle starting at approximately the zero reference of the sine wave on the positive slope. Vary starting and stopping phase with the START/STOP PHASE control and set the 3300A output cycle to begin at 0° phase. (See Figure 5-2.)

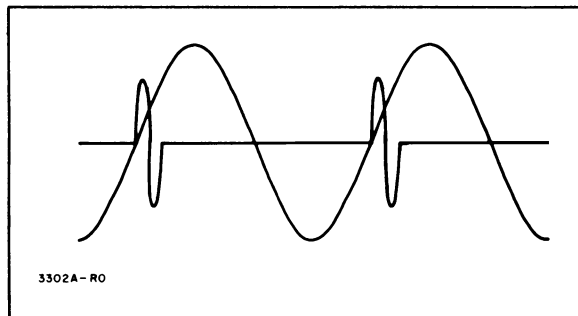

Figure 5-2. Single Cycle Phase Relationship

- j. Position INPUT PHASE Switch to -.
- k. Check that the 3300A output now begins at approximately 0 volts on the oscillator output but on the negative slope.
- m. Rotate START/STOP PHASE Dial between +90 and -90 and check that the starting phase of the 3300A output changes from +90° to -90°.

NOTE

3300A may free run at maximum CW or CCW positions.

- n. Position MODE Switch to MULTIPLE and check 3300A output for oscillations during negative portion of 10 KHz oscillator waveform.

NOTE

Last cycle will be completed during positive part of 10 KHz wave.

- p. Switch INPUT PHASE Switch to + and check 3300A output for oscillation during positive half of 10 KHz oscillator waveform.

5-10. SINGLE AND MULTIPLE CYCLE MODE CHECK MANUAL.

- a. Test equipment required: Oscilloscope.
- b. Connect 3300A CHANNEL B OUTPUT to the oscilloscope.
- c. Set 3302A controls as follows:
 EXTERNAL-MANUAL Switch . . . MANUAL
 START/STOP PHASE Control . . . Centered
 MODE Switch SINGLE
- d. Set 3300A controls as follows:
 CHANNEL B Function Switch SINE
 FREQUENCY Dial 10
 RANGE Switch X.1
- e. Dc couple the oscilloscope and adjust sweep for free run.
- f. Depress 3302A MANUAL TRIGGER button.
- g. Observe that the oscilloscope trace moves in the vertical axis for one cycle, starting and stopping at the same place.
- h. Set 3302A MODE switch to MULTIPLE.

- j. Depress 3302A MANUAL TRIGGER button and check that the 3300A free runs, as indicated by continuous vertical deflection of the trace, until the MANUAL TRIGGER button is released.

5-11. TRIGGER AMPLITUDE CHECK.

- a. Test equipment required: Dc voltmeter, 0 - ±1500 mv dc power supply (see Figure 5-3 for construction) and an oscilloscope.

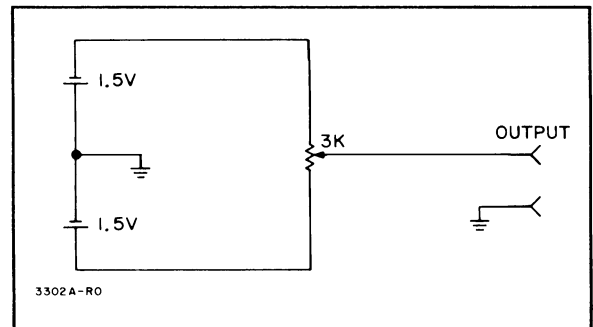

Figure 5-3. 0 - ±1500 MV Power Supply

- b. Connect test equipment as shown in Figure 5-4, Trigger Amplitude Check Test Setup.
- c. Set 3302A controls as follows:
 MODE Switch MULTIPLE
 INPUT PHASE Switch - (minus)
 EXTERNAL-MANUAL Switch . . . EXTERNAL
- d. Set 3300A controls as follows:
 FREQUENCY Dial 10
 RANGE X10K

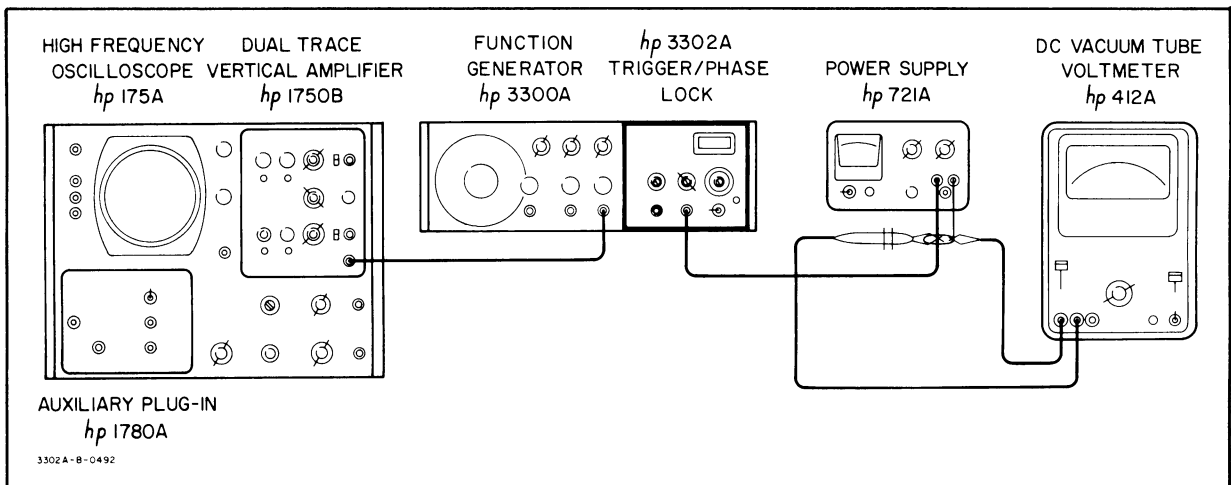

Figure 5-4. Trigger Amplitude Check Test Setup

- e. Vary power supply voltage and measure voltages at which 3300A starts and stops oscillating. 3300A should start and stop between 0 and -500 mv.
- f. Set 3302A INPUT PHASE Switch to + and reverse leads to the power supply.
- g. Vary the power supply voltage and measure voltage at which 3300A starts and stops oscillating. 3300A should start and stop oscillating between 0 and +500 mv.

5-12. PHASE LOCK MODE CHECK.

NOTE

Phase lock of the 3300A to the oscillator may not be obtained immediately as the integrator capacitor must be charged to a nominal value before lock can be obtained. The setting of the PHASE dial also affects the time required to obtain PHASE LOCK.

5-13. FREQUENCY DIAL CHECK.

- a. Equipment required: Oscillator and oscilloscope.
- b. Connect equipment as shown in Figure 5-1.
- c. Set 3302A controls as follows:

MODE	PHASE LOCK
FREQUENCY Dial	<50 Kc
INPUT PHASE	+
CAL-UNCAL	CAL
- d. Set 3300A controls as follows:

RANGE	X100
FREQUENCY Dial	1
CHANNEL B Function Switch	SINE
- e. Adjust oscillator for a frequency of 100 Hz and 10 volt peak-to-peak output.
- f. Obtain PHASE LOCK by slowly rotating PHASE control. The LOCK RANGE meter should center. If meter does not center, slowly adjust FREQUENCY dial until meter centers. FREQUENCY dial should indicate 1 ±3 minor divisions.

NOTE

If RANGE LOCK meter is offset to left of center, setting the PHASE Dial to 0° will decrease time required to obtain phase lock. If meter is offset to right of center, set the PHASE Dial to 180°.

- g. Change frequency of oscillator to 1 KHz and 3300A FREQUENCY Dial to 10.
- h. Obtain phase lock, meter should center. If meter does not center, slowly adjust FREQUENCY Dial until meter centers. FREQUENCY Dial should indicate 1 ±3 minor divisions.

5-14. PHASE LOCK DIAL AND DISTORTION CHECK.

- a. Equipment required: Oscillator, oscilloscope and distortion analyzer.
- b. Connect instruments as shown in Figure 5-5.
- c. Set 3302A controls as follows:

MODE Switch	PHASE LOCK
CAL-UNCAL Switch	CAL
INPUT PHASE Switch	+
- d. Set oscillator frequency to 1 KHz and amplitude to 10 volts peak-to-peak.
- e. Set 3300A controls as follows:

RANGE	X100
FREQUENCY Dial	X10
CHANNEL A AND B Function Switches	SINE
- f. Obtain phase lock and adjust PHASE Dial until oscillator and 3300A sine waves are in phase. PHASE Dial should read 0° ±10°.
- g. Turn PHASE Dial to 180° and INPUT PHASE Switch to - (minus). Check that 3300A is still phase locked.
- h. Adjust PHASE Dial until waveforms are in phase with each other. PHASE Dial should read 180° ±10°.
- j. Set oscillator to 10 cps, 3300A RANGE to X10 and FREQUENCY Dial to 1.
- k. Position 3302A FREQUENCY Switch to less than 50 KHz. Place 3302A INPUT to - (minus) and obtain phase lock.
- m. Adjust PHASE DIAL until waveforms are in phase. PHASE Dial should read 180° ±10°.
- n. Set 3302A in free run and measure distortion of 3300A OUTPUT. Note distortion reading.
- p. Set 3302A MODE Switch to PHASE LOCK and INPUT to +. Check that 3300A is still phase locked.
- q. Adjust PHASE Dial until waveforms are in phase. PHASE Dial should read 0° ±10°.
- r. While still phase locked, measure distortion of 3300A OUTPUT. Introduced distortion (distortion while phase locked minus distortion in free run operation step n above) should not exceed 1.0%.
- s. Refer to Table 5-2 for additional PHASE Dial accuracy and distortion checks.

5-15. HARMONIC LOCK ON CHECK.

- a. Test Equipment required: Oscillator and oscilloscope.
- b. Connect equipment as shown in Figure 5-1.
- c. Set 3300A controls as follows:

RANGE	X1K
CHANNEL B Output	SINE

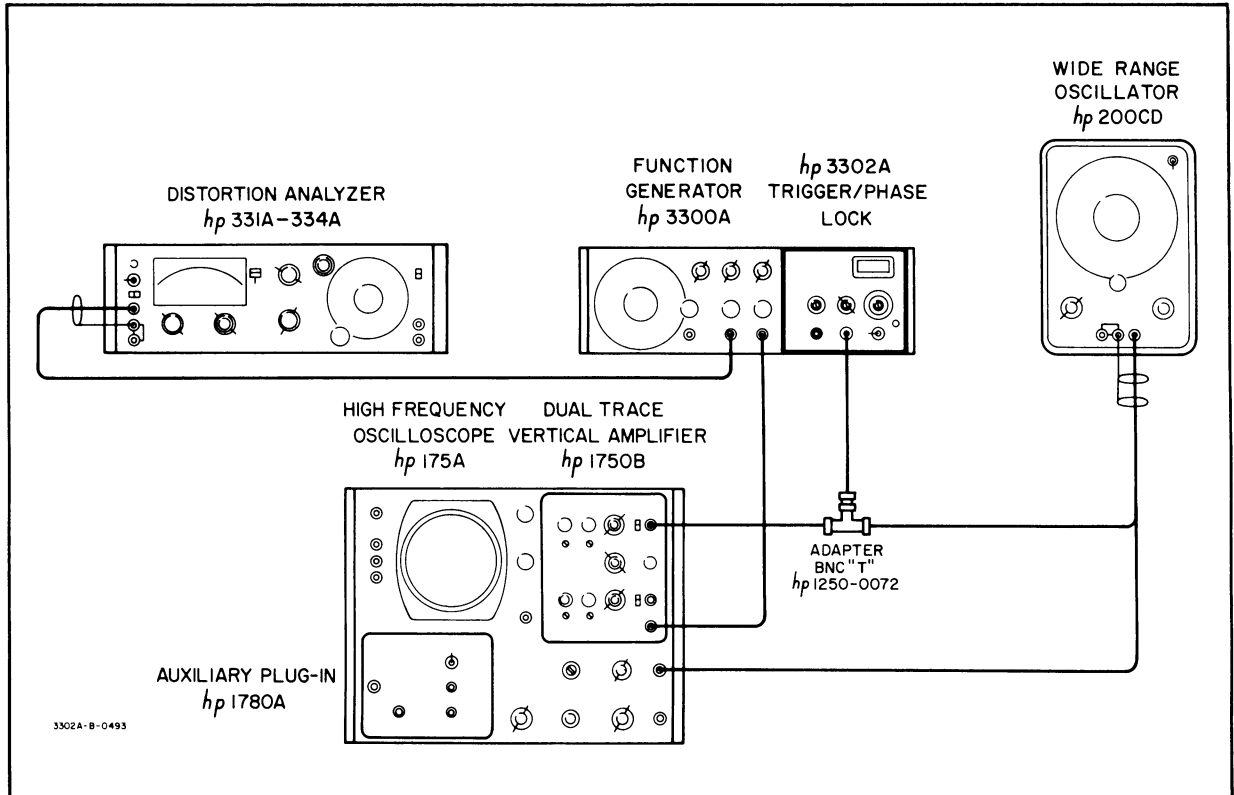

Figure 5-5. Distortion Check Test Setup

Table 5-2. Phase Dial Accuracy and Distortion Checks

OSCILLATOR FREQUENCY	3300A		3302A			LIMITS	
	FREQUENCY DIAL	RANGE	PHASE DIAL	INPUT PHASE	FREQUENCY SWITCH	PHASE DIAL	INTRODUCED DISTORTION
100 Hz	1	X100	0°	+	<50 Kc	±10°	1%
100 Hz	1	X100	180°	-	<50 Kc	±10°	1%
1 KHz	1	X1K	0°	+	<50 Kc	±10°	1%
1 KHz	1	X1K	180°	-	<50 Kc	±10°	1%
10 KHz	1	X10K	180°	-	<50 Kc	±20°	2%
10 KHz	1	X10K	0°	+	<50 Kc	±20°	2%
50 KHz	5	X10K	0°	+	>50 Kc	±20°	2%
50 KHz	5	X10K	180°	-	>50 Kc	±20°	2%
100 KHz	10	X10K	0°	+	>50 Kc	±20°	2%
100 KHz	10	X10K	180°	-	>50 Kc	±20°	2%

- d. Set 3302A controls as follows:
- MODE PHASE LOCK
 CAL-UNCAL UNCAL
 FREQUENCY <50 Kc
- e. Set oscillator output to 1 KHz and amplitude to 10 volts peak-to-peak.
- f. Set 3300A FREQUENCY Dial to 2 and obtain phase lock to second harmonic. Check that

3302A PHASE Dial changes phase of 3300A OUTPUT.

- g. Repeat step f with 3300A FREQUENCY Dial set at 5 and 10. Check that 3300A locks to fifth and tenth harmonic.

NOTE

In UNCAL position, PHASE Dial is not calibrated, and phase lock

can be lost if the phase relation of the harmonic is shifted greater than 90°.

5-16. ADJUSTMENT AND CALIBRATION.

5-17. The adjustment and calibration procedures are designed to adjust and calibrate the -hp- Model 3302A and should be undertaken only if the performance checks indicate the instrument does not meet specifications. Refer to Table 5-3, Maintenance Correlation, for applicable paragraphs for performance checks and troubleshooting information.

5-18. When it is necessary to repair or adjust the 3302A, the top cover of the 3300A must be removed. To remove the 3300A top cover, remove the two phillips screws and slide the cover to the rear.

5-19. R5 AND R6, LOW AND HIGH FREQUENCY DIAL ADJUSTMENTS.

- a. Equipment required: Oscilloscope and oscillator.
- b. Connect equipment as shown in Figure 5-1.
- c. Set 3302A controls as follows:
 MODE PHASE LOCK
 FREQUENCY <50 Kc
 INPUT PHASE +
 CAL-UNCAL CAL

- d. Set 3300A controls as follows:
 RANGE X100
 FREQUENCY Dial X1
 CHANNEL B Function Switch SINE
- e. Adjust oscillator for a frequency of 100 Hz and for 10 volts peak-to-peak output.
- f. Obtain phase lock by slowly rotating PHASE control. Set 3302A CHANNEL B AMPLITUDE to 10 volts peak-to-peak. Slowly adjust R5 Low Frequency Dial until LOCK RANGE meter centers.
- g. Change frequency of oscillator to 1 KHz and 3300A FREQUENCY Dial to 10.
- h. Obtain phase lock. Slowly adjust R6 High Frequency Dial Adjust until Lock Range meter centers.
- j. Recheck that meter is centered at 100 Hz and readjust R5 if necessary.
- k. Recheck that meter is centered at 1 KHz and readjust R6 if necessary.

5-20. PHASE LOCK DIAL ADJUST.

- a. Equipment required: Oscillator and Oscilloscope.
- b. Connect instruments as shown in Figure 5-1.
- c. Set 3302A controls as follows:
 MODE Switch PHASE LOCK
 CAL-UNCAL CAL
 INPUT PHASE +
- d. Set oscillator frequency to 1 KHz and amplitude to 10 volts peak-to-peak.

Table 5-3. Maintenance Correlation

FUNCTION	PERFORMANCE CHECKS PARAGRAPHS	ALIGNMENT PARAGRAPHS	THEORY AND AIDS PARAGRAPHS
Free Run Mode	5-8	N/A	1-8
Single Cycle Mode	5-9	N/A	4-5 thru 4-12 4-30 thru 4-49
Multiple Cycle Mode	5-9	N/A	4-5 thru 4-12 4-30 thru 4-49
Manual Triggering	5-10	N/A	4-6 thru 4-35
Trigger Amplitude	5-11	N/A	4-6 Table 5-4
Phase Lock Mode	5-12	N/A	4-13 thru 4-24 4-41 4-50 thru 4-64
Harmonic Phase Lock	5-15	N/A	4-13, 4-55
Frequency Dial Calibrate	5-13	5-19	4-64
Phase Dial Calibrate	5-14 Table 5-2	5-20	4-56
C-28	N/A	5-21	N/A
Distortion Introduced	5-14	N/A	Table 5-4

- e. Set 3300A controls as follows:
 RANGE X100
 FREQUENCY Dial X10
 CHANNEL B Function Switch SINE
 CHANNEL B AMPLITUDE Equal to
 oscillator waveform
- f. Obtain phase lock and set PHASE Dial to 0° .
- g. Adjust R3, 0° Phase Adjust until 3300A and oscillator sine waves are in phase.

NOTE

If PHASE Dial has slipped on shaft center R3, 0° Phase adjust and R4, 180° Phase, adjust potentiometers. Obtain phase lock and adjust PHASE Dial until 3300A and oscillator waveforms are in phase. Loosen PHASE Dial set screws and set PHASE Dial to zero. Retighten set screws.

- h. Position 3302A INPUT PHASE Switch to - and turn PHASE Dial to 180° .
- j. Adjust R2, 180° Phase Adjust until waveforms are in phase.

5-21. C28 ADJUST.

- a. Test equipment required: Oscilloscope and Oscillator.
- b. Connect test equipment as shown in Figure 5-1.
- c. Set 3302A controls as follows:
 EXTERNAL-MANUAL Switch. . . EXTERNAL
 START/STOP PHASE Knob Centered
 MODE Switch SINGLE
 INPUT PHASE Switch +
 FREQUENCY Switch >50 Kc

- d. Set 3300A controls as follows:
 CHANNEL B Function Switch SINE
 FREQUENCY Dial 10
 RANGE X10K

- e. Set oscillator for 10 KHz and adjust output level for 10 volts peak-to-peak.
- f. Adjust 3300A AMPLITUDE control and obtain a scope picture similar to Figure 5-2.
- g. Expand sweep on oscilloscope and set a single cycle of 3300A in center of scope.
- h. Adjust C28 for no overshoot or undershoot at end of the single sine wave. Use non-metallic adjust tool.

5-22. TROUBLESHOOTING PROCEDURES.

5-23. These troubleshooting procedures are designed to assist in isolating a malfunction and are based on a systematic analysis of the instrument to localize the trouble. These operations should be undertaken only after it has been established that the difficulty cannot be eliminated by the adjustment and calibration procedures. An investigation should also be made to ensure that the trouble is not a result of conditions external to the 3300A/3302A.

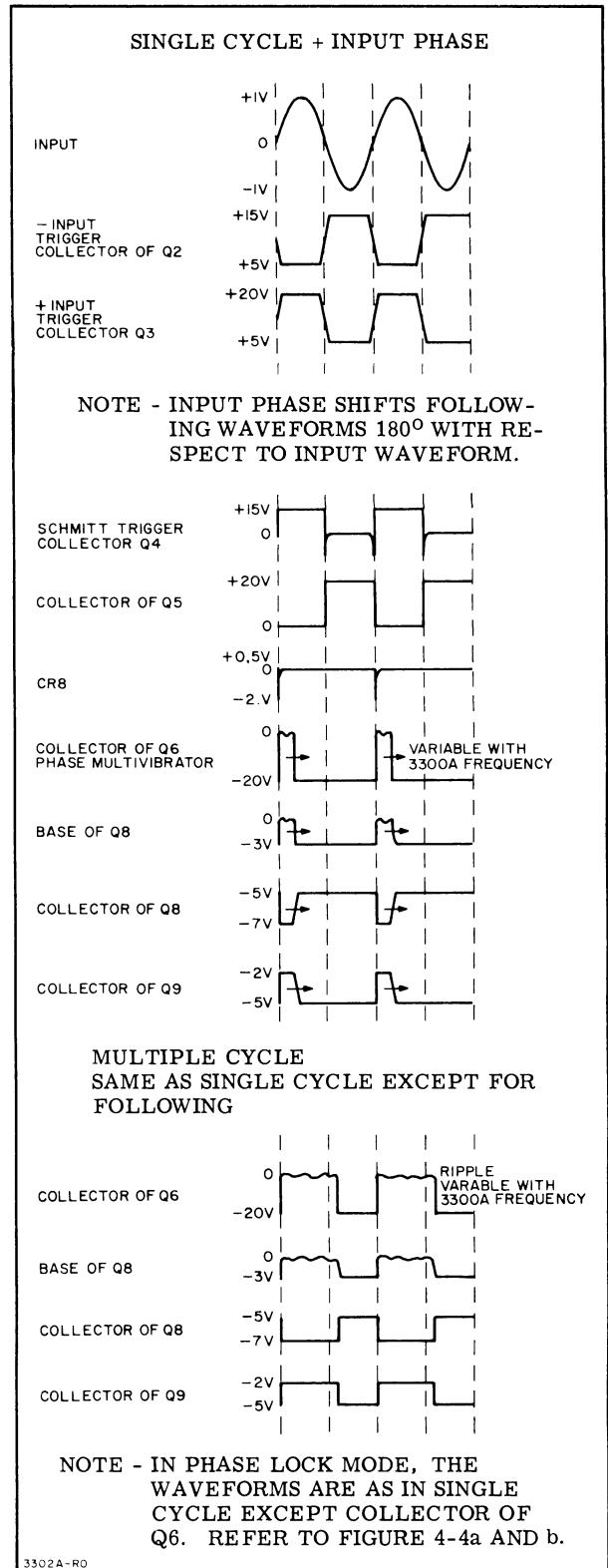

Figure 5-6. Typical Waveforms and Phase Relationship

5-24. To troubleshoot the 3302A, first insure the trouble is in the 3302A Plug-in by checking 3300A operation with either the 3301A aux plug-in or the malfunctioning isolating aid. This aid is described in Section V of 3300A Operating and Service Manual.

5-25. Conduct a visual check of the 3302A for possible burned or loose components, loose connections, or any obvious condition which might be a source of trouble.

5-26. The checks outlined in this section are not designed to measure all circuit parameters rather only

to localize the problem. Therefore, it is highly probable that additional checks will be required to completely isolate the malfunction. Amplifier gain may also vary slightly between instruments; therefore, it is not necessary to precisely duplicate waveforms or voltages described.

5-27. Table 5-4 contains a summary of front panel symptoms that can be used in initial efforts to select a starting point for troubleshooting; all are based on the assumption the trouble is in the plug-in unit. Figure 5-6 contains typical waveforms and their phase relationship.

Table 5-4. Troubleshooting Aid

SYMPTOM	POSSIBLE CAUSE
No output any mode.	Gating amplifier Q8, Q9 conducting.
3300A Output in Free Run Mode only.	Input trigger circuit; Schmitt Trigger. Phase multivibrator.
3300A Output in Single, Multiple, Mode in Manual but not in External.	Input Emitter follower, Q1, Trigger selector Amplifier, S1, and S4BF triggering voltage.
Operation normal in Single, Multiple, and Free Run but unable to Phase Lock.	Phase Lock Amplifier, Phase Lock Emitter Follower, Emitter Follower Q15, summing amplifier and CR5, C9, and R18.
3300A Operation same in Single and Multiple cycles, single cycle output. Can achieve Phase Lock to Fundamental in CAL but not to harmonics in UNCAL Position of S5.	CR7 open. CR6 shorted. R36.
On-Off trigger voltage not within limits.	Change value of R7. Increase value to shift both plus and minus on/off points in a negative direction. LIMITS 0.5 M Ω to out of circuit.
PHASE Dial accuracy out of specs at 100 KHz.	Change value of C5. Increase value to decrease a plus error. LIMIT 100 pf to 1000 pf.
Distortion on 10 KHz range.	Check C25.
Fifth and tenth harmonics of 1000 Hz very difficult to lock on.	Check C19.
Free runs when in single cycle at high dial setting on X10K range.	Check C14.
Distortion and bad phase lock on one range only.	Check appropriate capacitor C17 thru C19 and C22 thru C25.

WIRE COLOR CODE	
BLACK	0
BROWN	1
RED	2
ORANGE	3
YELLOW	4
GREEN	5
BLUE	6
VIOLET	7
GRAY	8
WHITE	9

2N70B
AND
1853009

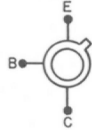

2N3391



2N3638

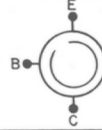

PI

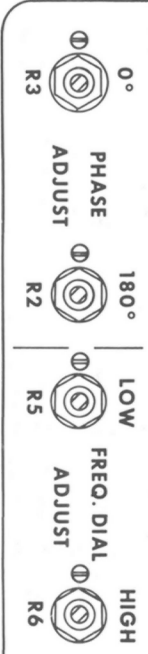
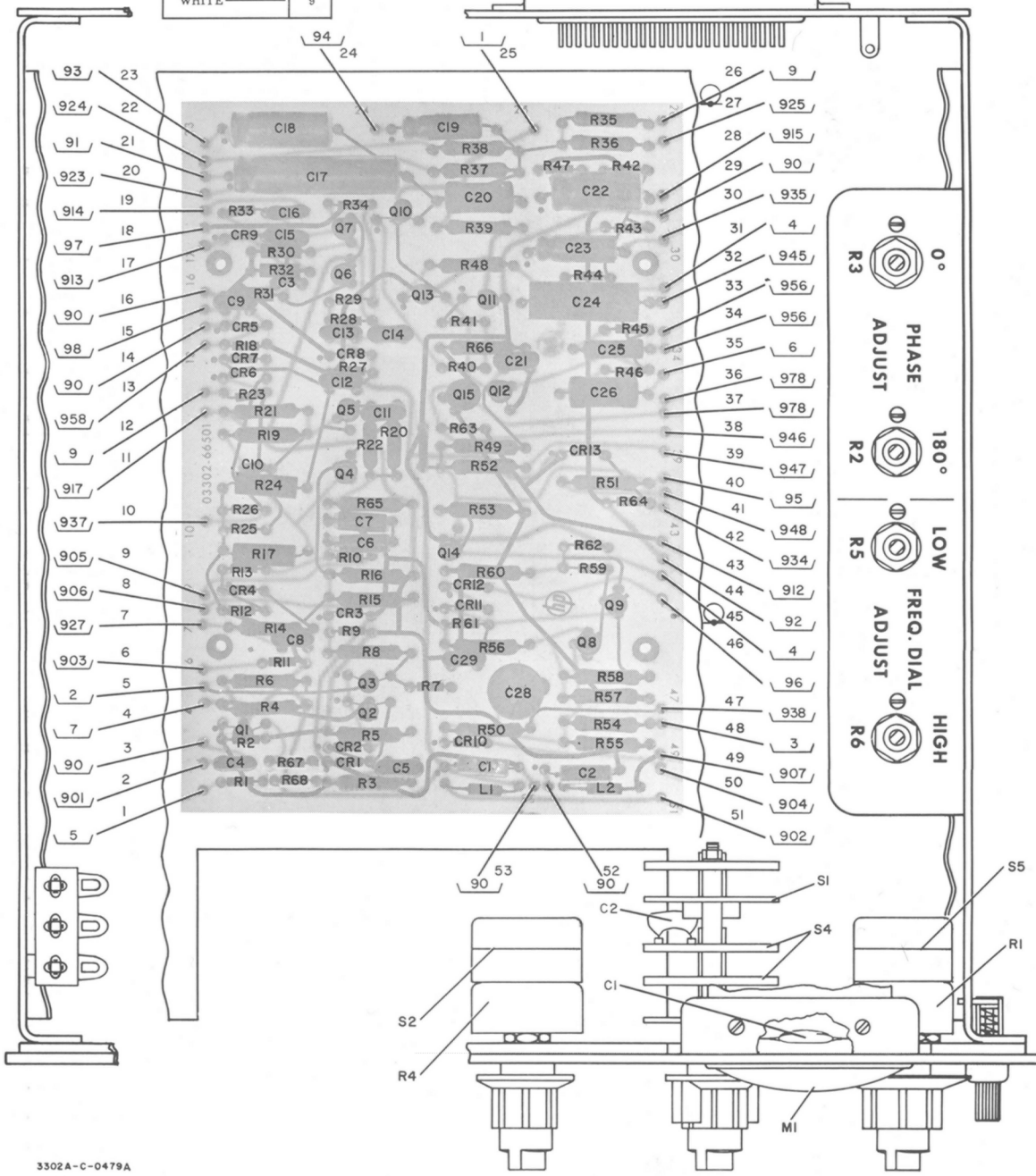

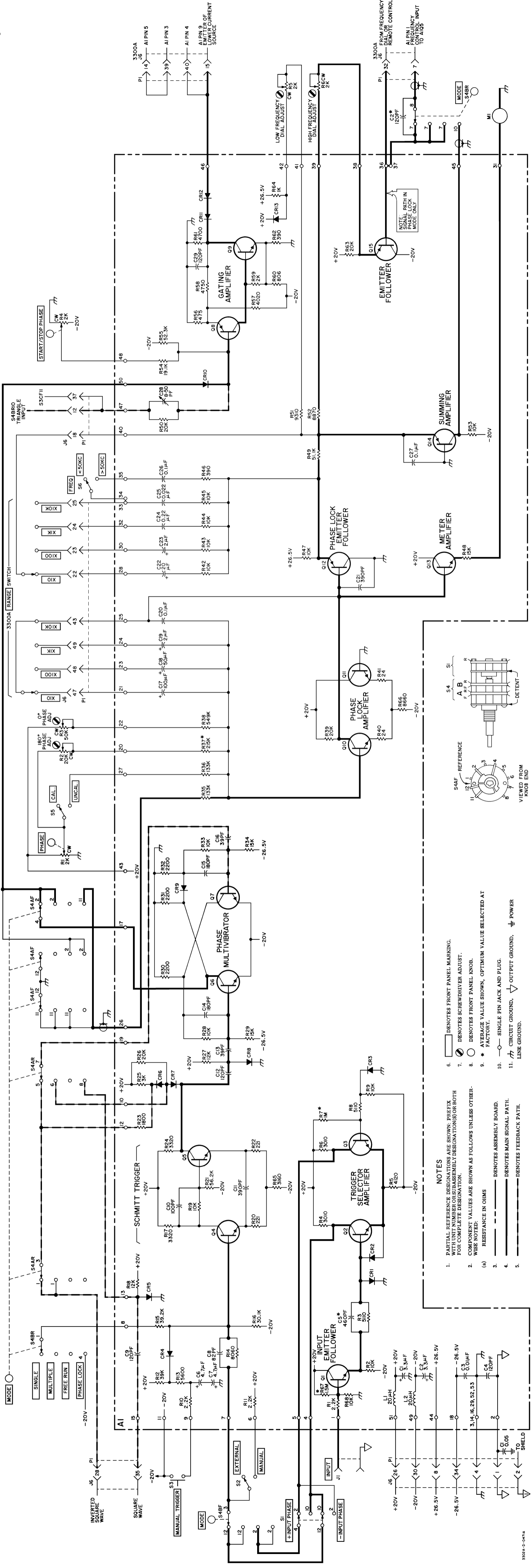

- NOTES**
- PARTIAL REFERENCE DESIGNATIONS ARE SHOWN: PREFIX WITH UNIT NUMBER OR SUBASSEMBLY DESIGNATION(S) OR BOTH FOR COMPLETE DESIGNATION.
 - COMPONENT VALUES ARE SHOWN AS FOLLOWS UNLESS OTHERWISE NOTED:
(a) RESISTANCE IN OHMS
 — DENOTES ASSEMBLY BOARD.
 — DENOTES MAIN SIGNAL PATH.
 — DENOTES FEEDBACK PATH.
 - DENOTES SINGLE PIN JACK AND PLUG.
 - DENOTES CIRCUIT GROUND, ▽ OUTPUT GROUND, ⊕ POWER LINE GROUND.
 - DENOTES FRONT PANEL MARKING.
 - ⊙ DENOTES SCREWDRIVER ADJUST.
 - DENOTES FRONT PANEL KNOB.
 - * AVERAGE VALUE SHOWN, OPTIMUM VALUE SELECTED AT FACTORY.
 - SINGLE PIN JACK AND PLUG.
 - CIRCUIT GROUND, ▽ OUTPUT GROUND, ⊕ POWER LINE GROUND.

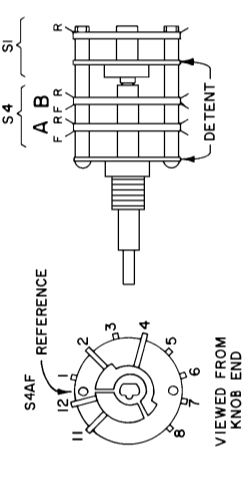

Figure 5-7. Schematic Diagram 01787-1 5-9

SECTION VI REPLACEABLE PARTS

6-1. INTRODUCTION.

6-2. This section contains information for ordering replacement parts. Table 6-1 lists parts in alphabetic order of their reference designators and indicates the description, -hp- part number of each part, together with any applicable notes, and provides the following:

- a. Total quantity used in the instrument (TQ column). The total quantity of a part is given the first time the part number appears.
- b. Description of the part. (See list of abbreviations below.)
- c. Typical manufacturer of the part in a five-digit code. (See Appendix A for list of manufacturers.)
- d. Manufacturer's part number.

6-3. Miscellaneous parts are listed at the end of Table 6-1.

6-4. ORDERING INFORMATION.

6-5. To obtain replacement parts, address order or inquiry to your local Hewlett-Packard Field Office. (See Appendix B for list of office locations.) Identify parts by their Hewlett-Packard part numbers.

6-6. NON-LISTED PARTS.

6-7. To obtain a part that is not listed, include:

- a. Instrument model number.
- b. Instrument serial number.
- c. Description of the part.
- d. Function and location of the part.

REFERENCE DESIGNATORS

A = assembly	F = fuse	P = plug	V = vacuum tube, neon bulb, photocell, etc.
B = motor	FL = filter	Q = transistor	W = cable
C = capacitor	J = jack	R = resistor	X = socket
CR = diode	K = relay	RT = thermistor	XF = fuseholder
DL = delay line	L = inductor	S = switch	XDS = lampholder
DS = device signaling (lamp)	M = meter	T = transformer	Z = network
E = misc electronic part	MP = mechanical part		

ABBREVIATIONS

a = amperes	elect = electrolytic	mtg = mounting	rot = rotary
bp = bandpass	encap = encapsulated	my = mylar	rms = root-mean-square
bwo = backward wave oscillator	f = farads	NC = normally closed	rmo = rack mount only
c = carbon	fxd = fixed	Ne = neon	s-b = slow-blow
cer = ceramic	Ge = germanium	NO = normally open	Se = selenium
cmo = cabinet mount only	grd = ground (ed)	NPO = negative positive zero (zero temperature coefficient)	sect = section(s)
coef = coefficient	h = henries	nsr = not separately replaceable	Si = silicon
com = common	Hg = mercury	obd = order by description	sil = silver
comp = composition	imp = impregnated	p = peak	sl = slide
conn = connection	incd = incandescent	pc = printed circuit board	td = time delay
crt = cathode-ray tube	ins = insulation (ed)	pf = picofarads = 10^{-12} farads	TiO ₂ = titanium dioxide
dep = deposited	K = kilo = 1000	pp = peak to peak	tog = toggle
EIA = Tubes or transistors meeting Electronic Industries' Association standards will normally result in instrument operating within specifications; tubes and transistors selected for best performance will be supplied if ordered by stock numbers.	lin = linear taper	piv = peak inverse voltage	tol = tolerance
	log = logarithmic taper	pos = position (s)	trim = trimmer
	m = milli = 10^{-3}	pot = potentiometer	tw = traveling wave tube
	M = megohms	rect = rectifier	var = variable
	ma = milliamperes		w/ = with
	μ = micro = 10^{-6}		W = watts
	minat = miniature		ww = wirewound
	mfgl = metal film on glass		w/o = without
	mfr = manufacturer		* = optimum value selected at factory, average value shown (part may be omitted)

Table 6-1. Replaceable Parts

REF. DESIG.	-hp- PART NO.	TQ	DESCRIPTION	MFR.	MFR. PART NO.
A1	03302-66501	1	Assembly: pc includes C1 thru C29 Q1 thru Q15 CR1 thru CR13 R1 thru R68 L1, L2	28480	03302-66501
A1C1, A1C2	0180-0161	2	C: fxd Ta elect 3.3 μ f \pm 20% 35 vdcw	56289	150D335 X 0035 B2
A1C3	0150-0093	1	C: fxd cer 0.01 μ f +80% -20% 100 vdcw	91418	TA obd
A1C4	0140-0216	4	C: fxd mica 120 pf \pm 2% 300 vdcw	04062	RDM15F121G3C
A1C5*	0140-0232	1	C: fxd mica 460 pf \pm 1%	04062	RDM15F461F3C
A1C6, A1C7	0180-0100	2	C: fxd solid Ta elect 4.7 μ f \pm 10% 35 vdcw	56289	150D475 X 9035 B2
A1C8	0140-0193	1	C: fxd mica 82 pf \pm 5% 300 vdcw	04062	RDM15E820J3C
A1C9	0140-0216	1	C: fxd mica 120 pf \pm 2% 300 vdcw	04062	RDM15F121G3C
A1C10	0150-0073	1	C: fxd cer 100 pf \pm 10% 500 vdcw	56289	40C200A2
A1C11	0140-0200	2	C: fxd mica 390 pf \pm 5% 300 vdcw	04062	RDM15F391J3C
A1C12	0140-0216	1	C: fxd mica 120 pf \pm 20% 300 vdcw	04062	RDM15F121G3C
A1C13	0140-0190	2	C: fxd mica 39 pf \pm 5% 300 vdcw	04062	RDM15E390J3C
A1C14, A1C15	0140-0197	2	C: fxd mica 180 pf \pm 5%	04062	RDM15F181J3C
A1C16	0140-0190	1	C: fxd mica 39 pf \pm 5% 300 vdcw	04062	RDM15E390J3C
A1C17	0180-0094	1	C: fxd Al elect 100 μ f +100% -10% 25 vdcw	56289	30D107G025DH4
A1C18	0180-0058	1	C: fxd elect 50 μ f +100% -10% 25 vdcw	56289	30D506G025DD4M1
A1C19	0180-0111	2	C: fxd Al elect 2 μ f 25 vdcw	56289	40D205G025BB4M1
A1C20	0160-0168	2	C: fxd my 0.1 μ f \pm 10% 200 vdcw	56289	192P10492
A1C21	0140-0200	1	C: fxd mica 390 pf \pm 5% 300 vdcw	04062	RDM15F391J3C
A1C22	0180-0142	1	C: fxd Al elect 20 μ f +100% -10% 25 vdcw	56289	Type 40D D36039
A1C23	0180-0111	1	C: fxd Al elect 2 μ f 25 vdcw	56289	40D205G025BB4M1
A1C24	0170-0038	1	C: fxd my 0.22 μ f \pm 10% 200 vdcw	56289	148P22492
A1C25	0160-0162	1	C: fxd 0.022 μ f \pm 10%	56289	192P22392
A1C26	0160-0168	1	C: fxd my 0.1 μ f \pm 10% 200 vdcw	56289	192P10492
A1C27	0150-0121	1	C: fxd cer 0.1 μ f +80% -20% 50 vdcw	56289	5C50A obd
A1C28	0130-0017	1	C: var cer 8-50 pf	72982	557-019-U2PO-34R
A1C29	0140-0216	1	C: fxd mica 120 pf \pm 2% 300 vdcw	04062	RDM15F121G3C
A1CR1, A1CR2	1901-0040	11	Diode: Si 30 ma at +1 v 30 piv 2 pf 2 ns	07263	FDG1088
A1CR3	1901-0025	1	Diode: Si 100 ma at +1 v 100 piv 12 pf	93332	D3072
A1CR4 thru A1CR11	1901-0040	1	Diode: Si 30 ma at +1 v 30 piv 2 pf 2 ns	07263	FDG1088
A1CR12	1901-0033	1	Diode: Si IN485B 100 ma at +1 v 180 wiv	93332	D6238
A1CR13	1901-0040	1	Diode: Si 30 ma at +1 v 30 piv 2 pf 2 ns	07263	FDG1088
A1L1, A1L2	9140-0047	2	Choke: radio frequency 20 μ h \pm 10%	99848	H51074020
A1Q1 thru A1Q3	1854-0033	6	TSTR: Si NPN 2N3391	24446	2N3391
A1Q4 thru A1Q7	1854-0005	5	TSTR: Si NPN 2N708	01295	2N708
A1Q8	1853-0009	3	TSTR: Si PNP **	28480	1853-0009
A1Q9	1854-0005	3	TSTR: Si NPN 2N708	01295	2N708
A1Q10, A1Q11	1854-0033	3	TSTR: Si NPN 2N3391	24446	2N3391
A1Q12	1853-0009	3	TSTR: Si PNP **	28480	1853-0009
A1Q13	1854-0033	3	TSTR: Si NPN 2N3391	24446	2N3391
A1Q14	1853-0009	3	TSTR: Si PNP **	28480	1853-0009
A1Q15	1853-0016	1	TSTR: Si PNP 2N3638	07263	2N3638
A1R1	0683-2225	3	R: fxd comp 2200 ohms \pm 5% 1/4 w	01121	CB2225
A1R2	0683-1035	9	R: fxd comp 10 K \pm 5% 1/4 w	01121	CB1035
A1R3	0757-0833	2	R: fxd prec met flm 5110 ohms \pm 1% 1/2 w	75042	CEC T-O obd
A1R4	0757-0828	2	R: fxd prec met flm 3010 ohms \pm 1% 1/2 w	75042	CEC T-O obd
A1R5	0698-3345	1	R: fxd prec met flm 4120 ohms \pm 1% 1/2 w	75042	CEC T-O obd

Table 6-1. Replaceable Parts (Cont'd)

REF. DESIG.	-hp- PART NO.	TQ	DESCRIPTION	MFR.	MFR. PART NO.	
A1R6	0757-0828		R: fxd prec met flm 3010 ohms $\pm 1\%$ 1/2 w	75042	CEC T-O	obd
A1R7*	0683-1055	1	R: fxd comp 1 meg $\pm 5\%$ 1/4 w	01121	CB1055	
A1R8	0757-0833		R: fxd prec met flm 5110 ohms $\pm 1\%$ 1/2 w	75042	CEC T-O	obd
A1R9	0683-1035		R: fxd comp 10 K $\pm 5\%$ 1/4 w	01121	CB1035	
A1R10, A1R11	0683-2225		R: fxd comp 2200 ohms $\pm 5\%$ 1/4 w	01121	CB2225	
A1R12	0683-3935	1	R: fxd comp 39 K $\pm 5\%$ 1/4 w	01121	CB3935	
A1R13	0683-5625	1	R: fxd comp 5600 ohms $\pm 5\%$ 1/4 w	01121	CB5625	
A1R14	0698-3481	1	R: fxd prec met flm 8060 ohms $\pm 1\%$ 1/2 w	19701	MF7C T-O	obd
A1R15	0757-0850	1	R: fxd prec met flm 39.2 K $\pm 1\%$ 1/2 w	75042	CEC T-O	obd
A1R16	0757-0848	1	R: fxd prec met flm 30.1 K $\pm 1\%$ 1/2 w	75042	CEC T-O	obd
A1R17	0757-0193	2	R: fxd prec met flm 3320 ohms $\pm 1\%$ 1/2 w	75042	CEC T-O	obd
A1R18	0683-1235	2	R: fxd comp 12 K $\pm 5\%$ 1/4 w	01121	CB1235	
A1R19	0757-0839	2	R: fxd prec met flm 10 K $\pm 1\%$ 1/2 w	75042	CEC T-O	obd
A1R20	0757-0719	2	R: fxd prec met flm 221 ohms $\pm 1\%$ 1/4 w	75042	CEB T-O	obd
A1R21	0757-0852	1	R: fxd prec met flm 41.5 K $\pm 1\%$ 1/2 w	75042	CEC T-O	obd
A1R22	0757-0719		R: fxd prec met flm 221 ohms $\pm 1\%$ 1/4 w	75042	CEC T-O	obd
A1R23	0683-1825	1	R: fxd comp 1800 ohms $\pm 5\%$ 1/4 w	01121	CB1825	
A1R24	0757-0193		R: fxd prec met flm 3320 ohms $\pm 1\%$ 1/2 w	75042	CEC T-O	obd
A1R25	0683-3025	1	R: fxd comp 3000 ohms $\pm 5\%$ 1/4 w	01121	CB3025	
A1R26	0683-2035	2	R: fxd comp 20 K $\pm 5\%$ 1/4 w	01121	CB2035	
A1R27	0683-1235		R: fxd comp 12 K $\pm 5\%$ 1/4 w	01121	CB1235	
A1R28	0683-1035		R: fxd comp 10 K $\pm 5\%$ 1/4 w	01121	CB1035	
A1R29	0683-1535	2	R: fxd comp 15 K $\pm 5\%$ 1/4 w	01121	CB1535	
A1R30 thru A1R32	0686-2225	3	R: fxd comp 2200 ohms $\pm 5\%$ 1/2 w	01121	EB2225	
A1R33	0683-1035		R: fxd comp 10 K $\pm 5\%$ 1/4 w	01121	CB1035	
A1R34	0683-1535		R: fxd comp 15 K $\pm 5\%$ 1/4 w	01121	CB1535	
A1R35, A1R36	0757-0310	2	R: fxd prec met flm 133 K $\pm 1\%$ 1/2 w	75042	CEC T-O	obd
A1R37*	0757-0862	1	R: fxd prec met flm 221 K $\pm 1\%$ 1/2 w	75042	CEC T-O	obd
A1R38	0698-4155	1	R: fxd prec met flm 549 K $\pm 1\%$ 1/2 w	75042	CEC T-O	obd
A1R39	0757-0190	2	R: fxd prec met flm 20 K $\pm 1\%$ 1/2 w	75042	CEC T-O	obd
A1R40, A1R41	0683-2405	2	R: fxd comp 24 ohms $\pm 5\%$ 1/4 w	01121	CB2405	
A1R42 thru A1R45	0683-1035		R: fxd comp 10 K $\pm 5\%$ 1/4 w	01121	CB1035	
A1R46	0683-3915	2	R: fxd comp 390 ohms $\pm 5\%$ 1/4 w	01121	CB3915	
A1R47	0683-1035		R: fxd comp 10 K $\pm 5\%$ 1/4 w	01121	CB1035	
A1R48	0757-0843	1	R: fxd prec met flm 15 K $\pm 1\%$ 1/2 w	75042	CEC T-O	obd
A1R49	0757-0853	1	R: fxd prec met flm 51.1 K $\pm 1\%$ 1/2 w	75042	CEC T-O	obd
A1R50	0757-0190		R: fxd prec met flm 20 K $\pm 1\%$ 1/2 w	75042	CEC T-O	obd
A1R51	0698-4153	1	R: fxd prec met flm 9310 ohms $\pm 1\%$ 1/2 w	75042	CEC T-O	obd
A1R52	0698-4135	1	R: fxd prec met flm 8870 ohms $\pm 1\%$ 1/2 w	75042	CEC T-O	obd
A1R53	0757-0839		R: fxd prec met flm 10 K $\pm 1\%$ 1/2 w	75042	CEC T-O	obd
A1R54	0698-4154	1	R: fxd prec met flm 19.1 K $\pm 1\%$ 1/2 w	75042	CEC T-O	obd
A1R55	0698-4039	1	R: fxd prec met flm 52.3 K $\pm 1\%$ 1/2 w	75042	CEC T-O	obd
A1R56	0757-0813	1	R: fxd prec met flm 475 ohms $\pm 1\%$ 1/2 w	75042	CEC T-O	obd
A1R57	0757-0085	1	R: fxd prec met flm 4020 ohms $\pm 1\%$ 1/2 w	75042	CEC T-O	obd
A1R58	0757-0832	1	R: fxd prec met flm 4750 ohms $\pm 1\%$ 1/2 w	75042	CEC T-O	obd
A1R59	0683-2025	1	R: fxd comp 2000 ohms $\pm 5\%$ 1/4 w	01121	CB2025	
A1R60	0698-3478	1	R: fxd prec met flm 806 ohms $\pm 1\%$ 1/2 w	75042	CEC T-O	obd
A1R61	0683-4725	1	R: fxd comp 4700 ohms $\pm 5\%$ 1/4 w	01121	CB4725	
A1R62	0683-3915		R: fxd comp 390 ohms $\pm 5\%$ 1/4 w	01121	CB3915	
A1R63	0683-2035		R: fxd comp 20 K $\pm 5\%$ 1/4 w	01121	CB2035	
A1R64	0683-1025	1	R: fxd comp 1000 ohms $\pm 5\%$ 1/4 w	01121	CB1025	
A1R65	0698-3410	1	R: fxd prec met flm 3160 ohms $\pm 1\%$ 1/2 w	75042	CEC T-O	obd
A1R66	0698-4134	1	R: fxd prec met flm 8660 ohms $\pm 1\%$ 1/2 w	75042	CEC T-O	obd
A1R67*	0698-5094	1	R: fxd comp 5.1 meg $\pm 5\%$ 1/4 w	01121	EB5155	
A1R68	0683-1035	1	R: fxd comp 10 K $\pm 5\%$ 1/4 w	01121	CB1035	

Table 6-1. Replaceable Parts (Cont'd)

REF. DESIG.	-hp- PART NO.	TQ	DESCRIPTION	MFR.	MFR. PART NO.
C1	0150-0052	1	C: fxd cer 0.05 μ f \pm 20% 400 vdcw	56289	33C17A
C2*	0160-0971	1	C: fxd mica 120 pf \pm 2% 300 vdcw	04062	RDM15F121G3F
J1	1250-0118	1	Connector: BNC UG-1094A/U input radio frequency	95712	30384-1
M1	1120-0913	1	Meter: 1 ma full scale	60741	Model 120 obd
C3	0160-0157	1	<i>0.0047 μF 200VDC 10%</i>		
R1	2100-1724	2	R: var lin ww 2000 ohms \pm 10% 4 w w/SPST switch (see S5)	71450	CAW-GC-DUM 45
R2	2100-0169	1	R: var lin 20 K \pm 30% 1/5 w	11237	Series 70 obd
R3	2100-0141	1	R: var lin 50 K \pm 20% 1/5 w	11237	Series 70 obd
R4	2100-1724	1	R: var lin ww 2000 ohms \pm 10% 4 w w/SPST switch (see S2)	71450	CAW-GC-DUM 45
R5, R6	2100-0261	2	R: var lin 2000 ohms \pm 20% 3/10 w	11237	Series 70 obd
S1	3100-1712	2	Integral p/o S1 INPUT PHASE	76854	obd
S2	2100-1724	2	Switch: SPST concentric shaft 15/16" diameter w/var resistor (see R4)	71450	CAW-GC-DUM 45
S3	3101-0014	1	Switch: pushbutton SPDT MANUAL TRIGGER	82389	4S-1106
S4	3100-1712	1	Switch: rotary MODE	76854	obd
S5	2100-1724	1	Switch: SPST concentric shaft 15/16" diameter w/var resistor (see R1)	71450	CAW-GC-DUM 45
S6	3101-0098	1	Switch: toggle subminiature SPDT FREQUENCY	04009	TS-3A obd
<u>MISCELLANEOUS</u>					
	03302-01201	1	Bracket: component mtg	28480	03302-01201
	425A-41C	3	Bushing: insulator	28480	425A-41C
	1251-0099	1	Connector: 50 pin male (P1)	71785	57-10500-375
	03302-00103	1	Chassis: plug-in left	28480	03302-00103
	03301-00101	1	Chassis: plug-in main	28480	03301-00101
	03302-00102	1	Chassis: plug-in right	28480	03302-00102
	03302-64001	1	Dial: PHASE 0-180° CAL.	28480	03302-64001
	5040-0425	2	Insulator: BNC panel	28480	5040-0425
	03302-04101	1	Insulator: panel	28480	03302-04101
	0370-0102	3	Knob: concentric EXTERNAL MANUAL INPUT PHASE	28480	0370-0102
	0370-0099	1	Knob: 5/8" diameter skirted bar black MODE	28480	0370-0099
	0370-0182	1	Knob: 5/8" diameter skirted black START/STOP PHASE -90° TO +90°	28480	0370-0182
	1390-0037	1	Latch: locking screw	94222	27-10-301-10
	03302-90000	1	Manual: operating and service	28480	03302-90000
	03302-00201	1	Panel: front	28480	03302-00201
	03302-00203	1	Panel: rear	28480	03302-00203
	03302-00202	1	Panel: sub	28480	03302-00202
R7	0687-1011		<i>R = 100 Ω (tussen R4 en -20V)</i>		
R8	0683-1025		<i>R = 1k Ω (in serie met P1 pin 28)</i>		
R9	0683-2225		<i>R = 2.k Ω (in serie met P1 pin 35)</i>		
R10	0867-1801		<i>R = 18 Ω (tussen R4 en aarde)</i>		
C4			<i>C = 0.001 μF - 250VDC (para. R6)</i>		

APPENDIX CODE LIST OF MANUFACTURERS (Sheet 1 of 2)

The following code numbers are from the Federal Supply Code for Manufacturers Cataloging Handbooks H4-1 (Name to Code) and H4-2 (Code to Name) and their latest supplements. The date of revision and the date of the supplements used appear at the bottom of each page. Alphabetical codes have been arbitrarily assigned to suppliers not appearing in the H4 handbooks.

Code No.	Manufacturer	Address	Code No.	Manufacturer	Address	Code No.	Manufacturer	Address
00000	U. S. A. Common	Any supplier of U.S.	07115	Corning Glass Works	Bradford, Pa.	24655	General Radio Co.	West Concord, Mass.
00136	McCoy Electronics	Mount Holly Springs, Pa.	07126	Electronic Components Dept.	Bradford, Pa.	26265	Gries Reproducer Corp.	New Rochelle, N.Y.
00213	Sage Electronics Corp.	Rochester, N. Y.	07137	Digitron Co.	Pasadena, Calif.	26462	Grobet File Co. of America, Inc.	Carlsbad, N.J.
00334	Humdistal Co.	Colton, Calif.	07138	Transistor Electronics Corp.	Minneapolis, Minn.	26992	Hamilton Watch Co.	Lancaster, Pa.
00355	Westech Corp.	New York, N. Y.	07139	Westinghouse Electric Corp.	Electronic Tube Div.	28480	Hewlett-Packard Co.	Palo Alto, Calif.
00373	Garlock Packing Co.,		07149	Filmohm Corp.	Elmira, N. Y.	33173	G. E. Receiving Tube Dept.	Owensboro, Ky.
	Electronic Products Div.	Camden, N. J.	07233	Cinch-Graphix Co.	City of Industry, Calif.	35434	Lectrohm Inc.	Chicago, Ill.
00656	Aerovox Corp.	New Bedford, Mass.	07261	Annet Corp.	Los Angeles, Calif.	36196	Stanwyc Corp.	Hawkesbury, Ontario, Canada
00779	Amp, Inc.	Harrisburg, Pa.	07263	Fairchild Semiconductor Corp.	Mountain View, Calif.	37942	P. R. Mallory & Co., Inc.	Indianapolis, Ind.
00781	Aircraft Radio Corp.	Boonton, N. J.	07322	Minnesota Rubber Co.	Minneapolis, Minn.	39543	Mechanical Industries Prod. Co.	Akron, Ohio
00815	Northern Engineering Laboratories, Inc.	Burlington, Wis.	07327	The Birtcher Corp.	Los Angeles, Calif.	40920	Miniature Precision Bearings, Inc.	Keene, N. H.
00853	Sangamo Electric Company,		07370	Technical Wire Products	Springfield, N. J.	42190	Muler Co.	Chicago, Ill.
	Ordil Division (Capacitors)	Marion, Ill.	07370	Continental Device Corp.	Hawthorne, Calif.	43990	C. A. Norgren Co.	Englewood, Colo.
00866	Goe Engineering Co.	Los Angeles, Calif.	07393	Rheem Semiconductor Corp.	Mountain View, Calif.	44655	Ohmitic Mfg. Co.	Skokie, Ill.
00891	Carl E. Holmes Corp.	Los Angeles, Calif.	07396	Shockley Semi-Conductor	Palo Alto, Calif.	47904	Polaroid Corp.	Cambridge, Mass.
01121	Allen Bradley Co.	Milwaukee, Wis.	07980	Boonton Radio Corp.	Boonton, N. J.	48620	Precision Thermometer and	
01255	Litton Industries, Inc.	Beverly Hills, Calif.	08145	U.S. Engineering Co.	Los Angeles, Calif.		Inst. Co.	Philadelphia, Pa.
01281	TRW Semiconductors Inc.	Lawdette, Calif.	08289	Blinn, Delbert, Co.	Pomona, Calif.	49956	Raytheon Company	Lexington, Mass.
01295	Texas Instruments, Inc.		08358	Burgess Battery Co.	Niagara Falls, Ontario, Canada.	52990	Rowan Controller Co.	Baltimore, Md.
01349	The Alliance Mfg. Co.	Alliance, Ohio	08717	Sloan Company	Burbank, Calif.	53743	Ward Leonard Electric	Mt. Vernon, N. Y.
01561	Chassi-Trak Corp.	Indianapolis, Ind.	08718	Cannon Electric Co., Phoenix Div.	Phoenix, Ariz.	62944	Shallcross Mfg. Co.	Selma, N. C.
01589	Practical Relays, Inc.	Van Nuys, Calif.	08792	CBS Electronics Semiconductor	Operations Div. of C. B. S. Inc.	55026	Simpson Electric Co.	Chicago, Ill.
01930	Aerocor Corp.	Rockford, Ill.	08894	Mei-Rain	Indianapolis, Ind.	55933	Sonotone Corp.	Elmsford, N. Y.
01961	Pulse Engineering Co.	Santa Clara, Calif.	09026	Babcock Relays, Inc.	Costa Mesa, Calif.	55938	Sorenson & Co., Inc.	So. Norwalk, Conn.
02114	Ferrocube Corp. of America	Saugerties, N. Y.	09134	Texas Capacitor Co.	Houston, Texas	56137	Spaulding Fibre Co., Inc.	Tonawanda, N. Y.
02286	Cole Mfg. Co.	Palo Alto, Calif.	09145	Alton Electronics	Sun Valley, Calif.	56289	Sprague Electric Co.	North Adams, Mass.
02660	Amphenol-Borg Electronics Corp.	Chicago, Ill.	09250	Electro Assemblies, Inc.	Chicago, Ill.	59446	Telex, Inc.	St. Paul, Minn.
02735	Radio Corp. of America, Semiconductor	Materials Div.	09569	Mallory Battery Co. of	Canada, Ltd.	59730	Thomas & Betts Co.	Elizabeth 1, N. J.
		Somerville, N. J.		Canada, Ltd.	Toronto, Ontario, Canada	60715	Tripplett Electrical Inc.	Bluffton, Ohio
02771	Vocaline Co. of America, Inc.	Old Saybrook, Conn.	09564	The Bristol Co.	Waterbury, Conn.	61219	Union Switch and Signal, Div. of	Westinghouse Air Brake Co.
02777	Hopkins Engineering Co.	San Fernando, Calif.	10214	General Transistor Western Corp.	Los Angeles, Calif.	62119	Universal Electric Co.,	Owosso, Mich.
03508	G. E. Semiconductor Products Dept.	Syracuse, N. Y.	10411	Ti-Tai, Inc.	Berkeley, Calif.	63743	Ward-Leonard Electric Co.,	Mt. Vernon, N. Y.
03705	Apex Machine & Tool Co.	Dayton, Ohio	10646	Carborundum Co.	Niagara Falls, N. Y.	64959	Weston Inst. Div. of Daystrom,	Chicago 23, Ill.
03797	Eldema Corp.	El Monte, Calif.	11236	C.T.S. of Berne, Inc.	Berne, Ind.	65295	Wetick Manufacturing Co.	Chicago 23, Ill.
03877	Transitron Electronic Corp.	Wakfield, Mass.	11332	Microvane Electronics Corp.	San Fernando, Calif.	65345	Wilensky Optical Co.	Rochester, N. Y.
03888	Pyrofilm Resistor Co.	Morristown, N. J.	11354	Duncan Electronic, Inc.	Santa Ana, Calif.	70276	Allen Mfg. Co.	Harford, Conn.
03954	Air Marine Motors, Inc.	Los Angeles, Calif.	11711	General Instrument Corporation	Semiconductor Division	70309	Altmetrol Control Co., Inc.	New York, N. Y.
04009	Airrow, Hart and Hegeman Elect. Co.	Hartford, Conn.	11717	Imperial Electronic, Inc.	Buena Park, Calif.	70319	Altmetrol Screw Prod. Co., Inc.	Garden City, N. Y.
04013	Taurus Corp.	Lambertville, N. J.	11870	Melabs, Inc.	Palo Alto, Calif.	70485	Atlantic India Rubber Works, Inc.	Chicago, Ill.
04062	Elmenco Products Co.	New York, N. Y.	12136	Philadelpia Handle Co.	Camden, N. J.	70563	Amperite Co., Inc.	New York, N. Y.
04222	H-Q Division of Aerovox	Myrtle Beach, S. C.	12597	Clarasol Mfg. Co.	Dover, N. H.	70903	Belden Mfg. Co.	Chicago, Ill.
04298	Elgin National Watch Co.,		12859	Nippon Electric Co., Ltd.	Tokyo, Japan	70998	Bird Electronic Corp.	Cleveland, Ohio
	Electronics Division	Burbank, Calif.	12930	Delta Semiconductor Inc.	Newport Beach, Calif.	71002	Birchack Radio Co.	New York, N. Y.
04354	Precision Paper Tube Co.	Chicago, Ill.	13103	Thermolyol	Dallas, Texas	71041	Boston Gear Works Div. of	Quincy, Mass.
04404	Dymec Division of Hewlett-Packard Co.	Palo Alto, Calif.	13396	Telefunken (G. M. B. H.)	Hannover, Germany	71218	Bud Radio Inc.	Cleveland, Ohio
04651	Sylvania Semiconductor, Inc.	Mountain View, Calif.	13835	Midland Mfg. Co.	Newbury Park, Calif.	71286	Camloc Fastener Corp.	Patamus, N. J.
04713	Motorola, Inc., Semiconductor Prod. Div.	Phoenix, Arizona	14099	Sea-Tech	Santa Monica, Calif.	71313	Allen D. Cardwell Electronic	Plainville, Conn.
04732	Filtron Co., Inc., Western Div.	Culver City, Calif.	14193	Calif. Resistor Corp.	Conshohocken, Pa.	71400	Bussmann Fuse Div. of McGraw-	Edison Co.
04773	Automatic Electric Co.	Northlake, Ill.	14298	American Components, Inc.	Conshohocken, Pa.	71436	Chicago Condenser Corp.	St. Louis, Mo.
04777	Automatic Electric Sales Corp.	Northlake, Ill.	14655	Cornell Dubilier Elec. Corp.	St. Plainfield, N. J.	71450	CTS Corp.	Chicago, Ill.
04796	Sequoa Wire & Cable Co.	Redwood City, Calif.	14868	Radio Industries	Des Plaines, Ill.	71468	Cannon Electric Co.	Los Angeles, Calif.
04811	Precision Coil Spring Co.	El Monte, Calif.	18583	Curtis Instrument Inc.	Mt. Kisco, N. Y.	71471	Cinema Engineering Co.	Burbank, Calif.
04870	P. M. Motor Company	Chicago 44, Ill.	19315	Eclipse Pioneer, Div. of	Bendix Aviation Corp.	71482	C. P. Clare & Co.	Chicago, Ill.
05006	Twentieth Century Plastics, Inc.	Los Angeles, Calif.	19500	Thomas A. Edison Industries	Div. of McGraw-Edison Co.	71590	Centalita Div. of Globe Union Inc.	Milwaukee, Wis.
05277	Westinghouse Electric Corp.,		19701	Electra Manufacturing Co.	West Orange, N. J.	71616	Commercial Plastics Co.	Chicago, Ill.
	Semiconductor Dept.	Youngwood, Pa.	20183	Electronic Tube Corp.	Philadelphia, Pa.	71700	The Cornish Wire Co.	New York, N. Y.
05347	Ultronix, Inc.	San Mateo, Calif.	21226	Executive, Inc.	New York, N. Y.	71744	Chicago Miniature Lamp Works	Chicago, Ill.
05593	Hillitronic Engineering Co.	Sunnyvale, Calif.	21320	Fanstel Metallurgical Corp.	New Chicago, Ill.	71753	A. O. Smith Corp., Crowley Div.	West Orange, N. J.
05618	Cosmo Plastic	Cleveland, Ohio	21335	The Fahm Bearing Co.	New Britain, Conn.	71785	Cinch Mfg. Corp.	Chicago, Ill.
05624	Barber Colman Co.	Rockford, Ill.	21364	Fed. Telephone and Radio Corp.	Clifton, N. J.	71984	Dow Corning Corp.	Midland, Mich.
05728	Tiffen Optical Co.		24446	General Electric Co.	Schenectady, N. Y.	72092	Eitel-McCollough, Inc.	San Bruno, Calif.
	Roslyn Heights	Long Island, N. Y.	24455	G. E., Lamp Division	Nela Park, Cleveland, Ohio	72136	Electro Motive Mfg. Co., Inc.	West Orange, N. J.
05729	Metropolitan Telecommunications Corp.,					71785	Cinch Mfg. Corp.	Chicago, Ill.
	Metro Cap. Division	Brooklyn, N. Y.				71984	Dow Corning Corp.	Midland, Mich.
05783	Stewart Engineering Co.	Santa Cruz, Calif.				72092	Eitel-McCollough, Inc.	San Bruno, Calif.
05820	Wakfield Engineering Inc.	Wakfield, Mass.				72136	Electro Motive Mfg. Co., Inc.	West Orange, N. J.
06004	The Bassich Co.	Bridgport, Conn.				71785	Cinch Mfg. Corp.	Chicago, Ill.
06175	Bausch and Lomb Optical Co.	Rochester, N. Y.				71984	Dow Corning Corp.	Midland, Mich.
06402	E. T. A. Products Co. of America	Chicago, Ill.				72092	Eitel-McCollough, Inc.	San Bruno, Calif.
06475	Western Devices, Inc.	Inglewood, Calif.				72136	Electro Motive Mfg. Co., Inc.	West Orange, N. J.
06540	Amtron Electronic					71707	Providence, R.I.	Providence, R.I.
	Hardware Co. Inc.	New Rochelle, N. Y.				72354	John E. Fast & Co.	Chicago, Ill.
06555	Beebe Electrical Instrument Co., Inc.	Penacook, N. H.				72619	Dialight Corp.	Brooklyn, N. Y.
06751	U. S. Sencor Division of Nuclear Corp.	Phoenix, Arizona				72656	General Ceramics Corp.	Brooksey, N. J.
06812	Torrington Mfg. Co., West Div.	Van Nuys, Calif.				72699	General Instrument Corp.,	Semiconductor Div.
07088	Kevin Electric Co.	Van Nuys, Calif.						Newark, N. J.

APPENDIX CODE LIST OF MANUFACTURERS (Sheet 2 of 2)

Code No.	Manufacturer	Address	Code No.	Manufacturer	Address	Code No.	Manufacturer	Address	Code No.	Manufacturer	Address
81349	Military Specification	85474	R. M. Bracamonte & Co.	San Francisco, Calif.	93929	G. V. Controls	Livingston, N. J.	98220	Francis L. Mosley	Pasadena, Calif.
81415	Wilkor Products, Inc.	Cleveland, Ohio	85660	Koiled Kords, Inc.	New Haven, Conn.	93983	Insuline-Van Norman Ind., Inc.	Manchester, N. H.	98278	Microdot, Inc.	So. Pasadena, Calif.
81453	Raytheon Mfg. Co., Industrial Components Div., Indust. Tube Operations	Newton, Mass.	85911	Seamless Rubber Co.	Chicago, Ill.	94137	General Cable Corp.	Bayonne, N. J.	98291	Selectro Corp.	Mamaroneck, N. Y.
81483	International Rectifier Corp.	El Segundo, Calif.	86197	Clifton Precision Products	Clifton Heights, Pa.	94144	Raytheon Mfg. Co., Industrial Components Div., Receiving Tube Operation	Quincy, Mass.	98405	Carad Corp.	Redwood City, Calif.
81541	The Airpax Products Co.	Cambridge, Mass.	86579	Precision Rubber Products Corp.	Dayton, Ohio	94145	Raytheon Mfg. Co., Semiconductor Div., California Street Plant	Newton, Mass.	98731	General Mills	Minneapolis, Minn.
81860	Barty Controls, Inc.	Watertown, Mass.	86684	Radio Corp. of America, RCA Electron Tube Div.	Harrison, N. J.	94148	Scientific Radio Products, Inc.	Loveland, Colo.	98821	North Hills Electric Co.	Mineola, N. Y.
82042	Carter Parts Co.	Skokie, Ill.	87216	Phico Corporation (Lansdale Division)	Lansdale, Pa.	94154	Tung-Sol Electric, Inc.	Newark, N. J.	98925	Clevite Transistor Prod. Div. of Clevite Corp.	Waltham, Mass.
82142	Jefferis Electronics Division of Speer Carbon Co.	Du Bois, Pa.	87473	Western Fibrous Glass Products Co.	San Francisco, Calif.	94197	Curtiss-Wright Corp., Electronics Div.	East Paterson, N. J.	98978	International Electronic Research Corp.	Burbank, Calif.
82170	Allen B. DuMont Labs, Inc.	Clifton, N. J.	87664	Van Waters & Rogers Inc.	Seattle, Wash.	94222	Southco Div. of S. Chester Corp.	Lester, Pa.	99109	Columbia Technical Corp.	New York, N. Y.
82209	Maguire Industries, Inc.	Greenwich, Conn.	87930	Tower Mfg. Corp.	Providence, R. I.	94310	Tri Ohm Prod. Div. of Model Engineering and Mfg. Co.	Chicago, Ill.	99313	Varian Associates	Palo Alto, Calif.
82219	Sylvania Electric Prod., Inc. Electronic Tube Div.	Emporium, Pa.	88140	Cutler-Hammer, Inc.	Lincoln, Ill.	94330	Wire Cloth Products Inc.	Chicago, Ill.	99515	Marshall Industries, Electron Products Division	Pasadena, Calif.
82376	Astron Co.	East Newark, N. J.	88220	Gould-National Batteries, Inc.	St. Paul, Minn.	94682	Worcester Pressed Aluminum Corp.	Worcester, Mass.	99707	Control Switch Division, Controls Co. of America	El Segundo, Calif.
82389	Switchcraft, Inc.	Chicago, Ill.	88698	General Mills, Inc.	Buffalo, N. Y.	95023	Philbrick Researchers, Inc.	Boston, Mass.	99848	Delevan Electronics Corp.	East Aurora, N. Y.
82647	Metals and Controls, Inc., Div. of Texas Instruments, Inc., Spencer Prods.	Attleboro, Mass.	89231	Graybar Electric Co.	Oakland, Calif.	95026	Allies Products Corp.	Miami, Fla.	99848	Wilco Corporation	Indianapolis, Ind.
82666	Research Products Corp.	Madison, Wis.	89462	Waldes Kohinoor, Inc.	Cambridge, Mass.	95238	Continental Connector Corp.	Woodside, N. Y.	99934	Renbrant, Inc.	Boston, Mass.
82877	Rotron Manufacturing Co., Inc.	Woodstock, N. Y.	89473	General Electric Distributing Corp.	Schenectady, N. Y.	95263	Leecraft Mfg. Co., Inc.	New York, N. Y.	99942	Hoffman Semiconductor Div. of Hoffman Electronics Corp.	Evanston, Ill.
82893	Vector Electronic Co.	Glendale, Calif.	89665	United Transformer Co.	Chicago, Ill.	95264	Lercro Electronics, Inc.	Burbank, Calif.	99957	Technology Instrument Corp. of Calif.	Newbury Park, Calif.
83053	Western Washer Mfr. Co.	Los Angeles, Calif.	90179	U. S. Rubber Co., Mechanical Goods Div.	Passaic, N. J.	95265	National Coil Co.	Sheridan, Wyo.	THE FOLLOWING H-P VENDORS HAVE NO NUMBER ASSIGNED IN THE LATEST SUPPLEMENT TO THE FEDERAL SUPPLY CODE FOR MANUFACTURERS' HANDBOOK.		
83058	Carr Fastener Co.	Cambridge, Mass.	90970	Bearing Engineering Co.	San Francisco, Calif.	95275	Vitamom, Inc.	Bridgeport, Conn.	J0000	Winchester Electronics, Inc.	Santa Monica, Calif.
83086	New Hampshire Ball Bearing, Inc.	Peterborough, N. H.	91260	Connor Spring Mfg. Co.	San Francisco, Calif.	95348	Gordas Corp.	Bloomfield, N. J.	0000F	Malco Tool and Die	Los Angeles, Calif.
83125	Pyramid Electric Co.	Darlington, S. C.	91345	Miller Dial & Nameplate Co.	El Monte, Calif.	95354	Methode Mfg. Co.	Chicago, Ill.	0000M	Western Coil Div. of Automatic Ind., Inc.	Redwood City, Calif.
83148	Electro Cords Co.	Los Angeles, Calif.	91418	Radio Materials Co.	Chicago, Ill.	95712	Dage Electric Co., Inc.	Franklin, Ind.	0000P	Ty-Car Mfg. Co., Inc.	Holliston, Mass.
83186	Victory Engineering Corp.	Springfield, N. J.	91506	Augat Brothers', Inc.	Attleboro, Mass.	95987	Weckesser Co.	Chicago, Ill.	0000Z	Willow Leather Products Corp.	Newark, N. J.
83298	Bendis Corp., Red Bank Div.	Red Bank, N. J.	91637	Dale Electronics, Inc.	Columbus, Nebr.	96067	Huggins Laboratories	Sunnyvale, Calif.	000A	British Radio Electronics Ltd.	Washington, D. C.
83315	Hubbell Corp.	Mundelein, Ill.	91662	Elco Corp.	Philadelphia, Pa.	96095	Hi-Q Division of Aerovox	Olean, N. Y.	000A B	ETA	England
83330	Smith, Herman H., Inc.	Brooklyn, N. Y.	91737	Gremer Mfg. Co., Inc.	Wakefield, Mass.	96256	Thoradson-Meissner Div. of Maguire Industries, Inc.	Mt. Carmel, Ill.	000C	Indiana General Corp., Elect. Div.	Indiana
83385	Central Screw Co.	Chicago, Ill.	91827	K F Development Co.	Redwood City, Calif.	96296	Solar Manufacturing Co.	Los Angeles, Calif.	000B B	Precision Instrument Components Co.	Van Nuys, Calif.
83501	Gavitt Wire and Cable Co., Div. of Amerace Corp.	Brookfield, Mass.	91929	Minneapolis-Honeywell Regulator Co.	Redwood City, Calif.	96320	Carlton Screw Co.	Chicago, Ill.	000M M	Rubber Eng. & Development	Hayward, Calif.
83594	Burroughs Corp., Electronic Tube Div.	Plainfield, N. J.	91961	Hahn-Bros. Spring Co.	Fresport, Ill.	96341	Microwave Associates, Inc.	Burlington, Mass.	000N N	A "N" D Manufacturing Co.	San Jose 27, Calif.
83740	Evershey Battery	New York, N. Y.	92180	Tru-Connector Corp.	Peabody, Mass.	96501	Excel Transformer Co.	Oakland, Calif.	000Q Q	Cooltron	Oakland, Calif.
83777	Model Eng. and Mfg., Inc.	Huntington, Ind.	92196	Universal Metal Prod., Inc.	Bassett Puente, Calif.	97464	Industrial Retaining Ring Co.	Irvington, N. J.	000S S	Control of Elgin Watch Co.	Burbank, Calif.
83821	Lycr Scraggs Co.	Festus, Mo.	92367	Elgeet Optical Co., Inc.	Rochester, N. Y.	97539	Automatic and Precision Mfg. Co.	Yonkers, N. Y.	000W W	California Eastern Lab.	Burlingame, Calif.
84171	Loce Electronics, Inc.	New York, N. Y.	92607	Tinsolite Insulated Wire Co.	Tarrytown, N. Y.	97966	CBS Electronics, Div. of C. B. S., Inc.	Danvers, Mass.	000Y Y	S. K. Smith Co.	Los Angeles 45, Calif.
84396	A. J. Gieseler Co., Inc.	San Francisco, Calif.	93332	Sylvania Electric Prod. Inc., Semiconductor Div.	Woburn, Mass.	97979	Reon Resistor Corp.	Yonkers, N. Y.			
84411	Good All Electric Mfg. Co.	Ogallala, Neb.	93369	Robbins and Myers, Inc.	New York, N. Y.	98141	Axel Brothers Inc.	Jamaica, N. Y.			
84970	Sarkes Tarzian, Inc.	Bloomington, Ind.	93410	Stevens Mfg. Co., Inc.	Manfield, Ohio	98159	Rubber Teck, Inc.	Gardena, Calif.			
85454	Bonton Molding Company	Bonton, N. J.	93788	Howard J. Smith Inc.	Port Monmouth, N. J.						
85471	A. B. Boyd Co.	San Francisco, Calif.									

HEWLETT - PACKARD SALES AND SERVICE OFFICES in the United States and Canada

ALABAMA

Huntsville, 35802
2003 Byrd Spring Rd. S.W.
(205) 881-4591
TWX: 510-579-2204

ALASKA

Bellevue, Wash. 98004
11656 N.E. 8th Street
(206) 454-3971
TWX: 910-443-2303

ARIZONA

Scottsdale, 85251
3009 No. Scottsdale Rd.
(602) 945-7601
TWX: 602-949-0111

Tucson, 85716
232 So. Tucson Blvd.
(602) 623-2564
TWX: 602-792-2759

CALIFORNIA

North Hollywood, 91604
3939 Lankershim Blvd.
(213) 877-1282 and 766-3811
TWX: 910-499-2170

Sacramento, 95821
2591 Carlsbad Ave.
(916) 482-1463
TWX: 916-444-8683

San Diego, 92106
1055 Shafter Street
(714) 223-8103
TWX: 714-276-4263

Palo Alto, 94303
1101 Embarcadero Rd.
(415) 327-6500
TWX: 910-373-1280

COLORADO

Englewood, 80110
7965 East Prentice
(303) 771-3455
TWX: 303-771-3056

CONNECTICUT

Middletown, 06458
589 Saybrook Rd.
(203) 346-6611
TWX: 710-428-2036

FLORIDA

Miami, 33125
2907 Northwest 7th St.
(305) 635-6461

Orlando, 32803
621 Commonwealth Ave.
(305) 425-5541
TWX: 305-275-1234

St. Petersburg, 33708
410-150th Ave., Madeira Beach
(813) 391-0211
TWX: 813-391-0666

GEORGIA

Atlanta, 30305
3110 Maple Drive, N.E.
(404) 233-1141
TWX: 810-751-3283

HAWAII

North Hollywood, Calif. 91604
3939 Lankershim Blvd.
(213) 877-1282 and 766-3811
TWX: 910-499-2170

ILLINOIS

Skokie, 60078
5500 Howard Street
(312) 677-0400
TWX: 910-223-3613

INDIANA

Indianapolis, 46205
3919 Meadows Dr.
(317) 546-4891
TWX: 317-635-4300

LOUISIANA

New Orleans
(504) 522-4359

MARYLAND

Baltimore, 21207
6660 Security Blvd.
(301) 944-5400

Rockville, 20852
12303 Twinbrook Pkwy.
(301) 427-7560
TWX: 710-828-9684

MASSACHUSETTS

Burlington, 01804
Middlesex Turnpike
(617) 272-9000
TWX: 710-332-0382

MICHIGAN

Southfield, 48076
24315 Northwestern Hwy.
(313) 353-9100
TWX: 313-357-4425

MINNESOTA

St. Paul, 55114
2459 University Ave.
(612) 646-7881
TWX: 910-563-3734

MISSOURI

Kansas City, 64131
7916 Paseo Street
(816) 444-9494
TWX: 816-556-2423

St. Louis, 63144
2814 South Brentwood Blvd.
(314) 647-4350
TWX: 314-962-3933

NEW JERSEY

Eatontown
(201) 542-0852
Englewood, 07631
391 Grand Avenue
(201) 567-3933

NEW MEXICO

Albuquerque, 87108
6501 Lomas Blvd., N.E.
(505) 255-5586
TWX: 910-989-1655
Las Cruces, 88001
114 S. Water Street
(505) 526-2486
TWX: 505-524-2671

NEW YORK

New York, 10021
236 East 75th Street
(212) 879-2023
TWX: 710-581-4376
Rochester, 14623
39 Saginaw Drive
(716) 473-9500
TWX: 510-253-5981
Poughkeepsie, 12601
82 Washington Street
(914) 454-7330
TWX: 914-452-7425
Syracuse, 13211
5858 East Molloy Rd.
(315) 454-2486
TWX: 710-541-0482
Endicott, 13764
1219 Campville Rd.
(607) 754-0050
TWX: 510-252-0890

NORTH CAROLINA

High Point, 27262
1923 N. Main Street
(919) 882-6873
TWX: 510-926-1516

OHIO

Cleveland, 44129
5579 Pearl Road
(216) 884-9209
TWX: 216-888-0715

Dayton, 45409
1250 W. Dorothy Lane
(513) 298-0351
TWX: 513-944-0090

OKLAHOMA

Oklahoma City
(405) 235-7062

PENNSYLVANIA

Camp Hill
(717) 737-6791
West Conshohocken, 19428
144 Elizabeth Street
(215) 248-1600 and 828-6200
TWX: 215-828-3847
Monroeville, 15146
2545 Moss Side Blvd.
(412) 271-5227
TWX: 710-797-3650

TEXAS

Dallas, 75209
P.O. Box 7166, 3605 Inwood Rd.
(214) 357-1881 and 332-6667
TWX: 910-861-4081

Houston, 77027
P.O. Box 22813, 4242 Richmond Ave
(713) 667-2407
TWX: 713-571-1353

UTAH

Salt Lake City, 84115
1482 Major St.
(801) 486-8166
TWX: 801-521-2604

VIRGINIA

Richmond, 23230
2112 Spencer Road
(703) 282-5451
TWX: 710-956-0157

WASHINGTON

Bellevue, 98004
11656 N. E. 8th St.
(206) 454-3971
TWX: 910-443-2303

**GOVERNMENT
CONTRACTING OFFICES**

Middletown, Pa. 17057
Hewlett-Packard
Contract Marketing Division
Olmsted Plaza
(717) 944-7401
TWX: 717-760-4816

West Conshohocken, Pa. 19428
Hewlett-Packard
Contract Marketing Division
144 Elizabeth Street
(215) 753-1811
TWX: 215-820-3847

CANADA

Montreal, Quebec
Hewlett-Packard (Canada) Ltd.
8270 Maynard Street
(514) 735-2273
TWX: 610-421-3484

Ottawa, Ontario
Hewlett-Packard (Canada) Ltd.
1762 Carling Avenue
(613) 722-4223
TWX: 610-562-1952

Toronto, Ontario
Hewlett-Packard (Canada) Ltd.
1415 Lawrence Avenue West
(416) 249-9196
TWX: 610-492-2382

Vancouver, B.C.
Hewlett-Packard (Canada) Ltd.
2184 W. Broadway
(604) 738-7520
TWX: 610-922-5059

HEWLETT-PACKARD INTERNATIONAL OFFICES

Electronic Instrument Sales and Service

ARGENTINA

Mauricio A. Saurez
Telecomunicaciones
Carlos Calvo 224, Buenos Aires
Tel: 30-6312

AUSTRALIA

Sample Electronics (Vic.) Pty. Ltd.
9-11 Cremorne Street
Richmond E. 1, Victoria
Tel: 42-4757 (3 lines)
Sample Electronics (N.S.W.) Pty. Ltd.
4 Grose Street, Glebe, N.S.W.
Tel: 69-6338 (16 lines)

AUSTRIA

UNILABOR H.m.b.H.
Wissenschaftliche Instrumente
Rummelhardtgasse 6/3
P.O. Box 33, Vienna IX/71
Tel: 42 61 81

BELGIUM

Hewlett-Packard Benelux
20-24 Rue de l'Hopital, Brussels 1
Tel: 11.22.20

BRAZIL

Ciental Importacao e Comercio Ltda.
R. Des. Eliseu Guilherme, 62
Sao Paulo 6
Tel: 32-4332

CHILE

Hector Calcagni
Casilla 13942, Santiago
Tel: 6 42 26

COLOMBIA

Instrumentacion Henrik A. Langebeck
& Cia. Ltda.
Apartado Aereo 6287
Bogota 1, D.E.
Tel: 45-78-06
Cable: AARIS - Bogota

DENMARK

Tage Olsen A/S
Ronnegade 1, Copenhagen 0
Tel: 29 48 00

FINLAND

INTO O/Y
P.O. Box 153
11 Meritullinkatu, Helsinki
Tel: 6.11.33

FRANCE

Hewlett-Packard France
150 Blvd. Massena, Paris 13e
Tel: 707.97.19

GERMANY

Hewlett-Packard VgmbH
Steindamm 35, Hamburg 1
Tel: 24.05.51

Hewlett-Packard VgmbH
Kurfurstenstrasse 95
Frankfurt a. Main
Tel: 52.00.36

Hewlett-Packard VgmbH
Reginfriedstrasse 13
Munich 9
Tel: 49.51.21/2

Hewlett-Packard VgmbH
Technisches Buro
Herrenbergerstrasse 110
703 Boblingen, Wurttemberg
Tel: 6971

Hewlett-Packard VgmbH
Lietzenburger Strasse 30
1000 Berlin 30
Tel: 24 92 71

IN EUROPE

Hewlett-Packard, S. A.
54 Route des Acacias
Geneva, Switzerland
Telephone: (022) 42.81.50
Telex: 2 24 86
Cable: HEWPACKSA

GREECE

K. Karayannis
Klaffmonos Square, Athens 124
Tel: 230.301

INDIA

The Scientific Instrument Company, Ltd.
6, Tej Bahadur Sapru Road, Allahabad 1
Tel: 2451

The Scientific Instrument Company, Ltd.
240, Dr. Dadabhai Naoroji Rd., Bombay 1
Tel: 26-2642

The Scientific Instrument Company, Ltd.
11, Esplanade East, Calcutta 1
Tel: 23-4129

The Scientific Instrument Company, Ltd.
30, Mount Road, Madras 2
Tel: 86339

The Scientific Instrument Company, Ltd.
B-7, Ajmeri Gate Extn., New Delhi 1
Tel: 271053

IRAN

Telecom Ltd.
P.O. Box 1812, Tehran
Tel: 43850

ISRAEL

Electronics & Engineering Ltd.
16 Kremenetski St., Tel Aviv
Tel: 35021-2-3

ITALY

Hewlett-Packard Italiana S.p.A.
Viale Lunigiana 46, Milan
Tel: 69.15.84/5/6

Hewlett-Packard Italiana S.p.A.
Palazzo Italia
Piazza Marconi, 25, Roma-Eur
Tel: 59.12.544/5

JAPAN

Yokogawa-Hewlett-Packard Ltd.
2270 Ishikawa-cho
Hachioji, Tokyo
Tel: Hachioji 0426-3-1231 (19 lines)

Yokogawa-Hewlett-Packard Ltd.
No. 3, 6-chome, Aoyama-Kitamachi
Akasaka, Minato-ku, Tokyo
Tel: 403-6511

Yokogawa-Hewlett-Packard Ltd.
No. 8, Umeda, Kita-ku, Osaka
Tel: 313-0091

Yokogawa-Hewlett-Packard Ltd.
No. 4, 3-chome, Himeikedori,
Chigusa-ku, Nagoya
Tel: 751-8545

KOREA

American Trading Company, Korea, Ltd
112-35 Sokong-Dong, Jung-ku
Seoul P.O. Box 1103, Seoul
Tel: 3-7049, 3-7613

NETHERLANDS

Hewlett-Packard Benelux N.V.
23 Burg Roellstraat, Amsterdam W.
Tel: (020) 13 28 98 and 13 54 99

NEW ZEALAND

Sample Electronics (N. Z.) Ltd.
8 Matipo Street
Onehunga S. E. 5, Auckland
Tel: 565-361

NORWAY

Morgenstjerne & Co. A/S
Ingeniørfirma
6 Wessels Gate, Oslo
Tel: 20 16 35

PANAMA

Electronico Balboa, S.A.
P.O. Box 4929
Panama City 5, Panama
Tel: 3-0833

PERU

Fernando Ezeta B.
Casilla 3061
Lima
Tel: 78745

PORTUGAL

TELECTRA
Rua Rodrigo da Fonseca 103
P.O. Box 2531, Lisbon 1
Tel: 68 60 72 and 68 60 73 and 68 60 74

PUERTO RICO & VIRGIN ISLANDS

San Juan Electronics, Inc.
150 Ponce de Leon, Stop 3
P.O. Box 5167
Plta. de Tierra Sta., San Juan 00906
Tel: 725-3342, 724-4406

SPAIN

ATAIO, Ingenieros
Enrique Larreta 12, Madrid 6
Tel: 235.43.44 and 235.43.45

SOUTH AFRICA

F. H. Flanzer & Co. (Pty.) Ltd.
Rosella House
Birtencingle Street, Cape Town
Tel: 3-3817

SWEDEN

H-P Instrument AB
Centralvagen 28, Solna, Centrum
Tel: 83.08.30

H-P Instrument AB
Idunagatan 28A
Goteborg
Tel: 27 68 00 and 27 68 01

SWITZERLAND

Max Paul Frey
Wankdorffeldstrasse 66, Berne
Tel: (031) 42.00.78

TAIWAN (FORMOSA)

Hwa Sheng Electronic Co., Ltd.
21 Nanking West Road, Taipei
Tel: 4 6076, 4 5936

TURKEY

TELEKOM Engineering Bureau
P.O. Box 376—Galata, Istanbul
Tel: 49.40.40

UNITED KINGDOM

Hewlett-Packard Ltd.
Dallas Rd., Bedford, England
Tel: Bedford 68052

VENEZUELA

Citec, C. A.
Edif. Arisan-Of #4
Avda. Francisco de Miranda-Chacaito
Apartado del Este 10.837, Caracas
Tel: 71.88.05

YUGOSLAVIA

Belram S.A.
83 Avenue des Mimosas
Brussels 15, Belgium
Tel: 35.29.58

For Sales and Service Assistance in Areas Not Listed Contact:

IN LATIN AMERICA

Hewlett-Packard Inter-Americas
1501 Page Mill Road
Palo Alto, California 94304, U.S.A.
Telephone: (415) 326-7000
TWX: 910-373-1267
Telex: 033811 Cable: HEWPACK

ELSEWHERE

Hewlett-Packard
Overseas Sales Department
1501 Page Mill Road
Palo Alto, California 94304, U.S.A.
Telephone: (415) 326-7000
TWX: 910-373-1267
Telex: 033811 Cable: HEWPACK

MANUAL BACKDATING CHANGES

MODEL 3302A

TRIGGER/PHASE LOCK PLUG-IN

Manual Serial Prefixed: 540-, 536-
-hp- Part No. 03302-90001

This manual backdating sheet makes this manual applicable to earlier instruments. Instrument-component values that differ from those in the manual, yet are not listed in the backdating sheet, should be replaced using the part number given in the manual.

Instrument Serial Prefix	Make Manual Changes	Instrument Serial Prefix	Make Manual Changes
540-, 536-	Change #1		

CHANGE #1

Figure 5-7, Schematic Diagram, and Table 6-1, Replaceable Parts:
Delete R67 and R68.

See Service Note 3302A-1 for modification.