

Errata

Title & Document Type: 3582A Spectrum Analyzer Operating Manual

Manual Part Number: 03582-90005

Revision Date: March 1981

HP References in this Manual

This manual may contain references to HP or Hewlett-Packard. Please note that Hewlett-Packard's former test and measurement, semiconductor products and chemical analysis businesses are now part of Agilent Technologies. We have made no changes to this manual copy. The HP XXXX referred to in this document is now the Agilent XXXX. For example, model number HP8648A is now model number Agilent 8648A.

About this Manual

We've added this manual to the Agilent website in an effort to help you support your product. This manual provides the best information we could find. It may be incomplete or contain dated information, and the scan quality may not be ideal. If we find a better copy in the future, we will add it to the Agilent website.

Support for Your Product

Agilent no longer sells or supports this product. You will find any other available product information on the Agilent Test & Measurement website:

www.tm.agilent.com

Search for the model number of this product, and the resulting product page will guide you to any available information. Our service centers may be able to perform calibration if no repair parts are needed, but no other support from Agilent is available.



OPERATING MANUAL

MODEL 3582A

SPECTRUM ANALYZER

**Serial Numbers: 1747A00101 to 1747A00125 and
809A00126 and greater**

IMPORTANT NOTICE

This manual applies to instruments with the above serial number prefixes. As changes are made in the instrument to improve performance and reliability, the appropriate pages will be revised to include this information.

WARNING

To help minimize the possibility of electrical fire or shock hazards, do not expose this instrument to rain or excessive moisture.

Manual Part No. 03582-90005

Microfiche Part No. 03582-90055

©Copyright Hewlett-Packard Company 1978
P.O. Box 301, Loveland, Colorado 80537 U.S.A.

CERTIFICATION

Hewlett-Packard Company certifies that this product met its published specifications at the time of shipment from the factory. Hewlett-Packard further certifies that its calibration measurements are traceable to the United States National Bureau of Standards, to the extent allowed by the Bureau's calibration facility, and to the calibration facilities of other International Standards Organization members.

WARRANTY

This Hewlett-Packard product is warranted against defects in material and workmanship for a period of one year from date of shipment [except that in the case of certain components listed in Section I of this manual, the warranty shall be for the specified period]. During the warranty period, Hewlett-Packard Company will, at its option, either repair or replace products which prove to be defective.

For warranty service or repair, this product must be returned to a service facility designated by -hp-. Buyer shall prepay shipping charges to -hp- and -hp- shall pay shipping charges to return the product to Buyer. However, Buyer shall pay all shipping charges, duties, and taxes for products returned to -hp- from another country.

Hewlett-Packard warrants that its software and firmware designated by -hp- for use with an instrument will execute its programming instructions when properly installed on that instrument. Hewlett-Packard does not warrant that the operation of the instrument, or software, or firmware will be uninterrupted or error free.

LIMITATION OF WARRANTY

The foregoing warranty shall not apply to defects resulting from improper or inadequate maintenance by Buyer, Buyer-supplied software or interfacing, unauthorized modification or misuse, operation outside of the environmental specifications for the product, or improper site preparation or maintenance.

NO OTHER WARRANTY IS EXPRESSED OR IMPLIED. HEWLETT-PACKARD SPECIFICALLY DISCLAIMS THE IMPLIED WARRANTIES OF MERCHANTABILITY AND FITNESS FOR A PARTICULAR PURPOSE.

EXCLUSIVE REMEDIES

THE REMEDIES PROVIDED HEREIN ARE BUYER'S SOLE AND EXCLUSIVE REMEDIES. HEWLETT-PACKARD SHALL NOT BE LIABLE FOR ANY DIRECT, INDIRECT, SPECIAL, INCIDENTAL, OR CONSEQUENTIAL DAMAGES, WHETHER BASED ON CONTRACT, TORT, OR ANY OTHER LEGAL THEORY.

ASSISTANCE

Product maintenance agreements and other customer assistance agreements are available for Hewlett-Packard products.

For any assistance, contact your nearest Hewlett-Packard Sales and Service Office. Addresses are provided at the back of this manual.

TABLE OF CONTENTS

Section	Page	Section	Page
I. GENERAL INFORMATION.....	1-1	3-55. Amplitude Reference Level.....	3-10
1-1. Introduction.....	1-1	3-58. The Passband Shape Controls.....	3-11
1-5. Specifications.....	1-1	3-61. The Noise Source.....	3-13
1-7. Safety Considerations.....	1-1	3-65. Impulse Output.....	3-14
1-9. Instruction Manual Symbol.....	1-1	3-68. Dual Channel Measurements.....	3-15
1-11. Instruments Covered by Manual.....	1-1	3-94. Storing Traces.....	3-24
1-16. Description.....	1-2	3-97. Conclusion.....	3-25
1-27. Options.....	1-3	3-99. Operating on Signal Data.....	3-25
1-29. Accessories Supplied.....	1-3	3-100. Introduction.....	3-25
1-31. Accessories Available.....	1-4	3-102. Acquiring a Time Record.....	3-25
1-33. Recommended Test Equipment.....	1-4	3-104. Operating on Stored Time Data.....	3-25
Section II. INSTALLATION.....	2-1	3-106. Using the Recorder Output.....	3-26
2-1. Introduction.....	2-1	3-109. Using Probes.....	3-26
2-3. Initial Inspection.....	2-1	3-111. Probes Are Delicate.....	3-27
2-5. Power Requirements.....	2-1	3-113. Probe Compensation Procedure.....	3-27
2-7. Line Voltage and Fuse Selection.....	2-1	3-115. Front Panel Screwdriver	
2-9. Power Cable and Grounding		Adjustments.....	3-28
Requirements.....	2-2	3-117. ASTIG Adjustment.....	3-29
2-11. Operating Environment.....	2-2	3-119. BAL Adjustments.....	3-29
2-12. Temperature.....	2-2	3-122. In Case of Trouble.....	3-29
2-14. Humidity.....	2-2	3-123. Introduction.....	3-29
2-16. Altitude.....	2-2	3-125. "Hung UP".....	3-30
2-18. Cooling Fan.....	2-2	3-127. Overload.....	3-30
2-20. Thermal Cutout.....	2-2	3-129. Unrelated Spectral Displays.....	3-31
2-22. Installation.....	2-3	3-131. Noise Source Output.....	3-31
2-23. Mounting.....	2-3	3-133. Simplification of Discrete Data	
2-26. HP-IB System Interface Connections..	2-3	Analysis.....	3-31
2-30. Cable Length Restrictions.....	2-4	3-134. Introduction.....	3-31
2-32. HP-IB Address Selection.....	2-5	3-136. Time Domain Considerations.....	3-32
2-34. Storage and Shipment.....	2-5	3-139. Frequency Domain Considerations..	3-32
2-35. Environment.....	2-5	3-147. Aliasing.....	3-34
2-37. Packaging.....	2-5	3-150. Data in Memory.....	3-35
Section III. MANUAL OPERATION.....	3-1	3-153. Interpreting the Display.....	3-36
3-1. Introduction.....	3-1	3-156. Leakage.....	3-37
3-3. Controls, Connectors, and Indicators..	3-1	3-158. Windowing.....	3-37
3-5. Turn-On Procedure.....	3-1	3-163. Window Functions.....	3-38
3-8. About Spectrum Analyzers.....	3-2	REMOTE OPERATION.....	3-39
3-10. A Comparison.....	3-2	3-165. Remote Operation.....	3-39
3-13. Features.....	3-2	3-166. Introduction.....	3-39
3-15. The Display.....	3-2	3-169. 3582A Remote Functions.....	3-39
3-19. Familiarization Exercise.....	3-3	3-170. General Description.....	3-39
3-20. Introduction.....	3-3	3-172. Remote Front Panel Programming...	3-40
3-22. Adjusting the Display.....	3-4	3-176. Syntax.....	3-40
3-24. The CAL Signal.....	3-4	3-180. Delimiters.....	3-41
3-27. The Input Mode Switch.....	3-4	3-182. Special Front Panel Commands.....	3-41
3-29. Input Considerations.....	3-5	3-184. Using Preset.....	3-41
3-34. Analyzing an Input Signal.....	3-5	3-186. Setting the Marker.....	3-41
3-46. The Frequency Span Controls.....	3-8	3-189. Instrument Data Output.....	3-42
3-53. Scales.....	3-9	3-191. Listing Control Settings.....	3-42
		3-194. Program Examples.....	3-42
		3-199. Program Example.....	3-45
		3-201. Program Example.....	3-46
		3-202. Instrument Data Input.....	3-47

TABLE OF CONTENTS (Cont'd)

Section	Page	Section	Page
3-203. Writing Alphanumeric Messages . . .	3-47	OPERATIONAL VERIFICATION . . .	3-57
3-205. Program Example	3-48	3-236. Operational Verification	3-57
3-206. Working With Memory	3-48	3-238. Required Test Equipment	3-57
3-208. The Binary Format	3-48	3-240. Preset	3-57
3-212. Memory Instructions	3-49	3-242. Instrument Warmup	3-57
3-215. Memory Locations	3-49	3-245. DC BAL Verification	3-59
3-217. Instrument Signal Processing Control and Status	3-50	3-248. ROM Self Test	3-59
3-218. Service Request	3-50	3-252. Display Accuracy	3-59
3-220. Status Word	3-50	3-257. Calibrator Accuracy	3-60
3-223. Program Example	3-51	3-262. Amplitude Accuracy and Flatness . . .	3-60
3-224. Processor Control Commands	3-51	3-267. Noise Level	3-61
3-226. Example Flowcharts and Programs . .	3-51	3-272. Harmonic Distortion	3-62
3-227. Loading a Time Record Into Memory	3-51	3-277. Common Mode Rejection	3-63
3-229. Program Example: Writing to Memory	3-53	3-282. Frequency Accuracy	3-64
3-230. Reading Binary Data From Memory	3-53	3-287. Phase Accuracy	3-65
3-232. The Learn Mode	3-53	3-292. Amplitude and Phase Match Between Channels	3-66
3-234. Program Example: The Learn Mode	3-55	3-297. Controls, Connectors and Indicators	3-67
3-235. Program Example: Plotting The Display	3-56	APPENDICES	
		A. HP-IB Command List	
		B. Condensed Description of the HP-IB	
		C. Condensed Description of Meta Messages	
		D. Application Notes	

LIST OF TABLES

Table	Page
1-1. Options	1-3
1-2. Accessories Supplied	1-3
1-3. Accessories Available	1-4
1-4. Recommended Test Equipment	1-4
1-5. Specifications	1-5
2-1. HP-IB Cables	2-5
2-2. Address Selection	2-5
3-1. Impulse Output Pulse Period	3-14
3-2. LDS Points Returned	3-45
3-3. Output Units	3-45
3-4. Display-ASCII Equivalents	3-46
3-5. Recommended Test Equipment for Operational Verification	3-58
3-6. Recommended Test Accessories	3-58
3-7. Amplitude Accuracy and Flatness	3-61

LIST OF ILLUSTRATIONS

Figure	Page	Figure	Page
2-1. Line Voltage and Fuse Selection.....	2-1	3-24. A Two Trace Plot.....	3-27
2-2. Power Cables.....	2-2	3-25. About Scope Probes.....	3-28
2-3. Typical HP-IB System Interconnection.....	2-3	3-26. Probe Compensation.....	3-28
2-4. HP-IB Connector.....	2-4	3-27. Adjusting the BAL Control.....	3-30
3-1. The Channel A CAL Signal.....	3-4	3-28. Sampling an Input Waveform.....	3-32
3-2. Spectrum of a 1 kHz Square Wave.....	3-6	3-29. Windowing a Sampled Waveform.....	3-32
3-3. Setting the Marker Position.....	3-7	3-30. Frequency Representation of a Cosine Wave.....	3-33
3-4. Using the SPAN Control to Resolve Sidebands.....	3-9	3-31. Frequency Representation of an Impulse Train.....	3-33
3-5. Expanding a Portion of the Display.....	3-11	3-32. Frequency Representation of a Square Pulse.....	3-33
3-6. Full Scale Reference in the LINEAR Mode....	3-11	3-33. Convolver the Cosine Spectrum with the Sampling Pulse Spectrum.....	3-34
3-7. A Sine Wave Spectrum Using the FLAT TOP Passband.....	3-12	3-34. Convolver a Sampled Cosine Spectrum with a Window Spectrum.....	3-34
3-8. Sine Wave Spectrum Using the HANNING Passband.....	3-13	3-35. Increasing the Frequency of a Cosine Wave.....	3-34
3-9. Sine Wave Spectrum Using the UNIFORM Passband.....	3-13	3-36. Aliasing.....	3-35
3-10. Noise Source Spectrums.....	3-14	3-37. 3582A Antialiasing Filter.....	3-35
3-11. A Two Port Network.....	3-15	3-38. The Continuous Function.....	3-35
3-12. Connecting a Single Pole Low Pass Filter....	3-15	3-39. Spectrum Points in Memory.....	3-36
3-13. Input and Output Spectrum of a Low Pass Filter.....	3-16	3-40. Memory Data Points Displayed on CRT....	3-36
3-14. Transfer Function for a Two Port Network.....	3-17	3-41. Leakage of Energy.....	3-37
3-15. Phase Transfer Function of a Low Pass Filter.....	3-18	3-42. Sidelobes of Transformed Rectangular Window.....	3-37
3-16. Phase Spectrum of a Triangle Wave.....	3-19	3-43. Data Flow.....	3-38
3-17. Selecting the Correct Harmonic.....	3-21	3-44. Window Functions.....	3-38
3-18. Modulating a Spectral Line with Noise.....	3-21	3-45. Words in Memory.....	3-48
3-19. RMS Averaged Signals.....	3-21	3-46. Storing a Time Record in Memory.....	3-52
3-20. TIME Averaged Signals.....	3-22	3-47. Reading Binary Data From Memory.....	3-54
3-21. Oscillating Frequency Spectrum.....	3-22	3-48. 3582A Front Panel Controls, Connectors and Indicators.....	3-69/3-70
3-22. Spectrum of an FM Passband.....	3-23	3-49. 3582A Rear Panel Connectors, Switches and Filter.....	3-71/3-72
3-23. The Coherence Relationship Between Two Signals.....	3-23		

SAFETY SUMMARY

The following general safety precautions must be observed during all phases of operation, service, and repair of this instrument. Failure to comply with these precautions or with specific warnings elsewhere in this manual violates safety standards of design, manufacture, and intended use of the instrument. Hewlett-Packard Company assumes no liability for the customer's failure to comply with these requirements. This is a Safety Class 1 instrument.

GROUND THE INSTRUMENT

To minimize shock hazard, the instrument chassis and cabinet must be connected to an electrical ground. The instrument is equipped with a three-conductor ac power cable. The power cable must either be plugged into an approved three-contact electrical outlet or used with a three-contact to two-contact adapter with the grounding wire (green) firmly connected to an electrical ground (safety ground) at the power outlet. The power jack and mating plug of the power cable meet International Electrotechnical Commission (IEC) safety standards.

DO NOT OPERATE IN AN EXPLOSIVE ATMOSPHERE

Do not operate the instrument in the presence of flammable gases or fumes. Operation of any electrical instrument in such an environment constitutes a definite safety hazard.

KEEP AWAY FROM LIVE CIRCUITS

Operating personnel must not remove instrument covers. Component replacement and internal adjustments must be made by qualified maintenance personnel. Do not replace components with power cable connected. Under certain conditions, dangerous voltages may exist even with the power cable removed. To avoid injuries, always disconnect power and discharge circuits before touching them.

DO NOT SERVICE OR ADJUST ALONE

Do not attempt internal service or adjustment unless another person, capable of rendering first aid and resuscitation, is present.

USE CAUTION WHEN EXPOSING OR HANDLING THE CRT

Breakage of the Cathode-ray Tube (CRT) causes a high-velocity scattering of glass fragments (implosion). To prevent CRT implosion, avoid rough handling or jarring of the instrument. Handling of the CRT shall be done only by qualified maintenance personnel using approved safety mask and gloves.

DO NOT SUBSTITUTE PARTS OR MODIFY INSTRUMENT

Because of the danger of introducing additional hazards, do not install substitute parts or perform any unauthorized modification to the instrument. Return the instrument to a Hewlett-Packard Sales and Service Office for service and repair to ensure that safety features are maintained.

DANGEROUS PROCEDURE WARNINGS

Warnings, such as the example below, precede potentially dangerous procedures throughout this manual. Instructions contained in the warnings must be followed.

WARNING

Dangerous voltages, capable of causing death, are present in this instrument. Use extreme caution when handling, testing, and adjusting.

SAFETY SYMBOLS

General Definitions of Safety Symbols Used On Equipment or In Manuals.



Instruction manual symbol: the product will be marked with this symbol when it is necessary for the user to refer to the instruction manual in order to protect against damage to the instrument.



Indicates dangerous voltage (terminals fed from the interior by voltage exceeding 1000 volts must be so marked).

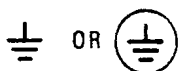

Protective conductor terminal. For protection against electrical shock in case of a fault. Used with field wiring terminals to indicate the terminal which must be connected to ground before operating equipment.



Low-noise or noiseless, clean ground (earth) terminal. Used for a signal common, as well as providing protection against electrical shock in case of a fault. A terminal marked with this symbol must be connected to ground in the manner described in the installation (operating) manual, and before operating the equipment.

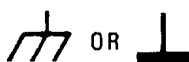

Frame or chassis terminal. A connection to the frame (chassis) of the equipment which normally includes all exposed metal structures.



Alternating current (power line).



Direct current (power line).



Alternating or direct current (power line).

DANGER

The DANGER sign denotes a hazard. It calls attention to an operating procedure, practice, condition or the like, which could result in injury or death to personnel even during normal operation.

WARNING

The WARNING sign denotes a hazard. It calls attention to a procedure, practice, condition or the like, which, if not correctly performed or adhered to, could result in injury or death to personnel.

CAUTION

The CAUTION sign denotes a hazard. It calls attention to an operating procedure, practice, condition or the like, which, if not correctly performed or adhered to, could result in damage to or destruction of part or all of the product.

NOTE:

The NOTE sign denotes important information. It calls attention to procedure, practice, condition or the like, which is essential to highlight.

CATHODE-RAY TUBE WARRANTY AND INSTRUCTIONS

The cathode-ray tube (CRT) supplied in your Hewlett-Packard Instrument and replacement CRT's purchased from -hp- are warranted by the Hewlett-Packard Company against electrical failure for a period of one year from the date of shipment from Colorado Springs. Broken tubes and tubes with phosphor or mesh burns are not included under this warranty. No other warranty is expressed or implied.

INSTRUCTION TO CUSTOMERS

If the CRT is broken when received, a claim should be made with the responsible carrier. All warranty claims with Hewlett-Packard should be processed through your nearest Hewlett-Packard Sales/Service Office (listed at rear of instrument manual).

INSTRUCTIONS TO SALES/SERVICE OFFICE

Return defective CRT in the replacement CRT packaging material. If packaging material is not available, contact CRT Customer Service in Colorado Springs. The Colorado Springs Division must evaluate all CRT claims for customer warranty, Material Failure Report (MFR) credit, and Heart System credit. A CRT Failure Report form (see reverse side of this page) must be completely filled out and sent with the defective CRT to the following address:

HEWLETT-PACKARD COMPANY
1900 Garden of the Gods Road
Colorado Springs, Colorado 80907

Parcel Post Address:
P.O. Box 2197
Colorado Springs, Colorado 80901

Attention: CRT Customer Service

Defective CRT's not covered by warranty may be returned to Colorado Springs for disposition. These CRT's, in some instances, will be inspected and evaluated for reliability information by our engineering staff to facilitate product improvements. The Colorado Springs Division is equipped to safely dispose of CRT's without the risks involved in disposal by customers or field offices. If the CRT is returned to Colorado Springs for disposal and no warranty claim is involved, write "Returned for Disposal Only" in item No. 5 on the form.

Do not use this form to accomplish CRT repairs. In order to have a CRT repaired, it must be accompanied by a customer service order (repair order) and the shipping container must be marked "Repair" on the exterior.

X-RAY RADIATION NOTICE

Model 3582A

ACHTUNG

Während des Betriebs erzeugt dieses Gerät Röntgenstrahlung. Das Gerät ist so abgeschirmt, daß die Dosisleistung weniger als 36 $\mu\text{A}/\text{kg}$ (0,5mR/h) in 5cm Abstand von der Oberfläche der Katodenstrahlröhre beträgt. Somit sind die Sicherheitsbestimmungen verschiedener Länder, u.A. der deutschen Röntgenverordnung eingehalten.

Die Stärke der Röntgenstrahlung hängt im Wesentlichen von der Bauart der Katodenstrahlröhre ab, sowie von den Spannungen, welche an dieser anliegen. Um einen sicheren Betrieb zu gewährleisten, dürfen die Einstellungen der Niederspannung und des Hochspannungsnetzteils nur nach der Anleitung in Kapitel V des Handbuchs vorgenommen werden.

Die Katodenstrahlröhre darf nur durch die gleiche Type ersetzt werden. (Siehe Kapitel VI für HP-Ersatzteile).

Das Gerät ist in Deutschland zugelassen unter der

Nummer BW/82/80/Rö

WARNING

When operating, this instrument emits x-rays; however, it is well shielded and meets safety and health requirements of various countries, such as the X-ray Radiation Act of Germany.

Radiation emitted by this instrument is less than 0.5 mR/hr at a distance of five (5) centimeters from the surface of the cathode-ray tube. The x-ray radiation primarily depends on the characteristics of the cathode-ray tube and its associated low-voltage and high voltage circuitry. To ensure safe operation of the instrument, adjust both the low-voltage and high-voltage power supplies as outlined in Section V of this manual (if applicable).

Replace the cathode-ray tube with an identical CRT only. Refer to Section VI for proper HP part number.

Number of German License: BW/82/80/Rö



MINISTERIUM
FÜR ARBEIT, GESUNDHEIT UND SOZIALORDNUNG
BADEN-WÜRTTEMBERG

Ministerium für Arbeit, Gesundheit und Sozialordnung Baden-Württemberg
Postfach 1250 - 7000 Stuttgart 1

Firma
Hewlett-Packard GmbH
Herrenberger Str. 110

7030 Böblingen



Stuttgart, den 7. Januar 1982

P am Eingang 8
im Innenhof

Fernsprecher 7357
Durchwahl (0711) 66 73-

Aktenzeichen: VII/6-3400.2.2/15/
(Bitte bei Antwort angeben) Fa. Hewlett-Packard;
Böblingen/82

Betr.: Durchführung der Verordnung über den Schutz vor Schäden
durch Röntgenstrahlen (Röntgenverordnung - RÖV) vom
1. März 1973 (BGBI. I S. 173);
hier: Bauartzulassung gemäß §§ 7 bis 10 RÖV

Bezug: Ihr Antrag vom 9. September 1981 - PSD/US/es -

Beil.: 1 Mehrfertigung

Nachtrag 1

zum Zulassungsschein Nr. BW/82/80/Rö

Aufgrund des § 7 Abs. 2 der Röntgenverordnung vom 1. März 1973
(BGBI. I S. 173) gilt die der Firma Hewlett-Packard GmbH, Herren-
berger Str. 110, 7030 Böblingen, erteilte Zulassung Nr. BW/82/80/Rö
vom 29. Januar 1981 auch für Spektrumanalysatoren, die im Werk

Hewlett-Packard Co.

Lake Stevens Instruments Div.

6330 Marine Drive

Marysville, Washington, 98270 USA

hergestellt werden.

Betriebsdaten, Auflagen, Hinweise und Befristung ergeben sich aus dem Zulassungsschein Nr. BW/82/80/RÖ vom 29. Januar 1981.

Dieser Nachtrag gilt nur im Zusammenhang mit dem vollständigen Text des o. g. Zulassungsscheins.

Dr. Dettling



Dieses Gerät wurde nach den Auflagen der Zulassungsbehörde einer Stückprüfung unterzogen und entspricht in den für den Strahlenschutz wesentlichen Merkmalen der Bauartzulassung. Die Beschleunigungsspannung beträgt maximal 23,5 kV.

Hewlett-Packard Co.
Lake Stevens Instruments Div.
6330 Marine Drive
Marysville, Washington, 98270, USA.

SECTION I

GENERAL INFORMATION

1-1. INTRODUCTION.

1-2. The Operating Manual contains information required to install, operate, and verify the instrument's operational capabilities.

1-3. The Service Manual contains the necessary information to test, adjust, and service the 3582A Spectrum Analyzer.

1-4. The part number of this manual is listed on the title page. Also listed on the title page is a Microfiche part number. This number can be used to order 4×6 inch microfilm transparencies of the manual. Each microfiche contains photo-duplicates of up to 96 manual pages. The microfiche package also includes the latest Manual Changes supplement as well as pertinent Service Notes.

1-5. SPECIFICATIONS.

1-6. Instrument specifications are listed in Table 1-5. These specifications are the performance standards against which the instrument is tested.

1-7. SAFETY CONSIDERATIONS.

1-8. This product is a Safety Class 1 instrument (provided with a 3-wire cord). The instrument and manual should be reviewed for safety markings and instructions before operation.

1-9. INSTRUCTION MANUAL SYMBOL.

1-10. Wherever the 3582A instrument is marked with this symbol, the user should refer to the instruction manual in order to protect against damage to the instrument. This symbol is found primarily in the Service Manual.

1-11. INSTRUMENTS COVERED BY MANUAL.

1-12. Attached to the instrument is a serial number plate. The serial number is in the form: 0000A00000. It is in two parts; the first four digits and the letter are the serial prefix and the last five digits are the suffix. The prefix is the same for all identical instruments; it changes only when a change is made to the instrument. The suffix, however, is assigned sequentially and is different for each instrument. The contents of this manual apply to instruments with serial number prefix(es) listed under SERIAL NUMBERS on the title page.

1-13. An instrument manufactured after the printing of this manual may have a serial number prefix that is not listed on the title page. This unlisted serial number prefix indicates the instrument is different from those described in this manual. The manual for this newer instrument is accompanied by a yellow Manual Changes supplement. This supplement contains "change information" that explains how to adapt the manual to the newer instrument.

1-14. In addition to change information, the supplement may contain information for correcting errors in the manual. To keep this manual as current and accurate as possible, Hewlett-Packard recommends that you periodically request the latest Manual Changes supplement. The supplement for this manual is identified with the manual part number, which also appears on the manual title page. Complementary copies of the supplement are available from Hewlett-Packard.

1-15. For information concerning a serial number prefix that is not listed on the title page or in the Manual Changes supplement, contact your nearest Hewlett-Packard Sales and Service Office.

1-16. DESCRIPTION.

1-17. The -hp- Model 3582A is a dual-channel spectrum analyzer covering the frequency range of 0.02 Hz to 25.6 kHz. By combining advanced digital processing techniques and a powerful micro-computer, it can provide measurement capability previously found only in complicated computer systems.

1-18. The performance features of the instrument provide optimal solutions to the problems of low frequency spectrum analysis. Frequency spans from 1 Hz to 25 kHz full scale allow great flexibility in selecting the portion of the spectrum to be analyzed. The spans from 5 Hz up to 25 kHz can be positioned anywhere within the frequency range of the instrument to provide exceptionally good frequency resolution.

1-19. Without resorting to external signal conditioning, the instrument can measure input from +30 dBV (31.6 volts) down to -120 dBV (1 microvolt). Even with this high sensitivity, the input circuits are protected against overloads of up to 100 volts. For measurements where the signal of interest exists in the presence of large unwanted signals, the wide 70 dB dynamic range of the instrument is important.

1-20. These spectrum measurements are made with "real-time" speed for frequency spans less than 500 Hz. Here real-time means that processing time is less than data acquisition time so that no input data is "lost" while waiting for processing. Data acquisition time must be increased for narrower spans to provide the required resolution. For broader spans, data acquisition time is small and processing speed becomes the limiting factor.

1-21. The Model 3582A can also measure the phase of the various spectral components or transfer function. This makes it possible to fully characterize a signal and can provide new insight into the operation of complex electrical or mechanical devices.

1-22. The most significant additional measurement capabilities of the instrument result from having two input channels that operate simultaneously. Not only can independent input signals be examined for common characteristics, but also device input/output relationships can be evaluated. The instrument directly provides both amplitude and phase information of the transfer function of a device. A built-in pseudo-random noise or a built-in random "band limited white noise" source can be used to drive the device under test to perform low frequency network analysis.

NOTE

The random "band limited white noise" source is not available on instruments with serial numbers prefixed 1747A.

1-23. Many signals cannot be analyzed with conventional spectrum analyzers because they are not stable. Digital signal processing techniques allow the Model 3582A to capture and analyze transient signals that last for only a few milliseconds.

1-24. In the Model 3582A, the large-screen CRT makes the measurement results available in a highly usable form. In addition to two simultaneous information traces, the display provides four lines of alphanumeric data giving measurement configuration and results. The alphanumeric marker makes it possible to read results directly in absolute or relative units. In addition to measurement results, the CRT is also used to display operational diagnostic messages.

1-25. In order to provide maximum confidence in the operation of the instrument, self test routines have been built in. These tests, in conjunction with the internal calibration signal, make it possible to quickly verify the calibration of the instrument before beginning a critical measurement sequence.

1-26. Virtually all of the measurement functions of the Model 3582A are remotely programmable via the Hewlett-Packard Interface Bus (HP-IB). Since actual measurement data can be remotely input or output, it is possible with a computing controller to extend the basic measurement capability.

1-27. OPTIONS.

1-28. Table 1-1 lists the options which are available for the 3582A. These options may be ordered with the instrument or installed later.

Table 1-1. Options.

3582A Option	-hp- Part Number	Description
907	5061-0090	Front Handle Kit
908	5061-0078	Rack Flange Kit
909	6061-0084	Rack Flange and Handle Kit
910	03582-90000	Extra Operating Manual
910	03582-90001	Extra Service Manual

1-29. ACCESSORIES SUPPLIED.

1-30. Table 1-2 lists the accessories supplied with the -hp- Model 3582A Spectrum Analyzer.

Table 1-2. Accessories Supplied.

Item	Quantity	-hp- Part Number
Accessory Kit (includes the following):	1 ea.	03582-84401
PC Board Extender	1 ea.	03582-66531
PC Board Extender	1 ea.	03582-66532
PC Board Extender	1 ea.	03582-66533
Fuse .25 amp 250 V Slow Blo	1 ea.	2110-0201
Fuse 1.5 amp 250 V Normal Blo	2 ea.	2110-0043
For use in the Familiarization Exercise:		
Capacitor, 3000 pF 5% 300 V	1 ea.	0160-2229
Resistor, 10 kΩ 1% ¼W	1 ea.	0757-0442

1-31. ACCESSORIES AVAILABLE.

1-32. Table 1-3 indicates the accessories which are available for the -hp- 3582A. These accessories may be obtained through your -hp- Sales and Service Office.

Table 1-3. Accessories Available.

Accessory	-hp- Model
10:1 Voltage Divider Probe	10001A
HP-IB Cables	10631A 1 meter (3.3 feet) 10631B 2 meters (6.6 feet) 10631C 4 meters (13.2 feet)
Scope Camera	Model 197A Option 006
Slide Rack Mount	Standard Slide Kit (-hp- Part No. 1497-0017) Tilt Slide Kit (-hp- Part No. 1494-0020)
Test Leads	11000A 112 cm (44 in);dual banana both ends 11001A 112 cm (44 in);dual banana to BNC

1-33. RECOMMENDED TEST EQUIPMENT.

1-34. Equipment required to maintain the Model 3582A is listed in Table 1-4. Other equipment may be substituted if it meets or exceeds the critical specifications listed in the table.

1-35. Note that the Performance Test is automatic and controlled via the Hewlett-Packard Interface Bus (HP-IB). Thus, the calculator and HP-IB compatibility for the instruments is not strictly required. However, the full manual test will take about 10 times longer than the automatic test.

1-36. If manual testing must be done, it is recommended that only the Performance Test appropriate to a specific problem and/or repair be done, supplemented by the Operational Verification given at the end of Section III.

Table 1-4. Recommended Test Equipment.

Instrument	Required Characteristics	Recommended Model(s)	Use*
Audio Oscillator	Harmonics, Hum and Noise Down at least 86 dB Freq. Range: 10 Hz – 25 kHz Output Level: 10 dBV (3.16 Vrms)	-hp- 239A/339A (See Note 1)	P
Bus Analyzer	Bus System Analyzer Meeting I.E.E.E. 488-1975 Standards	-hp- 59401A	T
Calculator (Controller)	(See Note 2)	-hp- 9825A (Option 002)	P
HP-IB Interface	(See Note 2)	-hp- 98034A	P
Calculator ROM's	(See Note 2)	-hp- 98210A -hp- 98211A -hp- 98214A	P
Counter	6 Digits Frequency Range: 200 HZ – 200 kHz Sensitivity: 50 mV rms Input Impedance: 1 MΩ, < 50 pF	-hp- 5328A	T,A

Table 1-4. Recommended Test Equipment (Cont'd).

Digital Voltmeter	HP-IB Capability (see Note 3) AC Function: Frequency Range: 200 HZ – 100 kHz Accuracy: ± (0.1% of RDNG + 0.025% of range) DC Function: Accuracy: ± (0.005% of RDNG + 0.001% of range)	-hp- 3455A	P, T
High Voltage Probe	1000:1 Division 1% Accuracy at 4 kV	-hp- 3440A-K05	A, T
Logic Probe	TTL Compatible	-hp- 10525A	T
Oscilloscope	50 MHz; range down to 5 mV/Div	-hp- 1740A -hp- 10007A Probe -hp- 10004-67605 Spanner Tip	T,A
Signature Analyzer	NA	-hp-5004A	
Synthesizer:	HP-IB Capability (see Note 3) Frequency Range: 0.02 Hz to 100 Hz Amplitude Range: –80 dBm to +13 dBm (50 ohms) Amplitude Accuracy: ±0.2 dB at 10 kHz and -70 dBm	-hp- 3330B (Option 005) -hp- 3325A (Option 002)	P,T,A
50 Ω Termination	50 ± 0.1 ohm; Feedthru	-hp- 11048C	P,T,A,
Function Generator:	Square and Triangle Outputs	-hp- 3311A -hp- 3325A	P
Load Resistor	2.5Ω, 5%, 10W	-hp- 0811-2844	A
Test Cartridge	Automatic Performance Test Software	-hp-03582-10002	P

NOTE 1: The 339A is a distortion measurement set with built-in low distortion oscillator. The oscillator alone is available as the 239A.

NOTE 2: Performance test software is written for the -hp- 9825A Calculator and 9866B Printer. Use of a different printer will require program modification. The test can be run using the 9825A's Printer, but the printout will be pass/fail rather than the full explanation given with the 9866B.

NOTE 3: HP-IB capability required for automatic testing.

*P = Performance Test; A = Adjustments; T = Troubleshooting

Table 1-5. Specifications

FREQUENCY	
FREQUENCY MODES:	
<p>0-25 kHz Span: The selected measurement is performed over the fixed frequency range of 0 Hz to 25 kHz independent of the FREQUENCY SPAN control.</p> <p>0-Start: The selected measurement is performed over the frequency range defined by the FREQUENCY SPAN control and with a fixed start frequency of 0 Hz.</p> <p>Set Center: The selected measurement is performed over a frequency range with a width determined by the FREQUENCY SPAN control and with a center frequency variable with 1 Hz resolution.</p>	<p>Set Start: The selected measurement is performed over a frequency range with a width determined by the FREQUENCY SPAN control and with a start frequency variable with 1 Hz resolution.</p> <p>FREQUENCY RANGE: 0.02 Hz to 25.5 kHz. The low frequency limit is the result of the DC response.</p> <p>FREQUENCY SPANS:</p> <p>0 Start Mode: 1 Hz full scale to 25 kHz full scale in a 1-2.5-5-10 sequence.</p>

Table 1-5. Specifications (Cont'd).

Set Start Or Set Center Mode: 5 Hz span to 25 kHz span in a 1-2.5-5-10 sequence.

FREQUENCY ACCURACY: The frequency accuracy is $\pm 0.003\%$ of the display center frequency.

FREQUENCY RESOLUTION: The marker resolution is equal to the calculated point spacing for the selected frequency span and number of channels.

FILTER PASSBAND SHAPE:

	Flat Top	Hanning	Uniform
3 dB Bandwidth: (single-channel) of span	$1.4 \pm 0.1\%$	$(0.58 \pm 0.05)\%$	$(0.35 \pm 0.02)\%$
Shape Factor:	$2.6 \pm .1$	$9.1 \pm .2$	716 ± 20

$$\left[\frac{60 \text{ dB bandwidth}}{3 \text{ dB bandwidth}} \right]$$

The FLAT TOP PASSBAND SHAPE provides optimum amplitude accuracy. The UNIFORM PASSBAND SHAPE is optimized for use with transients and for use with the PERIODIC NOISE SOURCE, and the HANNING PASSBAND SHAPE provides an amplitude/frequency resolution compromise and is used for general noise measurements.

Single-Channel Analysis Parameters:

Frequency Span	Time Record Length (NΔt)	Calculated Point Spacing (Δf)	Equivalent Noise Bandwidth		
			Flat Top	Hanning	Uniform
1 Hz	250 sec	4 mHz	14.5 mHz	6.00 mHz	4 mHz
2.5 Hz	100 sec	10 mHz	36.3 mHz	15 mHz	10.0 mHz
5 Hz	50 sec	20 mHz	72.4 mHz	30 mHz	20 mHz
10 Hz	25 sec	40 mHz	145 mHz	60 mHz	40 mHz
25 Hz	10 sec	100 mHz	362 mHz	150 mHz	100 mHz
50 Hz	5 sec	200 mHz	725 mHz	300 mHz	200 mHz
100 Hz	2.5 sec	400 mHz	1.45 Hz	600 mHz	400 mHz
250 Hz	1 sec	1 Hz	3.63 Hz	1.50 Hz	1.00 Hz
500 Hz	500 msec	2 Hz	7.24 Hz	3.00 Hz	2.00 Hz
1 kHz	250 msec	4 Hz	14.5 Hz	6.00 Hz	4.00 Hz
2.5 kHz	100 msec	10 Hz	36.3 Hz	15.0 Hz	10.0 Hz
5 kHz	50 msec	20 Hz	72.5 Hz	30.0 Hz	20.0 Hz
10 kHz	25 msec	40 Hz	145 Hz	60.0 Hz	40.0 Hz
25 kHz	10 msec	100 Hz	362 Hz	150 Hz	100 Hz

The corresponding dual-channel parameters are found by doubling the calculated point spacing and equivalent noise bandwidths and taking one half the time record length.

AMPLITUDE

AMPLITUDE MEASUREMENT MODES: 256 point amplitude spectra are measured in the single-channel mode. Two 128 point amplitude spectra are measured in the dual-channel mode.

AMPLITUDE DISPLAY MODES:

Log: 10 dB/major division
2 dB/major division

Linear: Constant voltage/major division

AMPLITUDE MEASUREMENT RANGE:

Log: The calibrated attenuator range is +30 dBV to -50 dBV single tone RMS maximum input level in 10 dB ± 0.2 dB steps. The continuous vernier provides >10 dB of additional uncalibrated sensitivity between the 10 dB steps.

Linear: The calibrated attenuator range is +30 volts RMS to 3 millivolts single tone RMS maximum input in a 1-3-10 sequence. The vernier provides continuous coverage between the major steps. The AMPLITUDE

REFERENCE LEVEL provides 8 additional ranges down to 8 microvolts full scale.

DYNAMIC RANGE:

Distortion Products: >70 dB below the maximum input level.

Spurious Responses: >70 dB below the maximum input level.

Noise:

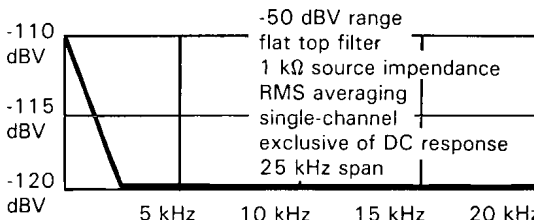

DC Response: Adjustable to >40 dB below the maximum input level with the front panel DC balance adjustment.

Table 1-5. Specifications (Cont'd).

AMPLITUDE (Cont'd)

AMPLITUDE ACCURACY:

	Log
Accuracy At The Passband Center: (Full Scale)	± 0.5 dB
Flat Top Filter:	+0, -0.1 dB
Hanning Filter:	+0, -1.5 dB
Uniform Filter:	+0, -4.0 dB

Overall accuracy is the sum of the accuracy at the passband center and the filter accuracy.

AMPLITUDE RESOLUTION:

Log: 0.1 dB with the marker

Linear: 3 digits with the marker

AMPLITUDE LINEARITY:

± 0.2 dB ± 0.02% of full scale

AMPLITUDE CALIBRATOR: The internal calibration signal is a line spectrum with nominal 1 kHz frequency spacing and a fundamental level of 22 ± 0.2 dBV on the log scales and 20 ± 0.5 volts on the linear scale.

AMPLITUDE OVERLOAD LIMITS:

Log: Overload occurs at 100% of the maximum input level which is equal to full scale when the AMPLITUDE REFERENCE LEVEL is set to NORMAL. When overload occurs spurious products may be displayed.

Linear: Overload occurs at 100% of the maximum input level which, depending on the input attenuator setting, is at 6/8 or 5/8 of full scale when the AMPLITUDE REFERENCE LEVEL is set to NORMAL. When overload occurs spurious products may be displayed.

PHASE

PHASE MEASUREMENT MODES: 256 point phase spectra are measured in the single-channel mode. Two 128 point phase spectra are measured in the dual channel mode.

PHASE DISPLAY RANGE: From 200 degrees to -200 degrees.

PHASE ACCURACY: ± 10 degrees

PHASE RESOLUTION:

Display: 50 degrees/major division

Marker: 1 degree

TRANSFER FUNCTION

TRANSFER FUNCTION MEASUREMENT MODES: Dual-channel 128-point transfer functions are measured.

TRANSFER FUNCTION DISPLAY MODES:

Log Amplitude: 10 dB/major division
2 dB/major division

Linear Amplitude: Constant floating point fraction/major division

Phase: Constant 50 degrees/major division

TRANSFER FUNCTION MEASUREMENT RANGE:

Log Amplitude: Calibrated ranges of +160 dB full scale to -80 dB full scale in 10 dB steps. The uncalibrated verniers provide continuous coverage between the 10 dB steps.

Linear Amplitude: Calibrated ranges of 4.0 x 10⁸ full scale to 4.0 x 10⁻⁸ full scale in factor of 10 steps. The un-

calibrated verniers provide continuous coverage between the factor of 10 steps.

Phase Display Range: +200 degrees to -200 degrees.

TRANSFER FUNCTION ACCURACY (STANDARD):

Amplitude: ± 0.8 dB

Phase: ± 5 degrees

TRANSFER FUNCTION ACCURACY (OPTION 001):

	.02Hz	5kHz	25.5kHz
Amplitude:	.4dB	± .8dB	
Phase:	± 2°	± 5°	

TRANSFER FUNCTION RESOLUTION:

Log Amplitude: 0.1 dB with the marker

Linear Amplitude: 3 digit scientific notation with the marker

Phase: 1 degree with the marker

COHERENCE FUNCTION

COHERENCE FUNCTION MEASUREMENT MODE: Dual-channel 128 point coherence functions are measured with RMS averaging only.

COHERENCE MEASUREMENT RANGE: The bottom display line is 0.0 and the top display line is 1.0.

COHERENCE FUNCTION RESOLUTION:

Display: 0.125/major division

Marker: 0.01

Table 1-5. Specifications (Cont'd).

TRIGGER	
<p>TRIGGER MODES:</p> <p>Free Run: A new measurement is initiated by the completion of the previous measurement.</p> <p>External: A rear panel switch allows new measurements to be initiated by an external TTL pulse.</p> <p>Input Signal: A new measurement is initiated when the input signal meets the specified trigger condition.</p>	<p>TRIGGER CONDITIONS:</p> <p>Signal Conditions: Triggering can be selected to occur on a positive or negative going transition through the trigger level. The trigger level is adjusted between the time record overload limits by a continuous vernier.</p> <p>Single/Multiple Triggers: Single-shot triggering is specified by taking the instrument out of the REPETITIVE mode. The ARM control sensitizes the instrument to take another measurement in the non-repetitive mode.</p>
INPUT CHANNELS	
<p>INPUT IMPEDANCE: $10^6\Omega \pm 5\%$ shunted by <60 pf from input high to low for less than 75% relative humidity.</p> <p>DC ISOLATION: Input low may be connected to chassis ground or floated up to 30 volts to reduce the effects of ground loops on the measurement.</p> <p>INPUT COUPLING: The input circuit may be AC or DC coupled. The low frequency 3 dB roll off of the AC coupling is <1 Hz.</p>	<p>COMMON MODE REJECTION:</p> <p>50 Hz: >60 dB</p> <p>60 Hz: >58 dB</p> <p>INPUT CHANNEL CROSSTALK: <-140 dB between channels with 1 kΩ source impedance driving one channel and the other channel terminated in 1 kΩ.</p>
OUTPUT SIGNALS	
<p>X-Y RECORDER:</p> <p>Vertical: 0 to 5.25V $\pm 5\%$</p> <p>Horizontal: 0 to 5.25V $\pm 5\%$</p> <p>Impedance: 1kΩ</p> <p>Pen Lift: Contact closure during sweep.</p> <p>NOISE SOURCE:</p> <p>Periodic: Pseudorandom noise signal with spectral line spacings that match the calculated point spacing for the selected frequency span. The noise spectrum is band limited and band translated to match the selected measurement.</p>	<p>Random: Random noise signal; the noise spectrum is band limited and band translated to match the selected measurement.</p> <p>Level: Vernier control from <10 mV to >500 mV RMS into a load of $\geq 50\Omega$ when measured with a broadband True RMS voltmeter.</p> <p>Periodic Noise Frequency Response: ± 1 dB with UNIFORM PASSBAND SHAPE and -10 dBV level.</p> <p>Impedance: $<2\Omega$</p> <p>IMPULSE SOURCE: A TTL low to high pulse with a period equal to the time record length.</p>
DISPLAY	
<p>CRT:</p> <p>Screen Size: 11.9 cm (4.7 in.) wide by 9.6 cm (3.8 in.) high.</p> <p>Graticule: 10 major division horizontal by 8 major divisions vertical with internal illumination for CRT photography.</p> <p>Text: Maximum of four 32 character lines of alphanumeric text.</p> <p>ALPHANUMERIC ANNOTATION: Single or dual-channel configuration, input or stored trace, frequency calibration, amplitude calibration, equivalent noise bandwidth,</p>	<p>relative or absolute marker frequency, relative or absolute marker phase, relative or absolute marker coherence, RMS noise density at the marker, time record collection time.</p> <p>DISPLAY ACCURACY: Display accuracy is 3% of total height or width for $25 \pm 15^\circ\text{C}$. Note that if numeric readings are taken visually from the displayed trace, this factor must be added to the basic accuracy specification.</p> <p>TRACE STORAGE: A maximum of two independent traces may be digitally stored and recalled. Annotation information is not stored with the traces.</p>

Table 1-5. Specifications (Cont'd).

AVERAGE

AVERAGING MODES:

RMS: For each calculated frequency point the displayed amplitude is

$$\sqrt{\frac{1}{N} \sum_i^N A_i^2(f)} \quad \text{and the phase is} \quad \frac{1}{N} \sum_i^N \theta_i(f)$$

Peak: For each calculated frequency point the displayed amplitude is MAX Ai(f) and the phase is the corresponding value for the retained amplitude point.

Time: For each time record point the amplitude is

$$\frac{1}{N} \sum_i A_i(t)$$

The averaged time record is transformed to give the corresponding amplitude and phase.

NUMBER OF AVERAGES: 4 to 256 in a binary sequence plus exponential. Exponential in the RMS mode gives a running average with new spectral data weighted 1/4 and the previous result by 3/4. Exponential in the peak mode gives a continuous peak hold operation.

REMOTE OPERATION

PROGRAMMING: All analyzer front panel controls except the CRT controls, NOISE SOURCE LEVEL and TYPE, TRIGGER LEVEL, AMPLITUDE VERNIERS, and GROUND ISOLATION are remotely programmable via the HP-IB.

DATA INPUT: Time records, amplitude and phase spectra, coherence functions, transfer functions and

alphanumeric text can be input to the analyzer via the HP-IB.

DATA OUTPUT: Time records, amplitude and phase spectra, coherence functions, transfer functions, alphanumeric text, marker values and control settings can be output via the HP-IB.

GENERAL

ENVIRONMENTAL:

Operating Temperature: 0°C to +55°C.

Non-operating Temperature: -40°C to +75°C.

Humidity: To 95% relative humidity at 40°C.

Operating Altitude: 4600 Meters (15,000 feet).

Non-operating Altitude: 6300 Meters (25,000 feet).

Shock: 30 G, 11 msec half sine wave on each of six sides.

Vibration: 10 Hz to 55 Hz at 0.010 inch peak-to-peak excursion.

OPERATING POWER: Switch selection of 110V +5, -10% or 230V +5, -10% 48-66 Hz; less than 150 VA.

PHYSICAL PARAMETERS:

Size: 425.5 mm (16.75 inches) wide
552.5 mm (21.75 inches) deep
188 mm (7.4 inches) high

Net Weight: 24.5 kg (54 lbs.).

Shipping Weight: 29 kg (63 lbs.).

SECTION II INSTALLATION

2-1. INTRODUCTION.

2-2. This section contains instructions for installing and interfacing the Model 3582A Spectrum Analyzer. Included are initial inspection procedures, power and grounding requirements, environmental requirements, installation instructions, interfacing procedures and instructions for repacking and shipment.

2-3. INITIAL INSPECTION.

2-4. This instrument was carefully inspected both mechanically and electrically before shipment. It should be free of marks or scratches and in perfect electrical order upon receipt. To confirm this, the instrument should be inspected for physical damage incurred in transit. If the instrument was damaged in transit, file a claim with the carrier. Check for supplied accessories (listed in Section I) and test the electrical performance using the Operational Verification given in Section IV Part II. If there is damage or deficiency, see the warranty in the front of this manual.

2-5. POWER REQUIREMENTS.

2-6. The Model 3582A can be operated from any power source supplying 100V, 120V, 220V or 240V (-10% to +5%), 48 Hz to 66 Hz single phase. Power consumption is less than 150 VA.

2-7. Line Voltage And Fuse Selection.

2-8. Figure 2-1 gives information for line voltage and fuse selection. The voltage and proper fuse have been factory selected for 120V ac operation.

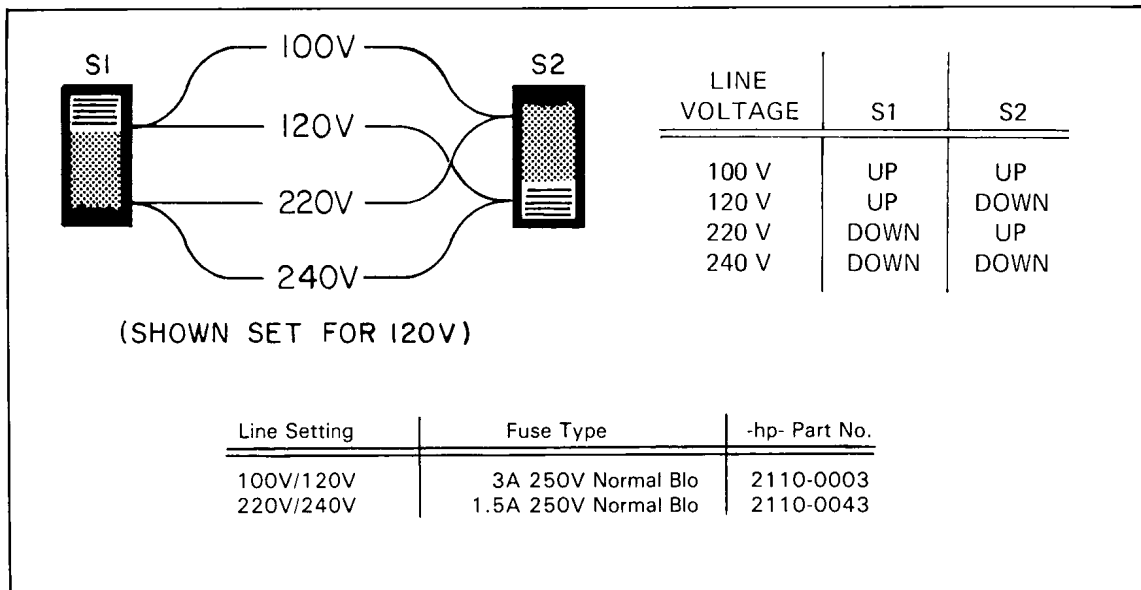

Figure 2-1. Line Voltage And Fuse Selection.

2-9. Power Cable and Grounding Requirements.

2-10. To protect operating personnel, the National Electrical Manufacturer's Association (NEMA) recommends that the instrument panel and cabinet be grounded. The Model 3582A is equipped with a three-conductor power cord which, when plugged into an appropriate receptacle, grounds the instrument cabinet. The type of power cable plug shipped with each instrument depends on the country of destination. Refer to Figure 2-2 for the part number of the power cable and plug configurations available.

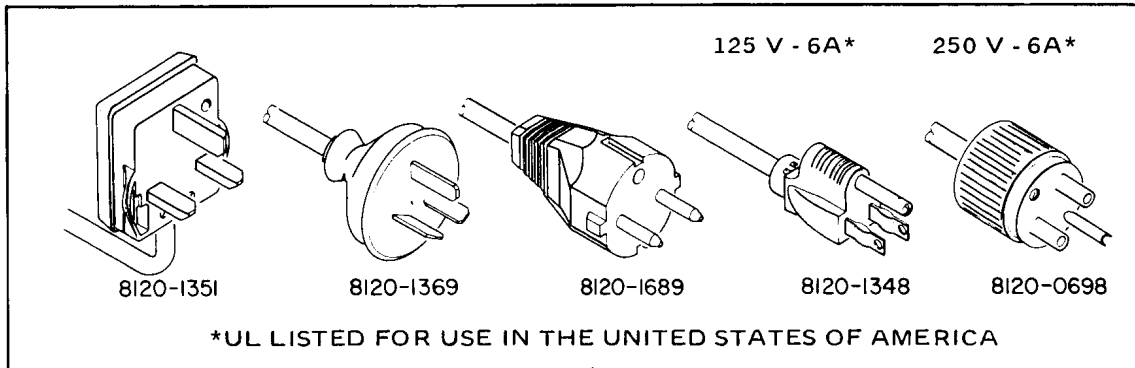

Figure 2-2. Power Cables.

2-11. OPERATING ENVIRONMENT.

2-12. Temperature.

2-13. The instrument may be operated in temperatures from 0°C to +55°C.

2-14. Humidity.

2-15. The instrument may be operated in environments with humidity up to 95%. However, the instrument should be protected from temperature extremes which cause condensation within the instrument.

2-16. Altitude.

2-17. The instrument may be operated at altitudes up to 4600 meters (15,000 feet).

2-18. Cooling Fan.

2-19. The 3582A is equipped with a cooling fan mounted on the rear panel. The instrument should be mounted so that air can freely circulate through it. The filter for the cooling fan can be removed and cleaned by flushing with soapy water.

2-20. Thermal Cutout.

2-21. The 3582A is equipped with a thermal cutout switch which automatically removes line voltage whenever the internal temperature becomes excessive. The temperature at which this will occur is dependent upon line voltage and airflow but with proper airflow will not occur in less than a 55°C ambient at high line. The switch resets automatically when the instrument cools. If a thermal cutout occurs, check for fan stoppage, clogged fan parts and other conditions that could obstruct airflow or otherwise cause excessive heating.

NOTE

The thermal cutout will operate at any external temperature down to +15°C if the airflow is blocked.

2-22. INSTALLATION.**2-23. Mounting.**

2-24. The 3582A is shipped with plastic feet and tilt stand in place, ready for use as a bench instrument. The plastic feet are shaped so that the 3582A may be mounted on top of other -hp- equipment. Plastic feet mounted on the rear panel enable the 3582A to be placed in a vertical position if desired. When operating the instrument, choose a location that provides at least three inches of clearance at the rear and at least one inch for each side. Failure to provide adequate air clearance will result in excessive internal temperature, reducing instrument reliability. The clearances provided by the plastic feet in bench stacking and the filler strip in rack mounting allow air passage across the top and bottom cabinet surfaces.

2-25. Option 908 (Rack Mount Kit) enables the 3582A to be mounted in an equipment cabinet. The rack mount for the 3582A is an EIA standard width of 19 inches. Installation instructions are included with the Rack Mount Kit. Option 908 may be ordered from the nearest -hp- Sales and Service Office under -hp- part number 5061-0078.

2-26. HP-IB SYSTEM INTERFACE CONNECTIONS.

2-27. The Model 3582A instrument is compatible with the Hewlett-Packard Interface Bus (HP-IB).

NOTE

The HP-IB is Hewlett-Packard implementation of IEEE std. 488-1975, "Standard Digital Interface for Programmable Instrumentation".

2-28. The instrument is connected to the HP-IB by connecting an HP-IB interface cable to the connector located on the rear panel. Figure 2-3 illustrates a typical HP-IB System interconnection.

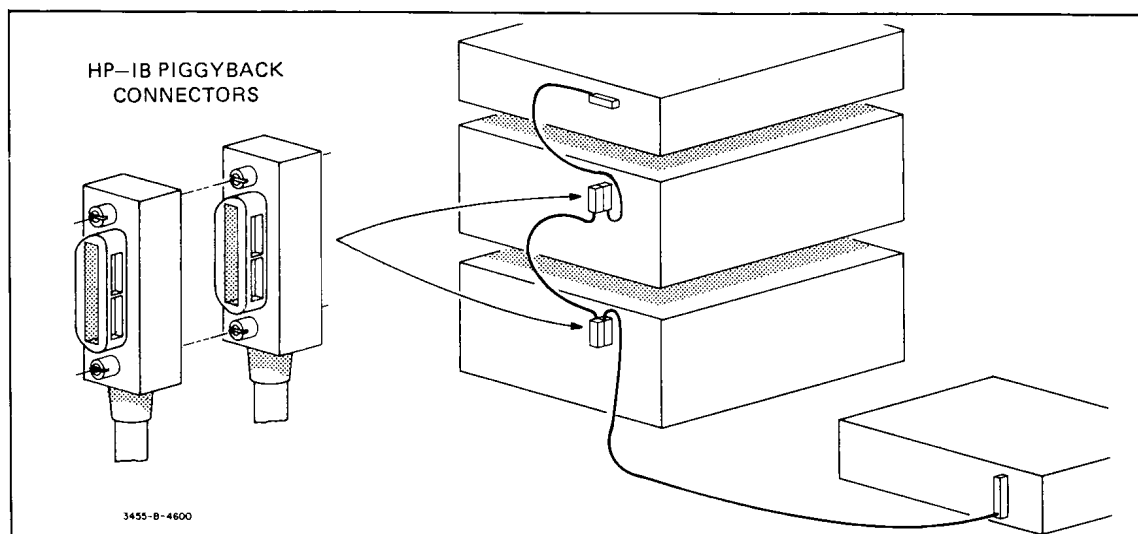

Figure 2-3. Typical HP-IB System Interconnection.

2-29. With the HP-IB system, you can interconnect up to 15 HP-IB compatible instruments. The -hp- 10631 HP-IB cables have identical "piggy-back" connectors on both ends so that several cables can be connected to a single source without special adapters or switch boxes. You can interconnect system components and devices in virtually any configuration you desire. There must, of course, be a path from the calculator (or other controller) to every device operating on the bus. As a practical matter, avoid stacking more than three or four cables on any one connector. If the stack gets too long, any force on the stack produces great leverage which can damage the connector mounting. Be sure that each connector is firmly screwed in place to keep it from working loose during use. The 3582A uses all the available HP-IB lines, therefore, any damaged connector pins may adversely affect HP-IB operation (see Figure 2-4).

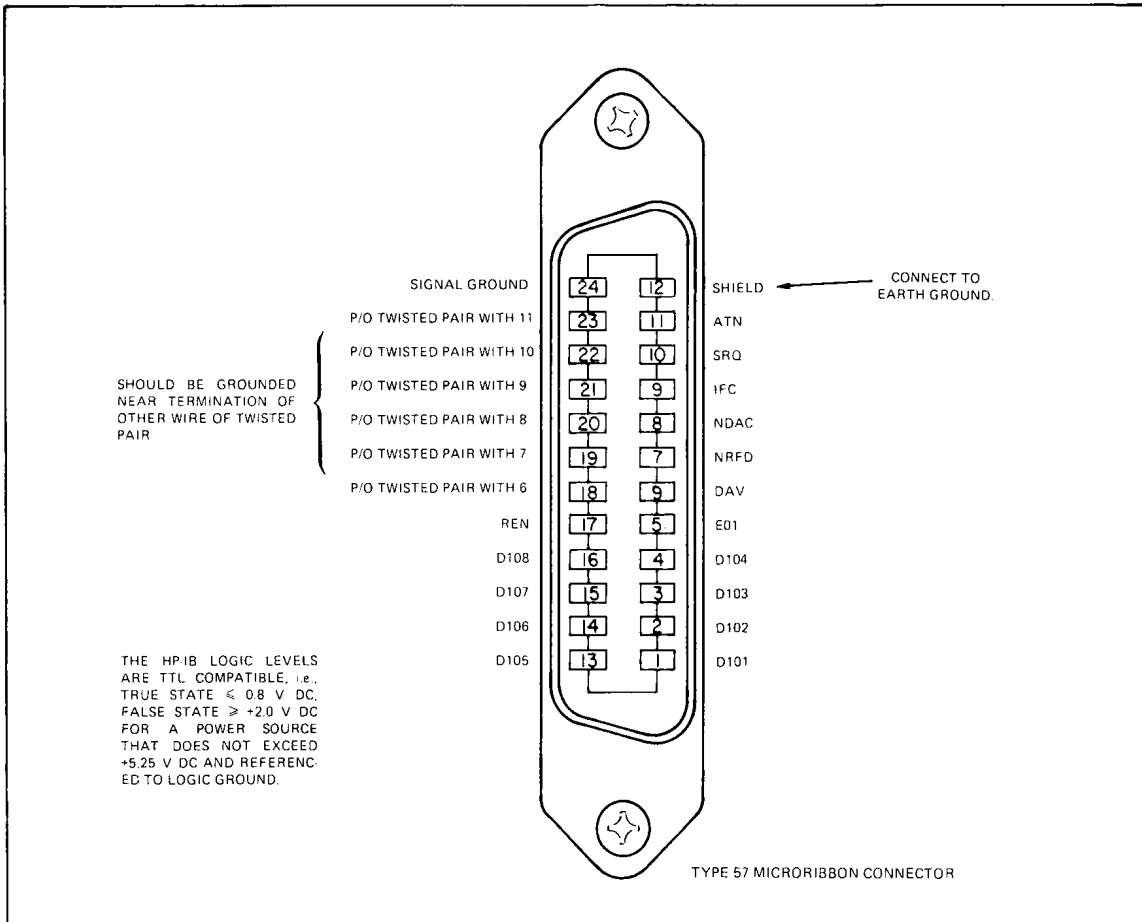

Figure 2-4. HP-IB Connector.

2-30. Cable Length Restrictions.

2-31. To achieve design performance with the HP-IB, proper voltage levels and timing relationships must be maintained. If the system cable is too long, the lines cannot be driven properly and the system will fail to perform (see Table 2-1 for HP-IB cable lengths). Therefore, when interconnecting an HP-IB system, it is important to observe the following rules:

- a. The total cable length for the system must be less than or equal to 20 meters (65 feet).
- b. The total cable length for the system must be less than or equal to 2 meters (6 feet) times the total number of devices connected to the bus.

address, model number, and full serial number. Also, mark the contain FRAGILE to ensure careful handling. In any correspondence, refer to the instrument by model number and full serial number.

2-39. Other Packaging. The following general instructions should be used for repacking with commercially available materials:

- a. Wrap the instrument in heavy paper or plastic. (If shipping to a Hewlett-Packard office or service center, attach a tag indicating the type of service required, the return address, the model number, and the full serial number.)
- b. Use a strong shipping container. A double-wall carton made of 350-pound test material is adequate.
- c. Use a layer of shock-absorbing material 70 to 100 mm (3 to 4 inch) thick around all sides of the instrument to provide firm cushioning and prevent movement inside of the container. Protect the control panel with cardboard.
- d. Seal shipping container securely.
- e. Mark shipping container FRAGILE to ensure careful handling.
- f. In any correspondence, refer to the instrument by model number and full serial number.

WARNING

The Model 3582A is not intended for outdoor use. Do not expose it to rain or other excessive moisture.

Table 2-1. HP-IB Cables.

HP-IB Cable	Length
10631A	3 feet
10631B	6 feet
10631C	12 feet

2-32. HP-IB Address Selection.

2-33. The “talk” and “listen” addresses for the instrument are selected by the Instrument Bus Address switch. This switch is the seven section “DIP” switch located on the A2 HP-IB board under the front right card nest cover in the instrument. the five switches labeled 1 through 5 are used to select the unique talk and listen address. The instrument may be left at its factory settings of + K for the talk and listen address or it may be set to any of the alternate settings available. Refer to Table 2-2 for the available address codes and the corresponding switch settings.



Access to the HP-IB Address switch requires removal of the instrument top cover, exposing potentially lethal voltages. To avoid electrical shock, do not attempt to check or change the switch setting unless you are properly service trained.

NOTE

The 5-bit decimal code, consisting of bits A1 through A5, is often used by controllers which use this code convention as a System Device Number for instruments.

2-34. STORAGE AND SHIPMENT.

2-35. Environment.

2-36. The instrument may be stored or shipped in environments within the following limits:

- Temperature.....-40°C to +75°C
- Humidity.....Up to 95%
- Altitude.....Up to 7,630 meters (25,000 feet)

The instrument should also be protected from temperature extremes which cause condensation within the instrument.

2-37. Packaging.

2-38. Original Packaging. Containers and materials identical to those used in factory packaging are available through Hewlett-Packard offices. If the instrument is being returned to Hewlett-Packard for servicing, attach a tag indicating the type of service required, return

Table 2-2. Address Selection.

ASCII Code Character		Address Switches					5-bit Decimal Code
Listen	Talk	A5	A4	A3	A2	A1	
SP	@	0	0	0	0	0	00
!	A	0	0	0	0	1	01
"	B	0	0	0	1	0	02
#	C	0	0	0	1	1	03
\$	D	0	0	1	0	0	04
%	E	0	0	1	0	1	05
&	F	0	0	1	1	0	06
'	G	0	0	1	1	1	07
(H	0	1	0	0	0	08
)	I	0	1	0	0	1	09
*	J	0	1	0	1	0	10
+	K	0	1	0	1	1	11
,	L	0	1	1	0	0	12
-	M	0	1	1	0	1	13
.	N	0	1	1	1	0	14
/	O	0	1	1	1	1	15
0	P	1	0	0	0	0	16
1	Q	1	0	0	0	1	17
2	R	1	0	0	1	0	18
3	S	1	0	0	1	1	19
4	T	1	0	1	0	0	20
5	U	1	0	1	0	1	21
6	V	1	0	1	1	0	22
7	W	1	0	1	1	1	23
8	X	1	1	0	0	0	24
9	Y	1	1	0	0	1	25
:	Z	1	1	0	1	0	26
<	[1	1	0	1	1	27
<	\	1	1	1	0	0	28
=]	1	1	1	0	1	29
>	~	1	1	1	1	0	30

INSTRUMENT ADDRESS

NOT USED

SERVICE

1 POSITION (UP)
 0 POSITION (DOWN)

SECTION III PART I MANUAL OPERATION

3-1. INTRODUCTION.

3-2. This section contains the complete operating instructions as they relate to manual operation. Remote operating instructions, such as those from the HP-IB, are contained in Section III, Part II. Included in this section are the turn-on procedure, a description of the 3582A, a familiarization exercise, and specific operating data.

3-3. CONTROLS, CONNECTORS, AND INDICATORS.

3-4. On the foldout at the end of Section III is an illustration of all front and rear panel controls, connectors and indicators. The description of each item is keyed to the drawing within the figure.

NOTE

To permit maximum CRT life, always turn the instrument power LINE switch or the intensity control to OFF when the instrument is not in use for extended periods.

3-5. TURN-ON PROCEDURE.

3-6. If you have never used the 3582A, you are probably anxious to get started. Notice that the 3582A front panel switches are arranged in functional groups. The pushbuttons in each group are either momentary contact or push to turn on and push to turn off. Framed functions in some groups may be placed in the ON position to establish a basic turn-on mode of operation. If an apparent operating difficulty arises due to the inadvertant setting of switches or power line fluctuations, resetting the instrument to the basic turn-on mode and pressing the RESET button (colored orange) will often solve the problem (see the instrument pullout card). Preset the front panel switches for turn-on as follows:

Button Positions:  ON  OFF

Set both framed buttons.....	ON(IN)
Set AMPLITUDE A.....	ON
Set SCALE 10 dB/DIV.....	ON
Set AVERAGE NUMBER 4.....	ON
Set PASSBAND SHAPE.....	FLAT TOP
Set all other buttons.....	OFF
AMPLITUDE REFERENCE LEVEL.....	NORM
FREQUENCY MODE.....	0-25 kHz
TRIGGER LEVEL.....	FREE RUN
INPUT CHANNEL A SENSITIVITY.....	30 dBV
VERNIER.....	CAL
INPUT CHANNEL B SENSITIVITY.....	30 dBV
VERNIER.....	CAL
INPUT MODE.....	A
TRIGGER (REAL PANEL).....	INT

3-7. Connect the 3582A to a suitable power source (see Section II, Installation). Set the LINE switch to the ON position. While the instrument is warming up (allow 1 or 2 minutes), read the following information about spectrum analyzers and the description of the 3582A.

3-8. ABOUT SPECTRUM ANALYZERS.

3-9. The first spectrum analyzers were introduced during World War II for use in the development of pulse radar systems. Early spectrum analyzers were difficult to operate and interpret since they lacked such refinements as calibrated controls. They were, however, adequate tools which enabled scientists to observe the spectra of radar pulses and subsequently optimize the gain and bandwidth of radar receivers. Since that time, spectrum analyzers have evolved into general purpose instruments with unlimited applications. The 3582A is a low frequency spectrum analyzer designed for use below 25 kHz.

3-10. A COMPARISON.

3-11. Most low frequency spectrum analyzers use analog circuits to sweep the frequency band of interest and display the spectral components. This may require complex analog circuits with many associated adjustments to assure good signal analysis. Also, High Q circuits required for narrow bandwidths have long settling times resulting in slow operation.

3-12. In contrast, the 3582A converts the analog input signal into discrete digital data through a sampling process. This data is then processed by a unique "digital filter" to obtain the frequency band of interest before it is stored in memory for analysis. A "computer-like" processor performs a Discrete Fast Fourier Transform and other mathematical operations on the stored data allowing the 3582A to display a great variety of information in a timely manner. For example, the 3582A will provide spectral data at greater than 100 times the speed of the -hp- 3580A Spectrum Analyzer (using conventional swept L.O. techniques) for narrow bandwidths.

3-13. FEATURES.

3-14. The 3582A, because of its digital design, offers many operating features not found in "conventional" spectrum analyzers. Some of the more prominent features are listed in Operating Features on the following page.

3-15. THE DISPLAY.

3-16. The display on the 3582A contains both alphanumeric and graphical data. The graphical display of spectra is discrete in nature and is presented as a series of line segments connecting discrete data points.

3-17. There are many problems associated with changing continuous waveforms into discrete data. Sampling processes and finite measurement times generate some extraneous information which effect frequency analysis operations and may appear as undesirable display data. These display aberrations become more pronounced when a narrow passband is used and the frequency is shifted slightly. The effects of discrete measurements are explained in more detail in Simplification of Discrete Data Analysis.

OPERATING FEATURES

<p>Frequency Range: .02 Hz to 25 kHz</p> <p>Amplitude Range: 3 mV to 30 V maximum input</p> <p>Display Range: 80 dB (dynamic range > 70 dB)</p> <p>Display: Two channel input and capability of displaying or storing two traces simultaneously. The traces may contain the following information.</p> <ol style="list-style-type: none"> 1. Phase: either or both channels 2. Amplitude: either or both channels 3. Phase Transfer Function 4. Amplitude Transfer Function 5. Coherence 6. Time Function: either channel can be displayed but not stored <p>Zoom: Zoom can expand any portion of the display to a maximum of .5 Hz/cm</p> <p>Marker: Manually moveable marker can be used for determining frequency, amplitude, and phase on any point of the selected spectrum. The marker is not usable on stored traces.</p> <p>Averaging: RMS and Time averaging functions and selectable averaging cycles. Also there is a Peak hold mode.</p> <p>Noise Source: Amplitude adjustable (periodic or random)</p>	<p style="text-align: center;">NOTE</p> <p><i>Random noise source is not available on instruments with serial numbers prefixed 1747A.</i></p> <p>Noise Measurement: Volts/$\sqrt{\text{Hz}}$ can be measured directly</p> <p>Filter Shapes: Three selectable filter (PASSBAND) shapes:</p> <ol style="list-style-type: none"> 1. Flat Topped: Best for measuring accurate amplitude of discrete spectra. 2. Hanning: More selective than Flat Topped filter (narrower 3 dB passband) but less accurate. Better for frequency measurements where spectral amplitudes are relatively equal (within 50 dB). 3. Uniform: Useful for analyzing transients. Also the 3582A's Periodic Noise Source is optimized for this filter to improve analysis. <p>Filter Bandwidth: Automatically selected</p> <p>HP-IB: The Hewlett-Packard Interface Bus permits interconnection to a controller (such as the -hp- 9825A Calculator) and affords programmability plus data transfer capabilities.</p>
--	--

3-18. The discrete display may appear somewhat different from conventional spectrum analyzers, however, the locus of all points represented by the graphical display will be accurate within the specifications for the mode of operation selected.

3-19. FAMILIARIZATION EXERCISE.

3-20. Introduction.

3-21. The familiarization exercise is intended to give the user a general introduction to the instrument controls and their functions. The exercise will begin with simplified displays of data and proceed to the more complex modes of operation and data display. To help facilitate making sample measurements, a 10 k Ω resistor, a 3000 pF capacitor, and a function generator will be required (suggestion: a Hewlett-Packard 3312A Function Generator will provide all the necessary output signals). To avoid confusion, follow the procedures and switch settings in the order given.

3-22. Adjusting the Display.

3-23. The 3582A should already be set up in the basic turn-on mode as indicated in the Turn-On Procedure. Press the SCALE 2 dB/DIV button and set CHANNEL A and B SENSITIVITY to CAL. Adjust the INTENSITY and FOCUS to obtain a well defined trace. An ASTIG (astigmatism) control is provided, but adjustment is only necessary if the FOCUS control cannot produce a clear display. The trace being displayed is the channel A calibration signal.

3-24. The CAL Signal.

3-25. An internal calibration signal is provided to check instrument operation and is switched into the input circuits whenever the CHANNEL A or CHANNEL B SENSITIVITY control is placed in the CAL position. A display of spectral lines, which have an amplitude of 22 dBm (or 20 V in LINEAR mode) and are 1 kHz apart, serve as a quick reference for verifying the amplitude and frequency calibration of the instrument (see Figure 3-1). These non-equivalent levels result in displays of exactly half full scale for LINEAR and 2 dB/DIV display settings. To display the channel B CAL signal, make the following switch changes:

DISPLAY AMPLITUDE A.....OFF
 DISPLAY AMPLITUDE B.....ON

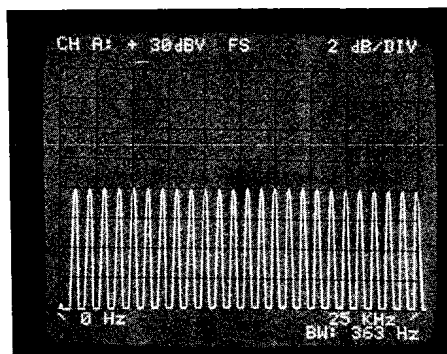

Figure 3-1. The Channel A CAL Signal.

3-26. Notice that the display message indicates that an invalid condition exists. This is one of several messages that help to insure proper instrument operation. To continue though, place the INPUT MODE switch to the B position to obtain the correct display.

3-27. The Input Mode Switch.

3-28. The INPUT MODE switch position establishes one or two channel operation. Because the display and analysis techniques are discrete and the amount of memory space limited, the number of displayed data points are divided in half for two channel operation. As a result of this division, the instrument doubles the bandwidth even though the SPAN setting remains the same. To observe this condition on the display, slowly alternate the INPUT MODE switch between B and BOTH. Reset the following switches:

DISPLAY AMPLITUDE B.....OFF
 DISPLAY AMPLITUDE A.....ON
 INPUT MODE.....A

3-29. Input Considerations.

3-30. Voltage Limitations. Before connecting any device to the input terminals, be aware of the maximum voltages which are marked on the Front Panel and listed as follows:

MAXIMUM INPUT VOLTAGE.....100 V rms or \pm 100 Vdc
MAXIMUM ISOLATION VOLTAGE.....30 V MAX

3-31. AC-DC Coupling. A front panel slide switch selects ac or dc coupling. AC coupling is useful for analyzing signals which have a high dc offset. Note that the absolute value of the dc offset plus the absolute value of the peak voltage of the signal must be less than 100 V dc. This capacitive type of coupling acts like a high pass filter which has a - 3 dB point at .5 Hz. DC coupling has the widest area of applications and the 0 Hz frequency spectral component is presented on the display when the range of frequencies selected include 0 Hz but do not use the dc component to measure dc as some inaccuracies may result. Set the following switches:

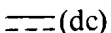
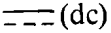
A COUPLING..... (dc)
B COUPLING..... (dc)

3-32. Input Isolation. The input section of the 3582A can be isolated to permit measurements where ground loops may be present. When the ISOL-CHAS switch is in the CHAS position, the lower (black)-input terminal is connected to the chassis which in turn is connected to the power system ground through the offset pin on the power plug. It is not advisable to isolate the chassis through a power plug adapter which would, in effect, render the instrument in an unsafe condition. When the ISOL-CHAS switch is set to ISOL, it disconnects the input low from chassis ground; the maximum isolation voltage must not be greater than 30 V max above the chassis potential (0 V). Set the following switch:

ISOL-CHAS CHAS

3-33. Balance Adjustments. Balance adjustments (BAL) are provided for each channel and may be used to change the dc offset voltage output of the input amplifiers. Under normal operating conditions, no change in the BAL setting is required. However, the BAL adjustment may be made for each setting of the INPUT SENSITIVITY switches. Specific instructions for setting the BAL adjustment are given under Front Panel Screwdriver Adjustment.

NOTE

The dc balance, if it is far out of adjustment, may cause a premature overload condition.

3-34. Analyzing an Input Signal.

3-35. Connecting the Input. Set the controls on the function generator for a 1 kHz square wave output. Connect this output to the channel A input of the 3582A (a shielded cable with suitable connectors is recommended, but not mandatory). Make the following switch changes:

CHANNEL A SENSITIVITY.....30 dBV
 DISPLAY SCALE.....10 dB/DIV

3-36. Setting the Input Sensitivity. Adjust CHANNEL A SENSITIVITY to achieve an approximately full scale display without overloading the input. The input amplitude will be referenced to a calibrated full scale amplitude on the display (see Figure 3-2). Each INPUT SENSITIVITY switch has a concentric control which is an 11 dB attenuator. This may be used to decrease the signal amplitude between INPUT SENSITIVITY ranges, however, the displayed amplitude will not be referenced to a calibrated full scale amplitude. It is always a good operating procedure to set the INPUT SENSITIVITY switch to its least sensitive position and then increase the sensitivity to obtain an adequate display amplitude. The OVERLOAD light will indicate if the input magnitude is too large. An indication on the alphanumeric portion of the display will appear if an overload condition occurs during the period when data is being taken. (There could be a possible overload in the data.)

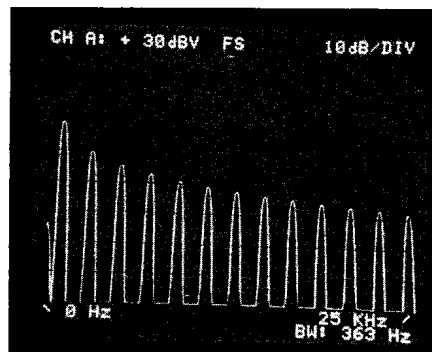

Figure 3-2. Spectrum of a 1 kHz Square Wave.

3-37. The Triggering Controls. The triggering controls determine when the input signal will start to be sampled for analysis. The input trigger is derived from one of the following sources:

- a. A signal level on channel A input.
- b. An external TTL level input on the rear panel.

3-38. When data is being taken, the DATA LOADING annunciator will be on. The LEVEL control in combination with the SLOPE switch determine the portion of the wave shape which will initiate a trigger. When the LEVEL control is in the FREE RUN position, data will be taken as fast as it can be processed. The REPETITIVE switch, when placed in the off position, places the instrument in a single scan mode of operation. In this mode a trigger can be generated as described above, but only after the trigger circuits are enabled by an arm command generated by pressing the ARM button. An annunciator light, located adjacent to the ARM button, indicates when an arm command has been initiated. Try the following procedure:

- a. Move the LEVEL control out of FREE RUN to the approximate center position. A trigger initiated by the input signal will continue the scan operation.
- b. Set REPETITIVE to OFF for single scan operation.

c. To initiate a scan, press the ARM button. A single scan will take place almost immediately.

d. Make the following switch changes:

LEVEL.....FREE RUN
 REPETITIVE.....ON

NOTE

The FREE RUN position is framed to draw attention to it. If the TRIGGER LEVEL is inadvertently left on and an appropriate input signal is not available, the instrument will stop taking data and appear to be "hung up".

3-39. Marker Controls. The 3582A has a unique movable marker which is set by the POSITION control. The marker frequency is displayed in addition to three amplitude functions:

- a. Normal marker amplitude.
- b. Amplitude of noise in the equivalent noise bandwidth ($\div \sqrt{BW}$).
- c. Relative amplitude (the frequency is also relative (REL)).

3-40. Normal Marker Amplitude. Set the MARKER ON switch to ON. A bright dot will appear on the trace. Rotate the POSITION control to place the marker at a point of interest. In Figure 3-3 the marker has been set on the 1 kHz spectral line.

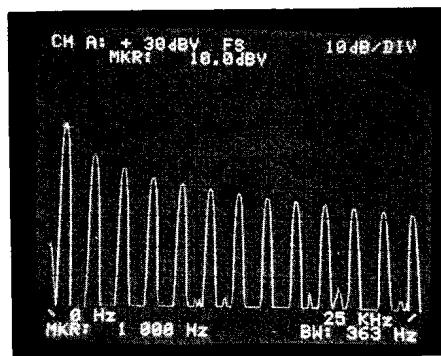

Figure 3-3. Setting the Marker Position.

3-41. Equivalent Noise Bandwidth. The \sqrt{BW} button is used for making measurements of random noise. Normally the noise level measured at any point with the analyzer is a function of the filter bandwidth and the actual noise density. Since different filter bandwidths will give different answers, the comparison of results is difficult. In order to eliminate this problem, it is customary to normalize out the bandwidth factor by dividing the reading by the square root of the "equivalent noise bandwidth". This is the width of an ideal rectangular filter with the same power response as the actual filter used. The \sqrt{BW} function performs this normalization automatically and presents the results directly in dBV/ \sqrt{Hz} or voltage \sqrt{Hz} . To observe this function set the \sqrt{BW} button to ON; when finished, set the button to OFF.

3-42. Relative Amplitude. The SET REF button enters a reference amplitude and frequency into memory of comparison to the present marker reading (see Note). This reference remains in memory until the SET REF button is pressed again establishing a new reference. Press the SET REF button.

NOTE

The relative marker reading is the ratio of the present amplitude reading to the previous amplitude reading. Units for the various marker functions will be displayed accordingly. In the relative mode, an error will result if the SCALE is changed between LINEAR and LOG.

3-43. To read a relative amplitude and frequency, set the REL button to the ON position. The display will now present the relative frequency and amplitude of the present marker position. Move the MARKER POSITION to observe a new relative reading. Set the REL button to OFF.

3-44. Switching the Marker to a Different Trace. When two traces are being displayed, the TRACE button causes the marker to be moved from one trace to another. Note that if the REL button is on, relative comparisons between the two traces can be made. Dual trace operation and examples of marker functions will be given later.

3-45. Setting a Frequency Reference for Band Analysis Modes. Move the marker to the 1 kHz spectral line as in Figure 3-3. Press SET FREQ to load the marker frequency, as a reference, into memory for a new start or center frequency in the band analysis modes.

3-46. The Frequency Span Controls.

3-47. The Mode Switch. The Mode switch can select one of four different types of frequency displays. Two of the types of displays will be referred to as the base band mode because the frequencies displayed begin at 0 Hz and end at some upper frequency. The 0–25 kHz position permits an overall view of the frequency spectrum and provides a quick reference to return to if a spectral line is lost while searching at narrow bandwidths in other modes. The 0 START position provides for high resolution near the 0 Hz frequency point using the span selector to set the upper frequency limit.

3-48. The other two types of displays will be referred to as the band analysis modes because a segment or band of frequencies within the 0–25 kHz range may be observed. Switching to either SET START or SET CENTER, allows for the use of a variable frequency control which tunes the digital local oscillator. Rotating the control changes the starting frequency or the center frequency so that spectral lines may be placed at any horizontal position on the display. START or CENTER frequency may also be selected using the MARKER SET FREQ button. Set the following switch:

MODE.....SET CENTER

3-49. The 1 kHz spectral line should now be in the center of the display. Rotate the ADJUST control to see how the center frequency is changed. For more detailed analysis, the SPAN may be reduced thereby expanding (or zooming in) on the frequencies of interest.

3-50. The SPAN Control. The SPAN switch controls the displayed span. The bandwidth is adjusted automatically and is also dependent upon the position of the DISPLAY MODE switch. The narrowest bandwidths are available in the 0 START mode and single channel mode for any PASSBAND SHAPE selected. When using SET START or SET CENTER, all span settings are available for use except the two narrowest spans (1 Hz and 2.5 Hz). Set the following switch:

SPAN.....250 Hz

3-51. In the example presented by Figure 3-4, reducing the span permitted two sidebands to be resolved which were formerly included in the wider 25 kHz span. The use of the MARKER controls showed that the sidebands were 40 Hz away from the center frequency with a relative amplitude of -20.0 dB.

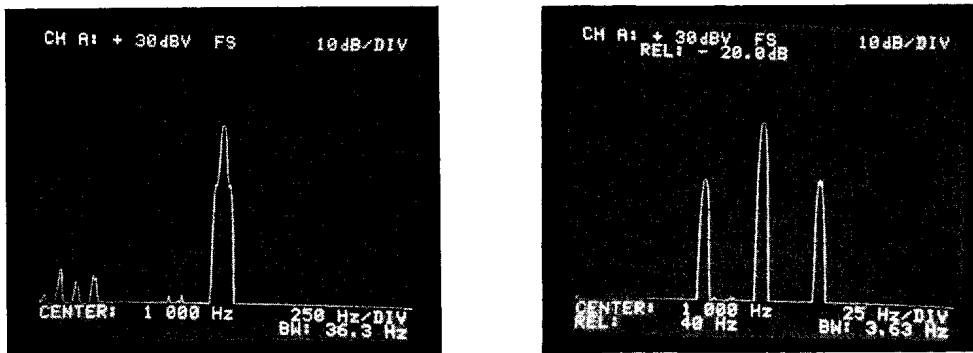

Figure 3-4. Using the SPAN Control to Resolve Sidebands.

3-52. If the function generator has modulating capabilities, pause to experiment with different modulating frequencies and amplitudes using the 3582A and the control information thus far presented to derive spectral data. When finished, reset the following switches (except the LINE switch):

- Set both framed functions.....ON
- Set SCALE 10 dB/DIV.....ON
- Set AVERAGE NUMBER 4.....ON
- Set PASSBANDSHAPE..... FLATTOP
- Set AMPLITUDE A.....ON
- Set all other buttons.....OFF
- AMPLITUDE REF LEVEL.....NORMAL
- FREQ SPANMODE.....0-25 kHz
- TRIGGER LEVEL (framed).....FREE RUN
- INPUT CHANNEL A.....30 dBV
- VERNIER.....CAL
- INPUT CHANNEL B.....30 dBV
- VERNIER.....CAL
- INPUT MODE.....A

3-53. Scales.

3-54. One of three scales may be selected to represent display spectral amplitudes. Each scale may be used in combination with the channel SENSITIVITY switches and the

AMPLITUDE REFERENCE LEVEL switch to offset (log modes) or expand (linear mode) the display relative to full scale. There are three basic scale settings:

- a. 10 dB/DIV. The 10 dB/DIV scale is a logarithmic type of display which has a range of 80 dB.
- b. 2 dB/DIV. The 2 dB/DIV scale is a logarithmic type of display which has a range of 16 dB.
- c. LINEAR. The LINEAR scale has a range from the full scale indicated voltage to zero volts. Therefore, the volts per division decreases as the full scale amplitude is reduced. The SENSITIVITY switch indicates the maximum rms voltage level which does not exceed overload. The voltage level displayed is a calibrated voltage which can be easily divided among the eight graticule divisions. Because of this, some SENSITIVITY switch positions will give a displayed full scale voltage which will require the use of the AMPLITUDE REFERENCE LEVEL switch to give a full scale display.

3-55. Amplitude Reference Level.

3-56. The AMPLITUDE REFERENCE LEVEL switch has nine positions. In the NORM position, the amplitude reference level function is off. If the switch is turned clockwise, the following changes will take place on the display (NORM is position 1):

- a. Log Modes: The display is offset by an additional 10 dB/DIV for each position which can accumulate to a total of 80 dB.
- b. Linear Mode: Since the zero volts line is always at the bottom of the display, the full scale reference level will decrease thereby expanding or amplifying lower signal levels.

3-57. To observe the different SCALES and effects of the AMPLITUDE REFERENCE LEVEL switch, try the following exercise:

- a. Set the function generator for a 1 kHz square wave output. Adjust the amplitude to 3 V rms or less.
- b. Set the CHANNEL A SENSITIVITY for 10 dB.
- c. Readjust the amplitude of the function generator to achieve a full scale display without an overload indication.
- d. Rotate the AMPLITUDE REFERENCE LEVEL switch and observe how the display is shifted up in 10 dB increments.
- e. To expand a portion of the display, use the AMPLITUDE REFERENCE LEVEL switch to place that part of the display at or near the full scale graticule.
- f. Placing the 2 dB/DIV button to the ON position will expand the spectra within – 16 dB from the reference setting to a full scale display (see Figure 3-5).
- g. Return the AMPLITUDE REFERENCE LEVEL switch to NORM.

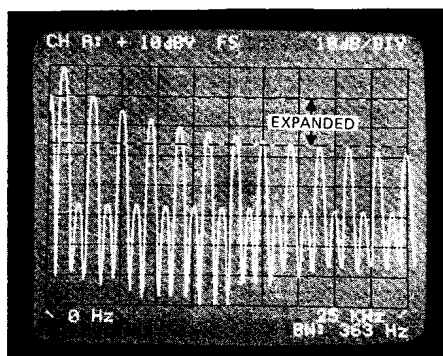

BEFORE OFFSET AND EXPANSION

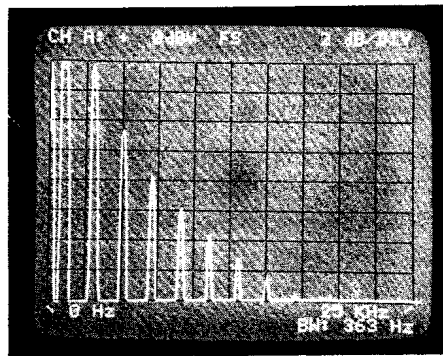

AFTER OFFSET AND EXPANSION

Figure 3-5. Expanding a Portion of the Display.

h. Press the LINEAR scale button and observe that the maximum allowable input signal on the 3 V range does not produce a full scale display. Notice that the calibrated reference level is 4 V (see Figure 3-6).

i. To observe the associated lower amplitude spectra, rotate the AMPLITUDE REFERENCE LEVEL switch. Notice that the volts/div decreases at each new reference level, thus expanding the amplitude of the spectra on the display.

j. Set the following switches:

10 dB/DIV.....ON
 AMPLITUDE REFERENCE LEVEL.....NORM

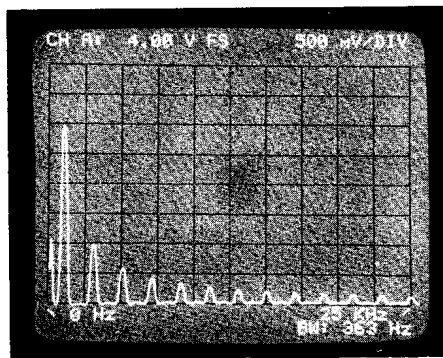

Figure 3-6. Full Scale Reference in the LINEAR Mode.

3-58. The Passband Shape Controls.

3-59. One of three passband shapes may be selected to characterize the signal data. Careful consideration should be given to the choice of PASSBAND SHAPE in order to maximize the spectral information displayed for a particular type of measuring application. The PASSBAND SHAPES are unique and are explained as follows:

a. FLAT TOP. The FLAT TOP passband is similar to those found in wave analyzers such as the -hp- 312D and the -hp- 310A. Its high shape factor and broad response make it

ideal for measuring the amplitude of individual spectra, such as that found in the output from an oscillator. Therefore it is the most accurate passband for measuring amplitude.

b. **HANNING.** The **HANNING** passband is similar to those found in swept frequency spectrum analyzers such as the -hp- 3580A. The **HANNING** passband is derived from a raised cosine shape which helps to give better resolution for isolating one spectral line in a closely spaced group of spectral lines, particularly when the amplitudes of the spectra are within 50 dB of each other. A good example of the use of this passband would be in deriving the spectrum for a notch filter. The **HANNING** passband should be selected when using the **RANDOM NOISE SOURCE** and when measuring discrete spectrum components. It is slightly less accurate (approximately -1 dB) than the **FLAT TOP** passband.

c. **UNIFORM.** The **UNIFORM** passband has a very narrow 3 dB bandwidth and should be used for measuring transient signals. The 3582A's **PERIODIC NOISE SOURCE** is optimized for this passband which aids in analyzing transfer characteristics of networks. The display aberrations are greatest when using this passband so caution should be used when measuring the amplitudes of individual spectra.

3-60. To observe the effects of using the different passband shapes on a spectral display, try the following exercise:

a. The 3582A should have the switches already set up from the last exercise. But if you are beginning here, set the switches to the basic turn-on mode as indicated in the Turn-On Procedure.

b. Set **CHANNEL A SENSITIVITY** to $+10$ dB.

c. Adjust the function generator for a 10 kHz sine wave and a full scale display on the 3582A (approximately 3 V). The spectrum should appear as in Figure 3-7.

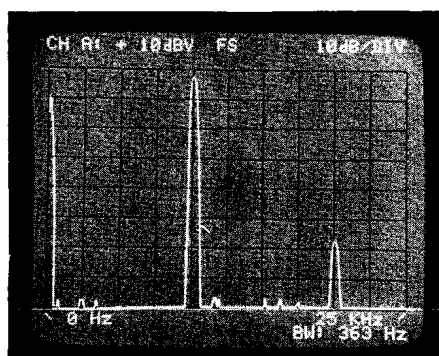

Figure 3-7. A Sine Wave Spectrum using the FLAT TOP Passband.

d. Change the frequency of the oscillator very slowly and notice that the spectral display retains its shape as it shifts across the screen.

e. Now set the **HANNING** passband button to **ON**. The spectrum should appear as in Figure 3-8.

f. Slowly change the frequency of the oscillator and observe how the spectral shape slightly changes proportions. Also notice that the bandwidth has decreased to less than one

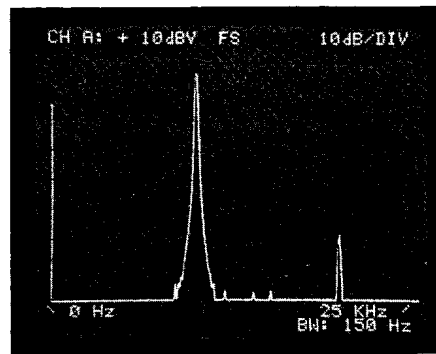

Figure 3-8. Sine Wave Spectrum using the HANNING Passband.

half its previous value. The smaller bandwidth allows for greater selectivity, while the slightly changing shape is due to the discrete sampling and display technique.

- g. Set the UNIFORM passband button to ON. The spectrum may appear as in Figure 3-9.

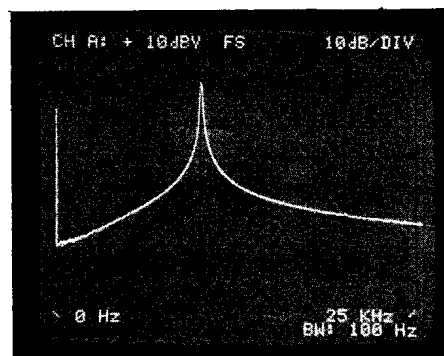

Figure 3-9. Sine Wave Spectrum Using the UNIFORM Passband.

h. Slowly change the frequency of the oscillator. The radically changing shape is due to a bandwidth which is now less than a third that of the FLAT TOP passband. This reveals that the UNIFORM passband should generally not be used except for measuring transfer functions using the PERIODIC NOISE OUTPUT as a source.

3-61. The NOISE SOURCE.

3-62. The NOISE SOURCE is a broadband periodic pseudo random signal. When "PERIODIC" is selected, the period is automatically adjusted so that one period covers one SPAN setting and, therefore, the periodicity does not effect the spectrum analysis. When "RANDOM" is selected, the periodicity of the noise source signal is extended to as much as 14 minutes. In this mode, the 3582A interprets the pseudo random signal as a band limited white noise source. The NOISE SOURCE output may be adjusted through the use of the LEVEL control located adjacent to it. The low impedance output (< 1 ohm) may be used as a source signal for analyzing two port networks.

3-63. To see the spectral output of the NOISE SOURCE, connect the NOISE SOURCE output to the channel A input connector via a shielded cable with suitable adapters. Set the

CHANNEL A COUPLING and the CHANNEL B COUPLING to AC. Adjust the CHANNEL A SENSITIVITY control for an on-scale display. The displayed spectrum is nearly a uniform amplitude across the frequency axis (see Figure 3-10[a]). It is important to note that there is energy at each spectral point, but none in between. If a phase spectrum is observed, the phase will be consistent for corresponding frequencies for each time record taken. Do not use SET START or SET CENTER for making measurements using the Periodic Noise Source within one SPAN width of 0 Hz. Instead, use the 0-START mode as this does not use the Digital Local Oscillator and will avoid L.O. translated noise aliasing around 0 Hz.

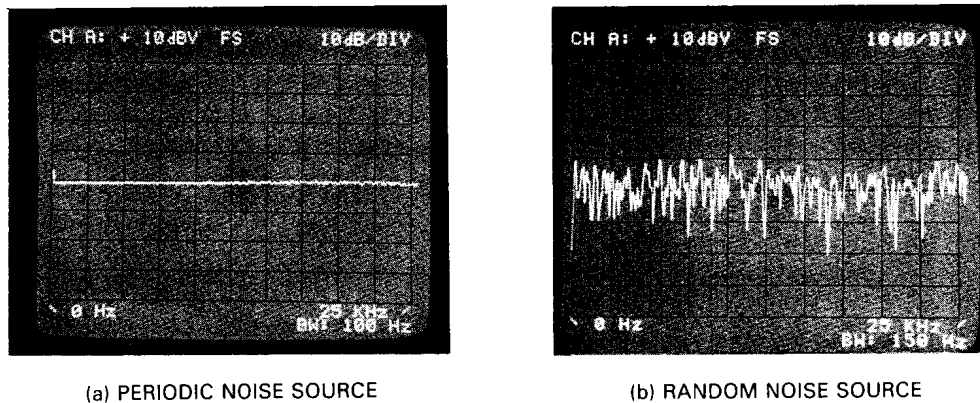

Figure 3-10. Noise Source Spectrums.

3-64. To see the spectral output of the RANDOM noise source, set the PASSBAND SHAPE to HANNING and turn the concentric control of the level switch to RANDOM. The spectrum will appear similar to that in Figure 3-10(b). A smoother display may be obtained by RMS averaging.

3-65. IMPULSE OUTPUT.

3-66. The IMPULSE output signal is a pulse which has an amplitude of +5 V. The period of the pulse is determined by the SPAN control settings (see Table 3-1). The repetition period is the same as the length of the time record. The UNIFORM window should be used

Table 3-1. Impulse Output Pulse Period.

SPAN	0-25 kHz 0-Start	SET START SET CENTER
25 kHz	1.211 μ sec	2.441 μ sec
10 kHz	2.441 μ sec	6.104 μ sec
5 kHz	6.104 μ sec	12.207 μ sec
2.5 kHz	12.207 μ sec	24.414 μ sec
1 kHz	30.518 μ sec	61.035 μ sec
500 Hz	61.035 μ sec	.12207 msec
250 Hz	.12207 msec	.24414 msec
100 Hz	.24414 msec	.6105 msec
50 Hz	.6105 msec	1.221 msec
25 Hz	1.221 msec	2.441 msec
10 Hz	2.441 msec	6.101 msec
5 Hz	6.101 msec	— — —
1 Hz	30.667 msec	— — —

when making measurements using the IMPULSE output as a source. The resulting spectrum has a constant amplitude and phase-frequency relationship.

3-67. To observe the IMPULSE spectrum, remove the NOISE SOURCE output from CHANNEL A and connect the IMPULSE output to CHANNEL A. Adjust the SENSITIVITY for an on-scale display. The spectrum will appear similar to that in Figure 3-10(a).

3-68. Dual Channel Measurements.

3-69. The dual channel capability makes the 3582A a very versatile instrument. With two channels, many measuring applications are possible including the measurement of the transfer characteristics of two port networks. One type of two port network is a single pole low pass filter, consisting of a series resistor and a parallel capacitor (see Figure 3-11).

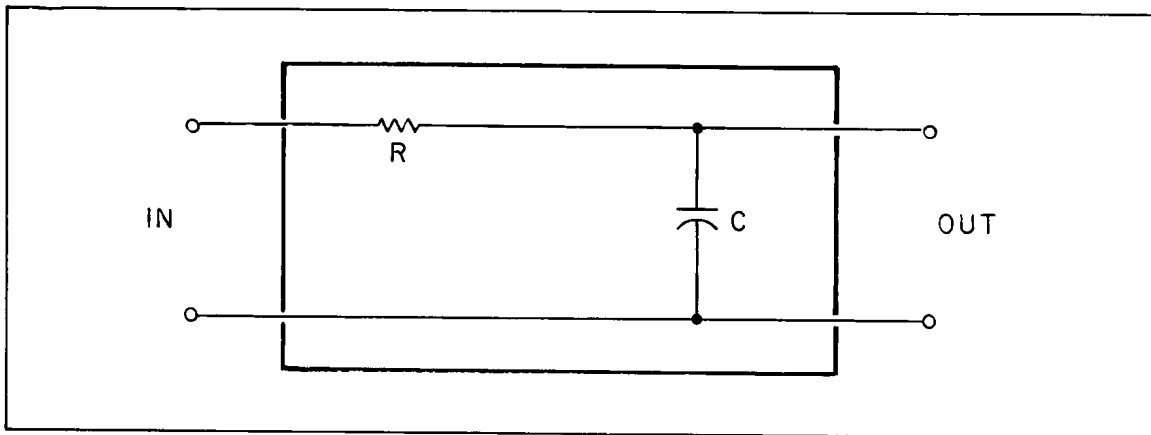

Figure 3-11. A Two Port Network.

3-70. A two port network such as this will be used to illustrate the amplitude and phase transfer measuring functions of the 3582A. To connect the filter:

- a. Remove the IMPULSE source from channel A.
- b. Connect a $10\text{ k}\Omega$ resistor and a 3000 pF capacitor between the inputs of channels A and B as shown in Figure 3-12.

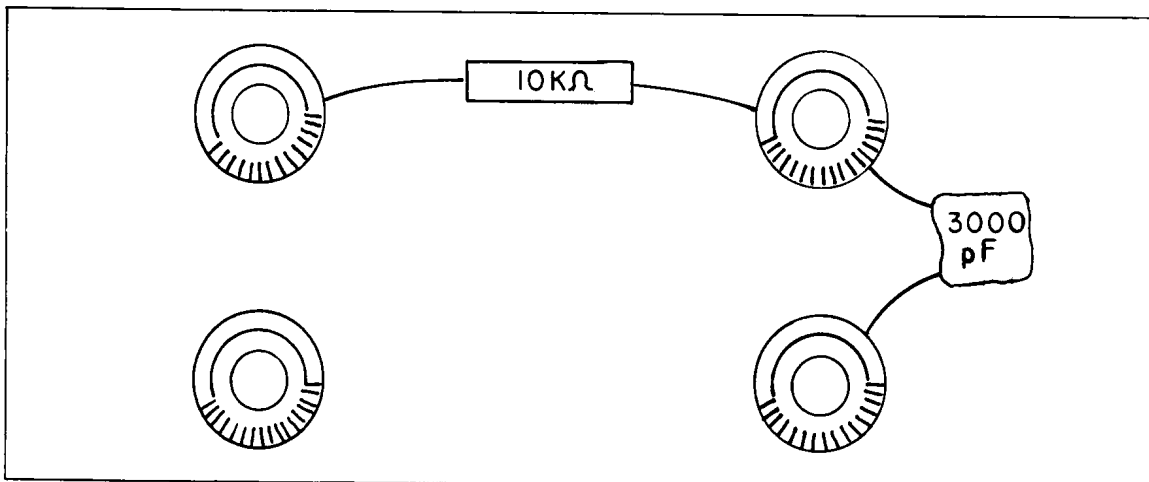

Figure 3-12. Connecting a Single Pole Low Pass Filter.

- 3-71. To observe both input A and input B, try the following exercise:
- Reconnect the NOISE SOURCE OUTPUT to channel A INPUT.
 - Verify that CHANNEL A and CHANNEL B COUPLING switches are set to AC and that the INPUT MODE switch is set to BOTH.
 - Set CHANNEL A and CHANNEL B SENSITIVITY switches for + 10 dB.
 - Verify that the UNIFORM PASSBAND button is set to on and "PERIODIC" is selected.
 - Press channel A and channel B AMPLITUDE buttons to ON.
 - Adjust the AMPLITUDE REFERENCE LEVEL for a centered display.
 - The input and output of the low pass filter is described by the two traces and should appear similar to Figure 3-13.

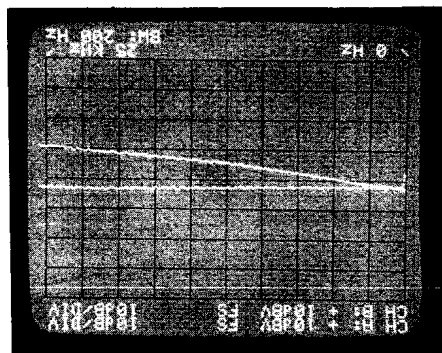

Figure 3-13. Input and Output Spectrum of a Low Pass Filter.

- Comparisons between the two traces can be made with the use of the MARKER functions.
- Set the MARKER ON button to ON.
- Set the MARKER to a desired reference point on the top trace using the POSITION control.
- Press the MARKER REL button to ON.
- Press the MARKER SET REF to load a relative reference into memory.
- Pressing the MARKER TRACE button will now give relative amplitude information between the two traces.

3-72. Amplitude Transfer (XFR) Function. As already illustrated, comparative measurements can be used to determine the differences between channel A and channel B. If enough of these measurements are made, a graph may be constructed which would indicate the amplitude transfer characteristics of the network under analysis. The AMPLITUDE

XFR FCTN is a graphical display which is the result of dividing the spectrum of channel B by the spectrum of channel A. It is a continuous function which describes the gain or attenuation, as referenced to frequency, of a two port network. To observe the AMPLITUDE XFR FCTN, try the following exercise:

- a. Set MARKER REL OFF.
- b. Set AMPLITUDE A and AMPLITUDE B OFF.
- c. Set AMPLITUDE XFR FCTN to ON.
- d. Set AMPLITUDE REFERENCE LEVEL for a centered display.
- e. The MARKER functions may be used to provide amplitude and frequency information at a point of interest.
- f. For example, turn the MARKER POSITION control so that the marker is in the vicinity of 5300 Hz. This is the approximate -3 dB point of the transfer function (see Figure 3-14).

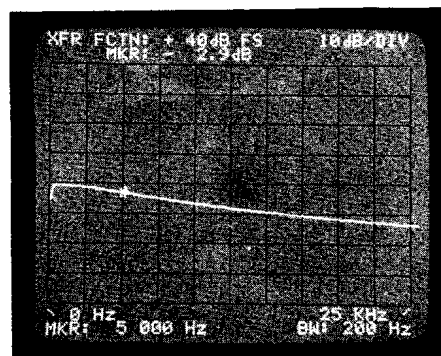

Figure 3-14. Transfer Function for a Two Port Network.

3-73. Phase Measurements. Complete analysis of a waveform requires that phase as well as amplitude be known. Phase data must be relative to a fixed point in time. It is best to use a trigger signal when single channel measurements are made to establish relative phase data. A trigger signal is not required for some dual channel displays since phase data is simply relative between the two channels.

3-74. The phase display uses the central horizontal graticule to indicate zero degrees each division vertically represents 50 degrees. The phase display is dependent on the triggering of the time record, but the phase reference is at the middle of the screen so there is no simple relationship between the phase spectrum and the trigger point. However, the phase reference is at the beginning of the time record if the UNIFORM window is used.

3-75. Since the instrument is already set up to display a transfer function, the phase transfer function of the low pass filter may be observed by setting the following switches:

AMPLITUDE XFR FCTN.....OFF
 PHASE XFR FCTN.....ON
 AMPLITUDE REFERENCE LEVEL.....NORM

3-76. The MARKER controls may be used to indicate the phase reading at a particular frequency of interest. Notice that at low frequencies the relative phase is approximately 0 degrees and at 5300 Hz the phase is approximately 45 degrees (see Figure 3-15).

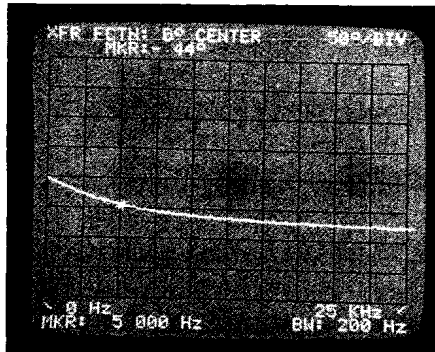

Figure 3-15. Phase Transfer Function of a Low Pass Filter.

3-77. Single channel phase measurements will be illustrated with the use of a function generator. To observe a single channel measurement, try the following exercise:

- a. Set the following switches:

```

PHASEXFRFCTN.....OFF
AMPLITUDE A.....ON
PASSBAND SHAPE FLAT TOP.....ON
INPUT CHANNEL A SENSITIVITY.....30 V
INPUT MODE.....A
  
```

b. Set the function generator for a 1 kHz triangle wave output. Disconnect the NOISE SOURCE OUTPUT and connect the output of the function generator to the input of the 3582A via suitable cables. Adjust the output of the function generator and/or the INPUT SENSITIVITY of the 3582A to achieve a full scale display without overloading the 3582A. Now set the 3582A switches as follows:

```

AMPLITUDE A.....OFF
PHASE A.....ON
  
```

3-78. Notice that the phase readings change randomly. This is caused by the TRIGGER LEVEL control being in the FREE RUN position. To stabilize the readings and establish a phase reference, turn the TRIGGER LEVEL control until the desired display is shown. An example display is shown in Figure 3-16.

3-79. There are two important criteria about the phase display that should be noted.

a. Threshold: Except for the phase transfer function, the phase is displayed if the signal is above a certain threshold. If it is below the threshold, 0 degree is displayed and the marker will indicate that it is undefined. This eliminates phase readings resulting from low signal levels (i.e., noise).

b. Slope: There is a phase slope which corresponds to a phase shift across the passband

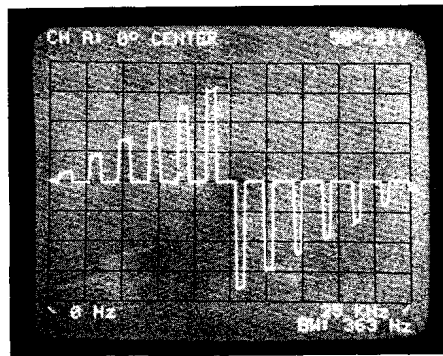

Figure 3-16. Phase Spectrum of a Triangle Wave.

filters. The correct reading is obtained at the center of the sloping segment which is the peak of the amplitude response at that frequency.

3-80. If desired, the MARKER functions and/or the amplitude spectrum may be shown for reference purposes by pressing the appropriate buttons.

3-81. External Trigger Input. Another method of establishing a phase reference is through the use of the rear panel TRIGGER INPUT. This is TTL compatible input which is enabled when the TRIGGER switch is set to EXT. Another condition is that the front panel TRIGGER LEVEL control must not be in the FREE RUN position. If your function generator has a TTL pulse output (0 V to 5 V), connect this output to the rear panel TRIGGER INPUT and set the adjacent TRIGGER switch to EXT. Notice that the TRIGGER LEVEL control is now non-functional except in the FREE RUN position. When finished, disconnect the external TRIGGER INPUT and return the TRIGGER switch to INT. It is good to mention at this point that some apparent trigger problems may be due to the inadvertent setting of the rear panel TRIGGER switch. Always verify that this switch is in the proper position for the desired mode of operation of the instrument.

3-82. The Averaging Functions. The AVERAGE controls are used to average the spectra displayed on the CRT. Operationally, it replaces the video filtering or display smoothing usually found on spectrum analyzers. The TIME average does offer a unique capability of actually enhancing the signal-to-noise ratio.

3-83. *RMS Average.* The RMS average mode combines a new spectrum with a partial result on a point-by-point basis using an RMS calculation. At any point (m) in the cycle, the amplitude and phase at some frequency (f) are given as:

$$\text{Amplitude: } \sqrt{\frac{1}{m} \sum_{i=1}^m A_i^2}$$

$$\text{Phase: } \frac{1}{m} \sum_{i=1}^m \theta_i$$

This averaging results in smoothing of the noise variations but does not reduce the level of the noise. RMS averaging must be used when making coherence measurements.

3-84. *TIME Average.* The TIME Average mode involves time domain averaging. When a synchronizing trigger is available, successive time records are averaged point-by-point. Time

variations that are coherent with the trigger will average to some value while those that are not coherent will average to zero. This reduces the noise prior to the transformation to the frequency domain. Time averaging is unique in that it does result in an enhancement of the signal-to-noise ratio. It is also by far the fastest averaging mode for wide frequency spans and should be used any time a synchronizing trigger is available.

3-85. *PEAK Mode.* The PEAK mode is not truly an averaging mode, but rather is the result of keeping the maximum input at each frequency point. The phase point retained is the phase of the retained point at each frequency. PEAK averaging is useful for measurements such as monitoring signal drift, etc.

3-86. *Selecting the Number of Averages.* The NUMBER of averages is selectable between 4 and 256 in a binary sequence. The SHIFT key selects whether the lower case black numbers or the upper case blue numbers are active.

3-87. *EXP Mode.* The EXP mode is a continuous averaging process where the new spectrum is weighted $\frac{1}{4}$ and the previous average is weighted $\frac{3}{4}$. This causes the most recent data to be most important while the older data dies out in importance at a decaying exponential rate. The exponential accumulation mode works with the RMS average but in the PEAK mode provides unlimited peak hold. It is most useful when the process under consideration exhibits relatively slow term variations and yet some averaging is still desired. The time constant of the exponential weighting is such that it averages out short term variations, yet follows longer term variations.

3-88. *Running an Averaging Sequence.* In all of the averaging modes except exponential, the instrument stops taking new data when the selected number of averages are completed. When this occurs, the 3582A may appear to be “hung up” when actually it is waiting for further instructions. This is the reason the AVERAGE OFF button is framed. Any time the 3582A appears to be stopped, this button and other framed functions should be checked. When the instrument has taken the selected number of averages, the RESTART button is used to start the next averaging sequence. When the averaging mode is changed, a restart is automatically executed. When the number of averages is changed from one number to a larger number, a restart is also not required; the instrument continues from where it stopped to the new number of averages.

3-89. The following exercise will illustrate the use of the RMS and TIME averaging controls. It requires that the function generator have external modulating capability.

a. Set the controls of the function generator so that a 5 kHz sine wave can be AM modulated by an external source.

b. Connect the output of the function generator to the CHANNEL A input of the 3582A.

c. Using the control information thus far presented, adjust the function generator output and the 3582A controls for a full scale amplitude display using the trigger mode and FLAT TOP PASSBAND.

d. Select a harmonic of low amplitude and place it in the center of the screen using either SET START or SET CENTER frequency mode (see Figure 3-17).

e. Connect the NOISE SOURCE OUTPUT of the 3582A to the external modulation input of the function generator.

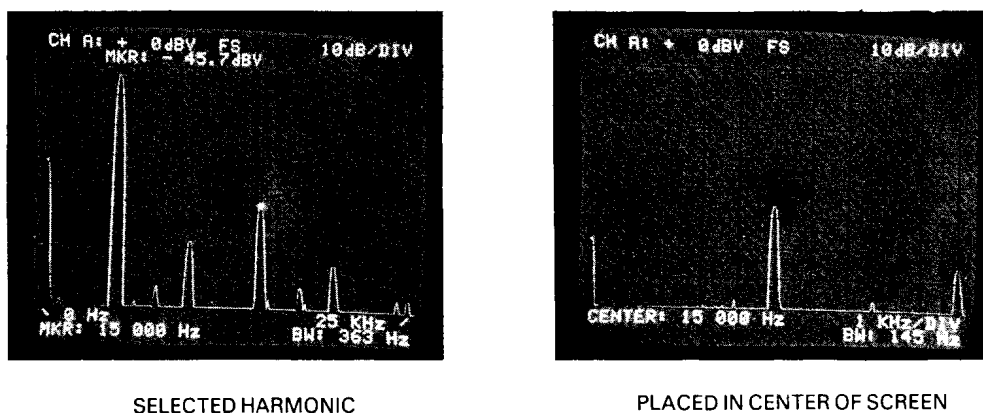

Figure 3-17. Selecting the Correct Harmonic.

f. Adjust the modulation and NOISE SOURCE LEVEL such that the harmonic spectral line is indistinguishable from the noise spectrum (see Figure 3-18). The noise level peaks should be a little lower than the harmonic.

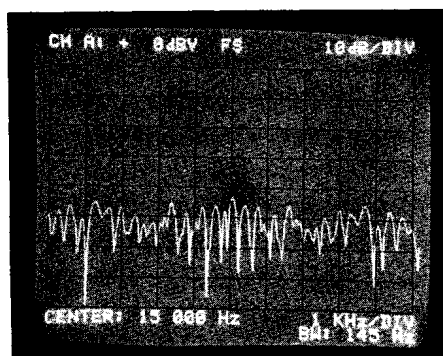

Figure 3-18. Modulating a Spectral Line with Noise.

g. Set the AVERAGE controls for a 256 RMS average function. When the average is completed, the spectrum may appear as in Figure 3-19. Notice that the value of the noise has averaged out to an RMS amplitude which is less than its peak value and that the spectra of the harmonic retains the same RMS amplitude throughout the averaging process.

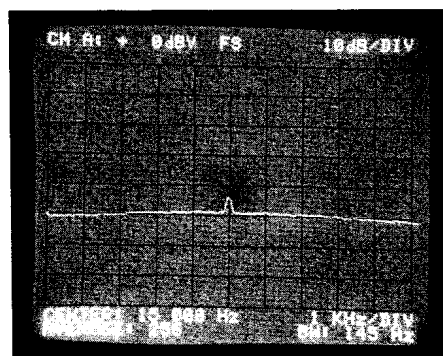

Figure 3-19. RMS Averaged Signals.

h. Set the TIME average button to ON and trigger properly. When the average is completed, notice that a signal-to-noise ratio enhancement has taken place (see Figure 3-20).

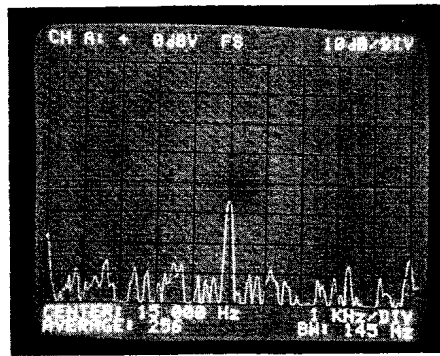

Figure 3-20. TIME Averaged Signals.

This is due to the principle that random noise averages in time to a lower value than a periodic waveform averages in time. Thus, if successive time records (relative to a fixed point in time) were superimposed upon one another, the signal waveform components would coincide while the noise waveform components would not.

i. Disconnect the NOISE SOURCE from the function generator and set the AVERAGE OFF button to OFF.

3-90. The following exercise illustrates the PEAK average mode and requires the function generator to have FM modulating capabilities.

- a. Adjust the function generator for a 10 kHz sine wave modulated by a 1 Hz sine wave.
- b. Adjust the controls of the 3582A for a center frequency of 10 kHz and a SPAN of 2.5 kHz.
- c. The sine wave spectral line should be oscillating in frequency as indicated in Figure 3-21.

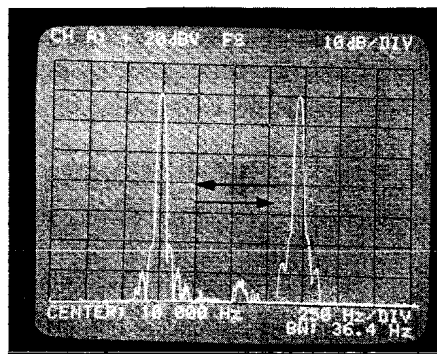

Figure 3-21. Oscillating Frequency Spectrum.

d. Press the PEAK average button to ON. At the end of 256 averages, the FM passband should appear as in Figure 3-22. This shape describes the maximum amplitude of the spectral line as it sweeps between maximum and minimum frequency.

3-91. Time Functions. The TIME display buttons supersede the other display controls. Only one time display can be selected at a time and all other displays are suspended. The TIME display is active only as long as the pushbutton is held in. It is important to note that the

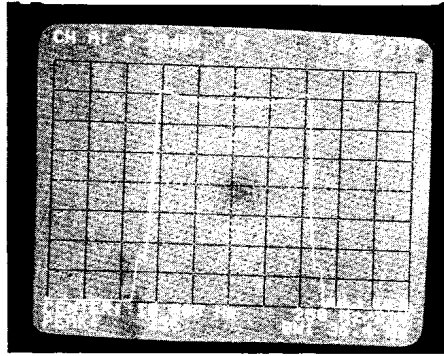
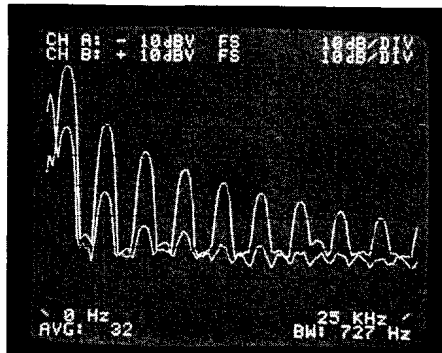

Figure 3-22. Spectrum of an FM Passband.

TIME display is used mainly for setting input sensitivities and for determining when a time record is complete; it does not replace an oscilloscope. The information displayed consists of alternate samples of the input time record in the baseband modes. In the band analysis modes, the time record may not be representative of the input signal since it is mixed with the Digital Local Oscillator before being stored.

3-92. Coherence. The coherence display is activated when the instrument is in the two channel RMS average mode and the COHER button is set to the ON position. The most common use of this display is as a check on the validity of a transfer function measurement. The coherence function is also a measure of the proportion of power in an output signal caused by an input signal. A coherence value of 1.0 would indicate that the cause/effect relationship is ideal and the transfer function ratio at that frequency is valid. Figure 3-23 shows two signals derived from the same source and their coherence relationship.



AVERAGED INPUT SIGNALS

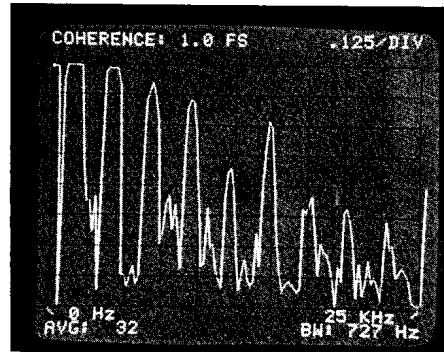

COHERENCE RELATIONSHIP

Figure 3-23. The Coherence Relationship Between Two Signals.

Notice that the coherence function shows unreliable data in the higher frequencies. This is largely due to the signal-to-noise ratio of the smaller signal which becomes less as the frequency increases. Also note that when the signal-to-noise ratio of either signal is low, the coherence is also low.

3-93. To observe the TIME and COHER functions, try the following exercise.

- a. Connect the function generator output to the 3582A's channels A and B input via suitable cables and connectors.

- b. Set the function generator for a 2 kHz triangle wave output.
- c. Set the 3582A for normal dual channel amplitude measurement (in case of difficulty, see Turn-On Procedure).
- d. Set SCALE to 10 dB/DIV and the INPUT MODE to BOTH.
- e. With CHANNEL A and CHANNEL B INPUT SENSITIVITY controls set to +30 dBV, adjust the function generator for a half scale (approximately – 10 dBV) display.
- f. To observe the channel A TIME function, depress the TIME A button and hold it in while varying the channel A INPUT SENSITIVITY. This will show the effect of the INPUT SENSITIVITY switch on the TIME amplitude. Set the AMPLITUDE A and B buttons to OFF.
- g. To observe the coherence function, set the COHER button to ON, RMS AVERAGE button to ON, and AVERAGE NUMBER 64 to ON. The RMS averaging sequence should begin immediately with the coherence display becoming valid at the end of the sequence.
- h. Experiment with the coherence function by varying the INPUT SENSITIVITY controls, pressing RESTART, and noting the result on the display when the averaging sequence is completed.
- i. When finished, press the AVERAGE OFF button and set the COHER button to OFF.

3-94. Storing Traces.

3-95. The graphics portion of a single trace being displayed may be stored in TRACE 1 and/or TRACE 2, but either or both may be recalled using the dual channel mode of operation. The MARKER functions do not work on the recalled traces and the stored traces are not affected by any front panel operations except POWER OFF.

3-96. The following exercise illustrates the use of the trace STORE and RECALL functions.

- a. Connect the NOISE SOURCE OUTPUT to the channel A INPUT.
- b. Set the controls of the 3582A for a dual channel amplitude measurement. (In case of difficulty, see the Turn-On Procedure.)
- c. Set the SCALE 10 dB/DIV to ON, the INPUT MODE switch to BOTH, and AMPLITUDE A to ON.
- d. Set the INPUT SENSITIVITY switches as follows:

CHANNEL A..... + 20 dBV
CHANNEL B..... CAL

- e. With channel A only being displayed, press the TRACE 1 STORE button.
- f. Change the AMPLITUDE buttons to display channel B only and press the TRACE 2 STORE button.

g. Keeping in mind that only two traces may be displayed at one time, experiment with the TRACE RECALL buttons, INPUT MODE switch, and the DISPLAY AMPLITUDE buttons to get different combinations of recalled traces and amplitude functions.

3-97. Conclusion.

3-98. Storing Traces marks the end of the Familiarization Exercise. It must be reiterated that only the most fundamental concepts were covered and that expertise acquired through continued use of the instrument will lead to discoveries of many applications for measuring spectra using the variety of unique capabilities of the 3582A.

NOTE

See Application Notes in Appendix D for additional information.

3-99. OPERATING ON SIGNAL DATA.

3-100. Introduction.

3-101. The following information is presented in order to maximize the user's efficiency in the operation of the 3582A. The two main functions involving the use of the instrument controls are:

- a. Acquiring a time record.
- b. Operating on stored time data.

3-102. Acquiring a Time Record.

3-103. Because the time record is stored in digital form, the 3582A is a versatile instrument for doing transient analysis. The irregular nature of transient signals, however, dictate that the time record of the captured event must remain unaltered until all applicable analysis is completed. The 3582A has many functions, therefore, great care must be exercised to avoid destroying a time record through the inadvertent setting of a control. To acquire a time record, the following conditions should prevail:

- a. INPUT, TRIGGER, and FREQUENCY controls should be set prior to the initiation of a trigger.
- b. If more than one time record is needed and the AVERAGE functions are used, the PASSBAND SHAPE must be established prior to the initiation of the trigger signals.

Once a time record is established, several operations may be carried out on the data.

3-104. Operating on Stored Time Data.

3-105. Data may be displayed without destroying the time record under the following conditions:

- a. The display of transformed time data may be made in any of the formats indicated by the switches in the DISPLAY group. Note, however, that some DISPLAY functions may require certain setups in the INPUT and TRIGGER switch groups.

- b. Once a trace is displayed, the MARKER functions may be used to obtain information at a particular point of interest.
- c. Traces may also be stored, recalled, or plotted by an external plotting instrument.
- d. The PASSBAND SHAPE may be changed but only if the AVERAGE functions are not used.

NOTE

Pressing the RESET button will clear the time record, but it will not clear traces which are stored using the TRACE 1 and/or TRACE 2 storage functions.

3-106. Using the Recorder Output.

3-107. An X-Y analog recorder (such as the -hp- Model 7004B) may be used to plot the graphics portion of the display. Three controls on the 3582A front panel allow the processor to operate the X-Y analog outputs and the PEN LIFT control output located on the rear panel.

3-108. To initiate a plot, the following steps should be taken:

- a. All 3582A and recorder interface lines should be connected and both instruments turned on.
- b. Next press the LL↓← (RESET) button in order to set the lower left-hand corner minimum scale pen position using the recorder offsets.
- c. The UR →↑ button on the 3582A may be pressed in order to set the upper right-hand corner full scale pen position using the recorder gain.
- d. When the desired spectrum is present on the display and you are ready to plot, press the PLOT button. The 3582A will automatically control the pen lift line throughout the entire plot and return the recorder pen to its initial position when the plot is finished or terminated. If desired, choose another trace and plot again (see Figure 3-24).
- e. To terminate a plot, press the LL↓← (RESET) button to cause the recorder pen to return to its initial position.

NOTE

No other operations on the 3582A may be initiated during a plotting sequence except RESET or HP-IB inputs.

3-109. USING PROBES.

3-110. The -hp- Model 10001A Voltage Divider Probe is recommended for use with the 3582A. The probe has a tip impedance of 10 megohms shunted by 10 pF and a 10:1 division ratio. The probe is especially valuable for use in analyzing high impedance circuits. Note, however, that most high impedance probes such as the -hp- 10001A have capacitive compen-

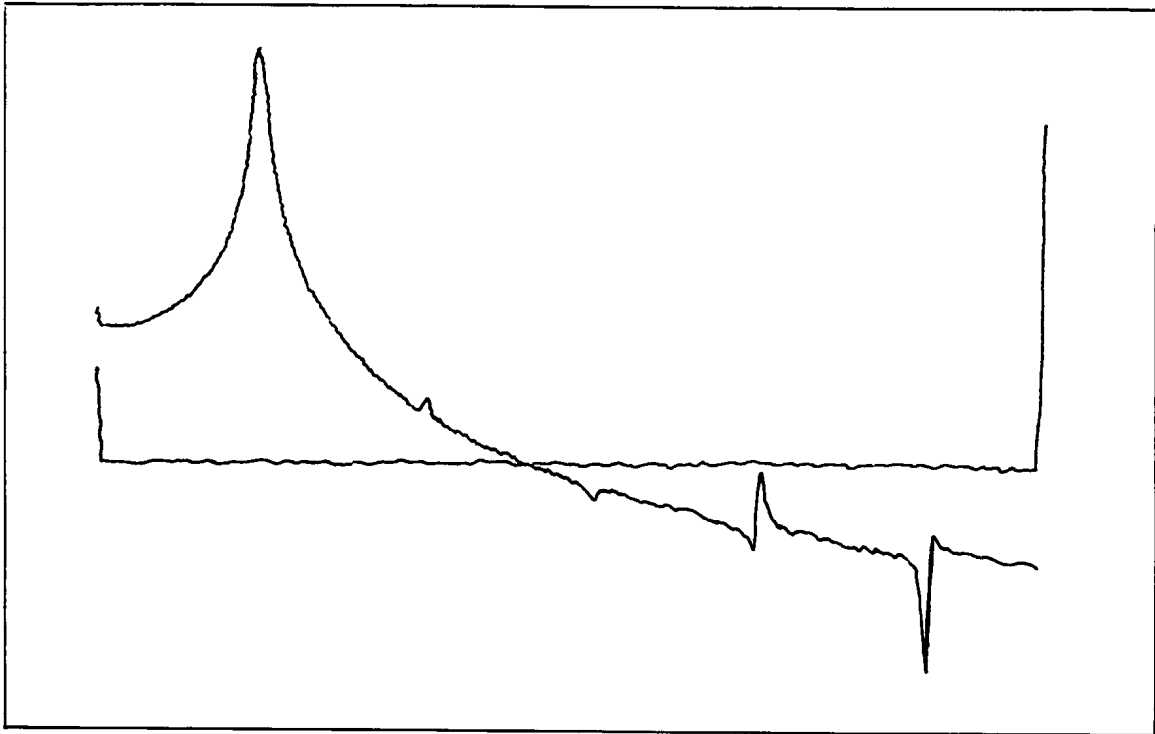

Figure 3-24. A Two Trace Plot.

sating adjustments which effect their frequency response. Before using the -hp- 10001A probe in a measuring application, the probe should be compensated to match the input impedance of the 3582A. Once the probe is properly adjusted, it should not require further attention. It is a good practice, however, to perform periodic verification tests to assure that optimum adjustment is maintained.

3-111. Probes Are Delicate.

3-112. If you have ever tried to use a probe that does not work because it has been abused, you will appreciate the excerpt from -hp- *Bench Briefs* given in Figure 3-25.

3-113. Probe Compensation Procedure.

3-114. The Probe Compensation Procedure uses the Amplitude Transfer Function measuring mode and the PERIODIC NOISE SOURCE OUTPUT of the 3582A.

- a. Turn on the 3582A and/or set the switches as indicated in the Turn-On Procedure.
- b. Set the CHANNEL A SENSITIVITY for 3 V.
- c. Set the INPUT MODE switch to BOTH.
- d. Set the CHANNEL B SENSITIVITY for .3 V.
- e. Connect the NOISE SOURCE OUTPUT to channel A INPUT via suitable cable and connectors.
- f. Connect the cable from the probe to channel B using a BNC adapter (-hp- Part No. 1251-2277).

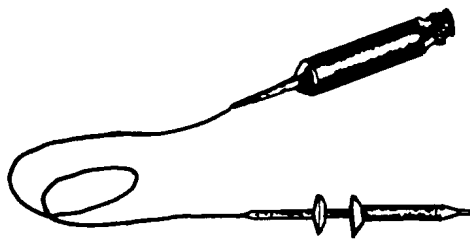

Although oscilloscope probes are as common as pocket screwdrivers, they need to be handled with much more care than the normal screwdriver. Probes are often dropped on the floor, stepped on, rolled over with carts or even used as tow ropes to pull systems around on carts.

Probes are designed to be as rugged as possible, but many times they are abused. It turns out that a high-frequency passive probe is a fairly sophisticated piece of electronic equipment, even if it doesn't sound or look exciting. Electrically, there is a complex termination and compensation network at the base of the probe. The probe tip has the divider resistor (usually about 9 megohms) and another compensating capacitor. One of the toughest things to design and build well is the probe cable. To keep the input capacitance at the probe tip as low as possible, the cable must be very low capacitance. To accomplish this, a very small center conductor must be used. The smaller the center conductor, the lower the capacitance, but also, the easier it is to break the center conductor. The typical diameter of a probe cable center conductor is 4 mils (about the size of a hair!). The point is that a probe should be handled with care, just as any precision measuring tool should be.

Figure 3-25. About Scope Probes.

- g. Attach the probe tip to the signal input on channel A and the ground lead to channel A ground.
- h. Place the DISPLAY AMPLITUDE XFR FCTN to the ON position. Adjust the AMPLITUDE REFERENCE LEVEL for a centered display.
- i. Adjust the probe so the response is flat over the entire frequency range (see Figure 3-26).

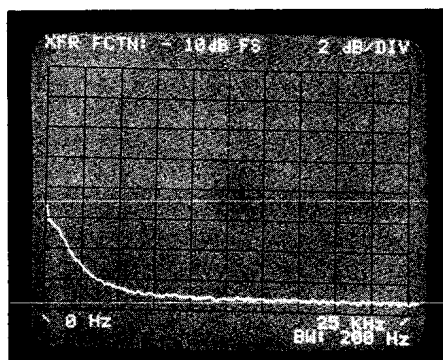

UNCOMPENSATED

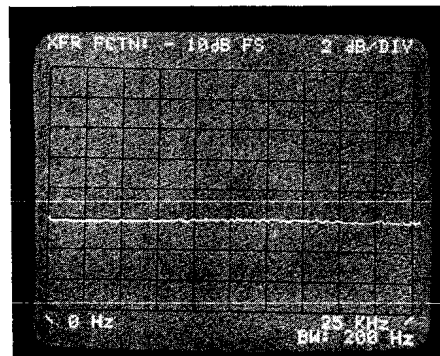

PROPERLY COMPENSATED

Figure 3-26. Probe Compensation.

3-115. FRONT PANEL SCREWDRIVER ADJUSTMENTS.

3-116. Front panel screwdriver adjustments are provided for periodic fine tuning of the instrument. Under most normal operating conditions, there is no need to change the setting

of these adjustments, however, it is a good practice to verify that the instrument is tuned for optimum accuracy before a critical measurement is made.

3-117. ASTIG (Astigmatism) Adjustment.

3-118. The ASTIG adjustment is an analog control which works in combination with the FOCUS control to provide well defined traces and characters on the display. The adjustment of this control may be made anytime the instrument is turned on and there is a display on the CRT. It is often necessary to alternate adjusting the ASTIG control and the FOCUS control to provide a sharp, clear display.

3-119. BAL (Balance) Adjustments.

3-120. The BAL adjustment effects the dc offset of the Input Amplifiers and balances offsets even though ac COUPLING is selected. The BAL adjustment is usually made on the most sensitive input range of the instrument, however, when making a critical measurement, the adjustment should be made on the particular range in use.

3-121. The following procedure is given for adjusting the BAL control on the most sensitive input range, but the same principal procedure applies for adjusting the BAL control on any of the INPUT SENSITIVITY ranges in channel A or channel B.

- a. Set the switches on the 3582A as indicated in the Turn-On Procedure.
- b. Set the DISPLAY AMPLITUDE to A.
- c. Set the SCALE to LINEAR.
- d. Connect a short across the input terminals of channel A.
- e. Set the channel A COUPLING to DC(---).
- f. Set the CHANNEL A SENSITIVITY to 3 mV.
- g. Adjust the BAL control for a minimum amplitude at the 0 Hz frequency point (see Figure 3-27).
- h. Rotate the AMPLITUDE REFERENCE LEVEL control fully clockwise and repeat Step g. This completes the BAL adjustment.
- i. A quicker but less accurate method is to press the TIME function button for the appropriate channel and adjust the time trace for zero volts by centering it on the middle horizontal graticule.

3-122. IN CASE OF TROUBLE.

3-123. Introduction.

3-124. The 3582A, because of its high degree of flexibility, has many operating modes requiring some fundamental knowledge of the operating controls. Under some circumstances, the instrument may appear to be operating incorrectly, when all that is really

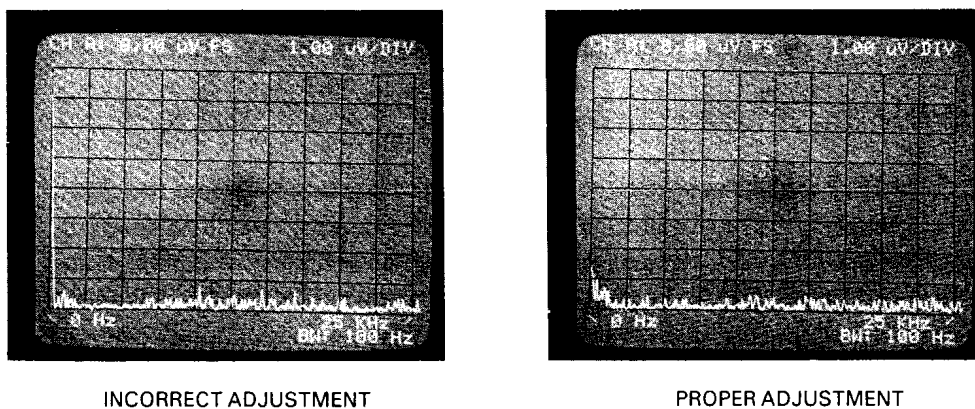

Figure 3-27. Adjusting the BAL Control.

needed is correct operator interpretation and input. The following information will aid the operator in interpreting situations which may arise during measurement sequences. It is intended only as a supplement to the information presented in the Familiarization Exercise. The Familiarization Exercise should be read (and performed) before any (other) operation of the instrument is attempted.

3-125. "Hung Up" (Instrument does not appear to respond).

3-126. If the instrument does not appear to respond to front panel controls, check the following list of possibilities:

- a. Instrument under REMOTE Local Lockout.
- b. No trigger signal available:
 1. Trigger REPETITIVE is OFF.
 2. No INPUT on channel A.
 3. Incorrect TRIGGER LEVEL setting.
 4. Rear panel switch set to EXT without an input connected.
 5. Improper EXT input level.
- c. An average has been completed and the instrument is awaiting further averaging instructions. (Suggestion: turn AVERAGE to OFF.)
- d. A Plotting operation has been initiated and the instrument is awaiting completion of the plot. Note that the display will remain active during this time.

3-127. Overload.

3-128. Data displayed under OVERLOAD conditions may involve the following peculiarities:

- a. Overload occurs at 100% of full scale input and may produce spurious responses in spectral display data.
- b. The TIME display is shown as alternate time record points; therefore it is possible to have an overload indication which does not appear in the TIME record display.

c. Signals are clipped at full scale and as a result, displayed spectra may be misrepresented in amplitude.

d. To avoid a possible overload when using TIME AVERAGE, be sure that input signals are at least 2 dB below full scale.

3-129. Unrelated Spectral Displays.

3-130. The 3582A may display spectra which are unrelated to the input signal under the following circumstances:

a. If using either SET START or SET CENTER, several spectral lines may appear above 26 kHz. These spectra are derived from the switching power supplies and from an analog to digital exercising signal.

b. If the PERIODIC NOISE SOURCE is used in combination with either the SET START or SET CENTER frequency modes, the spectral data within one SPAN width of 0 Hz may be inaccurate due to local oscillator translated noise aliasing around 0 Hz and adding to the desired spectral data. To avoid this problem, use the 0 START frequency mode.

c. Unrelated spectral displays may be caused by data analyzed under OVERLOAD conditions.

d. Stray signals present in both input channels may result in an abnormally high COHERENCE level even though there is no cause and effect relationship, merely the presence of a common signal. (Suggestion: use well shielded input cables.)

3-131. Noise Source Output.

3-132. The 3582A has two types of noise sources available. There are measurement situations where the use and choice of a noise source may be critical in achieving correct results. The Noise Source Output has the following peculiarities:

a. The PERIODIC noise source will cause uneven or noisy transfer function measurements on non-linear systems. (Suggestion: Use the RANDOM source and AVERAGING.)

b. Use an external source resistor when driving low impedance filters. For example, use a 50 ohm external series resistor when driving a 50 ohm filter. This is necessary because of the low output impedance (< 2 ohms) of the Noise Source Output.

3-133. SIMPLIFICATION OF DISCRETE DATA ANALYSIS.

3-134. Introduction.

3-135. The following description is presented in order to provide the user with a feel for what is taking place in the 3582A as data is converted from the time domain to the frequency domain. While this is entirely a mathematical process, the main vehicle for explanation will be graphical with many math operations assumed for simplification.

3-136. Time Domain Considerations.

3-137. The sampling function is carried out by hardware while the conversion to the frequency domain is handled by firmware. Sampling is accomplished in the Analog-to-Digital Converter at a 102.4 kHz rate and involves the multiplication of the normalized input waveform by an impulse train of unity amplitude. This results in the waveform being broken down into a series of amplitude pulses separated by the period of the sampling impulses (see Figure 3-28).

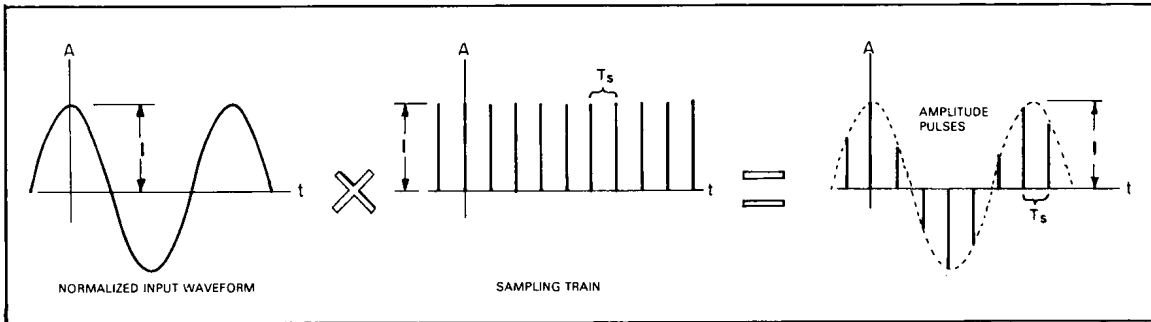

Figure 3-28. Sampling an Input Waveform.

3-138. Because of limited memory and other processing requirements, sampled data cannot be taken indefinitely and therefore must be restricted to a period of time called a window. A window in this particular sense is defined as a square pulse of unity amplitude which, when the sampled data is multiplied by the window, confines it to a particular time interval (see Figure 3-29).

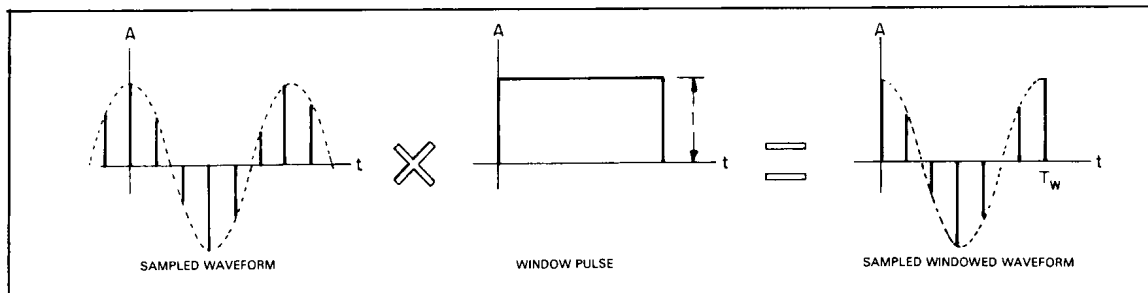

Figure 3-29. Windowing a Sampled Waveform.

3-139. Frequency Domain Considerations.

3-140. So far, three waveforms and two processes have been given in the time domain. Each waveform and process has an equivalent representation in the frequency domain which is carried through by Fourier Analysis. For example, assume the input is a cosine waveform which has a discrete line spectrum in the frequency domain. Its representation in the frequency domain is indicated in Figure 3-30.

3-141. Notice that as a result of the transform, half of the energy is represented in the negative frequency region of the spectrum. This situation is eliminated by scaling the amplitude data by a factor of two before it is displayed.

3-142. The sampling train is composed of impulses of theoretically zero width. An impulse train transforms into a discrete line spectrum with lines spaced at $1/T_s$ intervals. Its representation in the frequency domain is indicated in Figure 3-31.

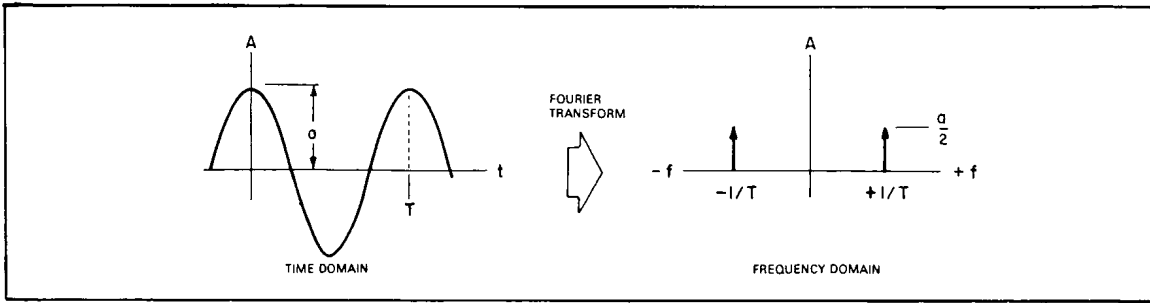

Figure 3-30. Frequency Representation of a Cosine Wave.

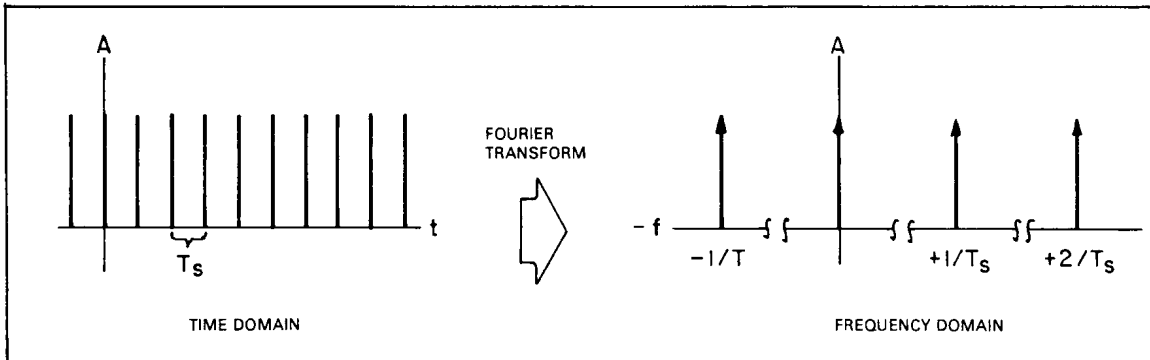

Figure 3-31. Frequency Representation of an Impulse Train.

3-143. The square pulse has a unique frequency domain representation which is not discrete but a continuous function and is composed of all frequencies. This function is represented by the formula $Y = \text{SIN } X/X$ (see Figure 3-32).

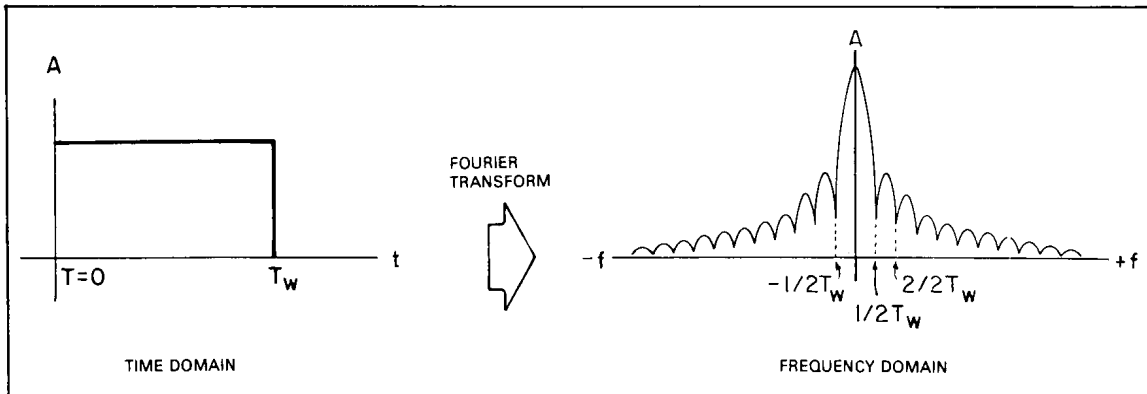

Figure 3-32. Frequency Representation of a Square Pulse.

3-144. In the time domain, different waveforms were multiplied resulting in a new modified waveform, i.e., the sampled windowed cosine wave. This multiplication process is represented in the frequency domain by another process called convolution. In a mathematical context, the operation involves the use of the Convolution Integral, sometimes known by its other name, the Superposition Integral. The convolution of the cosine spectrum with a sampling spectrum is shown in Figure 3-33.

3-145. Notice that the impulse spectrum has been combined into the new cosine and impulse spectrum. Another convolution operation is necessary involving the sampled cosine spectrum and the window spectrum (see Figure 3-34).

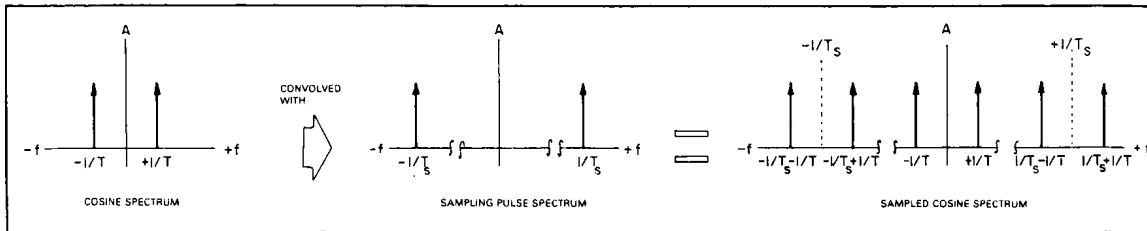

Figure 3-33. Convolving the Cosine Spectrum with the Sampling Pulse Spectrum.

3-146. Although there appear to be three sets of SIN X/X shapes, each set is replicated at intervals of $1/T_s$ (sampling frequency) out to infinity in both positive and negative frequency domains. A seeming paradox is that all the information needed by the 3582A is contained in one-half of any one set or one SIN X/X shape and its relationship to the origin or zero Hz mark. The other sets cannot be forgotten and may impair desirable data due to a characteristic of sampling systems called aliasing.

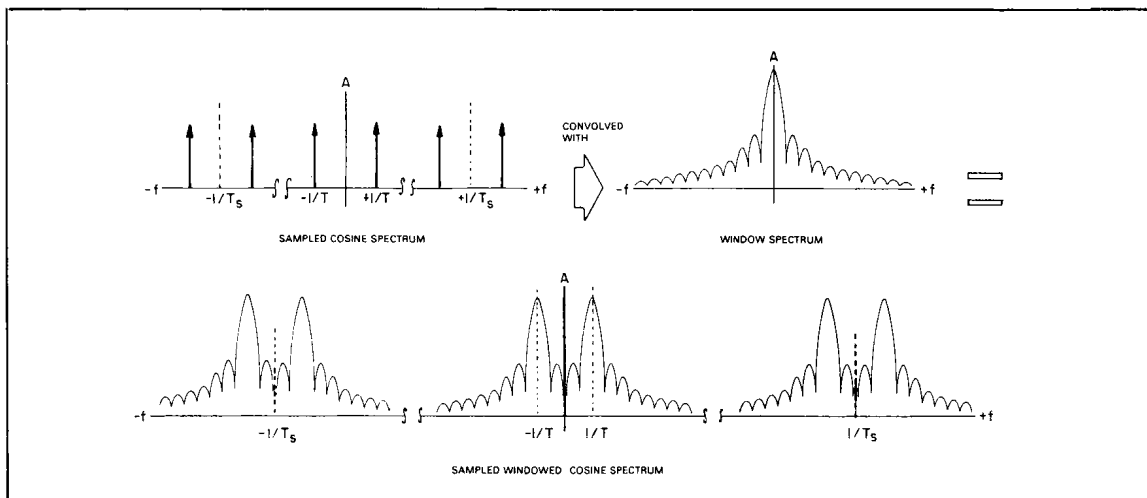

Figure 3-34. Convolving a Sampled Cosine Spectrum with a Window Spectrum.

3-147. Aliasing.

3-148. Consider what would happen if the frequency of the cosine wave were to increase. Each SIN X/X shape in a pair would separate (see Figure 3-35).

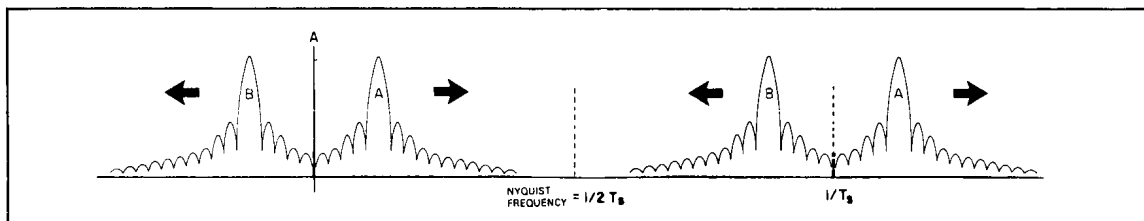

Figure 3-35. Increasing the Frequency of a Cosine Wave.

Remembering that the sampling frequency ($1/T_s$) is constant, it can be visualized that as the cosine wave continues to increase in frequency, the SIN X/X shapes will meet at a point half-way between the sampling frequency and the origin. This point is called the Nyquist Frequency and defines the maximum frequency of a sampled waveform. Any further increase in the waveform frequency above the Nyquist point will result in an overlapping of spectrums and contamination of data in the desirable region of the spectrum under analysis. This is called aliasing (see Figure 3-36).

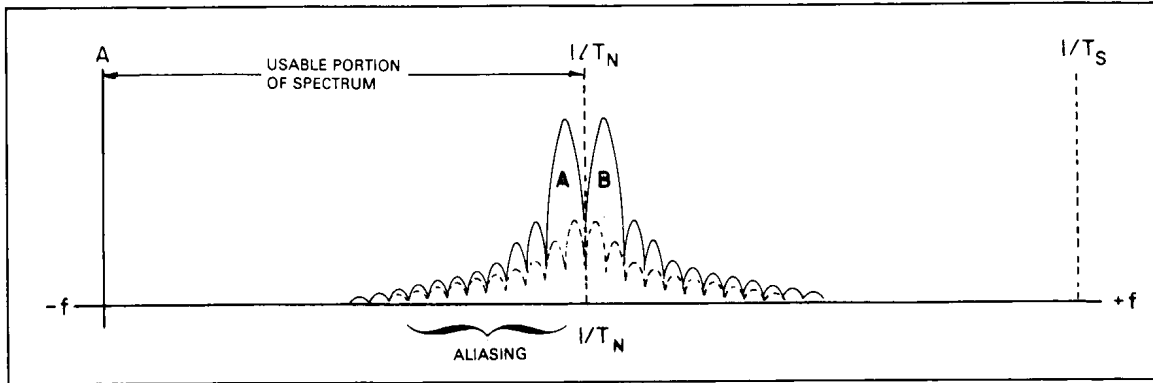

Figure 3-36. Aliasing.

3-149. Aliasing may be minimized by increasing the sampling frequency or filtering the input waveform so that frequency components above the Nyquist point are reduced to acceptable levels. The 3582A does the latter of the two and has an antialiasing filter in the input section which is flat to 25 kHz and then rolls off to approximately -80 dB at 70 kHz. Since the sampling frequency is 102.4 kHz and the Nyquist Frequency is at 51.2 kHz, data within the dynamic range of the instrument should be free from alias contamination (see Figure 3-37).

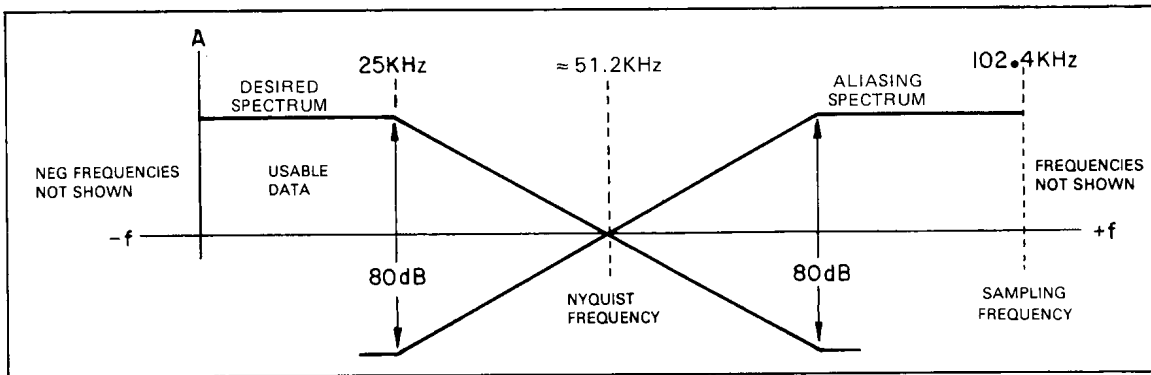

Figure 3-37. 3582A Antialiasing Filter.

3-150. Data in Memory.

3-151. Refer again to the SIN X/X shape (see Figure 3-38).

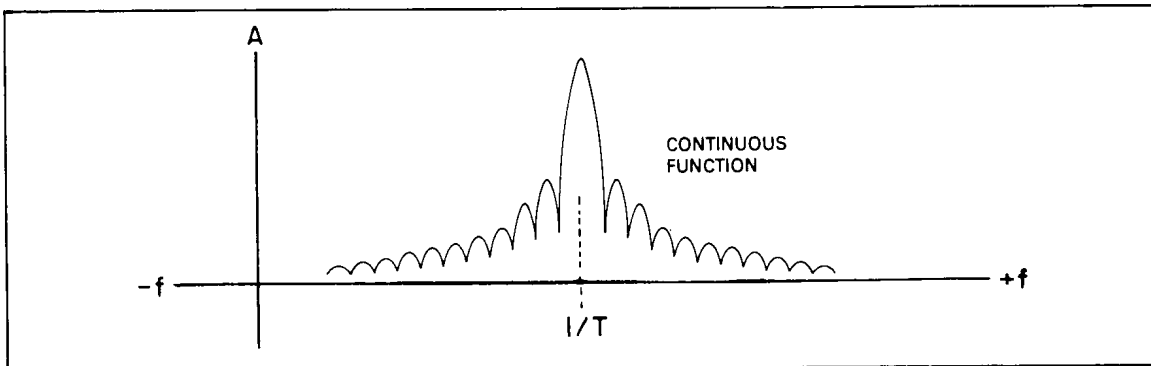

Figure 3-38. The Continuous Function.

3-152. What has been presented to this point is a graphical analogy of the continuous function resulting from the Fourier Transform of a cosine wave. But the 3582A uses an

implementation of the Discrete Fourier Transform called the Fast Fourier Transform. The key here is the word discrete. Instead of the transform being evaluated for all frequencies, the discrete transform is evaluated at selected frequency intervals. Therefore, the discrete transform is an approximation of the continuous transform and the resemblance to the latter depends upon the number of frequency evaluation points. How many points are needed? Naturally, the more points evaluated, the more defined the function becomes. The 3582A has 256 display points on single trace and 128 display points on double trace stored in memory. These points are derived from a 1024 point or 512 point time record (the result of sampling) which also resides in memory. These combination of points are a compromise among filter design, memory allocation, and display information. A way of visualizing the spectrum points in memory is to think of the continuous function masked by a slotted overlay (see Figure 3-39).

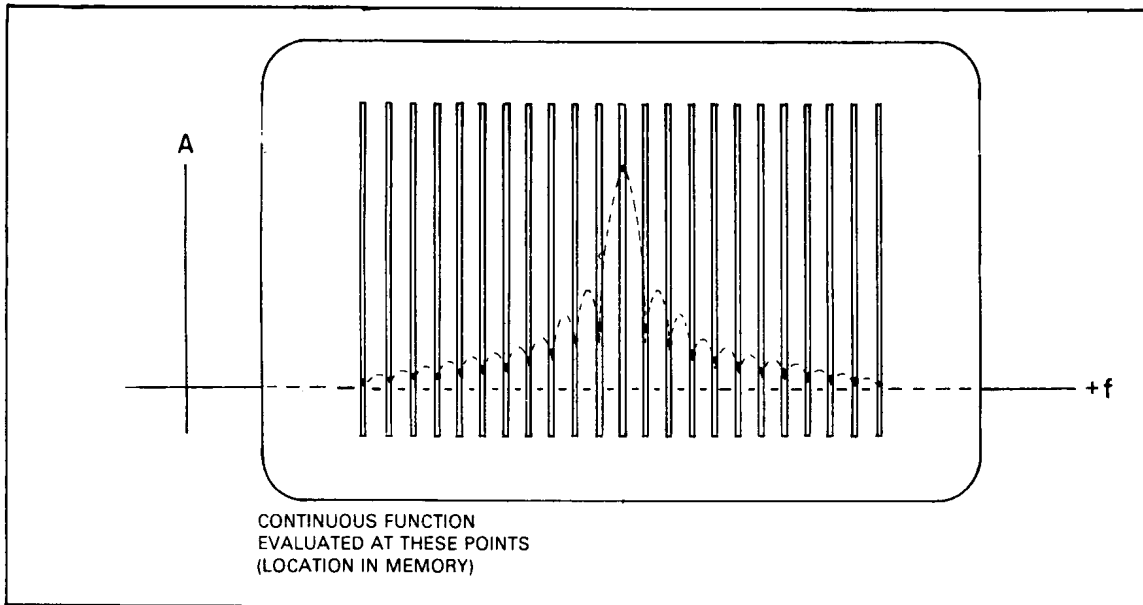

Figure 3-39. Spectrum Points in Memory.

3-153. Interpreting the Display.

3-154. It is now easy to understand that each location in memory is a frequency point (commonly referred to as a frequency bin) and that the digital word in that location (bin) represents the amplitude and phase at that point. The Display Section contains the hardware and firmware which allows the display to be shown as the data points connected by straight line segments (see Figure 3-40).

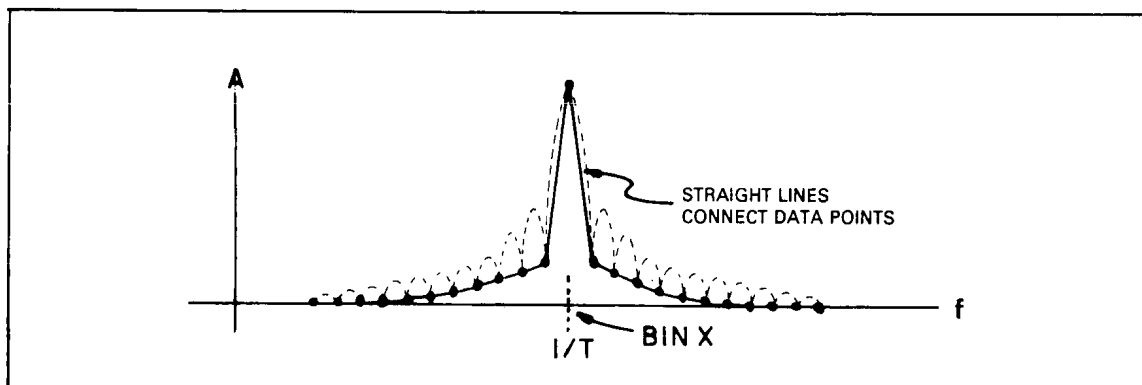

Figure 3-40. Memory Data Points Displayed on CRT.

3-155. Notice that many of the spectrum points occur in the valleys (nulls) of the $\text{SIN } X/X$ shape. Remembering that the frequency bins are fixed relative to the frequency scale, what would happen if the cosine wave input were to change slightly in frequency? Spectrum points will now be determined at other parts of the $\text{SIN } X/X$ shape (see Figure 3-41). This distorted spectrum is the result of leakage.

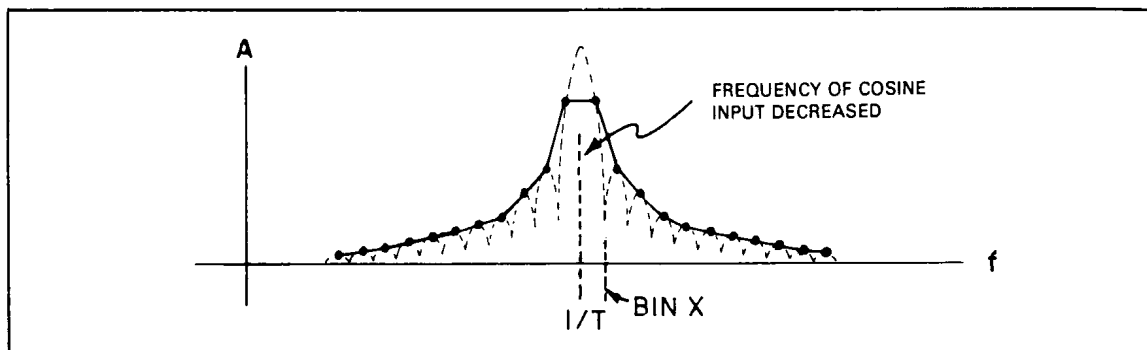

Figure 3-41. Leakage of Energy.

3-156. Leakage.

3-157. A property of the $\text{SIN } X/X$ shape is that the nulls (valleys) line up with the bin frequencies whenever the center frequency of the waveshape under examination occurs at a bin frequency. Thus, changes result only when the frequency of the input is varied and the worst case occurs when the center frequency of the signal being analyzed is shifted between two adjacent bin frequencies. Because energy is related to amplitude, the undesirable changes in amplitude between adjacent bins is called leakage. The energy is said to have leaked from one bin to another. One method for reducing leakage is to modify the window function which operates on the time record.

3-158. Windowing.

3-159. As previously described, windowing involved the limiting of the number of samples of the input waveform to a particular interval of time. Therefore, windowing may be thought of as performing some operation on data as it passes through. Additional time domain windows may be added in series to manipulate frequency domain data through the convolution process (multiplication of data in the time domain).

3-160. The $\text{SIN } X/X$ shape in the frequency domain was the result of time domain sampling with no further windowing operations applied. The frequency domain function produced inaccuracies when evaluated in a discrete manner. These inaccuracies were primarily due to the excessive relative amplitude of the sidelobes of the function (see Figure 3-42).

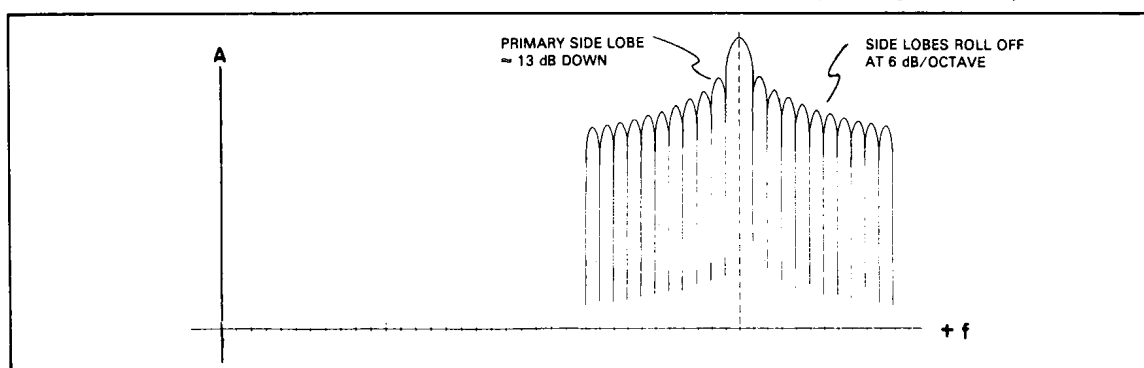

Figure 3-42. Sidelobes of Transformed Rectangular Window.

3-161. Notice that the primary sidelobes are only 13 dB down and that successive sidelobes roll off at 6 dB/octave. The sidelobe amplitude may be reduced through the use of additional windowing operations, but this occurs only at the expense of increased bandwidth. This sidelobe-bandwidth tradeoff translates into an amplitude accuracy versus frequency resolution tradeoff when the choice of passbands needs to be considered.

3-162. The additional windowing functions are accomplished when time domain data is shifted from the accumulated time record buffer in memory to another buffer in memory where the Fast Fourier Transform is performed (see Figure 3-43).

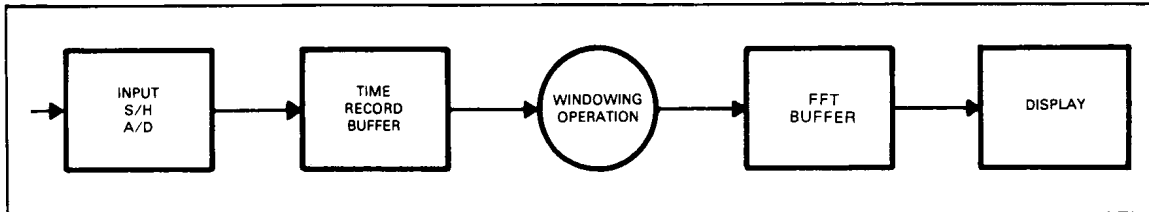

Figure 3-43. Data Flow.

3-163. Window Functions.

3-164. The window functions, including additional notes are presented as follows:

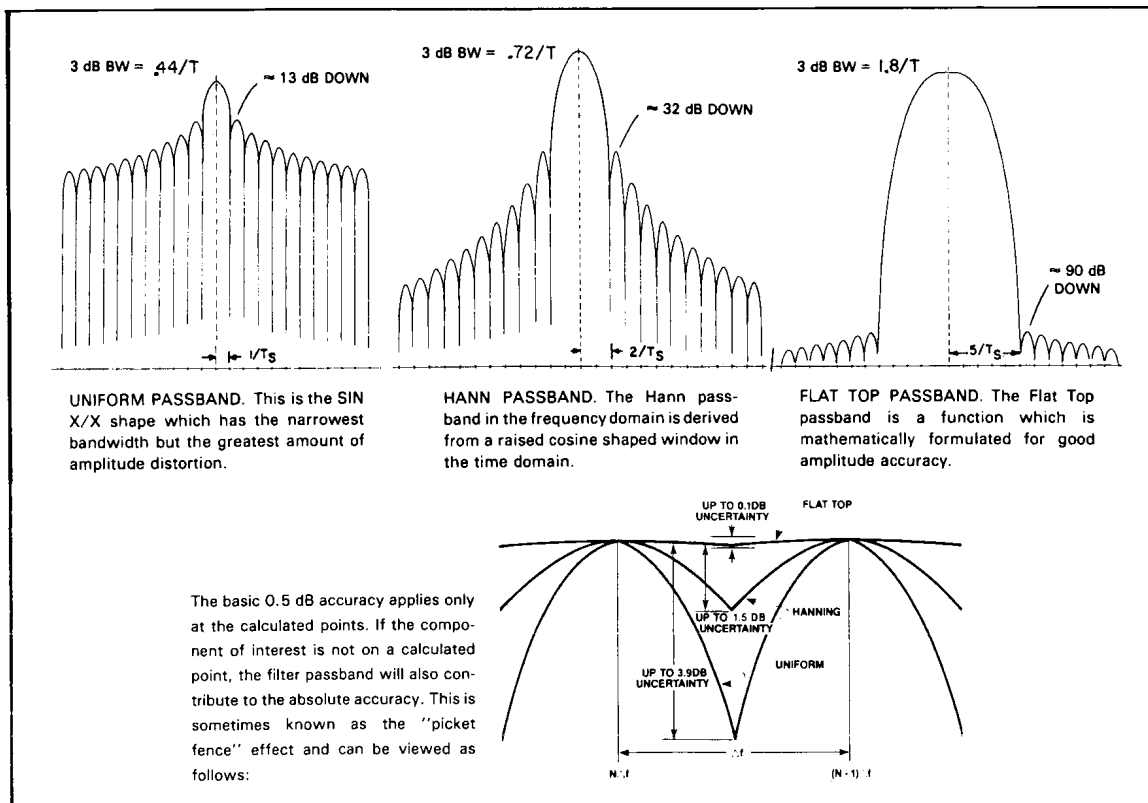

Figure 3-44. Window Functions.

NOTE

The Hann window, commonly referred to as the Hanning window, was discovered by Julius von Hann. Hanning refers to the operation of applying a Hann window.

SECTION III PART II

REMOTE OPERATION

3-165. REMOTE OPERATION.

NOTE

The 3582A may be remotely controlled in much the same manner as it is controlled manually. Therefore, it is recommended that the manual operation of the instrument be learned before remote operation is attempted.

3-166. INTRODUCTION.

3-167. The following information concerning remote operation of the 3582A via the Hewlett-Packard Interface Bus (HP-IB) will be supplemented with examples using the -hp-9825A Calculator and -hp-1000 computer (controllers) with equivalent examples incorporating the Meta Message concept. For a condensed description of the HP-IB, see Appendix B. For a condensed description of the Meta Message concept, see Appendix C.

NOTE

HP-IB is Hewlett-Packard's implementation of IEEE Std. 488-1975, "Standard Digital Interface for Programmable Instrumentation".

3-168. While the -hp-9825A and -hp-1000 are specific controllers, fully capable of implementing all the HP-IB functions used with the 3582A, the Meta Message equivalent may be referenced to by any controller which is HP-IB compatible.

NOTE

Not all HP-IB compatible controllers may possess the sophistication necessary to utilize the complete remote capabilities of the 3582A.

3-169. 3582A REMOTE FUNCTIONS.

3-170. General Description.

3-171. In remote operation, the 3582A has even greater flexibility than in manual operation. The following functions describe how the 3582A may be controlled through the HP-IB:

Remote Front-Panel Programming

In addition to the normal front panel switch controls, the operation of the 3582A can be controlled by remote commands sent on the HP-IB.

Instrument Data Output

Display data, alphanumerics, switch settings and other useful data can be output from the instrument for the purpose of making plots, additional processing, etc.

Instrument Data Input

Time record data obtained by external means can be input to the instrument for analysis. Also, any of the instrument data output may be reentered into the instrument at a later time.

Instrument Signal Processing Control and Status

Additional special HP-IB commands allow limited control of the signal processing. An 8 bit status word is available to indicate various states of the signal processing.

3-172. REMOTE FRONT PANEL PROGRAMMING.

3-173. The Command List specifies all of the functions which may be activated by the 3582A via the HP-IB. Note that many of the functions are the remote equivalent of setting a front panel switch manually and may be executed in similar sequences. For example, the arm command (AR) would not be given until all other applicable functions are set for a measurement operation. The Command List is given in Appendix A.

3-174. The HP-IB status light "REMOTE", located at the lower left of the front panel, indicates whether the instrument is currently operating under local (front panel switches) or remote control. Remote operation is accomplished only via commands sent on the HP-IB.

3-175. When the instrument is in local, the operation is determined solely by the front panel settings. At the time that the instrument is programmed to remote, the operation remains exactly the same as it was in local. Additional commands sent on the HP-IB can change the mode of operation. Returning to local, either by pushing the LOCAL button or by an HP-IB command, causes the instrument to return to front panel switch control.

3-176. Syntax.

3-177. The Command List (actually sent as DATA) is divided into groups of related operations. Each command in a group is divided into a function and a setting (some groups do not have settings). If the function is a front panel switch, the letters will correspond to the underlined letters of the name of that switch on the front panel. The setting indicates a switch position. A zero setting will indicate that the switch is out (OFF) and numbers greater than zero indicate that the switch is in (ON) or set at some other position (rotary switches and slide switches). On rotary and slide switches, a one (1) will indicate a counterclockwise or left most position (COUPLING switches excepted, a one indicates ac).

3-178. Adjust Frequency. For Adjust Frequency (AD 0-24999), the setting is a number which corresponds to the CENTER or START frequency in the band analysis modes.

3-179. Marker Position. The marker position setting corresponds to a position on the display. For single trace modes of operation, the marker may be programmed to one of 256 horizontal positions. For dual trace operation, the marker may be programmed to one of 128 horizontal positions on the selected trace.

3-180. Delimiters.

3-181. Delimiters are not needed, but if desired, commas, spaces, upper or lower case alphanumerics can be used.

NOTE

*The last character needs to be followed by a CRLF, space, or a comma. For example, the 9825A automatically sends this information if the **wrt** statement is used. If the **cmd** statement is used, these additional characters must be supplied. The **PRINT** statement on the **-hp- 1000** automatically defaults to **CRLF** if these characters are forgotten. Spaces following characters will not effect the messages sent, except for the write alphanumerics (**WTA**) command which requires the output string of characters to have a fixed number of characters (32) and may consist of spaces and/or alphanumeric characters.*

	-hp- 9825A	-hp- 1000
Example:	wrt711,“prs, ad442,ac1”	10 PRINT#11;“prs,ad442,ac1”
	wrt711,“PRSAD442AC1”	10 PRINT #11; “PRSAD422AC1”

3-182. SPECIAL FRONT PANEL COMMANDS.

3-183. Special commands are useful when it is desirable to set the front panel controls for a particular mode of operation. Special sequences are useful when data is being transferred between the 3582A and a controller.

3-184. Using Preset.

3-185. The preset (PRS) command places the 3582A front panel controls in a mode which is equivalent to that in the Turn-On Procedure. If the 3582A instrument appears to be “hung up” due to an inadvertant programming error, sending the PRS command will often return the instrument to an operating status. Furthermore, it is a good programming practice to “initialize” the front panel controls of the 3582A using the PRS command before entering an extensive programming sequence. See the Command List in Appendix A for the PRS switch settings.

3-186. Setting the Marker.

3-187. The marker position command (MP) combined with a marker position number (0-255 or 0-127) sets the marker horizontal position on the display. The marker position may be determined by the following equations:

$$\text{MARKER POSITION} = \frac{250 \text{ (or } 125^*)}{\text{SPAN}} \times (\text{fm} - \text{fs})$$

$$\begin{aligned} \text{Where: fm} &= \text{Desired marker frequency} \\ \text{fs} &= \text{START FREQUENCY or } \left(\text{CENTER FREQUENCY} - \left(\frac{\text{SPAN}}{2} \right) \right) \end{aligned}$$

***NOTE**

The marker has 128 positions for each trace in dual mode.

3-188. Note that on larger spans and dual trace operation, the marker position (derived from the equation) will not be an integer for some frequencies. In this case, round the marker position to the nearest integer number.

3-189. INSTRUMENT DATA OUTPUT.

3-190. The listing commands are used to read control or display data from the 3582A. The general form for initiating a list command requires that the list command be given by the controller which sets the 3582A in a "talk" mode. The 3582A will then output data, as specified by the list command, to the controller which must then be programmed to the "listen" mode.

3-191. Listing Control Settings.

3-192. The position of some front panel control settings, in decimal or exponential format, may be read by the controller through the following list commands:

Command	Description
LAD	List frequency adjust value NNNNN.NN CRLF
LMK	List marker amplitude and frequency ± NNNNE ± NN, NNNNN.NNN CRLF
LSP	List span (Hz) NNNNN CRLF
LAS	List channel A sensitivity
LBS	List channel B sensitivity
LXS	List Transfer Function sensitivity
	} ± N.NNE ± NN CRLF

3-193. Notice that all of the list commands above, except LMK, require one variable in which to store the data in the controller. The LMK instruction requires two variables in which to store data, and both must be available when the LMK command is given. (See the HP-IB section of your controller manual for information on how to read from the HP-IB into multiple variables.) The sensitivities obtained by the LAS, LBS, and LXS commands are the same as those indicated on the display and are the total of the SENSITIVITY switch setting and the AMPLITUDE REFERENCE LEVEL switch setting. The units are either volts or dBV as determined by the LOG/LINEAR switches.

3-194. Program Examples.

<pre>-hp- 9825A 0: "program to demo LAD comman d": 1: fxd 1;wrt 711,"LAD" 2: red 711,A; prt A;dsp "FREQ =",A 3: lcl 711;end *6446</pre>	<p>META Equivalent</p> <p>REMOTE DATA: LAD</p> <p>DATA: NNNNN.NN CRLF</p> <p>LOCAL</p>
---	--

-HP - 1000-

META Equivalent

```

-----
10 CALL RMOPE(7)
20 PRINT #7; "LAD"
30 READ #7;A
40 PRINT "FREQUENCY ADJUST "A" HZ"
50 CALL GTL(7)
60 END

```

```

REMOTE
DATA: LAD
DATA: NNNNN.NN CRLF

LOCAL

```

-hp- 9825A

META Equivalent

```

0: "program to
demo LMK comman
d":wrt 711;"LMK
";red 711;A,B
1: flt 2;prt A,
B;dsp "A=";A,
"B=";B
2: lcl 711;end
*17489

```

```

REMOTE
DATA: LMK
DATA: ± NNNNE ± NN, + NNNNN.NNN CRLF

```

LOCAL

-HP- 1000

META Equivalent

```

-----
10 CALL RMOPE(7)
20 PRINT #7;"LMK"
30 READ #7;B,C
40 PRINT "MARKER AMPLITUDE ="B" DBV"
45 PRINT "MARKER FREQUENCY ="C" HZ"
50 CALL GTL(7)
60 END

```

```

REMOTE
DATA: LMK
DATA: ± N.NNN E ± NN, NNNNN.NNN CRLF

```

LOCAL

-hp- 9825A

META Equivalent

```

0: "program to
demo LSP comman
d":
1: fxd 1;wrt
711;"LSP"
2: red 711;A;
prt A;dsp "SPAN
=";A
3: lcl 711;end
*323

```

```

REMOTE
DATA: LSP
DATA: NNNNN CRLF

```

LOCAL

-HP - 1000-

META Equivalent

```

-----
10 CALL RMOPE(7)
20 PRINT #7; "LSP"
30 READ #7;A
40 PRINT "SPAN "A" HZ"
50 CALL GTL(7)
60 END

```

```

REMOTE
DATA: LSP
DATA: NNNNN CRLF

```

LOCAL

-hp- 9825A

META Equivalent

```

0: "program to
demo LAS comman
d":
1: flt 2;wrt
711,"LAS"
2: red 711,A;
prt A;dsp "ASEN
S=",A
3: lcl 711;end
*29531

```

```

REMOTE
DATA: LAS
DATA: ±N.NNE±NN CRLF

```

LOCAL

-HP - 1000-

META Equivalent

```

-----
10 CALL RMOPE(7)
20 PRINT #7; "LAS"
30 READ #7;A
40 PRINT "CH. A SENSIVITY (DBV/V):"A
50 CALL GTL(7)
60 END

```

```

REMOTE
DATA: LAS
DATA: ±N.NNE±NN CRLF

```

LOCAL

3-195. Listing Display Data. The display graphics or the display alphanumeric may be listed using the following instructions:

Command	Description
LDS	List display (128, 256, or 512 points in corresponding units) each point $\pm N.NNE \pm NN$ separated by commas; CRLF
LAN	List alphanumeric (128 ASCII characters, CRLF; representing the four 32 character lines)

3-196. The LDS instruction causes the 3582A to output data from the display in three different quantities. The number of points which are outputted depends upon the particular mode of operation the instrument is in when the LDS command is received (see Table 3-2).

Table 3-2. LDS Points Returned.

No. of Points	Mode of Operation
128	Single trace in dual channel mode
256	1. Single trace in single channel mode 2. Dual trace in dual channel mode (128 points for channel A followed by 128 points for channel B) 3. Single time trace in dual channel mode
512	Single trace time in single channel mode

3-197. The points are outputted in corresponding units. That is, the SCALE and SENSITIVITY will determine the type of units and the relative magnitude. However, the magnitude of the time points are determined by the SENSITIVITY setting alone. Each group of ASCII coded characters is separated by commas with the CRLF sent after the last point.

NOTE

It is important to note that some controllers may not accept a comma as a delimiter and therefore may require special programming steps in order to receive and retain the number representing each point sent.

3-198. Note that if the display is listed when the instrument is in the UNCAL (uncalibrated) mode, the units which are output will be different than when the instrument is in the CAL mode (see Table 3-3).

Table 3-3. Output Units.

Function	CAL	UNCAL
Amplitude	dBV (log) Volts (lin)	0 to 1
Time	- 1 to + 1	0 to 1
Phase	- 200 to + 200	0 to 1
Transfer Function	dB	dB

3-199. Program Example.

```

-hp- 9825A                                META Equivalent

0: "program to
   demo LDS common
   d":
1: fmt 1,f4.0,                                REMOTE
   2x,e10.2;wrt                                DATA: LDS
   711,"LDS"
2: red 711
3: for I=0 to 9
** 4: red 731;A;                                DATA: Each point ±N.NNE±NN
   wrt 16.1;I;A;                                separated by commas;
5: next I                                        CRLF sent last
6: spc 2;lcl
   711;end
*23532                                LOCAL
    
```

**731 operates with a device currently addressed on the bus and provides faster reading and writing speeds.

3-200. The LAN (list alphanumerics) instruction causes the 3582A to output 128 ASCII coded characters which represent the four alphanumeric display lines. Note that some symbols such as $\sqrt{\quad}$ (square root) do not have an ASCII equivalent and may require conversion to another code form. Table 3-4 gives the displayed character and the ASCII equivalent which is sent or received over the HP-IB.

Table 3-4. Display-ASCII Equivalents.

LISTEN					TALK			LISTEN					TALK		
OCT	DEC	CHAR SENT	CHAR DISP	CHAR RETN	OCT	DEC	OCT	DEC	CHAR SENT	CHAR DISP	CHAR RETN	OCT	DEC		
41	33	!	!	!	41	33	104	68	D	D	D	104	68		
42	34	"	"	"	165	117	105	69	E	E	E	105	69		
43	35	#	#	#	144	100	106	70	F	F	F	106	70		
44	36	\$	\$	\$	155	109	107	71	G	G	G	107	71		
45	37	%	%	%	172	122	110	72	H	H	H	110	72		
46	38	&	&	&	170	120	111	73	I	I	I	111	73		
50	40	(((57	47	112	74	J	J	J	112	74		
51	41)))	134	92	113	75	K	K	K	113	75		
52	42	+	+	+	52	42	114	76	L	L	L	114	76		
53	43	+	+	+	53	43	115	77	M	M	M	115	77		
55	45	-	-	-	55	45	116	78	N	N	N	116	78		
56	46	.	.	.	56	46	117	79	O	O	O	117	79		
57	47	/	/	/	57	47	120	80	P	P	P	120	80		
60	48	0	0	0	60	48	121	81	Q	Q	Q	121	81		
61	49	1	1	1	61	49	122	82	R	R	R	122	82		
62	50	2	2	2	62	50	123	83	S	S	S	123	83		
63	51	3	3	3	63	51	124	84	T	T	T	124	84		
64	52	4	4	4	64	52	125	85	U	U	U	125	85		
65	53	5	5	5	65	53	126	86	V	V	V	126	86		
66	54	6	6	6	66	54	127	87	W	W	W	127	87		
67	55	7	7	7	67	55	130	88	X	X	X	130	88		
70	56	8	8	8	70	56	131	89	Y	Y	Y	131	89		
71	57	9	9	9	71	57	132	90	Z	Z	Z	132	90		
72	58	:	:	:	72	58	134	92	r	\	r	134	92		
74	60	<	<	<	74	60	144	100	d	d	d	144	100		
76	62	>	>	>	162	114	155	109	m	m	m	155	109		
77	63	?	?	?	77	63	162	114	r	r	r	162	114		
101	65	A	A	A	101	65	165	117	u	u	u	165	117		
102	66	B	B	B	102	66	170	120	x	x	x	170	120		
103	67	C	C	C	103	67	172	122	z	z	z	172	122		

3-201. Program Example.

-hp- 9825A

META Equivalent

```

0: "program to
   demo LAN comman
   d":
1: dim A#[130];
   fxd 0
2: wrt 711,"LAN"
3: red 711,A#
4: wrt 16,A#[1,
   32]
5: wrt 16,A#[33,
   64]
6: wrt 16,A#[65,
   96]
7: wrt 16,A#[97,
   128]
    
```

REMOTE
DATA: LAN
DATA: 128 ASCII characters, CRLF

```

8: wrt 0,A#[1,
  32];stp
9: wrt 0,A#[33,
  64];stp
10: wrt 0,A#[65,
  96];stp
11: wrt 0,A#[97,
  128];stp
12: lcl 711;end
*5323
    
```

LOCAL

-HP - 1000-

META Equivalent

```

1 DIM A$(140)
2 FOR I = 1 TO 130
3 A$(I) = "X"
4 NEXT I
10 CALL RMOTE(7)
20 PRINT #7;"LAN"
30 READ #7;A$

40 PRINT A$(1,32)
50 PRINT
60 PRINT A$(33,64)
70 PRINT
80 PRINT A$(65,96)
90 PRINT
100PRINT A$(97,128)
110CALL GTL(7)
120END
    
```

REMOTE
DATA: LAN
DATA: 128 ASCII CHARACTERS,
CRLF

LOCAL

3-202. INSTRUMENT DATA INPUT.

3-203. Writing Alphanumeric Messages.

3-204. Alphanumeric messages may be written into any of the four alphanumeric lines on the display through the use of the following instruction:

WTA 1-4, 32 ASCII Characters

select line 1,2,3, or 4 Use blanks to fill up remaining spaces to total 32.

The first part of the instruction (WTA) should be followed immediately by a line number and a comma. The next 32 characters are reserved for the text of the message. For example, to write "A COSINE SPECTRUM" on line 1 of the display, the command and message would appear as follows (Δ means space):

"WTA1,ΔΔΔΔΔΔΔΔΔΔCOSINEΔSPECTRUMΔΔΔΔΔΔΔΔ"

NOTE

The text of the message must have at least 32 characters or the 3582A will not display the message and will appear to be "hung up" while waiting for the completion of the message.

3-205. Program Example.

```

-hp- 9825A                                META Equivalent

0: "program to
   demo WTA comman
   d":
1: dim B#[37]
2: "WTA1,"->B#[1,
   5];dsp "Write
   a 32 character
   message";wait
   5000;ent B#[6,
   37]
3: prt B#[6,37];
   wrt 711,B#
4: lcl 711;end
*23868
    
```

REMOTE
DATA: WTA1, 32 ASCII characters

LOCAL

3-206. WORKING WITH MEMORY.

3-207. The RAM (Random Access Memory) contents are completely accessible via the HP-IB. Data in memory is stored in a binary format consisting of 16 bit words. But information is transferred over the HP-IB in 8 bit bytes, therefore, two bytes are required to transmit or receive memory word.

3-208. The Binary Format.

3-209. In order to work with memory data directly, it is important that the binary format of words be understood. The words themselves indicate a magnitude for numerics or a particular code for alphanumeric. There are no units indicated in a numeric word and the word is simply a 2's complement binary number with an equivalent decimal range of from - 32768 to + 32767 (see Figure 3-45).

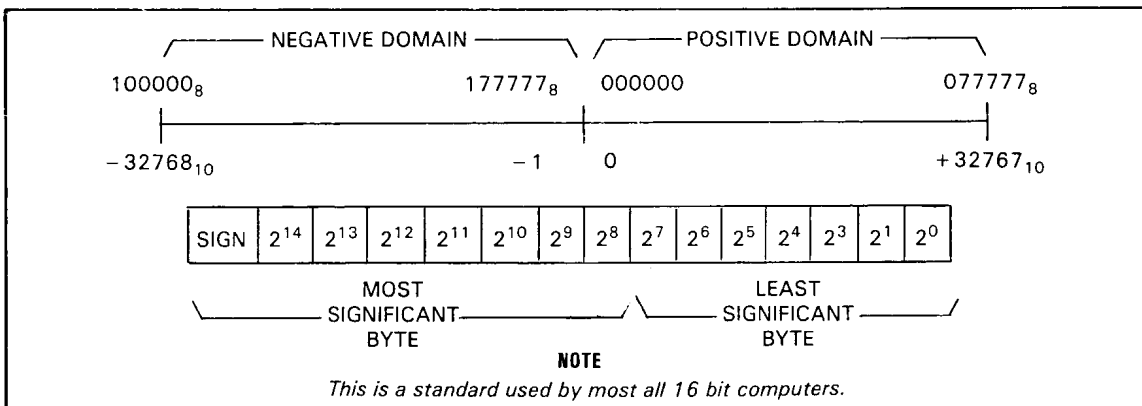

Figure 3-45. Words in Memory.

3-210. In the display section of memory, numerics and alphanumerics are mixed together and require a decoding procedure if they are to be interpreted by a controller program as binary data. This will generally not be necessary since the List Display commands perform the decoding operations and transmit the words in ASCII format.

3-211. When binary data is transmitted over the bus between the controller and the 3582A, the most significant byte of a 16 bit word is sent first followed by the least significant byte.

3-212. Memory Instructions.

3-213. There are two instructions for working with binary memory data. These commands are primarily for the advanced user who wishes to input his own time record or display or to do special processing:

<u>Command</u>	<u>Description</u>
LFM,M,N	List from memory
WTM,M,N	Write to memory

Where: M= Start address (octal)

N= Number of words to be transferred (decimal)

Data is in 2N 8 bit bytes, most significant byte first

3-214. These memory instructions are transmitted via the HP-IB in ASCII format. The controller must be programmed to take the appropriate action directly after the instruction is sent with no intervening messages. Each instruction requires that the memory location (in octal) be specified. For example, if a time record is to be entered into the 3582A for processing, the instruction would appear as follows:

WTM,70000,1024

NOTE

The 3582A starts accepting or sending binary data after the LF character is sent. The CRLF is automatically sent by the 9825A if the wrt command is used and by the -hp- 1000 when the PRINT statement is used. For other commands and controllers, check the order and type of characters used as delimiters. When the LFM or WTM instruction is used, a CR or LF is not sent by the 3582A after the binary string, nor is it looked for after a binary string is received from the controller.

After the instruction is given, the controller may send the data as a character string or as individual bytes. (Character strings may be composed of 8 bit bytes and are one of the faster methods for transferring data between the controller and the 3582A.) See EXAMPLE FLOWCHARTS AND PROGRAMS.

3-215. Memory Locations.

3-216. The principal memory locations of interest are given as follows:

<u>Description</u>	<u>Start Address (M, octal)</u>	<u>Number of Words (N, decimal)</u>	<u>Binary Format</u>
Time Record	70000	1024	Numeric
Display	74000	512	Alphanumeric
Front Panel Switches	77454	5	Numeric
Stored Trace 2	75400	256	Numeric

3-217. INSTRUMENT SIGNAL PROCESSING CONTROL AND STATUS.

3-218. Service Request.

3-219. Service Request (SRQ) is set only as a result of syntax errors caused by improper HP-IB commands. It is cleared by a DEVICE CLEAR or cleared as the result of a SERIAL POLL. When cleared, the five bit status byte returned will always consist of zeros.

3-220. Status Word.

3-221. The status word may be used to determine what operational state the 3582A is in. The eight bit status word contains the following information:

Bit	Value	Meaning
0	1	Diagnostic on screen. Indicates current switch setting is invalid. Set and cleared by 3582A.
1	2	Arm light is on. Set and cleared by 3582A to agree with arm light on front panel.
2*	4	A overload. Set by 3582A when <ol style="list-style-type: none"> 1. Time record is moved to FFT area or time record is complete 2. and hardware overload has occurred 3. and A or BOTH INPUT MODE is selected
3*	8	B overload. Same as A.
4*	16	Time record complete. Set when 1024 new time points have been taken since last record complete.
5*	32	Single sweep spectrum complete. Set when time complete data has been FFT'D and displayed. Use LST1 to check this flag! It depends on internal flags which are cleared by LST0.
6*	64	Average complete.
7*	128	X-Y plot complete. if two traces are plotted, it is set after the final trace.

NOTE

The Status Word is not the same as the HP-IB STATUS BYTE. The STATUS BYTE returned as the result of a serial poll will be zeros since the only reason for an SRQ from the 3582A is incorrect HP-IB commands.

3-222. The two commands for obtaining a status word are:

<u>Command</u>	<u>Description</u>
LST1	Reads status word
LST0	Reads status word and then resets*

As with many other HP-IB commands, the controller first gives the command and then reads the returning byte into a variable for decoding. The LST0 command resets the starred bits after they are read so that new information may be entered on the next machine cycle.

3-223. Program Example.

```

    -hp- 9825A                               META Equivalent

0: "program to
   demo LST comman
   d":
1: moct;fxd 0;
   wrt 711,"LST1"
2: dsp rdb(711);
   lcl 711;end
*9201
    REMOTE
    DATA: LST1
    DATA: Binary 8 bit word
    LOCAL
    
```

3-224. Processor Control Commands.

3-225. There are two processor control commands which can be used to improve data transfer rates when large blocks of data are transmitted.

<u>Command</u>	<u>Description</u>
HLT	Unconditional halt at next HP-IB branch point
RUN	Unconditional run

Without the use of these commands, the processor handles the HP-IB in an interrupt mode of operation. When the HLT command is given, the processor is stopped which allows practically direct memory access without unnecessary time delay. After the data is transferred, the processor may be returned to normal operation by giving the RUN command. However, no momentary buttons are processed when the processor is in the HLT mode.

3-226. EXAMPLE FLOWCHARTS AND PROGRAMS.

3-227. Loading a Time Record Into Memory.

3-228. The following flowchart presents the fundamental steps needed to load a time record into memory in the baseband 0-25 kHz mode. The time record should consist of 1024 data points with each point being a 16 bit 2's complement number (other magnitude ranges will require scaling). The example flowchart (see Figure 3-46) includes scaling for a function which has a range between +1 and -1 and also conversion of the scaled number to an integer.

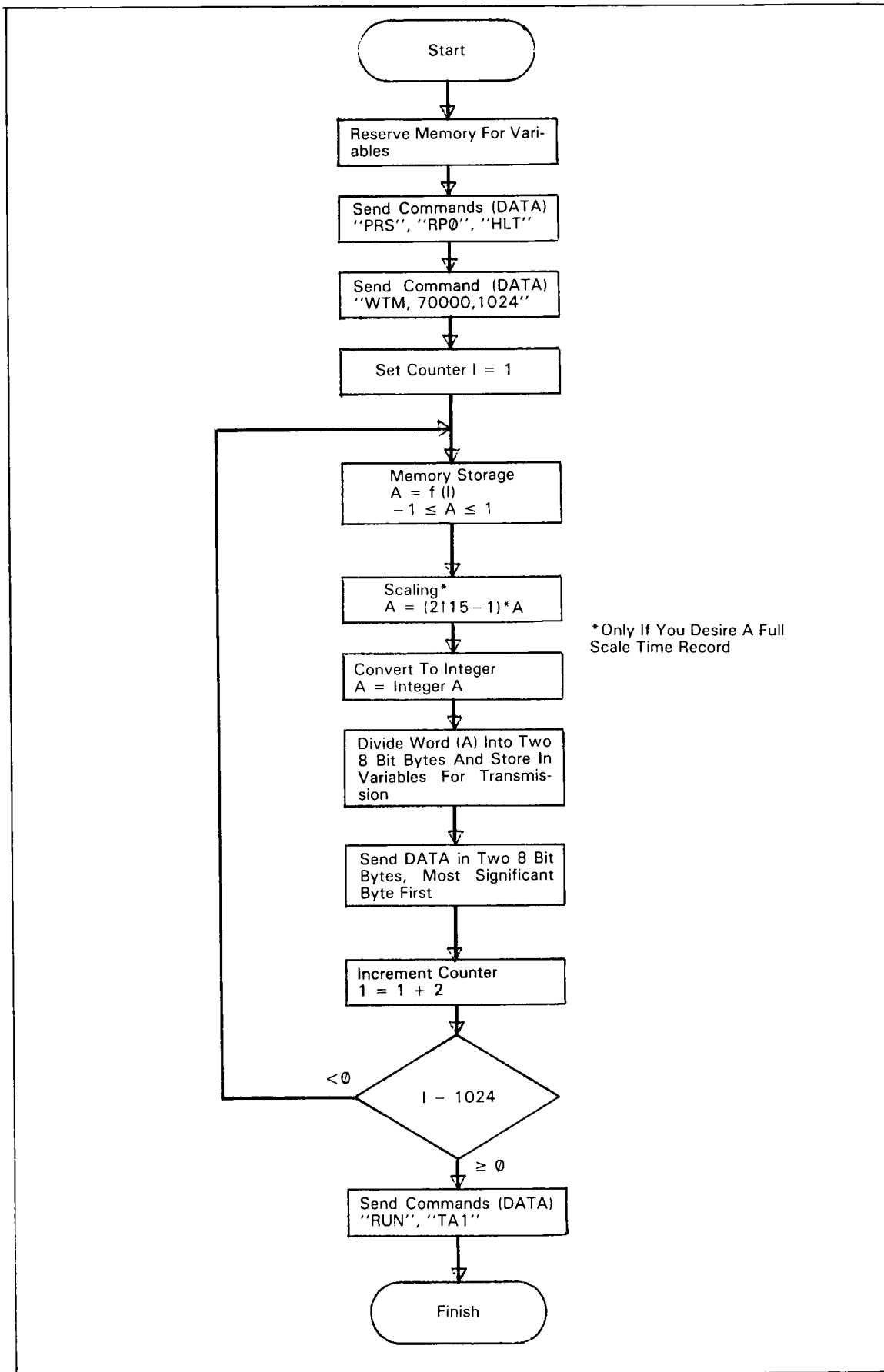

Figure 3-46. Storing a Time Record in Memory.

3-229. Program Example: Writing to Memory.

<pre> -hp- 9825A 0: "program to demo WTM comman d": 1: rad:wrt 711, "TA1" 2: mdec:dim A[10 24] 3: for I=1 to 1024 4: 20000*cos(2π* (I-1)/256)+A[I] 5: next I 6: fmt 1,"WTM, 70000,1024" 7: wrt 711.1 8: beep 9: for I=1 to 1024 10: wtb 731,shf(A[I],8) 11: wtb 731,band (255,A[I]) 12: next I 13: beep 14: end *9460 </pre>	<p>META Equivalent</p> <p>REMOTE DATA: TA1</p> <p>DATA: WTM,70000,1024</p> <p>DATA: Most significant 8 bit byte</p> <p>DATA: Least significant 8 bit byte</p>
--	---

3-230. Reading Binary Data From Memory.

3-231. The following flowchart presents the fundamental steps needed to read data from memory. A very useful function, derived from this operation, is the storage of data for long periods of time. Remember that if the 3582A is turned off, all data in RAM is lost. As an example, switch settings, time records, or the entire display may be stored in the controller and then later written back into the 3582A memory (using a technique similar to entering a time record but without the need for scaling since the data itself is merely being stored and not operated on). The example flowchart (see Figure 3-47) includes scaling* but this step may be skipped if the data is only to be stored.

3-232. The Learn Mode.

3-233. One method of programming the instrument is to use the PRS (preset) command and then program the control settings as necessary. Another method involves the Learn Mode. To use this method, the instrument controls are set up manually in the LOCAL mode of operation. The switch settings may then be stored in the controller by accessing the five switch registers using the LFM (list from memory) command. At a later time when it is desirable to duplicate the same switch settings, the controller may write the switch settings back into the five switch registers using the WTM (write to memory) command.

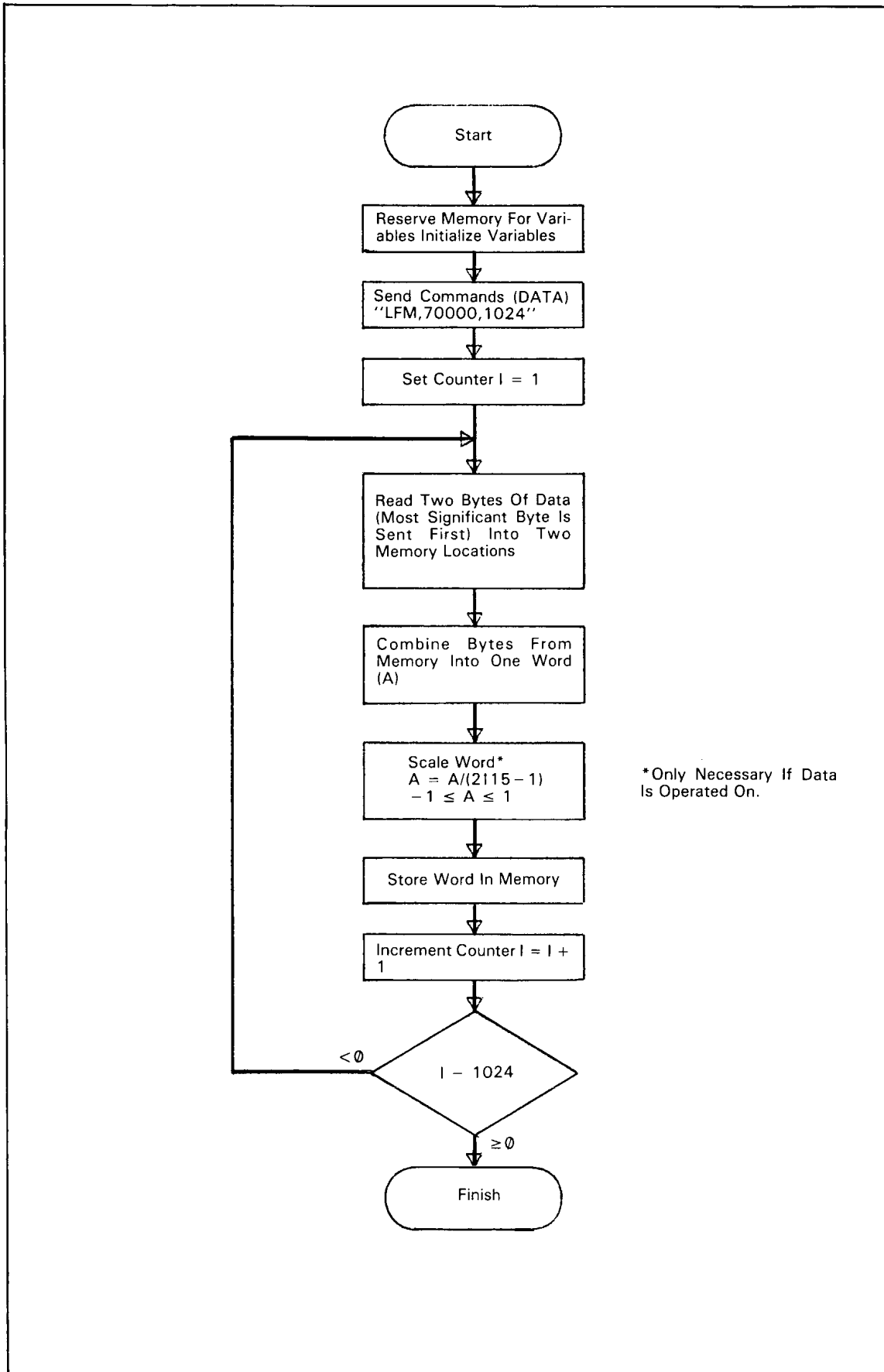

Figure 3-47. Reading Binary Data From Memory.

3-234. Program Example: The Learn Mode (reading and writing to memory).

<pre> -hp- 9825A 0: "program to demo learn mode "; 1: dim A[10] 2: dsp "learn mode demonstrat ion" 3: wrt 711,"LFM, 77454,5" 4: rdb(711)→A[1] 5: for I=2 to 10 6: rdb(711)→A[I] ;next I 7: beep;dsp "swi tch settings learned" 8: wait 1000; beep 9: lcl 711;beep 10: dsp "press cont to reprogr am 3582" 11: stop 12: wrt 711,"WTM ,77454,5" 13: wtb 711,A[1] 14: for I=2 to 10 15: wtb 711,A[I] 16: next I 17: beep;end *8362 </pre>	<p>META Equivalent</p> <p>REMOTE DATA: LFM,77454,5</p> <p>DATA: Most significant 8 bit byte</p> <p>DATA: Least significant 8 bit byte; remaining input alternates between MSB and LSB (bytes)</p> <p>LOCAL</p> <p>REMOTE DATA: WTM,77454,5</p> <p>DATA: Most significant 8 bit byte</p> <p>DATA: Least significant 8 bit byte; remaining output alternates between MSB and LSB (bytes).</p>
---	---

3-235. Program Example: Plotting the Display.

```

-hp- 9825A
0: "program to
  plot and annota
  te display on
  a 9862 plotter"
  :
1: dim A[512],
  A#[130]
2: wrt 711,"LDS"
3: red 711
4: for I=1 to
  256:red 731,
  A[I]
5: next I
6: ent "Ymax",B,
  "Ymin",C
7: scl 1,256,C,B
8: axe 1,C,25.6,
  (B-C)/8
9: plt 1,C,1
10: for I=1 to
  256
11: plt I,A[I]
12: next I
13: wrt 711,"LAN
  ";red 711,A#
14: .97*(B-C)+
  C+E
15: plt 20,E,1;
  csiz ;lbl A#[1,
  32]
16: plt 147,E,1;
  lbl A#[65,96]
17: .93*(B-C)+
  C+E
18: plt 20,E,1;
  lbl A#[33,64]
19: plt 147,E,1;
  lbl A#[97,128]
20: plt 256,B,1;
  end
*13545

```

META Equivalent

REMOTE
DATA: LDSDATA: Each point $\pm N.NNE \pm NN$
separated by commas;
CRLF sent lastDATA: LAN
DATA: 128 ASCII characters, CRLF

OPERATIONAL VERIFICATION TEST CARD

Hewlett-Packard Model 3582A
Spectrum Analyzer
Serial No. _____

Test Performed By _____
Date _____

ROM Self Test: Pass _____ Fail _____

Display Accuracy:

Frequency (Hz)	012500	25000
Reading ± 250 Hz	_____	_____

Calibrator Accuracy:

		Pass	Fail
25 Amplitude Readings	CH A	_____	_____
(1 kHz to 25 kHz) 22.0 ± 0.2 dBV	CH B	_____	_____

Amplitude Accuracy and Flatness:

Frequency (kHz)	CH A (± 0.5)		CH B (± 0.5)	
	2.5	22.5	2.5	22.5
+ 30	_____	_____	_____	_____
Sensitivity + 10	_____	_____	_____	_____
- 10	_____	_____	_____	_____

Noise:

Span		25 kHz	25 kHz	500 Hz
		Noise Floor	Noise Floor	Line Related
	Test	< -85 dB	< -120 dB	Noise < -120 dB
Noise	CHA	_____	_____	_____
	CH B	_____	_____	_____
L.O.	CHA	_____	_____	
Spurs	CH B	_____	_____	

Harmonic Distortion:

Harmonic	CH A		CH B	
	2nd	3rd	2nd	3rd
Amplitude Reading	_____	_____	_____	_____

Common Mode Rejection:

Marker Amplitude Reading		Frequency	CH A	CH B
		< - 66 dB	50 Hz	_____
< - 64 dB	60 Hz	_____	_____	

Frequency Accuracy:

Reading at 25 kHz \pm 0.5 Hz	CH A _____	CH B _____
--------------------------------	------------	------------

Phase Accuracy:

Maximum Variation at 5th Harmonic < \pm 10°	CH A	Pass	Fail
		CH B	_____

Amplitude and Phase Match Between Channels:

Marker Reading	< \pm 0.8 dB	CH A		CH B	
		Pass	Fail	Pass	Fail
Variation	< \pm 5°	_____	_____	_____	_____

SECTION III PART III OPERATIONAL VERIFICATION

3-236. OPERATIONAL VERIFICATION.

3-237. The following set of tests check selected specifications in their worst-case condition to provide a relatively short but high (95%) confidence level verification for proper operation of the 3582A. This verification should be used for incoming inspection and instrument check out after a minor repair has been completed. For complete specification verification, refer to the Performance Test Section.

3-238. Required Test Equipment.

3-239. If the recommended equipment is not available, equipment meeting the critical specifications given in Table 3-5 may be substituted. Listed in Table 3-6 are recommended test accessories.

3-240. Preset.

3-241. Preset refers to a mode in which the 3582A front panel switches should be set prior to the initiation of each test sequence. The switch settings are given as follows (line switch excepted):

Button Positions:  ON  OFF

- Set both framed buttons.....ON
- Set AMPLITUDE A.....ON
- Set SCALE.....10 dB/DIV
- Set PASSBAND SHAPE.....FLAT TOP
- Set AVERAGE NUMBER 4.....ON
- Set all other buttons.....OFF
- AMPLITUDE REFERENCE LEVEL.....NORM (Position 1)
- FREQUENCY MODE.....0-25 kHz
- SPAN.....25 kHz
- TRIGGER LEVEL.....FREE RUN
- INPUT CHANNEL A SENSITIVITY.....+ 30 dBV
- VERNIER.....CAL
- INPUT CHANNEL B SENSITIVITY.....+ 30 dBV
- VERNIER.....CAL
- INPUT MODE.....A

3-242. Instrument Warmup.

3-243. Before any of the Operational Verification tests are performed, be sure that all equipment associated with the test is functioning within specified operating limits. The 3582A requires at least two minutes of warmup before any test is performed.

Table 3-5. Recommended Test Equipment for Operational Verification.

Test	Instrument	Critical Specification	Recommended Model
Amplitude Accuracy and Flatness	Sine wave source	Amplitude accuracy of ± 0.2 dB, flatness (1 kHz – 25 kHz) ± 0.1 dB output ≥ 3.2 V rms into 50 Ω	-hp- 3330B Opt. 005 or -hp- 3320B or -hp- 3325A Opt. 002
Noise Level	Sine wave source	S/N ratio 80 dB or better	-hp- 339A or -hp- 204D
Harmonic Distortion	Sine wave source	All harmonics down at least 80 dB from the fundamental	-hp- 339A
Phase Accuracy	Function Generator	NA	-hp- 3312A or -hp- 3325A
Common Mode Rejection	Sine wave source	NA	Any recommended signal source.
Frequency Accuracy	Sine wave source with counter or Frequency Synthesizer	Frequency accuracy $\pm 0.001\%$ of setting at 25 kHz	-hp- 3330B Opt. 005 or -hp- 3320B or -hp- 3335A

Table 3-6. Recommended Test Accessories.

Description	Part No. (Model No.)
Test Leads: 112 cm (44 in): dual banana both ends 112 cm (44 in): dual banana to BNC	-hp- Model 11000A -hp- Model 11001A
Adapters: Shielded dual banana to BNC male Dual banana to BNC male Dual banana to BNC female	Pamona 1555-C-18 -hp- Part No. 1251-2277 -hp- Model 10110A
Termination: 50 Ω feedthrough 1 k Ω ¼ W 5%	-hp- Model 11048C -hp- Part No. 0683-1025

3-244. Perform the following steps:

- a. Verify that all test equipment is operating under the proper conditions.
- b. Connect the 3582A to a suitable power receptacle using the power cord provided with the instrument. **DO NOT FLOAT THE 3582A USING A POWER PLUG ADAPTER!**
- c. Set the 3582A front panel switches to the preset mode and turn the LINE switch to ON.

d. Allow at least two minutes of warmup time for the 3582A before performing any of the Operational Verification tests.

3-245. DC BAL Verification.

3-246. Before performing any of the following tests, verify that the DC BAL (offset) is not excessively out of adjustment.

3-247. Perform the following steps:

- a. Verify that the 3582A switches are in the preset mode.
- b. Short the input terminals of channel A and set the INPUT SENSITIVITY to 10mV.
- c. Press the TIME A button and verify that the trace is at the center horizontal graticule. If it is not, correct its position by adjusting the channel A BAL control.
- d. Perform steps b and c for channel B after setting the INPUT MODE switch to B, AMPLITUDE A to OFF, and AMPLITUDE B to ON.

3-248. ROM Self Test.

3-249. Because the 3582A is highly dependent upon internal firmware for operation, it is recommended that the ROM Self Test be performed before other tests are initiated. If the test fails, refer to Troubleshooting, Section VIII of the Service Manual.

NOTE

The following test requires that the 3582A be in the LOCAL mode of operation.

3-250. The ROM self test checks the firmware program stored in each ROM by summing together the data bits in a known binary sequence. This sum is then compared to a known result which is stored in the last two locations in each ROM.

3-251. Perform the following steps:

- a. Set AVERAGE NUMBER 32 to ON.
- b. Hold AVERAGE RESTART button in while RESET (orange button) is pressed and then released. Release the AVERAGE RESTART button and press and release it again.
- c. The test will then begin to run as indicated in the upper left-hand corner of the display by a mnemonic RU.
- d. After approximately 5 seconds, the RU will change to OK indicating that the test passed or an ER indicating that the test failed. Press RESET to return the instrument to the normal operating mode.

3-252. Display Accuracy.

3-253. The display accuracy test checks the alignment of the trace, both vertically and horizontally on the CRT graticules.

3-254. Required Test Equipment. None.**3-255. Instrument Control Setup.**

3582A: Preset
 MARKER ON
 SCALE.....2 dB/DIV

3-256. Perform the following steps.

a. The marker is used to check the horizontal trace alignment by positioning it at the left-hand, center and right-hand graticules. The corresponding marker readouts should be within ± 250 Hz of the correct value (0 Hz, 12500 Hz, 25000 Hz).

b. To check the vertical alignment, set the CHANNEL A SENSITIVITY to CAL and the AMPLITUDE REFERENCE LEVEL to position 9 (fully clockwise). Repeat Step a. When finished, return the AMPLITUDE REFERENCE LEVEL to NORM.

3-257. Calibrator Accuracy.

3-258. This procedure checks the level and flatness of the internally generated "CAL" signal.

3-259. Required Test Equipment. None.**3-260. Instrument Control Setup.**

3582A: Preset
 MARKER ON
 SCALE.....2 dB/DIV
 CHANNEL SENSITIVITY (both channels)..... CAL

3-261. Perform the following steps:

a. Move the marker to 1 kHz. The marker level readout should be 22.0 dBV ± 0.2 dB.

b. Set the 1 kHz level as a relative reference by pressing the Marker SET REF button first and the REL button next. Using this relative reference, measure the amplitudes of all other harmonically related spectra displayed (i.e., 2 kHz, 3 kHz, etc.). The levels should be within ± 0.3 dB of the 1 kHz relative reference level.

c. Repeat Steps a and b for channel B after setting the INPUT MODE switch and AMPLITUDE switch for channel B readings.

3-262. Amplitude Accuracy and Flatness.

3-263. This procedure checks the amplitude accuracy and flatness at selected cardinal points in amplitude and frequency. These points exhibit a worse case condition due to the accumulated errors throughout the instrument. Passing this test assures that all other points are at least as accurate as these points.

3-264. Required Test Equipment.

-hp- 3330B Option 005 or 3320B Synthesizer
 Compatible shielded (coax) interconnecting cables with appropriate adapters
 Termination: 50 ohms

3-265. Instrument Control Settings.

3582A: Preset
 MARKER ON

3330B:
 FREQUENCY.....2.5 khz
 AMPLITUDE.....23.01 dBm
 LEVELING (3330B/3320B only).....FAST (ON)

3-266. Perform the following steps.

- a. Connect the output of the 3330B to channel A via suitable cables and adapters and terminate in 50 ohms.
- b. Verify the amplitude accuracy and flatness by performing the operations indicated in Table 3-7.
- c. Connect the 3330B output to channel B. Repeat Step b for channel B by switching the INPUT MODE switch and AMPLITUDE buttons for channel B.

Table 3-7. Amplitude Accuracy and Flatness.

Set 3330B AMPLITUDE dBm 50	Set 3582A SENSITIVITY dBV	Vrms	dBV	Set 3330B FREQUENCY and read MARKER at frequency	
				2.5 kHz	22.5 kHz
22.01	+ 30	2.818	+ 9	+ 9 ± 0.5	+ 9 ± 0.5
22.01	+ 10	2.818	+ 9	+ 9 ± 0.5	+ 9 ± 0.5
2.01	- 10	.2818	- 11	- 11 ± 0.5	- 11 ± 0.5

3-267. Noise Level.

3-268. The noise level test insures that all noise internal to the analyzer is at least 70 dB below full scale. The test requires a source with a signal-to-noise ratio of at least 80 dB.

3-269. Required Test Equipment.

-hp- 339A Distortion Measuring Set
 Compatible shielded (coax) interconnecting cables with appropriate adapters
 Termination: 1 kΩ ¼W 5%, -hp- Part No. 0683-1025

3-270. Instrument Control Settings.

3582A: Preset
 MARKER ON

SENSITIVITY (both channels)..... – 10 dBV
 AVERAGE NUMBER.....32
 FREQUENCY MODE.....0-START

339A:

OSCILLATOR OUTPUT LEVEL.....0.3 V rms
 FREQUENCY..... 25 kHz

3-271. Perform the following steps.

a. Connect the oscillator output of the 339A to channel A of the 3582A terminated with a 1 k Ω resistor. Verify that the output level is set at 0.3 V rms and the 3582A SENSITIVITY is set to – 10 dBV.

b. Set the 339A output level vernier for a full-scale amplitude on the 3582 without overloading the 3582A. Press AVERAGE RMS and RESTART. The progress of the averaging sequence may be observed by temporarily setting the MARKER ON button to OFF. This will cause the average number to be displayed.

c. Use the marker to verify that all frequencies below 25 kHz have noise less than – 85 dBV. Then set the AVERAGE to OFF.

d. Set the 339A output to 3 mV rms. Set the 3582A INPUT SENSITIVITY to – 50 dBV.

e. Repeat Steps b and c verifying that the noise levels are less than – 120 dBV.

f. Set the 3582A SPAN to 500 Hz and repeat Steps d and e to check for line related noise.

g. Repeat Steps a through f for channel B.

h. Set the 3582A SPAN to 25 kHz, MODE to SET CENTER, and INPUT SENSITIVITY to – 10 dBV. Set the FREQUENCY ADJUST control for a center frequency of 5001 Hz. Set AVERAGE to OFF.

i. Set the 339A FREQUENCY to 5 kHz and the output to 0.3 V rms.

j. Repeat Steps b through e verifying that all non-harmonically related noise (do not include 0 Hz and negative frequencies) is within the stated limits. This test checks for Digital Local Oscillator spurs.

3-272. Harmonic Distortion.

3-273. The harmonic distortion test checks for harmonically related signals which are generated within the instrument when a full scale input is present. To perform this test requires a signal source which has a signal with harmonic distortion products less than – 80 dB below the fundamental.

3-274. Required Test Equipment.

-hp- 339A Distortion Measuring Set or 239A Low Distortion Oscillator
 Compatible shielded (coax) interconnecting cables with appropriate adapters

3-275. Instrument Control Settings.

3582A: Preset

SPAN.....50 Hz
 SENSITIVITY (both channels).....0 dBV
 AVERAGE NUMBER.....8
 AVERAGE OFF
 FREQUENCY MODE.....0-START
 MARKER ON

339A:

FREQUENCY.....10 Hz
 OSCILLATOR OUTPUT LEVEL.....1.0 V

3-276. Perform the following steps.

- a. Connect the output of the 339A to both channel A and B via suitable cables and adapters.
- b. Set the MARKER POSITION to 10 Hz and adjust the 339A output level for a full scale display without overloading the 3582A. (This can be done faster with a SPAN of 500 Hz.) Set AVERAGE to TIME and set the TRIGGER LEVEL to achieve consistent triggering. Press MARKER SET REF.
- c. Set the 3582A AMPLITUDE REFERENCE LEVEL to position 2 (NORM is position 1) and press AVERAGE RESTART.
- d. After the average is complete (this takes about 40 seconds), move the marker to the second harmonic. The amplitude of the second harmonic should be less than - 70 dB below full scale.
- e. Repeat Step d for the third harmonic.
- f. Repeat Steps b through e for channel B after switching the INPUT MODE switch and AMPLITUDE buttons for channel B, resetting the AMPLITUDE REFERENCE LEVEL to NORM, and setting AVERAGE to OFF.

3-277. Common Mode Rejection.

3-278. The common mode rejection test verifies the capability of the 3582A to ignore a signal which appears simultaneously and in phase at both input terminals of a single channel.

3-279. Required Test Equipment.

- Any recommended signal source
- Compatible shielded (coax) interconnecting cables with appropriate adapters

3-280. Instrument Control Settings.

3582A: Preset

MARKER ON

Table 2. Code Assignments for "Command Mode" of Operation.
(SENT AND RECEIVED WITH ATN TRUE)

Bits b ₇ b ₆ b ₅ b ₄ b ₃ b ₂ b ₁	COLUMN →		ROW ↓		MSG		MSG		MSG		MSG		MSG		MSG		MSG	
	0	1	0	1	0	1	0	1	0	1	0	1	0	1	0	1	0	1
0 0 0 0	0	1	DLE	DC1	LLO	LLO	SP	0	1	3	0	1	4	0	1	5	6	7
0 0 0 1	0	1	GTL	DC2	STX	STX	"	0	1	2	3	4	5	6	7	8	9	10
0 0 1 0	0	1	ETX	DC3	ETX	#	#	0	1	1	2	3	4	5	6	7	8	9
0 0 1 1	0	1	EOT	DC4	DCL	DCL	\$	0	1	3	4	5	6	7	8	9	10	11
0 1 0 0	0	1	ENQ	NAK	PPU	PPU	%	0	1	4	5	6	7	8	9	10	11	12
0 1 0 1	0	1	ACK	SYN	ACK	&	&	0	1	5	6	7	8	9	10	11	12	13
0 1 1 0	0	1	BEL	ETB	BEL	'	'	0	1	6	7	8	9	10	11	12	13	14
0 1 1 1	0	1	BS	CAN	SPE	((0	1	7	8	9	10	11	12	13	14	15
1 0 0 0	0	1	HT	EM	SPD))	0	1	8	9	10	11	12	13	14	15	
1 0 0 1	0	1	LF	SUB	LF	*	*	0	1	9	10	11	12	13	14	15		
1 0 1 0	0	1	VT	ESC	VT	+	+	0	1	10	11	12	13	14	15			
1 0 1 1	0	1	FF	FS	FF	,	,	0	1	11	12	13	14	15				
1 1 0 0	0	1	CR	GS	CR	-	-	0	1	12	13	14	15					
1 1 0 1	0	1	SO	RS	SO	.	.	0	1	13	14	15						
1 1 1 0	0	1	SI	US	SI	/	/	0	1	14	15							
1 1 1 1	0	1				/	/	0	1	15								

- NOTES:
- ① MSG = INTERFACE MESSAGE
 - ② b₁ = DIO1 ... b₇ = DIO7
 - ③ REQUIRES SECONDARY COMMAND
 - ④ DENSE SUBSET (COLUMN 2 THROUGH 5). ALL CHARACTERS USED IN BOTH COMMAND & DATA MODES.

ADDRESSED COMMAND GROUP (ACG) UNIVERSAL COMMAND GROUP (UCG) LISTEN ADDRESS GROUP (LAG) TALK ADDRESS GROUP (TAG) PRIMARY COMMAND GROUP (PCG) SECONDARY COMMAND GROUP (SCG)

HP-IB

Parallel Poll.

Parallel polling permits the status of up to eight devices on the HP-IB to be checked simultaneously. The operator assigns each device a data line (DIO1 thru DIO8) which the device sets low during the parallel poll routine if it requires service. More devices can be handled, if desired, by sharing the use of each DIO line.

The parallel polling function requires the controller to periodically poll the instruments connected to the Bus. The controller interrogates (polls) the instruments by sending an EOI with ATN activated. When either EOI or ATN is removed, the controller stops polling.

Code Summary.

A code assignment summary is shown in Table 2. These assignments apply only when operating in "Command Mode".

In "Data Mode" there are no specific code assignments. However, the devices communicating in this mode must agree on the meaning of the codes they use.

The set of codes labeled "Primary Command Group" are the codes commonly used to communicate on the HP-IB. The "Secondary Command Group" is used when addressing extended listeners and talkers, or enabling the Parallel Poll Mode.

Other Bus Lines.

The three remaining HP-IB lines and their functions are:

- REN (Remote Enable) – The system controller sets REN low and then addresses the devices to Listen before they will operate under remote control.
- IFC (Interface Clear) – Only the system controller can activate this line. When IFC is set (true) all talkers, listeners and active controllers go to their inactive states.
- EOI (End or Identify) – This line is used to indicate the end of a multiple byte transfer sequence or, in conjunction with ATN, to execute a parallel polling sequence.

NOTE

Individual instruments, at power-on, can momentarily set the IFC line to a true state.

Address Codes.

Devices with the functional capability of talker normally recognize a single byte address*. A certain group of ASCII seven-bit bytes is reserved for talk addresses (refer to Table 3). The state of the eighth bit is ignored in the "Command Mode" when addresses are being transmitted. Each device has a unique talk address which can normally be modified. The Talk Address, bits one through five, are individually selected in each device to be either high or low. The selection of these bits allows changing the device talk and/or Listen address.

Devices with the functional capability of Listener normally recognize a single character address**. The seven-bit codes reserved for Listen addresses are listed in Table 3. Each device has a unique listen address which can normally be modified.

NOTE

Bits 6 and 7 determine whether the "address" is a "listen" or "talk" address (see Table 3).

*An "extended talker" is capable of recognizing a two byte talk address.

**An "extended listener" is capable of recognizing a two byte listen address.

Devices with both talk and listen addresses have these addresses assigned in pairs, eg., if the fourth address in the column of listen addresses "F" is selected, the talk address is "C", the fourth address in the talker address column. The talk address is automatically changed whenever the listen address is changed and vice versa. Addresses are normally alterable by the use of switches or jumpers within the instrument.

Table 3. Address Codes.

Listen Addresses									Talk Addresses								
Bits								ASCII Character	Bits								ASCII Character
b ₈	b ₇	b ₆	b ₅	b ₄	b ₃	b ₂	b ₁		b ₈	b ₇	b ₆	b ₅	b ₄	b ₃	b ₂	b ₁	
X	0	1	0	0	0	0	0	SP	X	1	0	0	0	0	0	0	@
X	0	1	0	0	0	0	1	!	X	1	0	0	0	0	0	1	A
X	0	1	0	0	0	1	0	"	X	1	0	0	0	0	1	0	B
X	0	1	0	0	0	1	1	#	X	1	0	0	0	0	1	1	C
X	0	1	0	0	1	0	0	S	X	1	0	0	0	1	0	0	D
X	0	1	0	0	1	0	1	%	X	1	0	0	0	1	0	1	E
X	0	1	0	0	1	1	0	&	X	1	0	0	0	1	1	0	F
X	0	1	0	0	1	1	1	'	X	1	0	0	0	1	1	1	G
X	0	1	0	1	0	0	0	{	X	1	0	0	1	0	0	0	H
X	0	1	0	1	0	0	1	}	X	1	0	0	1	0	0	1	I
X	0	1	0	1	0	1	0	*	X	1	0	0	1	0	1	0	J
X	0	1	0	1	0	1	1	+	X	1	0	0	1	0	1	1	K
X	0	1	0	1	1	0	0	,	X	1	0	0	1	1	0	0	L
X	0	1	0	1	1	0	1	-	X	1	0	0	1	1	0	1	M
X	0	1	0	1	1	1	0	.	X	1	0	0	1	1	1	0	N
X	0	1	0	1	1	1	1	/	X	1	0	0	1	1	1	1	O
X	0	1	1	0	0	0	0	0	X	1	0	1	0	0	0	0	P
X	0	1	1	0	0	0	1	1	X	1	0	1	0	0	0	1	Q
X	0	1	1	0	0	1	0	2	X	1	0	1	0	0	1	0	R
X	0	1	1	0	1	0	0	3	X	1	0	1	0	0	1	1	S
X	0	1	1	0	1	0	0	4	X	1	0	1	0	1	0	0	T
X	0	1	1	0	1	0	1	5	X	1	0	1	0	1	0	1	U
X	0	1	1	0	1	1	0	6	X	1	0	1	0	1	1	0	V
X	0	1	1	0	1	1	1	7	X	1	0	1	0	1	1	1	W
X	0	1	1	1	0	0	0	8	X	1	0	1	1	0	0	0	X
X	0	1	1	1	0	0	1	9	X	1	0	1	1	0	0	1	Y
X	0	1	1	1	0	1	0	:	X	1	0	1	1	0	1	0	Z
X	0	1	1	1	0	1	1	;	X	1	0	1	1	0	1	1	[
X	0	1	1	1	1	0	0	<	X	1	0	1	1	1	0	0	\
X	0	1	1	1	1	0	1	=	X	1	0	1	1	1	0	1]
X	0	1	1	1	1	1	0	>	X	1	0	1	1	1	1	0)

X = don't care

Handshake Lines.

Each character byte transferred on the HP-IB data lines employs the three-wire handshake sequence. This sequence has the following characteristics:

1. Data transfer is asynchronous – Data can be transferred at any rate suitable for the devices operating on the Bus. (Data rates up to 500 kilobytes per second are typical; with a maximum of 1 megabyte per second).
2. Devices with different input/output speeds can be interconnected. Data transfer rate automatically adjusts to slowest active device.
3. More than one device can accept data at the same time.

The following definitions are used throughout the remaining text.

Source – A device transmitting information on the Bus in either the Command or Data Mode.

Talker – An “addressed” source in the Data Mode only.

Acceptor – A device receiving information on the Bus in either the Command or Data Mode.

Listener – An “addressed” acceptor in the Data Mode only.

The Data Transfer or “HANDSHAKE” lines are shown in Figure 1. The mnemonics of each line have the following meanings:

DAV – Data Valid
NRFD – Not Ready for Data
NDAC – Not Data Accepted

The handshake timing sequence is illustrated in Figure 2.

Each data byte transferred by the interface system uses the handshake process when exchanging data between source and acceptor. The handshake timing sequence is illustrated in Figure 2. In Data Mode, the source is a Talker and the acceptor is a Listener.

The timing diagram illustrates the handshake process by indicating the actual waveforms on the DAV, NRFD, and NDAC lines. The NRFD and NDAC signals each represent composite waveforms resulting from two or more Listeners accepting the same data byte at slightly different times. This is usually due to variations in the transmission path length and individual instrument response rates (delays).

The flow chart represents the same sequence of events in a different form.

The subscripted letters on the flow chart and the timing diagram refer to the same event on the list of events.

HANDSHAKE line timing diagram for one talker and multiple listeners using the handshake process. Two cycles of the handshake sequence are shown. Also refer to the flow diagram and list of events on this figure.

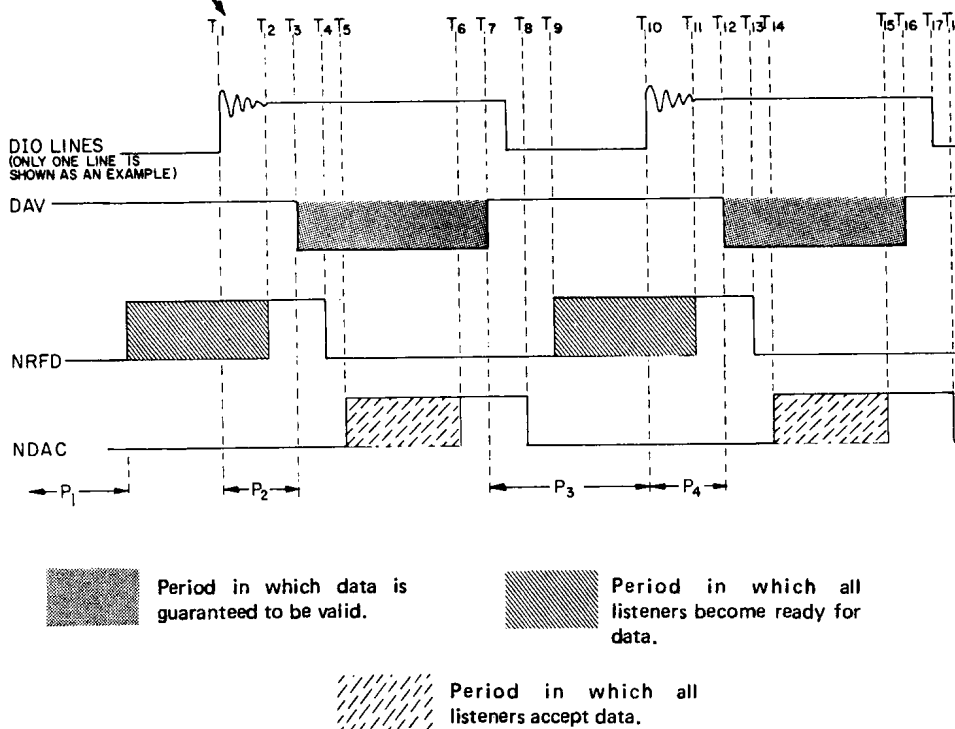

List of Events for Handshake Process

- Source initializes DAV to high (False - data not valid).
- P₁ - Acceptors initialize NRFD to low (True - none are ready for data), and set NDAC to low (True - none have accepted the data).
- T₁ - Source checks for error condition (both NRFD and NDAC high), then places data byte on DIO lines.
- P₂ - Source delays to allow data to settle on DIO lines.

Figure 2. Handshake Timing Sequence.

T ₂	Acceptors have all indicated readiness to accept first data byte; NRFD goes high.
T ₃	When the data is settled and valid, and the source has sensed NRFD high, DAV is set low.
T ₄	First acceptor sets NRFD low to indicate that it is no longer ready, then accepts the data. Other acceptors follow at their own rates.
T ₅	First acceptor sets NDAC high to indicate that it has accepted the data. (NDAC remains low due to other acceptors driving NDAC low).
T ₆	Last acceptor sets NDAC high to indicate that it has accepted the data; all have now accepted and NDAC goes high.
T ₇	Source, having sensed that NDAC is high, sets DAV high. This indicates to the acceptors that data on the DIO lines must now be considered not valid. Upon completion of this step, one byte of data has been transferred.
P ₃ (T ₇ -T ₁₀)	Source changes data on the DIO lines.
T ₈ *	Acceptors, upon sensing DAV high set NDAC low in preparation for next cycle. NDAC goes low as the first acceptor sets it low.
T ₉	First acceptor indicates that it is ready for the next data byte by setting NRFD high. (NRFD remains low due to other acceptors driving NRFD low).
T ₁₀	Source checks for error condition (both NRFD and NDAC high), then places data byte on DIO lines (as at T ₁).
P ₄ (T ₁₀ -T ₁₂)	Source delays to allow data to settle on DIO lines.
T ₁₁	Last acceptor indicates that it is ready for the next data byte by setting NRFD high; NRFD signal line goes high.
T ₁₂	Source, upon sensing NRFD high, sets DAV low to indicate that data on DIO lines is settled and valid.
T ₁₃	First acceptor sets NRFD low to indicate that it is no longer ready, then accepts the data.
T ₁₄	First acceptor sets NDAC high to indicate that it has accepted the data.
T ₁₅	Last acceptor sets NDAC high to indicate that it has accepted the data (as at T ₆).
T ₁₆	Source, having sensed that NDAC is high, sets DAV high (as at T ₇).
T ₁₇	Source removes data byte from DIO signal lines after setting DAV high.
T ₁₈ *	Acceptors, upon sensing DAV high, set NDAC low in preparation for next cycle.
	* Note that all three handshake lines return to their initialized states, as at T ₁ and T ₂ .

Figure 2. Handshake Timing Sequence (cont'd).

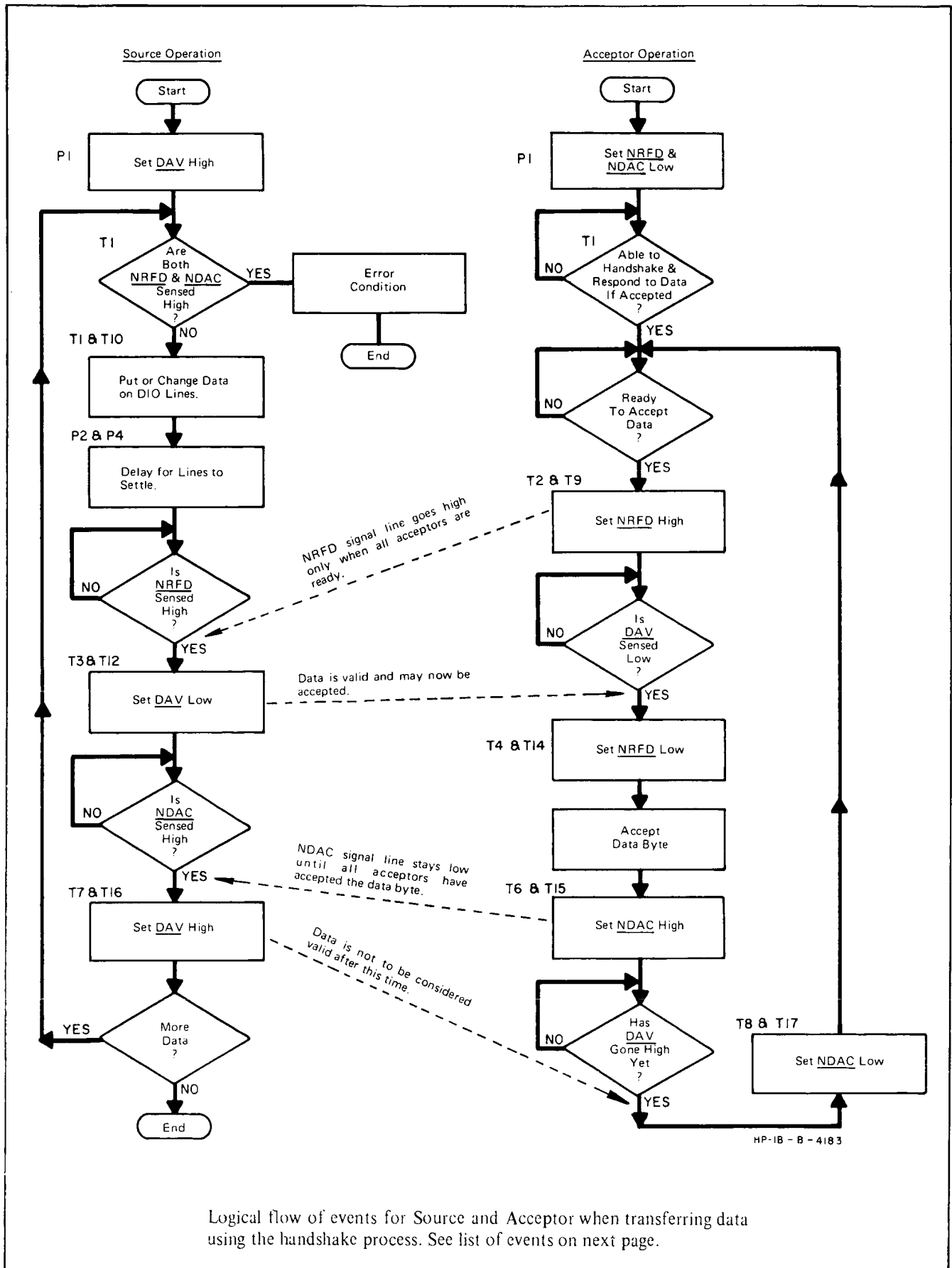

Logical flow of events for Source and Acceptor when transferring data using the handshake process. See list of events on next page.

Figure 2. Handshake Timing Sequence (cont'd).

Data Lines.

A set of eight interface lines is available to carry all seven bit interface messages and device dependent messages. These are DATA INPUT OUTPUT lines, DIO1 through DIO8. Only seven lines are required for transfer of data. The eighth line is usually used for a parity check. The data on the DIO lines is transferred in a bit parallel, byte serial form, asynchronously and bidirectionally.

a. Data Mode –

When ATN (attention) goes high (false), the HP-IB is in the “Data Mode”. In this mode data may be transferred between devices that were addressed when the HP-IB was in “Command Mode”. Messages that can be transferred in “Data Mode” include:

1. Programming Instructions –

Codes are seven bit bytes placed on the HP-IB data (DIO) lines. The meaning of each byte is device dependent and is selected by the equipment designer. These types of messages are usually between the controller acting as the talker and a single device that has been addressed as a listener.

2. Data Codes –

Data codes are seven-bit bytes placed on the data lines. The meaning of each byte is device dependent. For meaningful communication to occur, both the talker and listener must agree on the meaning of the codes they use.

Data Byte.

Individual data bytes transmitted on the HP-IB can be described in an octal code. The binary bits are separated into groups of three starting from the right-hand side (see Table 3). Within the groups each binary bit is assigned a weight – “1”, “2” and “4” respectively. The octal numbers corresponding to each group of bits is the summation of the weights of the binary ones in each group.

NOTE

In Table 3 the hundreds group has two bits rather than three since there are eight data lines. When seven-bit character ASCII code is used the hundreds group contains only one bit which can take on the octal value of “0” or “1”.

Table 4. Octal Code Conversion.

Bits	b ₈	b ₇	b ₆	b ₅	b ₄	b ₃	b ₂	b ₁	Octal Code
Weights	“2” “1” (Hundreds)		“4” “2” “1” (Tens)			“4” “2” “1” (Ones)			
	1	0	0	1	1	0	1	0	2 3 2
	1	1	1	1	1	0	0	0	3 7 0
	0	1	0	0	1	0	1	1	1 1 3
	0	0	0	1	0	1	1	1	0 2 7

INTERFACE.

A list of the available functions is given in Table 5. Every HP-IB compatible device is able to perform at least one function on the HP-IB. Devices ignore all commands relating to functions they do not have.

Example:

An HP-IB compatible programmable voltage source includes the "listen function" so that it can be programmed to accept data. However, it does not output information so it does not include a "talk function". Therefore, the programmable voltage source would ignore all information on the HP-IB pertaining to the "talk function".

Table 5. HP-IB Instrument Interface Functions.

Interface Functions that may be included in an HP-IB device.	Comments
Source Handshake	This functional capability must be included in any device that can be a "talker" on the bus.
Acceptor Handshake	This functional capability must be included in all devices that can be "listeners".
Talker or Extended Talker*	Capability required for a device to be a "talker".
Listener or Extended Listener*	Capability required for a device to be a "listener".
Service Request	This capability permits a device to asynchronously request service from the controller.
Remote/Local	Provides capability to select between two sources of input information. Local corresponds to front panel controls and remote to the input information from the bus.
Parallel Poll	Provides capability for a device to uniquely identify itself if it requires service and the controller is requesting a response. This capability differs from service request in that it requires a commitment of the controller to periodically conduct a parallel poll.
Device Clear	This function allows a device to be initialized to a pre-defined state. A device with this capability will have the effect of this command described in its operating manual.
Device Trigger	This function permits a device to have its basic (measurement) operation initiated by the talker on the Bus.
Controller	This function permits a device to send addresses, universal commands and addressed commands to other devices on the HP-IB. It may also include the ability to conduct parallel polling to determine devices requiring service.

*Extended Talker and Extended Listener provide increased address capability. Devices with this functional capability recognize addresses that are two bytes in length rather than just one byte.

Bus Operating Considerations.

- a. When a device capable of activating IFC is powered on during system operation, it may cause the active controller on the Bus to relinquish control, resulting in errors. The Controller must transmit IFC to regain active Control.
- b. Prior to addressing new listeners it is recommended that all previous listeners be unaddressed using the Unlisten Command (?).
- c. Only one talker can be addressed at a time. When a new talker is addressed the former talker is automatically unaddressed.
- d. The maximum accumulative length of the HP-IB cable in any system must not exceed more than 2 meters of cable per device or 20 meters, whichever is less.
- e. For additional programming information consult the HP-IB User Guide for the appropriate calculator.

HP-IB Connector.

Figure 3 shows the pin configuration of the HP-IB Connector.

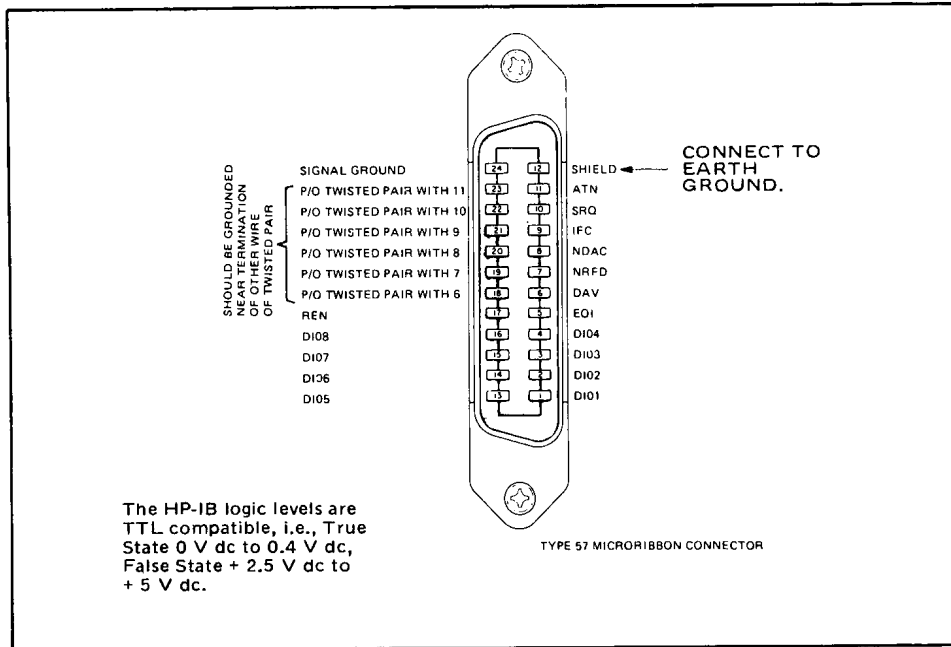

Figure 3. HP-IB Connector.

System Configurations.

HP-IB Systems can be categorized into three types:

- 1. Systems with no controller –

The mode of data transfer is limited to a direct transfer between one device manually set to "talk only" and one or more devices manually set to "listen only" to form a very basic fixed network system.

- 2. Systems with a single controller –

The modes of data transfer for these systems are:

- a. Direct transfer between talkers and listeners (Data Mode).
- b. Transfer from a device to a controller (Data Mode).
- c. Transfer from a controller to a device (Command Mode).

3. Systems with multiple controllers –

The modes of data transfer for these systems are the same as those listed in 2. In addition a method of passing control from one controller to another is required. One controller must be designated as the system controller. The system controller is the only device that can control the HP-IB lines designated IFC (Interface Clear) and REN (Remote Enable). When the system controller sets IFC low, all I/O operations cease and all talkers, listeners and controllers are unaddressed. Control is passed to a different controller by addressing it as a talker and commanding it to “take control” (Octal code 011).

- ACCEPTOR**—A device receiving information on the Bus in either the Command or Data Mode (Also, see Source).
- ADDRESS**—A 7-bit code applied to the HP-IB in “Command Mode” which enables instruments capable of responding to listen and/or talk on the Bus.
- ADDRESSED COMMANDS**—These commands allow the Bus controller to initiate simultaneous actions from addressed instruments which are capable of responding.
- ATN**—Mnemonic (Attention) referring to the “Command Mode” of operation on the HP-IB, or the control line which places the HP-IB in this mode. Also used with EOI for parallel polling.
- BIT**—The smallest part of an HP-IB character (Byte) which contains intelligible information.
- BUS COMMANDS**—A group of Special Codes which initiate certain types of operation in instruments capable of responding to these codes. Each instrument on the HP-IB is designed to respond to those codes that have useful meaning to the device and ignore all others.
- BYTE**—An HP-IB character sent over the DIO lines, normally consisting of seven-bits.
- COMMAND MODE**—In this mode devices on the HP-IB can be addressed or unaddressed as talkers or listeners. Bus commands are also issued in this mode.
- CONTROLLER**—Any device on the HP-IB which is capable of setting the ATN line and addressing instruments on the Bus as talkers and listeners. (Also see System Controller.)
- DEVICE CLEAR (DCL)**—ASCII character “DC4” (Octal 024) which, when sent on the HP-IB will return all devices capable of responding to pre-defined states. See Table E-3.
- DATA MODE**—The HP-IB is in this mode when the control line “ATN” is high (false). In this mode data or instructions are transferred between instrument on the HP-IB.
- DAV**—Mnemonic referring to the handshake line “Data Valid” on the HP-IB. This signal is used in the HP-IB “Handshake” sequence. See Table C-1.
- DIO**—Mnemonic referring to the eight “Data Input/Output” lines of the HP-IB.
- EOI**—Mnemonic referring to the control line “End or Identify” on the HP-IB. This line is used to indicate the end of a multiple byte message on the Bus. It is also used with ATN in parallel polling to transfer the poll response bits from polled devices to the bus.
- EXTENDED LISTENER**—An instrument which requires two HP-IB bytes to address it as a listener. (Also see Listener.)
- EXTENDED TALKER**—An instrument which requires two HP-IB bytes to address it as a talker. (Also see Talker.)
- GO TO LOCAL (GTL)**—ASCII character “SOH” (Octal 001) which, when sent on the HP-IB, will return devices addressed to listen and capable of responding back to local control.
- GROUP EXECUTE TRIGGER (GET)**—ASCII character “BS” (Octal 010) which, when sent on the HP-IB, initiates simultaneous actions by devices addressed to listen and capable of responding to this command.

HANDSHAKE – Refers to the sequence of events on the HP-IB during which each data byte is transferred between addressed devices. The conditions of the HP-IB handshake sequence are as follows:

- a. **NRF**D, when false, indicates that a device is ready to receive data.
- b. **DAV**, when true, indicates that data on the DIO lines is stable and available to be accepted by the receiving device.
- c. **NDAC**, when false indicates to the transmitting device that data has been accepted by the receiver.

HP-IB – An abbreviation that refers to the “Hewlett-Packard Interface Bus”.

IFC – Mnemonic referring to the Control line “Interface Clear” on the HP-IB. Only the system controller can activate this line. When IFC is set (true) all talkers and listeners on the HP-IB are unaddressed, and controllers go to the inactive state.

LISTENER – A device which has been addressed to receive data or instructions from other instruments on the HP-IB. (Also see Extended Listener.)

LOCAL LOCKOUT – ASCII character “DC1” (Octal 021) which, when sent on the HP-IB, disables the front panel controls of responding devices.

NDAC – Mnemonic referring to the control line “Data Not Accepted” on the HP-IB. This line is used in the “Handshake” sequence.

NRFD – Mnemonic referring to the control line “Not Ready For Data” on the HP-IB. This line is used in the HP-IB “Handshake” sequence.

PARALLEL POLLING – A method of simultaneously checking status on up to eight instruments on the HP-IB. Each instrument is assigned a DIO line with which to indicate whether it requested service or not.

PRIMARY COMMANDS – The group of ASCII characters which are typically used on the HP-IB (see Table 5).

REN – Mnemonic referring to the control line “Remote Enable” on the HP-IB. This line is used to enable Bus compatible instruments to respond to commands from the controller or another talker. It can be issued only by the system controller.

SECONDARY COMMANDS – The group of ASCII characters which are used to increase the address length of extended talkers and listeners to two bytes.

SELECTIVE DEVICE CLEAR – ASCII character “EOT” (Octal 004) which, when sent on the HP-IB, returns addressed devices capable of responding to a predetermined state.

SERIAL POLLING – The method of sequentially determining which device connected to the HP-IB has requested service. Only one instrument is checked at a time.

SERIAL POLL DISABLE (SPD) – ASCII character “EM” (Octal 031) which, when sent on the HP-IB, will cause the Bus to go out of serial poll mode.

SOURCE – A device transmitting information on the Bus in either the Command or Data Mode (also see Acceptor).

HP-IB

SRQ – Mnemonic referring to the control line “Service Request” on the HP-IB. This line is set low (true) by any instrument requesting service.

SYSTEM CONTROLLER – This is an instrument on the HP-IB which has all the features of a standard controller with the added ability to control the IFC and REN lines. (Also see Controller.)

TALKER – A device that has been addressed to transmit data on the HP-IB. (Also see Extended Talker.)

UNADDRESS COMMANDS – These commands are obeyed by all addressable devices. This category consists of the Unlisten Command (?) and the Untalk Command (–). When the Unlisten Command (?) is transmitted on the HP-IB, all devices on the Bus will be unaddressed as listeners. When the Untalk Command (–) is transmitted, all devices will be unaddressed as talkers.

UNIVERSAL COMMANDS – These commands affect every device capable of responding on the HP-IB, regardless of whether they have been addressed or not; e.g., Serial Poll Enable (SPE) and Serial Poll Disable (SPD).

UNLISTEN COMMAND – See “UNADDRESS COMMANDS”.

UNTALK COMMAND – See “UNADDRESS COMMANDS”.

APPENDIX C

CONDENSED DESCRIPTION OF META MESSAGES AS THEY APPLY TO THE 3582A

MESSAGE CONCEPTS.

Devices which communicate along the interface bus are transferring quantities of information from one device to one or more other devices. These quantities of information are called messages. Most of the messages consist of two basic parts—the address portion specified by the controller and the information that comprises the message. In turn, the messages can be classified into twelve types. The twelve types of messages are defined in Table C-1.

Table C-1. Definition of Meta Messages.

Message	Definition
DATA	The actual information (binary bytes) which is sent from a talker to one or more listeners. The information or data can be in a numeric form or a string of characters.
TRIGGER	The trigger message causes the listening device(s) to perform a device-dependent action.
CLEAR	A clear message will cause a device(s) to return to a pre-defined device-dependent state.
REMOTE	The remote message causes the listening device(s) to switch from local front panel control, to remote program control. This message remains in effect so that devices subsequently addressed to listen will go into remote operation.
LOCAL	This message clears the remote message from the listening device(s) and returns the device(s) to local front panel control.
LOCAL LOCKOUT	The local lockout message is implemented to prevent the device operator from manually inhibiting remote program control.
CLEAR LOCKOUT AND SET LOCAL	This message causes all devices to be removed from the local lockout mode and revert to local. It will also clear the remote message for all devices.

Table C-1. Definition of Meta Messages (Cont'd).

REQUIRE SERVICE	A device can send this message at any time to signify that it needs some type of interaction with the controller. The message is cleared by the device's status byte message if it no longer requires service.
STATUS BYTE	A byte that represents the status of a single device. One bit indicates whether the device sent the required service message and the remaining 7 bits indicate operational conditions defined by the device. This byte is sent from the talking device in response to a "Serial Poll" operation performed by a controller.
STATUS BIT	<p>A byte that represents the operational conditions of a group of devices on the bus. Each device responds on a particular bit of the byte thus identifying a device dependent condition. This bit is typically sent by devices in response to a parallel poll operation.</p> <p>The status bit message can also be used by a controller to specify the particular bit and logic level that a device will respond with when a parallel poll operation is performed. Thus more than one device may respond on the same bit.</p>
PASS CONTROL	This message transfers the bus management responsibilities from the active controller to another controller.
ABORT	The system controller sends the abort message to unconditionally assume control of the bus from the active controller. The message will terminate all bus communications but does not implement the clear message.

INSTRUMENT RESPONSE TO MESSAGES.

Table C-2 indicates the messages and required bus actions which the 3582A is capable of implementing.

HP-IB WORKSHEET.

The HP-IB Worksheet provided in the back of this appendix and Table C-3 can be used to determine the capabilities of this instrument and other instruments participating in the HP-IB System. The sheet should be filled in with message applicability for the controller and each HP-IB device. When the sheet has been completely filled out, the system HP-IB Capabilities will be defined for the system.

HP-IB ADDRESSING.

Certain Meta Messages require that a specific listener and talker be designated on the bus. Each instrument on the bus has its own distinctive listen and talk address. The device address provides the identity to distinguish it from other devices on the bus. The instrument receives programming instructions when addressed to listen. When addressed to talk, the in-

Table C-2. 3582A Implementation of Messages.

Message	Implementation	Interface Functions**		3582A Response
		Sender	Receiver	
DATA	SR	T,SH	L ⁿ ,AH	Send or receive data as instructed
TRIGGER CLEAR	NA			
	R	ID-LIST C,SH	DC ⁿ ,L,AH	Performs the same function as the "reset" button on the front panel.
REMOTE	R	REMOTE ENABLE ID LIST,C _s ,SH	RL ⁿ ,L,AH RL,AH	Goes to remote. Can be set to local by local key.
LOCAL	R	C _s ,SH	RL ⁿ ,AH	Goes to local.
LOCAL LOCKOUT	R	C,SH	RL,AH	Goes to remote. Cannot be set to local by local key.
CLEAR LOCKOUT and SET LOCAL	R	C,SH,C _s	RL	Goes to local from local lockout.
REQUIRE SERVICE	S		C	Set SRQ true.
STATUS BYTE	NA			
STATUS BIT	NA			
PASS CONTROL	NA			
ABORT	NA			

*
 S = Send Only
 R = Receive Only
 SR = Send and Receive
 NA = Not Applicable

**
 SH = Source Handshake
 AH = Acceptor Handshake
 T = Talker
 L = Listener
 SR = Service Request
 RL = Remote/Local
 PP = Parallel Poll
 DC = Device Clear
 DT = Device Trigger
 C = Any Controller
 C_n = A Specific Controller (i.e., CA, CB, -)
 C_s = System Controller
 Xⁿ = Indicates Replication n Times

strument can output measurement data or send programming instructions if it is also the system controller. The address is set via jumpers or switches. Refer to Table C-3 for the allowable program codes.

Table C-3. Address Selection.

ASCII Code Character		Address Switches					5-bit Decimal Code
Listen	Talk	A5	A4	A3	A2	A1	
SP	@	0	0	0	0	0	00
!	A	0	0	0	0	1	01
"	B	0	0	0	1	0	02
#	C	0	0	0	1	1	03
\$	D	0	0	1	0	0	04
%	E	0	0	1	0	1	05
&	F	0	0	1	1	0	06
'	G	0	0	1	1	1	07
(H	0	1	0	0	0	08
)	I	0	1	0	0	1	09
*	J	0	1	0	1	0	10
+	K	0	1	0	1	1	11
,	L	0	1	1	0	0	12
-	M	0	1	1	0	1	13
.	N	0	1	1	1	0	14
/	O	0	1	1	1	1	15
0	P	1	0	0	0	0	16
1	Q	1	0	0	0	1	17
2	R	1	0	0	1	0	18
3	S	1	0	0	1	1	19
4	T	1	0	1	0	0	20
5	U	1	0	1	0	1	21
6	V	1	0	1	1	0	22
7	W	1	0	1	1	1	23
8	X	1	1	0	0	0	24
9	Y	1	1	0	0	1	25
:	Z	1	1	0	1	0	26
;	[1	1	0	1	1	27
<	\	1	1	1	0	0	28
=]	1	1	1	0	1	29
>	~	1	1	1	1	0	30

1 POSITION (UP)
0 POSITION (DOWN)

Since each instrument has its own distinctive address, HP-IB programming requires that an address be designated when attempting to send information to, or receive information from, an individual instrument. An address is usually in the form of:

universal unlisten, device talk, device listen

The universal unlisten command removes all listeners from the bus, thus allowing only the specific listener(s) designated by the device listen parameter, to receive information. The information is sent by a talker which is designated by the device talk parameter. In many controllers this type of basic bus addressing is taken care of automatically.

INSTRUMENT PROGRAMMING.

The Instrument Programming section provides the basic information and programming techniques to control the -hp- 3582A via Remote programming. The first and most important step for the user is to completely define the measurement the instrument will be making. The next step is to define the measurement requirements in terms the instrument can use. These terms are called Program Codes. They are device-dependent since each instrument has its own set of Program Codes. The Program Codes are ASCII characters which are transmitted to the instrument via the HP-IB.

The final step is to write the problem and solution down in the order it should be performed in (an algorithm) and then convert the Algorithm into controller language.

Once the algorithm for the program has been completed, it can be converted to code. The conversion to code requires the conversion charts or block diagram for Meta Messages as mentioned before, plus the understanding of the instrument program codes.

NOTE

The Meta Message in itself is not a program code or an HP-IB command. It is only intended to be an uncomplicated means to translate a program written as an algorithm into the controller's code.

For detailed controller/instrument programming codes, refer to the Operating Notes on the specific controller (-hp- XXXX). These Operating Notes are available from your local -hp- Sales and Service Office.

The Meta Message Block diagrams show which bus signals are required for a particular message. Note that some controllers may be able to implement the function with a single character or code or it may take several lines of code.

ALGORITHM.

The Algorithm written for the instrument will express exactly how to set up and implement the instrument measurement or function. In order to make the transition from algorithm to program code as simple as possible, the user should use the twelve Meta Messages as key words.

These Messages may be directly converted to code using an -hp- calculator manual. The -hp- 9825A Calculator Extended I/O Manual provides a one-to-one chart for program code conversion. In cases where the controller used with the instrument does not have a conversion chart, the user may refer to the block diagram associated with each Meta Message located in the expanded Meta Message topic. The block diagrams show the bus signals required to implement each message. Note that this is only required when a conversion chart is not available.

An example application and program algorithm using an -hp- 3582A instrument and the Meta Messages is shown below. Note that the algorithm emphasizes the key words and does not employ any code. The application problem the algorithm is written for can be described as:

A system employing a single controller and three instruments consisting of an Analyzer, scanner, and printer are to measure the outputs of ten relays. The ten relays should close singly and then remain closed so that at the end of the measurement sequence all ten relays are closed.

The program should print out the reading after the measurement cycle is complete. The program should also completely abort operations if there is a problem with the Analyzer. If the Scanner errors, the controller should generate an error message to the printer.

1. ABORT all previous operations.
2. Set the Analyzer to REMOTE.
3. LOCAL LOCKOUT the Analyzer.

4. Send DATA to configure the Analyzer to:
 PRESET
 NON-REPETITIVE
 MARKER ON, MARKER POSITION
5. Send DATA to Scanner in order to close relay 1.
6. Send DATA to configure the Printer to:
 Begin printing at top of page
 2" width of printing
 Characters $\frac{1}{4}$ standard size
7. Send DATA to ARM the trigger in the Analyzer.
8. Send the DATA measurement to the controller and store in an array.
9. Send DATA to Scanner to increment the relay closure by 1.
10. Check Analyzer and Scanner to see if they REQUIRE SERVICE.
11. If REQUIRE SERVICE, check STATUS BYTE; otherwise skip next step.
12. If Analyzer sent SRQ indicating it did REQUIRE SERVICE, end program;
 otherwise send DATA to the Printer to indicate an error in the Scanner.
13. Return to ARM step and continue incrementing the relay closure until all 10
 relays have been measured.
14. Send the DATA array to Printer for printout.
15. CLEAR LOCKOUT and SET LOCAL.
16. End program.

EXAMPLE PROGRAM WITH CODE.

The example Algorithm is implemented by this means:

- a. HP-IB Format Only
- b. 9825A controller syntax

In all three cases the numbers will directly correspond to each other. The Algorithm describes a single measurement made by the Analyzer using the Scanner as a source.

- a. Send DATA to the Scanner to close relay 1.
- b. Send DATA to configure the Analyzer to:

Preset
 Non-Repetitive
 Marker on
 Marker location

c. Arm the Analyzer and prepare it to transfer the Marker amplitude and frequency by sending DATA characters "AR", "LMK".

- d. Send the DATA from the Analyzer to the Calculator.

<u>Program (talk, listen)</u>	<u>Select Code</u>
Address U,5 Calculator -	
K, + Analyzer -	711
/ Scanner -	709

HP-IB FORMAT

Command Mode

Data Mode

- | | |
|--------|------------------------------|
| 1. ?U1 | CI |
| 2. ?U+ | “PRE”, “RP0”, “MN1”, “MP120” |
| 3. ?U+ | “AR”, “LMK” |
| 4. ?VK | ±N.NNNE±NN, ±NNNNN.NNN |

9825A CALCULATOR FORMAT

1. fmt f; wrt 709, “C1”
2. wrt 711, “PRERP0MN1MP120”
3. wrt 711, “AR”, “LMK”
4. fmt e.3, f.3; red 711, A,B

NOTE

In this example, only the DATA Message is implemented. The DATA message is implemented each time a character or group of characters is transmitted over the HP-IB.

META MESSAGES EXPANDED.

This section on Meta Messages provides an in-depth description and flowchart for implementing each specific message that pertains to the -hp- 3582A. Additional information on instrument response to the implementation of each message listed in this section is also provided where required to facilitate programming.

Figure C-1. Message List.

DATA — The DATA message is the actual information (8 bit byte) which is sent from a talker to one or more listeners. This action requires the controller to first enter the command mode to set up the talker and receiver(s) for the transfer of DATA. When the command mode is complete, the information is transmitted when the bus enters the Data Mode.

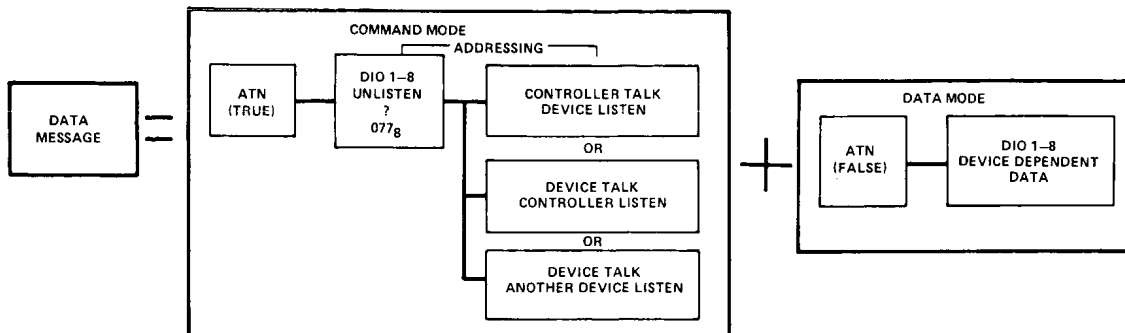
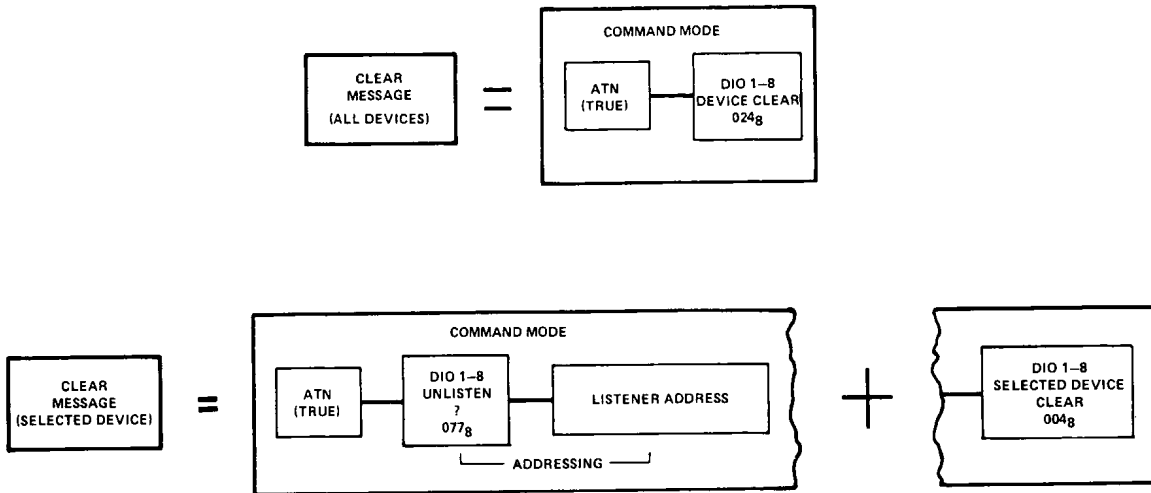
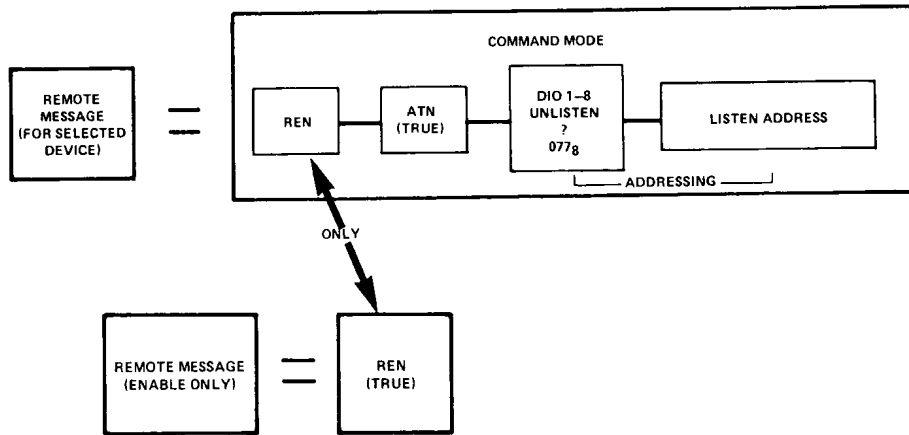

Figure C-1. Message List (Cont'd).

CLEAR – The Clear Message may be implemented for addressed devices or for all devices on the bus capable of responding. In both cases the controller places the bus in the Command Mode to execute the message.



REMOTE – Only the System controller can place the instrument into the Remote Operating condition. To implement the Remote message, the controller will set the REN line true. The HP-IB is then the Enable-Only mode. In the Enable-Only mode, the bus instruments are not in remote but will go into Remote as soon as they are addressed.



LOCAL – The Local Message will remote addressed instruments from remote Operation mode to Local-Front panel control. The controller must place the HP-IB into the command Mode and address all instruments to listen that are to be returned to local. The local message will not remove the bus from the remote mode, only the listening devices.

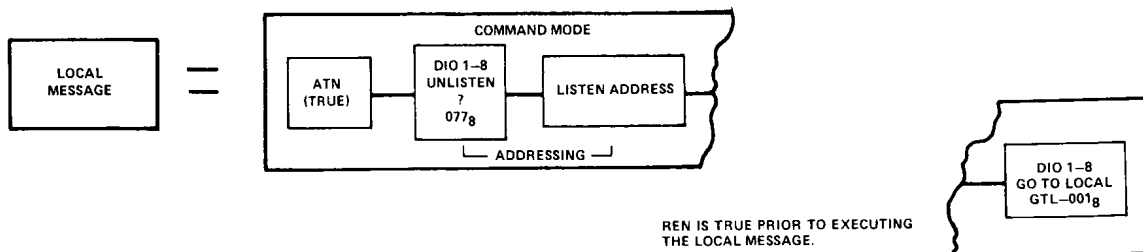
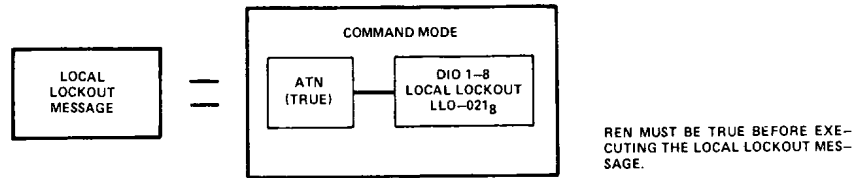
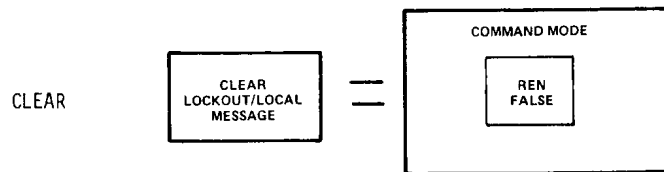

Figure C-1. Message List (Cont'd).

LOCAL LOCKOUT – The Local Lockout Message prevents the instrument operator from placing the instrument into local control from the front panel. The controller must be in the command mode to send the local lockout message.



LOCKOUT AND SET LOCAL – When implemented, this message removes all instruments from the local lockout mode and causes them to revert to local-front panel control. Since the REN line is set false the bus is also in the local mode.



REQUIRE SERVICE – The Require Service Message is implemented by an instrument by causing the HP-IB SRQ line true state. The Require Service message and therefore the SRQ line is held true until a poll is conducted to determine the cause of the request for service or until the device no longer needs service.

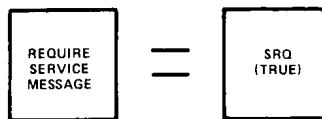

*REFER TO THE STATUS BYTE MESSAGE FOR THE SPECIFICATIONS REQUIRED TO FORCE SRQ FALSE.

MESSAGE		HP-IB IMPLEMENTATION WORKSHEET									
		DEVICE									
		MODEL	LISTEN	TALK	5 BIT VALUE	MODEL	LISTEN	TALK	5 BIT VALUE		
INSTRUMENT IDENTIFICATION AND HP-IB ADDRESS											
DATA											
TRIGGER											
CLEAR											
LOCAL											
REMOTE											
LOCAL LOCKOUT											
CLEAR LO & SET LOCKOUT											
REQUIRE SERVICE											
STATUS BYTE											
STATUS BIT											
PASS CONTROL											
ABORT											

S = SEND ONLY R = RECEIVE ONLY S & R = SEND AND RECEIVE N = NOT IMPLEMENTED

FREQUENCY MODE.....0-START
 SPAN.....100 Hz

3330B (3320B):

AMPLITUDE.....(4.94V)26.89 dBm
 FREQUENCY.....50 Hz
 LEVELING (3330B or 3320B only).....SLOW (ON)

3-281. Perform the following steps.

a. Switch the 3582A ISOL-CHAS switch to ISOL and connect the 3330B output, without a load, to the input of the 3582A channel A.

b. Using the MARKER POSITION control, set the marker to 50 Hz and press the MARKER SET REF button.

NOTES

1. *If not using a Synthesizer, adjust Oscillator frequency.*

2. *The NOISE SOURCE OUTPUT BNC connector may be used for a chassis ground.*

c. Disconnect the 3330B at the input terminal of channel A. Short the input terminals together. Connect the “high” side of the 3330B output to the shorted connection (input terminals) and the “low” side of the 3330B output to the 3582A chassis.

d. Switch the 3582A SENSITIVITY to +10 dBV and press the MARKER REL button. The amplitude reading should be less than -66 dB.

e. Repeat Steps a through d with the 3330B FREQUENCY set to 60 Hz. The reading in Step d should be less than -64 dB.

f. Repeat Steps a through e for channel B by setting the INPUT MODE switch and AMPLITUDE switches for channel B.

g. Disconnect the signal source from the input terminals.

h. Set ISOL-CHAS switch to CHAS.

3-282. Frequency Accuracy.

3-283. The frequency accuracy test checks the frequency measuring capability in the band analysis (SET START, SET CENTER) mode under narrow bandwidth conditions.

3-284. Required Test Equipment.

-hp- 3330B or 3320B or 3325A Synthesizer
 Compatible shielded (coax) interconnecting cables with appropriate adapters
 Termination: 50 ohms

3-285. Instrument Control Settings.

3582A: Preset

SENSITIVITY (both channels).....0.3 V
 SPAN..... 5 Hz
 FREQUENCY MODE.....SET CENTER
 FREQUENCY ADJUST..... 25 kHz
 MARKER ON
 SCALE LINEAR

3330B:

FREQUENCY..... 25 kHz
 AMPLITUDE.....2.05 dBm
 LEVELING (3330B/3320B only).....FAST`

3-286. Perform the following steps.

- a. Connect the output of the 3330B to input channel A of the 3582A using a 50 ohm termination.
- b. Using the MARKER POSITION control, set the marker to the maximum amplitude of the 25 kHz signal spectra. The marker frequency displayed should be 25000 Hz \pm 0.5 Hz.
- c. Repeat Steps a and b for channel B by setting the INPUT MODE switch and AMPLITUDE switches for channel B.

3-287. Phase Accuracy.

3-288. The phase accuracy test checks the phase accuracy by comparing the phase spectral components associated with the harmonics of a triangle wave input.

3-289. Required Test Equipment.

- hp- 3312A or 3325A Function Generator
- Compatible shielded (coax) interconnecting cables with appropriate adapters

3-290. Instrument Control Settings.

3582A: Preset

SENSITIVITY (both channels).....0 dBV
 FREQUENCY MODE.....SET CENTER
 SPAN..... 1 kHz
 FREQUENCY ADJUST..... 2750 Hz
 MARKER ON

3312A:

AMPLITUDE..... 1 V
 RANGE..... 1 kHz
 Adjust Frequency..... 2.75
 FUNCTION..... \sphericalangle (triangle)
 SYMMETRY CAL
 TRIGGER..... FREE RUN
 MODULATION SECTION..... OFF

3-291. Perform the following steps.

- a. Connect the output of the 3312A to the inputs of channels A and B using appropriate cables and adapters.
- b. Adjust the frequency of the 3312A to place the fundamental at the center graticule (2750 Hz \pm 20 Hz). Adjust the 3312A amplitude output to place the amplitude of the fundamental within 3 dB of full scale.
- c. Set the 3582A AMPLITUDE A to OFF and the PHASE A to ON. Set the FREQUENCY MODE to 0-25 kHz and the TRIGGER SLOPE to -.
- d. Adjust the TRIGGER LEVEL until the phase spectra of the harmonics are as near to zero degrees as possible. Use the MARKER to verify that the center of the sloping portion of the phase components are between $\pm 10^\circ$. If they are not, repeat the TRIGGER LEVEL SETTING. Set the TRIGGER REPETITIVE button to OFF.
- e. Using the MARKER POSITION control, set the marker to the center of the sloping segment of the phase spectra of the 5th harmonic. Press the MARKER SET REF button.
- f. Put the TRIGGER back into the REPETITIVE mode. Press the MARKER REL button and check that the relative phase variation is less than $\pm 10^\circ$.
- g. Repeat Steps d through f for channel B by setting the INPUT MODE switch and PHASE switches for channel B. Set the MARKER REF to OFF.

3-292. Amplitude and Phase Match Between Channels.

3-293. The amplitude and phase match between channels should be within the given tolerances so that comparative functions such as Transfer Function and Coherence will be accurate.

3-294. Required Test Equipment. None.

3-295. Instrument Control Settings.

3582A: Preset

SENSITIVITY (both channels).....	+ 10 dBV
INPUT MODE.....	BOTH
AMPLITUDE XFR.....	ON
AMPLITUDE A.....	OFF
PASSBAND SHAPE.....	UNIFORM
NOISE SOURCE.....	PERIODIC
MARKER	ON

3-296. Perform the following steps:

- a. Connect the NOISE SOURCE OUTPUT to the inputs of channels A and B via suitable cables with adapters.
- b. Using the MARKER POSITION control, move the marker across the screen noting that each marker amplitude reading does not exceed ± 0.8 dB.

- c. Set the AMPLITUDE XFR button to OFF and set the PHASE XFR button to ON.
- d. Move the marker across the screen noting that each marker phase reading does not exceed ± 5 degrees.

3-297. CONTROLS, CONNECTORS AND INDICATORS.

3-298. Introduction.

3-299. The control glossary is located on a foldout which also contains a pictorial of the 3582A. Each pictorial has numerical designators which refer to control group sections. The control group sections are described on adjoining pages.

NOTE

The information contained in the control glossary is of a limited nature. Therefore, it is recommended that Section III Part I be read before operating the instrument.

1 INPUT SECTION: Two independent input signals can be measured separately or simultaneously. The input circuits can be ac or dc coupled and can be floated.

OVERLOAD: Indicates momentary or continuous overload of the input or the digital filters. The appropriate input sensitivity is obtained by down-ranging until the LED comes on and then backing off one position.

SENSITIVITY: Selects the maximum input level that can be applied to the instrument without overloading.

When set to the CAL position, an internally generated calibrated signal is connected to the measurement path. The signal has a spectral line every 1 kHz and an amplitude of 22 dBV (20 V) as shown.

VERNIER: Provides continuous but uncalibrated attenuation between the major steps. When not in the CAL position, only relative marker operations are valid. Note that this control is not programmable.

INPUT MODE: Determines which input signal is sampled. When set to BOTH, the resolution is cut in half.

COUPLING: Selects ac or dc coupling of the input circuit. When ac coupled the low frequency 3 dB point is < 0.5 Hz. This is easily shown by monitoring the NOISE SOURCE on the 2.5 Hz 0-START span.

DC coupling is used for signals with components of interest below about 10 Hz.

BALANCE: Compensates for dc drift of the input circuits. The temperature related drift is less than 100 $\mu\text{V}/^\circ\text{C}$.

ISOL/CHAS: Determines if the input circuit is floating or referenced to chassis ground. In the isolated position safety requirements limit the amount of "float" to 30 volts.

INPUT: High impedance (1 M Ω) input is directly compatible with -hp- 10001A type 10:1 divider probes.

2 FREQUENCY SECTION: Spans down to 1 Hz full scale with a 0 Hz START FREQUENCY and band analysis spans down to 5 Hz full scale can be selected. In the band analysis mode the frequency adjust control tunes the start or center display frequency.

SPAN MODE: Selects the sweep mode. 0-START refers to an analysis span that starts at dc and SET START or SET CENTER refers to one that does not start at dc. The 0–25 kHz mode is for taking a quick look at the entire spectrum independent of where the span control is set.

SPAN CONTROL: Selects the total width (not per division) of the span to be analyzed. Spans from 5 Hz to 25 kHz in a 1-2-5-10 sequence are available in three of the modes. Spans of 1 and 2.5 are also available in the 0-START modes. If these spans are accidentally selected in band analysis, a diagnostic is written and the 5 Hz span is used. This control determines how long time record collection takes place, therefore, you have to be careful when using spans below about 100 Hz.

ADJUST: Tunes the start or center display frequency in the band analysis modes. The tuned frequency is displayed in the lower left corner of the display.

Note that tuning is locked out when the instrument is in an averaging sequence to prevent the collection of invalid data. The control is an infinite turns RPG with tuning rates which depend on how fast you turn the knob.

3 DISPLAY SECTION: Amplitude or phase of either or both channels or the transfer function can be displayed. The sampled time waveform and a measurement called the coherence function can also be displayed.

AMPLITUDE: Selects one or more amplitude displays. These buttons must agree with the INPUT MODE switch or a diagnostic will be written.

SCALE: Defines the display as 80 dB or 16 dB in log modes or as voltage in the linear mode.

PHASE: Selects one or more phase displays. As with the AMPLITUDE displays, these buttons must agree with the INPUT MODE switch or you get a diagnostic. In addition, single channel phase requires triggered operation or you get a diagnostic. The scale on these displays is fixed at 50 $^\circ$ /division with foldover at $\pm 180^\circ$.

COHERENCE: It is only valid in the dual-channel mode with RMS averaging selected. Any other configuration results in a diagnostic. The scale is a fixed 0.0 to 1.0 percentage scale.

TIME: The Model 3582A is *not* a digital time domain oscilloscope. In the baseband mode the display is composed of every other time sample (the display circuitry can only take 512 points) of the input. For input signals well below the span width the reproduction can be pretty good, but for frequencies near the span width the reproduction is very poor. For the band analysis modes the display is probably useful only in determining the presence or absence of a signal.

AMPLITUDE REFERENCE LEVEL: In the log display modes this offsets the display in 10 dB steps. In the linear mode the full scale sensitivity is increased in a 40-16-8-4 sequence. In all cases this is just an arithmetic scaling operation and does not effect the input level that will cause overloading. Also, since it is a 16 bit arithmetic operation, it does not contribute to the accuracy specification like an IF attenuator would. The most common uses for this control are:

1. To properly scale a transfer function amplitude display.
2. To examine signals below 10% of full scale in the linear mode.

INPUT MODE STATUS: Reflects the setting of the input mode switch.

- 4 TRIGGER SECTION: Multiple or single shot triggering of a measurement can be initiated by an input signal on channel A of the proper slope and level.

DATA LOADING: Is on while a time record is being collected. When this indicator is not flashing the instrument is not collecting data and may appear to be "hung-up". When this happens the key control settings should be checked (framed functions).

LEVEL CONTROL: Determines the level on the time domain waveform at which the collection of a data record should begin. In the detented FREE RUN position, triggering is initiated by the completion of the previous measurement. Note that while the level can be varied over the entire A/D converter range, there is no way to select a particular value other than trial-and-error. Also this control cannot be programmed.

SLOPE: Determines if triggering will occur on a positive or negative going transition through the trigger level.

REPETITIVE: Determines if multiple successive triggers can occur without an ARM operation. Note that when not in the repetitive mode the instrument will take only one time record. After this, the instrument can appear to be "hung-up".

ARM: Sensitizes the trigger path to initiate time record collection the next time all trigger conditions are satisfied.

ARM INDICATOR: When lit, the unit is armed and waiting for the trigger conditions to be satisfied.

- 5 PASSBAND SHAPE SECTION: Passband filter shapes are optimized for various measurement situations and can be changed without having to redo a measurement unless averaging is being applied.

FLAT TOP: Optimized for maximum accuracy when measuring discrete spectral lines. This filter contributes less than 0.1 dB of amplitude inaccuracy.

HANNING: Represents a compromise between optimum amplitude accuracy and narrow bandwidth. Its worst case amplitude uncertainty is about 1.8 dB but its 3 dB bandwidth is roughly 40% of that of the FLAT TOP filter.

UNIFORM: Specifies no time domain weighting of the input data. This is used for transient measurements and in conjunction with the built-in pseudorandom noise source and the impulse output (rear panel).

- 6 AVERAGE SECTION: Digital averaging gives precise, repeatable analysis of random or time varying data.

OFF: Determines whether successive spectral results are averaged or not. Note that when averaging is specified, the unit will stop taking data after the selected number of averages. Under these conditions the instrument may appear to be "hung-up".

RMS: Combines successive amplitude results in a frequency bin using a root-mean-square calculation and phase results using a simple mean calculation. This is operationally equivalent to display smoothing or video filtering in that it reduces noise variations, but does *not* result in enhancement of the signal-to-noise ratio.

TIME: Combines successive time records by finding the mean at each point. This requires a trigger signal that is synchronized with the discrete portion of the signal. Unlike RMS averaging this can result in signal-to-noise enhancement of as much as 24 dB. It is also

much faster than other methods because no intermediate results are calculated. If you try to TIME average without a trigger you get a diagnostic.

PEAK: Keeps the maximum amplitude and corresponding value found in a frequency bin during N successive measurements.

RESTART: Initiates a new averaging sequence. Note that this control actually clears the time record and restarts the measurement process *even* with the averaging turned off. This is probably the easiest way to restart any measurement if you do not like the time record being collected. It can even be used as a manual trigger by putting the unit in the non-repetitive mode.

SHIFT: Functions like a shift button on a calculator to define whether the black average numbers or the blue average numbers are active.

NUMBER: Specifies 4 to 256 averages. EXP gives an exponentially decreasing weight to older data. Exponential weighting works in RMS averaging only. When EXP is selected in the PEAK mode, the instrument will accumulate PEAK data indefinitely.

7 MARKER SECTION: Absolute or relative readout of the X and Y values of the intensified dot marker simplify interpretation of results.

ON: Turns the intensified dot marker on. Normally, about the only reason to ever turn the marker OFF is to view the progress of the average number during an averaging cycle.

REL: Specifies if the marker is to read out in absolute units or in units referenced to the last value saved by a SET REF operation. This can be used to read the difference between two traces as long as they are both of the same type and neither is a stored trace.

SET REF: Defines the present marker values as a reference for subsequent relative measurements.

SET FREQ: Defines the present marker frequency as the value to be used as the start or center frequency for subsequent band analysis measurements. The marker frequency resolution on wide bandwidths (since the marker is $k\Delta f$) may cause the display to be not exactly centered or started. Repositioning the marker and doing SET FREQ again will refine the display because the marker resolution is better on narrower spans.

TRACE: Causes the dot marker to jump from one active trace to the other. Note that the marker will not work on stored traces.

POSITION: Moves the intensified dot marker either right or left on the active trace.

+ \sqrt{BW} : Normalizes the marker reading by the square root of the equivalent noise bandwidth. This gives results as relative or absolute $\text{dBV}/\sqrt{\text{Hz}}$ and corresponds to a noise voltage density in a 1 Hz bandwidth. The equivalent noise bandwidth appears in the lower right corner of the display.

8 TRACE STORAGE SECTION: Two independent display traces can be digitally stored and recalled.

STORE: Digitally stores the trace portion of an active display. Note that the alphanumerics and scale settings are not stored so marker functions do not work on stored traces.

RECALL: Recalls the stored display trace.

A stored trace counts as one of the two allowable display traces.

9 NOISE SOURCE SECTION: A built-in noise source serves as the "real-time" equivalent of a conventional tracking generator.

OUTPUT: Serves as a replacement for the conventional tracking oscillator. The source impedance is low (typically $< 2 \Omega$) and the level varies from nominally 0 V to 0.69 RMS.

LEVEL: Varies the RMS output level from nominally 0 V to 0.69 V at the detented position. Note that this control is not programmable.

SELECTOR: Selects RANDOM or PERIODIC pseudorandom source.

10 X-Y RECORDER SECTION: Front panel controls facilitate the interface with analog X-Y recorders.

PLOT: Initiates an analog X-Y plot. A plot normally takes about 80 seconds but may vary since the output approximates a constant slew rate. Note that none of the alphanumerics are plotted.



↓: Initializes the plotter to the lower left corner for setting plotter controls. Note that pressing this button during a plot will abort the plot and reset the plot circuit—hence the reset notation.

↑: Initializes the plotter to the upper right corner. While not marked, this will also reset the plot circuit during a plot.

- 11 HP-IB STATUS SECTION: HP-IB is standard and provides full remote programming and flexible data input and output.

LOCAL: Returns the instrument to local control unless an external controller has executed a local lockout command.

REMOTE: Lights when the instrument is under remote HP-IB control.

TALK: Lights when the instrument is addressed to talk via the HP-IB.

SRQ: Lights when an HP-IB syntax error occurs.

LISTEN: Lights when the instrument is addressed to listen via the HP-IB.

- 12 CRT SECTION: Two digitally stored display traces plus four lines of alphanumeric data provide complete annotated results.

CRT: Displays graphical and alphanumeric data.

ASTIG: The ASTIG control is used in conjunction with the FOCUS control to adjust the CRT spot size (see screwdriver adjustments Section III Part I).

INTENSITY: The INTENSITY control adjusts the brightness of the CRT trace. Since the 3582A has a digital storage display, the INTENSITY can be set at any level without burning the CRT. In the CRT OFF position, the CRT display is disabled. This position should be used if the instrument is left on for long periods and the CRT display is not needed (such as when the unit is under remote control).

FOCUS: Adjusts the CRT spot size (see ASTIG).

GRAT. ILLUM.: Adjusts the graticule scale illumination for photography.

- 13 RESET: Resets the micro-processor.

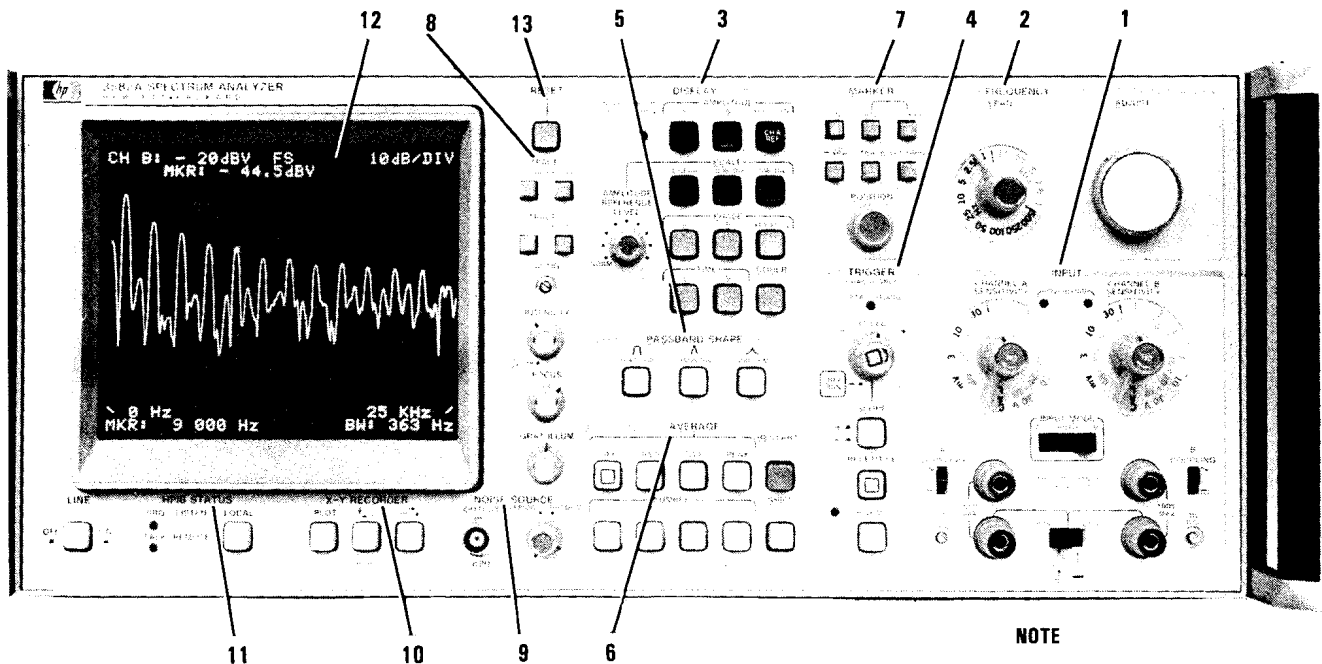

The information contained in the Control Glossary is of a limited nature. Therefore, it is recommended that Section III Part I be read before operating the instrument.

Figure 3-48. 3582A Front Panel Controls, Connectors and Indicators.
3-69/3-70

- 1 X-Y Recorder Output: The RECORDER output provides a variable output between 0 V and +5 V on the X and Y terminals. The PENLIFT output is a contact closure.

X and Y Axis Output: The X and Y axis BNC connectors output a dc voltage (from 0 to +5.25 V nominal) which is proportional to a position on the CRT as the trace is scanned from left to right. Zero volts on both outputs corresponds to the lower left-hand corner of the display. Alphanumerics are not available on the recorder outputs.

PENLIFT: The penlift output is actuated by a contact closure which shorts the two terminals together during operation.

- 2 HP-IB Connector: The connector is compatible with the -hp- Model 10631 series of HP-IB interconnecting cables. Stacking more than four cables on the connector may lead to the connector and mounting being damaged (see Section II Installation).

HP-IB Connector: The 3582A uses all of the signal lines in the connector. Be sure that none of the contacts are damaged before inserting or after removing a compatible HP-IB cable. HP-IB is Hewlett-Packard's implementation of IEEE Std. 488-1975, "Standard Digital Interface for Programmable Instrumentation". See Section II Installation.

Fastening Nuts: Cable fastening screws have metric threads. Be sure your connector cables are compatible, do not force non-metric screws into the mounting nuts.

- 3 Impulse Output: The IMPULSE output is a TTL level output and has a period determined by the SPAN and MODE switch settings.

IMPULSE Output: The IMPULSE output is a pulse which has an amplitude of +5 V. The period of the pulse is determined by the setting of the SPAN and MODE switches and can be approximated by the following formula:

$$T_{\text{PULSE}} = \frac{1}{32 \times \text{SPAN (Hz)}}$$

The repetition rate of the pulse is determined by the length of the time record (push the TIME record button to observe the time record length).

- 4 Trigger Input: A TTL compatible trigger source may be used when the switch is set to EXT and the trigger LEVEL control on the front panel is in FREE RUN.

TRIGGER Input: The TRIGGER input is a TTL compatible input. The front panel SLOPE switch determines which edge of the pulse may initiate the trigger.

Trigger Switch: When this switch is set to EXT, the trigger input is enabled. Note, however, that the front panel trigger LEVEL control must be in the FREE RUN position.

- 5 Air Filter Screen: The instrument should always be positioned so that unrestricted airflow is available through the air filter screen (see Section II Installation).

Air Filter Screen: The air filter screen should be cleaned periodically by removing and flushing it with soapy water.

Air Filter Mounting Screws: The four screws may be removed for air filter service.

- 6 Power Input Section: Two switches may be set to the input line voltage level. The line FUSE is accessible as well as the power plug connector (see Section II Installation).

Line Switches: The line switches may be set to one of several combinations of input line voltages.

FUSE: The fuse may be accessed by removing the fuse holder cap. Use only a fuse which is specified for the line voltage selected (see Section II Installation).

Power Line Connector: A three wire cord with the appropriate plug is provided with the instrument. When inserted into the proper power receptacle, the plug grounds the instrument cabinet. **Do not use any power plug adapters to "float" the instrument chassis!**

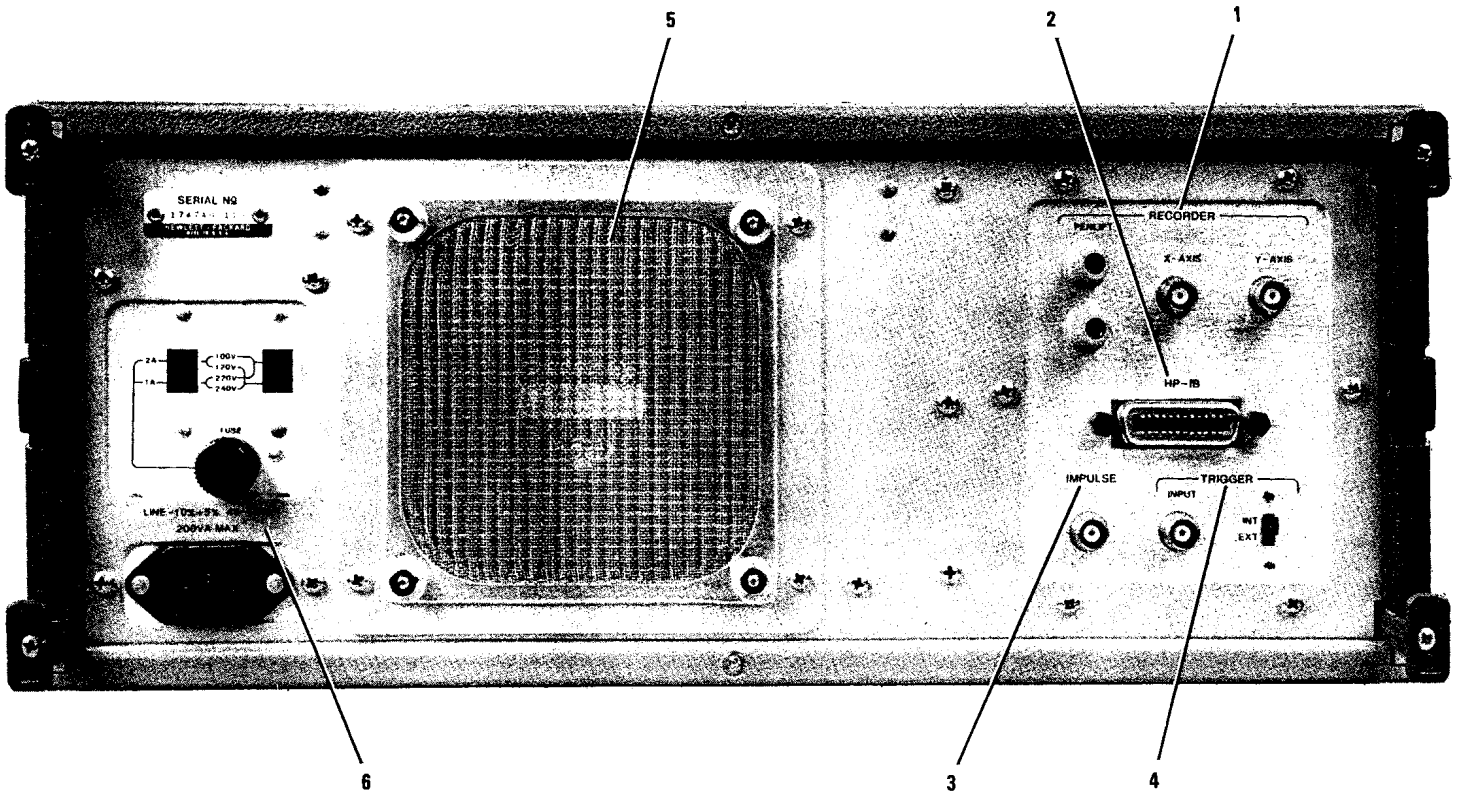

Figure 3-49. 3582 Rear Panel Connectors, Switches, and Filter.
3-71/3-72

APPENDIX A HP-IB COMMAND LIST

NOTE

It is recommended that Section III Part II be read before remote programming the instrument.

Table A-1. HP-IB Command List.

Group	Command		Description	
	Function	Setting		
Input & Trigger	IM	1-3	Input Mode (A, Both, B)	
	AC	1-2	A Coupling (1 = AC, 2 = DC)	
	BC	1-2	B Coupling (1 = AC, 2 = DC)	
	AS	AS	1-10	1 CAL
				2 30 V, +30 dBV
				3 10 V, +20 dBV
				4 3 V, +10 dBV
				5 1 V, +0 dBV
				6 .3 V, -10 dBV
				7 .1 V, -20 dBV
				8 30 mV, -30 dBV
				9 10 mV, -40 dBV
				10 3 mV, -50 dBV
	BS	1-10	CH B Sensitivity	
SL	1-2	Slope (1 = +, 2 = -)		
AR		Arm		
RP	0-1	Repetitive		
FR	0-1	Free Run		
AD	0-24999	Adjust (Frequency) (0 = 0 Hz, 24999 = 24999 Hz)		
Frequency & Marker	MD	1-4	Mode (1 = 0-25 kHz, 2 = 0 Start, 3 = Set Center, 4 = Set Start)	
			1 1 Hz	
			2 2.5 Hz	
			3 5 Hz	
			4 10 Hz	
			5 25 Hz	
			6 50 Hz	
			7 100 Hz	
			8 250 Hz	
			9 500 Hz	
			10 1 kHz	
			11 2.5 kHz	
			12 5 kHz	
			13 10 kHz	
14 25 kHz				
SP	1-14	Span		
MN	0-1	Marker		
MR	0-1	Marker Relative		
MS		Marker Set Ref		

Table A-1. HP-IB Command List (Cont'd).

Group	Command		Description
	Function	Setting	
Display	MB	0-1	Marker / \sqrt{BW}
	MT	0-1	Marker Trace
	MF		Marker Set Freq
	MP	0-255	Marker Position (0-127 for dual channel)
	AA	0-1	Amplitude A
	AB	0-1	Amplitude B
	AX	0-1	Amplitude Transfer Function
	SC	1	Scale Linear
	SC	2	Scale 10 dB/Div.
	SC	3	Scale 2 dB/Div.
	PA	0-1	Phase A
	PB	0-1	Phase B
	PX	0-1	Phase Transfer Function
	TA	0-1	Time A
	TB	0-1	Time B
Passband Shape	CH	0-1	Coherence
	AM	1-9	Amplitude Ref. Level (Add - 10 dB per step, 2 = - 10 dB, 9 = - 80 dB)
	PS	1	Flattop
Average	PS	2	Hanning
	PS	3	Uniform
	AV	1	Off
	AV	2	RMS
	AV	3	Time
	AV	4	Peak
	RE		Restart
	NU	1	Number 4/64
	NU	2	Number 8/128
	NU	3	Number 16/256
Trace Storage & Recall	NU	4	Number 32/Exp
	SH	0-1	Shift
	TS		Trace 1 Store
	TR	0-1	Trace 1 Recall
X-Y Recorder	RS		Trace 2 Store
	RR	0-1	Trace 2 Recall
X-Y Recorder	PL		X-Y Plot
	LL		↓ - Lower Left & Reset)
	UR		→ ↑ (Upper Right)

Table A-2. Special Commands (See Section III Part II).

Group	Command	Description																		
Listing Commands	LAD	List frequency adjust value NNNNN.N CRLF																		
	LMK	List marker amplitude and frequency $\pm N.NNNE \pm NN$, NNNNN CRLF																		
	LSP	List span (Hz) NNNNN CRLF																		
	LAS	List Ch A sensitivity																		
	LBS	List Ch B sensitivity																		
	LXS	List transfer function sensitivity																		
	LDS	List display (128, 256, or 512 points in corresponding units) each point $\pm N.NNE \pm NN$ separated by commas; CRLF																		
	LAN	List alphanumerics (128 ASCII characters, CRLF; representing the four 32 character lines)																		
Binary Memory I/O	LFM,M,N WTM,M,N	List from memory Write to memory M = Start Address (Octal) N = Number of words to be transferred (decimal) Input is in 2N 8-bit bytes Most significant byte first																		
Writing Display Alpha-numerics	WTA 1-4, 32 ASCII Characters	Inputs a 32 character string to alpha line 1 to 4 (top to bottom) of display. Use blanks where needed to complete 32 character count.																		
Processor Control	HLT RUN	Unconditional halt at next HP-IB branch point Unconditional run																		
Status Word	LST0 LST1	List status word (0 Resets Bits After Reading) One 8-Bit Byte <table border="1" data-bbox="630 1423 1341 1881"> <thead> <tr> <th>Bit</th> <th>Value</th> <th>Meaning</th> </tr> </thead> <tbody> <tr> <td>0</td> <td>1</td> <td>Diagnostic on screen. Indicates current switch setting is invalid. Set and cleared by 3582.</td> </tr> <tr> <td>1</td> <td>2</td> <td>Arm light is on. Set and cleared by 3582 to agree with arm light on front panel.</td> </tr> <tr> <td>2*</td> <td>4</td> <td>A overload. Set by 3582 when: 1)Time record is moved to FFT area or time record is complete 2)and hardware overload has occurred 3)and A or BOTH INPUT MODE.</td> </tr> <tr> <td>3*</td> <td>8</td> <td>B overload. Same as A.</td> </tr> <tr> <td>4*</td> <td>16</td> <td>Time record complete. Set when 1024 new time points have been taken since last record complete.</td> </tr> </tbody> </table>	Bit	Value	Meaning	0	1	Diagnostic on screen. Indicates current switch setting is invalid. Set and cleared by 3582.	1	2	Arm light is on. Set and cleared by 3582 to agree with arm light on front panel.	2*	4	A overload. Set by 3582 when: 1)Time record is moved to FFT area or time record is complete 2)and hardware overload has occurred 3)and A or BOTH INPUT MODE.	3*	8	B overload. Same as A.	4*	16	Time record complete. Set when 1024 new time points have been taken since last record complete.
Bit	Value	Meaning																		
0	1	Diagnostic on screen. Indicates current switch setting is invalid. Set and cleared by 3582.																		
1	2	Arm light is on. Set and cleared by 3582 to agree with arm light on front panel.																		
2*	4	A overload. Set by 3582 when: 1)Time record is moved to FFT area or time record is complete 2)and hardware overload has occurred 3)and A or BOTH INPUT MODE.																		
3*	8	B overload. Same as A.																		
4*	16	Time record complete. Set when 1024 new time points have been taken since last record complete.																		

Table A-2. Special Commands (Cont'd).

Group	Command	Description		
		5*	32	Single sweep spectrum complete. Set when time complete data has been FFT'D and displayed. Use LST1 to check this flag! It depends on internal flags which are cleared by LST0.
		6*	64	Average complete.
		7*	128	X-Y plot complete.
		*Resets after LST 0 is given.		
Preset	PRS	Preset command		
		Causes instrument to go into the following control state: (25 kHz, 1 channel)		
		Switch	Setting (when applicable)	
		Coupling	AC (Channels A & B)	
		Input Mode	Channel A	
		Sensitivity	30 V (Channels A & B)	
		Level	Free Run	
		Repetitive	On	
		Arm	Off	
		Trigger Slope	—	
		Marker	Off	
		Marker Relative	Off	
		Marker $\div \sqrt{BW}$	Off	
		Mode	0-25 kHz Baseband	
		Span	25 kHz	
		Amplitude	A (B&XFR-OFF)	
		Scale	10 dB/Div	
		Phase	None	
		Time	None	
		Coherence	Off	
		Amplitude Ref Lev	Normal	
		Passband	Flat Top	
		Average	Off	
		Average Number	4	
		Average Shift	Off	
		Trace 1 Store	Off	
		Trace 1 Recall	Off	
		Trace 2 Store	Off	
		Trace 2 Recall	Off	

Table A-3. Memory Locations.

Description	Start Address (M, Octal)	Number of Words (N, Decimal)	Binary Format
Time Record	70000	1024	Numeric
Display	74000	512	Alphanumeric
Front Panel Switches	77454	5	Numeric

APPENDIX B

CONDENSED DESCRIPTION OF THE HEWLETT-PACKARD INTERFACE BUS

GENERAL BUS DESCRIPTION.

The Hewlett-Packard Interface Bus (HP-IB) is a carefully defined instrumentation interface which simplifies the integration of instruments, calculators, and computers into systems. It minimizes compatibility problems between devices and has sufficient flexibility to accommodate future products. The Hewlett-Packard Interface Bus has been formally proposed to the International Electrotechnical Commission (I.E.C.), as an international standard, and to the Institute of Electrical and Electronic Engineers (I.E.E.E.) as an American standard.

The HP-IB employs a 16 line Bus to interconnect up to 15 instruments. This Bus is normally the sole communication link between the interconnected units. Each instrument on the Bus is connected in parallel to the 16 lines of the Bus. Eight of the lines are used to transmit data and the remaining eight are used for communication timing (Handshake), and control.

Data is transmitted on the eight HP-IB data lines as a series of eight-bit characters referred to as "bytes". Normally, a seven-bit ASCII (American Standard Code for Information Interchange) code is used with the eighth bit available for a parity check, if desired. Data is transferred by means of an interlocked "handshake" technique. This sequence permits asynchronous communication over a wide range of data rates.

Communication between devices on the HP-IB employs the three basic functional elements listed below. Every device on the Bus must be able to perform at least one of these functions:

a. **LISTENER** – A device capable of receiving data from other instruments. Examples of this type of device are: printers, display devices, programmable power supplies, programmable signal sources and the like.

b. **TALKER** – A device capable of transmitting data to other instruments. Examples of this type of device are: tape readers, voltmeters that are outputting data, counters that are outputting data, and so on.

c. **CONTROLLER** – A device capable of managing communications over the HP-IB such as addressing and sending commands. A calculator or computer with an appropriate I/O interface is an example of this type of device.

An HP-IB system allows only one device at a time to be an active talker. Up to 14 devices may simultaneously be listeners. Only one device at a time may be an active controller.

BUS STRUCTURE.

The HP-IB interface connections and Bus structure are shown in Figure 1.

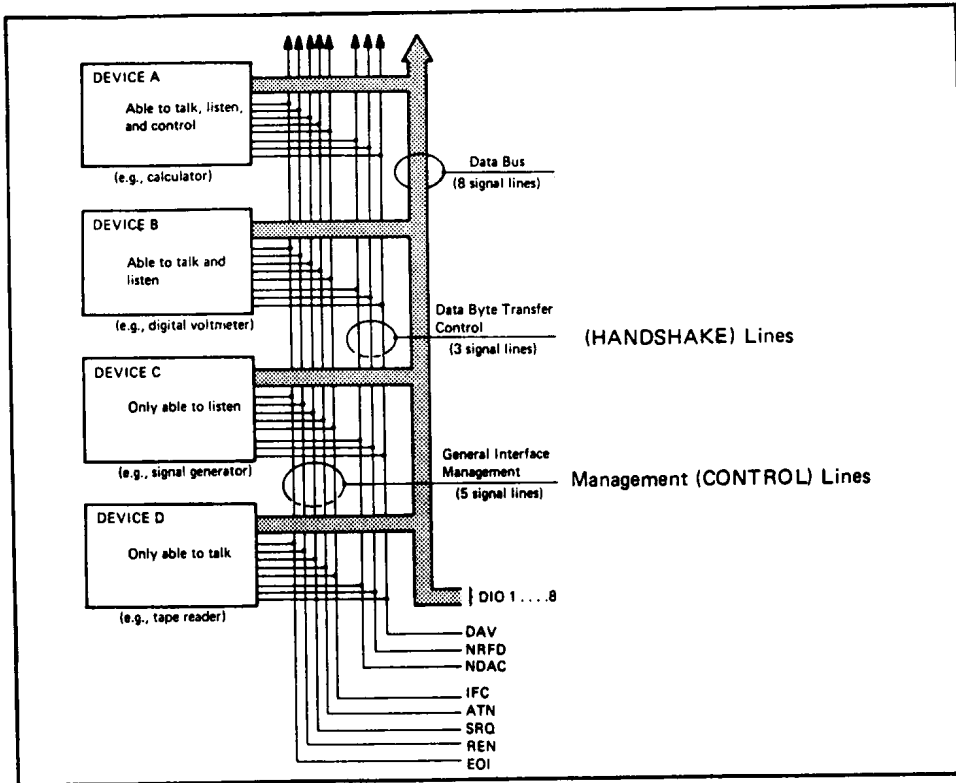

Figure 1. Interface Connections and Bus Structure.

Management (CONTROL) Lines.

The active controller manages all Bus communications. The state of the ATN (attention) line, determined by the controller, defines how data on the eight data (DIO) lines will be interpreted by the other devices on the Bus. When ATN is low (true), the HP-IB is in Command Mode. In Command Mode the controller is active and all other devices are waiting for instructions. Command Mode instructions which can be issued by the Controller in "Command Mode" include:

a. Talker Address –

A seven bit code transmitted on the HP-IB which enables a specific device to talk. Only one Bus device at a time may act as the talker. When the controller addresses a unit to talk the previous talker is automatically unaddressed and ceases to be a talker. Confusion would result if more than one device were allowed to talk at a time.

b. Listener Address –

A seven-bit code transmitted on the HP-IB which enables a specific device to listen. Several Bus devices at a time (up to 14) may be listeners.

c. Universal Commands –

Bus devices capable of responding to these commands from the controller will do so at any time regardless of whether they are addressed. These commands will be covered in more detail later.

d. Addressed Commands –

These commands are similar to universal commands except that they are recognized only by devices that are addressed as listeners.

e. Unaddress Commands –

1. “Unlisten” Address Command –

This command unaddresses all listeners that have been previously addressed to listen.

2. “Untalk” Address Command –

This command unaddresses any talker that had been previously addressed to talk.

Bus Commands.

In “Command Mode” one or more special codes known as “bus commands” may be placed on the HP-IB. These commands have the same meaning in all Bus systems. Each device is designed to respond to those commands that have a useful meaning to the device and will ignore all others. The operating manual for each device will state which Bus commands it will obey.

Bus commands fall into three categories.

1. Universal commands affect all responding devices on the Bus, whether addressed or not.
2. Addressed commands affect only responding devices which are addressed to listen. Addressed commands allow the controller to initiate a simultaneous action from a selected group of devices on the Bus.
3. Unaddress commands are obeyed by all addressable devices. These commands unaddress devices that are currently addressed.

The Bus commands are summarized in Table 1.

Service Request and Serial Polling.

Some devices that operate on the interface bus have the ability to request service from the system controller. A device may request service when it has completed a measurement, when it has detected a critical condition, or for any other reason. Service request is initiated when a device sets the HP-IB line labeled SRQ low. The controller has the option of determining when or if a service request will be serviced. The following sequence is used to respond to a service request:

- a. The controller checks for the presence of a service request.
- b. If a service request is present, the controller sets the serial poll mode. *The serial poll mode is initiated by the controller transmitting the Universal Command “SPE” (ASCII character “CAN” [Octal 030]) in the “Command Mode”.*
- c. The controller polls one of the devices that may have requested service. It then polls the next device, and so on. *Once the serial poll mode has been enabled, responding devices on the Bus are prepared to accept a serial poll. This is done by setting ATN, addressing the device as a talker, and then removing ATN. If the device has requested service, it will respond by setting DIO line 7 low. Other DIO lines may also be set low indicating the nature of the service request.*
- d. For each device that has requested service, the controller takes appropriate action.

Table 1. Summary of Bus Commands.

	COMMAND	ASCII Character	OCTAL CODE	PURPOSE
UNADDRESS COMMANDS	UNL UNLISTEN	?	077	Clears Bus of all listeners.
	UNT UNTALK	—	137	Unaddresses the current talker so that no talker remains on the Bus.*
UNIVERSAL COMMANDS	LLO Local Lockout	DC1	021	Disables front panel local-reset button on responding devices.
	DCL Device Clear	DC4	024	Returns all devices capable of responding to pre-determined states, regardless of whether they are addressed or not.
	PPU Parallel Poll Unconfigure	NAK	025	Sets all devices on the HP-IB with Parallel Poll capability to a predefined condition.
	SPE Serial Poll Enable	CAN	030	Enables Serial Poll Mode on the Bus.
	SPD Serial Poll Disable	EM	031	Disables Serial Poll Mode on the Bus.
ADDRESSED COMMANDS	SDC Selective Device Clear	EOT	004	Returns addressed devices, capable of responding to pre-determined states.
	GTL Go to Local	SOH	001	Returns responding devices to local control.
	GET Group Execute Trigger	BS	010	Initiates a simultaneous pre-programmed action by responding devices.
	PPC Parallel Poll Configure	ENQ	005	This command permits the DIO lines to be assigned to instruments on the Bus for the purpose of responding to a parallel poll.
	TCT Take Control	HT	011	This command is given when the active controller on the Bus transfers control to another instrument.

***NOTE**

Talkers can also be unaddressed by transmitting an unused talk address on the Bus.

e. When all devices have been polled, the controller terminates the serial poll mode by issuing the Universal Command SPD (ASCII Character "EM", [Octal 031]).

The full sequence of operations is not necessary in all cases. For example, a system may have only one device that requests service and then only for a single purpose. When the controller detects a service request, the source of the request and the appropriate action is known immediately. Thus the use of the service request and the serial poll depends entirely on the make-up of each system and the devices involved.

APPENDIX D

APPLICATION NOTES

SIGNAL AVERAGING WITH THE HP 3582A SPECTRUM ANALYZER
AN 245-1

MEASURING THE COHERENCE FUNCTION WITH THE
HP 3582A SPECTRUM ANALYZER
AN 245-2

THIRD OCTAVE ANALYSIS WITH THE HP 3582A SPECTRUM ANALYZER
AN 245-3

ACCESSING THE 3582 MEMORY WITH HP-IB
AN 245-4

LOG SWEEP WITH THE HP 3582A SPECTRUM ANALYZER
AN 245-5

SIGNAL AVERAGING WITH THE HP 3582A SPECTRUM ANALYZER

AN 245-1

FOREWORD

Low frequency spectrum analyzers are fast turning into digital instruments. A primary reason for this trend is the frequency analysis speed achieved through the startlingly efficient Fast Fourier Transform computing algorithm. With the additional help of large-scale integrated circuits, compact low-frequency analyzers are emerging which are often 10 to 100 times faster than traditional swept-tuned-filter spectrum analyzers. The HP 3582A is a low-frequency analyzer which continues in a long historical line of HP wave and spectrum analyzers. However, it is totally digital except for input filtering and cathode ray display.

The purpose of this application note is to develop an understanding, by theory and example, of two kinds of signal averaging commonly used in digital signal analysis of the kind employed by the 3582A. These averaging

routines are called "power spectrum averaging" and "time averaging." The corresponding swept analyzer techniques are video filtering (for smoothing measurements of random signals) and narrow-band analysis (when used to enhance signal-to-noise ratios). Two other related digital techniques are discussed which do not have direct equivalents in swept analyzers. These are signal-to-noise enhancement of recurrent transients and a peak-hold feature.

This application note is largely tutorial because of our belief that, while many readers will not have had experience in the area of digital signal processing, all will want a basic understanding of certain of its ideas in order to get maximum benefit from an instrument like the 3582A. This note and others in the series are intended to help provide this understanding.

THE HEWLETT-PACKARD MODEL 3582A SPECTRUM ANALYZER

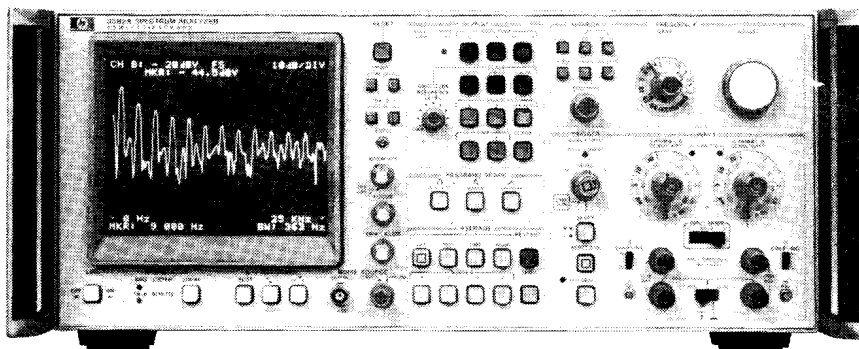

The HP 3582A is a spectrum analyzer covering the frequency range of DC to 25 kHz. Although it is a FFT-based, digital instrument, a special design effort has made it as straightforward to use as a conventional swept analyzer. With dual measurement channels it is possible to measure transfer function gain and phase, as well as the coherence function. A built-in random or pseudo-ran-

dom noise source, whose spectrum tracks the analysis range, is a useful measurement stimulus. Band Selectable Analysis enables narrowband, high resolution analysis to be applied to any portion of the frequency range. The instrument comes equipped with a flexible HP-IB interface for control and two-way data transfers.

TABLE OF CONTENTS

SECTION		PAGE
1	The reasons for signal averaging Deterministic and random signals Classes of random signals The kinds of signals which benefit from signal averaging are defined and discussed.	1
2	The spectrum of a random process Some properties of a random process Analyzing a random process with the FFT Certain properties of random spectra influence the way measurements are made. In addition, the FFT of a random process has some intrinsic limitations which are overcome by averaging.	2
3	Power spectrum averaging Power spectrum averaging compared with video filtering This is a light treatment of the origin of power spectrum averaging, and a discussion of the analogy between this and video filtering.	3
4	Time averaging When to use time averaging How it works There is another kind of averaging which can be used whenever a synchronizing signal is available.	4
5	Summary of averaging properties Power spectrum averages Time averages This is a tabular summary of the principle features of both power spectrum and time averaging.	5
6	Characteristics of 3582A averaging routines Power spectrum averaging; Exponential averaging Time averaging Peak "averaging" The way signal averaging is carried out in the 3582A is explained, along with a couple of related techniques also available in the analyzer.	6
7	Examples Two power (RMS) averaging examples Two time averaging examples Peak averaging example Here are some documented experiments designed to illustrate each of the 3582A averaging techniques.	7
	Appendix 1: Probability distributions of power spectrum estimates Gaussian random processes The averaged power spectrum as a random process	12
	Appendix 2: 90% confidence limits for power averages	
	Bibliography	

SECTION 1:

The reasons for signal averaging

Deterministic and random signals. A deterministic waveform, or signal, is one which can be described by an explicit mathematical function of time. Deterministic signals are easy to visualize: sinusoids and pulse trains are good examples.

Signals derived from real, physical processes are not often deterministic. More likely they are random, or a mixture of deterministic and random. One good reason for this state of affairs is succinctly stated by Shannon's information theory: deterministic signals are not information-bearing, since they are predictable. Some common examples of real-world signals which are more or less random are speech, music, digital data, seismic data, and mechanical vibrations.

Classes of random signals. The technical term used to describe a signal which is a random function of time is "random process." Two useful classes of random processes are:

- a. Pure random process: a signal with no deterministic portion. An example is the sound emitted by a compressed gas escaping from a nozzle.
- b. Mixed random process: a composite signal, the sum of a pure random process and a deterministic signal. For instance, the output of a noisy amplifier with a sinewave input is a mixed random process.

An example of each of these is shown in Figure 1.

Measuring the frequency spectra of random processes involves some difficulties not encountered in measuring deterministic signals. The source of the difficulties is discussed in the next section. **The purpose of signal averaging techniques is to improve the measurement and analysis of random processes.**

Figure 1.

Typical random processes

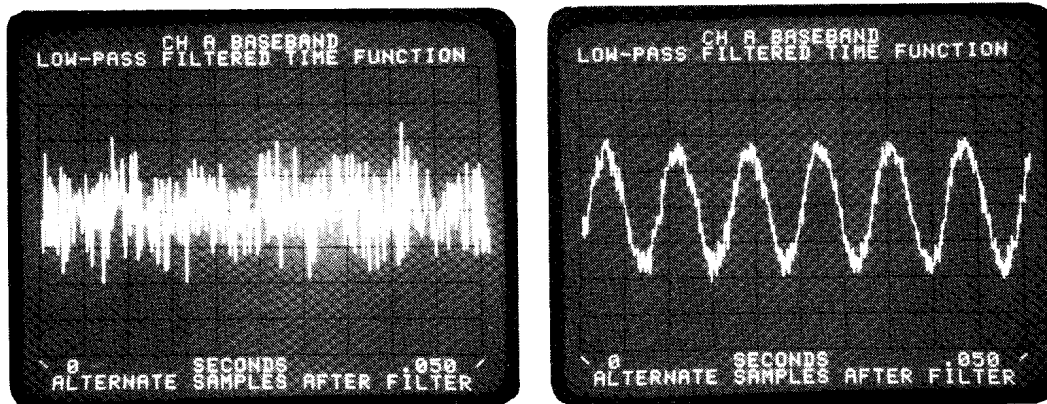

a. Pure random process

b. Mixed random process

Each of the examples shown is a 50-millisecond segment of a process which, theoretically, continues for all time.

SECTION 2:

The spectrum of a random process

Although the exact time waveform of a random process cannot be described by an explicit mathematical function of time, there are certain ways to describe a random process which are explicit and quantitative. Among these ways are the probability density function, the auto-correlation function, and the power spectrum. These parameters provide valuable information about the process, and instruments are available to measure these (and other) parameters of any particular random process. In this note, we are concerned with the measurement of the parameter called the power spectrum. (The 3582A actually displays the square root of the power spectrum, called the amplitude spectrum.)

Some properties of the spectrum of a random process:

- a. **The spectrum is a continuous function of frequency.** This follows from the fact that a random process is not periodic.
- b. **The phase of the linear spectrum of a random process is a random function of frequency.** For this reason, a phaseless spectrum, called the power spectrum, is generally used to describe random processes. This is the same as the magnitude-squared spectrum, obtained by multiplying the linear spectrum by its complex conjugate. Sometimes the square root of the power spectrum is used, as in the 3582A.
- c. **Each segment of the infinite-duration time waveform, being different from any other segment, makes a unique contribution to the spectrum.** Thus, the spectrum resulting from any finite-time measurement is only an approximation to the true spectrum of the random process.

In this last property is found the primary difficulty in measuring the spectrum of a random process. Because we are limited to making finite-time measurements, **the spectrum calculated from one finite segment of the random process only approximates the true spectrum.** It follows that the spectrum derived from one time segment will differ from that of the next, and so on. How inaccurate is such a single measurement? How can we increase the accuracy of measuring the power spectrum? These questions will be taken up next.

Analyzing a random process with the FFT.

The Discrete Fourier Transform, in the form of the Fast Fourier Transform (FFT) implementation, translates a finite segment of discrete time data into a discrete frequency spectrum. For instance, the 3582A operates (in single-channel mode) by sampling the signal on its input terminals to produce 1024 binary numbers representing a segment of the input time function. These numbers are transformed by the FFT into 512 complex values in the frequency domain. Because of possible aliasing, only 256 of these are used. The amplitude display consists of 256 connected points representing the numerical contents of 256 data storage locations called "bins." The numbers in the bins are calculated from the FFT output and can represent either spectrum magnitude or log magnitude.

What if the input time signal is a random process? A common example of this is a Gaussian process. In this case, the magnitude spectrum turns out to be 256 independent random variables with Rayleigh distribution (see appendix). It can be shown that the standard deviation of each bin's contents is about the same as the true value being measured. This obviously poor measurement is inherent in the FFT, regardless of the number of points in the transform. Figure 2 illustrates this with a white noise source as the Gaussian process.

Figure 2.

The spectrum of a 10-millisecond segment of a Gaussian random process

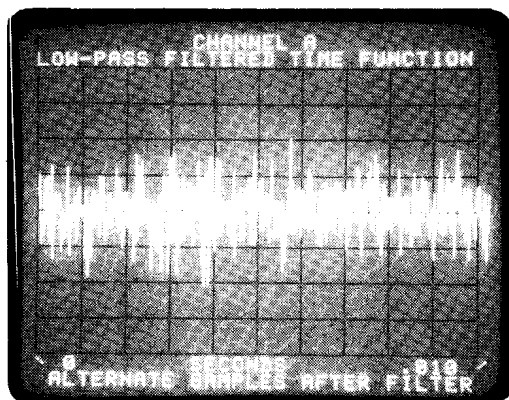

display of the sampled time waveform

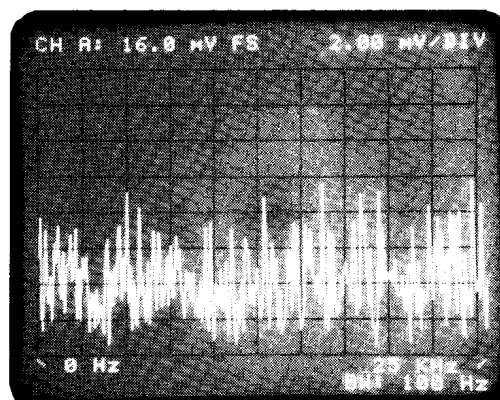

linear magnitude spectrum

SECTION 3:

Power spectrum averaging

If we watch a particular bin while the 3582A analyzes successive segments of a random process, we will begin to suspect that there is a way to improve the measurement accuracy. While there is considerable variation among the values of amplitude, there appears to be a central tendency (or mean value) for the data. More exactly, if we take K measured values and calculate their average (mean), and then repeat this several times, we will have a collection of numbers (the individual averages) whose variance is considerably less than that of the individual data points. Or, putting it another way, the average of K independent measurements is a better statistical “estimator” of the true magnitude of a bin than any single measurement. The accuracy of the average improves (in the sense that the variance decreases) as K gets larger. This kind of average is called a power average, since it is derived from a series of power spectra.

Since employing large values of K can be very time-consuming, especially in narrow-band analysis, it is necessary to know what accuracy to expect for a given value of K . In dealing with random data, a useful form in which to present such accuracy specifications is the “confidence interval.” This is a chart or table listing a numerical interval to be attached to a measured value. With a given confidence, the true value can be stated to be within the interval. For instance, a 90% confidence table states that, in 90% of the measurements, the true value will lie within the interval given. Such a table and an example of its use is given in Section 4 to aid 3582A users in choosing values of K appropriate to their accuracy needs.

Power spectrum averaging compared with video filtering. Many readers will have had experience with conventional swept spectrum analyzers. In these instruments, post-detection low-pass filtering (video filtering) is provided to smooth the measurement of random process spectra. As it happens, this technique is directly related to power averaging in digital analysis, and it is interesting to examine the relationship briefly.

Conventional analyzers: Assume the input to the analyzer is a random process whose power spectrum is nearly constant across the analyzer bandwidth (this assumption is necessary so that the estimate will be “unbiased”; that is, tend in the limit to the true value of the spectrum). Then the spectrum estimate will have this statistical accuracy:

normalized std. dev. of the estimate of the
amplitude spectrum =

$$\frac{1}{\sqrt{B_a T_a}}$$

where

B_a = analysis bandwidth

T_a = effective averaging time, equal to two time constants for single pole filters

Digital analyzers: Using the same assumption as above, the spectrum estimate of a single bin is:

normalized std. dev. of the estimate of
the amplitude spectrum =

$$\frac{1}{\sqrt{B_d K T_d}}$$

where

B_d = bandwidth of one bin $\geq T_d$

K = number of records averaged

T_d = length of time record

Comparison: By comparing these results on the basis of equal analysis bandwidths ($B_a = B_d$), it is plain that equal averaging times ($T_a = K T_d$) produce statistically equivalent measurements of the amplitude spectrum at each frequency. **However, the N-point FFT makes N such estimates, covering a total analysis range of $N B_d$, in the same time that the conventional analyzer makes one estimate.**

SECTION 4:

Time averaging

When power averaging is applied to a mixed random process, the deterministic portion of the signal is unaffected, since its variance is zero to start with. **Power averaging will smooth only the estimate of the random portion of the spectrum.** It will not, for instance, uncover the deterministic spectrum if it is "buried in the noise."

When to use time averaging. If there exists an independent signal, free from noise, which is synchronous with the periodic part of a mixed random process, then we can use another kind of averaging, called "time averaging" in the 3582A, which *will* enhance signal-to-noise ratios. Of course, the need for the synchronizing signal is rather restrictive, although there are numerous situations in which one is available. For example, in biological stimulus-response measurements, the stimulus signal itself will serve as the synchronizer while analyzing the noise-contaminated response.

How it works. The principle of time averaging is straightforward. The operation may be explained from the point of view of either time or frequency domains, although perhaps the time domain view is intuitively clearer: select K equal length intervals of a mixed random process. The intervals must be chosen so that the first point of each occurs at the same position in the cycle of the periodic component. If the corresponding points of all the intervals are added together, and then divided by K to produce an average, we can deduce the following about this averaged waveform:

- 1) The amplitude of the normalized periodic component is $(1/K)K = 1$ times the amplitude of the periodic component in one interval. This is because the synchronized components add directly.

- 2) The random components, being uncorrelated, add on an RMS basis; their normalized sum is $(1/K)\sqrt{K} = 1/\sqrt{K}$ times the amplitude of the random component in one interval.

Thus, in the average, the ratio of the periodic component to the random component is

$$\frac{1}{1/\sqrt{K}} = \sqrt{K}$$

times higher. This means a S/N improvement of $20 \log \sqrt{K} = 10 \log(K)$ dB. The maximum K is 256 in the 3582A, so the S/N improvement for time averaging approaches 24 dB.

Time averaging does *not* reduce the normalized standard deviation in measuring the random portion of the spectrum. In the averaged waveform, the ratio of the standard deviation to the mean value (of the random portion) is the same as that of a single measurement. Therefore, if one wants both improved measurement of the random portion and enhanced S/N ratio, both spectrum and time averaging should be used in succession. This is possible either for stored time data, or for signals whose statistics don't change with time. Of course, a synchronizing signal must be used for the time average.

Time averaging can also be performed on some mixed random processes whose deterministic components are not strictly periodic. This is most easily seen in the case of transient analysis in which the transient is stimulated by a non-periodic signal. It is necessary that the transient diminish to insignificance between applications of the stimulus so that the averaging process will be performed on identical samples of the deterministic signal. See Figure 3 and the example in Section 7.

Figure 3.

Time averaging on a repetitive but not periodic transient

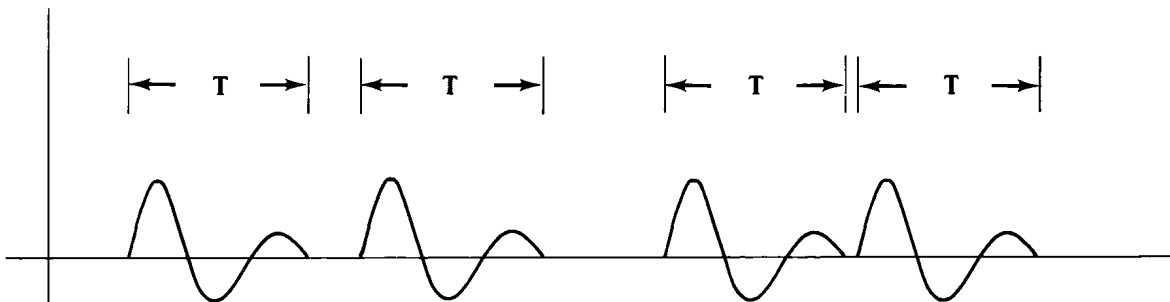

Each interval T begins at the same point in the waveform. An actual example of this is given in Section 7.

SECTION 5:

Summary of averaging properties

The important properties of the two forms of signal averaging in the 3582A are listed here in summary:

Power spectrum averaging

- a) Power averaging is applicable to either pure or mixed random processes.
- b) Power averaging reduces the inherent variance resulting when the FFT is used to determine the spectrum of a random process. Thus, a power averaged spectrum is a statistically more accurate estimate of the true spectrum.
- c) When applying power averaging to a mixed random process, the deterministic portion of the signal is unaffected. Thus, the S/N ratio (the ratio of the deterministic to the random parts of the signal) is *not* changed.
- d) No synchronizing signal is needed.
- e) Phase is not available in the power average routine. (The phase information given by the 3582A is calculated with another routine; see Section 6.)

Time averaging

- a) Time averaging is useful only with mixed random processes (the signal must have a deterministic component).
- b) Time averaging increases the ratio of the deterministic to random portions of the signal (i.e., it improves the S/N ratio).
- c) The normalized standard deviation of the random portion of the spectrum is unchanged.
- d) A synchronizing signal, in fixed relation to the deterministic portion of the signal, must be used with time averaging.
- e) In the 3582A, the results of time averaging on a signal may be displayed in both time and frequency domains.
- f) A time averaged spectrum is complex; both amplitude and phase spectra are derived from the same linear averaging algorithm.

Figure 4.

Relative weighting of spectra in exponential average routine

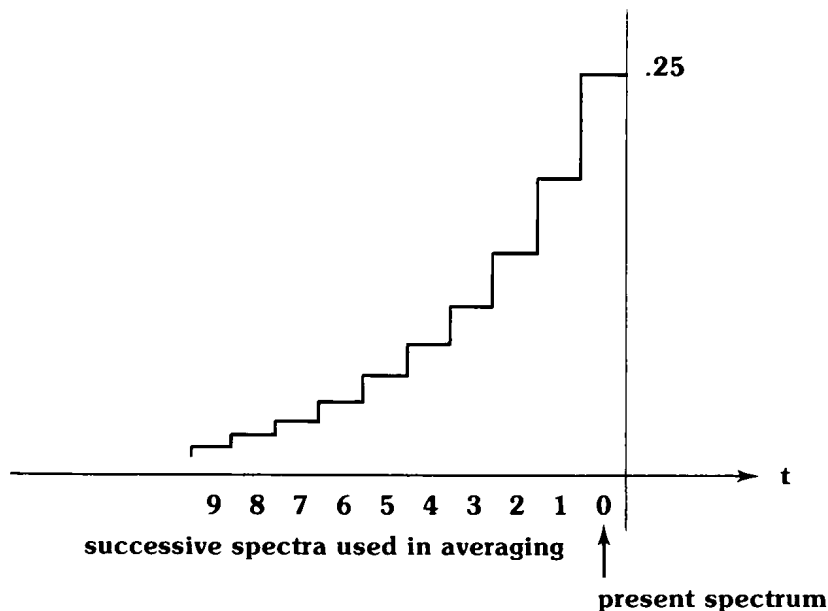

SECTION 6:

Characteristics of 3582A averaging routines

Power spectrum averaging. The 3582A computes a power average as follows: the FFT produces both a real and an imaginary spectrum component at each analysis frequency. These components are squared and added. For each successive transform, the same operation is performed, and a cumulative sum is maintained for each data bin. Thus, for a K-sized average (K is a power of 2, chosen between 4 and 256), each bin contains the sum of 2K squared values at the end of processing.

This sum is then divided by K, which converts it to the power spectral value for that bin. This process, performed independently for each of the 256 bins, generates the power spectrum average. Before display, the square root of each sum is extracted to produce the amplitude spectrum. The main reason for this step is convenience of units; for instance, volts is usually more appropriate than (volts)². Because of the square root operation, the control button which calls up this averaging routine is labeled "RMS" rather than "POWER."

With the power averaging routine, there is also available a phase display, but it is not a power-averaged quantity, since the power spectrum is phaseless. Rather, for each transform, the phase angle of each bin is computed conventionally as

$$\text{phase} = \tan^{-1} \left(\frac{\text{imaginary component}}{\text{real component}} \right)$$

and the K resulting numbers are simply averaged for the display.

While power averaging is proceeding, the user can watch the interim averages on the display. (However, the averaging process will proceed more quickly if the display is turned off, since this eliminates the need for intermediate root-taking and display formatting.) Also, if further averaging seems desirable after the K spectra are averaged, pressing a higher-numbered button will continue the process to the new value of K.

Exponential averages. Another variation of power averaging is the "moving" or exponential average. As the name suggests, this form of average gives more weight to the most recent measurements. In the 3582A, moving averages are calculated by weighing the latest spectrum by 1/4 and adding it to the previous average, weighted by 3/4. The result is that the Mth spectrum before the present one is given the weight $1/4(3/4)^M$. The standard deviation of an estimate from this averaging routine is about 8 dB less than a single FFT spectrum estimate. The weighting function is shown in Figure 4.

Moving averages are especially useful in cases where the random process is not stationary; that is, when the mean and/or variance of the random process changes with time.

Time averaging. The 3582A computes this type of average as follows: K successive, *synchronized* time records are added, and the sum is divided by K (K is chosen as a power of 2 from 4 to 256). The result is the time domain average. Both the time average and its transform are available for display, so that the result of the S/N enhancement may be observed in either time or frequency domains.

Two methods are available for applying the necessary synchronizing (triggering) signal used with time averaging:

- a) Internal triggering. The trigger signal is applied to Channel A, using the polarity and level controls to establish reliable triggering. (The internal trigger circuitry is only connected to Channel A.) Then the signal to be averaged is connected to Channel B.
- b) External triggering. The TTL-compatible trigger signal is applied to the rear panel connector, and the adjacent switch is set to "ext. trig." Then any combination of channels may be used for the signal(s) to be averaged.

Time averaging is a relatively fast procedure, requiring only slightly more time than that necessary to acquire the K time records. This is because only one FFT operation is performed, rather than K, as in the case of power averaging. (In the 3582A an FFT takes about 350 milliseconds.)

There is no exponential (moving) average routine for the time average procedure. Attempting this causes an error message to be displayed on the CRT.

Peak "averaging." This procedure is not truly averaging, but rather a peak holding process: K transforms are made (K is 4, 8, . . . , 256), and each set of data is compared, bin for bin, with the previous set. The larger number is then retained, with the result that, at the end of the procedure, each bin contains the largest data value encountered during the processing of the K signal segments.

Applications include noise monitoring, measurement of frequency drift, and the like. If continuous monitoring is wanted (that is, no limit on the size of K), pressing the "EXP" key will cause peak averaging to continue indefinitely.

SECTION 7:

Examples

In this section we have included the results of several actual measurements using the 3582A. These were chosen in order to illustrate the material discussed so far, and enough information is included to enable the reader to try similar experiments if he chooses. Each example includes a measurement block diagram and photos of the 3582A display screen, as well as relevant control settings and discussion.

Examples of RMS (power) averages. In Section 3 we stated that averaging a number of FFT spectra of a random process gives an estimate of the true spectrum which is more accurate than any single transform. Figure 5 illustrates this point. The signal being analyzed is a random binary data stream, whose transitions are clocked at a 1-kHz rate. A 50-bit segment of the signal is

shown in (a), along with the Fourier transform of the segment. Although the spectrum is an accurate frequency domain representation of that *particular* sample of the entire signal, one sample alone gives a poor and misleading indication of the characteristics of the whole process. A much better estimate of the spectrum of the process is shown by the power average of 64 spectra, in (b).

The control settings can generally be inferred from the self-documenting display. Other data of interest are:

- The Hanning passband was used for good resolution.
- For the single sample, the REPETITIVE button was out (off) and a single record was captured by pressing ARM.

Figure 5.

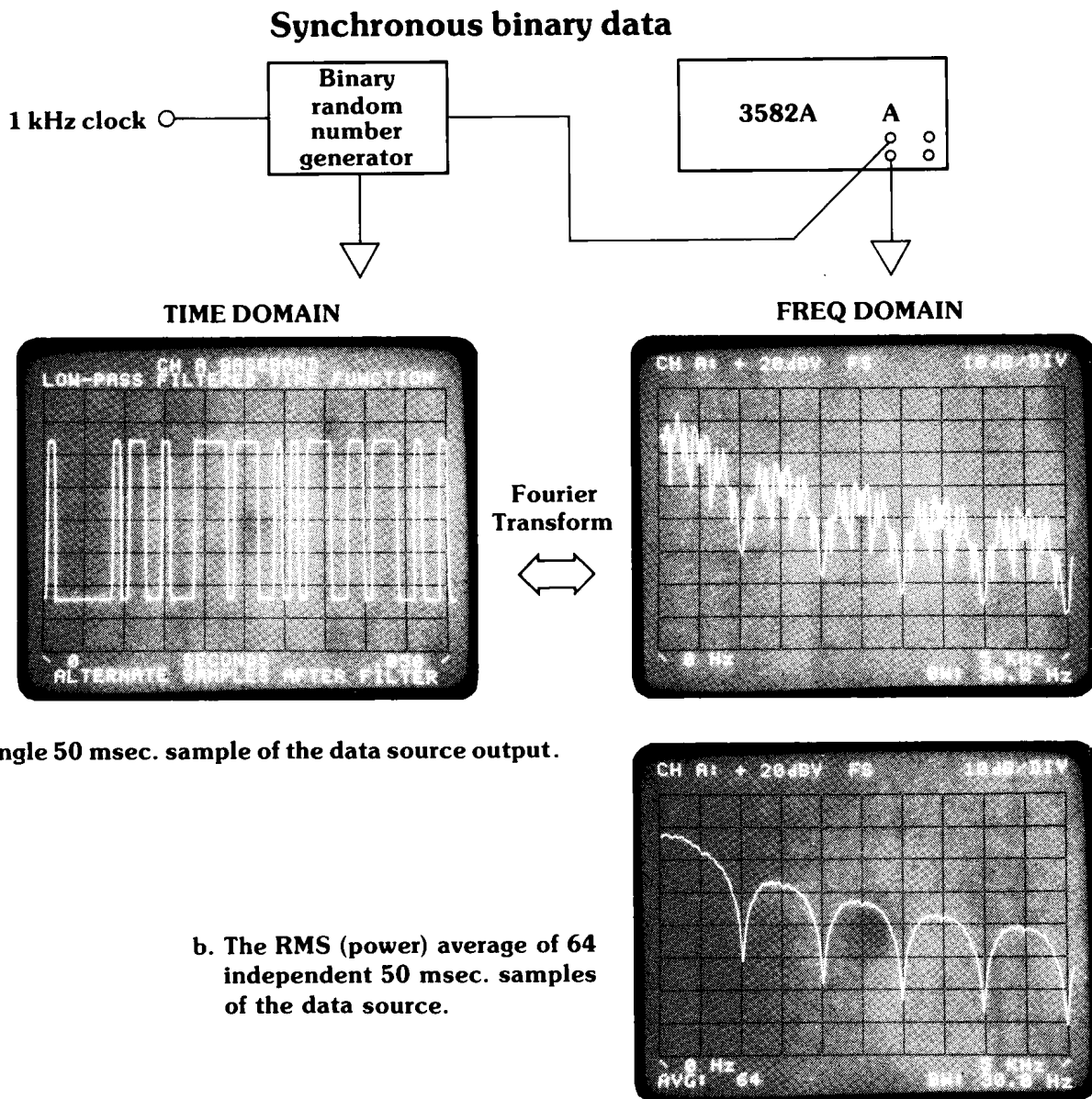

Another power averaging example.

There are some random processes whose statistics vary considerably over short intervals of time, but which are more stable (statistically "stationary") in the long run. Human speech is a good example. In the experiment of Figure 6, the object was to determine quantitative spectral differences between adult male and female voices. A common-speech script was chosen, which each speaker read for about two minutes, enough time to process 256 spectra. The individual spectra varied widely; some corresponded to time segments between words and had little energy. After 40 or 50 spectra were averaged, however, the long-term trends became evident. Several 256-spectrum averages from the same speaker showed differences of less than 3 dB.

In performing the experiment, the first step was to acquire and process the time records from the first speaker. After completing the RMS averaging, the display amplitude reference level was shifted 30 dB higher

(to separate this data from the next, when displayed simultaneously) and then stored in TRACE 1. The second speaker's voice was then averaged in the same way. When this was completed, the two traces were displayed together for comparison. Hanning passband shape was used throughout the experiment.

Examples of time averaging. As we discussed in Sections 1 and 2, a principal feature of time averaging is the use of a synchronizing signal to insure that each time record used in the average contains the deterministic waveform in the same relative position.

Figure 7 is the block diagram and measurement results showing how a signal can be extracted from noise by this technique. Since Channel A in the 3582A is the only one from which an internal trigger may be derived, it is used in this experiment to trigger the data acquisition. The analysis is carried out in Channel B, to which the noisy signal is connected.

Figure 6.

Human voice spectrum

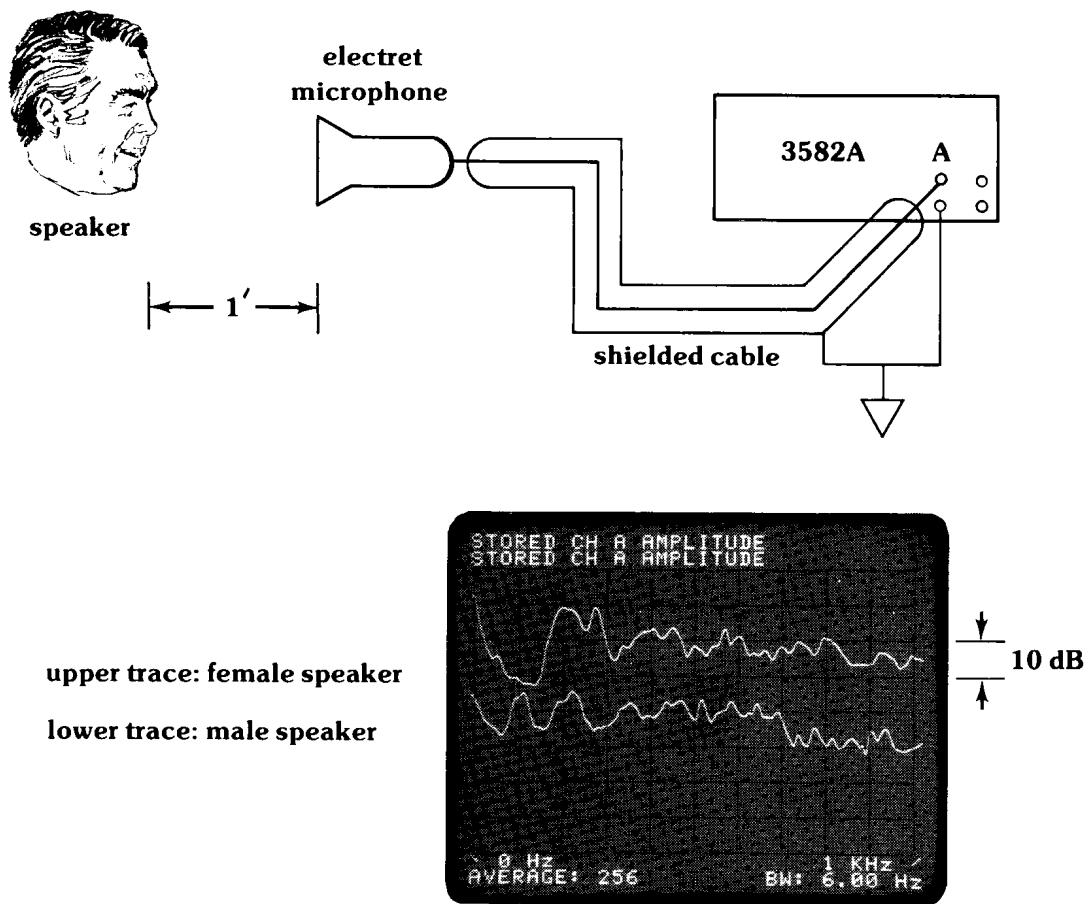

traces were separated 30 dB for clarity

The procedure followed was:

- a) Set up the controls as follows:
 Display: Amplitude A, 10 dB/div, ref. level normal
 Passband shape: Hanning
 Average: off
 Marker: off
 Span: 0-25 kHz
 Trigger: + slope, repetitive
 Input: A, AC coupling A & B
- b) Connect the pure squarewave to A. Holding in the Time A button, adjust Channel A Sensitivity for about half scale display. Then adjust Trigger level for reliable sync.
- c) Switch display and input mode to B. Connect

- d) the noisy signal to Channel B. Adjust B Sensitivity as in (b).
- e) At this point, the single record photographs were made by momentarily turning off the Repetitive control (button out).
- f) In the Average block of controls, push Time, 8/128, and Shift keys. This starts the averaging process.

Some interesting observations may be made from these results. First, the spectrum photos show a noise reduction of roughly 20 dB, which agrees well with the theoretical value of $10 \log 128$. Second, the noise is not "smoothed" by time averaging: its relative standard deviation appears about the same in both the single and the averaged spectra.

Figure 7. Squarewave plus noise

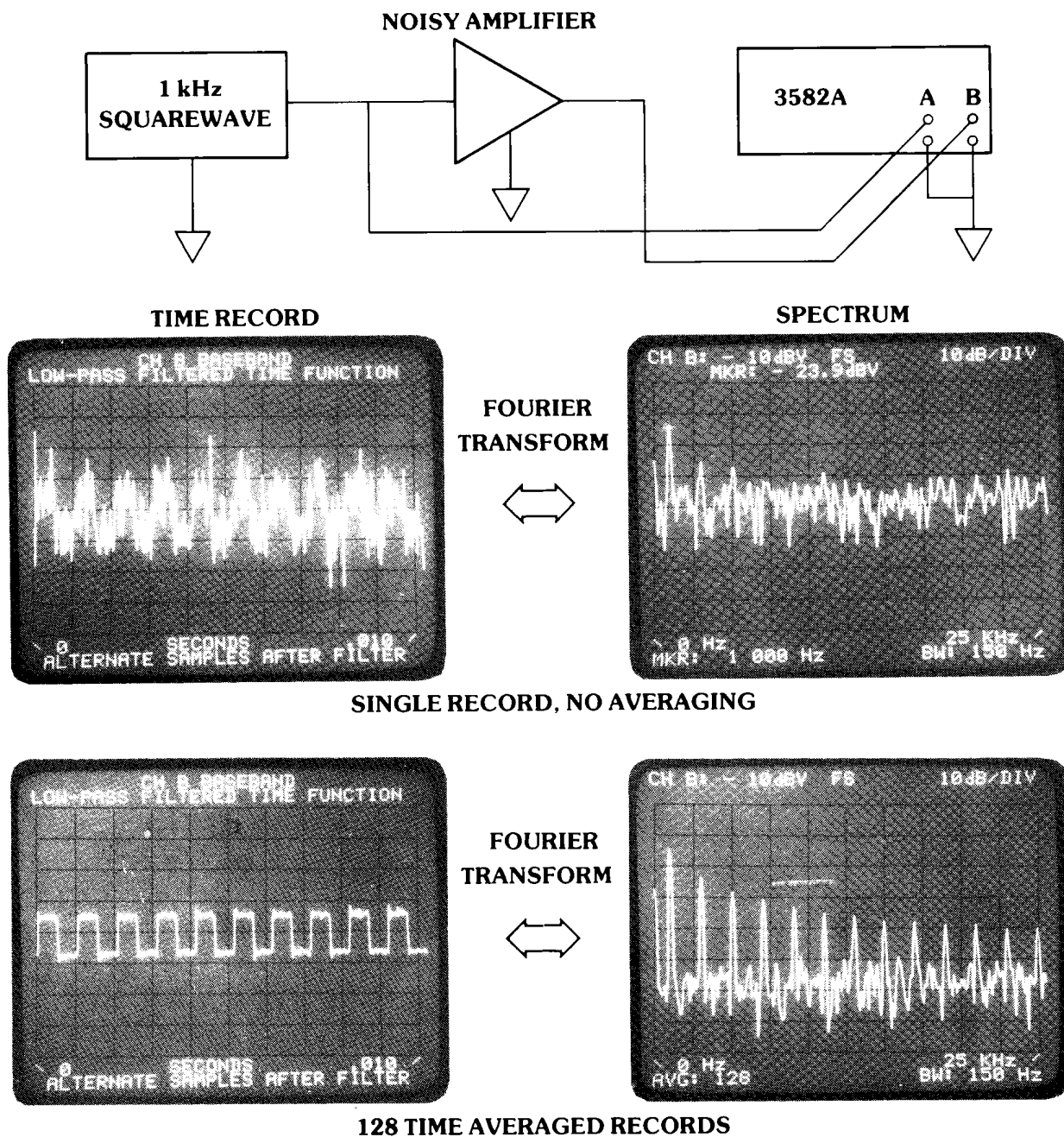

Self-Synchronizing

Sometimes the required synchronizing signal can be derived from the signal to be averaged. This is true when there is a portion of the deterministic waveform which is large compared with the peak noise. Such a situation is shown in Figure 8 which also demonstrates that time averaging can be used with a non-periodic signal. In this case, a tuned circuit is impulsed at irregular intervals, resulting in an identical transient each time. The negative leading edge of the transient was sufficiently higher than the noise to serve as the trigger. Control settings were similar to the previous example, except that Channel A was used for both trigger and analysis, and 32 averages were taken. Also, the uniform passband was used, as is normal with transient analysis. (The uses of the three available passbands are explained in the operating manual.)

A test to see whether a signal can self-trigger in time averaging is to observe the time waveform after some averaging has occurred; if the deterministic waveform seems to diminish or change form as averaging proceeds, there is too much jitter, and a separate trigger must be used.

Example of peak averaging. As we mentioned already, peak averaging is not truly an averaging process; rather, it is a means of comparing successive spectra and saving the largest amplitudes encountered at each analysis frequency.

A popular use of this feature is monitoring the frequency drift of some device which nominally operates at a constant frequency. For instance, a motor's speed may vary due to load, temperature, etc. Using a tachometer as a speed-to-frequency transducer, the peak average routine of the 3582A will reveal the maximum excursions of the speed over the test time.

Figure 8. Transient signal in noisy channel

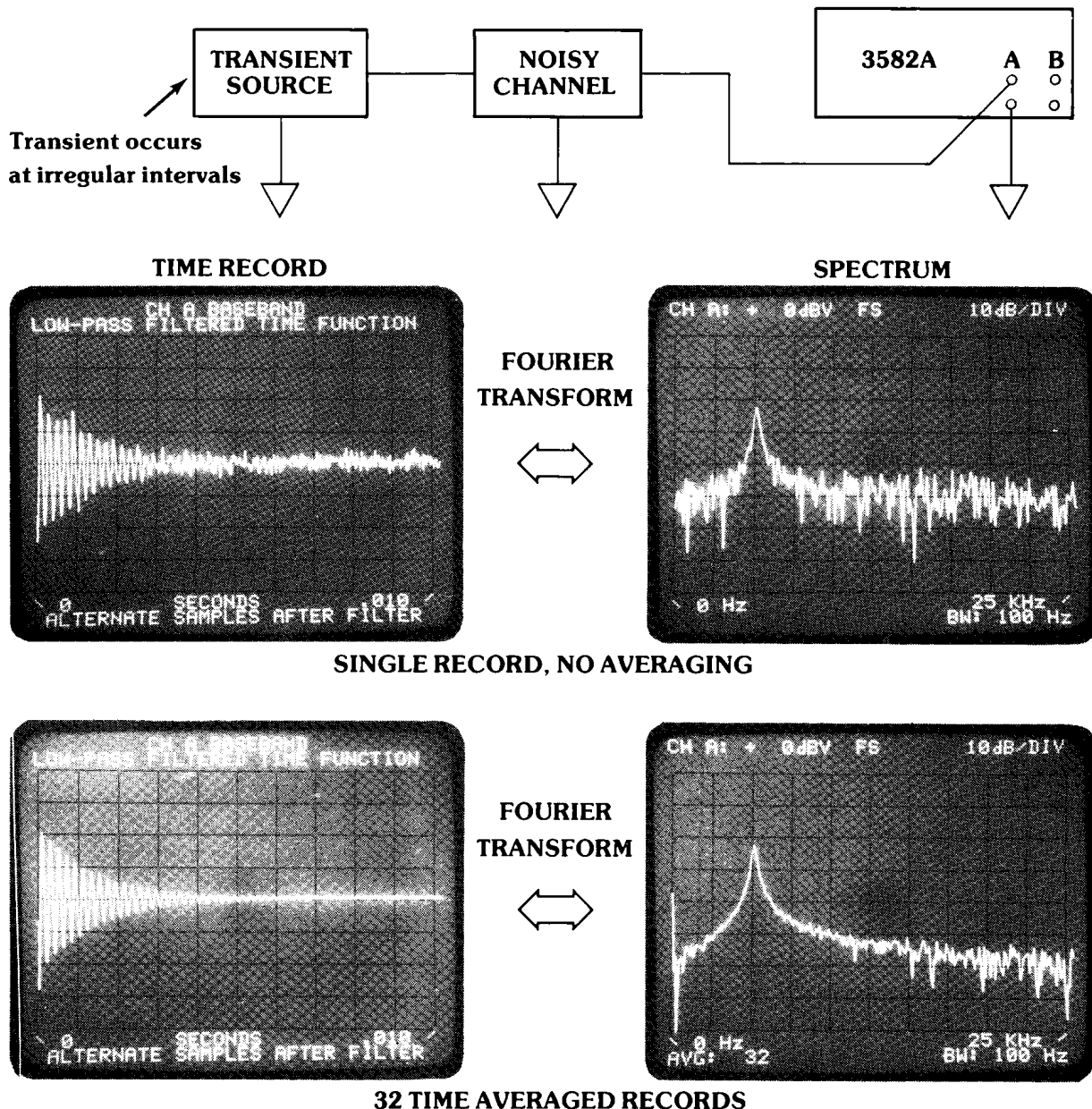

The example used here is similar. An electronic signal generator varies in frequency in a slow, periodic way. When this action is deliberate, it is called a “sweep generator.” In Figure 9 such a source is shown connected to the 3582A for analysis of its peak-to-peak frequency excursion. Since the source was a programmable frequency synthesizer whose excursion could be accurately set, the experiment was really intended to check the 3582A. The result, shown in the spectrum photo, is accurate. Using the marker dot would improve the accuracy to 2 Hz resolution.

Some information on the setup is:

- a) The Hanning passband was used, since its narrow peak is more useful for frequency measurements than the broader peak of the flat top passband.
- b) The 3582A was operated to process an unbounded number of spectra; this is done by pressing both 32/EXP and SHIFT keys in the averaging section. When the test was stopped, more than 5000 spectra had been examined.

One word of caution for this kind of measurement: the signal being analyzed should not change frequency too fast, or the analysis will be smeared and inaccurate. A good rule is that the frequency change should not exceed 2% of the analysis span during the time record. For the 3582A, this rule can be formulated:

$$\text{frequency rate-of-change} < \frac{(\text{analysis span})^2}{12500} \text{ Hz/sec}$$

The experiment of Figure 9 met this criterion, since

$$\text{frequency rate} = \frac{2 \times (22150 - 21950)}{33.3} = 12 \text{ Hz/sec}$$

is less than

$$\frac{(500)^2}{12500} = 20 \text{ Hz/sec}$$

The rule is not as restrictive as it sounds. Higher sweep rates cause the appearance of distinct sidebands in the analysis. The frequency excursion can then be calculated from frequency modulation theory. This is beyond the scope of the application note, however.

Figure 9.

Slowly swept source

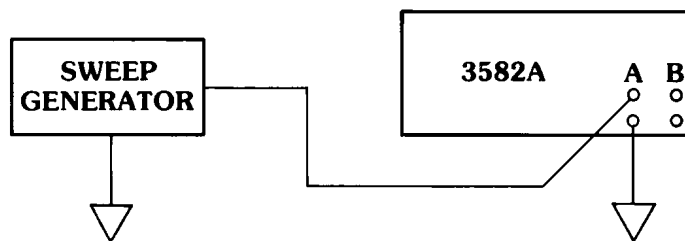

Peak hold “averaged” spectrum

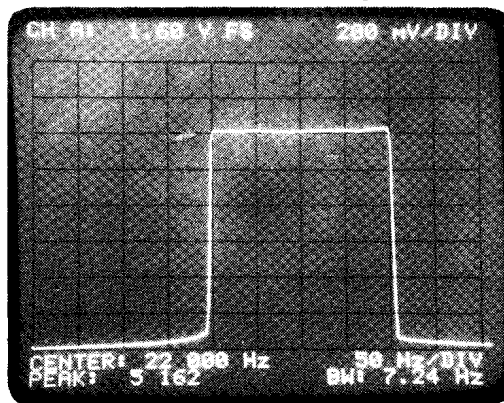

Sweep generator settings:

- $f_{min} = 21950 \text{ Hz}$
- $f_{max} = 22150 \text{ Hz}$
- sweep rate = 33.3 sec/sweep

5,162 separate spectra were measured and compared to derive this peak value envelope.

APPENDIX 1:

Probability distributions of power spectrum estimates

Gaussian random processes. If the input time signal to an FFT analyzer is a Gaussian random process, the output frequency variables are also Gaussian. This is because the Discrete Fourier Transform is a **linear** operation on the input. It can be shown that, at each frequency, there are two independent Gaussian random variables, which are the real and imaginary spectral components at that frequency. The two components have zero means and identical variances. From this fact, we conclude that the spectral power is equally divided between the real and imaginary spectral components.

The averaged power spectrum as a random process. The power at any frequency is the sum of the squares of the real and imaginary spectral components. This sum itself is a random process, being a function of two independent random processes. However, the prob-

ability distribution is no longer Gaussian, but “chi-squared.” The sum of K independent, zero mean, unity variance, *squared* Gaussian random variables is the chi-squared variable of order K . The square root of the second-order chi-squared variable is called the Rayleigh variable. Hence the magnitude spectrum of the D.F.T. is Rayleigh distributed. In the power spectrum averaging procedure described in Section 3, the average of K spectra is computed from the sum of $2K$ squared components. From the above discussion, it is apparent that the probability distribution of the sum is chi-squared, of order $2K$. Since the chi-squared variable is a standard, tabulated quantity, it is possible to calculate whatever statistical parameters one needs to know. The confidence table below was calculated on the basis of the 0.05 and 0.95 tails of the appropriate chi-squared distribution.

APPENDIX 2:

90% confidence limits for power averages

To use the table, first decide on the allowable statistical tolerance in dB. Then find the number of averages whose 90% limits are within the tolerance bounds. For instance, if we can tolerate a ± 2 dB accuracy band, then the 16-average routine is what we need. Remember that the limits given are statistical, not absolute. That is, they state that, *on the average*, the true value of amplitude will lie within the stated bounds in 9 out of 10 measurements.

	K = number of averages						
	4	8	16	32	64	128	256
Upper limit dB	+4.7	+3.0	+2.0	+1.4	+1.0	+0.7	+0.5
Lower limit dB	-2.9	-2.2	-1.6	-1.2	-0.8	-0.6	-0.4

As an example of use, suppose that a random noise source has been measured, and that 32 spectra have been power averaged. Using the marker readout, the 1000 Hz bin shows a signal level of -55 dBV. The table can be interpreted in this case to indicate that the true signal amplitude has a 90% probability of being in the range of -53.6 dBV to -56.2 dBV.

Bibliography

1. “Random Data: Analysis and Measurement Procedures,” J. S. Bendat and A. G. Piersol, John Wiley 1971. This is a fundamental text covering both analog and digital analysis of random processes. Chapters 3 and 4 provide the background for understanding the nature of random processes and measurements made on them. Chapter 6 details the errors encountered in several kinds of measurements on random processes.
2. “Digital Time Series Analysis,” R. K. Otnes and L. Enochson, John Wiley 1972. This deals specifically with computer analysis of random processes.

MEASURING THE COHERENCE FUNCTION WITH THE HP 3582A SPECTRUM ANALYZER

AN 245-2

FOREWORD

The Fast Fourier Transform algorithm and the development of powerful LSI devices are producing a revolution in the design of signal analyzers. The 3582A Low Frequency Spectrum Analyzer is based on this new technology and provides both greatly increased measurement speed and several kinds of measurement not available in traditional analog instruments.

One of the new measurements available in the 3582A is called the coherence function. If you have encountered problems with noise when measuring transfer functions, the coherence function will help to pinpoint where the difficulty lies. Similarly, if you are trying to determine whether one signal is wholly or partly responsible for an-

other, the coherence function will help because it indicates causality.

Although the coherence function has been a relatively unfamiliar statistical parameter, its usefulness is becoming apparent to the growing number of persons who need to analyze low frequency signals. Having the coherence function internally computed and available for display in the 3582A and similar instruments will, of course, increase interest in understanding its properties. This application note is intended both as an initial contribution to this understanding and as an encouragement to 3582A users to utilize the coherence function in solving their measurement problems.

THE HEWLETT-PACKARD MODEL 3582A SPECTRUM ANALYZER

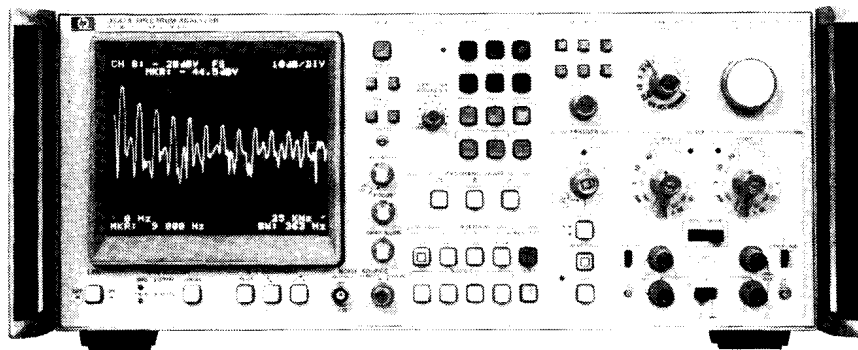

The HP 3582A is a spectrum analyzer covering the frequency range of DC to 25 kHz. Although it is a FFT-based, digital instrument, a special design effort has made it as straightforward to use as a conventional swept analyzer. With dual measurement channels it is possible to measure transfer function gain and phase, as well as the coherence function. A built-in random or pseudo-ran-

dom noise source, whose spectrum tracks the analysis range, is a useful measurement stimulus. Band Selectable Analysis enables narrowband, high resolution analysis to be applied to any portion of the frequency range. The instrument comes equipped with a flexible HP-IB interface for control and two-way data transfers.

TABLE OF CONTENTS

	Page
Section 1: Some system measurement problems	1
Transfer function measurements	
Cause-effect relations	
This section describes two classes of measurements and indicates the role of the coherence function in each.	
Section 2: Introducing the coherence function	2
What is it?	
The role of the coherence function in spectrum averaging	
A note of caution	
Summary of how the coherence function is used	
A brief discussion of the coherence function, its properties and its interpretation is followed by the reasons why it is usually associated with spectrum averaging. A possible problem in interpreting the coherence function is explained.	
Section 3: The coherence function and the 3582A	3
Transfer function measurements	
Causality measurements	
A specific procedure for using the coherence function to assess the validity of measured transfer functions is given. Another procedure is outlined for measurement of the coherence function itself. For each case, 90 percent statistical confidence tables are provided for quantitative interpretation of the measurements.	
Section 4: Experimental examples using the coherence function	5
Example 1: monitoring a transfer function measurement	
Example 2: dual-input system with random signals	
Here are the results of two experiments which illustrate the two principal roles of the coherence function.	
Appendix: Definitions and interpretations	8
Linear spectra and power spectra	
Mathematical definition of the coherence function	
Interpreting the coherence function as a power ratio	
Interpreting the coherence function as a correlation coefficient	
The use of the cross power spectrum to calculate transfer functions	
Mathematical definition and interpretations of the coherence function were left out of the main body of the application note, but are included here for fuller understanding.	
Bibliography	9

Section 1:

Some system measurement problems

Transfer function measurements and the coherence function

Many engineering problems are solved through determining how signals are modified in amplitude and phase as they pass through a system. Transfer function measurement, as this is called, is often made with a network analyzer. This is a specialized instrument which provides a driving signal and can measure the input/output amplitude ratio and phase shift over a band of frequency. Figure 1 shows a typical setup. An excitation signal, such as a swept sinewave or a broadband source, is applied to the input of the system being checked. The system output—its response to the excitation—is measured and the transfer function is calculated. For the calculation, both input and output are in the form of frequency functions.

In “real life” situations, sometimes complications come up which render this kind of measurement inaccurate or even useless. The problem is the presence of additional signals in the output of the system. One kind of disturbing signal is noise, whether internal to the system or external. Another disturbance takes the form of distortion products generated by system nonlinearities. In either case, the disturbing signals affect the accuracy of measuring the linear input/output relation.

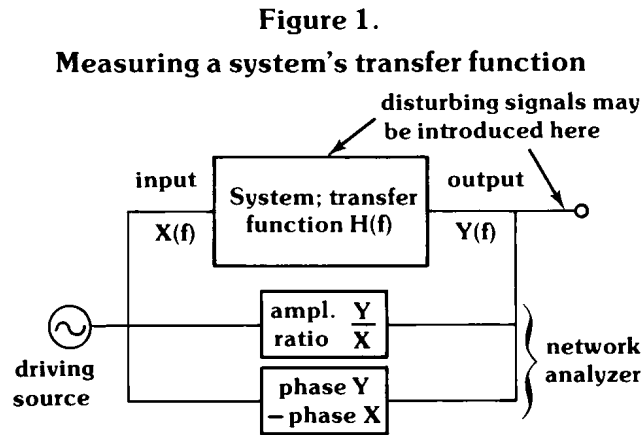

It is evident that determining the transfer function $H(f)$ by calculating the spectral ratio $Y(f)/X(f)$ will lead to irrecoverable errors whenever there is a disturbing signal included with the output $Y(f)$. The 3582A reduces these errors through a computational technique: it uses the cross power spectrum (see appendix) and spectrum averaging. The question remains, however, how many averages are needed to attain a desired accuracy?

Another kind of transfer function problem is the multiple-input system represented by Figure 2. In this case, the signal Y at the output is a composite of energy from several sources X_1, X_2 , etc. This situation may be intentional or unintentional. We want to determine the transfer function from each input to the output; in general, these are not identical. An obvious way to do this is to turn off

all sources and to apply the network analyzer to each path in turn. However, this can't always be done or is often undesirable (vibration measurement on a 4-engine aircraft, for example). Thus, it becomes necessary to measure the desired transfer function in the presence of signals from other sources. The 3582A can perform this measurement, but, again, we have to answer the question of how many spectra must be averaged to achieve a given accuracy.

We shall show in Section 3 how the coherence function may be used to determine the number of averages needed.

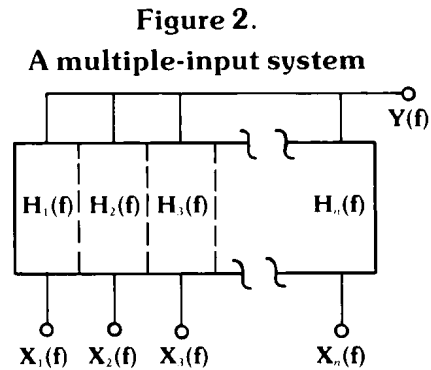

Cause-effect relations and the coherence function

Figure 2 serves as the model for another engineering problem. In this case, the exact shape of the transfer function between any input and the output is not needed. Rather, we are looking for causality; that is, we want to determine how much each source influences the observed output Y . For instance, which machine in a shop is most responsible for the noise at a given location? Which is least responsible? Traditionally, this measurement, when made at all, has relied on determining the cross-correlation function between the suspected source and the output signal Y . The coherence function will also reveal these causality relations, but it has an additional advantage over the cross-correlation function. The cross-correlation function is a function of time, and its maximum value corresponds to the approximate time delay (that is, propagation time) between the source and the observed effect Y . However, the coherence function is a function of frequency, and its maximum values occur at the **frequencies** where the greatest transfer of energy is taking place. The remedies used to suppress interference (noise, vibration, etc.) depend on the frequency distribution of the interference. Therefore, the coherence function not only reveals the degree of causality but is a direct aid in choosing the best means to solve the interference problem.

An example of the use of the coherence function in this application will be given in Section 4.

Section 2: Introducing the coherence function

What is it?

Leaving the mathematical definition for the appendix of this note, we can summarize the important features of the coherence function:

- a) it is a dimensionless, frequency-domain function.
- b) its range of values is 0 to + 1.
- c) at **each** frequency, it represents the fraction of the system output power directly related to the input.

With these properties, the coherence function is rather like a cross-correlation function in the frequency domain. (This interpretation is developed in the appendix.) If the system in Figure 1 has no contaminating noise, or there is only one input to the system in Figure 2, the coherence function is + 1 at every frequency where there is any output energy.

On the other hand, if $X = 0$ or $H = 0$ at some frequency (so that noise is the only output), the coherence function is zero for that frequency.

When the coherence function is less than unity, at least one of the following conditions exists:

- a) there is noise contaminating the measurement
- b) the system is nonlinear (and generating energy at additional frequencies)
- c) other inputs are present in the system.

The role of the coherence function in spectrum averaging

In reading material on the coherence function, one soon notices that it is almost always discussed and used in the context of spectrum averaging. There are two principal reasons for this. First, in some situations there is unwanted noise contaminating the measurement—such as the transfer function measurement. To compute the transfer function, the 3582A makes use of the cross-power spectrum and relies on averaging to increase the signal-to-noise ratio. The role of the coherence function in this case is to give an indication of how many averages are needed to achieve a given statistical accuracy.

The second reason for the association of the coherence function with spectrum averaging concerns the use of the FFT algorithm. When the FFT is used to calculate the coherence function, a single transform results in a value of unity for the coherence function regardless of its true value. A number of transforms must be averaged to produce a useful (that is, accurate) estimate of the coherence function itself.

For these reasons, the 3582A provides computation and display of the coherence function only in conjunction with the power spectrum averaging routing (called “RMS” averaging on the front panel).

Statistical accuracy vs. instrument accuracy.

In discussing accuracy improvement through averaging, we must point out that we mean **statistical** accuracy and not instrument accuracy. Statistical errors occur because we can measure only a finite sample of a signal. In general, the longer the sample, the smaller is the statistical error. Averaging is one way of measuring a longer sample.

On the other hand, there is always the problem of instrumentation errors. They exist for the traditional reasons of component tolerance, aging, misadjustment, etc., and they are usually not reduced by averaging. So the discussion of the role of the coherence function in accuracy improvement refers only to statistical accuracy.

For further discussion of the use of spectrum averaging in the measurement of noisy or noise-like signals, we refer the reader to the companion Application Note, 245-1 “Signal Averaging With the HP 3582A Spectrum Analyzer.”

A note of caution

As useful as the coherence function may be in resolving some of the measurement difficulties mentioned, it is not a panacea. There is one situation in particular in which the user must guard against misinterpreting the information contained in the coherence function. This occurs most commonly in causality measurements and often involves signals at AC powerline frequencies.

For example, suppose the problem is that AC magnetic flux is leaking into a sensitive electronic circuit, and that one of several nearby transformers is suspected to be the culprit. Using appropriate transducers and the 3582A, we measure the coherence function between the circuit and each transformer. **Each** measurement produces a value of + 1 at the powerline frequency and several of its harmonics. The experiment is saying that **each** transformer is completely responsible for the interference! This anomaly is caused by the fact that every transformer is wired to the same power source, which is the primary source of the disturbance.

The principle to remember is: if two or more sources are related to (caused by) a primary source, then the coherence function will not reveal the secondary causal relations we want to determine.

This can be a difficult problem in some situations. It can **sometimes** be solved through the more complex techniques of multiple coherences (Ref. 3). Of course, if we can arrange to turn on the sources one at a time, the solution is easy!

Summary of how the coherence function is used

In Section 1 we discussed two broad classes of measurements in which the coherence function has an important role: transfer function measurements and determining causality. The contribution of the coherence function to each of these may be summarized:

- a) Transfer functions. The basic technique used to improve the measurement accuracy is spectrum

averaging. The coherence function is an indicator by which we can determine the number of averaged spectra needed to achieve a desired accuracy.

- b) Causality. At every frequency being analyzed, the coherence function directly indicates causality. Its value is interpreted as the fraction of system output power than can be attributed to the input.

Section 3:

The coherence function and the 3582A

In this section, we outline suggested measurement procedures for the 3582A. Both transfer function and causality measurements are included. There are also tables to help you determine the statistical accuracy of your measurement.

Transfer function measurements

When noise or other signals unrelated to the input are present in the output, the 3582A Transfer Function routine can employ RMS averaging to improve the statistical accuracy. In this note, we use the "90% confidence limit" approach to quantify the accuracy. This means that there is a band of values (given in dB) around each measurement of the transfer function amplitude. The true amplitude will lie within the band in 9 out of 10 measurements **on the average**. For transfer function phase, the idea is the same, but the measurement band is given in degrees.

The following procedure can be used to detect regions of noise contamination and to get acceptable statistical accuracy in measuring the transfer function.

- a) Set up the transfer function routine on the 3582A, using the built-in noise source or another drive signal which covers the frequency range of interest.
- b) Execute 16 or more RMS averages.
- c) Display amplitude and coherence (or phase and coherence).

- d) Use Table 1 to determine whether the measurement is sufficiently accurate in regions where the coherence is low or where high accuracy is desired. If not, more spectra can be averaged by pressing a higher-valued "number of averages" button.
- e) Repeat if necessary.

Causality measurements

For measuring causality the desired result is the value of the coherence function itself. If this is not +1, then some averaging must be performed in order to get a statistically accurate measure of its true value (see Section 2).

This procedure should yield acceptable results:

- a) Set up the coherence measurement on the 3582A, connecting the source being investigated to Channel A and the system output to Channel B.
- b) Execute 16 or more RMS averages.
- c) Display the coherence function. Using Table 2, determine whether the measurement is satisfactory. If not, continue averaging by pressing a higher-valued "number of averages" button.
- d) Repeat as necessary.

Table 1

90% confidence limits on the measurement of the amplitude $|H|$ and phase ϕ of transfer functions, as a function of the measured value of coherence and the number of averages.

Measured value of coherence function	Number of Averages				
	16	32	64	128	256
0.2	+ 5.2	+ 3.8	+ 2.8	+ 2.1	+ 1.5
	- 14.6	- 7.1	- 4.2	- 2.7	- 1.8
	(± 54)	(± 34)	(± 23)	(± 16)	(± 11)
0.3	+ 4.2	+ 3.1	+ 2.2	+ 1.6	+ 1.2
	- 8.4	- 4.8	- 3.0	- 2.0	- 1.4
	(± 38)	(± 25)	(± 17)	(± 12)	(± 8)
0.4	+ 3.5	+ 2.6	+ 1.8	+ 1.3	+ 1.0
	- 6.0	- 3.6	- 2.3	- 1.6	- 1.1
	(± 30)	(± 20)	(± 14)	(± 10)	(± 7)
0.5	+ 3.0	+ 2.1	+ 1.5	+ 1.1	+ 0.8
	- 4.5	- 2.8	- 1.9	- 1.3	- 0.9
	(± 24)	(± 16)	(± 11)	(± 8)	(± 5)
0.6	+ 2.5	+ 1.8	+ 1.3	+ 0.9	+ 0.7
	- 3.5	- 2.2	- 1.5	- 1.0	- 0.7
	(± 19)	(± 13)	(± 9)	(± 6)	(± 4)
0.7	+ 2.1	+ 1.5	+ 1.0	+ 0.7	+ 0.5
	- 2.7	- 1.7	- 1.2	- 0.8	- 0.6
	(± 15)	(± 10)	(± 7)	(± 5)	(± 4)
0.8	+ 1.6	+ 1.1	+ 0.8	+ 0.6	+ 0.4
	- 2.0	- 1.3	- 0.9	- 0.6	- 0.4
	(± 12)	(± 8)	(± 6)	(± 4)	(± 3)
0.9	+ 1.1	+ 0.8	+ 0.5	+ 0.4	+ 0.3
	- 1.3	- 0.8	- 0.6	- 0.4	- 0.3
	(± 8)	(± 5)	(± 4)	(± 3)	(± 2)

For each entry, the first two digits are the upper and lower bounds on $|H|$, in dB.

Digits in parentheses are the bounds on ϕ , in degrees.

(Data compiled from formulas in Ref. 3, p. 202.)

Table 2

90% confidence limits on coherence function measurements.

Entries in table are min, max limits.

Measured value of coherence function	Number of Averages				
	16	32	64	128	256
0.4	.15, .59	.23, .54	.28, .50	.32, .47	.34, .45
0.5	.25, .67	.33, .63	.39, .59	.42, .57	.45, .55
0.6	.36, .74	.45, .71	.50, .68	.53, .66	.55, .64
0.7	.50, .81	.57, .78	.61, .76	.64, .75	.66, .73
0.8	.65, .88	.70, .86	.74, .84	.76, .83	.77, .82
0.9	.81, .94	.85, .93	.87, .92	.88, .92	.88, .91

Section 4:

Experimental examples using the coherence function

Example 1: Using the coherence function to monitor a transfer function experiment

The purpose of the experiment indicated by Figure 3 is to demonstrate that transfer function measurements are susceptible to contamination by signals other than the intended input, and to show how the coherence function reveals the existence of such signals.

We measured the relative mechanical inertance of a small structure: a 5" by 7" by .062" printed circuit board. Inertance is acceleration/force, and this quantity was measured as a transfer function by connecting an accelerometer output to Channel B and the pseudo-random driving signal to Channel A. (A small shaker converted the electrical driving signal to mechanical force.) Modal vibration resonances are clearly indicated in the inertance spectrum, which is displayed in Figure 3(a) along with the coherence function. Except for zero frequency, where the accelerometer output is zero, the coherence function is unity nearly everywhere else, indicating a good measurement environment (in the sense of signal/noise ratio). One exception occurs at the 100 Hz resonance. Here, the coherence function has decreased to about 0.83, indicating a signal/noise ratio of $.83/1 - .83$, or about 7 dB (see appendix for using the coherence function to calculate a S/N ratio). This effect oc-

curred because, at this frequency, the accelerometer output was low, approaching the noise level of the analyzer.

Without changing anything else, we made a minor modification before running the experiment again. This was to drop a small screw into a hole in the test board. The mass of the screw only slightly lowered the resonant frequencies, but its looseness caused it to vibrate against the board as excitation was applied. Within the experimental structure we thus created a non-linear element which converted (that is, smeared) some of the input energy to other frequencies. As Figure 3(b) shows, not a lot of energy was converted, since the coherence function is generally high. However, at just those places where we would expect signal/noise problems—where the response signal is small—the effect of the smeared energy is apparent. An interesting exception is the strong 260 Hz resonance, which is only lightly affected; this means the energy generated by the vibrating screw is not uniformly distributed in frequency.

The principal use of the coherence function in measurements of this sort is to alert the person performing the measurement that there **is** a signal/noise problem and to give him information about the frequencies and magnitudes of its occurrence.

Figure 3.

Vibration spectrum of 5" x 7" printed circuit board.

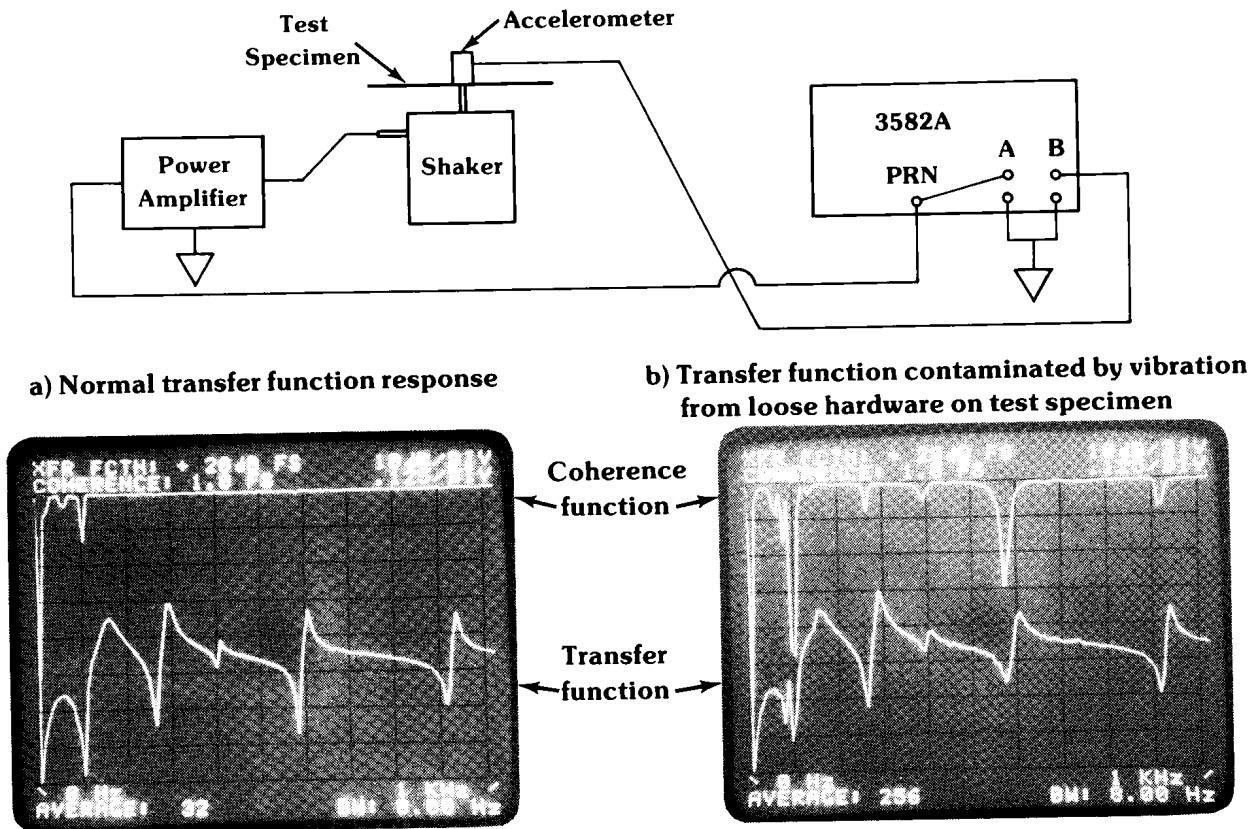

c) Test setup. The “loose hardware,” a 10-32 screw inserted through a hole in the test board, is visible in right front corner of board. Device on top of analyzer is power supply for accelerometer.

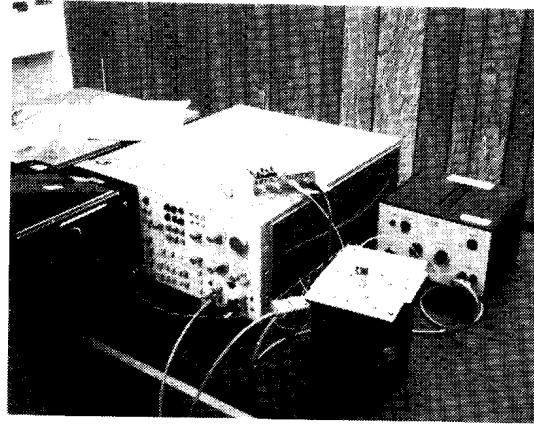

Experiment 2: Dual-input system with random signals

The main purpose of the experiment of Figure 4 is to show how the coherence function is used to separate the individual effects of input signals which are combined in a system to form a common output signal, and thus to reveal input-output causal relations.

Sometimes simple spectrum analysis can be used to trace cause-effect relations. The output signal of a system and an input which is thought to be causally related to it may share common spectral components or lines; this usually means a causal relation unless another input **also** has the same components, which makes the situation a lot more complicated! However, when the spectra are continuous (without individual lines), as is the case with random signals, one cannot usually deduce causality by looking for common components. One purpose of this experiment is to illustrate that point.

In the system shown in Figure 4, there are two identical noise sources, X and Y, connected to the inputs. In

this case, “identical” means that the two power spectra are flat and have the same amplitude, so that they couldn’t be distinguished with a spectrum analyzer. Inside the box representing the system, each signal is passed through a simple filter and then the two are combined linearly to form the output signal. The filters, low-pass and high-pass, are carefully matched in cutoff frequency and gain, with the result that the output signal Z **also** has a flat spectrum, even though it is the combination of two filtered inputs. Figure 4(a) shows the spectra of one of the inputs and the output, while Figure 4(b) shows the filter transfer functions, their -3 dB frequencies being equal. Assuming that we have access only to the terminals X₁, Y₁, and Z, and that we can’t disconnect the sources, how do we determine the causal relation of each source to the output? In fact, how can we tell that this system is any different from one in which there is no frequency dependence in the combining process?

Figure 4.

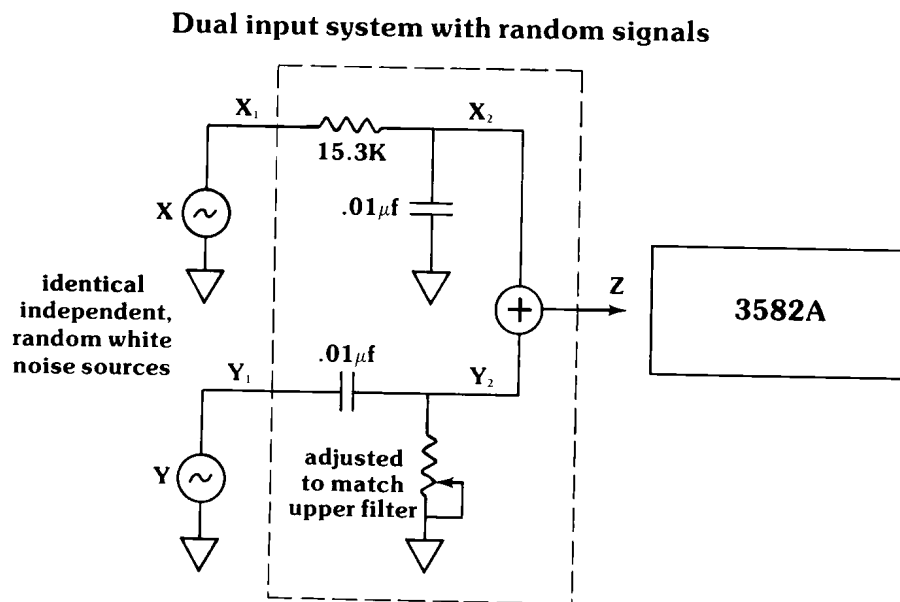

The measured coherence functions, shown in Figure 4(c), provide the answer to these questions. Remembering from the discussion in Section 2 that the measured coherence function of a random process must be averaged to improve the statistical accuracy (which is why the display is ragged; see Table 2), we can interpret the results as follows. First, the low-pass signal X is the dominant output term at low frequencies, since the coherence function is nearly unity there. The same is true for signal Y at high frequencies. At **any** frequency, the two coherence functions add to unity, confirming the statement in Section 2 that the coherence function represents the fraction of output power attributable to the input in question. Note that both functions are equal to 0.5 at the common crossover frequency 1040 Hz (which is often called the half-power point). Finally, the answer to the second question is that the coherence functions for a system with no frequency dependence would be flat, at values which represent each input's contribution to the output power.

a) Noise spectra at one input (X_1) and output Z . The other input (Y_1) has an identical spectrum.

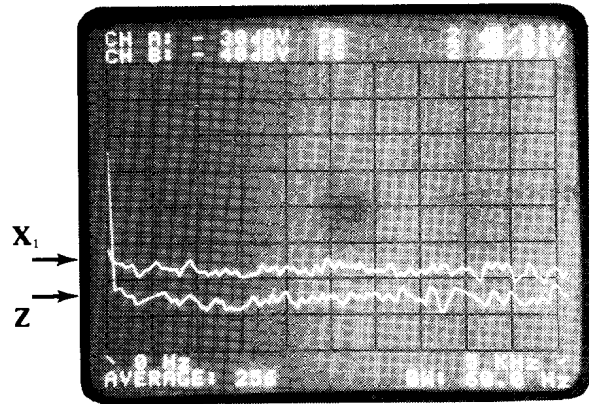

b) Measured filter transfer functions.

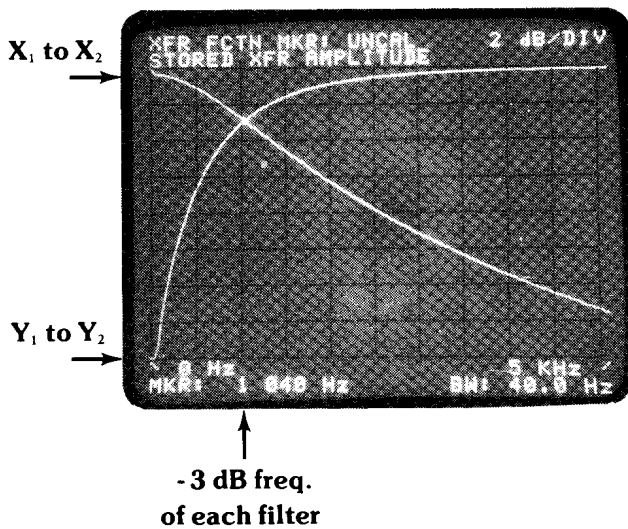

c) Coherence functions between each input and the output.

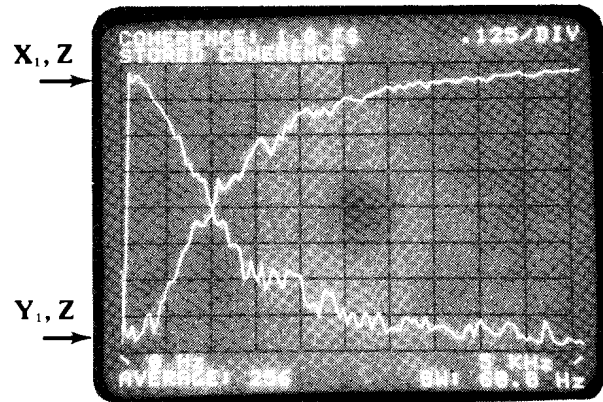

Appendix:

Definitions and interpretations

Linear spectra and power spectra

Figure 5 is the model of a linear, single-input system much like that of Figure 1 except the various signals and the transfer function are shown both as functions of frequency and of time. Also, a single disturbing signal (or noise source) is shown adding to the total output signal Y. This represents the simplest form of the situation described in Section 1, in which the output is contaminated with energy not directly related to the input.

The time-function and frequency-function equivalent forms of a signal are related by the Fourier transform. For instance,

$$X(f) = F[x(t)] \equiv \int_{-\infty}^{\infty} x(t)e^{-j2\pi ft} dt$$

The frequency function $X(f)$ is called a linear spectral function, or linear spectrum because it corresponds to the first order time function $x(t)$. There is another spectral function corresponding to the power function $x^2(t)$. (We assume, for convenience, that $x(t)$ is a voltage across a 1 ohm resistor.) This function is the "auto" power spectrum (that is, self-power) and it is defined as

$$\text{auto power spectrum} = G_{xx}(f) \equiv X(f) \cdot X^*(f)$$

That is, the linear spectrum $X(f)$ multiplied by its complex conjugate. Notice that the power spectrum has no imaginary term; its phase is zero at all frequencies.

There is another kind of power spectrum which reveals, in a sense, the relation between **two** signals, say $X(f)$ and $Y(f)$. This is called the cross-power spectrum, and it is defined similarly:

$$\text{cross-power spectrum} = G_{yx} \equiv Y(f) \cdot X^*(f)$$

In contrast to the auto power spectrum $G_{xx}(f)$, the cross power spectrum is generally complex (phase $\neq 0$).

The cross-power spectrum is central to both the coherence function and the method used by the 3582A to calculate transfer functions.

Figure 5.

Single input, linear system with noise added to output signal

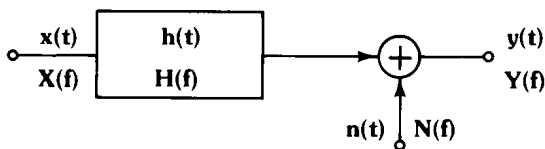

Defining the coherence function

With the concept of a power spectrum in hand, the formal definition of the coherence function, applied to the situation of Figure 5 can be given:

$$\text{coherence function} = \gamma^2 \equiv \frac{|G_{yx}(f)|^2}{G_{xx}(f) \cdot G_{yy}(f)}$$

(From now on, we will drop the independent variable f from the expressions to keep them tidier, but it is assumed.)

The expression for γ^2 , the coherence function, can be examined from at least two points of view which provide useful interpretation and insight.

The coherence function as a power ratio

Note that the output spectrum Y contains both input- and noise-related components: $Y = HX + N$. The power spectrum, G_{yy} , can be expressed using these components:

$$G_{yy} = YY^* = (HX + N)(HX + N)^* = |H|^2 G_{xx} + G_{NN} + HG_{xN} + H^* G_{Nx}$$

We can also form an expression for the cross-power term:

$$G_{yx} = YX^* = (HX + N)X^* = HG_{xx} + G_{Nx}$$

Now, before using these expanded forms to construct an expression for the coherence function, we must reason as follows: since X and N are assumed to be independent, uncorrelated signals, they do not have any common, synchronous components. Therefore, cross-power terms involving these signals (such as G_{Nx}) must be zero. Using this argument, the expanded expression for the coherence function simplifies:

$$\gamma^2 = \frac{(HG_{xx})(HG_{xx})^*}{G_{xx} (|H|^2 G_{xx} + G_{NN})} = \frac{|H|^2 G_{xx}}{|H|^2 G_{xx} + G_{NN}}$$

In words, this interprets the coherence function as

$$\gamma^2 = \frac{\text{output power due to the input}}{\text{total output power}}$$

That is, γ^2 equals the fraction of the output power attributable to the input signal. (Any nonlinearity in the system may convert some of the input signal to energy at other frequencies, but the coherence function treats this energy as noise.) It follows that $\gamma^2 G_{yy}$ is the output power related to the input, and that $(1-\gamma^2)G_{yy}$ is the noise component of the output power. Therefore, the system signal-to-noise ratio is $\gamma^2/1-\gamma^2$. Note that this is not the overall S/N ratio, but the S/N ratio at **each** frequency, a very useful aid in interpreting measurement results.

The coherence function as a correlation coefficient

Another useful interpretation of the coherence function is in terms of the statistical measure called the correlation coefficient.

Let's assume we have N values of each of the complex, zero-mean variables X and Y. (In reality, this is the situation in the 3582A after making N two-channel transforms; **at one frequency**, X_i and Y_i represent the linear spectral values of the i^{th} transform of the signals in channels A and B, respectively.) Estimates of two statistical quantities defined for such variables are

$$1) \text{ the variance: } \sigma_X^2 = \frac{1}{N} \sum_{i=1}^N X_i X_i^*$$

$$\sigma_Y^2 = \frac{1}{N} \sum_{i=1}^N Y_i Y_i^*$$

$$2) \text{ the covariance: } C_{YX} = \frac{1}{N} \sum_{i=1}^N Y_i X_i^*$$

Another quantity is the normalized correlation coefficient, defined in terms of (1) and (2) as

3) the normalized correlation coefficient:

$$\rho_{YX} = \frac{C_{YX}}{\sigma_Y \sigma_X}$$

Now the 3582A makes these same calculations (1) and (2) in the course of determining the coherence function. That is, at any one of the 256 analysis frequencies, it calculates

$$\text{channel A auto spectrum} = G_{XX} = \frac{1}{N} \sum_{i=1}^N X_i X_i^* = \sigma_X^2$$

And similarly, channel B auto spectrum = $G_{YY} = \sigma_Y^2$ and the cross-power spectrum = $G_{YX} = C_{YX}$.

From these results and the previous definition of the coherence function, we see that $\gamma^2 = \rho_{YX}^2$.

Thus, we can interpret the coherence function as the squared correlation coefficient of the two spectra X and Y **at each analysis frequency**.

The use of the cross-power spectrum to calculate transfer functions

On page 2 the use of the cross-power spectrum as a means for calculating transfer functions was mentioned. The reason for this technique will now be outlined.

Referring to Figure 1, it is customary to derive the transfer function H by calculating the output/input ratio Y/X. This is fine, since $Y = HX$, **except** for the situations where Y contains some noise or other contaminating signal. In this case (see Figure 5), the output/input ratio is $(HX + N)/X$, which is not equal to H, nor can any amount of signal averaging cause it to approach the true value of H.

A remedy for this problem can be found as follows. Multiplying numerator and denominator by X^*/X^* , we have

$$\frac{Y}{X} \frac{X^*}{X^*} = \frac{G_{YX}}{G_{XX}} = \frac{HXX^* + NX^*}{XX^*} = \frac{HG_{XX} + G_{NX}}{G_{XX}}$$

As before, we reason that the term G_{NX} is the cross-power between X and N, which are assumed to be uncorrelated. Averaging will thus produce an estimate of this term which tends to zero. Thus, the true value of H is recoverable, even in the presence of system noise, through the use of the cross-power spectrum and the auto spectrum of the input.

Bibliography

The first two references are clearly-written, illustrated technical articles dealing with several aspects (including coherence functions) of random-process measurement. The last is probably the standard text dealing with this subject matter. It is clear and well organized so that it may be used for reference as well as study.

1) "Effective Measurements using Digital Signal Analysis," by Peter R. Roth, IEEE SPECTRUM, April, 1971.

- 2) "How to Use the Spectrum and Coherence Function," by Peter R. Roth, SOUND AND VIBRATION, January, 1971.
- 3) "Random Data: Analysis and Measurement Procedures," by Julius S. Bendat and Allan G. Piersol, Wiley-Interscience, 1971.

THIRD OCTAVE ANALYSIS WITH THE HP 3582A SPECTRUM ANALYZER

AN 245-3

FOREWORD

Low frequency analyzers based on digital signal processing — especially the Fast Fourier Transform algorithm — are rapidly replacing older analog spectrum analyzers for a variety of measurement tasks. However, even the most enthusiastic FFT analyzer users recognize that there are some measurements for which they are not particularly suited. Log frequency sweep and 1/3 octave analysis are examples.

Nevertheless, the combination of an FFT analyzer and a “friendly” (i.e., easily programmed) small computer can perform a greater variety of measurements than the analyzer itself can do. For this to happen, it is essential to have fast, efficient communication between the two. The Hewlett-Packard Interface Bus (HP-IB*) serves this need well.

1/3 octave analysis is the measurement of a frequency spectrum by the use of constant percentage bandwidth

filters 1/3 octave wide and spaced 1/3 octave. It has long been popular for audio and acoustic applications, largely because of the relationship between this filtering technique and certain psychoacoustic properties of human hearing.

This application note offers a means for making 1/3 octave measurements with a 3582A Spectrum Analyzer controlled by a 9835A Desktop Computer. Enough information is included (program listing, flowcharts, and description) to enable the reader to use it directly or to modify it as he requires.

*HP-IB is Hewlett-Packard's implementation of IEEE Standard 488 and identical ANSI Standard MC1.1 “Digital interface for programmable instrumentation.”

THE HEWLETT-PACKARD MODEL 3582A SPECTRUM ANALYZER

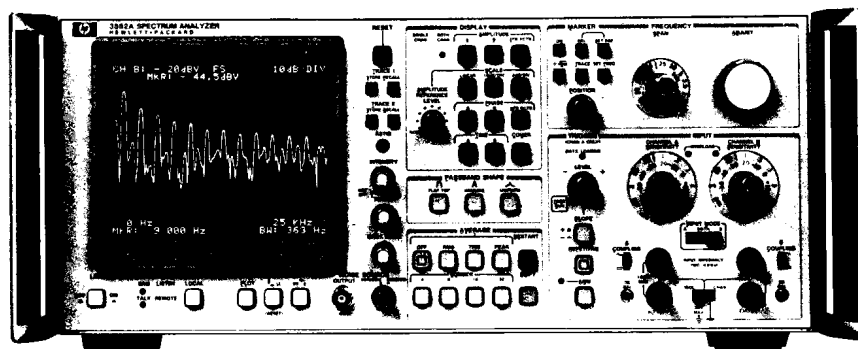

The HP 3582A is a spectrum analyzer covering the frequency range of DC to 25 kHz. Although it is a FFT-based, digital instrument, a special design effort has made it as straightforward to use as a conventional swept analyzer. With dual measurement channels it is possible to measure transfer function gain and phase, as well as the coherence function. A built-in random or pseudo-

random noise source, whose spectrum tracks the analysis range, is a useful measurement stimulus. Band Selectable Analysis enables narrowband, high resolution analysis to be applied to any portion of the frequency range. The instrument comes equipped with a flexible HP-IB interface for control and two-way data transfers.

TABLE OF CONTENTS

	Page
Section 1: Third octave analysis Brief review of the concept and practice of third octave spectrum analysis	1
Section 2: Implementing 1 / 3 octave analysis with an FFT analyzer Problems inherent in using an FFT analyzer directly The idea of synthesizing 1 / 3 octave filter response	1
Section 3: Introduction to this program Equipment needs Operating the program Sequence of operations How signals are combined	2
Section 4: Comparison with ANSI class III 1 / 3 octave filters ANSI standard How results of this program compare with standard specifications	3
Section 5: Suggested extensions to the program Modular program structure Several possible modifications	4
Section 6: Flow diagrams	5
Section 7: Program listing	7
Section 8: Summary	9
Appendix: HP 9825A Calculator Program	10

Section 1: Third octave analysis

In concept, “third octave” analysis is straightforward: imagine a set of parallel-connected filters being used to examine an audio signal. The center frequencies of the filters are scaled by a factor of 1/3 octave; that is, each filter is located at a frequency $2^{1/3}$ times its lower neighbor. In addition the nominal bandwidth of each filter is $2^{1/3} - 1$ times its center frequency. To cover the audio range of, say, 20 Hz to 20 kHz (9.97 octaves), with this technique requires 30 filters. Because of the multiplicative frequency spacing and bandwidth of the filters, it is convenient to display their characteristics on a log frequency plot, such as illustrated by Figure 1.

Historically, this kind of analyzer has been implemented with an actual parallel bank of filters. The instantaneous signal amplitude in each filter is detected and converted to dB. The data is displayed on an oscilloscope in the form of a bar graph: log amplitude (vertical) versus log frequency (horizontal).

Although parallel analog filters are still being used in some current instruments, there are at least two newer alternative techniques: digital filtering and FFT synthesis. Of these, the digital filter approach is preferable from the point of view of performance. This is primarily because the hardware can be optimized for the 1/3 octave task

and the display is “real time.” However, for the many cases for which “real time” operation is not necessary – meaning that the signal to be analyzed has a stationary spectrum – the FFT technique is attractive, especially if you already have an FFT analyzer! Advantages of the FFT synthesis technique include easy modification of the frequency range and the use of frequency weighting functions if desired.

Figure 1.

Representation of a 1/3 octave analyzer composite filter characteristic

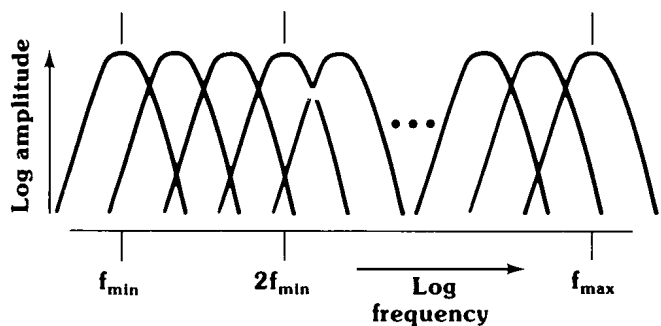

Section 2: Implementing 1/3 octave analysis with an FFT analyzer

Why can't an FFT analyzer, such as the 3582A, be modified so that it produces a 1/3 octave analysis directly? Primarily because the FFT algorithm generates data on a set of linearly spaced sample points in the frequency domain. Its display has a linear frequency axis, not logarithmic as required by the 1/3 octave data. Also, the individual FFT filters, or “bins,” have all the same bandwidth rather than bandwidths proportional to their center frequencies.

The approach used in this application note is to synthesize the frequency characteristics of 1/3 octave filters by combining the signals from several FFT bins. This requires weighting the contribution from each bin so that the composite “filter” is a good approximation to the specified shape of the 1/3 octave filter in question. Figure 2 indicates how this is done.

At lower frequencies the approximation is not as good because only a few FFT bins can be used. In fact, in the 3582A the bin spacing is 100 Hz when using the 0-25 kHz span. If only this span were used, the lowest frequency third octave filter that could be synthesized would be about 500 Hz. This is certainly not satisfactory for audio analysis. Therefore, to adequately cover the audio range, three spans are used: 0-250 Hz, 0-5 kHz, and

0-25 kHz. The result is 32 third octave filters, with center frequencies ranging from 15.85 Hz to 19.95 kHz (Fig. 3).

Figure 2.

Synthesizing a composite 1/3 octave filter by combining the weighted responses of several FFT filters, or “bins”

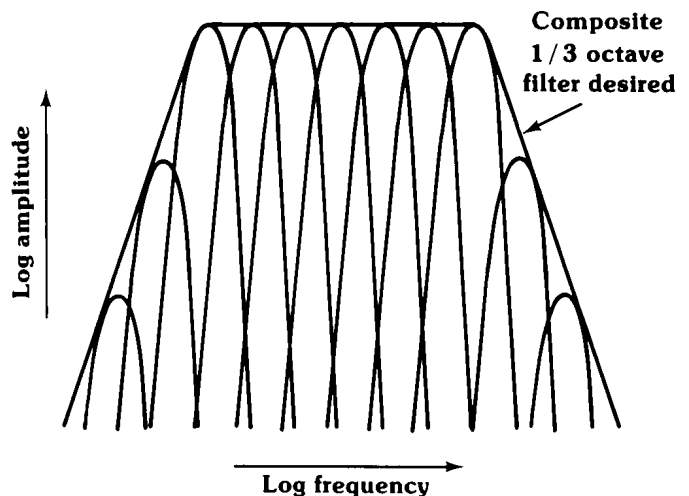

Section 3: Introduction to this program

The equipment needed to use this program for 1/3 octave analysis is a 3582A Spectrum Analyzer (standard equipment includes HP-IB), a 9835A Desktop Computer with a 98332A I/O ROM installed, and a 98034A HP-IB Interface. The program is written in BASIC; it will run on another language-compatible calculator with the appropriate I/O, such as the 9845A. Memory requirements are approximately 15000 bytes for program and variable storage. Using the program listing and the flow diagrams, one can rewrite the program in another language. See the Appendix for the 9825A Calculator version.

Operating the program is simple. Pressing RUN causes the necessary initialization and then the user is asked, "Do you want RMS averaging?" The reason for this is that many spectra are random in nature, and a better estimate of the spectrum – and thus a better 1/3 octave analysis – is obtained when the 3582A is allowed to average the data. (Application Note 245-1, "Signal Averaging with the 3582A Spectrum Analyzer," deals with averaging in detail.) After the user answers the question, the program proceeds to:

- a) set the 3582A to each frequency range in turn
- b) bring the amplitude data for each range from the 3582A display into the controller for processing
- c) convert the data, apply weights, and combine to form 32 synthesized results as if from 1/3 octave filters
- d) format and output these results in the form of a bar-graph display on the 3582A
- e) return to the beginning for another analysis, if desired

Step (c) requires some explanation. How exactly should the data from several FFT bins be combined to approximate the result expected from a 1/3 octave filter? It should be done on the basis of power rather than linear addition. This is because the signals in adjacent FFT bins are uncorrelated when the input is a random time signal. And when a coherent signal is analyzed, such as a sinusoid, the sum of signal power remains constant as the signal frequency varies. This means there is no ripple in the synthesized passband.

In the program, line 3090 converts the FFT bin signals to power (that is, volts squared) from dBV, and line 3180 converts the sum of weighted powers back to dBV.

Figure 3.

Center frequencies of 1 / 3 octave filters synthesized by this program

FILTER NUMBER	CENTER FREQ	
1	15.85	} Pass.1 0-250 Hz
2	19.95	
3	25.12	
4	31.62	
5	39.81	
6	50.12	
7	63.1	
8	79.43	
9	100	
10	125.9	
11	158.5	
12	199.5	
13	251.2	} Pass.2 0-5 kHz
14	316.2	
15	398.1	
16	501.2	
17	631	
18	794.3	
19	1000	
20	1259	
21	1585	
22	1995	
23	2512	
24	3162	
25	3981	
26	5012	} Pass.3 0-25 kHz
27	6310	
28	7943	
29	10000	
30	12590	
31	15850	
32	19950	

Section 4: Comparison with ANSI class III 1/3 octave filters

The American National Standards Institute publishes a document* recognized as setting proper standards for these filters. The filters synthesized by this program conform closely to the specifications for "Third-Octave Band Filters – Class III," as defined in this paper. Here are the principal characteristics of the filters:

- a) Center frequencies: Strictly speaking, the ANSI document defines these in "tenth decade" intervals, but the difference from third octave is negligible. The greatest deviation from the specified value occurs in filter #20, whose geometric mean frequency is 0.7% below the specified value of 1259 Hz. ($\pm 3\%$ is allowable).
- b) Transmission loss limits: All filters meet these criteria, although the rolloff rates differ due to the varying number of FFT bins used in the synthesis of individual filters. Filter #13, which uses only 4 bins, reaches -72 dB loss at 1/5 its center frequency, rather than the specified -75 dB. The other extreme is filter #12, which uses 49 bins. The attenuation characteristics of these two filters are shown in Figures 4 and 5, with the specification limits superimposed.
- c) Effective bandwidth (noise bandwidth): This specification requires that the power output from a filter, when the input is white noise, be within 10% of the noise passed by an ideal rectangular 1/3 octave filter. Filter #10 has the greatest deviation, with a noise bandwidth 2.9% higher than standard.
- d) Passband uniformity (passband ripple): The synthesized filters have no perceptible ripple within the defined band-edge frequencies, and so the ripple specification (0.5 dB) does not apply.
- e) Variation of minimum loss among filters: Theoretically, all filters in this program have zero mid-band loss. Some variation will be encountered due to individual 3582A amplitude accuracy characteristics, specifically gain variations between different frequency spans. These will be well within the allowed ± 1 dB.
- f) Transient response: The program cannot meet this specification, since it is necessary that the signal being analyzed be statistically stationary during the acquisition of data.

**Figure 4.
Filter #12**

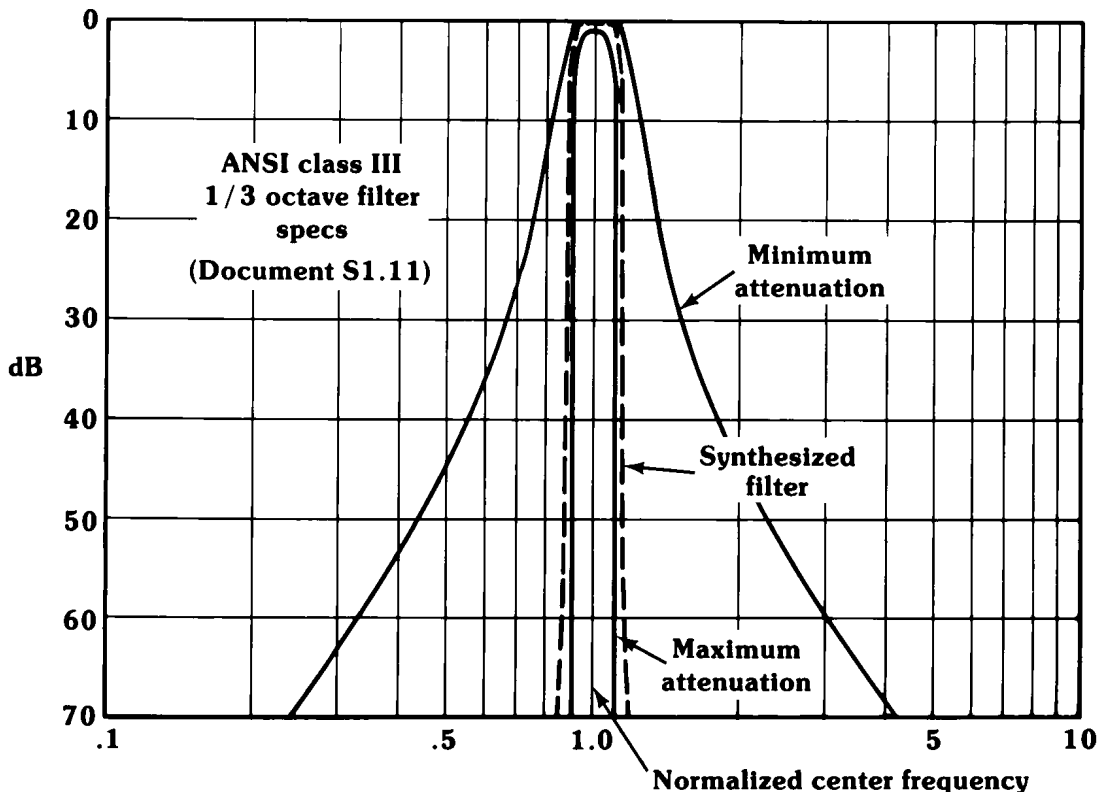

*"AMERICAN NATIONAL STANDARD SPECIFICATION FOR OCTAVE, HALF-OCTAVE, AND THIRD-OCTAVE BAND FILTER SETS," ANSI Specification

S1.11-1966
American National Standards Institute, Inc.
1430 Broadway, New York, N.Y. 10018

Section 5: Suggested extensions to the program

Because of the modular structure of the program, it is simple to modify by adding or deleting sections.

"Modular" means that the action portions of the program are written as subroutines called up as needed by a control sequence located in lines 50 to 150.

Here are some possible modifications:

PRINTED OUTPUT. Some users may want a permanent record of the analysis results. The structure of this program makes this an easy job. Simply write an output routine to the desired printer (internal or HP-IB external), listing the contents of "Thirdmag" (dBV) together with the 1/3 octave filter number or center frequency. The center frequency is readily calculated as $10^{((\text{filter number} + 11)/10)}$ Hz. Append this routine to the program and call it by a statement like

145 GOSUB Printer

This method also could be used to save the data on a mass storage device, like the tape cassette.

DISPLAY ANNOTATION. It may be desirable to identify individual filters more readily on the 3582A display. Since there are 32 third octave filters and also room for 32 characters on each of the four display lines, you can fill the lower two lines with digits so that they give the filter number when read vertically:

0000. . . .2333

1234. . . .9012

This change would be made in lines 2540 and 2550 of the program.

FREQUENCY WEIGHTING. Some measurements require the application of special shaping to measured spectra. An example is "A" weighting sometimes used in acoustics measurements. It is simple to do this with the present program. What is required is a table of dB loss values for the center frequency of each of the 1/3 octave filters in the program. Then a routine should be written to modify the dBV numbers in "Thirdmag" by these values. The routine should be called up before the display routine by adding, for example, the line

125 GOSUB Spectrum.weight

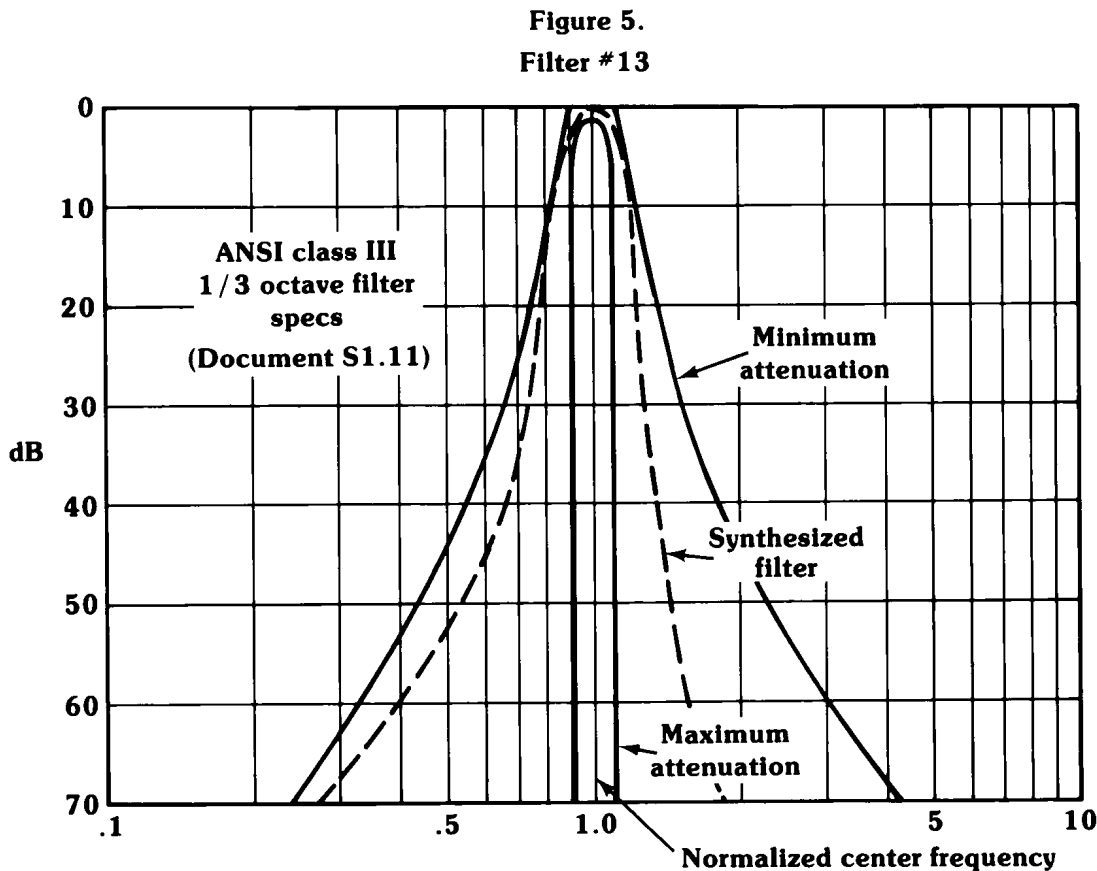

Section 6: Flow diagrams

Main Flow Diagram - 1/3 octave program

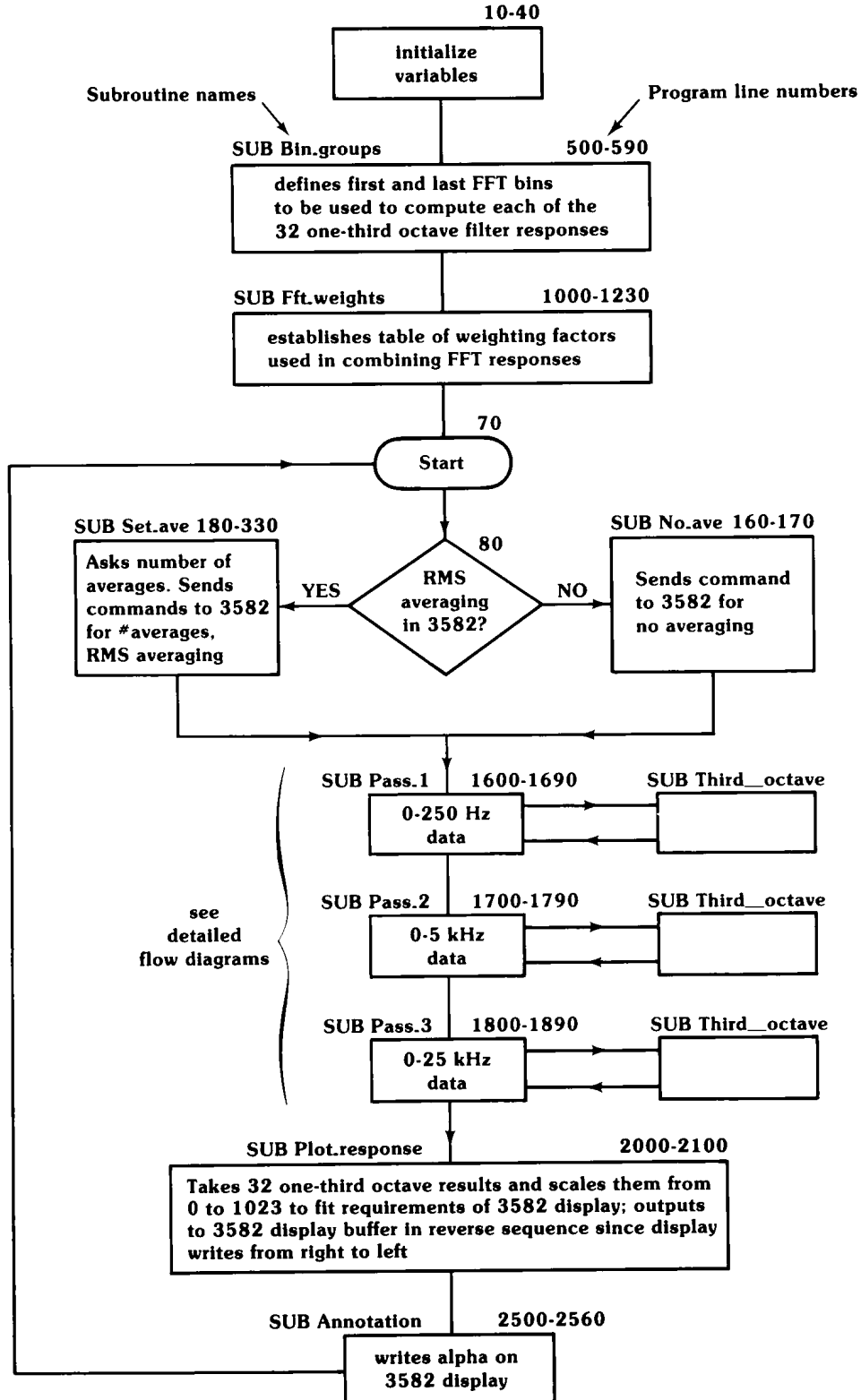

Detailed Flow Diagram
Pass subroutines - 1/3 octave program

Pass.1 begins at 1600
 Pass.2 begins at 1700
 Pass.3 begins at 1800

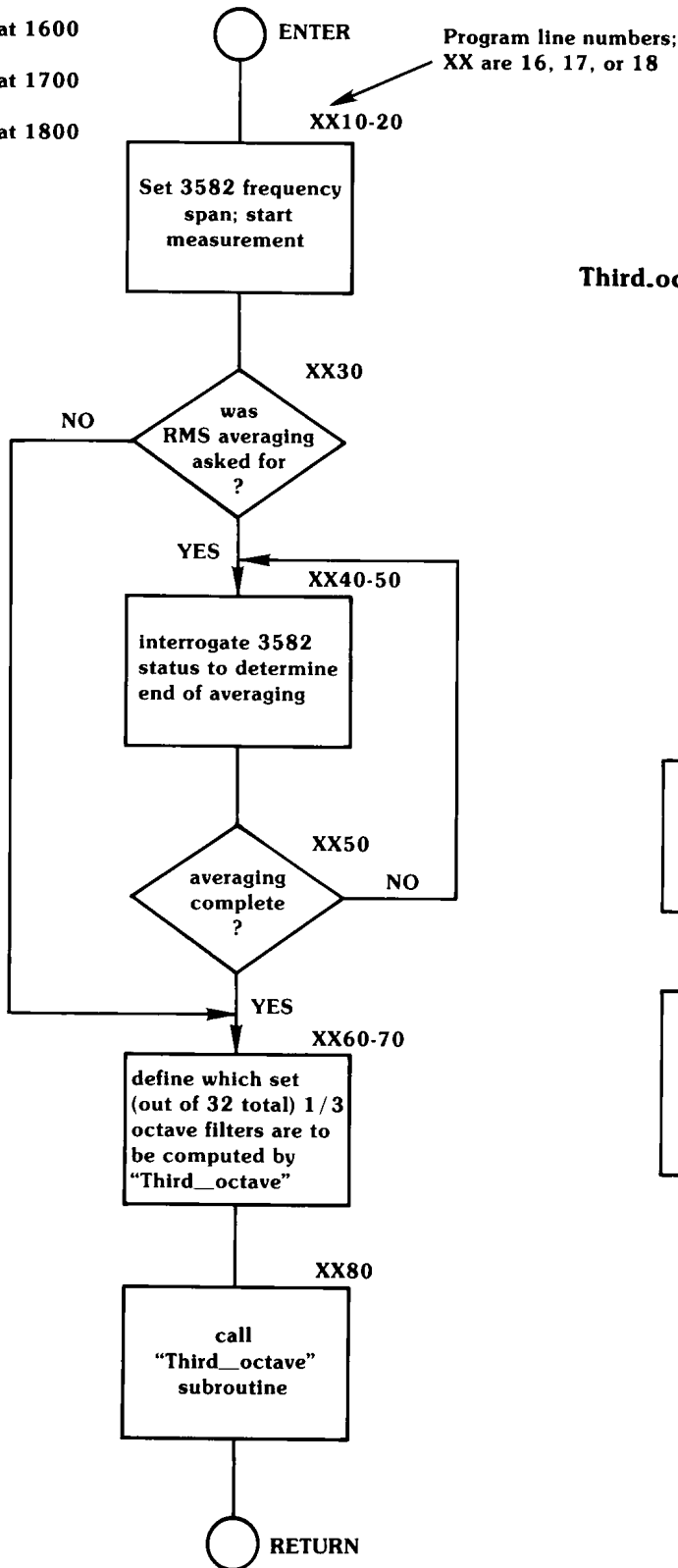

Detailed Flow Diagram
Third.octave subroutine - 1/3 octave program

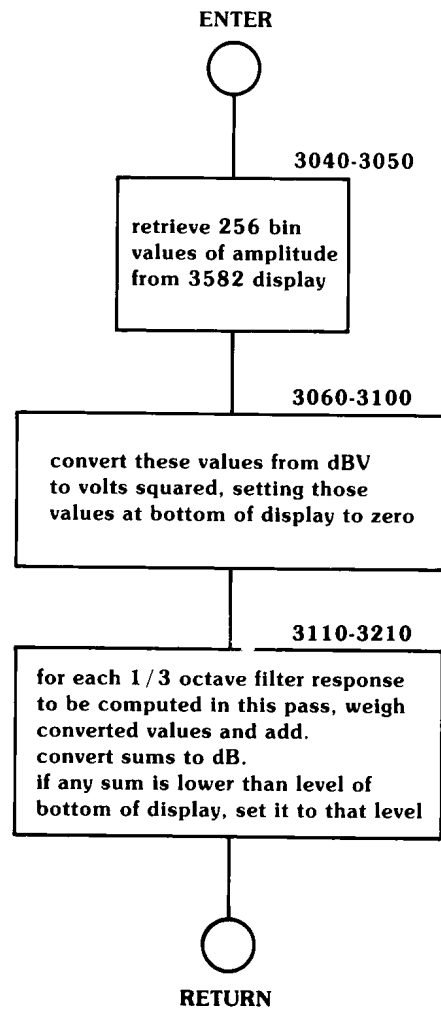

Section 7: Program listing

```

1   REM   1/3 OCTAVE ANALYSIS PROGRAM FOR THE H-P 3582A SPECTRUM
2   REM   ANALYZER AND THE 9800 SERIES 35 CALCULATOR.
3   REM   H-P LOVELAND INSTRUMENT DIVISION.
10  OPTION BASE 1
20  INTEGER Firstbins(32),Lastbins(32),Graphics(256),Analyzer,First_Lthird,Last_
third,A,I,J,K
30  SHORT Binweight(32,49),Thirdwag(32),Fftwag(256),Temp
40  Analyzer=711 !REM   LINES 50 TO 150 COMPRISE THE MAIN
50  GOSUB Bin_groups !REM   CONTROL PROGRAM WHICH CALLS
60  GOSUB Fft_weights !REM   SUBROUTINES IN THE PROPER SEQUENCE
70  Start: INPUT "DO YOU WANT RMS AVERAGING?";Averagein$
80  ON (Averagein$="YES")+1 GOSUB No_Lave,Set_Lave
90  GOSUB Setup
100 GOSUB Pass_1
110 GOSUB Pass_2
120 GOSUB Pass_3
130 GOSUB Plot_response
140 GOSUB Annotation
150 GOTO Start
160 No_Lave: OUTPUT Analyzer;"HLTAV1"
170 RETURN
180 Set_Lave: INPUT "HOW MANY AVERAGES?";A
190 Ave$="ERROR"
200 IF A=4 THEN Ave$="NU1SH0"
210 IF A=8 THEN Ave$="NU2SH0"
220 IF A=16 THEN Ave$="NU3SH0"
230 IF A=32 THEN Ave$="NU4SH0"
240 IF A=64 THEN Ave$="NU1SH1"
250 IF A=128 THEN Ave$="NU2SH1"
260 IF A=256 THEN Ave$="NU3SH1"
270 IF Ave$(<>"ERROR") THEN GOTO 320
280 BEEP
290 DISP "CHOSE A NUMBER FROM THOSE ON FRONT PANEL OF 3582A"
300 WAIT 4000
310 GOTO 180
320 OUTPUT Analyzer;"HLTAV2LST0";Ave$
330 RETURN
500 Bin_groups: REM   LOADS THE ARRAYS Firstbins AND Lastbins
510 REM   WITH THE FIRST AND LAST NUMBERS OF THE SETS OF
520 REM   FFT BINS USED TO COMPUTE EACH 1/3 OCTAVE FILTER
530 MAT READ Firstbins
540 DATA 15,18,23,29,36,45,57,71,89,112,142,178,12,15,18,23
550 DATA 29,36,45,56,71,89,112,141,178,45,57,71,89,112,142,179
560 MAT READ Lastbins
570 DATA 19,24,30,37,46,58,72,91,114,143,180,226,15,19,24,30
580 DATA 37,46,58,72,91,114,143,179,225,58,72,91,114,143,179,225
590 RETURN
1000 Fft_weights: REM   LOADS THE ARRAY Binweight WITH THE WEIGHTS
1010 REM   TO BE USED IN ADDING RESPONSES FROM FFT BINS
1020 MAT Binweight=(.67)
1030 FOR I=1 TO 32
1040 READ Binweight(I,1)
1050 NEXT I
1060 DATA .25,.1,.3,.3,.3,.2,.2,.2,.1,.2,.3,.2,.15,.25,.1,.2
1070 DATA .3,.3,.2,.2,.2,.1,.1,.2,.2,.1,.2,.2,.1,.1,.3,.2

```

```

1080     FOR I=1 TO 32
1090         READ Binweight(I,2)
1100     NEXT I
1110         DATA .67,.4,.4,.5,.5,.4,.5,.4,.4,.4,.4,.4,.67,.67,.4,.4
1120         DATA .5,.5,.4,.4,.4,.4,.3,.5,.5,.4,.67,.4,.3,.4,.5,.5
1130     FOR I=1 TO 32
1140         READ Binweight(I,Lastbins(I)-Firstbins(I))
1150     NEXT I
1160         DATA .67,.4,.4,.5,.5,.4,.5,.4,.4,.4,.4,.4,.67,.67,.4,.4
1170         DATA .5,.5,.4,.4,.4,.4,.3,.5,.5,.4,.67,.4,.3,.4,.5,.5
1180     FOR I=1 TO 32
1190         READ Binweight(I,Lastbins(I)-Firstbins(I)+1)
1200     NEXT I
1210         DATA .25,.2,.25,.3,.3,.2,.2,.2,.1,.2,.3,.2,.5,.25,.2,.2
1220         DATA .3,.3,.2,.2,.2,.1,.1,.2,.2,.1,.2,.2,.1,.1,.3,.2
1230     RETURN
1500 Setup:    REM     INITIALIZES THE CONTROL SETTINGS OF THE 3582A.
1510         REM     CHAN "A" SENSITIVITY IS OBTAINED FOR PROPER DISPLAY SCALING.
1520         REM     THREE CONSTANTS ARE CALCULATED.
1530         OUTPUT Analyzer;"AA1AB0AX0SC2PA0PB0PX0CH0PS2FR1RP1MD2IM1TR0RR0"
1540         OUTPUT Analyzer;"LAS"
1550         ENTER Analyzer;Sensitivity
1560         Minimum=10*((Sensitivity-80)/10)
1570         Display_Scale=1023/80
1580         Input_Scale=8/1023
1590     RETURN
1600 Pass_1:    REM     0 TO 250 Hz
1610         OUTPUT Analyzer;"SP8RUNRE"
1620         WAIT 2000
1630         IF Averaging$<>"YES" THEN GOTO 1660
1640         OUTPUT Analyzer;"LST0"
1650         IF BIT(READBIN(Analyzer),6)=0 THEN GOTO 1640
1660         First_third=1
1670         Last_third=12
1680         GOSUB ThirdOctave
1690     RETURN
1700 Pass_2:    REM     0 TO 5 KHz
1710         OUTPUT Analyzer;"SP12RUNRE"
1720         WAIT 1000
1730         IF Averaging$<>"YES" THEN GOTO 1760
1740         OUTPUT Analyzer;"LST0"
1750         IF BIT(READBIN(Analyzer),6)=0 THEN GOTO 1740
1760         First_third=13
1770         Last_third=25
1780         GOSUB ThirdOctave
1790     RETURN
1800 Pass_3:    REM     0 TO 25 KHz
1810         OUTPUT Analyzer;"SP14RUNRE"
1820         WAIT 1000
1830         IF Averaging$<>"YES" THEN GOTO 1860
1840         OUTPUT Analyzer;"LST0"
1850         IF BIT(READBIN(Analyzer),6)=0 THEN GOTO 1840
1860         First_third=26
1870         Last_third=32
1880         GOSUB ThirdOctave
1890     RETURN

```

```

2000 Plot_response:      REM      OUTPUTS GRAPHIC RESULTS TO 3582A DISPLAY
2010      FOR I=1 TO 32
2020          Temp=Display_scale*(Thirdmag(33-I)+80-Sensitivity)
2030          IF Temp>1023 THEN Temp=1023
2040          IF Temp<0 THEN Temp=0
2050          FOR J=1 TO 8
2060              Graphics(8*I+J-8)=Temp
2070          NEXT J
2080      NEXT I
2090      OUTPUT Analyzer USING "13A/256(Y)";"WTM,74400,256";Graphics(*)
2100      RETURN
2500 Annotation:        REM      OUTPUTS 3 LINES OF ALPHA TO 3582A DISPLAY,
2510          REM      LEAVING THE 2ND LINE BLANK
2520      OUTPUT Analyzer USING "5A,DDD,32A";"WTA1,";Sensitivity," dBV FULLSCALE
--- 10 dB/DIV "
2530      OUTPUT Analyzer;"WTA2,"
2540      OUTPUT Analyzer;"WTA3,16 HZ"
2550      OUTPUT Analyzer;"WTA4, 32 THIRD-OCTAVE SEGMENTS "
2560      RETURN
3000 Third_Octave:      REM      TAKES THE DISPLAY DATA OF THE 3582 IN
3010          REM      BINARY FORM AND CONVERTS THE NUMBERS TO VOLTS SQUARED;
3020          REM      APPLIES THE WEIGHTING FACTORS AND COMBINES THE DATA TO FORM
3030          REM      RESULTS AS IF FROM ANSI CLASS III FILTERS.
3040      OUTPUT Analyzer;"HLTLFM,74400,256"
3050      ENTER Analyzer USING "#,Y";Fftmag(*)
3060      FOR I=1 TO 256          !REM      FORMAT BINARY DATA FROM DISPLAY
3070          Fftmag(I)=Input_scale*BINAND(Fftmag(I),1023)
3080          IF Fftmag(I)=0 THEN GOTO 3100
3090          Fftmag(I)=10*(Fftmag(I)+Sensitivity/10-8)
3100      NEXT I
3110      FOR I=First_third TO Last_third      !REM      WEIGHT AND ADD FFT RESPONSES
3120          Temp=0
3130          FOR J=Firstbins(I) TO Lastbins(I)
3140              K=J-Firstbins(I)+1
3150              Temp=Temp+Binweight(I,K)*Fftmag(257-J)
3160          NEXT J
3170          IF Temp<Minimum THEN GOTO 3200
3180          Thirdmag(I)=10*LGT(Temp)
3190          GOTO 3210
3200          Thirdmag(I)=Sensitivity-80
3210      NEXT I
3220      RETURN

```

Section 8: Summary

We hope this application note will provide some insight into one possible technique for making 1/3 octave measurements with the 3582A Spectrum Analyzer. While the program is written in BASIC, there should be enough flowcharts, program annotation, and comments to allow the interested reader to implement the measurement with a controller using another language.

The program has been developed, tested, and evaluated by the Product Marketing Group of HP's Loveland Instrument Division. It is based on a report from the R&D Department.

INTENSIFIED MARKER (Fig. 9). In normal operation of the 3582A there is no provision for using the marker on either time record displays or stored trace displays. This program provides a generalized means for moving around an intensified dot on any type of display, and for reading out the magnitude of the graphic data at each point.

The technique is the same as that used by the pro-

cessor: setting and resetting bit 14 of the data buffer word. However, using the HP-IB, this means withdrawing the entire word, changing the bit, and writing the modified word back into RAM. This action is carried out by a subroutine ("Dot"), while the user controls the marker position with the special function keys of the 9835A.

Figure 9

```

10  ! PROGRAM ALLOWS MANUAL CONTROL OF AN INTENSIFIED DOT BY SPECIAL
20  ! FUNCTION KEYS 0-3.  STARTS AT ADDRESS 74777 (LEFT EDGE OF DISPLAY)
30  ! AND MOVES DOT ACCORDING TO KEY PRESSED, BY EXTINGUISHING PREVIOUS
40  ! DOT AND TURNING ON NEXT DOT.  ADDRESS FIELD LIMITED TO DISPLAY
50  ! BUFFER (77000-74777) BUT NO FURTHER LIMITS CORRESPONDING TO
60  ! DISPLAY MODE; I.E., DOTS OF BLANKED DISPLAY CAN BE TURNED ON.
70  ! BOTH THE ADDRESS OF THE INTENSIFIED BIN AND THE MAGNITUDE OF THE
80  ! GRAPHIC DATA THEREIN ARE WRITTEN ON THE SCREEN.
90  INTEGER Disp_data,I,Dec_addr      ! initialize variables & constants.
100  Prev_addr=Oct_addr=74777
110  Dec_addr=31231
120  GOSUB Dot                        ! turn on the dot at the left side of display.
130  ON KEY #0 GOTO Step_up1         ! move one bin to the left.
140  ON KEY #1 GOTO Step_up10       ! move ten bins to the left.
150  ON KEY #2 GOTO Step_down10     ! move ten bins to the right.
160  ON KEY #3 GOTO Step_down1      ! move one bin to the right.
170  !
180  GOTO 170                         ! these two lines are the waiting
                                     ! loop required by "ON KEY" lines.
190 Step_up1: Dec_addr=Dec_addr+1
200  GOTO 220
210 Step_up10: Dec_addr=Dec_addr+10
220  IF Dec_addr>31231 THEN Dec_addr=31231 ! upper address bound.
230  GOSUB Dec_to_Octal
240  GOSUB Dot
250  GOTO 170
260 Step_down1: Dec_addr=Dec_addr-1
270  GOTO 290
280 Step_down10: Dec_addr=Dec_addr-10
290  IF Dec_addr<30720 THEN Dec_addr=30720 ! lower address bound.
300  GOSUB Dec_to_Octal
310  GOSUB Dot
320  GOTO 170
330  ! "Dot" IS THE INTENSIFY SUBROUTINE. IT RETURNS THE LAST INTENSIFIED
340  ! WORD TO NORMAL, MOVES TO THE NEXT ADDRESS, AND INTENSIFIES THAT WORD.
350  Dot: OUTPUT 711 USING "7A,5D,2A";"HLT LFN";Prev_addr,";1"
360  ENTER 711 USING "#,Y";Disp_data      ! get last intensified word.
370  Disp_data=BINAND(Disp_data,16383)    ! de-intensify it.
380  OUTPUT 711 USING "4A,5D,2A/Y";"WTN";Prev_addr,";1";Disp_data
390  Prev_addr=Oct_addr                  ! save the new address.
400  OUTPUT 711 USING "4A,5D,2A";"LFN";Oct_addr,";1"
410  ENTER 711 USING "#,Y";Disp_data      ! get the new word.
420  Disp_data=BINIOR(Disp_data,16384)    ! intensify it.
430  OUTPUT 711 USING "4A,5D,2A/Y";"WTN";Oct_addr,";1";Disp_data
440  Graphic=BINAND(Disp_data,1023)       ! get the magnitude (0-1023) of display.
450  Graphic=Graphic*8/1023              ! scale it to 0 to 8 (8 divisions on CRT)
460  OUTPUT 711 USING "16A,5D,12A,D,DD";"WTA3;ADDRESS IS ";Oct_addr,"  MAG.
IS ";Graphic                          ! write bin number and magnitude on line 3 of display.
470  RETURN
480  Dec_to_Octal:  Oct_addr=0           ! decimal to octal conversion subroutine;
490  Dec=Dec_addr                          ! required by 9845A - 9835A could use
500  FOR I=0 TO 5                          ! "OCTAL" instruction.
510  Oct_addr=Oct_addr+Dec MOD 8*10^I
520  Dec=INT(Dec/8)
530  NEXT I
540  RETURN

```

9825A Program Listing

```
0: "1/3 octave analysis program for the H-P 3582A spectrum":
1: "analyzer and the 9825A calculator":
2: dim F[32],L[32],B#[3136],T[32],M[256],A#[3],D#[6],C#[2]
3: dev "Analyzer",711
4: esb "Bin_groups"
5: esb "Fft_weights"
6: "Start":ent "do you want RMS averaging?";A#
7: if A#="yes";esb "Set_ave"
8: if A##"yes";esb "No_ave"
9: esb "Setup"
10: esb "Pass_1"
11: esb "Pass_2"
12: esb "Pass_3"
13: esb "Plot_response"
14: esb "Annotation"
15: sto "Start"
16: "No_ave":urt "Analyzer","HLTAV1";ret
17: "Set_ave":ent "how many averages?";A
18: "ERROR"→D#
19: if A=4;"NU1SH0"→D#
20: if A=8;"NU2SH0"→D#
21: if A=16;"NU3SH0"→D#
22: if A=32;"NU4SH0"→D#
23: if A=64;"NU1SH1"→D#
24: if A=128;"NU2SH1"→D#
25: if A=256;"NU3SH1"→D#
26: if D##"ERROR";sto +3
27: beep;dsp "chose a number from front panel"
28: wait 3000;sto "Set_ave"
29: urt "Analyzer","HLTAV2LST0",D#
30: ret
31: "Bin_groups":15→F[1];18→F[2];23→F[3];29→F[4];36→F[5];45→F[6];57→F[7]
32: 71→F[8];89→F[9];112→F[10];142→F[11];178→F[12];12→F[13];15→F[14];18→F[15]
33: 23→F[16];29→F[17];36→F[18];45→F[19];56→F[20];71→F[21];89→F[22];112→F[23]
34: 141→F[24];178→F[25];45→F[26];57→F[27];71→F[28];89→F[29];112→F[30]
35: 142→F[31];179→F[32];19→L[1];24→L[2];30→L[3];37→L[4];46→L[5];58→L[6]
36: 72→L[7];91→L[8];114→L[9];143→L[10];180→L[11];226→L[12];15→L[13];19→L[14]
37: 24→L[15];30→L[16];37→L[17];46→L[18];58→L[19];72→L[20];91→L[21];114→L[22]
38: 143→L[23];179→L[24];225→L[25];58→L[26];72→L[27];91→L[28];114→L[29]
39: 143→L[30];179→L[31];225→L[32]
40: ret
41: "Fft_weights":fti (67)→C#
42: for I=1 to 1568;C#→B#[2I-1,2I];next I
43: .25→T[1];.1→T[2];.3→T[3]→T[4]→T[5];.2→T[6]→T[7]→T[8]
44: .1→T[9];.2→T[10];.3→T[11];.2→T[12];.15→T[13];.25→T[14]
45: .1→T[15];.2→T[16];.3→T[17]→T[18];.2→T[19]→T[20]→T[21]
46: .1→T[22]→T[23];.2→T[24]→T[25];.1→T[26];.2→T[27]→T[28]
47: .1→T[29]→T[30];.3→T[31];.2→T[32]
48: for I=1 to 32;fti (100T[I])→B#[98(I-1)+1,98(I-1)+2];next I
49: .67→T[1];.4→T[2]→T[3];.5→T[4]
50: .5→T[5];.4→T[6];.5→T[7];.4→T[8]→T[9]→T[10]→T[11]→T[12]
51: .4→T[15]→T[16];.5→T[17]→T[18];.4→T[19]→T[20]→T[21]→T[22]
52: .3→T[23];.5→T[24]→T[25];.4→T[26]→T[28];.3→T[29];.4→T[30]
53: .5→T[31]→T[32];.67→T[13]→T[14]→T[27]
54: for I=1 to 32;fti (100T[I])→B#[98(I-1)+3,98(I-1)+4];next I
55: .4→T[2]→T[3];.5→T[4]→T[5];.4→T[6];.5→T[7];.4→T[8]→T[9]→T[10]→T[11]→T[12]
56: .4→T[15]→T[16];.5→T[17]→T[18];.4→T[19]→T[20]→T[21]→T[22];.3→T[23]
57: .5→T[24]→T[25];.4→T[26]→T[28]→T[30]
58: .3→T[29];.5→T[31]→T[32];.67→T[1]→T[13]→T[14]→T[27]
59: for I=1 to 32;L[I]-F[I]→K
*776
```



```

60: fti (100T[I])+B#[98(I-1)+2K-1,98(I-1)+2K];next I
61: .25+T[1]+T[3]+T[14];.2+T[2]+T[6]+T[7]+T[8]+T[10]+T[12]+T[15]+T[16]+T[19]
62: .2+T[20]+T[21]+T[24]+T[25]+T[27]+T[28]+T[32]
63: .3+T[4]+T[5]+T[11]+T[17]+T[18]+T[31];.5+T[13]
64: .1+T[9]+T[22]+T[23]+T[26]+T[29]+T[30]
65: for I=1 to 32;L[I]-F[I]+1+K
66: fti (100T[I])+B#[98(I-1)+2K-1,98(I-1)+2K];next I
67: ret
68: "Setup":
69: wrt "Analyzer","AA1AB0AX0SC2PA0PB0PX0CH0PS2FR1RP1HD2IM1TR0RR0"
70: wrt "Analyzer","LAS";red "Analyzer",S
71: 10f((S-80)/10)+C
72: 1023/80+D;8/1023+E
73: ret
74: "Pass_1":wrt "Analyzer","SP8RUNRE"
75: wait 2000
76: if A##"yes"goto +3
77: wrt "Analyzer","LST0"
78: if bit(6,rdb("Analyzer"))=0;goto -1
79: 1+M;12+L;esb "Third_Octave"
80: ret
81: "Pass_2":wrt "Analyzer","SP12RUNRE"
82: wait 1000
83: if A##"yes"goto +3
84: wrt "Analyzer","LST0"
85: if bit(6,rdb("Analyzer"))=0;goto -1
86: 13+M;25+L;esb "Third_Octave"
87: ret
88: "Pass_3":wrt "Analyzer","SP14RUNRE"
89: wait 1000
90: if A##"yes"goto +3
91: wrt "Analyzer","LST0"
92: if bit(6,rdb("Analyzer"))=0;goto -1
93: 26+M;32+L;esb "Third_Octave"
94: ret
95: "Plot_response":for I=1 to 32
96: D(T[33-I]+80-S)+P
97: if P>1023;1023+P
98: if P<0;0+P
99: for J=1 to 8;P+M[8I+J-8];next J;next I
100: wrt "Analyzer","WTM,74400,256"
101: for I=1 to 256;wtb 731,shf(M[I],8);wtb 731,M[I];next I
102: ret
103: "Annotation":fwt 1,c5,f3.0,c29
104: wrt "Analyzer.1","WTA1,";S," dBV FULLSCALE --- 10 dB/DIV "
105: wrt "Analyzer","WTA2,"
106: wrt "Analyzer","WTA3,16 Hz          20 KHz"
107: wrt "Analyzer","WTA4,  32 THIRD-OCTAVE SEGMENTS  "
108: ret
109: "Third_Octave":wrt "Analyzer","HLTLFN,74400,256";red "Analyzer"
110: for I=1 to 256;ior(shf(rdb(731),-8),rdb(731))+M[I];next I
111: for I=1 to 256;Eband(M[I],1023)+M[I]
112: if M[I]=0;goto +2
113: 10+(M[I]+S/10-8)+M[I]
114: next I
115: for I=M to L;0+P;for J=F[I] to L[I]
116: J-F[I]+1+K;B#[98(I-1)+2K-1,98(I-1)+2K]+C#
117: P+.01;itf(C#)M[257-J]+P;next J
118: if P<C;goto +2
119: 10log(P)+T[I];goto +2
120: S-80+T[I]
121: next I
122: ret
*9859

```

ACCESSING THE 3582A MEMORY WITH HP-IB

AN 245-4

FOREWORD

Fast Fourier Transform (FFT) analyzers like the HP 3582A are truly *fast*. The 3582A can analyze a time domain signal up to 200 times faster than a comparable swept frequency analyzer. This is one of the reasons that it is being increasingly used in automatic test systems and other applications where speed is essential.

In addition, the 3582A generates some interesting intermediate results which are not available through operating the front panel controls. An example is the cross-power spectrum, which is one of the terms required for calculating the averaged transfer function.

Considerations like these prompted the writing of this application note, whose primary purpose is to spell out clearly the internal memory structure of the 3582A and the various kinds of data to be found there. Equipped

with this information and an HP-IB* controller like the 9835A Desktop Computer, a user may speed up data transfers, obtain normally inaccessible data, modify some routines, and do many other special tasks.

Included with the explanations are listings of several small programs written in BASIC, the language of the 9835A. Our hope is that you will examine the text, the memory maps, and the programs, and then try your own hand at this level of instrument control. You may then wonder how you ever got along before the age of "intelligent instruments"!

*HP-IB is Hewlett-Packard's implementation of IEEE Standard 488 and identical ANSI Standard MC1.1 "Digital Interface for Programmable Instrumentation."

THE HEWLETT-PACKARD MODEL 3582A SPECTRUM ANALYZER

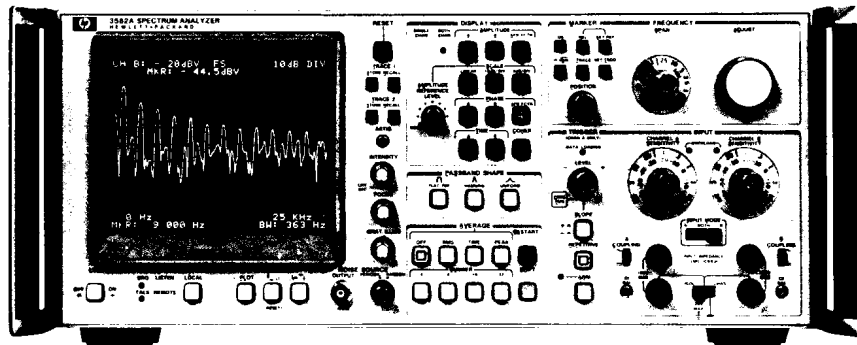

The HP 3582A is a spectrum analyzer covering the frequency range of DC to 25 kHz. Although it is a FFT-based, digital instrument, a special design effort has made it as straightforward to use as a conventional swept analyzer. With dual measurement channels it is possible to measure transfer function gain and phase, as well as the coherence function. A built-in random or pseudo-ran-

dom noise source, whose spectrum tracks the analysis range, is a useful measurement stimulus. Band Selectable Analysis enables narrowband, high resolution analysis to be applied to any portion of the frequency range. The instrument comes equipped with a flexible HP-IB interface for control and two-way data transfers.

TABLE OF CONTENTS

	Page
Section 1: Scope of this application note	1
Section 2: Definitions of concepts and terms	1
Section 3: HP-IB instructions for memory operations	2
Section 4: Individual memory blocks	3
a) Display	
b) Stored traces	
c) Raw spectrum	
d) Power averages	
e) Time record	
Section 5: Illustrative programs	8
a) Storing display on a tape cartridge	
b) Calculating phase from the cross-power spectrum	
c) Generating and loading an external time record	
d) Intensified marker for time records and stored displays	
e) Subtracting two traces	
f) Modifying the number of RMS averages	
g) Internal filter response correction	
Summary	13

Section 1: Scope of this application note

The 3582A belongs to a group of programmable instruments sometimes referred to as “third level” HP-IB instruments. These are the levels of remote programmability, in order of complexity:

1. Front panel controls may be remotely set
2. Bi-directional data transfer over the bus is possible
3. The internal controller and/or its memory may be remotely accessed and modified

Third level (we could say “third generation”) instruments date from about 1978, the year of the introduction of the 3582A. Hence, not many users have had a chance to explore the programming flexibility made possible by access to an instrument’s controller and memory.

READ/WRITE MEMORY. *This application note is intended to provide the information needed to work with the read/write part of the 3582A’s internal memory.* There is also a fixed part of the memory containing instructions for all the instrument’s routines. However, processed results of measurements, in-process results, and raw data are found in the read/write memory, and a primary purpose of this note is to help the user to locate, access, and modify this data.

Another purpose is to help a user who wants to speed up data transfer, such as is needed for automatic testing. For example, the HP-IB command “LDS” will cause the 3582A to list out all the numeric data appearing on the display. The listing is in ASCII format, complete with decimals, signs, commas, etc. It is ready for output to a

printer, typewriter, or display. But it is lengthy, and perhaps too slow for some applications. By contrast, if you need just a few display points, or a faster “dump,” *and you are willing to do a little more programming,* you can directly access the binary data the internal hardware uses to produce the display. True, the data isn’t in a form ready to drive a line printer, but it is probably well suited for an automatic test system.

PROGRAM EXAMPLES. Several program listings are given to illustrate some ways of working with the various memory blocks. The program language is BASIC, as used by the 9835A and 9845A controllers. Similar programs can be written in HPL for the 9825A, FORTRAN for the System 1000, or in other languages. It is important that the reader be familiar with input/output statements, especially those used for binary data transfers. It is also helpful to know how to perform conventional binary operations (OR, AND, SHIFT, etc.) on the data.

OTHER LITERATURE. This application note is an extension of some material in the 3582A User’s Guide, “Understanding the HP 3582A Spectrum Analyzer.” A copy of this guide is recommended for a comprehensive explanation of the operation of the 3582A. It is available through HP field sales offices under part number 5952-8773.

For an additional programming example of memory access, see Application Note 245-3, “Third Octave Analysis with the 3582A Spectrum Analyzer.”

Section 2: Definitions of concepts and terms

The subject matter of this application note is strongly rooted in computers and digital signal processing. Because of this, certain terms and concepts peculiar to these subjects are frequently used. Some of these may be confusing, or worse, opaque to the non-specialist.

The following glossary may be helpful:

RAM. “Random-Access Memory,” the type of read/write binary data storage used by the 3582A controller.

WRITE. To insert new binary data into a location in the 3582A RAM, destroying what was stored there.

READ. To withdraw a duplicate of the binary data stored at a RAM location without destroying what was stored there.

WORD. 16 ordered bits of data; the contents of one RAM address.

ADDRESS. An orderly means of designating word locations in RAM. In this note, octal numbers are used for addresses.

BYTE. One half word. “Least significant byte” (LSB) refers to bits 0-7, and “most significant byte” (MSB) refers to bits 8-15:

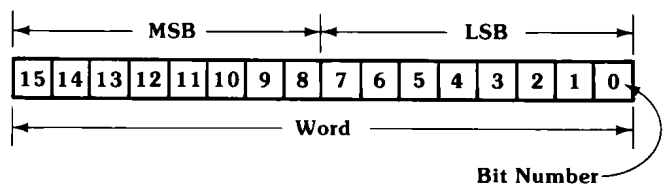

2's COMPLEMENT. A means of representing both positive and negative integers with binary numbers. In the 3582A, fundamental processing and storage occurs with 16 bit, 2's complement words, spanning a numeric range of -32768 to +32767. See page 43 of "Understanding the HP 3582A Spectrum Analyzer."

CRT. "Cathode ray tube," a shorthand expression for the type of electronic display used in many instruments, including the 3582A.

BIN. This is used in two separate but related senses. First, it refers to any of the individual "filters" (or their signal content) generated by the FFT algorithm. In the 3582A there are 256 of these in single channel mode (numbered 0-255) and 128 in dual channel (0-127). For instance, in the single channel, 0-25 KHz span, BIN #125 is 12.5 KHz.

Secondly, BIN refers to the left-to-right position on the 3582A display corresponding to a particular FFT filter.

Section 3: HP-IB instructions for memory operations in the 3582A

Four 3582A HP-IB instructions are defined for the purpose of accessing internal memory data: LFM, WTM, HLT, and RUN. Programming examples in Section 5 will help to clarify how to use these instructions efficiently to accomplish your objectives. Here are the important features of each:

LFM. The mnemonic refers to "list from memory." This is the instruction used to read any number of words (in consecutive addresses) from the 3582A RAM. The following ASCII sequence must be sent by the controller:

```
LFM,XXXXX,YYYY[linefeed]
```

XXXXX is the *octal* address of the first binary word, and YYYY is the total *decimal* number of consecutive words to be read. On the HP-IB, data transmission takes place in bytes; a 16 bit word is sent in two bytes, the MSB first. Normally, the programmer doesn't have to be concerned with this, since both analyzer and controller automatically take care of "packing" two bytes into one word and vice-versa. (For a counter example where such packing is not wanted, see line 170 of Figure 7. Also note that the 9825A Calculator does not have the packing feature.)

Consider the following 9835A program line:

```
100 OUTPUT 711; "LFM,76077,3"
```

"711" indicates that the HP-IB interface card is set to select code #7 and the 3582A is set to bus address 11. When activated, this line will command the 3582A to prepare to send back the words contained in octal addresses 76077, 76100, and 76101.

Important: This only *prepares* the 3582A to send the data; actual transfer doesn't take place until the controller

addresses the 3582A to talk, itself to listen (for binary, not ASCII, data) and begins the HP-IB handshake. A line like

```
110 ENTER 711 USING "#,3(Y)"; A,B,C
```

will do all this for the 9835A. "#" cancels the need for a linefeed terminator, and "3(Y)" combines the six transmitted bytes into the three variables A, B, and C.

WTM. This instruction is the counterpart to LFM and stands for "write to memory." The syntax to be used by the controller is similar:

```
WTM,XXXXX,YYYY[linefeed]
```

This sequence prepares the 3582A to interpret the subsequent HP-IB data as bytes to be written into RAM.

For this reason, both the instruction sequence and the data can be combined into one program line, if desired:

```
120 OUTPUT 711 USING  
"11A/3(Y)";"WTM,76077,3",A,B,C
```

"11A" allows the WTM sequence to be output as an ASCII string, while "3(Y)" separates each 16 bit variable into 2 bytes for transmission on the bus. "/" transmits a linefeed after the WTM string, as required by the 3582A syntax.

Both LFM and WTM operations abort "graciously;" that is, if they are interrupted by the controller in the midst of data transfer, whatever new operation is commanded will begin. Or, if un-addressed, data transfer will recommence where it was interrupted when the 3582A is again addressed.

HLT. This means “halt” and refers to the 3582A internal processor operation. It does not actually stop processing; rather, it traps the processor at a location in its round of jobs where it is servicing the HP-IB. If this command were not used, data transfers via the bus would be interleaved with other processor tasks, such as performing the FFT. This would result in taking considerably longer time for the data transfer, whereas after sending “HLT” we have the full attention of the processor to perform our job.

After “HLT,” bus instructions other than “WTM” and “LFM” can also be sent, such as front panel setups. But the processor will not respond the *momentary* front panel operations like “restart” or “trace store.”

RUN. If “HLT” was used, this instruction should be sent at the end of the instruction sequence to allow the processor to continue on its appointed rounds. After receiving “RUN,” normal operation will resume, although the 3582A will still remain under remote control. From the “halt” condition, you can return both to normal operation and to local control by sending the “return-to-local” sequence. In the 9835A, this would be

130 LOCAL 711

(assuming 11 is the bus address of the 3582A).

Section 4: Individual memory blocks

In this section we will describe five kinds of information resident in the 3582A during the course of its operation:

- (A) **CRT DISPLAY BUFFER**
- (B) **STORED TRACES**
- (C) **RAW (UNPROCESSED) SPECTRUM**
- (D) **RMS AVERAGED SPECTRA**
- (E) **TIME RECORD**

Each of these is described in terms of where it is located in RAM, the form of the data, and additional information needed to properly access and process the information.

(A) CRT DISPLAY BUFFER

Control of the visual output of the 3582A depends on the contents of 512 words beginning at location 74000. This section is continuously accessed by the display hardware such that the screen is refreshed about 50 times per second; this direct memory access continues regardless of whether the data is being changed by the processor. In fact, this is the means by which the dynamic RAM data is kept alive.

The data packed into the 512 words contains:

- the vertical position of the points which make up the trace(s)
- the code to generate four lines of annotation
- whether a trace point is to be intensified
- whether a trace point is to be blanked

The display buffer organization depends on whether the instrument is in single or two channel mode. In addition, commanding a display of a time record momentarily changes the format. Figure 1 is a memory map of the display buffer, showing both one and two channel modes. (Time record displays are described in a paragraph below.) The different buffer size is related to the fact that single channel displays contain 256 points per trace, while dual channel traces have 128. Additional facts about the buffer are:

WORD CONTENT. Bits 0-9 form a binary number which locates the corresponding display point linearly from the bottom (0) to the top (1023) of the graphic area of the CRT. If bit 14 is set, the point is intensified, as in the marker operation. Bit 15 blanks the point; the words of all non-displayed traces have bit 15 set.

There are 128 possible positions for annotation, 32 characters to a line. The code for each character spans 4 words, using bits 10-13 in each word. Because of this complexity, we recommend that you use the “WTA” (i.e., “write alpha”) instruction to annotate the display, and the necessary bit juggling will be done automatically.

WORD ORDER. In the conventional sense, the words are in reverse sequence: lowest addresses correspond to the *right* side of the screen, and highest addresses to the *left* side. The same is true for the annotation: addresses 74774 to 74777 contain the code for the character in the lower left corner of the display, while the upper right character is found in 74000 to 74003.

TRACE BLOCKS. The 128 or 256 consecutively addressed words which contain all the graphic data for one trace are placed as high in the buffer address space as possible. For example, in single channel mode, Amplitude A will be located from 74400 to 74777. Then, if Phase A is called up, it is placed from 74000 to 74377. If Amplitude A is removed, leaving only the phase display, the phase data will be moved to the higher address block. The priority followed in determining which of two displays occupies the higher address block is (in descending order) Amplitude A, Amplitude B, Amplitude Transfer Function, Phase A, Phase B, Phase Transfer Function, Coherence, Stored Trace 1, Stored Trace 2.

DISPLAYING A TIME RECORD. The time buffer consists of 1024 words starting at address 7000 (see paragraph (E) of this section). When the front panel TIME button for either channel is pressed (or, equivalently, "TA" or "TB" commands are sent over the HP-IB), one-half the stored time record is scaled to 10 bits and displayed as follows:

One channel — 512 points, consisting of the data in the even numbered addresses of the time buffer (70000, 70002, etc., to 71776).

Two channels — 256 points. In dual channel mode, the time buffer data is interleaved, with channel A occupying even addresses, and channel B odd. Therefore, the display shows data in addresses ending in 0 and 4 for channel A, and addresses ending in 1 and 5 for channel B.

Figure 1.
CRT Display Buffer
 (for all displays except time records;
 for these, see Section 4A)

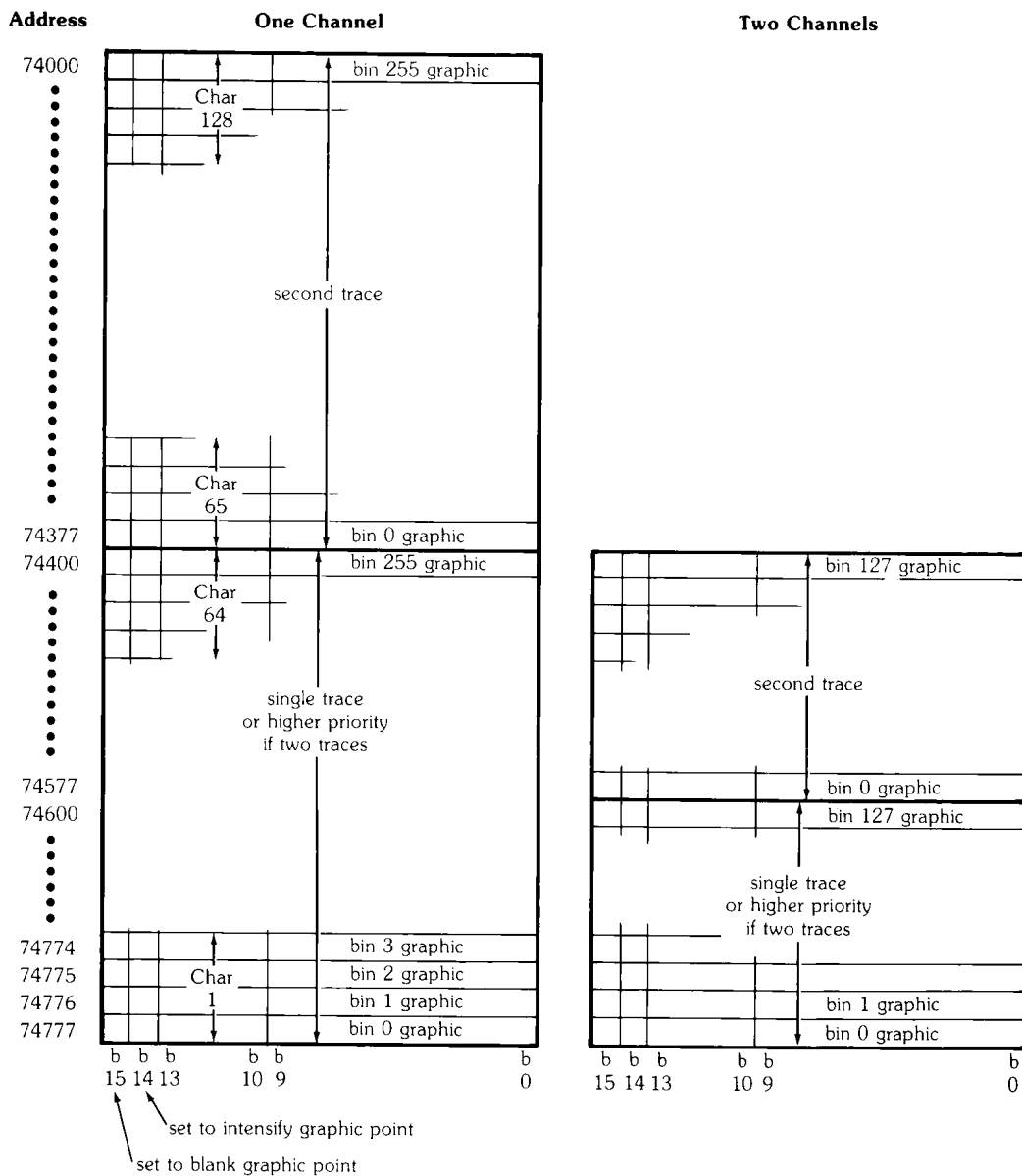

SAVING A DISPLAY IN MASS STORAGE. Often one wants to store away data and examine it at some future time. A convenient way to do this with the 3582A is to save the entire display buffer and then restore it to the CRT when desired. Figure 6 lists a program to do this job, using a string variable to hold the binary data. It is important to obtain and save information about the display state of the 3582A; that is, whether it is in single channel, dual channel, or time display modes when the display is recorded. This information could be recorded manually and the analyzer adjusted to that state before displaying the saved data. However, the same result can be achieved automatically by saving the contents of address 77455, one of the five switch register words in which the state of the front panel controls is stored. (This is part of the "learn mode" routine on page 46 of "Understanding the 3582A Spectrum Analyzer.")

(B) STORED TRACES

There are four switches whose function is to store and recall one or two traces from the display. 512 words of RAM are allocated for this storage. The principle difference between the data stored in this buffer and that stored in the display buffer is that the stored trace words contain only the 10 bits of graphic information — no intensify, blanking, or alpha character codes. Figure 2 shows the memory location and format of the stored traces buffer for single and dual channel modes.

If one does not use the stored trace function very often, its buffer could be a convenient place to store other data temporarily. Two minor words of caution if you do this: don't operate the STORE switches, or your data will be overwritten; and don't switch from single trace to dual trace modes, or vice-versa, as the processor may set bit 15 when moving around the data.

Figure 2.
Stored Traces

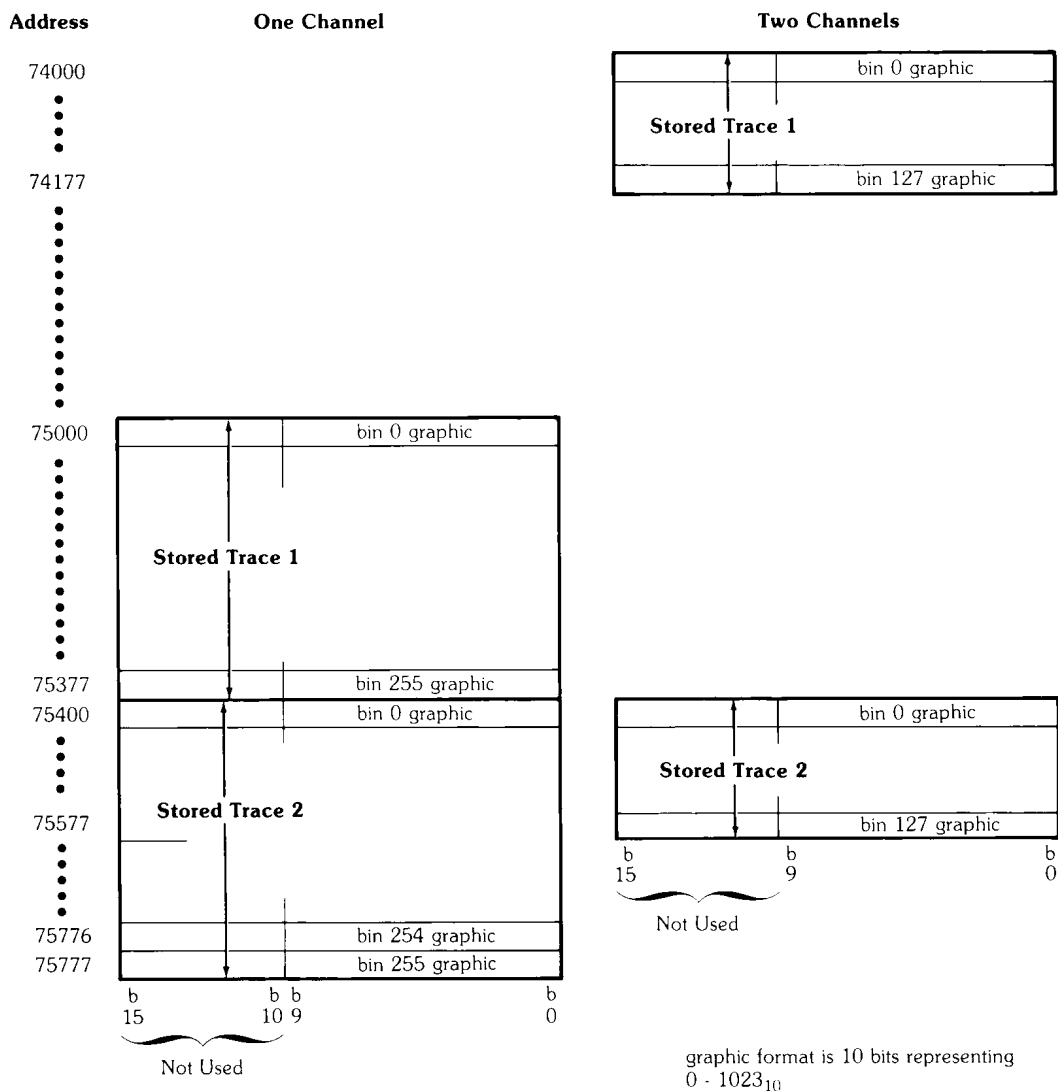

(C) RAW (UNPROCESSED) SPECTRUM

When the FFT finishes processing a time record (two records for dual channel operation), its results are transferred to a spectrum buffer. A memory map of this is shown in Figure 3. Each frequency (or "bin") in the spectrum is represented by two words, the real and imaginary magnitudes in 2's complement form. In single channel operation, there are 256 pairs of words; in dual channel there are two sets of 128 pairs each. This data is the raw material used to create the display commanded by the front panel controls.

Before you attempt to use the raw spectrum data directly, consider the fact that it contains three systematic errors which are removed by the display processing algorithms before presentation on the CRT. These are the errors:

CAUTION Systematic errors contained in the raw spectrum:

- 1) The phase shift of the 25 KHz analog input filters. This is greatest in the 0-25 KHz span.
- 2) The phase shift and passband ripple of the digital anti-alias/decimation filters.
- 3) The linear phase shift caused by the location of the time record in the time buffer. This usually varies from record to record and is caused by non-synchronism between trigger and sampling pulses.

These errors apply to all signals which reach the time buffer the usual way, i.e., via the front terminals. However, if you write directly into the time buffer, bypassing the signal conditioning, the raw spectrum will be as accurate as the 16 bit arithmetic allows.

The magnitude error caused by passband ripple in the digital filters (about 1.2 dB worst case) can be removed by comparing the stored spectrum data with the displayed magnitude. Figure 12 is a program to do this.

Figure 3.
Spectrum Buffer
(non-averaging)

*NOTE: Before using data stored herein,
see Caution in Section 4(C)*

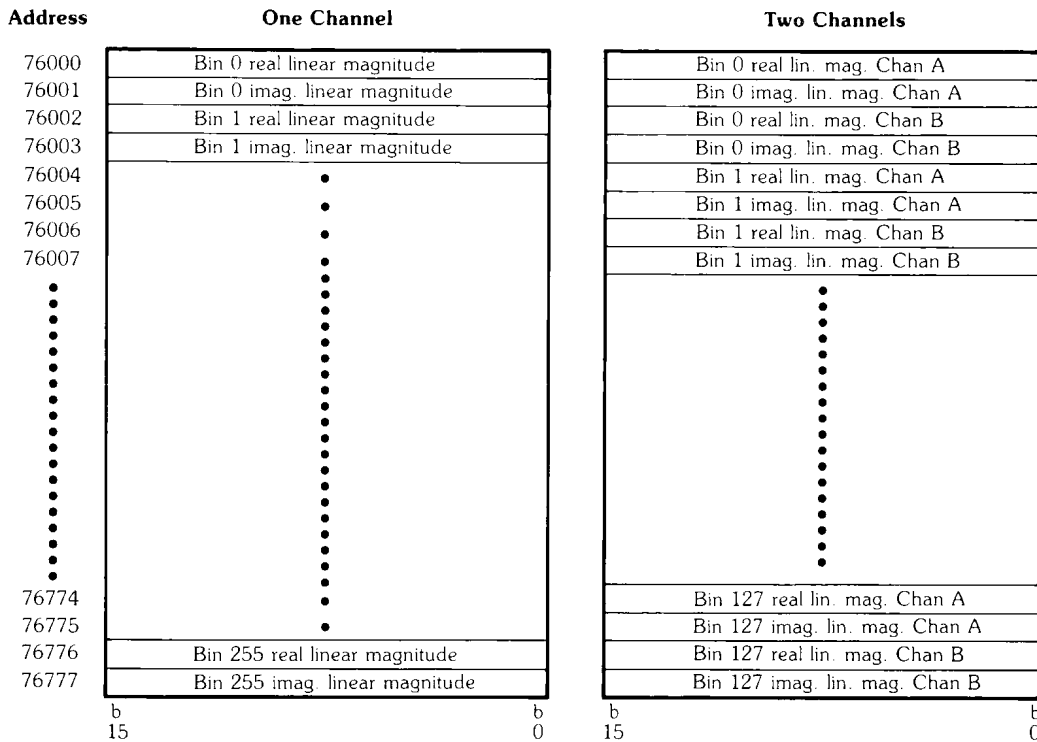

data format is 16 bit 2's complement
binary representing -32768 to 32767

(D) RMS AVERAGED SPECTRA

After the 3582A performs from 4 to 256 "RMS" averages, there are two types of results available in memory:

- Auto (or self) power spectra* for one or both channels, depending on the input mode
- The cross power spectrum*, when in dual channel mode

Figures 4 and 5 show the memory organization for these two types of buffers. During averaging, the buffers are used as accumulators. Therefore, at the end of averaging, the numbers therein are the sum of N individual power spectra, where N is the number of averages (4 to 256) chosen. *To get the true average, you must divide the data in the buffers by N.*

Both types of spectrum contain the passband ripple errors mentioned in (C) above, except that the cross spectrum has twice the error (in dB), since it is obtained through multiplying data from two identical channels.

Phase errors don't apply to either spectrum for these reasons:

- 1) Auto spectra are phaseless. (The phase data available in the 3582A with auto spectra is obtained by a simple linear averaging process.)
- 2) Cross spectra are obtained by conjugate multiplication, and the phase errors cancel.

The comments in Section 5, Figure 12, indicate how you can determine the magnitude errors in order to remove the intrinsic ripple from the data before you use it.

*For an explanation of these spectra and their usefulness, see Application Note 245-1, "Signal Averaging With the HP 3582A Spectrum Analyzer," Sections 3, 5, and 6; also Application Note 245-2, "Measuring the Coherence Function With the HP 3582A Spectrum Analyzer," Appendix.

(E) TIME RECORD

After the input signal is conditioned, its sample values are written into a 1024-word buffer from address 70000 to address 71777. The data is 2's complement binary. When using the dual channel mode, Channel A data is written into even-numbered addresses, and Channel B into odd-numbered addresses. In REPETITIVE operation, new data is written into this buffer whenever the FFT can accept it. For this reason, if you want to preserve the time record (you may have written in your own record over the HP-IB, for instance), you should turn REPETITIVE off. When this is done, the processor will continue to read the time record into the FFT buffer 2-3 times per second, but it will be reading the *same* time data.

Figure 4.
Auto (Self) Power Spectra
(RMS Averaging)

NOTE: Read Section 4(D) before using this data

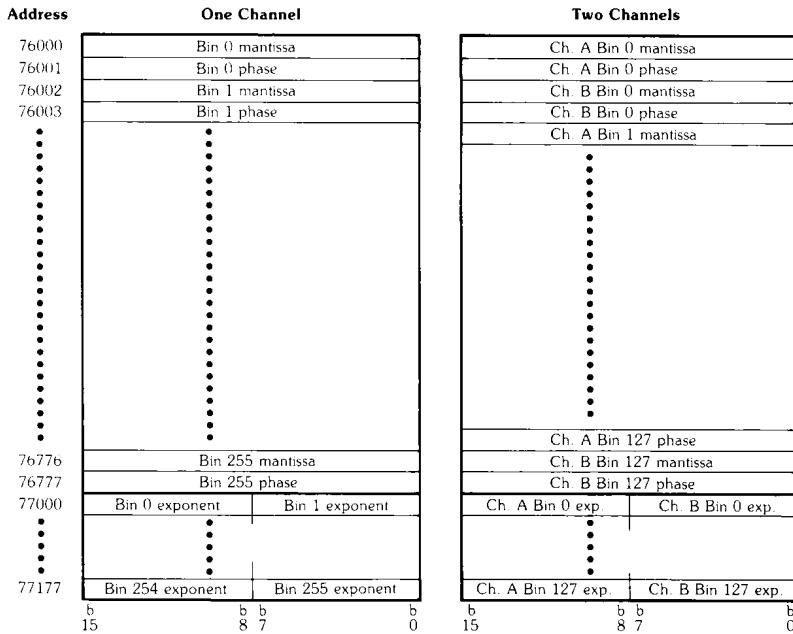

Data Formats:

[Amplitude]²: binary floating point number, evaluated as follows

$$\left(\begin{array}{l} \text{mantissa} \\ \text{16 bit 2's complement} \end{array} \right) \times 2^{\left(\begin{array}{l} \text{exponent} \\ \text{8 bit positive binary} \end{array} \right) - 15}$$

Phase: 2's complement, in which $\pm 2^{15}$ corresponds to $\pm 200^\circ$

Figure 5.
Cross Power Spectra
(RMS Averaging)

NOTE: Read Section 4(D) before using this data

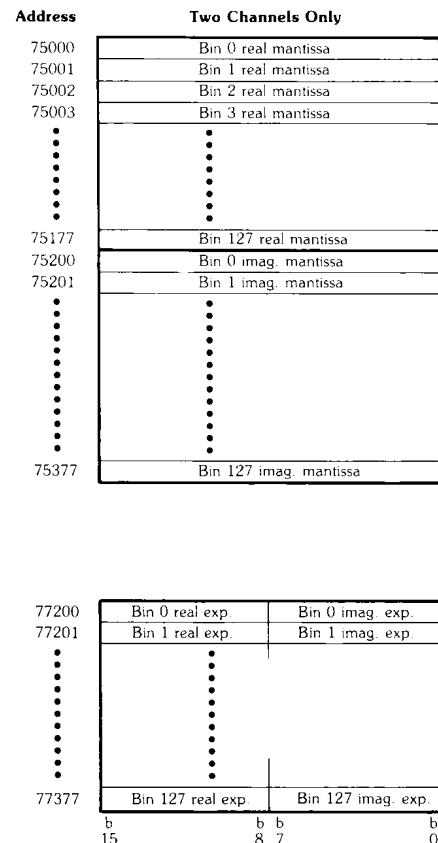

data formats are the same as those of auto power spectra

WINDOW FUNCTIONS. Some measurements could benefit from the use of other window functions than those provided with the 3582A. Exponential windows are useful with transients, for instance. Here is a way to implement your own choice of window function: with REPETITIVE off, enter one time record using the UNIFORM PASSBAND SHAPE (the rectangular win-

dow). Then read the time buffer into the controller, multiply the data by the desired window, and write the modified data back to the time buffer. If a gain correction is desirable, the spectrum data can be multiplied by the appropriate factor; this will avoid possible overload of the time buffer.

Section 5: Illustrative programs

In this section you will find some annotated programs, along with explanatory comments for each. This is not meant to be a comprehensive "library" of software. Rather, the programs are included both for their usefulness, and also as illustrations of BASIC statements needed to work with the 3582A memory.

The following programs are included:

- Fig. 6: STORING THE DISPLAY ON A TAPE CARTRIDGE**
- Fig. 7: CALCULATING PHASE FROM THE CROSS-POWER SPECTRUM**
- Fig. 8: GENERATING AND LOADING AN EXTERNAL TIME RECORD**
- Fig. 9: INTENSIFIED MARKER FOR TIME RECORDS, STORED DISPLAYS, ETC.**
- Fig. 10: SUBTRACTING TRACES**
- Fig. 11: MODIFYING THE NUMBER OF RMS AVERAGES**
- Fig. 12: INTERNAL FILTER RESPONSE CORRECTION**

STORING THE DISPLAY (Fig. 6). Many applications require semi-permanent storage of spectrum information produced by the 3582A. (A common example is monitoring bearing vibration; a series of records is kept to reveal any adverse trends in a bearing's "health.") This program allows any type of display to be saved in its entirety: one or two traces, marker dot, and annotation. This is because it saves the full 512 word display buffer. Before writing the stored data back on the CRT, the 3582A is forced back to the display state it was in when the data was recorded, and "HLT" is transmitted to prevent over-writing the stored data with current data.

Although this is the easiest and fastest method for display storage, it has the disadvantage that the stored display is static; the marker can't be used, nor can the display format (like SCALE) be changed. There are a couple of ways to overcome this: either store the time record, or (in the case of RMS averaging) store the spectrum buffer. If you do the latter, you should get the 3582A to the same state it was — that is, restore the INPUT and FREQUENCY controls, and execute the same number of averages before loading in the stored data.

Figure 6

```

10  ! PROGRAM TO SAVE AND RETRIEVE 3582A DISPLAY
20  ! "Save" SAVES DISPLAY BUFFER (A#) AND DISPLAY STATE (B#);
30  ! "Retrieve" REMOTES 3582A AND LOADS STORED DISPLAY STATE AND DISPLAY.
40  ! STORAGE MEDIUM FOR THIS PROGRAM IS BUILT-IN TAPE CARTRIDGE.
50      OPTION BASE 1
60      DIM A#[1024],B#[2]                ! initialize variables.
70      Analyzer=711
80      CREATE "SAVDSP",1,1100            ! establish data buffer on tape.
90      ASSIGN #1 TO "SAVDSP"
100     PAUSE
110 Save: OUTPUT 711;"HLTLFM,77455,1"      ! get switch register word
120     ENTER Analyzer USING "#,2A";B#     ! containing display state.
130     OUTPUT Analyzer;"LFM,74000,512"    ! set entire display buffer;
140     ENTER Analyzer USING "#,1024A";A#  ! 512 16-bit words.
150     LOCAL Analyzer
160     PRINT #1;A#,B#                    ! save display data and switch state on tape.
170     PAUSE
180 Retrieve: READ #1,1                   ! reposition file data pointer.
190     READ #1;A#,B#                     ! load display and switch data from tape.
200     OUTPUT Analyzer USING "11A/2A";"WTM,77455,1";B# ! set display state.
210     OUTPUT Analyzer USING "16A/1024A";"HLTWTM,74000,512";A# ! load buffer.
220     PAUSE

```

CROSS-POWER SPECTRUM PHASE (Fig. 7).

Marker readout of phase has only one degree resolution, largely because of the phase accuracy specification of the 3582A. This, in turn, comes from the imperfect characteristics of the analog input filters, especially over the environmental operating range. However, for restricted environmental change and frequencies much lower than 25 KHz, these filters have less effect on the phase accuracy. In addition, transfer function measurements increase phase accuracy by first-order tracking of the two channels.

These considerations make it attractive to increase the

resolution of the measured phase, and the program is intended for this purpose. The principle is to perform an RMS average of the transfer function, and then to calculate and display the phase, using the stored real and imaginary components of the cross-power spectrum.

The program asks for which bin (of the 128 available) the phase is wanted. It then extracts the spectrum components for that bin, calculates the phase in degrees, and displays it to 0.1 degree resolution. Given the data for the frequency setup of the 3582A, the program could be easily modified to request frequency rather than bin number.

Figure 7

```
10 ! PROGRAM TO COMPUTE AND DISPLAY CROSS-POWER (AND THUS TRANSFER
20 ! FUNCTION) PHASE. MUST BE USED AFTER RMS AVERAGING.
30 Analyzer=711 ! initialize.
40 DEG
50 INPUT "Bin number (0-127)?",Dec
60 Dec_bin=Dec
70 Oct_bin=0 ! convert bin number to octal; this routine
80 FOR I=0 TO 2 ! required for 9845A.
90 Oct_bin=Oct_bin+Dec_bin MOD 8*10^I
100 Dec_bin=INT(Dec_bin/8)
110 NEXT I ! "Oct_bin" is bin number in octal.
120 OUTPUT Analyzer USING "7A,5D,2A";"HLT LFM,";75000+Oct_bin,";1"
130 ENTER Analyzer USING "#,Y";Re_mant ! get the real spectrum mantissa.
140 OUTPUT Analyzer USING "4A,5D,2A";"LFM,";75200+Oct_bin,";1"
150 ENTER Analyzer USING "#,Y";Im_mant ! get the imag spectrum mantissa.
160 OUTPUT Analyzer USING "4A,5D,2A";"LFM,";77200+Oct_bin,";1"
170 ENTER Analyzer USING "#,B,B";Re_exp,Im_exp ! get real and imag exponents.
180 Arg=Im_mant/Re_mant*2^(Im_exp-Re_exp) ! calculate IMAG/REAL.
190 Phase=ATN(Arg)+(SGN(Re_mant)=-1)*SGN(Im_mant)*180
200 PRINT USING "6A,3D,8A,DDDD.D,4A";"BIN # ";Dec;" PHASE= ";Phase;" DEG"
210 LOCAL Analyzer
220 GOTO 50
```

EXTERNAL TIME RECORD (Fig. 8). In "Understanding the HP 3582A Spectrum Analyzer," page 45, there is an explanation and an example of writing external data into the time buffer so that it may be examined

and analyzed just as if it had originated as an input signal. The program given here is much the same, except that it is written in BASIC.

Figure 8

```
10 ! PROGRAM TO GENERATE A SAMPLED SINUSOID AND WRITE IT INTO THE
20 ! 3582A TIME BUFFER.
30 RAD ! set calculator in radian mode.
40 INTEGER T(1023) ! initialize integer variable to store samples.
50 Analyzer=711
60 INPUT "FREQUENCY (CYCLES PER RECORD)?",F ! ask for frequency wanted.
70 Const=2*PI*F/1024 ! compute this once rather than 1024 times.
80 FOR I=0 TO 1023 ! computing loop.
90 T(I)=20000*COS(Const*I) ! values are rounded to integers
100 NEXT I ! through using integer variable.
110 OUTPUT Analyzer;"RP0IM1TA1HLT" ! REPETITIVE off; one chan.; disp TIME.
120 OUTPUT Analyzer USING "14A/1024(Y);3A";"WTM,70000,1024";T(*);"RUN"
130 GOTO 60 ! return for another pass.
```

Appendix

HP 9825A Calculator Program

For the users of the popular 9825A Calculator, the 1/3 octave program is given here in HPL, the language of that machine.

The 9825A version is structurally the same as the 9835A program around which this application note is written. All subroutines have the same labels; this will

help you use the flow diagrams of Section 6 to follow the 9825A version. However, most of the variables are different, because HPL allows only single characters for simple, array, and string variables. Listed below is a table showing corresponding variables in both programs.

EQUIVALENT VARIABLES

9835A Program	9825A Program	Comments
Firstbins(32)	F[32]	
Lastbins(32)	L[32]	
Graphics(256)	M[256]	shared by "Plot__response" and
Fftmag(256)	M[256]	"Third__octave" routines.
Thirdmag(32)	T[32]	also used as a temporary in
		"Fft__weights" routine.
Binweight(32,49)	B\$(3136)	weight values times 100, stored in integer format.
Sensitivity	S	
Minimum	C	
Display__scale	D	
Input__scale	E	
First__third	M	
Last__third	L	
Temp	P	
I	I	
J	J	
K	K	
A	A	
Averaging\$	A\$(3)	
Ave\$	D\$(6)	
---	C\$(2)	used as temporary in "Fft__weights" and "Third__octave".

SUBTRACTING TRACES (Fig. 10). Sometimes it is helpful to be able to perform "trace arithmetic;" this term means not only adding or subtracting trace data, but multiplication, division, and time domain integration or differentiation. The latter two operations are equivalent to applying 6 dB/octave gain decreases or increases in the frequency domain and are a convenient way, for instance, to convert accelerometer data to velocity or displacement.

As an example of this type of data manipulation, the program requests the user to set up two successive traces on the CRT. It inputs the data from each trace, blanks off all but the graphic information, and writes back the difference into the display buffer.

Although the program subtracts the traces, other operations are easily accomplished by changing the contents of the FOR/NEXT loop, lines 140 to 170.

Figure 10

```

10  ! PROGRAM TO INPUT TWO SUCCESSIVE SINGLE CHANNEL AMPLITUDE
20  ! TRACES, AND TO DISPLAY THEIR DIFFERENCE.
30  Analyzer=711                               ! initialize variables.
40  INTEGER First(255),Second(255),Diff(255)
50  DISP "DISPLAY FIRST TRACE, THEN PRESS 'CONTINUE'"
60  PAUSE                                       ! ask for first trace.
70  OUTPUT Analyzer;"HLTLFM,74400,256"
80  ENTER Analyzer USING "#,256(Y)";First(*) ! input first trace.
90  LOCAL Analyzer
100 DISP "DISPLAY SECOND TRACE, THEN PRESS 'CONTINUE'"
110 PAUSE                                       ! ask for second trace.
120 OUTPUT Analyzer;"HLTLFM,74400,256"
130 ENTER Analyzer USING "#,256(Y)";Second(*) ! input second trace.
140 FOR I=0 TO 255
150 Diff(I)=BINAND(First(I),1023)-BINAND(Second(I),1023) ! blank all but
160 IF Diff(I)<0 THEN Diff(I)=0                ! graphics, subtract, set any
170 NEXT I                                       ! negative values to zero.
180 OUTPUT Analyzer USING "13A/256(Y)";"WTM,74400,256",Diff(*) ! send data.
190 OUTPUT Analyzer;"WTA3, FIRST TRACE MINUS SECOND TRACE "
200 OUTPUT Analyzer;"WTA4, "
210 END

```

ARBITRARY NUMBER OF RMS AVERAGES (Fig. 11). Occasionally there is a need to perform a specific number of RMS averages outside the range of choice available in the 3582A. Within certain constraints, this is possible by using the listed program. The program takes advantage of the fact that one word of RAM (location 77465) is used as a cycle counter by the processor during RMS averaging. This word is loaded with the number of averages, decremented during each cycle, and tested for zero content to stop the averaging. The program merely writes a user-supplied value into this

location before allowing averaging to start.

The following constraints apply to averages performed this way:

- 1) Above approximately 1500 averages, roundoff errors will start to degrade the accuracy of the spectrum data.
- 2) Phase information is largely useless, as it will not be properly scaled.
- 3) The average counter on the display will recycle after 999; therefore, the current average count is shown modulo 1000.

Figure 11

```

10  ! PROGRAM TO SET ARBITRARY NUMBER OF RMS AVERAGES.
20  ! THIS ROUTINE OVERRIDES THE AVERAGE COUNTER IN THE 3582A,
30  ! ALLOWING ANY NUMBER OF AVERAGES <32767. HOWEVER,
40  ! ARITHMETIC CONSIDERATIONS LIMIT THE NUMBER TO
50  ! 1500 OR SO; OTHERWISE INACCURACIES WILL RESULT.
60  ! START PROGRAM WITH 3582A IN RMS AVERAGING.
70  Analyzer=711
80  INPUT "HOW MANY AVES?";N                   ! Get number of averages wanted
90  OUTPUT Analyzer USING "16A/Y,3A";"RP0REWTM,77465,1",N,"RP1"
100  GOTO 80

```

INTERNAL FILTER RESPONSE CORRECTION

(Fig. 12). In Section 4C and 4D we mentioned that the various forms of stored spectrum information contain errors resulting from the passband ripple of the digital filters used to process the time signal(s) before applying the FFT. The magnitude errors are removed by the display algorithms before the spectrum data is shown on the CRT. The actual correction depends on the frequency span and whether band analysis is being used.

A practical way to determine the corrections to be applied for any measurement setup is to observe what the 3582A does. That is, you apply a broad-band signal and compare the computed spectrum with the display. The ratio of these contains the correction information.

The program accomplishes this for the case of single channel, non-averaged data. A convenient broad-band source is the internal periodic noise source, which excites each bin at approximately the same level. Both the spectrum data (real and imaginary components) and the linear display data are retrieved. Then a power ratio is obtained by dividing the spectrum power by the display "power" (the square of the linear display data). Since the units of this ratio are obscure at this point, the ratio is nor-

malized so that the largest of the 256 numbers is set to unity. The result is the "Norm" array.

To use the data, follow these rules:

- a) divide linear components (real and imaginary, non-averaged) by the square root of "Norm"
- b) divide auto-power spectra by "Norm"
- c) divide cross-power spectra by the square of "Norm"

Naturally, for two channel operation, and this includes cross-power spectra, you will need to modify the program to work with 128 data bins rather than 256.

One word of caution: there are some small gain corrections which are not included in "Norm." These come from the fact that the digital filter gain varies somewhat, depending on its configuration. If you need absolute magnitude information, and not just flatness correction, you should make an additional calibration measurement. Use a calibrated sinusoidal source set to the bin where "Norm" has its maximum value (unity), and determine the spectrum value there. Of course, the 3582A marker can be used to measure the amplitude of the source, and thus provide the calibration factor.

Figure 12

```
10  ! PROGRAM TO DETERMINE THE CORRECTION FACTORS USED BY THE 3582A TO
20  ! OBTAIN A FLAT RESPONSE IN ANY SPAN; NON AVERAGING.  AN ARRAY "Norm"
30  ! IS COMPUTED GIVING THE NORMALIZED FREQUENCY RESPONSE ON THE BASIS OF
40  ! POWER FOR EACH OF THE 256 BINS.  TO OPERATE, USE PERIODIC NOISE SIGNAL,
50  ! UNIFORM PASSBAND, SINGLE CHANNEL AND ADJUST LINEAR AMPLITUDE DISPLAY
60  ! NEAR TOP OF SCREEN.  TO USE RESULTS, DIVIDE AUTO POWER SPECTRUM DATA
70  ! BY "Norm" OR LINEAR SPECTRUM DATA BY THE SQUARE ROOT OF "Norm".
80  Analyzer=711
90  INTEGER Re(255),Im(255),Dsp(255)      ! declare REAL, IMAGINARY, DISPLAY
100 DIM Norm(255)                        ! and NORMALIZE variables.
110 OUTPUT Analyzer;"HLTLFM,76000,512"    ! set real and imaginary parts
120 FOR I=0 TO 255                        ! of power spectrum.
130   ENTER Analyzer USING "#,Y,Y";Re(I),Im(I)
140 NEXT I
150 OUTPUT Analyzer;"LFM,74400,256"      ! set display data.
160 ENTER Analyzer USING "#,256(Y)";Dsp(*)
170 FOR I=0 TO 255                        ! compute magnitude squared from real
180   Norm(I)=Re(I)*Re(I)+Im(I)*Im(I)    ! and imaginary components.
190   Dsp(I)=BINAND(Dsp(I),1023)         ! mask off extraneous display data.
200 NEXT I
210 FOR I=0 TO 255                        ! compute ratio of magnitude squared
220   Norm(I)=Norm(I)/Dsp(255-I)+2      ! to display magnitude squared; save
230 NEXT I                                ! in NORMALIZE array.
240 Max=Norm(0)                           ! determine largest number.
250 FOR I=1 TO 255
260   IF Norm(I)>Max THEN Max=Norm(I)    ! save it in Max
270 NEXT I
280 MAT Norm=Norm/(Max)                   ! largest value in Norm is now 1.
290 LOCAL Analyzer
300 END
```

Summary:

The 3582A is an instrument with an advanced level of remote programming capability. Specifically, it allows direct access to the internal memory used by the instrument's microprocessor. This opens the door to many kinds of programming possibilities, from speeding up data transfers to modifying certain routines. However, to

use this potential effectively, the user must know more about the internal workings and structure of the instrument.

This application note is intended to provide the necessary documentation and explanation to make this level of programming both possible and attractive.

LOG SWEEP WITH THE HP 3582A SPECTRUM ANALYZER

AN 245-5

FOREWORD

Spectrum analyzers using the Fast Fourier Transform – like the 3582A – produce a spectrum display with a linear frequency axis. While this is appropriate for narrowband analysis, it is sometimes more informative to view a broadband analysis, such as the entire audio spectrum, with a display that uses a log frequency axis. This form of presentation is generally called "log sweep."

This application note provides a means of modifying the 3582A Spectrum Analyzer operation so that it produces a 256 point log display covering the range of 10 Hz to 25 KHz. The key to this modification is the use of an

external controller whose communication path with the 3582A is the HP Interface Bus (HP-IB*). The required control program is given here in both BASIC and HPL languages.

This application note is the fifth of a series on the 3582A. You will find a list of all the notes on the back cover.

*HP-IB is Hewlett-Packard's implementation of IEEE Standard 488 and identical ANSI Standard MC1.1 "Digital interface for programmable instrumentation."

THE HEWLETT-PACKARD MODEL 3582A SPECTRUM ANALYZER

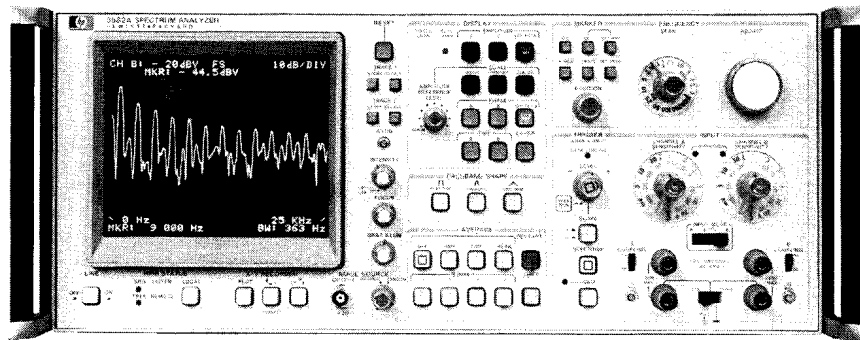

The HP 3582A is a spectrum analyzer covering the frequency range of DC to 25 kHz. Although it is a FFT-based, digital instrument, a special design effort has made it as straightforward to use as a conventional swept analyzer. With dual measurement channels it is possible to measure transfer function gain and phase, as well as the coherence function. A built-in random or pseudo-

random noise source, whose spectrum tracks the analysis range, is a useful measurement stimulus. Band Selectable Analysis enables narrowband, high resolution analysis to be applied to any portion of the frequency range. The instrument comes equipped with a flexible HP-IB interface for control and two-way data transfers.

TABLE OF CONTENTS

	Page
Section 1: Introduction How log sweep is produced with an FFT analyzer	1
Section 2: How to Use This Program Equipment, setup, and operation	1
Section 3: Description of Program Routines Brief discussion of each of the subroutines which comprise the program	3
Section 4: Program Modifications Two of many possible modifications to adapt the program to special needs	4
Section 5: Program Listings The complete log sweep program in both BASIC and HPL versions	4

Section 1: Introduction

A spectrum presentation with a logarithmically-compressed frequency axis, commonly called "log sweep," is often used in diverse applications such as characterizing audio components, servo response, and acoustics. Part of the advantage of log sweep becomes evident when the amplitude axis is chosen to be logarithmic also. Various parts of the display may then approximate straight line segments whose slopes reveal, to the practiced eye, a good deal about the structure of the device whose spectrum or transfer function is being measured.

By nature, FFT analyzers produce data which is linearly spaced in frequency, and they must be coaxed to convert the data into a log format. With the use of an external controller the 3582A readily adapts to this job. Essentially, the controller commands the analyzer to generate a large number of data points over the frequency range. From all of these, 256 points can be chosen logarithmically.

The program described in this note generates a good approximation to a true log sweep in this manner: in the range of 10 Hz to 25 KHz, it first calculates 256 frequen-

cies as a geometric series so that they would be uniformly spaced if plotted on log graph paper. Then, in five measurement passes, it collects data from the FFT "bin" nearest to each of the theoretical frequencies, and presents the data points sequentially on the 3582A display CRT, together with a vertical log graticule.

The log display has 256 points whether the 3582A INPUT MODE is single channel or dual channel. (The 3582A normally produces 256 points in single channel mode, and 128 in dual channel.)

Discrete versus continuous spectra.

Because the 256 data points are discrete samples of the entire frequency range, there is a possibility that some isolated spectral lines may be skipped over and hence not be represented in the final log display. For this reason, it is recommended that the program be used with continuous spectra such as those associated with random processes. Measuring transfer functions using the built-in periodic noise source for excitation also works well, since, although the source has a line spectrum, there is one line for every FFT bin in a measurement.

Section 2: How to Use This Program

This section describes the equipment needed to use the log sweep program (both BASIC and HPL versions). It also discusses measurement setups and control settings of the 3582A.

EQUIPMENT. In addition to a 3582A Spectrum Analyzer and a 98034A HP-IB Interface assembly, the following controller equipment is needed, depending on which program language is to be used:

<u>LANGUAGE</u>	<u>CONTROLLER</u>	<u>ROM FUNCTIONS</u>
BASIC	9835A or 9845A/B desktop computers	plotter, I/O
HPL	9825A calculator	9872A plotter, string, advanced programming, general I/O, extended I/O

Plotter capability is used only for the optional hard-copy plotter output, so you can omit this ROM function if desired.

SETUP AND OPERATION. Most of the control settings of the 3582A are left to the user to set as he chooses, whether manually or through programming. Those which are determined by the program are: 10 dB/div SCALE, RMS AVERAGE (if averaging is requested), SET START MODE, and the SPANs used in each of the five passes.

Before running the program, the test setup should be checked to see whether the sensitivity controls are set satisfactorily so that no overload occurs on any of the measurement spans. This is especially important when using the internal noise source of the 3582A as a stimulus. Its output is constant-power, restricted to the frequency span being measured, rather than constant power-density over all frequencies. Therefore, the narrower spans may exhibit an overload which isn't evident in a 0-25 KHz analysis, for instance.

After loading the program into the controller, you should press RUN. This results in a few seconds of initializing operations, after which some questions are asked. These are listed below, along with comments on their significance. The first question of the pair is the BASIC version, and the second is HPL:

<u>QUESTION</u>	<u>COMMENT</u>	
DO YOU WANT RMS AVERAGING?	For spectra of random processes, RMS averaging provides a means for smoothing the spectral display. This is also helpful for improving signal/noise ratios for transfer function measurements. *	If you have answered "YES" to the RMS averaging question, the program pauses while prompting you to set the 3582A AVERAGE NUMBER controls to the number of averages you want. After doing this, press CONTINUE and the program will proceed.
RMS AVERAGING (yes/no)?		During the data collection phase of the program, a message is displayed on line 2 of the 3582A display indicating the pass for which data is currently being gathered. At the end of the five passes, the program processes the accumulated data and presents the final scaled and annotated display on the 3582A. Do not return the analyzer to LOCAL at this point, or the display will be lost.
DO YOU WANT NOISE BANDWIDTH COMPENSATION?	Because the measurement bandwidth of an FFT analyzer varies with the frequency span, the display of a random source (like white noise) will appear to be stepped unless this compensation is used. It is not needed for transfer functions or for the internal noise source.	Before returning for another measurement, the program asks whether you want a hard copy plot made. Answering "YES" activates the plotting routine, which is written primarily for the 7225A Plotter, although the 9872A and other plotters using the "HP-GL" bus language will work also. After you set the diagonal limits as requested, the program draws X and Y scales. It then pauses so that you can manually change the pen color, and then plots the annotation and data.
NOISE BW COMPENSATION (yes/no)?		Pressing CONTINUE once more completes the sequence by clearing the CRT display, returning the 3582A to LOCAL, and beginning the question cycle to start another measurement. If you are making a series of similar measurements, it is not necessary to type in the answers each time, since these controllers retain the previous entries to an "INPUT" or "ent" program line when CONTINUE alone is pressed.
SINGLE CHANNEL (1) OR DUAL CHANNEL (2) MEASUREMENT?	The program will accept either single or dual input mode. In either case, the information on the display is what is processed; therefore, be sure that the display is what you want. Amplitude displays should use 10 dB/div SCALE. The CRT may have two displays, but the program will process only the higher priority one. See Application Note 245-4 for priority list.	
SINGLE CHAN(1) OR DUAL CHAN(2)?		

*More discussion of signal averaging, including how the 3582A improves transfer function measurements, may be found in Application Note 245-1, "Signal averaging with the HP 3582A Spectrum Analyzer," part no. 5952-8767.

Section 3: Description of Program Routines

The program is organized as a collection of subroutines which are called up in the proper order by a control sequence labeled "Start." All variables are global rather than local, somewhat simplifying the job of tracing program flow if that becomes necessary. Both BASIC and HPL versions of the program use the same subroutine labels and are organized the same way, as far as possible. Therefore, the following comments apply to either version.

"Setup": This and "Bin_calc" are initializing routines; that is, they only operate when the program is run the first time, and are subsequently bypassed. "Setup" defines the values of a number of tabular arrays and strings. The uses of these are explained in the commentary included with the BASIC listing.

"Bin_calc": Theoretically, this log sweep program operates by selecting signal values at 256 exponentially-spaced frequencies between 10 Hz and 25 KHz. Frequency values are found in the array F. Practically, the program must round the true frequencies to the nearest available FFT "bins" in each of the five spans used in the analysis. This routine does the rounding operation. Both single channel (256 bins) and dual channel (128 bins) operations contribute the same number of points to a given pass. A slight complication occurs in the first pass: for single channel, the START frequency is 10 Hz, while (for arithmetic reasons in the 3582A) it is 9.8 Hz in dual channel. This condition is sensed and dealt with by a ($J = 1$) term in the formula.

"Data": This is the principle routine of the program. When called, it cycles through the five passes, performing the following in each pass:

- a) sets up the frequency range in the 3582A, using tabular data
- b) writes the pass identifier message on the display
- c) if RMS averaging was indicated, starts averaging and monitors for completion; otherwise waits tabulated time
- d) reads binary display data from the 3582A
- e) saves only the data from bins selected for that pass
- f) subtracts the bandwidth compensation factor, if indicated

Because single and dual channel operations involve different numbers of display points and different memory locations (Application Note 245-4), there is a separate data collection section for each case.

"Sensitivity": In order to display the full-scale measurement sensitivity on the composite log plot, the controller must interrogate the 3582A to determine this item, which is a function of INPUT SENSITIVITY and the AMPLITUDE REFERENCE LEVEL. The routine finds out the kind of display being shown on the 3582A by reading and decoding front panel switch word 77455. It then sends the appropriate HP-IB command and obtains the sensitivity value.

"Display": This writes the composite graphic data, 256 words, on the 3582A display.

"Graticule": Since the internal graticules of the 3582A CRT are linear, the vertical lines cannot conveniently be used for a logarithmic frequency axis. This routine generates a log graticule by drawing a set of 29 vertical lines corresponding to cardinal frequencies. The graticule coexists with the graphic data without interference, since it uses display buffer space reserved for a second 256-point display.

"Annotation": After writing both graphic data and the log graticule on the 3582A display, the final step is to write the alphanumeric labels and messages. These are "pre-recorded" except for part of line 2, which displays the scale sensitivity previously determined by "Sensitivity."

"Hard_copy": This routine reproduces the complete 3582A log display on an HP-IB plotter. It assumes that you are using a blank sheet of paper, since it draws both vertical and horizontal scaling lines. Remember that the plotter must be one that uses "HP-GL" graphics language, such as the 7225A.

Section 4: Program Modifications

Because of the modular structure of the program, it is a straightforward matter to change it by adding or deleting segments, or modifying the existing coding. This section suggests a couple of possibilities.

Improving transfer function S/N ratio. Over the 3+ decades of frequency covered by this program, some devices you are measuring will exhibit a dynamic range greater than 50 dB. When this is the case, the low amplitude parts of the response may appear noisy. You may be able to improve the S/N ratio in the noisy parts of the response by increasing the gain of Channel B during the corresponding measurement pass. Try the following procedure:

- a) Identify the pass(es) for which the gain should be increased.
- b) Insert a program line at the beginning of "Data" to increase Channel B gain. For example,
IF J=3 THEN OUTPUT (BASIC)
Analyzer; "BS8"
if J=3; wrt "Analyzer", (HPL)
"BS8"

Be sure to reset the gain to normal for the following passes.

- c) Since step (b) changes the transfer function sensitivity, the resulting jump must be subtracted from the collected data, at the rate of 128 per 10 dB. A convenient way to do this is to modify the calculation of "Bwcomp" by a term like
$$-128 \cdot (J=3)$$

This procedure was used for the lowpass filter on the cover of the Application Note. Channel B gain was increased 10 dB in pass 5.

Plotting two (or more) traces. The 3582A display can only present two 256-point traces simultaneously, and one of these is used for the log graticule. No such limitation applies to the external hard-copy plotter, however. If you want to display both amplitude and phase on the same graph, for instance, the simplest approach is to make two measurements. After the first has been plotted you should arrange for the program to skip over the graticule and annotation portions of "Hard_copy" and proceed with the graphic output. In the BASIC version, a simple way to do this is to change line 300 to read
IF Plot\$ = "YES" THEN GOSUB 1620

Section 5: Program Listings BASIC PROGRAM

```
10 ! LOG FREQUENCY "SWEEP" FOR THE 3582A SPECTRUM ANALYZER CONTROLLED
20 ! BY THE 9835A OR 9845A DESKTOP COMPUTER. PROGRAM INCLUDES A
30 ! SUBROUTINE FOR PLOTTING RESULTS ON AN HP-IB X/Y PLOTTER,
40 ! SUCH AS THE 7225A OR 9872A.
50 DIM Pass_ident$(5)[371],Notation$(4)[32]
60 SHORT Incr(5),F(255) ! "F" contains frequencies used in log display.
70 INTEGER Firstbin(5),Lastbin(5),Span(5),Time(5),Bwcomp(5),I,J
80 INTEGER Bin1(255),Bin2(255),Grafic1(255),Grafic2(127),Disp(255),Gnat(29)
90 ! "Bin1" and "Bin2" (single and dual channel) contain the numbers of the
100 ! FFT bins collected from each of the 5 spans; "Grafic1" and "Grafic2"
110 ! are used to save the 3582A display; "Disp" collects the log-spaced
120 ! display data; "Gnat" contains bin numbers for the log graticule.
130 Analyzer=711
140 GOSUB Setup
150 GOSUB Bin_calc
160 Start: INPUT "DO YOU WANT RMS AVERAGING?",Ave# ! Main control sequence.
170 INPUT "DO YOU WANT NOISE BANDWIDTH COMPENSATION?",Bwcomp#
180 INPUT "SINGLE CHANNEL (1) OR DUAL CHANNEL (2) MEASUREMENT?",Chan
190 .IF Ave#<>"YES" THEN GOTO 220
200 DISP "SET NUMBER OF AVERAGES ON FRONT PANEL; PRESS ^CONTINUE^"
210 PAUSE
220 DISP "COLLECTING DATA"
230 OUTPUT Analyzer;"AV1MD4SC2"
240 GOSUB Data
250 GOSUB Sensitivity
260 GOSUB Display
270 GOSUB Graticule
280 GOSUB Annotation
290 INPUT "DO YOU WANT A HARD COPY PLOT?",Plot#
300 IF Plot#="YES" THEN GOSUB Hard_copy
310 DISP "PRESS ^CONTINUE^ FOR ANOTHER MEASUREMENT"
320 PAUSE
```

```

330 RESET Analyzer
340 LOCAL Analyzer
350 GOTO Start ! End of control sequence.
360 Setup: MAT READ Grats ! Load arrays.
370 DATA 0,23,36,45,52,58,63,68,72,75,98,111,120,128,133,138,143
380 DATA 147,150,173,186,195,203,208,214,218,222,225,248,250
390 MAT READ Firstbin ! First bin of each of five
400 DATA 0,0,59,113,160,211 ! segments making up display.
410 MAT READ Lastbin ! Last bin of each segment.
420 DATA 0,58,112,159,210,255
430 MAT READ Inchr ! Value of FFT bin spacing
440 DATA 0,.2,1,4,20,100 ! for each segment, 1 chan.
450 MAT READ Span ! HP-IB code for each span.
460 DATA 0,6,8,10,12,14
470 MAT READ Time ! Dwell time before reading
480 DATA 0,7000,4000,2000,1000,1000 ! data, for non-averaging.
490 MAT READ Bwcomp ! Noise bandwidth ratios,
500 DATA 0,0,89,166,256,345 ! in display units.
510 Pass_ident$(1)="WTA2, 1ST PASS SPAN 50 Hz "
520 Pass_ident$(2)="WTA2, 2ND PASS SPAN 250 Hz "
530 Pass_ident$(3)="WTA2, 3RD PASS SPAN 1 KHz "
540 Pass_ident$(4)="WTA2, 4TH PASS SPAN 5 KHz "
550 Pass_ident$(5)="WTA2, 5TH PASS SPAN 25 KHz "
560 Notation$(1)=" 10 - 25000 Hz LOG SWEEP "
570 Notation$(2)=" FULL SCALE SENSITIVITY"
580 Notation$(3)="10 100 1K 10K "
590 Notation$(4)=" FREQUENCY Hz "
600 A=255/(LGT(25000)-LGT(10)) ! Calculate 256 exponentially
610 FOR I=0 TO 255 ! spaced frequencies from 10
620 F(I)=10^(I/A+1) ! to 25000 Hz.
630 NEXT I
640 RETURN
650 Bin_calc: ! Determine which bins in
660 FOR J=1 TO 5 ! each of the five spans
670 Fr=PROUND(F(Firstbin(J)),0) ! are to be saved to make
680 Gr=Fr-.2*(J-1) ! up composite log display;
690 K1=Fr MOD Inchr(J) ! results are stored in
700 K2=Gr MOD (2*Inchr(J)) ! Bin1 (one channel) and
710 FOR I=Firstbin(J) TO Lastbin(J) ! Bin2 (two channels).
720 X=Inchr(J)*PROUND((F(I)-K1)/Inchr(J),0)+K1
730 Y=2*Inchr(J)*PROUND((F(I)-K2)/(2*Inchr(J)),0)+K2
740 Bin1(I)=(X-Fr)/Inchr(J)
750 Bin2(I)=(Y-Gr)/(2*Inchr(J))
760 NEXT I
770 NEXT J
780 RETURN
790 Display: OUTPUT Analyzer;"PR$" ! Display graphic data.
800 OUTPUT Analyzer USING "16R/256(Y)";"HLTMTM,74400,256",Disp(*)
810 RETURN
820 Graticule: MAT Grafic1=(-32768) ! Assemble and display
830 FOR I=0 TO 28 ! log graticule.
840 Grafic1(254-Grat(I))=1023 ! Grafic1 is borrowed
850 NEXT I ! as a buffer.
860 OUTPUT Analyzer USING "13R/256(Y)";"WTM,74000,256",Grafic1(*)
870 RETURN
880 Data: FOR J=1 TO 5 ! Main data collecting and
890 Startfreq=PROUND(F(Firstbin(J)),0) ! processing routine.
900 OUTPUT Analyzer USING "2R,4D,2R,2D";"RD",Startfreq,"SP",Span(J)
910 OUTPUT Analyzer;Pass_ident$(J)
920 Bwcomp=Bwcomp(J)*(Bwcomp$="YES")
930 IF Ave$("<"YES" THEN GOTO 980
940 OUTPUT Analyzer;"RV2RELST0" ! RMS averaging routine.
950 OUTPUT Analyzer;"LST0" ! Check for average done.
960 IF BIT(READBIN(Analyzer),6)=0 THEN GOTO 950
970 GOTO 990
980 WAIT Time(J)
990 IF Chan(">"2 THEN GOTO 1070

```



```

1000 OUTPUT Analyzer;"HLTLFM,74600,128" ! Dual channel section.
1010 ENTER Analyzer USING "#,128(Y)";Grafic2(*)
1020 FOR I=Firstbin(J) TO Lastbin(J)
1030 Disp(255-I)=BINAND(Grafic2(127-Bin2(I)),1023)-Bwcomp
1040 IF Disp(255-I)<0 THEN Disp(255-I)=0
1050 NEXT I
1060 GOTO 1130
1070 OUTPUT Analyzer;"HLTLFM,74400,256" ! Single channel section.
1080 ENTER Analyzer USING "#,256(Y)";Grafic1(*)
1090 FOR I=Firstbin(J) TO Lastbin(J)
1100 Disp(255-I)=BINAND(Grafic1(255-Bin1(I)),1023)-Bwcomp
1110 IF Disp(255-I)<0 THEN Disp(255-I)=0
1120 NEXT I
1130 OUTPUT Analyzer;"RUN" ! Ready 3582A for next pass.
1140 NEXT J
1150 RETURN
1160 Sensitivity: OUTPUT Analyzer;"LFM,77455,1" ! Determine what kind of
1170 ENTER Analyzer USING "#,Y";X ! display is being used.
1180 X=BINAND(X,7)
1190 IF X=1 THEN Sens$="LAS"
1200 IF X=2 THEN Sens$="LBS"
1210 IF X=4 THEN Sens$="LXS"
1220 OUTPUT Analyzer;Sens$ ! Determine sensitivity.
1230 ENTER Analyzer;Sens
1240 IF Sens>200 THEN Sens=9999 ! Default value if
1250 RETURN ! sensitivity uncalibrated.
1260 Annotation: OUTPUT Analyzer USING "5A,32A";"WTA1,";Notation$(1)
1270 OUTPUT Analyzer USING "5A,23A,4D,5A";"WTA2,";Notation$(2);Sens," dB "
1280 OUTPUT Analyzer USING "5A,32A";"WTA3,";Notation$(3)
1290 OUTPUT Analyzer USING "5A,32A";"WTA4,";Notation$(4)
1300 RETURN
1310 Hard_copy: ! Routine plots completed log
1320 PLOTTER IS 7,5,"9872A" ! display on X-Y plotter.
1330 DISP "SET LOWER LEFT AND UPPER RIGHT LIMITS; PRESS <ENTER> AFTER EACH"
1340 LIMIT
1350 DISP ! Clear display.
1360 LOCATE 0,100*RATIO,10,90 ! Set limits of graph area.
1370 SCALE 0,255,0,1023
1380 MOVE 0,0 ! Draw 10 dB/division
1390 FOR I=0 TO 8 ! vertical amplitude scale.
1400 X=(I MOD 2=0)*255
1410 PLOT X,1023*I/8,-1
1420 MOVE X,1023*(I+1)/8
1430 NEXT I
1440 MOVE 0,0 ! Draw log-spaced horizontal
1450 FOR I=0 TO 28 ! frequency scale.
1460 Y=(I MOD 2=0)*1023
1470 PLOT Graf(I),Y,-1
1480 MOVE Graf(I+1),Y
1490 NEXT I
1500 DISP "CHANGE PEN COLOR, IF DESIRED, THEN PRESS <CONTINUE>"
1510 PAUSE
1520 DISP ! Clear display.
1530 CSIZE 5,.632*RATIO ! Plot the four lines
1540 MOVE 0,1090 ! of annotation.
1550 LABEL Notation$(1)
1560 MOVE 0,1035
1570 LABEL USING "23A,4D,5A";Notation$(2);Sens," dB "
1580 MOVE 0,-50
1590 LABEL Notation$(3)
1600 MOVE 0,-100
1610 LABEL Notation$(4)
1620 FOR I=0 TO 255 ! Plot graph.
1630 PLOT I,Disp(255-I)
1640 NEXT I
1650 PENUP
1660 RETURN

```

HPL PROGRAM

```

0: "LOG SWEEP FOR THE 3582A AND THE 9825A":
1: dim P#[5,37],A#[3],B#[3],S#[3],I[5],F[0:255],R[5],L[5],S[5],T[5]
2: dim C[5],BC[0:255],GC[0:255],HC[0:127],DC[0:255],AC[0:29],N#[4,32],T#[3]
3: dev "Analyzer",711
4: esb "Setup"
5: esb "Bin_calc"
6: "Start":ent "RMS AVERAGING (yes/no)?",A#
7: ent "NOISE BW COMPENSATION (yes/no)?",B#
8: ent "SINGLE CHAN(1) OR DUAL CHAN(2)?",C
9: if A##"yes";sto 11
10: dsp "SET # AVERAGES; PRESS CONTINUE";stp
11: dsp "COLLECTING DATA"
12: wrt "Analyzer","AV1MD48C2"
13: esb "Data"
14: esb "Sensitivity"
15: esb "Display"
16: esb "Graticule"
17: esb "Annotation"
18: ent "X-Y PLOTTER (yes/no)?",T#;if T#="yes";esb "Hard copy"
19: dsp "PRESS CONTINUE FOR NEXT MEAS. ";stp
20: clr "Analyzer";lcl "Analyzer";sto "Start"
21: "Setup":0+AC[0];23+AC[1];36+AC[2];45+AC[3];52+AC[4];58+AC[5];63+AC[6];250+AC[29]
22: 68+AC[7];72+AC[8];75+AC[9];98+AC[10];111+AC[11];120+AC[12];128+AC[13];133+AC[14]
23: 138+AC[15];143+AC[16];147+AC[17];150+AC[18];173+AC[19];186+AC[20];195+AC[21]
24: 203+AC[22];208+AC[23];214+AC[24];218+AC[25];222+AC[26];225+AC[27];248+AC[28]
25: 0+RC[1];59+RC[2];113+RC[3];160+RC[4];211+RC[5]
26: 58+LC[1];112+LC[2];159+LC[3];210+LC[4];255+LC[5]
27: .2+IC[1];1+IC[2];4+IC[3];20+IC[4];100+IC[5]
28: 6+SC[1];8+SC[2];10+SC[3];12+SC[4];14+SC[5]
29: 7000+TC[1];4000+TC[2];2000+TC[3];1000+TC[4];TC[5]
30: 0+CC[1];89+CC[2];166+CC[3];256+CC[4];345+CC[5]
31: "WTA2, 1ST PASS SPAN 50 Hz "+P#[1]
32: "WTA2, 2ND PASS SPAN 250 Hz "+P#[2]
33: "WTA2, 3RD PASS SPAN 1 KHz "+P#[3]
34: "WTA2, 4TH PASS SPAN 5 KHz "+P#[4]
35: "WTA2, 5TH PASS SPAN 25 KHz "+P#[5]
36: " 10 - 25000 Hz LOG SWEEP "+N#[1]
37: " FULL SCALE SENSITIVITY"+N#[2]
38: "10 100 1K 10K "+N#[3]
39: " FREQUENCY HZ "+N#[4]
40: 255/(log(25000)-log(10))+R
41: for I=0 to 255;tn=(I/A+1)+F[I];next I
42: ret
43: "Bin_calc":for J=1 to 5
44: rnd(F[R[J]]+0)+U;U=.2(J=1)+V
45: IE[J]frc(U/IE[J])+W;2IE[J]frc(V/2IE[J])+Z
46: for I=R[J] to L[J]
47: IE[J]rnd((F[I]-W)/IE[J],0)+W+X
48: 2IE[J]rnd((F[I]-Z)/2IE[J],0)+Z+Y
49: (X-U)/IE[J]+BC[1,I];(Y-V)/2IE[J]+BC[2,I]
50: next I;next J;ret
51: "Display":wrt "Analyzer","PRS"
52: wrt "Analyzer","HLTWTM;74400;256"
53: for I=0 to 255
54: wtb 731,shf(DC[I],8);wtb 731,DC[I]
55: next I;ret
56: "Graticule":for I=0 to 255;-32768+GC[I];next I
57: for I=0 to 28;1023+GC[254-AC[I]];next I
58: wrt "Analyzer","WTM;74000;256"
59: for I=0 to 255;wtb 731,shf(GC[I],8)
60: wtb 731,GC[I];next I;ret

```

```

61: "Data":for J=1 to 5
62: @rnd(F[R][J],0)+U
63: @nt 1;c:f4.0;c:f2.0
64: wrt "Analyzer.1";"AD";U;"SP";S[J]
65: wrt "Analyzer";P#[J];C[J](B#="yes")+B
66: if A##"yes";eto 71
67: wrt "Analyzer";"AV2RELST0"
68: wrt "Analyzer";"LST0"
69: if bit(6;rdb("Analyzer"))=0;sto -1
70: eto 72
71: wait T[J]
72: if C#2;eto 80
73: wrt "Analyzer";"HLTLM;74600;128";red "Analyzer"
74: for I=0 to 127;rdb(731)+X;rdb(731)+Y
75: ior(shf(X,-8);Y)+H[I];next I
76: for I=R[J] to L[J]
77: band(H[127-B[2,I]],1023)-B+D[255-I]
78: if D[255-I]<0;0+D[255-I]
79: next I;eto 87
80: wrt "Analyzer";"HLTLM;74400;256";red "Analyzer"
81: for I=0 to 255;rdb(731)+X;rdb(731)+Y
82: ior(shf(X,-8);Y)+G[I];next I
83: for I=R[J] to L[J]
84: band(G[255-B[2,I]],1023)-B+D[255-I]
85: if D[255-I]<0;0+D[255-I]
86: next I
87: wrt "Analyzer";"RUN"
88: next J;ret
89: "Sensitivity":wrt "Analyzer";"LFM;77455;1"
90: rdb("Analyzer")+X;band(rdb("Analyzer");7)+X
91: if X=1;"LAS"+S#
92: if X=2;"LBS"+S#
93: if X=4;"LXS"+S#
94: wrt "Analyzer";S#;red "Analyzer";S
95: if S>200;9999+S
96: ret
97: "Annotation":@nt 1;c:f4.0;c:f4.0;c
98: wrt "Analyzer.1";"WTA1";N#[1]
99: wrt "Analyzer.2";"WTA2";N#[2];S;" dB "
100: wrt "Analyzer.1";"WTA3";N#[3]
101: wrt "Analyzer.1";"WTA4";N#[4];ret
102: "Hard_copy":psc 705;fxd 0
103: dsp "SET LIMITS THEN PRESS CONTINUE";stp
104: scl 0,255,-100,1123;elt 0,0,i
105: for I=0 to 8;(frc(I/2)=0)255+X
106: elt X,1023I/8,2;elt X,1023(I+1)/8,i
107: next I;elt 0,0,i
108: for I=0 to 28;(frc(I/2)=0)1023+Y
109: elt A[I];Y,2;elt A[I+1];Y,i;next I
110: dsp "CHANGE PEN; PRESS CONTINUE";stp
111: csiz 2.5;1.18;elt 0,1090,1;lbl N#[1]
112: elt 0,1035,1;lbl N#[2];S;" dB "
113: elt 0,-50,1;lbl N#[3]
114: elt 0,-100,1;lbl N#[4]
115: for I=0 to 255;elt I,D[255-I];next I
116: pen;ret
#15830

```